Artificial Intelligence

Structures and Strategies for Complex Problem Solving

Third Edition

George F. Luger

William A. Stubblefield



Addison Wesley Longman, Inc.

Harlow, England • Reading, Massachusetts • Menlo Park,
California • Berkeley, California • Don Mills, Ontario
Amsterdam • Bonn • Sydney • Tokyo • Milan • Mexico City

© Addison Wesley Longman, Inc. 1998

Addison Wesley Longman, Inc.
One Jacob Way
Reading
MA 01867-3999
USA

and Associated Companies throughout the World.

The rights of George Luger and William Stubblefield to be identified as authors of this Work have been asserted by them in accordance with the Copyright, Designs and Patents Act 1988.

All rights reserved. No part of this publication may be reproduced, stored in a retrieval system, or transmitted in any form or by any means, electronic, mechanical, photocopying, recording or otherwise, without either the prior written permission of the publisher or a licence permitting restricted copying in the United Kingdom issued by the Copyright Licensing Agency Ltd, 90 Tottenham Court Road, London W1P 9HE.

The programs in this book have been included for their instructional value. They have been tested with care but are not guaranteed for any particular purpose. The publisher does not offer any warranties or representations nor does it accept any liabilities with respect to the programs.

Cover designed by odB Design & Communication, Reading, England
Cover figure by Thomas Barrow, University of New Mexico
Typeset by the authors
Printed and bound in the United States of America

First printed 1997

ISBN 0-805-31196-3

British Library Cataloguing-in-Publication Data

A catalogue record for this book is available from the British Library

For my wife, Kathleen, and our children Sarah, David, and Peter,

For my parents, George Fletcher Luger and Loretta Maloney Luger.

Si quid est in me ingenii, iudices . . .

Cicero, Pro Archia Poeta

GFL

For my parents, William Frank Stubblefield and Maria Christina Stubblefield.

And for my wife, Merry Christina.

She is far more precious than jewels.

The heart of her husband trusts in her,

and he will have no lack of gain.

Proverbs 31: 10–11

WAS

PREFACE

*What we have to learn to do
we learn by doing. . .*

—ARISTOTLE, *Ethics*

New Colors on an Old Canvas

No one expects a computer science textbook to age as well as Katharine Hepburn, Sean Connery, or the music of Thelonious Monk. We were nonetheless surprised at just how soon it became necessary for us to begin work on this third edition. Some sections of the second edition have endured remarkably well, including topics such as logic, search, knowledge representation, production systems and the programming techniques developed in LISP and PROLOG. These remain central to the practice of artificial intelligence, and required a relatively small effort to bring them up to date and to correct the few errors and omissions that had appeared in the second edition (through purely random processes that imply no failure of the authors). However, many chapters, including those on learning, neural networks, and reasoning with uncertainty, clearly required, and received, extensive reworking. Other topics, such as emergent computation, case-based reasoning and model-based problem solving, that were treated cursorily in the first two editions, have grown sufficiently in importance to merit a more complete discussion. These needed changes are evidence of the continued vitality of the field of artificial intelligence.

As the scope of the project grew, we were sustained by the support of our publisher, editors, friends, colleagues, and, most of all, by our readers, who have given our creation such a long and productive life. We were also sustained by our own excitement at the opportunity afforded: Scientists are rarely encouraged to look up from their own, narrow research interests and chart the larger trajectories of their chosen field. Our publisher and readers have asked us to do just that. We are grateful to them for this opportunity.

Although artificial intelligence, like most engineering disciplines, must justify itself to the world of commerce by providing solutions to practical problems, we entered the

field for the same reasons as most of our colleagues and students: we want to understand the mechanisms that enable thought. We reject the rather provincial notion that intelligence is an exclusive ability of humans, and believe that we can effectively explore the space of possible intelligences by designing and evaluating intelligent machines. Although the course of our careers has given us no cause to change these commitments, we have arrived at a greater appreciation for the scope, complexity and audacity of this undertaking. In the preface to our first and second editions, we outlined three assertions that we believed distinguished our approach to teaching artificial intelligence. It is reasonable, in writing a preface to this third edition, to return to these themes and see how they have endured as our field has grown.

The first of these goals was to “unify the diverse branches of AI through a detailed discussion of its theoretical foundations.” At the time we adopted that goal, it seemed that the main problem was reconciling researchers who emphasized the careful statement and analysis of formal theories of intelligence (the *neats*) with those who believed that intelligence itself was some sort of grand hack that could be best approached in an application-driven, *ad hoc* manner (the *scruffies*). That simple dichotomy has proven far too simple. In contemporary AI, debates between neats and scruffies have given way to dozens of other debates between proponents of physical symbol systems and students of neural networks, between logicians and designers of artificial life forms that evolve in a most illogical manner, between architects of expert systems and case-based reasoners, and between those who believe artificial intelligence has already been achieved and those who believe it will never happen. Our original image of AI as frontier science where outlaws, prospectors, wild-eyed prairie prophets and other dreamers were being slowly tamed by the disciplines of formalism and empiricism has given way to a different metaphor: that of a large, chaotic but mostly peaceful city, where orderly bourgeois neighborhoods draw their vitality from wonderful, chaotic bohemian districts. Over the years we have devoted to the different editions of this book, a compelling picture of the architecture of intelligence has started to emerge from this city’s art and industry.

Intelligence is too complex to be described by any single theory; instead, researchers are constructing a hierarchy of theories that characterize it at multiple levels of abstraction. At the lowest levels of this hierarchy, neural networks, genetic algorithms and other forms of emergent computation have enabled us to understand the processes of adaptation, perception, embodiment and interaction with the physical world that must underlie any form of intelligent activity. Through some still partially understood resolution, this chaotic population of blind and primitive actors gives rise to the cooler patterns of logical inference. Working at this higher level, logicians have built on Aristotle’s gift, tracing the outlines of deduction, abduction, induction, truth-maintenance, and countless other modes and manners of reason. Even higher up the ladder, designers of expert systems, intelligent agents and natural language understanding programs have come to recognize the role of social processes in creating, transmitting, and sustaining knowledge. In this third edition, we have attempted to touch on all levels of this developing hierarchy.

The second commitment we made in the earlier editions was to the central position of “advanced representational formalisms and search techniques” in AI methodology. This is, perhaps, the most controversial aspect of our first two editions and of much early work in AI, with many workers in emergent computation questioning whether symbolic reasoning

and referential semantics have any role at all in thought. Although the idea of representation as giving names to things has been challenged by the implicit representation provided by the emerging patterns of a neural network or artificial life, we believe that an understanding of representation and search remains essential to any serious practitioner of artificial intelligence. Not only do such techniques as knowledge engineering, case-based reasoning, theorem proving, and planning depend directly on symbol-based models of reason, but also the skills acquired through the study of representation and search are invaluable tools for analyzing such aspects of non-symbolic AI as the expressive power of a neural network or the progression of candidate problem solutions through the fitness landscape of a genetic algorithm.

The third commitment we made at the beginning of this book's life cycle, to "place artificial intelligence within the context of empirical science," has remained unchanged. To quote from the preface to the second edition, we continue to believe that AI is not

... some strange aberration from the scientific tradition, but ... part of a general quest for knowledge about, and the understanding of intelligence itself. Furthermore, our AI programming tools, along with the exploratory programming methodology ... are ideal for exploring an environment. Our tools give us a medium for both understanding and questions. We come to appreciate and know phenomena constructively, that is, by progressive approximation.

Thus we see each design and program as an experiment with nature: we propose a representation, we generate a search algorithm, and then we question the adequacy of our characterization to account for part of the phenomenon of intelligence. And the natural world gives a response to our query. Our experiment can be deconstructed, revised, extended, and run again. Our model can be refined, our understanding extended.

New in This Edition

We revised the introductory and summary sections of this book to recognize the growing importance of agent-based problem solving as an application for AI techniques. In discussions of the foundations of AI we recognize intelligence as physically embodied and situated in a natural and social world. There are four entirely new areas presented in this edition: an extension of knowledge-intensive problem solving to the case-based and model-based approaches, a chapter presenting models for reasoning under conditions of ignorance and uncertainty, an extension of the natural language chapter to include stochastic approaches to language understanding, and finally, two new chapters devoted to neural and evolutionary models of learning.

Besides our previous analysis of data-driven and goal driven rule-based systems, Chapter 6 now contains case-based and model-based reasoning systems. The chapter concludes with a section relating the strengths and weaknesses of each of these approaches to knowledge-intensive problem solving.

Chapter 7 describes reasoning with uncertain or incomplete information. A number of important approaches to this problem are presented, including Bayesian reasoning, belief networks, the Dempster-Shafer model, the Stanford certainty factor algebra, and causal

models. Techniques for truth maintenance in nonmonotonic situations are also presented, as well as reasoning with minimal models and logic-based abduction.

Chapter 11, presenting issues in natural language understanding, now includes a section on stochastic models for language comprehension. The presentation includes Markov models, CART trees, mutual information clustering, and statistic-based parsing. The chapter closes with several examples applying the theoretical approaches presented to databases and other query systems.

Machine learning, currently a very important research topic in the AI community, is the third major addition to this edition. The ability to learn must be part of any system that would claim to possess general intelligence. Learning is also an important component of practical AI applications, such as expert systems. The learning models presented in Chapter 13 include explicitly represented knowledge where information is encoded in a symbol system and learning takes place through algorithmic manipulation, or search, of these structures. We present the sub-symbolic or connectionist approaches to learning in Chapter 14. In a neural net, for instance, information is implicit in the organization and weights on a set of connected processors, and learning is a rearrangement and modification of the overall structure of the system. We introduce genetic algorithms and evolutionary models of learning in Chapter 15, where learning is cast as an emerging and adaptive process. We compare and contrast the directions and results of learning in Chapter 16, where we also return to the deeper questions about the nature of intelligence and the possibility of intelligent machines that were posed in Chapter 1.

The Contents

Chapter 1 introduces artificial intelligence, beginning with a brief history of attempts to understand mind and intelligence in philosophy, psychology, and other areas of research. In a very important sense, AI is an old science, tracing its roots back at least to Aristotle. An appreciation of this background is essential for an understanding of the issues addressed in modern research. We also present an overview of some of the important application areas in AI. Our goal in Chapter 1 is to provide both background and a motivation for the theory and applications that follow.

Chapters 2, 3, 4, and 5 (Part II) introduce the research tools for AI problem solving. These include the predicate calculus to describe the essential features of a domain (Chapter 2), search to reason about these descriptions (Chapter 3) and the algorithms and data structures used to implement search. In Chapters 4 and 5, we discuss the essential role of heuristics in focusing and constraining search-based problem solving. We also present a number of architectures, including the blackboard and production system, for building these search algorithms.

Chapters 6, 7, and 8 make up Part III of the book: representations for knowledge-based problem solving. In Chapter 6 we present the rule-based expert system along with case-based and model-based reasoning systems. These models for problem solving are presented as a natural evolution of the material in the first five chapters: using a

production system of predicate calculus expressions to orchestrate a graph search. We end the chapter with an analysis of the strengths and weaknesses of each of these approaches.

Chapter 7 presents models for reasoning with uncertainty as well as unreliable information. We discuss Bayesian models, belief networks, the Dempster-Shafer approach, causal models, and the Stanford certainty algebra. Chapter 7 also contains algorithms for truth maintenance, reasoning with minimum models, and logic-based abduction.

Chapter 8 presents AI techniques for modeling semantic meaning, with a particular focus on natural language applications. We begin with a discussion of semantic networks and extend this model to include conceptual dependency theory, conceptual graphs, frames, and scripts. Class hierarchies and inheritance are important representation tools; we discuss both the benefits and difficulties of implementing inheritance systems for realistic taxonomies. This material is strengthened by an in-depth examination of a particular formalism, conceptual graphs. This discussion emphasizes the epistemological issues involved in representing knowledge and shows how these issues are addressed in a modern representation language. In Chapter 11, we show how conceptual graphs can be used to implement a natural language database front end.

Part IV presents AI languages. These languages are first compared with each other and with traditional programming languages to give an appreciation of the AI approach to problem solving. Chapter 9 covers PROLOG, and Chapter 10, LISP. We demonstrate these languages as tools for AI problem solving by building on the search and representation techniques of the earlier chapters, including breadth-first, depth-first, and best-first search algorithms. We implement these search techniques in a problem-independent fashion so they may later be extended to form shells for search in rule-based expert systems, semantic network and frame systems, as well as in other applications.

Part V, Chapters 11 through 15, continues our presentation of important AI application areas. Chapter 11 presents natural language understanding. Our traditional approach to language understanding, exemplified by many of the semantic structures presented in Chapter 8, is complemented with stochastic models. These include Markov models, CART trees, mutual information clustering, and statistic-based parsing. The chapter concludes with examples applying these techniques to query systems.

Theorem proving, often referred to as automated reasoning, is one of the oldest areas of AI research. In Chapter 12, we discuss the first programs in this area, including the Logic Theorist and the General Problem Solver. The primary focus of the chapter is binary resolution proof procedures, especially resolution refutations. More advanced inferencing with hyper-resolution and paramodulation is also discussed. Finally, we describe the PROLOG interpreter as a Horn clause inferencing system, and compare PROLOG computing to full logic programming.

Chapters 13 through 15 are an extensive presentation of issues in machine learning. In Chapter 13 we offer a detailed look at algorithms for symbol-based machine learning, a fruitful area of research spawning a number of different problems and solution approaches. The learning algorithms vary in their goals, the training data considered, the learning strategies, and the knowledge representations they employ. Symbol-based learning includes induction, concept learning, version space search, and ID3. The role of inductive bias is considered, generalizations from patterns of data, as well as the effective use of

knowledge to learn from a single example in explanation-based learning. Category learning, or conceptual clustering, is presented with unsupervised learning.

In Chapter 14, we present neural networks, often referred to as sub-symbolic or connectionist models of learning. In a neural net, for instance, information is implicit in the organization and weights on a set of connected processors, and learning involves a rearrangement and modification of the overall structure of the system. We present a number of connectionist architectures, including perceptron learning, backpropagation, and counterpropagation. We demonstrate examples of Kohonen, Grossberg, and Hebbian networks. We also present associative learning and attractor models, including Hopfield networks.

We introduce genetic algorithms and evolutionary models of learning in Chapter 15. In these models, learning is cast as an emerging and adaptive process. After several examples of problem solutions based on genetic algorithms, we introduce the application of genetic techniques to more general problem solvers. These include classifier systems and genetic programming. We then describe society-based learning with examples from artificial life, or a-life, research. We conclude the chapter with an example of emergent computation from research at the Santa Fe Institute. We compare and contrast the three approaches we present to machine learning (symbol-based, connectionist, social and emergent) in a subsection of Chapter 16.

Finally, Chapter 16 serves as an epilogue for the book. It introduces the discipline of cognitive science, addresses contemporary challenges to AI, discusses AI's current limitations, and examines what we feel is its exciting future.

Using This Book

Artificial intelligence is a big field; consequently, this is a big book. Although it would require more than a single semester to cover all of the material in the text, we have designed it so that a number of paths may be taken through the material. By selecting subsets of the material, we have used this text for single semester and full year (two semester) courses.

We assume that most students will have had introductory courses in discrete mathematics, including predicate calculus and graph theory. If this is not true the instructor should spend more time on these concepts in the sections at the beginning of the text (2.1, 3.1). We also assume that students have had courses in data structures including trees, graphs, and recursion-based search using stacks, queues, and priority queues. If they have not, they should spend more time on the beginning sections of Chapters 3, 4, and 5.

In a one semester course, we go quickly through the first two parts of the book. With this preparation, students are able to appreciate the material in Part III. We then consider the PROLOG and LISP in Part IV and require students to build many of the representation and search techniques of the earlier sections. Alternatively, one of the languages, PROLOG, for example, can be introduced early in the course and be used to test out the data structures and search techniques as they are encountered. We feel the meta-interpreters presented in the language chapters are very helpful for building rule-based and other knowledge-intensive problem solvers.

In a two semester course, we are able to cover the application areas of Part V, especially the machine learning chapters, in appropriate detail. We also expect a much more detailed programming project from students. We think that it is very important in the second semester for students to revisit many of the primary sources in the AI literature. It is crucial for students to see both where we are, as well as how we got here, to have an appreciation of the future promise of our work. We use a collected set of readings for this purpose, *Computation and Intelligence* (Luger 1995).

The algorithms of our book are described using a Pascal-like pseudo-code. This notation uses the control structures of Pascal along with English descriptions of the tests and operations. We have added two useful constructs to the Pascal control structures. The first is a modified `case` statement that, rather than comparing the value of a variable with constant case labels, as in standard Pascal, lets each item be labeled with an arbitrary boolean test. The `case` evaluates these tests in order until one of them is true and then performs the associated action; all other actions are ignored. Those familiar with LISP will note that this has the same semantics as the LISP `cond` statement.

The other addition to the language is a `return` statement which takes one argument and can appear anywhere within a procedure or function. When the `return` is encountered, it causes the program to immediately exit the function, returning its argument as a result. Other than these modifications we used Pascal structure, with a reliance on the English descriptions, to make the algorithms clear.

Supplemental Material Available via the Internet

The PROLOG and LISP code in the book as well as a public domain C-PROLOG interpreter are available via ftp and www. To retrieve software: ftp aw.com and log in as "anonymous," using your e-mail address as the password. Change directories by typing: `cd aw/luger`. View the "readme" file (get README) for current ftp status. File names are also available using the UNIX "ls" or the DOS "dir" command. Using ftp and de-archiving files can get complicated. Instructions vary for Macintosh, DOS, or UNIX files. Consult your local wizard if you have questions. www sites include those for Addison-Wesley at www.aw.com/cseng/ and www.awl-he.com/computing. George Luger's web site is www.cs.unm.edu/CS_Dept/faculty/homepage/luger.html and e-mail is luger@cs.unm.edu. Bill Stubblefield's e-mail is wastubb@sandia.gov.

Acknowledgments

First, we would like to thank the many reviewers that have helped us develop our three editions. Their comments often suggested important additions of material and focus. These include Dennis Bahler, Skona Brittain, Philip Chan, Peter Collingwood, John Donald, Sarah Douglas, Christophe Giraud-Carrier, Andrew Kosmorosov, Ray Mooney, Bruce Porter, Jude Shavlik, Carl Stern, Marco Valtorta, and Bob Veroff. We also appreciate the numerous suggestions for building this book received both from reviews solicited by Addison-Wesley, as well as comments sent directly to us by e-mail. Andrew Kosmorosov,

Melanie Mitchell, Jared Saia, Jim Skinner, Carl Stern, and Bob Veroff, colleagues at the University of New Mexico, have been especially helpful in the technical editing of this book. In particular we wish to thank Carl Stern for his major role in developing the chapters on reasoning under uncertain situations and connectionist networks, Jared Saia for developing the stochastic models of Chapter 11, and Bob Veroff for his contribution to the chapter on automated reasoning. We thank Academic Press for permission to reprint, in an altered form, much of the material of Chapter 14; this appeared earlier in the book *Cognitive Science: The Science of Intelligent Systems* (Luger 1994). Finally, we especially thank more than a decade of students, including Andy Dofasky, Steve Kleban, Bill Klein, and Steve Verzi, who have used this text and software in its preliminary stages, for their help in expanding our horizons, as well as in removing typos and bugs.

We thank our many friends at Addison-Wesley for their support and encouragement in completing our writing task, especially Alan Apt in helping us with the first edition, Lisa Moller and Mary Tudor for their help on the second, and Victoria Henderson, Louise Wilson, and Karen Mosman for their assistance on the third. We thank Linda Cicarella of the University of New Mexico for her help in preparing both text and figures for publication.

We wish to thank Thomas Barrow, internationally recognized artist and University of New Mexico Professor of Art, who created the six photograms especially for this book after reading an early draft of the manuscript.

In a number of places, we have used figures or quotes from the work of other authors. We would like to thank the authors and publishers for their permission to use this material. These contributions are listed at the end of the text.

Artificial intelligence is an exciting and oftentimes rewarding discipline; may you enjoy your study as you come to appreciate its power and challenges.

George F. Luger
William A. Stubblefield
1 July 1997
Albuquerque

CONTENTS

Preface vii

PART I ARTIFICIAL INTELLIGENCE: ITS ROOTS AND SCOPE

Artificial Intelligence—An Attempted Definition 1

1 AI: HISTORY AND APPLICATIONS 3

1.1 From Eden to ENIAC: Attitudes toward Intelligence, Knowledge, and Human Artifice 3

1.1.1 Historical Foundations 4

1.1.2 The Development of Logic 7

1.1.3 The Turing Test 10

1.1.4 Biological and Social Models of Intelligence: Agent-Oriented Problem Solving 13

1.2 Overview of AI Application Areas 17

1.2.1 Game Playing 18

1.2.2 Automated Reasoning and Theorem Proving 19

1.2.3 Expert Systems 20

1.2.4 Natural Language Understanding and Semantic Modeling 22

1.2.5 Modeling Human Performance 23

1.2.6	Planning and Robotics	23
1.2.7	Languages and Environments for AI	25
1.2.8	Machine Learning	25
1.2.9	Parallel Distributed Processing (PDP) and Emergent Computation	26
1.2.10	AI and Philosophy	27
1.3	Artificial Intelligence—A Summary	28
1.4	Epilogue and References	29
1.5	Exercises	30

PART II

ARTIFICIAL INTELLIGENCE AS REPRESENTATION AND SEARCH

Knowledge Representation	34
--------------------------	----

Problem Solving as Search	41
---------------------------	----

2 THE PREDICATE CALCULUS 47

2.0	Introduction	47
2.1	The Propositional Calculus	47
2.1.1	Symbols and Sentences	47
2.1.2	The Semantics of the Propositional Calculus	49
2.2	The Predicate Calculus	52
2.2.1	The Syntax of Predicates and Sentences	52
2.2.2	A Semantics for the Predicate Calculus	58
2.3	Using Inference Rules to Produce Predicate Calculus Expressions	64
2.3.1	Inference Rules	64
2.3.2	Unification	68
2.3.3	A Unification Example	72
2.4	Application: A Logic-Based Financial Advisor	75

2.5	Epilogue and References	79
2.6	Exercises	79
3	STRUCTURES AND STRATEGIES FOR STATE SPACE SEARCH	81
3.0	Introduction	81
3.1	Graph Theory	84
3.1.1	Structures for State Space Search	84
3.1.2	State Space Representation of Problems	87
3.2	Strategies for State Space Search	93
3.2.1	Data-Driven and Goal-Driven Search	93
3.2.2	Implementing Graph Search	96
3.2.3	Depth-First and Breadth-First Search	99
3.2.4	Depth-First Search with Iterative Deepening	106
3.3	Using the State Space to Represent Reasoning with the Predicate Calculus	107
3.3.1	State Space Description of a Logical System	107
3.3.2	And/Or Graphs	109
3.3.3	Further Examples and Applications	111
3.4	Epilogue and References	121
3.5	Exercises	121
4	HEURISTIC SEARCH	123
4.0	Introduction	123
4.1	An Algorithm for Heuristic Search	127
4.1.1	Implementing "Best-First" Search	127
4.1.2	Implementing Heuristic Evaluation Functions	131
4.1.3	Heuristic Search and Expert Systems	136
4.2	Admissibility, Monotonicity, and Informedness	139

4.2.1	Admissibility Measures	139
4.2.2	Monotonicity	141
4.2.3	When One Heuristic Is Better: More Informed Heuristics	142
4.3	Using Heuristics in Games	144
4.3.1	The Minimax Procedure on Exhaustively Searchable Graphs	144
4.3.2	Minimaxing to Fixed Ply Depth	147
4.3.3	The Alpha-Beta Procedure	150
4.4	Complexity Issues	152
4.5	Epilogue and References	156
4.6	Exercises	156
5	CONTROL AND IMPLEMENTATION OF STATE SPACE SEARCH	159
5.0	Introduction	159
5.1	Recursion-Based Search	160
5.1.1	Recursion	160
5.1.2	Recursive Search	161
5.2	Pattern-Directed Search	164
5.2.1	Example: Recursive Search in the Knight's Tour Problem	165
5.2.2	Refining the Pattern-search Algorithm	168
5.3	Production Systems	171
5.3.1	Definition and History	171
5.3.2	Examples of Production Systems	174
5.3.3	Control of Search in Production Systems	180
5.3.4	Advantages of Production Systems for AI	184
5.4	Predicate Calculus and Planning	186
5.5	The Blackboard Architecture for Problem Solving	196
5.6	Epilogue and References	198
5.7	Exercises	199

PART III

REPRESENTATIONS FOR KNOWLEDGE-BASED PROBLEM SOLVING

- 6 KNOWLEDGE-INTENSIVE PROBLEM SOLVING 207**
- 6.0 Introduction 207
- 6.1 Overview of Expert System Technology 210
 - 6.1.1 The Design of Rule-Based Expert Systems 210
 - 6.1.2 Selecting a Problem for Expert System Development 212
 - 6.1.3 The Knowledge Engineering Process 214
 - 6.1.4 Conceptual Models and Their Role in Knowledge Acquisition 216
- 6.2 Rule-based Expert Systems 219
 - 6.2.1 The Production System and Goal-driven Problem Solving 220
 - 6.2.2 Explanation and Transparency in Goal-driven Reasoning 224
 - 6.2.3 Using the Production System for Data-driven Reasoning 226
 - 6.2.4 Heuristics and Control in Expert Systems 229
 - 6.2.5 Conclusions: Rule-Based Reasoning 230
- 6.3 Model-based Reasoning 231
 - 6.3.1 Introduction 231
- 6.4 Case-based Reasoning 235
 - 6.4.1 Introduction 235
- 6.5 The Knowledge-Representation Problem 240
- 6.6 Epilogue and References 245
- 6.7 Exercises 246

7 REASONING WITH UNCERTAIN OR INCOMPLETE INFORMATION 247

- 7.0 Introduction 247
- 7.1 The Statistical Approach to Uncertainty 249
 - 7.1.1 Bayesian Reasoning 250
 - 7.1.2 Bayesian Belief Networks 254
 - 7.1.3 The Dempster–Shafer Theory of Evidence 259
 - 7.1.4 The Stanford Certainty Factor Algebra 263
 - 7.1.5 Causal Networks 266
- 7.2 Introduction to Nonmonotonic Systems 269
 - 7.2.1 Logics for Nonmonotonic Reasoning 269
 - 7.2.2 Logics Based on Minimum Models 273
 - 7.2.3 Truth Maintenance Systems 275
 - 7.2.4 Set Cover and Logic Based Abduction (Stern 1996) 281
- 7.3 Reasoning with Fuzzy Sets 284
- 7.4 Epilogue and References 289
- 7.5 Exercises 290

8 KNOWLEDGE REPRESENTATION 293

- 8.0 Knowledge Representation Languages 293
- 8.1 Issues in Knowledge Representation 295
- 8.2 A Survey of Network Representation 297
 - 8.2.1 Associationist Theories of Meaning 297
 - 8.2.2 Early Work in Semantic Nets 301
 - 8.2.3 Standardization of Network Relationships 303
- 8.3 Conceptual Graphs: A Network Representation Language 309
 - 8.3.1 Introduction to Conceptual Graphs 309

8.3.2	Types, Individuals, and Names	311
8.3.3	The Type Hierarchy	313
8.3.4	Generalization and Specialization	314
8.3.5	Propositional Nodes	317
8.3.6	Conceptual Graphs and Logic	318
8.4	Structured Representations	320
8.4.1	Frames	320
8.4.2	Scripts	324
8.5	Issues in Knowledge Representation	328
8.5.1	Hierarchies, Inheritance, and Exceptions	328
8.5.2	Naturalness, Efficiency, and Plasticity	331
8.6	Epilogue and References	334
8.7	Exercises	335

PART IV LANGUAGES AND PROGRAMMING TECHNIQUES FOR ARTIFICIAL INTELLIGENCE

Languages, Understanding, and Levels of Abstraction	340
Desired Features of AI Language	342
An Overview of LISP and PROLOG	349
Object-Oriented Programming	352
Hybrid Environments	353
A Hybrid Example	354
Selecting an Implementation Language	356

9	AN INTRODUCTION TO PROLOG	357
9.0	Introduction	357
9.1	Syntax for Predicate Calculus Programming	358
9.1.1	Representing Facts and Rules	358
9.1.2	Creating, Changing, and Monitoring the PROLOG Environment	362
9.1.3	Recursion-Based Search in PROLOG	364
9.1.4	Recursive Search in PROLOG	366
9.1.5	The Use of Cut to Control Search in PROLOG	369
9.2	Abstract Data Types (ADTs) in PROLOG	371
9.2.1	The ADT Stack	371
9.2.2	The ADT Queue	373
9.2.3	The ADT Priority Queue	373
9.2.4	The ADT Set	374
9.3	A Production System Example in PROLOG	375
9.4	Designing Alternative Search Strategies	381
9.4.1	Depth-First Search Using the Closed List	381
9.4.2	Breadth-First Search in PROLOG	383
9.4.3	Best-First Search in PROLOG	384
9.5	A PROLOG Planner	386
9.6	PROLOG: Meta-Predicates, Types, and Unification	389
9.6.1	Meta-Logical Predicates	389
9.6.2	Types in PROLOG	391
9.6.3	Unification, the Engine for Predicate Matching and Evaluation	394
9.7	Meta-Interpreters in PROLOG	397
9.7.1	An Introduction to Meta-Interpreters: PROLOG in PROLOG	397
9.7.2	Shell for a Rule-Based Expert System	401
9.7.3	Semantic Nets in PROLOG	410
9.7.4	Frames and Schemata in PROLOG	412

9.8	PROLOG: Towards Nonprocedural Computing	415
9.9	Epilogue and References	421
9.10	Exercises	422
10	AN INTRODUCTION TO LISP	425
10.0	Introduction	425
10.1	LISP: A Brief Overview	426
10.1.1	Symbolic Expressions, the Syntactic Basis of LISP	426
10.1.2	Control of LISP Evaluation: <code>quote</code> and <code>eval</code>	430
10.1.3	Programming in LISP: Creating New Functions	431
10.1.4	Program Control in LISP: Conditionals and Predicates	433
10.1.5	Functions, Lists, and Symbolic Computing	436
10.1.6	Lists as Recursive Structures	438
10.1.7	Nested Lists, Structure, and <code>car/cdr</code> Recursion	441
10.1.8	Binding Variables Using <code>set</code>	444
10.1.9	Defining Local Variables Using <code>let</code>	446
10.1.10	Data Types in Common LISP	448
10.1.11	Conclusion	449
10.2	Search in LISP: A Functional Approach to the Farmer, Wolf, Goat, and Cabbage Problem	449
10.3	Higher-Order Functions and Procedural Abstraction	455
10.3.1	Maps and Filters	455
10.3.2	Functional Arguments and Lambda Expressions	457
10.4	Search Strategies in LISP	459
10.4.1	Breadth-First and Depth-First Search	459
10.4.2	Best-First Search	462
10.5	Pattern Matching in LISP	463
10.6	A Recursive Unification Function	465

10.6.1	Implementing the Unification Algorithm	465
10.6.2	Implementing Substitution Sets Using Association Lists	467
10.7	Interpreters and Embedded Languages	469
10.8	Logic Programming in LISP	472
10.8.1	A Simple Logic Programming Language	472
10.8.2	Streams and Stream Processing	474
10.8.3	A Stream-Based Logic Programming Interpreter	477
10.9	Streams and Delayed Evaluation	482
10.10	An Expert System Shell in LISP	486
10.10.1	Implementing Certainty Factors	486
10.10.2	Architecture of lisp-shell	488
10.10.3	User Queries and Working Memory	490
10.10.4	Classification Using lisp-shell	491
10.11	Network Representations and Inheritance	494
10.11.1	Representing Semantic Nets in LISP	494
10.11.2	Implementing Inheritance	497
10.12	Object-Oriented Programming Using CLOS	497
10.12.1	Defining Classes and Instances in CLOS	499
10.12.2	Defining Generic Functions and Methods	501
10.12.3	Inheritance in CLOS	503
10.12.4	Advanced Features of CLOS	505
10.12.5	Example: A Thermostat Simulation	505
10.13	Epilogue and References	511
10.14	Exercises	511

PART V

ADVANCED TOPICS FOR AI PROBLEM SOLVING

Natural Language, Automated Reasoning, and Learning 517

11 UNDERSTANDING NATURAL LANGUAGE 519

11.0 Role of Knowledge in Language Understanding 519

11.1 Language Understanding: A Symbolic Approach 522

11.1.1 Introduction 522

11.1.2 Stages of Language Analysis 523

11.2 Syntax 524

11.2.1 Specification and Parsing Using Context-Free Grammars 524

11.2.2 Transition Network Parsers 527

11.2.3 The Chomsky Hierarchy and Context-Sensitive Grammars 531

11.3 Combining Syntax and Semantics in ATN Parsers 534

11.3.1 Augmented Transition Network Parsers 534

11.3.2 Combining Syntax and Semantics 538

11.4 Stochastic Tools for Language Analysis 543

11.4.1 Introduction 543

11.4.2 A Markov Model Approach 545

11.4.3 A CART Tree Approach 546

11.4.4 Mutual Information Clustering 547

11.4.5 Parsing 548

11.4.6 Other Language Applications for Stochastic Techniques 550

11.5 Natural Language Applications 550

11.5.1 Story Understanding and Question Answering 550

11.5.2 A Database Front End 551

11.6 Epilogue and References 555

11.7 Exercises 557

12	AUTOMATED REASONING	559
12.0	Introduction to Weak Methods in Theorem Proving	559
12.1	The General Problem Solver and Difference Tables	560
12.2	Resolution Theorem Proving	566
12.2.1	Introduction	566
12.2.2	Producing the Clause Form for Resolution Refutations	568
12.2.3	The Binary Resolution Proof Procedure	573
12.2.4	Strategies and Simplification Techniques for Resolution	578
12.2.5	Answer Extraction from Resolution Refutations	583
12.3	PROLOG and Automated Reasoning	587
12.3.1	Introduction	587
12.3.2	Logic Programming and PROLOG	588
12.4	Further Issues in Automated Reasoning	593
12.4.1	Uniform Representations for Weak Method Solutions	593
12.4.2	Alternative Inference Rules	597
12.4.3	Search Strategies and Their Use	599
12.5	Epilogue and References	600
12.6	Exercises	601
13	MACHINE LEARNING: SYMBOL-BASED	603
13.0	Introduction	603
13.1	A Framework for Symbol-based Learning	606
13.2	Version Space Search	612
13.2.1	Generalization Operators and the Concept Space	612
13.2.2	The Candidate Elimination Algorithm	613
13.2.3	LEX: Inducing Search Heuristics	620
13.2.4	Evaluating Candidate Elimination	623

13.3	The ID3 Decision Tree Induction Algorithm	624
13.3.1	Top-Down Decision Tree Induction	627
13.3.2	Information Theoretic Test Selection	628
13.3.3	Evaluating ID3	632
13.3.4	Decision Tree Data Issues: Bagging, Boosting	632
13.4	Inductive Bias and Learnability	633
13.4.1	Inductive Bias	634
13.4.2	The Theory of Learnability	636
13.5	Knowledge and Learning	638
13.5.1	Meta-DENDRAL	639
13.5.2	Explanation-Based Learning	640
13.5.3	EBL and Knowledge-Level Learning	645
13.5.4	Analogical Reasoning	646
13.6	Unsupervised Learning	649
13.6.1	Discovery and Unsupervised Learning	649
13.6.2	Conceptual Clustering	651
13.6.3	COBWEB and the Structure of Taxonomic Knowledge	653
13.7	Epilogue and References	658
13.8	Exercises	659
14	MACHINE LEARNING: CONNECTIONIST	661
14.0	Introduction	661
14.1	Foundations for Connectionist Networks	663
14.1.1	Early History	663
14.2	Perceptron Learning	666
14.2.1	The Perceptron Training Algorithm	666
14.2.2	An Example: Using a Perceptron Network to Classify	668
14.2.3	The Delta Rule	672

14.3	Backpropagation Learning	675
14.3.1	Deriving the Backpropagation Algorithm	675
14.3.2	Backpropagation Example 1: NETtalk	679
14.3.3	Backpropagation Example 2: Exclusive-or	681
14.4	Competitive Learning	682
14.4.1	Winner-Take-All Learning for Classification	682
14.4.2	A Kohonen Network for Learning Prototypes	684
14.4.3	Grossberg Learning and Counterpropagation	686
14.5	Hebbian Coincidence Learning	690
14.5.1	Introduction	690
14.5.2	An Example of Unsupervised Hebbian Learning	691
14.5.3	Supervised Hebbian Learning	694
14.5.4	Associative Memory and the Linear Associator	696
14.6	Attractor Networks or "Memories"	701
14.6.1	Introduction	701
14.6.2	BAM, the Bi-directional Associative Memory	702
14.6.3	Examples of BAM Processing	704
14.6.4	Autoassociative Memory and Hopfield Nets	706
14.7	Epilogue and References	711
14.8	Exercises	712

15 MACHINE LEARNING: SOCIAL AND EMERGENT 713

15.0	Social and Emergent Models of Learning	713
15.1	The Genetic Algorithm	715
15.1.3	Two Examples: CNF Satisfaction and the Traveling Salesperson	717
15.1.4	Evaluating the Genetic Algorithm	721
15.2	Classifier Systems and Genetic Programming	725
15.2.1	Classifier Systems	725
15.2.2	Programming with Genetic Operators	730

- 15.3 Artificial Life and Society-based Learning 736
 - 15.3.1 The "Game of Life" 737
 - 15.3.2 Evolutionary Programming 740
 - 15.3.3 A Case Study in Emergence (Crutchfield and Mitchell 1994) 743
- 15.4 Epilogue and References 747
- 15.5 Exercises 748

PART VI

EPILOGUE

- Reflections on the Nature of Intelligence 751

16 ARTIFICIAL INTELLIGENCE AS EMPIRICAL ENQUIRY 753

- 16.0 Introduction 753
- 16.1 Artificial Intelligence: A Revised Definition 755
 - 16.1.1 Intelligence and the Physical Symbol System 756
 - 16.1.2 Minds, Brains, and Neural Computing 759
 - 16.1.3 Agents, Emergence, and Intelligence 761
 - 16.1.4 Situated Actors and the Existential Mind 764
- 16.2 Cognitive Science: An Overview 766
 - 16.2.1 The Analysis of Human Performance 766
 - 16.2.2 The Production System and Human Cognition 767
- 16.3 Current Issues in Machine Learning 770
- 16.4 Understanding Intelligence: Issues and Directions 775
- 16.5 Epilogue and References 780

Bibliography 781

Author Index 803

Subject Index 809

Acknowledgements 823



PART I

ARTIFICIAL INTELLIGENCE: ITS ROOTS AND SCOPE

Everything must have a beginning, to speak in Sanchean phrase; and that beginning must be linked to something that went before. Hindus give the world an elephant to support it, but they make the elephant stand upon a tortoise. Invention, it must be humbly admitted, does not consist in creating out of void, but out of chaos; the materials must, in the first place, be afforded. . . .

—MARY SHELLEY, *Frankenstein*

Artificial Intelligence: An Attempted Definition

Artificial intelligence (AI) may be defined as the branch of computer science that is concerned with the automation of intelligent behavior. This definition is particularly appropriate to this text in that it emphasizes our conviction that AI is a part of computer science and, as such, must be based on sound theoretical and applied principles of that field. These principles include the data structures used in knowledge representation, the algorithms needed to apply that knowledge, and the languages and programming techniques used in their implementation.

However, this definition suffers from the fact that intelligence itself is not very well defined or understood. Although most of us are certain that we know intelligent behavior when we see it, it is doubtful that anyone could come close to defining intelligence in a way that would be specific enough to help in the evaluation of a supposedly intelligent computer program, while still capturing the vitality and complexity of the human mind.

Thus the problem of defining artificial intelligence becomes one of defining intelligence itself: is intelligence a single faculty, or is it just a name for a collection of distinct and unrelated abilities? To what extent is intelligence learned as opposed to having an a priori existence? Exactly what does happen when learning occurs? What is creativity? What is intuition? Can intelligence be inferred from observable behavior, or does it require evidence of a particular internal mechanism? How is knowledge represented in the nerve tissue of a living being, and what lessons does this have for the design of intelligent machines? What is self-awareness, and what role does it play in

intelligence? Is it necessary to pattern an intelligent computer program after what is known about human intelligence, or is a strict "engineering" approach to the problem sufficient? Is it even possible to achieve intelligence on a computer, or does an intelligent entity require the richness of sensation and experience that might be found only in a biological existence?

These are all unanswered questions, and all of them have helped to shape the problems and solution methodologies that constitute the core of modern AI. In fact, part of the appeal of artificial intelligence is that it offers a unique and powerful tool for exploring exactly these questions. AI offers a medium and a test-bed for theories of intelligence: such theories may be stated in the language of computer programs and consequently verified through the execution of these programs on an actual computer.

For these reasons, our initial definition of artificial intelligence seems to fall short of unambiguously defining the field. If anything, it has only led to further questions and the paradoxical notion of a field of study whose major goals include its own definition. But this difficulty in arriving at a precise definition of AI is entirely appropriate. Artificial intelligence is still a young discipline, and its structure, concerns, and methods are less clearly defined than those of a more mature science such as physics.

Artificial intelligence has always been more concerned with expanding the capabilities of computer science than with defining its limits. Keeping this exploration grounded in sound theoretical principles is one of the challenges facing AI researchers in general and this text in particular.

Because of its scope and ambition, artificial intelligence defies simple definition. For the time being, we will simply define it as *the collection of problems and methodologies studied by artificial intelligence researchers*. This definition may seem silly and meaningless, but it makes an important point: artificial intelligence, like every science, is a human endeavor and may best be understood in that context.

There are reasons that any science, AI included, concerns itself with a certain set of problems and develops a particular body of techniques for approaching these problems. A short history of artificial intelligence and the people and assumptions that have shaped it will explain why a certain set of questions have come to dominate the field and why the methods discussed in this text have been taken for their solution.

AI: HISTORY AND APPLICATIONS

1

Hear the rest, and you will marvel even more at the crafts and resources I have contrived. Greatest was this: in the former times if a man fell sick he had no defense against the sickness, neither healing food nor drink, nor unguent; but through the lack of drugs men wasted away, until I showed them the blending of mild simples wherewith they drive out all manner of diseases. . . .

It was I who made visible to men's eyes the flaming signs of the sky that were before dim. So much for these. Beneath the earth, man's hidden blessing, copper, iron, silver, and gold—will anyone claim to have discovered these before I did? No one, I am very sure, who wants to speak truly and to the purpose. One brief word will tell the whole story: all arts that mortals have come from Prometheus.

—AESCHYLUS, *Prometheus Bound*

1.1 From Eden to ENIAC: Attitudes toward Intelligence, Knowledge, and Human Artifice

Prometheus speaks of the fruits of his transgression against the gods of Olympus: his purpose was not merely to steal fire for the human race but also to enlighten humanity through the gift of intelligence or *nous*: the “rational mind.” This intelligence forms the foundation for all of human technology and ultimately all human civilization. The work of the classical Greek dramatist illustrates a deep and ancient awareness of the extraordinary power of knowledge. Artificial intelligence, in its very direct concern for Prometheus's gift, has been applied to all the areas of his legacy—medicine, psychology, biology, astronomy, geology—and many areas of scientific endeavor that Aeschylus could not have imagined.

Though Prometheus's action freed humanity from the sickness of ignorance, it also earned him the wrath of Zeus. Outraged over this theft of knowledge that previously

belonged only to the gods of Olympus, Zeus commanded that Prometheus be chained to a barren rock to suffer the ravages of the elements for eternity. The notion that human efforts to gain knowledge constitute a transgression against the laws of God or nature is deeply ingrained in Western thought. It is the basis of the story of Eden and appears in the work of Dante and Milton. Both Shakespeare and the ancient Greek tragedians portrayed intellectual ambition as the cause of disaster. The belief that the desire for knowledge must ultimately lead to disaster has persisted throughout history, enduring the Renaissance, the Age of Enlightenment, and even the scientific and philosophical advances of the nineteenth and twentieth centuries. Thus, we should not be surprised that artificial intelligence inspires so much controversy in both academic and popular circles.

Indeed, rather than dispelling this ancient fear of the consequences of intellectual ambition, modern technology has only made those consequences seem likely, even imminent. The legends of Prometheus, Eve, and Faustus have been retold in the language of technological society. In her introduction to *Frankenstein* (subtitled, interestingly enough, *The Modern Prometheus*), Mary Shelley writes:

Many and long were the conversations between Lord Byron and Shelley to which I was a devout and silent listener. During one of these, various philosophical doctrines were discussed, and among others the nature of the principle of life, and whether there was any probability of its ever being discovered and communicated. They talked of the experiments of Dr. Darwin (I speak not of what the doctor really did or said that he did, but, as more to my purpose, of what was then spoken of as having been done by him), who preserved a piece of vermicelli in a glass case till by some extraordinary means it began to move with a voluntary motion. Not thus, after all, would life be given. Perhaps a corpse would be reanimated; galvanism had given token of such things: perhaps the component parts of a creature might be manufactured, brought together, and endued with vital warmth.

Shelley shows us the extent to which scientific advances such as the work of Darwin and the discovery of electricity had convinced even nonscientists that the workings of nature were not divine secrets, but could be broken down and understood systematically. Frankenstein's monster is not the product of shamanistic incantations or unspeakable transactions with the underworld: it is assembled from separately "manufactured" components and infused with the vital force of electricity. Although nineteenth-century science was inadequate to realize the goal of understanding and creating a fully intelligent agent, it affirmed the notion that the mysteries of life and intellect might be brought into the light of scientific analysis.

1.1.1 Historical Foundations

By the time Mary Shelley finally and perhaps irrevocably joined modern science with the Promethean myth, the philosophical foundations of modern work in artificial intelligence had been developing for several thousand years. Although the moral and cultural issues raised by artificial intelligence are both interesting and important, our introduction is more properly concerned with AI's intellectual heritage. The logical starting point for such a history is the genius of Aristotle, or, as Dante refers to him, "the master of those who

know.” Aristotle wove together the insights, wonders, and fears of the early Greek tradition with the careful analysis and disciplined thought that were to become the standard for more modern science.

For Aristotle, the most fascinating aspect of nature was change. In his *Physics*, he defined his “philosophy of nature” as the “study of things that change.” He distinguished between the “matter” and “form” of things: a sculpture is fashioned from the “material” bronze and has the “form” of a human. Change occurs when the bronze is molded to a new form. The matter/form distinction provides a philosophical basis for modern notions such as symbolic computing and data abstraction. In computing (even with numbers) we are manipulating patterns that are the forms of electromagnetic material, with the changes of form of this material representing aspects of the solution process. Abstracting the form from the medium of its representation not only allows these forms to be manipulated computationally but also provides the promise of a theory of data structures, the heart of modern computer science.

In his *Metaphysics* (located just after, *meta*, the *Physics* in his writing), Aristotle developed a science of things that never change, including his cosmology and theology. More relevant to artificial intelligence, however, was Aristotle’s epistemology or science of knowing, discussed in his *Logic*. Aristotle referred to his logic as the “instrument” (*organon*), because he felt that the study of thought itself was at the basis of all knowledge. In his *Logic*, he investigated whether certain propositions can be said to be “true” because they are related to other things that are known to be true. Thus if we know that “all men are mortal” and that “Socrates is a man,” then we can conclude that “Socrates is mortal.” This argument is an example of what Aristotle referred to as a syllogism using the deductive form *modus ponens*. Although the formal axiomatization of reasoning needed another two thousand years for its full flowering in the works of Gottlob Frege, Bertrand Russell, Kurt Gödel, Alan Turing, Alfred Tarski, and others, its roots may be traced to Aristotle.

Renaissance thought, building on the Greek tradition, initiated the evolution of a different and powerful way of thinking about humanity and its relation to the natural world. Empiricism began to replace mysticism as a means of understanding nature. Clocks and, eventually, factory schedules superseded the rhythms of nature for thousands of city dwellers. Most of the modern social and physical sciences found their origin in the notion that processes, whether natural or artificial, could be mathematically analyzed and understood. In particular, scientists and philosophers realized that thought itself, the way that knowledge was represented and manipulated in the human mind, was a difficult but essential subject for scientific study.

Perhaps the major event in the development of the modern world view was the Copernican revolution, the replacement of the ancient Earth-centered model of the universe with the idea that the Earth and other planets actually rotate around the sun. After centuries of an “obvious” order, in which the scientific explanation of the nature of the cosmos was consistent with the teachings of religion and common sense, a drastically different and not at all obvious model was proposed to explain the motions of heavenly bodies. For perhaps the first time, *our ideas about the world were seen as fundamentally distinct from its appearance*. This split between the human mind and its surrounding reality, between ideas about things and things themselves, is essential to the modern study

of the mind and its organization. This breach was widened by the writings of Galileo, whose scientific observations further contradicted the “obvious” truths about the natural world and whose development of mathematics as a tool for describing that world emphasized the distinction between the world and our ideas about it. It is out of this breach that the modern notion of the mind evolved: introspection became a common motif in literature, philosophers began to study epistemology and mathematics, and the systematic application of the scientific method rivaled the senses as tools for understanding the world.

Although the seventeenth and eighteenth centuries saw a great deal of work in epistemology and related fields, here we have space only to discuss the work of René Descartes. Descartes is a central figure in the development of the modern concepts of thought and the mind. In his famous *Meditations*, Descartes attempted to find a basis for reality purely through cognitive introspection. Systematically rejecting the input of his senses as untrustworthy, Descartes was forced to doubt even the existence of the physical world and was left with only the reality of thought; even his own existence had to be justified in terms of thought: “Cogito ergo sum” (I think, therefore I am). After he established his own existence purely as a thinking entity, Descartes inferred the existence of God as an essential creator and ultimately reasserted the reality of the physical universe as the necessary creation of a benign God.

We can make two interesting observations here: first, the schism between the mind and the physical world had become so complete that the process of thinking could be discussed in isolation from any specific sensory input or worldly subject matter; second, the connection between mind and the physical world was so tenuous that it required the intervention of a benign God to allow reliable knowledge of the physical world. This view of the duality between the mind and the physical world underlies all of Descartes’s thought, including his development of analytic geometry. How else could he have unified such a seemingly worldly branch of mathematics as geometry with such an abstract mathematical framework as algebra?

Why have we included this philosophical discussion in a text on artificial intelligence? There are two consequences of this analysis that are essential to the enterprise of artificial intelligence:

1. By separating the mind and the physical world, Descartes and related thinkers established that the structure of ideas about the world was not necessarily the same as the structure of their subject matter. This underlies the methodology of the field of AI, along with the fields of epistemology, psychology, much of higher mathematics, and most of modern literature: mental processes had an existence of their own, obeyed their own laws, and could be studied in and of themselves.
2. Once the mind and the body were separated, philosophers found it necessary to find a way to reconnect the two, because interaction between the mental and the physical is essential for human existence.

Although millions of words have been written on the *mind-body problem*, and numerous solutions proposed, no one has successfully explained the obvious interactions

between mental states and physical actions while affirming a fundamental difference between them. The most widely accepted response to this problem, and the one that provides an essential foundation for the study of AI, holds that the mind and the body are not fundamentally different entities at all. In this view, mental processes are indeed achieved by physical systems such as brains (or computers). Mental processes, like physical processes, can ultimately be characterized through formal mathematics. Or, as stated by the Scots philosopher David Hume, "Cognition is computation."

1.1.2 The Development of Logic

Once thinking had come to be regarded as a form of computation, its formalization and eventual mechanization were logical next steps. In the seventeenth century, Gottfried Wilhelm von Leibniz introduced the first system of formal logic and constructed machines for automating calculation (Leibniz 1887). Euler, in the eighteenth century, with his analysis of the "connectedness" of the bridges joining the riverbanks and islands of the city of Königsberg (see the introduction to Chapter 3), introduced the study of representations that abstractly capture the structure of relationships in the world (Euler 1735).

The formalization of graph theory also afforded the possibility of *state space search*, a major conceptual tool of artificial intelligence. We can use graphs to model the deeper structure of a problem. The nodes of a *state space graph* represent possible stages of a problem solution; the arcs of the graph represent inferences, moves in a game, or other steps in a problem solution. Solving the problem is a process of searching the state space graph for a path to a solution (Section 1.3 and Chapter 3). By describing the entire space of problem solutions, state space graphs provide a powerful tool for measuring the structure and complexity of problems and analyzing the efficiency, correctness, and generality of solution strategies.

As one of the originators of the science of operations research, as well as the designer of the first programmable mechanical computing machines, Charles Babbage, a nineteenth century mathematician, is arguably the earliest practitioner of artificial intelligence (Morrison and Morrison 1961). Babbage's "difference engine" was a special-purpose machine for computing the values of certain polynomial functions and was the forerunner of his "analytical engine." The analytical engine, designed but not successfully constructed during Babbage's lifetime, was a general-purpose programmable computing machine that presaged many of the architectural assumptions underlying the modern computer.

In describing the analytical engine, Ada Lovelace (1961), Babbage's friend, supporter, and collaborator, said:

We may say most aptly that the Analytical Engine weaves algebraical patterns just as the Jacquard loom weaves flowers and leaves. Here, it seems to us, resides much more of originality than the difference engine can be fairly entitled to claim.

Babbage's inspiration was his desire to apply the technology of his day to liberate humans from the drudgery of arithmetic calculation. In this sentiment, as well as his conception of his computers as mechanical devices, Babbage was thinking in purely

nineteenth-century terms. His analytical engine, however, included many modern notions, such as the separation of memory and processor (the “store” and the “mill” in Babbage’s terms), the concept of a digital rather than analog machine, and programmability based on the execution of a series of operations encoded on punched pasteboard cards. The most striking feature of Ada Lovelace’s description, and of Babbage’s work in general, is its treatment of the “pattern” of an intellectual activity as an entity that may be studied, characterized, and finally implemented mechanically without concern for the particular values that are finally passed through the “mill” of the calculating machine. This is an implementation of the “abstraction and manipulation of form” first described by Aristotle.

The goal of creating a formal language for thought also appears in the work of George Boole, another nineteenth-century mathematician whose work must be included in any discussion of the roots of artificial intelligence (Boole 1847, 1854). Although he made contributions to a number of areas of mathematics, his best known work was in the mathematical formalization of the laws of logic, an accomplishment that forms the very heart of modern computer science. Though the role of Boolean algebra in the design of logic circuitry is well known, Boole’s own goals in developing his system seem closer to those of contemporary AI researchers. In the first chapter of *An Investigation of the Laws of Thought, on which are founded the Mathematical Theories of Logic and Probabilities*, Boole described his goals as

to investigate the fundamental laws of those operations of the mind by which reasoning is performed: to give expression to them in the symbolical language of a Calculus, and upon this foundation to establish the science of logic and instruct its method; ...and finally to collect from the various elements of truth brought to view in the course of these inquiries some probable intimations concerning the nature and constitution of the human mind.

The greatness of Boole’s accomplishment is in the extraordinary power and simplicity of the system he devised: three operations, “AND” (denoted by $*$ or \wedge), “OR” (denoted by $+$ or \vee), and “NOT” (denoted by \neg), formed the heart of his logical calculus. These operations have remained the basis for all subsequent developments in formal logic, including the design of modern computers. While keeping the meaning of these symbols nearly identical to the corresponding algebraic operations, Boole noted that “the Symbols of logic are further subject to a special law, to which the symbols of quantity, as such, are not subject.” This law states that for any X , an element in the algebra, $X * X = X$ (or that once something is known to be true, repetition cannot augment that knowledge). This led to the characteristic restriction of Boolean values to the only two numbers that may satisfy this equation: 1 and 0. The standard definitions of Boolean multiplication (AND) and addition (OR) follow from this insight. Boole’s system not only provided the basis of binary arithmetic but also demonstrated that an extremely simple formal system was adequate to capture the full power of logic. This assumption and the system Boole developed to demonstrate it form the basis of all modern efforts to formalize logic, from Russell and Whitehead’s *Principia Mathematica* (Whitehead and Russell 1950), through the work of Turing and Gödel, up to modern automated reasoning systems.

Gottlob Frege, in his *Foundations of Arithmetic* (Frege 1879, 1884), created a mathematical specification language for describing the basis of arithmetic in a clear and

precise fashion. With this language Frege formalized many of the issues first addressed by Aristotle's *Logic*. Frege's language, now called the *first-order predicate calculus*, offers a tool for describing the propositions and truth value assignments that make up the elements of mathematical reasoning and describes the axiomatic basis of "meaning" for these expressions. The formal system of the predicate calculus, which includes predicate symbols, a theory of functions, and quantified variables, was intended to be a language for describing mathematics and its philosophical foundations. It also plays a fundamental role in creating a theory of representation for artificial intelligence (Chapter 2). The first-order predicate calculus offers the tools necessary for automating reasoning: a language for expressions, a theory for assumptions related to the meaning of expressions, and a logically sound calculus for inferring new true expressions.

Russell and Whitehead's (1950) work is particularly important to the foundations of AI, in that their stated goal was to derive the whole of mathematics through formal operations on a collection of axioms. Although many mathematical systems have been constructed from basic axioms, what is interesting is Russell and Whitehead's commitment to mathematics as a purely formal system. This meant that axioms and theorems would be treated solely as strings of characters: proofs would proceed solely through the application of well-defined rules for manipulating these strings. There would be no reliance on intuition or the meaning of theorems as a basis for proofs. Every step of a proof followed from the strict application of formal (syntactic) rules to either axioms or previously proven theorems, even where traditional proofs might regard such a step as "obvious." What "meaning" the theorems and axioms of the system might have in relation to the world would be independent of their logical derivations. This treatment of mathematical reasoning in purely formal (and hence mechanical) terms provided an essential basis for its automation on physical computers. The logical syntax and formal rules of inference developed by Russell and Whitehead are still a basis for automatic theorem-proving systems as well as for the theoretical foundations of artificial intelligence.

Alfred Tarski is another mathematician whose work is essential to the foundations of AI. Tarski created a *theory of reference* wherein the *well-formed formulae* of Frege or Russell and Whitehead can be said to refer, in a precise fashion, to the physical world (Tarski 1944, 1956; see Chapter 2). This insight underlies most theories of formal semantics. In his paper "The semantic conception of truth and the foundation of semantics," Tarski describes his theory of reference and truth value relationships. Modern computer scientists, especially Scott, Strachey, Burstall (Burstall and Darlington 1977), and Plotkin have related this theory to programming languages and other specifications for computing.

Although in the eighteenth, nineteenth, and early twentieth centuries the formalization of science and mathematics created the intellectual prerequisite for the study of artificial intelligence, it was not until the twentieth century and the introduction of the digital computer that AI became a viable scientific discipline. By the end of the 1940s electronic digital computers had demonstrated their potential to provide the memory and processing power required by intelligent programs. It was now possible to implement formal reasoning systems on a computer and empirically test their sufficiency for exhibiting intelligence. An essential component of the science of artificial intelligence is this commitment to digital computers as the vehicle of choice for creating and testing theories of intelligence.

Digital computers are not merely a vehicle for testing theories of intelligence. Their architecture also suggests a specific paradigm for such theories: intelligence is a form of information processing. The notion of search as a problem-solving methodology, for example, owes more to the sequential nature of computer operation than it does to any biological model of intelligence. Most AI programs represent knowledge in some formal language that is then manipulated by algorithms, honoring the separation of data and program fundamental to the von Neumann style of computing. Formal logic has emerged as the lingua franca of AI research, whereas graph theory plays an indispensable role in the analysis of problem spaces as well as providing a basis for semantic networks and similar models of semantic meaning. These techniques and formalisms are discussed in detail throughout the body of this text; we mention them here to emphasize the symbiotic relationship between the digital computer and the theoretical underpinnings of artificial intelligence.

We often forget that the tools we create for our own purposes tend to shape our conception of the world through their structure and limitations. Although seemingly restrictive, this interaction is an essential aspect of the evolution of human knowledge: a tool (and scientific theories are ultimately only tools) is developed to solve a particular problem. As it is used and refined, the tool itself seems to suggest other applications, leading to new questions and, ultimately, the development of new tools.

1.1.3 The Turing Test

One of the earliest papers to address the question of machine intelligence specifically in relation to the modern digital computer was written in 1950 by the British mathematician Alan Turing. "Computing machinery and intelligence" (Turing 1950) remains timely in both its assessment of the arguments against the possibility of creating an intelligent computing machine and its answers to those arguments. Turing, known mainly for his contributions to the theory of computability, considered the question of whether or not a machine could actually be made to think. Noting that the fundamental ambiguities in the question itself (what is thinking? what is a machine?) precluded any rational answer, he proposed that the question of intelligence be replaced by a more clearly defined empirical test.

The Turing test measures the performance of an allegedly intelligent machine against that of a human being, arguably the best and only standard for intelligent behavior. The test, which Turing called the "imitation game," places the machine and a human counterpart in rooms apart from a second human being, referred to as the "interrogator" (Figure 1.1). The interrogator is not able to see or speak directly to either of them, does not know which entity is actually the machine, and may communicate with them solely by use of a textual device such as a terminal. The interrogator is asked to distinguish the computer from the human being solely on the basis of their answers to questions asked over this device. If the interrogator cannot distinguish the machine from the human, then, Turing argues, the machine may be assumed to be intelligent.

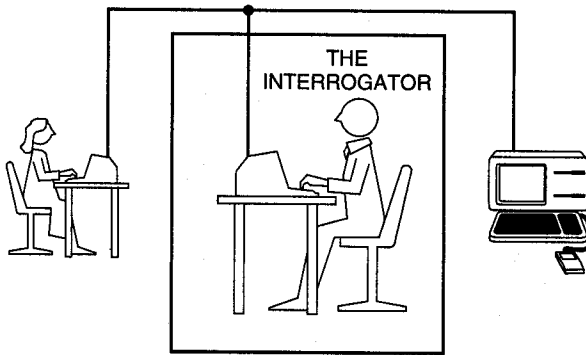

Figure 1.1 The Turing test.

By isolating the interrogator from both the machine and the other human participant, the test ensures that the interrogator will not be biased by the appearance of the machine or any mechanical property of its voice. The interrogator is free, however, to ask any questions, no matter how devious or indirect, in an effort to uncover the computer's identity. For example, the interrogator may ask both subjects to perform a rather involved arithmetic calculation, assuming that the computer will be more likely to get it correct than the human; to counter this strategy, the computer will need to know when it should fail to get a correct answer to such problems in order to seem like a human. To discover the human's identity on the basis of emotional nature, the interrogator may ask both subjects to respond to a poem or work of art; this strategy will require that the computer have knowledge concerning the emotional makeup of human beings.

The important features of this test are:

1. It gives us an objective notion of intelligence, i.e., the behavior of a known intelligent being in response to a particular set of questions. This provides a standard for determining intelligence that avoids the inevitable debates over its "true" nature.
2. It prevents us from being sidetracked by such confusing and currently unanswerable questions as whether or not the computer uses the appropriate internal processes or whether or not the machine is actually conscious of its actions.
3. It eliminates any bias in favor of living organisms by forcing the interrogator to focus solely on the content of the answers to questions.

Because of these advantages, the Turing test provides a basis for many of the schemes actually used to evaluate modern AI programs. A program that has potentially achieved intelligence in some area of expertise may be evaluated by comparing its performance on a given set of problems to that of a human expert. This evaluation technique is just a variation of the Turing test: a group of humans are asked to blindly compare the performance of a computer and a human being on a particular set of problems. As we will

see, this methodology has become an essential tool in both the development and verification of modern expert systems.

The Turing test, in spite of its intuitive appeal, is vulnerable to a number of justifiable criticisms. One of the most important of these is aimed at its bias toward purely symbolic problem-solving tasks. It does not test abilities requiring perceptual skill or manual dexterity, even though these are important components of human intelligence. Conversely, it is sometimes suggested that the Turing test needlessly constrains machine intelligence to fit a human mold. Perhaps machine intelligence is simply different from human intelligence and trying to evaluate it in human terms is a fundamental mistake. Do we really wish a machine would do mathematics as slowly and inaccurately as a human? Shouldn't an intelligent machine capitalize on its own assets, such as a large, fast, reliable memory, rather than trying to emulate human cognition? In fact, a number of modern AI practitioners (e.g., Hayes and Ford 1995) see responding to the full challenge of Turing's test as a mistake and a major distraction to the more important work at hand: developing general theories to explain the mechanisms of intelligence in humans and machines, and applying those theories to the development of tools to solve specific, practical problems. Although we agree with their concerns in the large, we still see Turing's test as an important component in the verification and validation of modern AI software.

Turing also addressed the very feasibility of constructing an intelligent program on a digital computer. By thinking in terms of a specific model of computation (an electronic discrete state computing machine), he made some well-founded conjectures concerning the storage capacity, program complexity, and basic design philosophy required for such a system. Finally, he addressed a number of moral, philosophical, and scientific objections to the possibility of constructing such a program in terms of an actual technology. The reader is referred to Turing's article for a perceptive and still relevant summary of the debate over the possibility of intelligent machines.

Two of the objections cited by Turing are worth considering further. "Lady Lovelace's Objection," first stated by Ada Lovelace, argues that computers can only do as they are told and consequently cannot perform original (hence, intelligent) actions. This objection has become a reassuring if somewhat dubious part of contemporary technological folklore. Expert systems (Section 1.2.3 and Chapter 6), for example, have reached conclusions unanticipated by their designers. Indeed, a number of researchers now feel that human creativity can be expressed in a computer program.

The other related objection, the "Argument from Informality of Behavior," asserts the impossibility of creating a set of rules that will tell an individual exactly what to do under every possible set of circumstances. Certainly, the flexibility that enables a biological intelligence to respond to an infinite range of situations in a reasonable if not necessarily optimal fashion is a hallmark of intelligent behavior. While it is true that the control structure used in most traditional computer programs does not demonstrate great flexibility or originality, it is not true that all programs must be written in this fashion. Indeed, much of the work done in AI over the past 25 years has been in the development of programming languages and models such as production systems, object-based systems, network representations, and others discussed in this text that attempt to overcome this deficiency.

Modern AI programs generally consist of a collection of modular components, or rules of behavior, that do not execute in a rigid order but rather are invoked as needed in

response to the structure of a particular problem instance. Pattern matchers allow general rules to apply over a range of instances. These systems have an extreme flexibility that enables relatively small programs to exhibit a vast range of possible behaviors in response to differing problems and situations.

Whether these systems can ultimately be made to exhibit the flexibility shown by a living organism is still the subject of much debate. Nobel laureate Herbert Simon has argued that much of the originality and variability of behavior shown by living creatures is due to the richness of their environment rather than the complexity of their own internal programs. In *The Sciences of the Artificial*, Simon (1981) describes an ant progressing circuitously along an uneven and cluttered stretch of ground. Although the ant's path seems quite complex, Simon argues that the ant's goal is very simple: to return to its colony as quickly as possible. The twists and turns in its path are caused by the obstacles it encounters on its way. Simon concludes that

An ant, viewed as a behaving system, is quite simple. The apparent complexity of its behavior over time is largely a reflection of the complexity of the environment in which it finds itself.

This idea, if ultimately proved to apply to organisms of higher intelligence as well as to such simple creatures as insects, constitutes a powerful argument that such systems are relatively simple and, consequently, comprehensible. It is interesting to note that if one applies this idea to humans, it becomes a strong argument for the importance of culture in the forming of intelligence. Rather than growing in the dark like mushrooms, intelligence seems to depend on an interaction with a suitably rich environment. Culture is just as important in creating humans as human beings are in creating culture. Rather than denigrating our intellects, this idea emphasizes the miraculous richness and coherence of the cultures that have formed out of the lives of separate human beings. In fact, the idea that intelligence emerges from the interactions of individual elements of a society is one of the insights supporting the approach to AI technology presented in the next section.

1.1.4 Biological and Social Models of Intelligence: Agent-Oriented Problem Solving

So far, we have approached the problem of building intelligent machines from the viewpoint of mathematics, with the implicit belief of logical reasoning as paradigmatic of intelligence itself, as well as with a commitment to "objective" foundations for logical reasoning. This way of looking at knowledge, language, and thought reflects the rationalist tradition of western philosophy, as it evolved through Plato, Galileo, Descartes, Leibniz, and many of the other philosophers discussed in this chapter. It also reflects the underlying assumptions of the Turing test, particularly its emphasis on symbolic reasoning as a test of intelligence, and the belief that a straightforward comparison with human behavior was adequate to confirming machine intelligence.

The reliance on logic as a way of representing knowledge and on logical inference as the primary mechanism for intelligent reasoning are so dominant in Western philosophy that their "truth" often seems obvious and unassailable. It is no surprise, then, that

approaches based on these assumptions have dominated the science of artificial intelligence from its inception through to the present day.

The latter half of the twentieth century has, however, seen numerous challenges to rationalist philosophy. Various forms of philosophical relativism question the objective basis of language, science, society, and thought itself. Ludwig Wittgenstein's later philosophy (Wittgenstein 1953), has forced us to reconsider the basis on meaning in both natural and formal languages. The work of Godel and Turing has cast doubt on the very foundations of mathematics itself. Post-modern thought has changed our understanding of meaning and value in the arts and society. Artificial intelligence has not been immune to these criticisms; indeed, the difficulties that AI has encountered in achieving its goals are often taken as evidence of the failure of the rationalist viewpoint (Winograd and Flores 1986).

Two philosophical traditions, that of Wittgenstein (1953) and that of Husserl (1970, 1972) and Heidegger (1962) are central to this re-appraisal of the Western philosophical tradition. In his later work, Wittgenstein questioned many of the assumptions of the rationalist tradition, including the foundations of language, science, and knowledge itself. Natural language was a major focus of Wittgenstein's analysis, where he challenged the notion that human language derived its meaning from any sort of objective foundation.

For Wittgenstein, as well as the speech act theory developed by Austin (1962) and his followers (Grice 1975, Searle 1969), the meaning of any utterance depends on its being situated in a human, cultural context. My understanding of the meaning of the word "chair," for example, is dependent on my having a physical body that conforms to a sitting posture and the cultural conventions for using chairs. When, for example, is a large, flat rock a chair? Why is it odd to refer to the throne of England as a chair? What is the difference between a human being's understanding of a chair and that of a dog or cat that are incapable of sitting in the human sense? Based on his attacks on the foundations of meaning, he argued that we should view the use of language in terms of choices made and actions taken in a shifting cultural context. Wittgenstein even extended his criticisms to science and mathematics, arguing that they are just as much social constructs as is language use.

Husserl (1970, 1972), the father of phenomenology, was committed to abstractions as rooted in the concrete "l'enswelt" or "life-world": a rationalist model was very much secondary to the concrete world that supported it. For Husserl, as for his student Heidegger (1962), and their modern proponent Merleau-Ponty (1962), intelligence was not knowing what was true, but rather knowing how to cope in a world that was constantly changing and evolving. Thus, for the existentialist/phenomenologist tradition, intelligence is seen as survival in the world, rather than as a set of logical propositions about the world (combined with an inferencing scheme).

Many authors, for example Dreyfus and Dreyfus (1985) and Winograd and Flores (1986), have drawn on Wittgenstein's and the Husserl/Heidigger work in their criticisms of AI. Although many AI practioners continue developing the rational/logical agenda (also known as GOFAI, or Good Old-Fashioned AI), a growing number of researchers in the field have incorporated these criticisms into new and exciting models of intelligence. In keeping with Wittgenstein's emphasis on the anthropological and cultural roots of

knowledge, they have turned to social, sometimes referred to as “situated,” models of intelligent behavior for their inspiration.

As an example of an alternative to a logic based approach, research in connectionist networks (Section 1.2.9 and Chapter 14) de-emphasizes logic and the functioning of the rational mind in an effort to achieve intelligence by modeling the architecture of the physical brain. Neural models of intelligence emphasize the brain’s ability to adapt to the world in which it is situated by modifying the relationships between individual neurons. Rather than representing knowledge in explicit logical sentences, they capture it implicitly, as a property of patterns of relationships.

Another biologically based model of intelligence takes its inspiration from the processes by which entire species adapt to their surroundings. Work in artificial life and genetic algorithms (Chapter 15) applies the principles of biological evolution to the problems of finding solutions to difficult problems. These programs do not solve problems by reasoning logically about them; rather, they spawn populations of competing candidate solutions and drive them to evolve ever better solutions through a process patterned after biological evolution: Poor candidate solutions tend to die out, while those that show promise of solving a problem survive and reproduce by constructing new solutions out of components of their successful parents.

Social systems provide another metaphor for intelligence in that they exhibit global behaviors that enable them to solve problems that would confound any of their individual members. For example, although no individual could accurately predict the number of loaves of bread to be consumed in New York City on a given day, the entire system of New York bakeries does an excellent job of keeping the city stocked with bread, and doing so with minimal waste. The stock market does an excellent job of setting the relative values of hundreds of companies, even though each individual investor has only limited knowledge of a few companies. A final example comes from modern science. Individuals, located in university, industry, or government environments focus on common problems. With conferences and journals as the main communication media, problems important to society at large are attacked and (usually) solved by individual agents working semi-independently.

These examples share two themes: first, the view of intelligence as rooted in culture and society and, as a consequence, emergent. The second theme is that intelligence is reflected by the collective behaviors of large numbers of very simple interacting, semi-autonomous individuals, or agents. Whether we take these agents to be neural cells, individual members of a species, or a single person in a society, their interactions produce intelligence.

What are the main themes supporting an agent-oriented and emergent view of intelligence? They include:

1. Agents are autonomous or semi-autonomous. That is, each agent has certain responsibilities in problem solving with little or no knowledge of either what other agents do or how they do it. Each agent does its own independent piece of the problem solving and either produces a result itself (does something) or reports its result back to others in the community of agents.

2. Agents are “situated.” Each agent is sensitive to its own surrounding environment and (usually) has no knowledge of the full domain of all agents. Thus, an agent’s knowledge is limited to the tasks to hand: “the-file-I’m-processing” or “the-wall-next-to-me” with no knowledge of the total range of files or physical constraints in the problem solving task.
3. Agents are interactional. That is, they form a collection of individuals that cooperate on a particular task. In this sense they may be seen as a “society” and, as with human society, knowledge, skills, and responsibilities, even when seen as collective, are distributed across the population of individuals.
4. The society of agents is structured. In most views of agent-oriented problem solving each individual, although having its own unique environment and skill set, will coordinate with other agents in the overall problem solving. Thus, a final solution will not only be seen as collective, but also as cooperative.
5. Finally, the phenomenon of intelligence in this environment is “emergent.” Although individual agents are seen as possessing sets of skills and responsibilities, the overall cooperative result of the society of agents can be viewed as greater than the sum of its individual contributors. Intelligence is seen as a phenomenon resident in and emerging from a society and not just a property of an individual agent.

Based on these observations, we define an agent as an element of a society that can perceive (often limited) aspects of its environment and affect that environment either directly or through cooperation with other agents. Most intelligent solutions require a variety of agents. These include rote agents, that simply capture and communicate pieces of information, coordination agents that can support the interactions between other agents, search agents that can examine multiple pieces of information and return some chosen bit of it, learning agents that can examine collections of information and form concepts or generalizations, and decision agents that can both dispatch tasks and come to conclusions in the light of limited information and processing. Going back to an older definition of intelligence, agents can be seen as the mechanisms supporting decision making in the context of limited processing resources.

The main requisites for designing and building such a society are:

1. structures for the representation of information,
2. strategies for the search through alternative solutions, and
3. the creation of architectures that can support the interaction of agents.

The remaining chapters of our book include prescriptions for the construction of support tools for this society of agents.

Our preliminary discussion of the possibility of a theory of automated intelligence is in no way intended to overstate the progress made to date or minimize the work that lies ahead. As we emphasize throughout this text, it is important to be aware of our limitations and to be honest about our successes. For example, there have been only limited results with programs that in any interesting sense can be said to “learn.” Our accomplishments in modeling the semantic complexities of a natural language such as English have also been very modest. Even fundamental issues such as organizing knowledge or fully managing the complexity and correctness of very large computer programs (such as large knowledge bases) require considerable further research. Knowledge-based systems, though they have achieved marketable engineering successes, still have many limitations in the quality and generality of their reasoning. These include their inability to perform *commonsense reasoning* or to exhibit knowledge of rudimentary physical reality, such as how things change over time.

But we must maintain a reasonable perspective. It is easy to overlook the accomplishments of artificial intelligence when honestly facing the work that remains. In the next section, we establish this perspective through an overview of several areas of artificial intelligence research and development.

1.2 Overview of AI Application Areas

The Analytical Engine has no pretensions whatever to originate anything. It can do whatever we know how to order it to perform.

—ADA BYRON, *Countess of Lovelace*

I'm sorry Dave; I can't let you do that.

—HAL 9000 in *2001: A Space Odyssey* by Arthur C. Clarke

We now return to our stated goal of defining artificial intelligence through an examination of the ambitions and accomplishments of workers in the field. The two most fundamental concerns of AI researchers are *knowledge representation* and *search*. The first of these addresses the problem of capturing in a formal language, i.e., one suitable for computer manipulation, the full range of knowledge required for intelligent behavior. Chapter 2 introduces predicate calculus as a language for describing the properties and relationships among objects in problem domains that require qualitative reasoning rather than arithmetic calculations for their solutions. Later chapters (6, 7, and 8) discuss the languages that artificial intelligence has developed for representing the ambiguities and complexities of areas such as commonsense reasoning and natural language understanding. Chapters 9 and 10 demonstrate the use of LISP and PROLOG to implement these representations

Search is a problem-solving technique that systematically explores a space of *problem states*, i.e., successive and alternative stages in the problem-solving process. Examples of

problem states might include the different board configurations in a game or intermediate steps in a reasoning process. This space of alternative solutions is then searched to find a final answer. Newell and Simon (1976) have argued that this is the essential basis of human problem solving. Indeed, when a chess player examines the effects of different moves or a doctor considers a number of alternative diagnoses, they are searching among alternatives. The implications of this model and techniques for its implementation are discussed in Chapters 3, 4, and 5.

Like most sciences, AI is decomposed into a number of subdisciplines that, while sharing an essential approach to problem solving, have concerned themselves with different applications. In this section we outline several of these major application areas and their contributions to artificial intelligence as a whole.

1.2.1 Game Playing

Much of the early research in state space search was done using common board games such as checkers, chess, and the 15-puzzle. In addition to their inherent intellectual appeal, board games have certain properties that made them ideal subjects for this early work. Most games are played using a well-defined set of rules: this makes it easy to generate the search space and frees the researcher from many of the ambiguities and complexities inherent in less structured problems. The board configurations used in playing these games are easily represented on a computer, requiring none of the complex formalisms needed to capture the semantic subtleties of more complex problem domains. As games can be easily played, testing a game-playing program presents no financial or ethical burden. State space search, the paradigm underlying most game-playing research, is presented in Chapters 3 and 4.

Games can generate extremely large search spaces. These are large and complex enough to require powerful techniques for determining what alternatives to explore in the problem space. These techniques are called *heuristics* and constitute a major area of AI research. A heuristic is a useful but potentially fallible problem-solving strategy, such as checking to make sure that an unresponsive appliance is plugged in before assuming that it is broken or trying to protect your queen from capture in a chess game. Much of what we call intelligence resides in the heuristics used by humans to solve problems.

Because most of us have some experience with these simple games, it is possible to devise and test the effectiveness of our own heuristics. We do not need to find and consult an expert in some esoteric problem area such as medicine or mathematics (chess is an obvious exception to this rule). For these reasons, games provide a rich domain for the study of heuristic search. Chapter 4 introduces heuristics using these simple games; Chapter 6 extends their application to expert systems. Game-playing programs, in spite of their simplicity, offer their own challenges, including an opponent whose moves may not be reliably anticipated. This presence of the opponent further complicates program design by adding an element of unpredictability and the need to consider psychological as well as tactical factors in game strategy.

1.2.2 Automated Reasoning and Theorem Proving

We could argue that automatic theorem proving is the oldest branch of artificial intelligence, tracing its roots back through Newell and Simon's Logic Theorist (Newell and Simon 1963a) and General Problem Solver (Newell and Simon 1963b) to its origins in Russell and Whitehead's efforts to treat all of mathematics as the purely formal derivation of theorems from basic axioms. In any case, it has certainly been one of the most fruitful branches of the field. Theorem-proving research was responsible for much of the early work in formalizing search algorithms and developing formal representation languages such as predicate calculus (Chapter 2) and the logic programming language PROLOG (Chapter 9).

Most of the appeal of automated theorem proving lies in the rigor and generality of logic. Because it is a formal system, logic lends itself to automation. A wide variety of problems can be attacked by representing the problem description and relevant background information as logical axioms and treating problem instances as theorems to be proved. This insight is the basis of work in automatic theorem proving and mathematical reasoning systems (Chapter 12).

Unfortunately, early efforts at writing theorem provers failed to develop a system that could consistently solve complicated problems. This was due to the ability of any reasonably complex logical system to generate an infinite number of provable theorems: without powerful techniques (heuristics) to guide their search, automated theorem provers proved large numbers of irrelevant theorems before stumbling onto the correct one. In response to this inefficiency, many argue that purely formal, syntactic methods of guiding search are inherently incapable of handling such a huge space and that the only alternative is to rely on the informal, *ad hoc* strategies that humans seem to use in solving problems. This is the approach underlying the development of expert systems, and it has proved to be a fruitful one.

Still, the appeal of reasoning based in formal mathematical logic is too strong to ignore. Many important problems such as the design and verification of logic circuits, verification of the correctness of computer programs, and control of complex systems seem to respond to such an approach. In addition, the theorem-proving community has enjoyed success in devising powerful heuristics that rely solely on an evaluation of the syntactic form of a logical expression, reducing the complexity of the search space without resorting to the *ad hoc* techniques used by human problem solvers.

Another reason for the continued interest in automatic theorem provers is the realization that such a system does not have to be capable of independently solving extremely complex problems without human assistance. Many modern theorem provers function as intelligent assistants, letting humans perform the more demanding tasks of decomposing a large problem into subproblems and devising heuristics for searching the space of possible proofs. The theorem prover then performs the simpler but still demanding task of proving lemmas, verifying smaller conjectures, and completing the formal aspects of a proof outlined by its human associate (Boyer and Moore 1979).

1.2.3 Expert Systems

One major insight gained from early work in problem solving was the importance of domain-specific knowledge. A doctor, for example, is not effective at diagnosing illness solely because she possesses some innate general problem-solving skill; she is effective because she knows a lot about medicine. Similarly, a geologist is effective at discovering mineral deposits because he is able to apply a good deal of theoretical and empirical knowledge about geology to the problem at hand. Expert knowledge is a combination of a theoretical understanding of the problem and a collection of heuristic problem-solving rules that experience has shown to be effective in the domain. Expert systems are constructed by obtaining this knowledge from a human expert and coding it into a form that a computer may apply to similar problems.

This reliance on the knowledge of a human domain expert for the system's problem-solving strategies is a major feature of expert systems. Although some programs are written in which the designer is also the source of the domain knowledge, it is far more typical to see such programs growing out of a collaboration between a domain expert such as a doctor, chemist, geologist, or engineer and a separate artificial intelligence specialist. The domain expert provides the necessary knowledge of the problem domain through a general discussion of her problem-solving methods and by demonstrating those skills on a carefully chosen set of sample problems. The AI specialist, or *knowledge engineer*, as expert systems designers are often known, is responsible for implementing this knowledge in a program that is both effective and seemingly intelligent in its behavior. Once such a program has been written, it is necessary to refine its expertise through a process of giving it example problems to solve, letting the domain expert criticize its behavior, and making any required changes or modifications to the program's knowledge. This process is repeated until the program has achieved the desired level of performance.

One of the earliest systems to exploit domain-specific knowledge in problem solving was DENDRAL, developed at Stanford in the late 1960s (Lindsay et al. 1980). DENDRAL was designed to infer the structure of organic molecules from their chemical formulas and mass spectrographic information about the chemical bonds present in the molecules. Because organic molecules tend to be very large, the number of possible structures for these molecules tends to be huge. DENDRAL addresses the problem of this large search space by applying the heuristic knowledge of expert chemists to the structure elucidation problem. DENDRAL's methods proved remarkably effective, routinely finding the correct structure out of millions of possibilities after only a few trials. The approach has proved so successful that descendants of the system are used in chemical laboratories throughout the world.

Whereas DENDRAL was one of the first programs to effectively use domain-specific knowledge to achieve expert level problem-solving performance, MYCIN established the methodology of contemporary expert systems (Buchanan and Shortliff 1984). MYCIN uses expert medical knowledge to diagnose and prescribe treatment for spinal meningitis and bacterial infections of the blood.

MYCIN, developed at Stanford in the mid-1970s, was one of the first programs to address the problems of reasoning with uncertain or incomplete information. MYCIN provided clear and logical explanations of its reasoning, used a control structure

appropriate to the specific problem domain, and identified criteria to reliably evaluate its performance. Many of the expert system development techniques currently in use were first developed in the MYCIN project (Chapter 8).

Other classic expert systems include the PROSPECTOR program for determining the probable location and type of ore deposits based on geological information about a site (Duda et al. 1979a, 1979b), the INTERNIST program for performing diagnosis in the area of internal medicine, the Dipmeter Advisor for interpreting the results of oil well drilling logs (Smith and Baker 1983), and XCON for configuring VAX computers. XCON has been in use since 1981; every VAX sold by Digital Equipment Corporation is now configured by XCON. Numerous other expert systems are currently solving problems in areas such as medicine, education, business, design, and science (Waterman 1986). It is interesting to note that most expert systems have been written for relatively specialized, expert level domains. These domains are generally well studied and have clearly defined problem-solving strategies. Problems that depend on a more loosely defined notion of "common sense" are much more difficult to solve by these means (Part IV). In spite of the promise of expert systems, it would be a mistake to overestimate the ability of this technology. Current deficiencies include:

1. Difficulty in capturing "deep" knowledge of the problem domain. MYCIN, for example, lacks any real knowledge of human physiology. It does not know what blood does or the function of the spinal cord. Folklore has it that once, when selecting a drug for treatment of meningitis, MYCIN asked whether the patient was pregnant, even though it had been told that the patient was male. Whether this actually occurred or not, it does illustrate the potential narrowness of expert systems.
2. Lack of robustness and flexibility. If humans are presented with a problem instance that they cannot solve immediately, they can generally return to an examination of first principles and come up with some strategy for attacking the problem. Expert systems generally lack this ability.
3. Inability to provide deep explanations. Because expert systems lack deep knowledge of their problem domains, their explanations are generally restricted to a description of the steps they took in finding a solution. They cannot tell "why" a certain approach was taken.
4. Difficulties in verification. Though the correctness of any large computer system is difficult to prove, expert systems are particularly difficult to verify. This is a serious problem, as expert systems technology is being applied to critical applications such as air traffic control, nuclear reactor operations, and weapons systems.
5. Little learning from experience. Current expert systems are handcrafted; once the system is completed, its performance will not improve without further attention from its programmers. This leads to severe doubts about the intelligence of such systems.

In spite of these limitations, expert systems are proving their value in a number of important applications. It is hoped that these limitations will only encourage the student to pursue this important new branch of computer science. Expert systems are a major topic in this text and are discussed in Chapters 6 and 7.

1.2.4 Natural Language Understanding and Semantic Modeling

One of the long-standing goals of artificial intelligence is the creation of programs that are capable of understanding human language. Not only does the ability to understand natural language seem to be one of the most fundamental aspects of human intelligence, but also its successful automation would have an incredible impact on the usability and effectiveness of computers themselves. Much effort has been put into writing programs that understand natural language. Although these programs have achieved success within restricted contexts, systems that can use natural language with the flexibility and generality that characterize human speech are beyond current methodologies.

Understanding natural language involves much more than parsing sentences into their individual parts of speech and looking those words up in a dictionary. Real understanding depends on extensive background knowledge about the domain of discourse and the idioms used in that domain as well as an ability to apply general contextual knowledge to resolve the omissions and ambiguities that are a normal part of human speech.

Consider, for example, the difficulties in carrying on a conversation about baseball with an individual who understands English but knows nothing about the rules, players, or history of the game. Could this person possibly understand the meaning of the sentence: "With none down in the top of the ninth and the go-ahead run at second, the manager called his relief from the bull pen"? Even though all of the words in the sentence may be individually understood, this sentence would be gibberish to even the most intelligent non-baseball fan.

The task of collecting and organizing this background knowledge in such a way that it may be applied to language comprehension forms the major problem in automating natural language understanding. Responding to this need, researchers have developed many of the techniques for structuring semantic meaning used throughout artificial intelligence (Chapters 7, 8, and 11).

Because of the tremendous amounts of knowledge required for understanding natural language, most work is done in well-understood, specialized problem areas. One of the earliest programs to exploit this "micro world" methodology was Winograd's SHRDLU, a natural language system that could "converse" about a simple configuration of blocks of different shapes and colors (Winograd 1973). SHRDLU could answer queries such as "what color block is on the blue cube?" and plan actions such as "move the red pyramid onto the green brick." Problems of this sort, involving the description and manipulation of simple arrangements of blocks, have appeared with surprising frequency in AI research and are known as "blocks world" problems.

In spite of SHRDLU's success in conversing about arrangements of blocks, its methods did not generalize from the blocks world. The representational techniques used in the program were too simple to capture the semantic organization of richer and more

complex domains in a useful way. Much of the current work in natural language understanding is devoted to finding representational formalisms that are general enough to be used in a wide range of applications yet adapt themselves well to the specific structure of a given domain. A number of different techniques (most of which are extensions or modifications of *semantic networks*) are explored for this purpose and used in the development of programs that can understand natural language in constrained but interesting knowledge domains. Finally, in current research (Grosz 1997, Marcus 1980) stochastic models and approaches, describing how sets of words “co-occur” in language environments, are used to characterize the semantic content of sentences. General natural language understanding, however, remains beyond the current state of the art.

1.2.5 Modeling Human Performance

Although much of the above discussion uses human intelligence as a reference point in considering artificial intelligence, it does not follow that programs should pattern themselves after the organization of the human mind. Indeed, many AI programs are engineered to solve some useful problem without regard for their similarities to human mental architecture. Even expert systems, while deriving much of their knowledge from human experts, do not really attempt to simulate human internal mental processes. If performance is the only criterion by which a system will be judged, there may be little reason to attempt to simulate human problem-solving methods; in fact, programs that take nonhuman approaches to solving problems are often more successful than their human counterparts. Still, the design of systems that explicitly model some aspect of human problem solving has been a fertile area of research in both artificial intelligence and psychology.

Human performance modeling, in addition to providing AI with much of its basic methodology, has proved to be a powerful tool for formulating and testing theories of human cognition. The problem-solving methodologies developed by computer scientists have given psychologists a new metaphor for exploring the human mind. Rather than casting theories of cognition in the vague language used in early research or abandoning the problem of describing the inner workings of the human mind entirely (as suggested by the behaviorists), many psychologists have adopted the language and theory of computer science to formulate models of human intelligence. Not only do these techniques provide a new vocabulary for describing human intelligence, but also computer implementations of these theories offer psychologists an opportunity to empirically test, critique, and refine their ideas (Luger 1994). Further discussion of the relationship between artificial intelligence and efforts to understand human intelligence is found throughout the text and summarized in Chapter 16.

1.2.6 Planning and Robotics

Planning is an important aspect of the effort to design robots that perform their task with some degree of flexibility and responsiveness to the outside world. Briefly, planning

assumes a robot that is capable of performing certain atomic actions. It attempts to find a sequence of those actions that will accomplish some higher-level task, such as moving across an obstacle-filled room.

Planning is a difficult problem for a number of reasons, not the least of which is the size of the space of possible sequences of moves. Even an extremely simple robot is capable of generating a vast number of potential move sequences. Imagine, for example, a robot that can move forward, backward, right, or left, and consider how many different ways that robot can possibly move around a room. Assume also that there are obstacles in the room and that the robot must select a path that moves around them in some efficient fashion. Writing a program that can intelligently discover the best path under these circumstances, without being overwhelmed by the huge number of possibilities, requires sophisticated techniques for representing spatial knowledge and controlling search through possible environments.

One method that human beings use in planning is *hierarchical problem decomposition*. If you are planning a trip to London, you will generally treat the problems of arranging a flight, getting to the airport, making airline connections, and finding ground transportation in London separately, even though they are all part of a bigger overall plan. Each of these may be further decomposed into smaller subproblems such as finding a map of the city, negotiating the subway system, and finding a decent pub. Not only does this approach effectively restrict the size of the space that must be searched, but also allows saving of frequently used subplans for future use.

While humans plan effortlessly, creating a computer program that can do the same is a difficult challenge. A seemingly simple task such as breaking a problem into independent subproblems actually requires sophisticated heuristics and extensive knowledge about the planning domain. Determining what subplans should be saved and how they may be generalized for future use is an equally difficult problem.

A robot that blindly performs a sequence of actions without responding to changes in its environment or being able to detect and correct errors in its own plan could hardly be considered intelligent. Often, a robot will have to formulate a plan based on incomplete information and correct its behavior as it executes the plan. A robot may not have adequate sensors to locate all obstacles in the way of a projected path. Such a robot must begin moving through the room based on what it has "perceived" and correct its path as other obstacles are detected. Organizing plans in a fashion that allows response to environmental conditions is another major problem for planning.

Finally, robotics was one of the research areas in AI that produced many of the insights supporting agent-oriented problem solving (Section 1.1.4). Frustrated by both the complexities of maintaining the large representational space as well as the design of adequate search algorithms for traditional planning, researchers, including Agre and Chapman (1987) and Brooks (1991a), restated the larger problem in terms of the interaction of multiple semi-autonomous agents. Each agent was responsible for its own portion of the problem task and through their coordination the larger solution would emerge. We present the elements of planning algorithms in Chapters 5 and 9.

1.2.7 Languages and Environments for AI

Some of the most important by-products of artificial intelligence research are advances in programming languages and software development environments. For a number of reasons, including the sheer size of most AI application programs, the tendency of search algorithms to generate huge spaces, and the difficulty of predicting the behavior of heuristically driven programs, AI programmers have been forced to develop a powerful set of programming methodologies.

Programming environments include knowledge-structuring techniques such as object-oriented programming and expert systems frameworks (these are discussed in Part III). High-level languages, such as LISP and PROLOG (Part IV), which strongly support modular development, help manage program size and complexity. Trace packages allow a programmer to reconstruct the execution of a complex algorithm and make it possible to unravel the complexities of heuristically guided search. Without such tools and techniques, it is doubtful that many significant AI systems could have been built.

Many of these techniques are now standard tools for software engineering and have little relationship to the core of AI theory. Others, such as object-oriented programming, are of significant theoretical and practical interest.

The languages developed for artificial intelligence programming are intimately bound to the theoretical structure of the field. We cover both LISP and PROLOG in this text and prefer to remain apart from religious debates over the relative merits of these languages. Rather, we adhere to the adage "a good worker knows all the tools." The language chapters (9 and 10) discuss the advantages of each language for specific programming tasks.

1.2.8 Machine Learning

Learning has remained a difficult problem for AI programs, in spite of their success as problem solvers. This shortcoming seems severe, particularly as the ability to learn is one of the most important components of intelligent behavior. An expert system may perform extensive and costly computations to solve a problem. Unlike a human being, however, if it is given the same or a similar problem a second time, it will not remember the solution. It performs the same sequence of computations again. This is true the second, third, fourth, and every time it solves that problem—hardly the behavior of an intelligent problem solver.

Most expert systems are hindered by the inflexibility of their problem-solving strategies and the difficulty of modifying large amounts of code. The obvious solution to these problems is for programs to learn on their own, either from experience, analogy, and examples or by being "told" what to do.

Although learning is a difficult area of research, several programs have been written that suggest that this is not an impossible goal. Perhaps the most striking such program is AM, the Automated Mathematician, designed to discover mathematical laws (Lenat 1977, 1982). Initially given the concepts and axioms of set theory, AM was able to induce such important mathematical concepts as cardinality and integer arithmetic and many of the results of number theory. AM conjectured new theorems by modifying its current

knowledge base and used heuristics to pursue the most “interesting” of a number of possible alternatives.

Other influential work includes Winston’s research on the induction of structural concepts such as “arch” from a set of examples in the blocks world (Winston 1975a). The ID3 algorithm has proved successful in learning general patterns from examples (Quinlan 1986a). Meta-DENDRAL learns rules for interpreting mass spectrographic data in organic chemistry from examples of data on compounds of known structure. Teiresias, an intelligent “front end” for expert systems, converts high-level advice into new rules for its knowledge base (Davis 1982). Hacker devises plans for performing blocks world manipulations through an iterative process of devising a plan, testing it, and correcting any flaws discovered in the candidate plan (Sussman 1975). Work in explanation-based learning has shown the effectiveness of prior knowledge in learning (Mitchell et al. 1986, DeJong and Mooney 1986).

The success of machine learning programs suggests the existence of a set of general learning principles that will allow the construction of programs with the ability to learn in realistic domains. We discuss machine learning in Chapters 13, 14, and 15.

1.2.9 Parallel Distributed Processing (PDP) and Emergent Computation

Most of the techniques presented in this text use explicitly represented knowledge and carefully designed search algorithms to implement intelligence. A very different approach seeks to build intelligent programs using models that parallel the structure of neurons in the human brain.

A simple schematic of a neuron (Figure 1.2) consists of a cell body that has a number of branched protrusions, called *dendrites*, and a single branch called the *axon*. Dendrites receive signals from other neurons. When these combined impulses exceed a certain threshold, the neuron fires and an impulse, or “spike,” passes down the axon. Branches at the end of the axon form *synapses* with the dendrites of other neurons. The synapse is the point of contact between neurons; synapses may be either *excitatory* or *inhibitory*. An excitatory synapse adds to the total of signals reaching the neuron; an inhibitory synapse subtracts from this total.

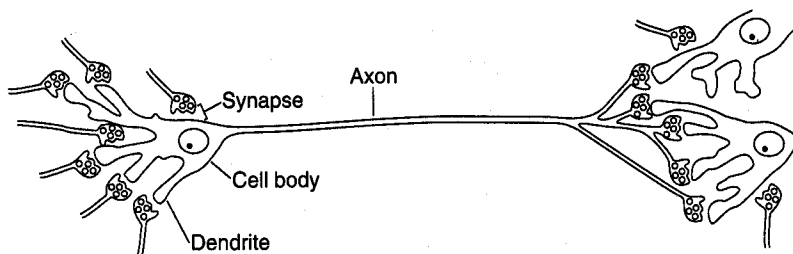

Figure 1.2 A simplified diagram of a neuron, from (Crick and Asanuma 1986).

This description of a neuron is excessively simple, but it captures those features that are relevant to neural models of computation. In particular, each computational unit computes some function of its inputs and passes the result along to connected units in the network. Instead of using explicit symbols and operations, the knowledge of the system *emerges* out of the entire network of neural connections and threshold values.

Neural architectures are appealing as mechanisms for implementing intelligence for a number of reasons. Traditional AI programs tend to be brittle and overly sensitive to noise: rather than degrading gracefully, such programs tend to either be right or fail completely. Human intelligence is much more flexible; we are good at interpreting noisy input, such as recognizing a face in a darkened room from an odd angle or following a single conversation in a noisy party. Even where a human may not be able to solve some problem, we generally can make a reasonable guess as to its solution. Neural architectures, because they capture knowledge in a large number of fine-grained units, seem to have more potential for partially matching noisy and incomplete data.

Neural architectures are also more robust because knowledge is distributed somewhat uniformly around the network. Experience with people who have lost part of their brain from disease or accident has shown that they do not lose specific memories; rather they suffer more general degradations of their mental processes.

Neural architectures also provide a natural model for parallelism, because each neuron is an independent unit. Hillis (1985) has commented on the fact that humans get faster at a task as they acquire more knowledge, while computers tend to slow down. This slowdown is due to the cost of sequentially searching a knowledge base; a massively parallel architecture like the human brain would not suffer from this problem. Finally, something is intrinsically appealing about approaching the problems of intelligence from a neural point of view. After all, the brain achieves intelligence and it does so using a neural architecture. We present neural networks and other models of emergent computation, including genetic algorithms and artificial life, in Chapters 14 and 15.

1.2.10 AI and Philosophy

In Section 1.1 we presented the philosophical, mathematical, and sociological roots of artificial intelligence. It is important to realize that modern AI is not just a product of this rich intellectual tradition but also contributes to it.

For example, the questions that Turing posed about intelligent programs also reflect back on our understanding of intelligence itself. What is intelligence, and how may it be described? What is the nature of knowledge? Can knowledge be represented? What is skill? How does knowledge in an application area relate to problem-solving skill in that domain? How does *knowing what* is true, Aristotle's *theoria*, relate to *knowing how* to perform, his *praxis*?

Answers proposed to these questions make up an important part of what AI researchers and designers do. In the scientific sense, AI programs can be viewed as experiments. A design is made concrete in a program and the program is run as an experiment. The program designers observe the results and then redesign and rerun the experiment. In this manner we can determine whether our representations and algorithms

are sufficient models of intelligent behavior. Newell and Simon (1976) proposed this approach to scientific understanding in their 1976 Turing Award lecture.

Newell and Simon (1976) also propose a stronger model for intelligence with their physical symbol system hypothesis: *the necessary and sufficient condition for a physical system to exhibit intelligence is that it be a physical symbol system*. What this hypothesis means in practice as well as how it may be criticized we take up in Chapter 16.

A number of AI's application areas also open up deep philosophical issues. In what sense can we say that a computer can understand natural language expressions? To produce or understand a language requires interpretation of symbols. It is not sufficient to be able to say that a string of symbols is well formed. A mechanism for understanding must be able to impute meaning or interpret symbols in context. What is meaning? What is interpretation? In what sense does interpretation require responsibility?

Similar philosophical issues emerge from many AI application areas, whether they be building expert systems to cooperate with human problem solvers, designing computer vision systems, or designing algorithms for machine learning. We look at many of these issues as they come up in the chapters of this book and address the general issue of relevance to philosophy again in Chapter 16.

1.3 Artificial Intelligence—A Summary

We have attempted to define artificial intelligence through discussion of its major areas of research and application. This survey reveals a young and promising field of study whose primary concern is finding an effective way to understand and apply intelligent problem-solving, planning, and communication skills to a wide range of practical problems. In spite of the variety of problems addressed in artificial intelligence research, a number of important features emerge that seem common to all divisions of the field; these include:

1. The use of computers to do symbolic reasoning, pattern recognition, learning, or some other form of inference.
2. A focus on problems that do not respond to algorithmic solutions. This underlies the reliance on heuristic search as an AI problem-solving technique.
3. A concern with problem solving using inexact, missing, or poorly defined information and the use of representational formalisms that enable the programmer to compensate for these problems.
4. Reasoning about the significant qualitative features of a situation.
5. An attempt to deal with issues of semantic meaning as well as syntactic form.
6. Answers that are neither exact nor optimal, but are in some sense "sufficient." This is a result of the essential reliance on heuristic problem-solving methods in situations where optimal or exact results are either too expensive or not possible.

7. The use of large amounts of domain-specific knowledge in solving problems. This is the basis of expert systems.
8. The use of meta-level knowledge to effect more sophisticated control of problem-solving strategies. Although this is a very difficult problem, addressed in relatively few current systems, it is emerging as an essential area of research.

We hope that this introduction provides some feel for the overall structure and significance of the field of artificial intelligence. We also hope that the brief discussions of such technical issues as search and representation were not excessively cryptic and obscure; they are developed in proper detail throughout the remainder of the text. They were included here to demonstrate their significance in the more general organization of the field.

As we mentioned in the discussion of agent-oriented problem solving, objects take on meaning through their relationships with other objects. This is equally true of the facts, theories, and techniques that constitute a field of scientific study. We have intended to give a sense of those interrelationships, so that when the separate technical themes of artificial intelligence are presented, they will find their place in a developing understanding of the overall substance and directions of the field. We are guided by an observation made by Gregory Bateson, the psychologist and systems theorist (Bateson 1979):

Break the pattern which connects the items of learning and you necessarily destroy all quality.

1.4 Epilogue and References

The challenging field of AI reflects some of the oldest concerns of Western civilization in the light of the modern computational model. The notions of rationality, representation, and reason are now under scrutiny as perhaps never before, because we computer scientists demand to understand them algorithmically! At the same time, the political, economic, and ethical situation of our species forces us to confront our responsibility for the effects of our artifices. The interplay between applications and the more humanistic aspirations for much of AI continues to inspire hosts of rich, challenging questions. We hope you will glean from the following chapters both a familiarity with the contemporary concepts and techniques of AI and an appreciation for the timelessness of the problems they address.

Several excellent sources available on the topics raised in this chapter are *Mind Design* (Haugeland 1981), *Artificial Intelligence: The Very Idea* (Haugeland 1985), *Brainstorms* (Dennett 1978), *Elbow Room* (Dennett 1984), *Consciousness Explained* (Dennett 1991), and *Darwin's Dangerous Idea* (Dennett 1995). Several of the primary sources are also readily available, including Aristotle's *Physics*, *Metaphysics*, and *Logic*; papers by Frege; and the writings of Babbage, Boole, and Russell and Whitehead. Turing's papers are also very interesting, especially his discussions of the nature of intelligence and the possibility of designing intelligent programs (Turing 1950). Turing's biography, *Alan*

Turing: The Enigma (Hodges 1983), also makes excellent reading. A critique of the Turing test may be found in Hayes and Ford (1995).

Computer Power and Human Reason (Weizenbaum 1976) and *Understanding Computers and Cognition* (Winograd and Flores 1986) offer sobering comments on the limitations of and ethical issues in AI. *The Sciences of the Artificial* (Simon 1981) is a positive statement on the possibility of artificial intelligence and its role in society.

The AI applications mentioned in Section 1.2 are intended to introduce the reader to the broad interests of AI researchers and outline many of the important questions under investigation. *The Handbook of Artificial Intelligence* (Barr and Feigenbaum 1989) offers an introduction to each of these areas. Besides the *Handbook* we recommend, for extended treatment of game playing, *Principles of Artificial Intelligence* (Nilsson 1980) and *Heuristics* (Pearl 1984); this is also an important topic in our Chapters 2 through 5. We discuss automated reasoning in Chapters 2, 3, and 12; some of the highlights in the literature of automated reasoning are *Automated Reasoning* (Wos et al. 1984), “Non-resolution theorem proving” (Bledsoe 1977), and *A Computational Logic* (Boyer and Moore 1979).

After reading our Chapters 6 and 7, the reader can get a good feel of the area for expert systems in *Expert Systems: Artificial Intelligence in Business* (Harmon and King 1985), *Building Expert Systems* (Hayes-Roth et al. 1993), and *A Guide to Expert Systems* (Waterman 1986). Natural language understanding is a dynamic field of study; some important points of view are expressed in *Natural Language Understanding* (Allen 1987), *Language as a Cognitive Process* (Winograd 1983), *Inside Computer Understanding* (Schank and Riesbeck 1981), *Computer Models of Thought and Language* (Schank and Colby 1973), and *Grammar, Meaning and the Machine Analysis of Language* (Wilks 1972); an introduction to the field is presented in our Chapters 8 and 11.

Using computers to model human performance, which we present in Chapter 16, is discussed in some depth in *Human Problem Solving* (Newell and Simon 1972), *Computation and Cognition* (Pylyshyn 1984), “Arguments concerning representations for mental imagery” (Anderson 1978) and *Cognitive Science: the Science of Intelligent Systems* (Luger 1994). Planning and robotics (see our Chapters 5 and 9) are well surveyed in Volume 3 of the *Handbook of Artificial Intelligence* (Barr and Feigenbaum 1981).

The subject of AI-oriented languages and environments is explored in Chapters 9 and 10 of this text; see also *Principles of Programming Languages* (MacLennan 1987) and *Smalltalk/V* (Anon. Digitalk 1986). Machine learning is discussed in some detail in Chapters 13-15; the multi-volume set, *Machine Learning* (Michalski et al. 1983, 1986; Kodratoff and Michalski 1989), and the *Journal of Machine Learning* are important sources.

Chapters 14 and 15 present a view of intelligence that emphasizes its modular structure and adaptation within a social and natural context. Minsky’s *Society of Mind* (1985) is one of the earliest and most thought provoking articulations of this point of view. Also see *Android Epistemology* (Ford et al. 1995) and *Artificial Life* (Langton 1995).

1.5 Exercises

1. Create and justify your own definition of artificial intelligence.

2. Give several other examples of Aristotle's distinction between "matter" and "form." Can you show how your examples might fit into a theory of abstraction?
3. Much traditional Western thought has dwelt on the mind-body relationship. Are the mind and body:
 - a. distinct entities somehow interacting, or
 - b. is mind an expression of "physical processes," or
 - c. is body just an illusion of the rational mind?

Discuss your thoughts on the mind-body problem and its importance for a theory of artificial intelligence.

4. Criticize Turing's criteria for computer software being "intelligent."
5. Describe your own criteria for computer software to be considered "intelligent."
6. Although computing is a relatively new discipline, philosophers and mathematicians have been thinking about the issues involved in automating problem solving for thousands of years. What is your opinion of the relevance of these philosophical issues to the design of a device for intelligent problem solving? Justify your answer.
7. Given the differences between the architectures of modern computers and that of the human brain, what relevance does research into the physiological structure and function of biological systems have for the engineering of AI programs? Justify your answer.
8. Pick one problem area that you feel would justify the energy required to design an expert system solution. Spell the problem out in some detail. Based on your own intuition, which aspects of this solution would be most difficult to automate?
9. Add two more benefits for expert systems to those already listed in the text. Discuss these in terms of intellectual, social, or financial results.
10. List and discuss two potentially negative effects on society of the development of artificial intelligence techniques.

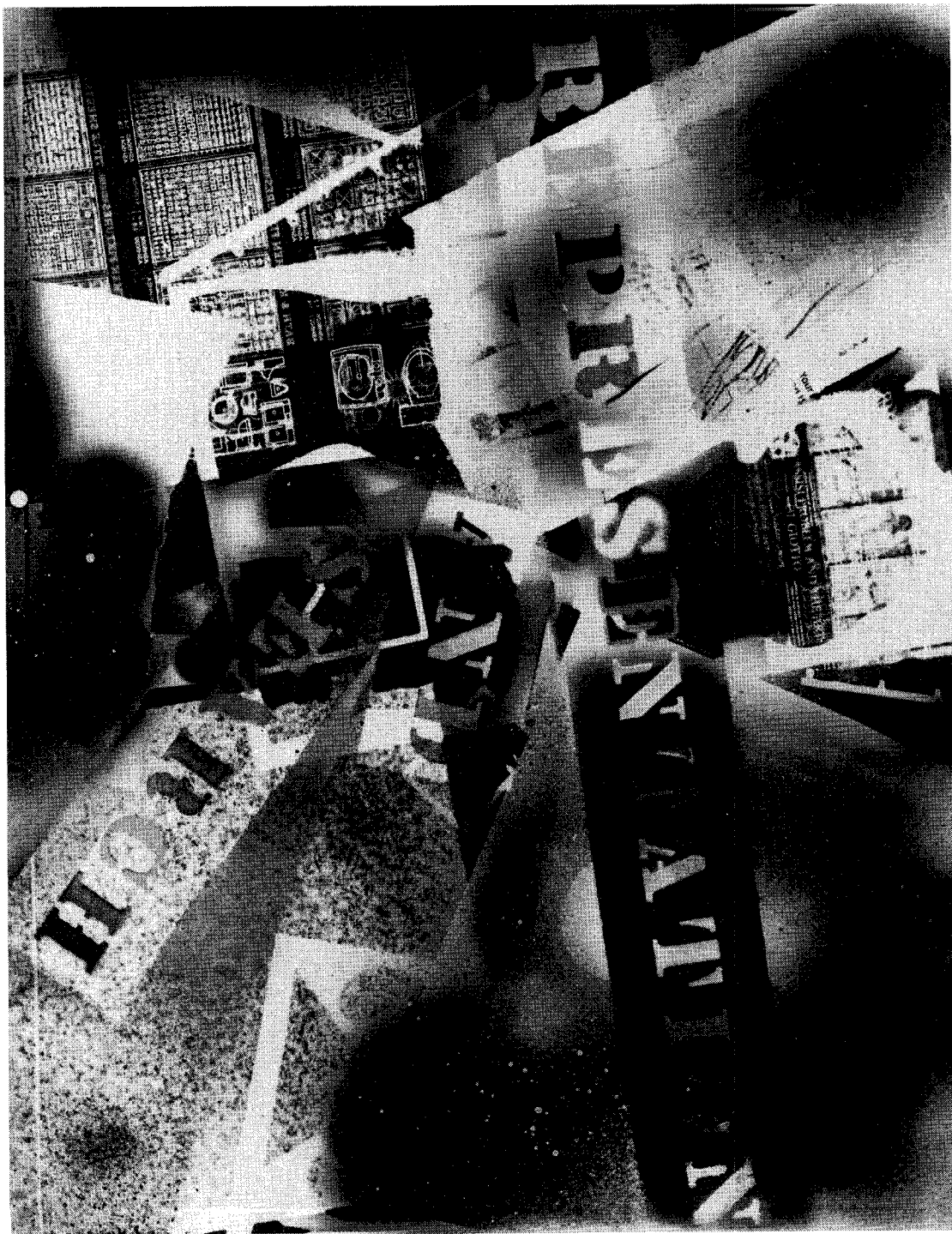

PART II

ARTIFICIAL INTELLIGENCE AS REPRESENTATION AND SEARCH

All sciences characterize the essential nature of the systems they study. These characterizations are invariably qualitative in nature, for they set the terms with which more detailed knowledge can be developed....

The study of logic and computers has revealed to us that intelligence resides in physical symbol systems. This is computer science's most basic law of qualitative structure. Symbol systems are collections of patterns and processes, the latter being capable of producing, destroying and modifying the former. The most important property of patterns is that they can designate objects, processes or other patterns, and that when they designate processes they can be interpreted....

A second law of qualitative structure for artificial intelligence is that symbol systems solve problems by generating potential solutions and testing them— that is by searching. Solutions are usually sought by creating symbolic expressions and modifying them sequentially until they satisfy the conditions for a solution.

—NEWELL AND SIMON, *ACM Turing Award Lecture, 1976 (Newell and Simon 1976)*

In their Turing Award lecture, Newell and Simon argue that intelligent activity, in either human or machine, is achieved through the use of:

1. Symbol patterns to represent significant aspects of a problem domain.
2. Operations on these patterns to generate potential solutions to problems.
3. Search to select a solution from among these possibilities.

These assumptions form the basis for what is known as the *physical symbol system hypothesis* (Section 16.1). This hypothesis justifies our efforts to build intelligent machines and makes explicit the underlying assumptions of artificial intelligence research.

The physical symbol system hypothesis implicitly distinguishes between the *patterns* formed by an arrangement of symbols and the *medium* used to implement them. If intelligence derives only from the structure of a symbol system, then any medium that successfully implements the correct patterns and processes will achieve intelligence, regardless of whether it is composed of neurons, logic circuits, or Tinkertoys. The possibility of building a machine that will pass the Turing test depends on this distinction. According to the Church–Turing thesis (Machtey and Young 1979), computers are capable of implementing any effectively described symbolic process. It follows that a properly programmed digital computer will achieve intelligence.

The physical symbol system hypothesis also outlines the major foci of AI research and application development: defining the symbol structures and operations necessary for intelligent problem solving and developing strategies to efficiently and correctly search the potential solutions generated by these structures and operations. These are the interrelated issues of *knowledge representation and search*; together, they are at the heart of modern research in artificial intelligence.

The physical symbol system hypothesis is disputed by critics who argue that intelligence is inherently biological and existential, and cannot be captured symbolically (Searle 1980; Winograd and Flores 1986). These arguments provide a well-considered challenge to the dominant direction of AI research, and have influenced the direction of research in neural networks, genetic algorithms and agent-based approaches. We examine them in Chapter 16. In spite of these challenges, the assumptions of the physical symbol system hypothesis underlie nearly all practical and theoretical work in expert systems, planning, and natural language understanding.

Knowledge Representation

The function of any representation scheme is to capture the essential features of a problem domain and make that information accessible to a problem-solving procedure. It is obvious that a representation language must allow the programmer to express the knowledge needed for a problem solution. *Abstraction*, the representation of only that information needed for a given purpose, is an essential tool for managing complexity. It is also important that the resulting programs be computationally efficient. *Expressiveness* and *efficiency* are major dimensions for evaluating knowledge representation languages. Many highly expressive representations are too inefficient for use in certain classes of problems. Sometimes, expressiveness must be sacrificed to improve efficiency. This must be done without limiting the representation's ability to capture essential problem-solving knowledge. Optimizing the trade-off between efficiency and expressiveness is a major task for designers of intelligent systems.

Knowledge representation languages are also tools for helping humans solve problems. As such, a representation should provide a *natural* framework for expressing problem-solving knowledge; it should make that knowledge available to the computer and assist the programmer in its organization.

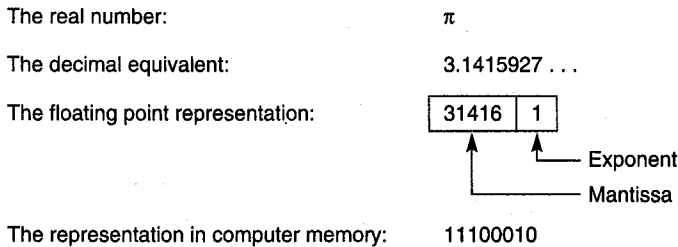

Figure II.1 Different representations of the real number π .

The computer representation of floating-point numbers illustrates these trade-offs (see Fig. II.1). In general, real numbers require an infinite string of digits to be fully described; this cannot be accomplished on a finite device, indeed a finite-state machine. The best answer to this dilemma is to represent the number in two pieces: its *significant* digits and the location within those digits of the decimal point. Although it is not possible to actually store a real number in a computer, it is possible to create a representation that functions adequately in most practical applications.

Floating-point representation thus sacrifices full expressive power to make the representation efficient, in this case to make it possible. The representation allows algorithms for multiple-precision arithmetic, giving effectively infinite precision by limiting round-off error to any prespecified tolerance. It also guarantees well-behaved round-off errors. Like all representations, it is only an abstraction, a symbol pattern that designates a desired entity and not the entity itself.

The array is another representation common in computer science. For many problems, it is more natural and efficient than the memory architecture implemented in computer hardware. This gain in naturalness and efficiency involves compromises in expressiveness, as illustrated by the following example from image processing. Figure II.2 is a digitized image of human chromosomes in a stage called metaphase. The image is processed to determine the number and structure of the chromosomes, looking for breaks, missing pieces, and other abnormalities.

The visual scene is made up of a number of picture points. Each picture point, or *pixel*, has both a location and a number value representing its gray level. It is natural, then, to collect the entire scene into a two-dimensional array where the row and column address gives the location of a pixel (*X* and *Y* coordinates) and the content of the array element is the gray level at that point. Algorithms are designed to perform operations like looking for isolated points to remove noise from the image, finding threshold levels for discerning objects and edges, summing contiguous elements to determine size or density, and in various other ways transforming the picture point data. Implementing these algorithms is straightforward, given the array representation and the FORTRAN language, for example. This task would be quite cumbersome using other representations such as the predicate calculus, records, or assembly code, because these do not have a natural fit with the material being represented.

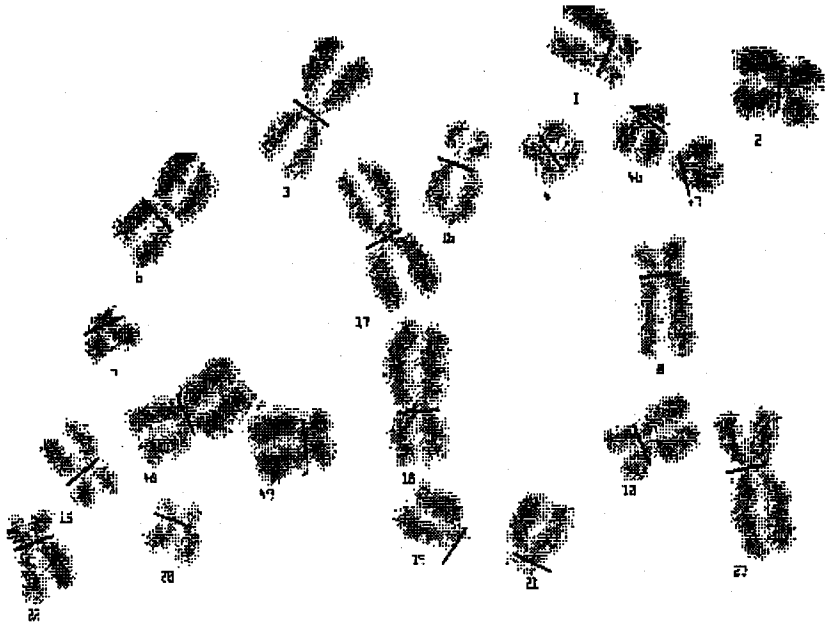

Figure II.2 Digitized image of chromosomes in metaphase.

When we represent the picture as an array of pixel points, we sacrifice fineness of resolution (compare a photo in a newspaper to the original print of the same picture). In addition, pixel arrays cannot express the deeper semantic organization of the image. For example, a pixel array cannot represent the organization of chromosomes in a single cell nucleus, their genetic function, or the role of metaphase in cell division. This knowledge is more easily captured using a representation such as predicate calculus (Chapter 2) or semantic networks (Chapter 8).

A representational scheme should:

1. Be adequate to express all of the necessary information.
2. Support efficient execution of the resulting code.
3. Provide a natural scheme for expressing the required knowledge.

McDermott and others have stated that the key to writing a successful knowledge-based program is the selection of appropriate representational tools. Often, lower-level language (BASIC, FORTRAN, C, etc.) programmers fail in building expert systems simply because these languages do not provide the representational power and modularity required for knowledge-based programming (McDermott 1981).

In general, the problems AI attempts to solve do not lend themselves to the representations offered by more traditional formalisms such as arrays. Artificial intelligence is concerned with qualitative rather than quantitative problem solving, with reasoning rather than calculation, with organizing large and varied amounts of knowledge rather than implementing a single, well-defined algorithm. To support these needs, an AI representation language must:

- A. Handle qualitative knowledge.
- B. Allow new knowledge to be inferred from a set of facts and rules.
- C. Allow representation of general principles as well as specific situations.
- D. Capture complex semantic meaning.
- E. Allow for meta-level reasoning.

These topics make up the remainder of our discussion of knowledge representation.

A. Handle qualitative knowledge.

Artificial intelligence programming requires a means of capturing and reasoning about the *qualitative* aspects of a problem. As a simple example, consider Figure II.3, the arrangement of blocks on a table:

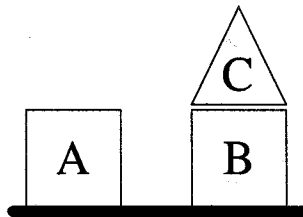

Figure II.3 A blocks world.

One way to represent this blocks arrangement would be to use a Cartesian coordinate system, giving the X and Y coordinates of each vertex of a block. Although this approach certainly describes the blocks world and is the correct representation for many tasks, it fails to capture directly the properties and relations required for qualitative reasoning. These include determining which blocks are stacked on other blocks and which blocks have clear tops so that they can be picked up. *Predicate calculus*, a subset of formal logic, directly captures this descriptive information. Using predicate calculus, the blocks world could be described by the logical assertions:

clear(c).
clear(a).
ontable(a).
ontable(b).
on(c, b).
cube(b).
cube(a).
pyramid(c).

The first word of each expression (on, ontable, etc.) is a *predicate* denoting some property or relationship among its arguments (appearing within parentheses). The arguments are symbols denoting objects (blocks) in the domain. The collection of logical clauses describes the important properties and relationships of the blocks world. Predicate calculus provides artificial intelligence programmers with a well-defined language for describing and reasoning about qualitative aspects of a system. Although it is not the only approach to representation, it is probably the best understood. In addition, it is sufficiently general to provide a foundation for other formal models of knowledge representation. Predicate calculus is discussed in detail in Chapter 2.

The above example illustrates an explicit representation of the blocks of figure II.3. It is explicit in that there is an easily recognized relationship between elements of the representation and our own understanding of the blocks. We may also represent knowledge implicitly. For example, a neural network (Chapter 14) would represent this blocks configuration in the patterns of interaction between artificial neurons. The relationship between these patterns and the elements of the blocks world would not be apparent on inspection of the network; in many cases, the only way we could understand the knowledge content of the network would be to run it on examples. Nonetheless, we ask many of the same questions about implicit representations as their explicit counterparts: Is a given neural network capable of representing all the knowledge that is relevant to our problem? Can the computer access and manipulate that knowledge efficiently? Can we establish the validity of inferences made by the neural network?

B. Allow new knowledge to be inferred from a set of facts and rules.

The ability to infer additional knowledge from a world description is essential to any intelligent entity. Humans, for example, do not store an inflexible description of every situation encountered; this would be impossible. Rather, we are able to formulate and reason from abstract descriptions of classes of objects and situations. A knowledge representation language must provide this capability.

In the blocks world example, we might like to define a test to determine whether a block is *clear*, that is, has nothing stacked on top of it. This is important if a robot hand is to pick it up or stack another block on top of it. It is not necessary to explicitly add this to our description for all such blocks. Instead, we define a general rule that allows the system to infer this information from the given facts. In predicate calculus, the rule can be written

$$\forall X \neg \exists Y \text{on}(Y,X) \Rightarrow \text{clear}(X)$$

or, "for all X, X is clear if there does not exist a Y such that Y is on X." This rule can be applied to a variety of situations by substituting different values for X and Y. By letting the programmer form general rules of inference, predicate calculus allows much greater economy of representation, as well as the possibility of designing systems that are flexible and general enough to respond intelligently to a range of situations.

Neural networks also infer knowledge from given facts, although the rules they use are implicit. Classification is a common form of inference performed by such systems. For example, we may train a neural network to recognize all block configurations that have the pyramid sitting on top of a cube-shaped block.

C. Allow representation of general principles as well as specific situations.

In addition to demonstrating the use of logical rules to infer additional knowledge from basic facts, the blocks example introduced the use of variables in the predicate calculus. Because an intelligent system must be as general as possible, any useful representation language needs variables. The requirements of qualitative reasoning make the use and implementation of variables subtly different from their treatment in traditional programming languages. The assignment, type, and scope rules we find in calculation-oriented languages are too restrictive for reasoning systems. Good knowledge representation languages handle the bindings of variable names, objects, and values in a highly dynamic fashion (Chapters 2, 9, and 10). The ability to generalize well is a key property of neural networks, learning systems and other adaptive systems. Effective learning requires that the agent generalize from training data in order to correctly apply learned knowledge to novel situations.

D. Capture complex semantic meaning.

Many artificial intelligence problem domains require large amounts of highly structured interrelated knowledge. It is not sufficient to describe a car by listing its component parts; a valid description must also describe the ways in which those parts are combined and the interactions between them. This view of structure is essential to a range of situations including taxonomic information, such as the classification of plants by genus and species, or a description of complex objects such as a diesel engine or a human body in terms of their component parts. In our blocks example, the interactions among predicates were the basis of a complete description of the arrangement.

Semantic relationships are also important in describing the causal relationships between events occurring over time. These are necessary to understand simple narratives such as a child's story or to represent a robot's plan of action as a sequence of atomic actions that must be executed in order.

Though all of these situations can ultimately be represented as collections of predicates or similar formalisms, some higher-level notion of structure is desirable to help both program and programmer deal with complex concepts in a coherent fashion. For example, a simple description of a bluebird might be "a bluebird is a small blue-colored

bird and a bird is a feathered flying vertebrate.” This may be represented as a set of logical predicates:

```
hassize(bluebird,small).
hascovering(bird,feathers).
hascolor(bluebird,blue).
hasproperty(bird,flies).
isa(bluebird,bird).
isa(bird,vertebrate).
```

This description could also be represented graphically by using the *arcs* (or *links*) in a graph instead of predicates to indicate relations (Fig. II.4). This description, called a *semantic network*, is a fundamental technique for representing semantic meaning.

Because relationships are explicitly denoted by the links of the graph, an algorithm for reasoning about the domain could make relevant associations simply by following links. In the bluebird illustration, a system need only follow two links in order to determine that a bluebird is a vertebrate. This is more efficient than exhaustively searching a database of predicate calculus descriptions of the form $isa(X,Y)$.

In addition, knowledge may be organized to reflect the natural class-instance structure of the domain. Certain links in a semantic network (the *ISA* links in Fig. II.4) indicate class membership and allow properties attached to a class description to be *inherited* by all members of the class. This inheritance mechanism is built into the language itself and allows knowledge to be stored at the highest possible level of abstraction. Inheritance is a natural tool for representing taxonomically structured information and ensures that all members of a class share common properties. Because of these gains in efficiency and naturalness of expression and because they make the power of graph theory available for reasoning about the structural organization of a knowledge base, semantic nets are an important alternative to predicate calculus. Semantic networks are discussed in detail in Chapter 8.

Because they represent knowledge through the interaction of many small elements, neural networks and agent-based approaches excel at representing complex semantics.

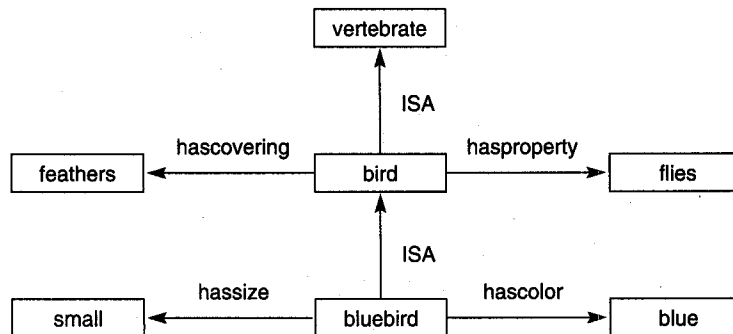

Figure II.4 Semantic network description of a bluebird.

Indeed, such representations, when used with appropriate learning algorithms, often discover relationships unanticipated by their human designers.

E. Allow for meta-level reasoning.

An intelligent system not only should know things but also should know what it knows. It should be able not only to solve problems but also to explain how it solved the problems and why it made certain decisions. It should be able to describe its knowledge in both specific and general terms, recognize the limitations of its knowledge, and learn from its interactions with the world. This “knowing about what you know” constitutes a higher level of knowledge called *meta-knowledge*, and its automation is essential to the design and development of truly intelligent systems.

The problem of formalizing meta-knowledge was first explored by Bertrand Russell in his theory of logical types. Briefly, if sets are allowed to be members of other sets (a situation analogous to having knowledge about knowledge), it is possible to have sets that are members of themselves. As Russell discovered, this leads to irresolvable paradoxes. Russell disallowed these paradoxes by classifying sets as being of different types depending on whether they were sets of individuals, sets of sets of individuals, etc. Sets could not be members of sets of a smaller or equal type number. This corresponds to the distinctions between knowledge and meta-knowledge. As Russell discovered, numerous difficulties arise in attempting to formally describe this reasoning (Whitehead and Russell 1950).

The ability to learn from examples, experience, or high-level instructions (as opposed to being programmed) depends on the application of meta-knowledge. The representational techniques developed for AI programming offer the flexibility and modifiability required of learning systems and form a basis for this research (Chapters 13, 14, and 15).

To meet the needs of symbolic computing, artificial intelligence has developed representation languages such as the predicate calculus, semantic networks, frames, and objects (Chapters 2 and 8). LISP and PROLOG are languages for implementing these and other representations. All of these tools are examined in detail throughout the text.

As our discussion of the properties needed for a knowledge representation language suggests, a given problem may lend itself to many alternative representations. Selecting the appropriate representation is an essential task for designers of artificially intelligent computer programs. In spite of the great variety of representation languages used in AI, all languages must meet similar tests of expressiveness, efficiency, and inferential soundness. The selection and evaluation of representation languages is a central concern of researchers and application developers alike.

Problem Solving as Search

The second aspect of Newell and Simon’s symbol system hypothesis, that problems are solved by searching among alternative choices, is supported by a commonsense view of human problem solving. Humans generally consider a number of alternative strategies on

their way to solving a problem. A chess player typically considers a number of alternative moves, selecting the best according to such criteria as the opponent's possible responses or the degree to which various moves support some global game strategy. A player also considers short-term gain (such as taking the opponent's queen), opportunities to sacrifice a piece for positional advantage, or conjectures concerning the opponent's psychological makeup and level of skill. A mathematician will choose from a different but equally complex set of strategies to find a proof for a difficult theorem, a physician may systematically evaluate a number of possible diagnoses, and so on. This aspect of intelligent behavior underlies the problem-solving technique of state space search.

Consider, as a simple example, the game of tic-tac-toe. Given any board situation, there is only a finite number of moves that a player can make. Starting with an empty board, the first player may place an X in any one of nine places. Each of these moves yields a different board that will allow the opponent eight possible responses, and so on. We can represent this collection of possible moves and responses by regarding each board configuration as a *node* in a graph. The *links* of the graph represent legal moves from one board configuration to another. These nodes thus correspond to different *states* of the game board. The resulting structure is called a *state space graph*.

If we begin with an empty board (indicating the start of a game) and construct a graph through the process of drawing links from the board to all board states that may be reached through a legal move, we will construct the state space graph for the game of tic-tac-toe (Fig. II.5). The significance of this construction is that by starting at the node representing a new board and moving along arcs until we get to a state representing either a win or a tie, it is possible to trace the sequence of moves in any potential game. The state space representation thus enables us to treat all possible games of tic-tac-toe as different paths through this state space graph. Given this representation, an effective game strategy will search through the graph for the paths that lead to the most wins and fewest losses and play in a way that always tries to force the game along one of these optimal paths. Not only is this strategy an effective one but also, because of the regularity and precision of the state space representation, it is straightforward to implement on a computer.

As an example of how search is used to solve a more complicated problem, consider the task of diagnosing a mechanical fault in an automobile. Although this problem does not initially seem to lend itself to state space search as easily as tic-tac-toe or chess, it actually fits this strategy quite well. Instead of letting each node of the state space graph represent a "board state," we let it represent a state of partial knowledge about the automobile's mechanical problems. The process of examining the symptoms of the fault and inducing its cause may be thought of as searching through states of increasing knowledge. The starting node of the graph is empty, indicating that nothing is known about the cause of the problem. The first thing a mechanic might do is ask the customer which major system (engine, transmission, steering, brakes, etc.) seems to be causing the trouble. This is represented by a collection of arcs from the start state to states that indicate a focus on a single subsystem of the automobile (Fig. II.6).

Each of the states in the graph has arcs (corresponding to basic diagnostic checks) that lead to states representing further accumulation of knowledge in the diagnostic process. For example, the engine trouble node has arcs to nodes labeled engine starts and engine won't start. From the won't start node we may move to nodes labeled turns over

and won't turn over. The won't turn over node has arcs to nodes labeled battery dead and battery ok (Fig. II.7).

We can construct a graph that includes all possible diagnostic checks and leads to a set of nodes that represent final diagnostic conclusions. A problem solver can diagnose car trouble by searching for a path through this graph that is consistent with the symptoms of a particular defective car. Note that the diagnostic checks performed in a given instance are determined by the path through the graph, with each decision eliminating certain tests from consideration. Although this problem is very different from that of finding an optimal way to play tic-tac-toe, it is equally amenable to solution by state space search.

Although it is easy to lose sight of it, neural networks and other adaptive systems also perform search, particularly during learning and adaptation. We can think of all possible generalizations from data a learning program can form as constituting a space. The task of a learning algorithm is to use training data to guide a search through this space. In a neural network, for example, the space to be searched is the space of all sets of possible weights on network connections; search modifies these weights based on

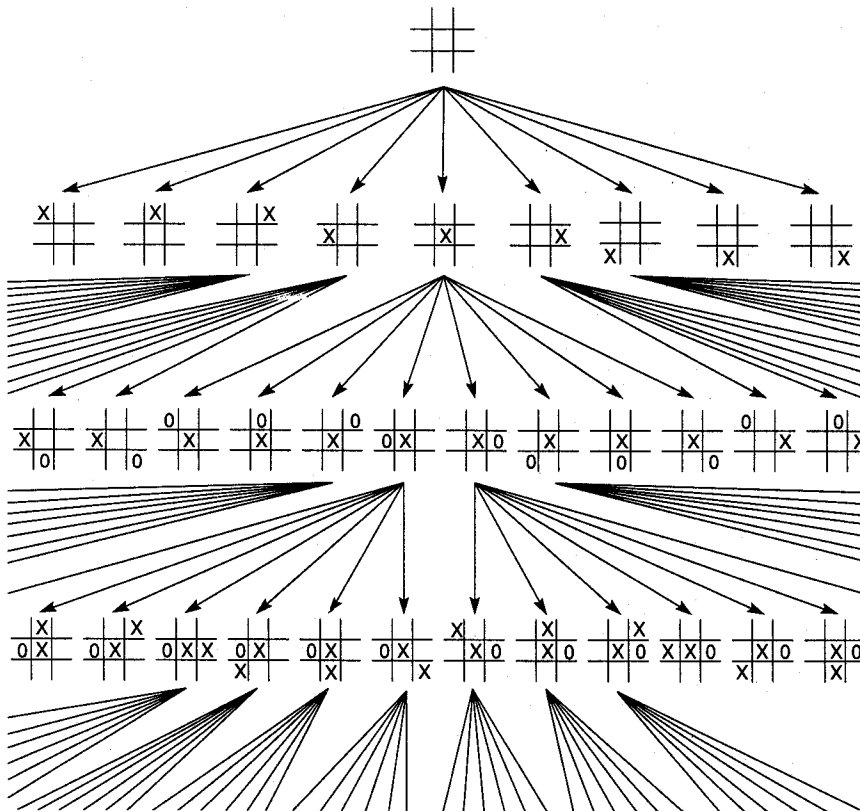

Figure II.5 Portion of the state space for tic-tac-toe.

experience in an effort to find the set of connection weightings that best fit the training data.

In spite of this apparent universality, state space search is not, by itself, sufficient for automating intelligent problem-solving behavior; if it were, intelligent machines would already be a reality. It would be fairly simple, for example, to write a program that plays chess by searching through the entire state space for the sequence of moves most likely to bring a victory. This problem-solving method is known as *exhaustive search*. Though exhaustive search can be applied to any state space, the overwhelming size of the state space for interesting problems makes this approach a practical impossibility. The game of chess, for example, has approximately 10^{120} different board states. This is a number larger than the number of molecules in the universe or the number of nanoseconds that have passed since the "big bang." Search of a space that large is well beyond the capabilities of any computing device, whose dimensions must be confined to the known universe and whose execution must be completed before that universe succumbs to the ravages of entropy.

Throughout the text we show how state space search may be used to approach practically any problem. Search provides a framework for automating problem solving, but it is a framework devoid of intelligence. It enables us to give a problem a formal description that can be implemented in a computer program, but simple exhaustive search of a large space is generally impractical and intuitively fails to capture the substance of intelligent activity.

Humans use search: a chess player considers a number of possible moves, a doctor examines several possible diagnoses, a computer scientist entertains different designs before beginning to write code. Human beings do not use exhaustive search: the chess player examines only moves that experience has shown to be effective, the doctor does not require tests that are not somehow indicated by the symptoms at hand, software design is guided by experience and theoretical sophistication. Human problem solving seems to be based on judgmental rules that guide our search to those portions of the state space that seem somehow "promising."

These rules are known as *heuristics*, and they constitute one of the central topics of AI research. A heuristic (the name is taken from the Greek word "to discover") is a strategy for selectively searching a problem space. It guides our search along lines that have a high probability of success while avoiding wasted or apparently stupid efforts. Human beings use a large number of heuristics in problem solving. If you ask a mechanic why your car is overheating, she may say something like, "Usually that means the thermostat is bad." If you ask a doctor what could cause nausea and stomach pains, he might say it is "probably either stomach flu or food poisoning."

Heuristics are not foolproof: even the best game strategy can be defeated, diagnostic tools developed by expert physicians sometimes fail, experienced mathematicians sometimes fail to prove a difficult theorem. Although it does not always guarantee an optimal solution to a problem, a good heuristic can and should come close most of the time. Most important, it employs knowledge about the nature of a problem to find a solution efficiently.

If state space search gives us a means of formalizing the problem-solving process, then heuristics allow us to infuse that formalism with intelligence. These techniques are

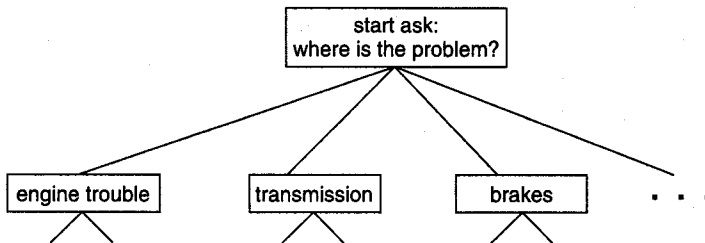

Figure II.6 State space description of the first step in diagnosing an automotive problem.

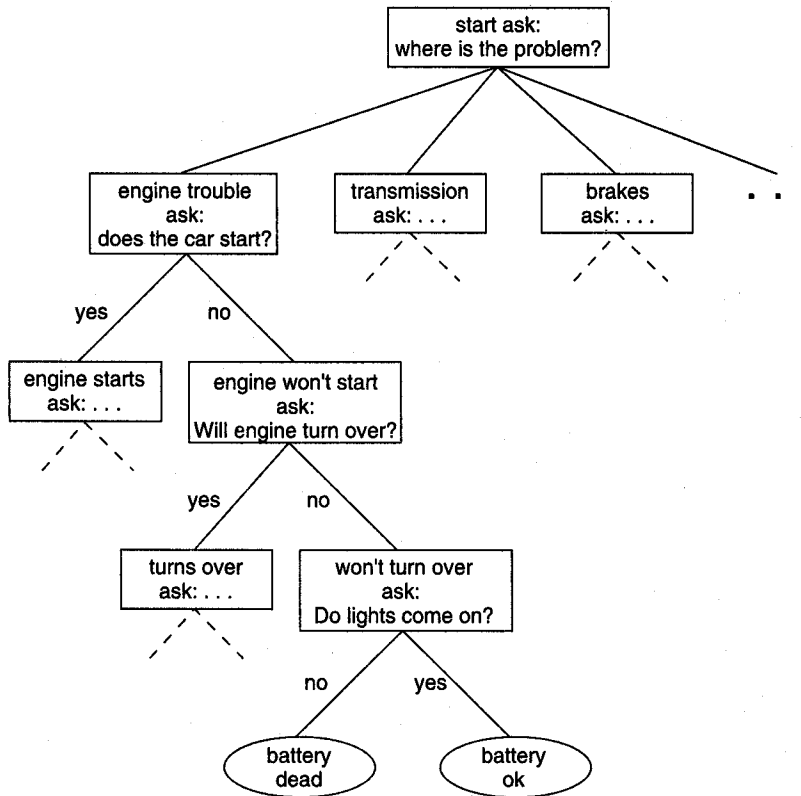

Figure II.7 State space description of the automotive diagnosis problem.

discussed in detail in the early chapters of this text and remain at the heart of most modern work in AI, including expert systems, natural language understanding, theorem provers and learning.

Throughout the text we explore the theoretical aspects of knowledge representation and search and the use of this theory in building effective programs. The treatment of

knowledge representation begins with the predicate calculus (Chapter 2). Although the predicate calculus is only one of the schemes used in knowledge representation, it has the advantage of a well-defined semantics and provably correct *inference rules*. Using logic, we introduce the issues of knowledge representation and its relationship to search. Once the reader has gained experience in these issues, we demonstrate limitations of the predicate calculus and introduce alternative representation schemes (Chapters 6, 7, and 8).

Chapter 3 introduces search in the context of simple games. By beginning with games, we can study the issues involved in state space search without the problems involved in representing real-world problems. This methodology is then applied to the more complex state spaces defined by logic problem solvers and expert systems (Chapters 4, 5, 6, and 12).

In Chapter 4, we discuss the implementation of search algorithms, with particular attention to the use of heuristics to guide search. Chapter 5 looks at production systems, a general and powerful model of search-based problem solving. Chapter 5 also presents problem solving with triangle tables and the blackboard architecture.

THE PREDICATE CALCULUS

2

We come to the full possession of our power of drawing inferences, the last of our faculties; for it is not so much a natural gift as a long and difficult art.

—C. S. PIERCE

The essential quality of a proof is to compel belief.

—FERMAT

2.0 Introduction

In this chapter we introduce the predicate calculus as a representation language for artificial intelligence. The importance of the predicate calculus was discussed in the introduction to Part II; these advantages include a well-defined *formal semantics* and *sound* and *complete* inference rules. This chapter begins with a brief review of the propositional calculus (Section 2.1). Section 2.2 defines the syntax and semantics of the predicate calculus. In Section 2.3 we discuss predicate calculus inference rules and their use in problem solving. Finally, the chapter demonstrates the use of the predicate calculus to implement a knowledge base of financial investment advice.

2.1 The Propositional Calculus

2.1.1 Symbols and Sentences

The propositional calculus and, in the next subsection, the predicate calculus are first of all languages. Using their words, phrases, and sentences, we can represent and reason about properties and relationships in the world. The first step in describing a language is to introduce the pieces that make it up: its set of symbols.

DEFINITION

PROPOSITIONAL CALCULUS SYMBOLS

The *symbols* of propositional calculus are the propositional symbols:

P, Q, R, S, T, ...

truth symbols:

true, false

and connectives:

\wedge , \vee , \neg , \Rightarrow , $=$

Propositional symbols denote *propositions*, or statements about the world that may be either true or false, such as "the car is red" or "water is wet." Propositions are denoted by uppercase letters near the end of the English alphabet. Sentences in the propositional calculus are formed from these atomic symbols according to the following rules:

DEFINITION

PROPOSITIONAL CALCULUS SENTENCES

Every propositional symbol and truth symbol is a sentence.

For example: true, P, Q, and R are sentences.

The *negation* of a sentence is a sentence.

For example: $\neg P$ and \neg false are sentences.

The *conjunction*, or *and*, of two sentences is a sentence.

For example: $P \wedge \neg P$ is a sentence.

The *disjunction*, or *or*, of two sentences is a sentence.

For example: $P \vee \neg P$ is a sentence.

The *implication* of one sentence for another is a sentence.

For example: $P \Rightarrow Q$ is a sentence.

The *equivalence* of two sentences is a sentence.

For example: $P \vee Q = R$ is a sentence.

Legal sentences are also called *well-formed formulas* or *WFFs*.

In expressions of the form $P \wedge Q$, P and Q are called the *conjuncts*. In $P \vee Q$, P and Q are referred to as *disjuncts*. In an implication, $P \Rightarrow Q$, P is the *premise* or *antecedent* and Q, the *conclusion* or *consequent*.

In propositional calculus sentences, the symbols () and [] are used to group symbols into subexpressions and so control their order of evaluation and meaning. For example, $(P \vee Q) = R$ is quite different from $P \vee (Q = R)$, as can be demonstrated using truth tables (Section 2.1.2).

An expression is a sentence, or well-formed formula, of the propositional calculus if and only if it can be formed of legal symbols through some sequence of these rules. For example,

$$((P \wedge Q) \Rightarrow R) = \neg P \vee \neg Q \vee R$$

is a well-formed sentence in the propositional calculus because:

P, Q, and R are propositions and thus sentences.

$P \wedge Q$, the conjunction of two sentences, is a sentence.

$(P \wedge Q) \Rightarrow R$, the implication of a sentence for another, is a sentence.

$\neg P$ and $\neg Q$, the negations of sentences, are sentences.

$\neg P \vee \neg Q$, the disjunction of two sentences, is a sentence.

$\neg P \vee \neg Q \vee R$, the disjunction of two sentences, is a sentence.

$((P \wedge Q) \Rightarrow R) = \neg P \vee \neg Q \vee R$, the equivalence of two sentences, is a sentence.

This is our original sentence, which has been constructed through a series of applications of legal rules and is therefore well formed.

2.1.2 The Semantics of the Propositional Calculus

Section 2.1.1 presented the syntax of the propositional calculus by defining a set of rules for producing legal sentences. In this section we formally define the *semantics* or “meaning” of these sentences. Because AI programs must reason with their representational structures, it is important to demonstrate that the truth of their conclusions depends only on the truth of their initial knowledge, i.e., that logical errors are not introduced by the inference procedures. A precise treatment of semantics is essential to this goal.

A proposition symbol corresponds to a statement about the world. For example, P may denote the statement “it is raining” or Q, the statement “I live in a brown house.” A proposition may be either true or false, given some state of the world. The truth value assignment to propositional sentences is called an *interpretation*, an assertion about their truth in some *possible world*.

Formally, an interpretation is a mapping from the propositional symbols into the set {T, F}. As mentioned in the previous section, the symbols **true** and **false** are part of the set of well-formed sentences of the propositional calculus; i.e., they are distinct from the truth value assigned to a sentence. To enforce this distinction, the symbols **T** and **F** are used for truth value assignment.

Each possible mapping of truth value onto propositions corresponds to a possible world of interpretation. For example, if P denotes the proposition "it is raining" and Q denotes "I am at work," then the set of propositions $\{P, Q\}$ has four different functional mappings into the truth values $\{T, F\}$. These mappings correspond to four different interpretations. The semantics of propositional calculus, like its syntax, is defined inductively:

DEFINITION

PROPOSITIONAL CALCULUS SEMANTICS

An *interpretation* of a set of propositions is the assignment of a truth value, either T or F , to each propositional symbol.

The symbol *true* is always assigned T , and the symbol *false* is assigned F .

The interpretation or truth value for sentences is determined by:

The truth assignment of *negation*, $\neg P$, where P is any propositional symbol, is F if the assignment to P is T , and T if the assignment to P is F .

The truth assignment of *conjunction*, \wedge , is T only when both conjuncts have truth value T ; otherwise it is F .

The truth assignment of *disjunction*, \vee , is F only when both disjuncts have truth value F ; otherwise it is T .

The truth assignment of *implication*, \Rightarrow , is F only when the premise or symbol before the implication is T and the truth value of the consequent or symbol after the implication is F ; otherwise it is T .

The truth assignment of *equivalence*, $=$, is T only when both expressions have the same truth assignment for all possible interpretations; otherwise it is F .

The truth assignments of compound propositions are often described by *truth tables*. A truth table lists all possible truth value assignments to the atomic propositions of an expression and gives the truth value of the expression for each assignment. Thus, a truth table enumerates all possible worlds of interpretation that may be given to an expression. For example, the truth table for $P \wedge Q$, Figure 2.1, lists truth values for each possible truth assignment of the operands. $P \wedge Q$ is true only when both P and Q are both T . Or (\vee), not (\neg), implies (\Rightarrow), and equivalence ($=$) are defined in a similar fashion. The construction of these truth tables is left as an exercise.

Two expressions in the propositional calculus are equivalent if they have the same value under all truth value assignments. This equivalence may be demonstrated using truth tables. For example, a proof of the equivalence of $P \Rightarrow Q$ and $\neg P \vee Q$ is given by the truth table of Figure 2.2.

By demonstrating that they have identical truth tables, we can prove the following propositional calculus equivalences. For propositional expressions P , Q , and R :

$$\neg(\neg P) = P$$

$$(P \vee Q) = (\neg P \Rightarrow Q)$$

the contrapositive law: $(P \Rightarrow Q) = (\neg Q \Rightarrow \neg P)$

de Morgan's law: $\neg(P \vee Q) = (\neg P \wedge \neg Q)$ and $\neg(P \wedge Q) = (\neg P \vee \neg Q)$

the commutative laws: $(P \wedge Q) = (Q \wedge P)$ and $(P \vee Q) = (Q \vee P)$

associative law: $((P \wedge Q) \wedge R) = (P \wedge (Q \wedge R))$

associative law: $((P \vee Q) \vee R) = (P \vee (Q \vee R))$

distributive law: $P \vee (Q \wedge R) = (P \vee Q) \wedge (P \vee R)$

distributive law: $P \wedge (Q \vee R) = (P \wedge Q) \vee (P \wedge R)$

Identities such as these can be used to change propositional calculus expressions into a syntactically different but logically equivalent form. These identities may be used instead of truth tables to prove that two expressions are equivalent: find a series of identities that transform one expression into the other. An early AI program, the Logic Theorist (Newell and Simon 1956), designed by Newell, Simon, and Shaw, used transformations between equivalent forms of expressions to prove many of the theorems in Russell and Whitehead's *Principia Mathematica*. The ability to change a logical expression into a different form with equivalent truth values is also important when using inference rules (modus ponens, Section 2.3, and resolution, Chapter 12) that require expressions to be in a specific form.

P	Q	$P \wedge Q$
T	T	T
T	F	F
F	T	F
F	F	F

Figure 2.1 Truth table for the operator \wedge .

P	Q	$\neg P$	$\neg P \vee Q$	$P \Rightarrow Q$	$(\neg P \vee Q) = (P \Rightarrow Q)$
T	T	F	T	T	T
T	F	F	F	F	T
F	T	T	T	T	T
F	F	T	T	T	T

Figure 2.2 Truth table demonstrating the equivalence of $P \Rightarrow Q$ and $\neg P \vee Q$.

2.2 The Predicate Calculus

In propositional calculus, each atomic symbol (P , Q , etc.) denotes a proposition of some complexity. There is no way to access the components of an individual assertion. Predicate calculus provides this ability. For example, instead of letting a single propositional symbol, P , denote the entire sentence "it rained on Tuesday," we can create a predicate **weather** that describes a relationship between a date and the weather: **weather(tuesday, rain)**. Through inference rules we can manipulate predicate calculus expressions, accessing their individual components and inferring new sentences.

Predicate calculus also allows expressions to contain variables. Variables let us create general assertions about classes of entities. For example, we could state that for all values of X , where X is a day of the week, the statement **weather(X , rain)** is true; i.e., it rains every day. As with propositional calculus, we will first define the syntax of the language and then discuss its semantics.

2.2.1 The Syntax of Predicates and Sentences

Before defining the syntax of correct expressions in the predicate calculus, we define an alphabet and grammar for creating the *symbols* of the language. This corresponds to the lexical aspect of a programming language definition. Predicate calculus symbols, like the *tokens* in a programming language, are irreducible syntactic elements: they cannot be broken into their component parts by the operations of the language.

In this text we represent predicate calculus symbols as strings of letters and digits beginning with a letter. Blanks and nonalphanumeric characters cannot appear within the string, although the underscore, `_`, may be used to improve readability.

DEFINITION

PREDICATE CALCULUS SYMBOLS

The alphabet that makes up the symbols of the predicate calculus consists of:

1. The set of letters, both upper- and lowercase, of the English alphabet.
2. The set of digits, 0, 1, ..., 9.
3. The underscore, `_`.

Symbols in the predicate calculus begin with a letter and are followed by any sequence of these legal characters.

Legitimate characters in the alphabet of predicate calculus symbols include

`a R 6 9 p _ z`

Examples of characters not in the alphabet include

% @ / & “ ”

Legitimate predicate calculus symbols include

George fire3 tom_and_jerry bill XXXX friends_of

Examples of strings that are not legal symbols are

3jack “no blanks allowed” ab%cd ***71 duck!!!

Symbols, as we see in Section 2.2.2, are used to denote objects, properties, or relations in a world of discourse. As with most programming languages, the use of “words” that suggest the symbol’s intended meaning assists us in understanding program code. Thus, even though $l(g,k)$ and $likes(george, kate)$ are formally equivalent (i.e., they have the same structure), the second can be of great help (for human readers) in indicating what relationship the expression represents. It must be stressed that these descriptive names are intended solely to improve the readability of expressions. The only meaning that predicate calculus expressions may be said to have is through their formal semantics.

Parentheses “()”, commas “;”, and periods “.” are used solely to construct well-formed expressions and do not denote objects or relations in the world. These are called *improper symbols*.

Predicate calculus symbols may represent either *variables*, *constants*, *functions*, or *predicates*. Constants name specific objects or properties in the world. Constant symbols must begin with a lowercase letter. Thus **george**, **tree**, **tall**, and **blue** are examples of well-formed constant symbols. The constants **true** and **false** are reserved as *truth symbols*.

Variable symbols are used to designate general classes of objects or properties in the world. Variables are represented by symbols beginning with an uppercase letter. Thus **George**, **BILL**, and **KATE** are legal variables, whereas **geORGE** and **bill** are not.

Predicate calculus also allows functions on objects in the world of discourse. Function symbols (like constants) begin with a lowercase letter. Functions denote a mapping of one or more elements in a set (called the *domain* of the function) into a unique element of another set (the *range* of the function). Elements of the domain and range are objects in the world of discourse. In addition to common arithmetic functions such as addition and multiplication, functions may define mappings between nonnumeric domains.

Note that our definition of predicate calculus symbols does not include numbers or arithmetic operators. The number system is not included in the predicate calculus primitives; instead it is defined axiomatically using “pure” predicate calculus as a basis (Manna and Waldinger1985). While the particulars of this derivation are of theoretical interest, they are less important to the use of predicate calculus as an AI representation language. For convenience, we assume this derivation and include arithmetic in the language.

Every function symbol has an associated *arity*, indicating the number of elements in the domain mapped onto each element of the range. Thus **father** could denote a function of arity 1 that maps people onto their (unique) male parent. **plus** could be a function of arity 2 that maps two numbers onto their arithmetic sum.

A *function expression* is a function symbol followed by its arguments. The arguments are elements from the domain of the function; the number of arguments is equal to the

arity of the function. The arguments are enclosed in parentheses and separated by commas. For example,

f(X,Y)
father(david)
price(bananas)

are all well-formed function expressions.

Each function expression denotes the mapping of the arguments onto a single object in the range, called the *value* of the function. For example, if **father** is a unary function, then

father(david)

is a function expression whose value (in the authors' world of discourse) is **george**. If **plus** is a function of arity 2, with domain the integers, then

plus(2,3)

is a function expression whose value is the integer 5. The act of replacing a function with its value is called *evaluation*.

The concept of a predicate calculus symbol or term is formalized in the following definition:

DEFINITION

SYMBOLS AND TERMS

Predicate calculus symbols include:

1. *Truth symbols* **true** and **false** (these are reserved symbols).
2. *Constant symbols* are symbol expressions having the first character lowercase.
3. *Variable symbols* are symbol expressions beginning with an uppercase character.
4. *Function symbols* are symbol expressions having the first character lowercase. Functions have an attached arity indicating the number of elements of the domain mapped onto each element of the range.

A *function expression* consists of a function constant of arity n , followed by n terms, t_1, t_2, \dots, t_n , enclosed in parentheses and separated by commas.

A *term* is either a constant, variable, or function expression.

Thus a predicate calculus *term* is either a constant, variable, or function expression. Terms denote objects and properties in a problem domain. Examples of terms are:

cat
times(2,3)
X
blue
mother(jane)
kate

Symbols in predicate calculus may also represent predicates. Predicate symbols, like constants and function names, begin with a lowercase letter. A predicate names a relationship between zero or more objects in the world. The number of objects so related is the arity of the predicate. Examples of predicates are

likes equals on near part_of

An *atomic sentence* in predicate calculus is a predicate of arity n followed by n terms enclosed in parentheses and separated by commas. Predicate calculus sentences are delimited by a period. Examples of atomic sentences are

likes(george,kate).	likes(X,george).
likes(george,susie).	likes(X,X).
likes(george,sarah,tuesday).	friends(bill,richard).
friends(bill,george).	friends(father(david),father(andrew)).
helps(bill,george).	helps(richard,bill).

The predicate symbols in these expressions are **likes**, **friends**, and **helps**. Note that a predicate symbol may be used with different numbers of arguments. In this example there are two different **likes**, one with two and the other with three arguments. When a predicate symbol is used in sentences with different arities, it is considered to represent two different relations. Thus, a predicate relation is defined by its name and its arity. There is no reason that the two different **likes** cannot make up part of the same description of the world; however, good coding practice encourages us to avoid this whenever possible.

In the predicates above, **bill**, **george**, **kate**, etc., are constant symbols and represent objects in the problem domain. The arguments to a predicate are terms and may also include variables or function expressions. For example,

friends(father(david),father(andrew))

is a predicate describing a relationship between two objects in a domain of discourse. These arguments are represented as function expressions whose mappings (given that the father of **david** is **george** and the father of **andrew** is **allen**) form the parameters of the predicate. After the function expressions are evaluated, the expression becomes

friends(george,allen).

These ideas are formalized in the following definition.

DEFINITION

PREDICATES AND ATOMIC SENTENCES

Predicate symbols are symbols beginning with a lowercase letter.

Predicates have an associated positive integer referred to as the *arity* or “argument number” for the predicate. Predicates with the same name but different arities are considered distinct.

An atomic sentence is a predicate constant of arity n , followed by n terms, t_1, t_2, \dots, t_n , enclosed in parentheses and separated by commas.

The truth values, **true** and **false**, are also atomic sentences.

Atomic sentences are also called *atomic expressions*, *atoms*, or *propositions*.

We may combine atomic sentences using logical operators to form *sentences* in the predicate calculus. These are the same logical connectives used in propositional calculus: \wedge , \vee , \neg , \Rightarrow , and $=$.

When a variable appears as an argument in a sentence, it refers to unspecified objects in the domain. Predicate calculus includes two symbols, the *variable quantifiers* \forall and \exists , that constrain the meaning of a sentence containing a variable. A quantifier is followed by a variable and a sentence, such as,

$\exists Y \text{ friends}(Y, \text{peter}).$
 $\forall X \text{ likes}(X, \text{ice_cream}).$

The *universal quantifier*, \forall , indicates that the sentence is true for all values of the quantified variable. In the example above, $\text{likes}(X, \text{ice_cream})$ is true for all values in the domain of the definition of X . The *existential quantifier*, \exists , indicates that the sentence is true for some value(s) in the domain. $\text{friends}(Y, \text{peter})$ is true for some objects, indicated by the variable Y . Quantifiers are discussed in more detail in Section 2.2.2.

Sentences in the predicate calculus are defined inductively.

DEFINITION

PREDICATE CALCULUS SENTENCES

Every atomic sentence is a sentence.

1. If S is a sentence, then so is its negation, $\neg S$.
2. If S_1 and S_2 are sentences, then so is their conjunction, $S_1 \wedge S_2$.
3. If S_1 and S_2 are sentences, then so is their disjunction, $S_1 \vee S_2$.
4. If S_1 and S_2 are sentences, then so is their implication, $S_1 \Rightarrow S_2$.
5. If S_1 and S_2 are sentences, then so is their equivalence, $S_1 = S_2$.

6. If X is a variable and s a sentence, then $\forall X s$ is a sentence.

7. If X is a variable and s a sentence, then $\exists X s$ is a sentence.

Examples of well-formed predicate calculus sentences follow. Let `times` and `plus` be function symbols of arity 2 and let `equal` and `foo` be predicate symbols with arity 2 and 3, respectively.

`plus(two,three)` is a function and thus not an atomic sentence.

`equal(plus(two,three), five)` is an atomic sentence.

`equal(plus(2, 3), seven)` is an atomic sentence. Note that this sentence, given the standard interpretation of `plus` and `equal`, is false. Well-formedness and truth value are independent issues.

$\exists X \text{foo}(X, \text{two}, \text{plus}(\text{two}, \text{three})) \wedge \text{equal}(\text{plus}(\text{two}, \text{three}), \text{five})$ is a sentence because both conjuncts are sentences.

$(\text{foo}(\text{two}, \text{two}, \text{plus}(\text{two}, \text{three}))) \Rightarrow (\text{equal}(\text{plus}(\text{three}, \text{two}), \text{five}) = \text{true})$ is a sentence because all its components are sentences, appropriately connected by logical operators.

The definition of predicate calculus sentences and the examples just presented suggest a method for verifying that an expression is a sentence. This is written as a recursive algorithm, `verify_sentence`. `verify_sentence` takes as argument a candidate expression and returns success if the expression is a sentence.

```
procedure verify_sentence(expression);
begin
  case
    expression is an atomic sentence: return(success);
    expression is of the form  $Q X s$ , where  $Q$  is either  $\forall$  or  $\exists$ ,  $X$  is a variable,
      and  $s$  is a sentence.
      if verify_sentence(s) returns success
      then return(success);
    expression is of the form  $\neg s$ :
      if verify_sentence(s) returns success
      then return(success);
    expression is of the form  $s_1 \text{ op } s_2$ , where  $\text{op}$  is a binary logical operator:
      if verify_sentence( $s_1$ ) returns success and
        verify_sentence( $s_2$ ) returns success
      then return(success);
    otherwise: return(fail)
  end
end.
```

We conclude this section with an example of the use of predicate calculus to describe a simple world. The domain of discourse is a set of family relationships in a biblical genealogy:

```
mother(eve,abel).
mother(eve,cain).
father(adam,abel).
father(adam,cain).
```

```
" X " Y father(X, Y) / mother(X, Y) fi parent(X, Y).
" X " Y " Z parent(X, Y) Ÿ parent(X, Z) fi sibling(Y, Z).
```

In this example we use the predicates `mother` and `father` to define a set of parent-child relationships. The implications give general definitions of other relationships, such as `parent` and `sibling`, in terms of these predicates. Intuitively, it is clear that these implications can be used to infer facts such as `sibling(cain,abel)`. To formalize this process so that it can be performed on a computer, care must be taken to define inference algorithms and to ensure that such algorithms indeed draw correct conclusions from a set of predicate calculus assertions. In order to do so, we define the semantics of the predicate calculus (Section 2.2.2) and then address the issue of inference rules (Section 2.3).

2.2.2 A Semantics for the Predicate Calculus

Having defined well-formed expressions in the predicate calculus, it is important to determine their meaning in terms of objects, properties, and relations in the world. Predicate calculus semantics provide a formal basis for determining the truth value of well-formed expressions. The truth of expressions depends on the mapping of constants, variables, predicates, and functions into objects and relations in the domain of discourse. The truth of relationships in the domain determines the truth of the corresponding expressions.

For example, information about a person, George, and his friends Kate and Susie may be expressed by

```
friends(george,susie).
friends(george,kate).
```

If it is indeed true that George is a friend of Susie and George is a friend of Kate then these expressions would each have the truth value (assignment) T. If George is a friend of Susie but not of Kate, then the first expression would have truth value T and the second would have truth value F.

To use the predicate calculus as a representation for problem solving, we describe objects and relations in the domain of interpretation with a set of well-formed expressions. The terms and predicates of these expressions denote objects and relations in the domain. This database of predicate calculus expressions, each having truth value T, describes the

“state of the world.” The description of George and his friends is a simple example of such a database. Another example is the *blocks world* in the introduction to Part II.

Based on these intuitions, we formally define the semantics of predicate calculus. First, we define an *interpretation* over a domain D . Then we use this interpretation to determine the *truth value assignment* of sentences in the language.

DEFINITION

INTERPRETATION

Let the domain D be a nonempty set.

An *interpretation* over D is an assignment of the entities of D to each of the constant, variable, predicate, and function symbols of a predicate calculus expression, such that:

1. Each constant is assigned an element of D .
2. Each variable is assigned to a nonempty subset of D ; these are the allowable substitutions for that variable.
3. Each function f of arity m is defined on m arguments of D and defines a mapping from D^m into D .
4. Each predicate p of arity n is defined on n arguments from D and defines a mapping from D^n into $\{T, F\}$.

Given an interpretation, the meaning of an expression is a truth value assignment over the interpretation.

DEFINITION

TRUTH VALUE OF PREDICATE CALCULUS EXPRESSIONS

Assume an expression E and an interpretation I for E over a nonempty domain D . The truth value for E is determined by:

1. The value of a constant is the element of D it is assigned to by I .
2. The value of a variable is the set of elements of D it is assigned to by I .
3. The value of a function expression is that element of D obtained by evaluating the function for the parameter values assigned by the interpretation.
4. The value of truth symbol “true” is T and “false” is F .
5. The value of an atomic sentence is either T or F , as determined by the interpretation I .

6. The value of the negation of a sentence is T if the value of the sentence is F and is F if the value of the sentence is T.
7. The value of the conjunction of two sentences is T if the value of both sentences is T and is F otherwise.
- 8.-10. The truth value of expressions using \vee , \Rightarrow , and $=$ is determined from the value of their operands as defined in Section 2.1.2.

Finally, for a variable X and a sentence S containing X :

11. The value of $\forall X S$ is T if S is T for all assignments to X under I , and it is F otherwise.
12. The value of $\exists X S$ is T if there is an assignment to X in the interpretation under which S is T; otherwise it is F.

Quantification of variables is an important part of predicate calculus semantics. When a variable appears in a sentence, such as X in $\text{likes}(\text{george}, X)$ in the first example of Section 2.2.2, the variable functions as a placeholder. Any constant allowed under the interpretation can be substituted for it in the expression. Substituting for X in $\text{likes}(\text{george}, X)$ forms the statements $\text{likes}(\text{george}, \text{kate})$ and $\text{likes}(\text{george}, \text{susie})$.

The variable X stands for all constants that might appear as the second parameter of the sentence. This variable name might be replaced by any other variable name, such as Y or PEOPLE , without changing the meaning of the expression. In this sense the variable is said to be a *dummy*. In predicate calculus, variables may be used or *quantified* in either of two ways. In the first, the sentence is true for all constants that can be substituted for the variable under the intended interpretation. In this case, the variable is said to be *universally* quantified.

The symbol indicating universal quantification is \forall . Parentheses are often used to indicate the *scope* of quantification, that is, the instances of a variable name over which a quantification holds. Thus

$$\forall X (p(X) \vee q(Y) \Rightarrow r(X)).$$

indicates that X is universally quantified in both $p(X)$ and $r(X)$.

Universal quantification introduces problems in computing the truth value of a sentence, because all the possible values of a variable symbol must be tested to see whether the expression remains true. For example, to test the truth value of $\forall X \text{likes}(\text{george}, X)$, where X ranges over the set of all humans, all possible values for X must be tested. If the domain of an interpretation is infinite, exhaustive testing of all substitutions to a universally quantified variable is computationally impossible: the algorithm may never halt. Because of this problem, the predicate calculus is said to be *undecidable*.

As the propositional calculus does not use variables, sentences have only a finite number of possible truth assignments, and we can exhaustively test all possible assignments. This is what is done in a truth table.

Variables may also be quantified *existentially*. In this case the expression containing the variable is said to be true for at least one substitution from the domain of definition. The existential quantifier is indicated by \exists . The scope of an existentially quantified variable is also indicated by enclosing the quantified occurrences of the variable in parentheses.

Evaluating the truth of an expression containing an existentially quantified variable may be no easier than evaluating the truth of expressions containing universally quantified variables. Suppose we attempt to determine the truth of the expression by trying substitutions until one is found that makes the expression true. If the domain of the variable is infinite and the expression is false under all substitutions, the algorithm will never halt.

Several relationships between negation and the universal and existential quantifiers are given below. These relationships are used in resolution refutation systems described in Chapter 11. The notion of a variable name as a dummy symbol that stands for a set of constants is also noted. For predicates p and q and variables X and Y :

$$\neg \exists X p(X) = \forall X \neg p(X)$$

$$\neg \forall X p(X) = \exists X \neg p(X)$$

$$\exists X p(X) = \exists Y p(Y)$$

$$\forall X q(X) = \forall Y q(Y)$$

$$\forall X (p(X) \wedge q(X)) = \forall X p(X) \wedge \forall Y q(Y)$$

$$\exists X (p(X) \vee q(X)) = \exists X p(X) \vee \exists Y q(Y)$$

In the language we have defined, universally and existentially quantified variables may refer only to objects (constants) in the domain of discourse. Predicate and function names may not be replaced by quantified variables. This language is called the *first-order predicate calculus*.

DEFINITION

FIRST-ORDER PREDICATE CALCULUS

First-order predicate calculus allows quantified variables to refer to objects in the domain of discourse and not to predicates or functions.

For example,

$$\forall (\text{Likes}) \text{Likes}(\text{george}, \text{kate}).$$

is not a well-formed expression in the first-order predicate calculus. There are *higher-order* predicate calculi where such expressions are meaningful. Some researchers

(McCarthy 1968, Appelt 1985) have used higher-order languages to represent knowledge in natural language understanding programs.

Almost any grammatically correct English sentence may be represented in first-order predicate calculus using the symbols, connectives, and variable symbols defined in this section. It is important to note that there is no unique mapping of sentences into predicate calculus expressions; in fact, an English sentence may have any number of different predicate calculus representations. A major challenge for AI programmers is to find a scheme for using these predicates that optimizes the expressiveness and efficiency of the resulting representation. Examples of English sentences represented in predicate calculus are:

If it doesn't rain tomorrow, Tom will go to the mountains.

$\neg \text{weather}(\text{rain}, \text{tomorrow}) \Rightarrow \text{go}(\text{tom}, \text{mountains})$

Emma is a Doberman pinscher and a good dog.

$\text{gooddog}(\text{emma}) \wedge \text{isa}(\text{emma}, \text{doberman})$

All basketball players are tall.

$\forall X (\text{basketball_player}(X) \Rightarrow \text{tall}(X))$

Some people like anchovies.

$\exists X (\text{person}(X) \wedge \text{likes}(X, \text{anchovies}))$.

If wishes were horses, beggars would ride.

$\text{equal}(\text{wishes}, \text{horses}) \Rightarrow \text{ride}(\text{beggars})$.

Nobody likes taxes.

$\neg \exists X \text{likes}(X, \text{taxes})$.

We conclude this section by giving an extended example of a truth value assignment to a set of predicate calculus expressions. Suppose we want to model the blocks world of Figure 2.3 to design a control algorithm for a robot arm. We can use predicate calculus sentences to represent the qualitative relationships in the world: does a given block have a clear top surface? can we pick up block a? etc. Assume that the computer has knowledge of the location of each block and the arm itself and is able to keep track of these locations (using three-dimensional coordinates) as the hand moves blocks about the table.

To pick up a block and stack it on another block, both blocks must be clear. In Figure 2.3, block a is not clear. Because the arm can move blocks, it can change the state of the world and clear a block. Suppose it removes block c from block a and updates the knowledge base to reflect this by deleting the assertion $\text{on}(c, a)$. The program needs to be able to infer that block a has become clear.

The following rule describes when a block is clear:

$\forall X (\neg \exists Y \text{on}(Y, X) \Rightarrow \text{clear}(X))$.

That is, for all X, X is clear if there does not exist a Y such that Y is on X.

This rule not only defines what it means for a block to be clear but also provides a basis for determining how to clear blocks that are not. For example, block d is not clear, because if variable X is given value d, substituting b for Y will make the statement false.

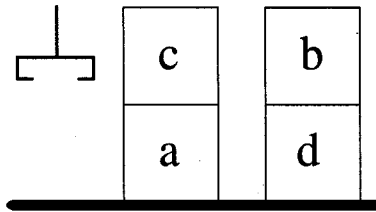

on(c,a).
 on(b,d).
 ontable(a).
 ontable(d).
 clear(b).
 clear(c).
 hand_empty.

Figure 2.3 A blocks world with its predicate calculus description.

Therefore, to make this definition true, block **b** must be removed from block **d**. This is easily done because the computer has a record of all the blocks and their locations.

Besides using implications to define when a block is clear, other rules may be added that describe operations such as stacking one block on top of another. For example: to stack **X** on **Y** first empty the hand, then clear **X**, then clear **Y**, and then `pick_up X` and `put_down X` on **Y**.

$$\forall X \forall Y ((\text{hand_empty} \wedge \text{clear}(X) \wedge \text{clear}(Y) \wedge \text{pick_up}(X) \wedge \text{put_down}(X,Y)) \Rightarrow \text{stack}(X,Y)).$$

Note that in implementing the above description it is necessary to “attach” an action of the robot arm to each predicate such as `pick_up(X)`. It is also necessary for such an implementation to augment the semantics of predicate calculus by requiring that the actions be performed in the order in which they appear in a rule premise. However, much is gained by separating these issues from the use of predicate calculus to define the relationships and operations in the domain.

Figure 2.3 gives a semantic interpretation of these predicate calculus expressions. This interpretation maps the constants and predicates in the set of expressions into a domain **D**, here the blocks and relations between them. The interpretation gives truth value **T** to each expression in the description. Another interpretation could be offered by a different set of blocks in another location, or perhaps by a team of four acrobats. The important question is not the uniqueness of interpretations, but whether the interpretation provides a truth value for all expressions in the set and whether the expressions describe the world in sufficient detail that all necessary inferences may be carried out by manipulating the symbolic expressions. The next section uses these ideas to provide a formal basis for predicate calculus inference rules.

2.3 Using Inference Rules to Produce Predicate Calculus Expressions

2.3.1 Inference Rules

The semantics of predicate calculus provide a basis for a formal theory of *logical inference*. The ability to infer new correct expressions from a set of true assertions is an important feature of the predicate calculus. These new expressions are correct in that they are *consistent* with all previous interpretations of the original set of expressions. First we discuss these ideas informally and then we create a set of definitions to make them precise.

An interpretation that makes a sentence true is said to *satisfy* that sentence. An interpretation that satisfies every member of a set of expressions is said to satisfy the set. An expression X *logically follows* from a set of predicate calculus expressions S if every interpretation that satisfies S also satisfies X . This notion gives us a basis for verifying the correctness of rules of inference: the function of logical inference is to produce new sentences that logically follow a given set of predicate calculus sentences.

It is important that the precise meaning of “logically follow” be understood: the expression X is true for every interpretation that satisfies S (Figure 2.4).

The term itself, “logically follows,” may be a bit confusing. It does not mean that X is deduced from or even that it is deducible from S . It simply means that X is true for every

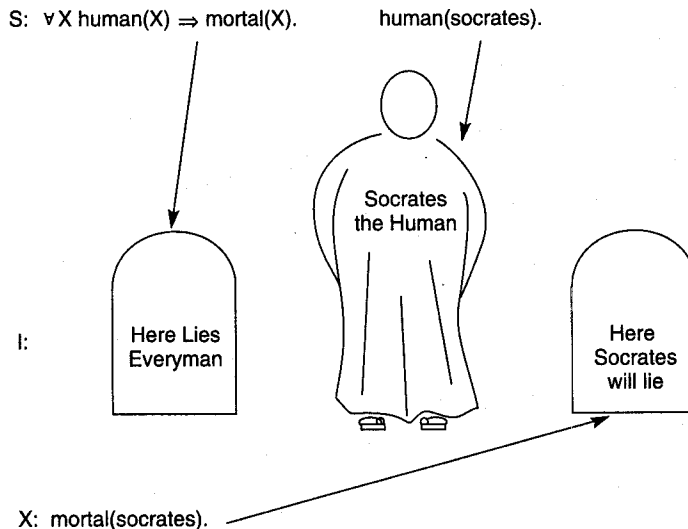

Figure 2.4 S , a set of predicate calculus sentences; I , an interpretation; and X , an expression logically following from S (also satisfied by I).

(potentially infinite) interpretation that satisfies S . However, because systems of predicates can have a potentially infinite number of possible interpretations, it is seldom practical to try all interpretations. Instead, *inference rules* provide a computationally feasible way to determine when an expression logically follows from another. The concept “logically follows” provides a formal basis for proofs of the soundness and correctness of inference rules.

An inference rule is essentially a mechanical means of producing new predicate calculus sentences from other sentences. That is, inference rules produce new sentences based on the syntactic form of given logical assertions. When every sentence X produced by an inference rule operating on a set S of logical expressions logically follows from S , the inference rule is said to be *sound*.

If the inference rule is able to produce every expression that logically follows from S , then it is said to be *complete*. *Modus ponens*, to be introduced below, and *resolution*, introduced in Chapter 11, are examples of inference rules that are sound and, when used with certain appropriate strategies, complete. Logical inference systems generally use sound rules of inference, although later chapters (5, 9, 10, and 14) examine heuristic reasoning and commonsense reasoning, both of which relax this requirement.

We formalize these ideas through the following definitions.

DEFINITION

SATISFY, MODEL, VALID, INCONSISTENT

For a predicate calculus expression S and an interpretation I :

If S has a value of T under I and a particular variable assignment, then I is said to *satisfy* S .

If I satisfies S for all variable assignments, then I is a *model* of S .

S is *satisfiable* if and only if there exist an interpretation and variable assignment that satisfy it; otherwise, it is *unsatisfiable*.

A set of expressions is *satisfiable* if and only if there exist an interpretation and variable assignment that satisfy every element.

If a set of expressions is not satisfiable, it is said to be *inconsistent*.

If S has a value T for all possible interpretations, S is said to be *valid*.

In the blocks world example of Figure 2.3, the blocks world was a model for its logical description. All of the sentences in the example were true under this interpretation. When a knowledge base is implemented as a set of true assertions about a problem domain, that domain is a model for the knowledge base.

The expression $\exists X (p(X) \wedge \neg p(X))$ is inconsistent, because it cannot be satisfied under any interpretation or variable assignment. On the other hand, the expression $\forall X (p(X) \vee \neg p(X))$ is valid.

The truth table method can be used to test validity for any expression not containing variables. Because it is not always possible to decide the validity of expressions containing variables (as mentioned above, the process may not terminate), the full predicate calculus is “undecidable.” There are *proof procedures*, however, that can produce any expression that logically follows from a set of expressions. These are called *complete* proof procedures.

DEFINITION

PROOF PROCEDURE

A *proof procedure* is a combination of an inference rule and an algorithm for applying that rule to a set of logical expressions to generate new sentences.

We present proof procedures for the *resolution* inference rule in Chapter 11.

Using these definitions, we may formally define “logically follows.”

DEFINITION

LOGICALLY FOLLOWS, SOUND, AND COMPLETE

A predicate calculus expression X *logically follows* from a set S of predicate calculus expressions if every interpretation and variable assignment that satisfies S also satisfies X .

An inference rule is *sound* if every predicate calculus expression produced by the rule from a set S of predicate calculus expressions also logically follows from S .

An inference rule is *complete* if, given a set S of predicate calculus expressions, the rule can infer every expression that logically follows from S .

Modus ponens is a sound inference rule. If we are given an expression of the form $P \Rightarrow Q$ and another expression of the form P such that both are true under an interpretation I , then modus ponens allows us to infer that Q is also true for that interpretation. Indeed, because modus ponens is sound, Q is true for *all* interpretations for which P and $P \Rightarrow Q$ are true.

Modus ponens and a number of other useful inference rules are defined below.

DEFINITION

MODUS PONENS, MODUS TOLENS, AND ELIMINATION, AND INTRODUCTION, AND UNIVERSAL INSTANTIATION

If the sentences P and $P \Rightarrow Q$ are known to be true, then *modus ponens* lets us infer Q .

Under the inference rule *modus tollens*, if $P \Rightarrow Q$ is known to be true and Q is known to be false, we can infer $\neg P$.

And elimination allows us to infer the truth of either of the conjuncts from the truth of a conjunctive sentence. For instance, $P \wedge Q$ lets us conclude P and Q are true.

And introduction lets us infer the truth of a conjunction from the truth of its conjuncts. For instance, if P and Q are true, then $P \wedge Q$ is true.

Universal instantiation states that if any universally quantified variable in a true sentence is replaced by any appropriate term from the domain, the result is a true sentence. Thus, if a is from the domain of X , $\forall X p(X)$ lets us infer $p(a)$.

As a simple example of the use of modus ponens in the propositional calculus, assume the following observations: "if it is raining then the ground will be wet" and "it is raining." If P denotes "it is raining" and Q is "the ground is wet" then the first expression becomes $P \Rightarrow Q$. Because it is indeed now raining (P is true), our set of axioms becomes

$$\begin{array}{l} P \Rightarrow Q \\ P \end{array}$$

Through an application of modus ponens, the fact that the ground is wet (Q) may be added to the set of true expressions.

Modus ponens can also be applied to expressions containing variables. Consider as an example the common syllogism "all men are mortal and Socrates is a man; therefore Socrates is mortal." "All men are mortal" may be represented in predicate calculus by

$$\forall X (\text{man}(X) \Rightarrow \text{mortal}(X)).$$

"Socrates is a man" is

$$\text{man}(\text{socrates}).$$

Because the X in the implication is universally quantified, we may substitute any value in the domain for X and still have a true statement under the inference rule of universal instantiation. By substituting **socrates** for X in the implication, we infer the expression

$$\text{man}(\text{socrates}) \Rightarrow \text{mortal}(\text{socrates}).$$

We can now apply modus ponens and infer the conclusion **mortal(socrates)**. This is added to the set of expressions that logically follow from the original assertions. An algorithm called *unification* can be used by an automated problem solver to determine that **socrates** may be substituted for X in order to apply modus ponens. Unification is discussed in Section 2.3.2.

Chapter 11 discusses a more powerful rule of inference called resolution, which is the basis of many automated reasoning systems.

2.3.2 Unification

To apply inference rules such as modus ponens, an inference system must be able to determine when two expressions are the same or *match*. In propositional calculus, this is trivial: two expressions match if and only if they are syntactically identical. In predicate calculus, the process of matching two sentences is complicated by the existence of variables in the expressions. Universal instantiation allows universally quantified variables to be replaced by terms from the domain. This requires a decision process for determining the variable substitutions under which two or more expressions can be made identical (usually for the purpose of applying inference rules).

Unification is an algorithm for determining the substitutions needed to make two predicate calculus expressions match. We have already seen this done in the previous subsection, where *socrates* in $\text{man}(\text{socrates})$ was substituted for X in $\forall X(\text{man}(X) \Rightarrow \text{mortal}(X))$. This allowed the application of modus ponens and the conclusion $\text{mortal}(\text{socrates})$. Another example of unification was seen previously when dummy variables were discussed. Because $p(X)$ and $p(Y)$ are equivalent, Y may be substituted for X to make the sentences match.

Unification and inference rules such as modus ponens allow us to make inferences on a set of logical assertions. To do this, the logical database must be expressed in an appropriate form.

An essential aspect of this form is the requirement that all variables be universally quantified. This allows full freedom in computing substitutions. Existentially quantified variables may be eliminated from sentences in the database by replacing them with the constants that make the sentence true. For example, $\exists X \text{parent}(X, \text{tom})$ could be replaced by the expression $\text{parent}(\text{bob}, \text{tom})$ or $\text{parent}(\text{mary}, \text{tom})$, assuming that *bob* and *mary* are *tom's* parents under the interpretation.

The process of eliminating existentially quantified variables is complicated by the fact that the value of these substitutions may depend on the value of other variables in the expression. For example, in the expression $\forall X \exists Y \text{mother}(X, Y)$, the value of the existentially quantified variable Y depends on the value of X . *Skolemization* replaces each existentially quantified variable with a function that returns the appropriate constant as a function of some or all of the other variables in the sentence. In the above example, because the value of Y depends on X , Y could be replaced by a *skolem function*, f , of X . This yields the predicate $\forall X \text{mother}(X, f(X))$. Skolemization is discussed in more detail in Chapter 12.

Once the existentially quantified variables have been removed from a logical database, unification may be used to match sentences in order to apply inference rules such as modus ponens.

Unification is complicated by the fact that a variable may be replaced by any term, including other variables and function expressions of arbitrary complexity. These expressions may themselves contain variables. For example, $\text{father}(\text{jack})$ may be substituted for X in $\text{man}(X)$ to infer that *jack's* father is mortal.

Some instances of the expression

$\text{foo}(X, a, \text{goo}(Y))$.

generated by legal substitutions are given below:

- 1) $\text{foo}(\text{fred}, \text{a}, \text{goo}(\text{Z}))$
- 2) $\text{foo}(\text{W}, \text{a}, \text{goo}(\text{jack}))$
- 3) $\text{foo}(\text{Z}, \text{a}, \text{goo}(\text{moo}(\text{Z})))$

In this example, the substitution instances or *unifications* that would make the initial expression identical to each of the other three are written as

- 1) $\{\text{fred}/\text{X}, \text{Z}/\text{Y}\}$
- 2) $\{\text{W}/\text{X}, \text{jack}/\text{Y}\}$
- 3) $\{\text{Z}/\text{X}, \text{moo}(\text{Z})/\text{Y}\}$

The notation $\text{X}/\text{Y}, \dots$ indicates that X is substituted for the variable Y in the original expression. Substitutions are also referred to as *bindings*. A variable is said to be *bound* to the value substituted for it.

In defining the unification algorithm that computes the substitutions required to match two expressions, a number of issues must be taken into account.

Although a constant may be systematically substituted for a variable, any constant is considered a “ground instance” and may not be replaced. Neither can two different ground instances be substituted for one variable.

A variable cannot be unified with a term containing that variable. X cannot be replaced by $\text{p}(\text{X})$ as this creates an infinite expression: $\text{p}(\text{p}(\text{p}(\text{p}(\dots\text{X})\dots))\dots)$. The test for this situation is called the *occurs check*.

Generally, a problem-solving process will require multiple inferences and, consequently, multiple successive unifications. Logic problem solvers must maintain consistency of variable substitutions. It is important that any unifying substitution be made consistently across all occurrences of the variable in both expressions being matched. This was seen before when *socrates* was substituted not only for the variable X in $\text{man}(\text{X})$ but also for the variable X in $\text{mortal}(\text{X})$.

Once a variable has been bound, future unifications and inferences must take the value of this binding into account. If a variable is bound to a constant, that variable may not be given a new binding in a future unification. If a variable X_1 is substituted for another variable X_2 and at a later time X_1 is replaced by a constant, then X_2 must also reflect this binding. The complete set of substitutions used in a sequence of inferences is important, because it may contain the answer to the original query (Section 12.2.5). For example, if $\text{p}(\text{a}, \text{X})$ unifies with the premise of $\text{p}(\text{Y}, \text{Z}) \Rightarrow \text{q}(\text{Y}, \text{Z})$ under the substitution $\{\text{a}/\text{Y}, \text{X}/\text{Z}\}$, modus ponens lets us infer $\text{q}(\text{a}, \text{X})$ under the same substitution. If we match this result with the premise of $\text{q}(\text{W}, \text{b}) \Rightarrow \text{r}(\text{W}, \text{b})$, we infer $\text{r}(\text{a}, \text{b})$ under the substitution set $\{\text{a}/\text{W}, \text{b}/\text{X}\}$.

Another important concept is the *composition* of unification substitutions. If S and S' are two substitution sets, then the composition of S and S' (written $\text{S}'\text{S}$) is obtained by applying S to the elements of S' and adding the result to S . Consider the example of composing the sequence of substitutions

$\{\text{X}/\text{Y}, \text{W}/\text{Z}\}, \{\text{V}/\text{X}\}, \{\text{a}/\text{V}, \text{f}(\text{b})/\text{W}\}.$

These are equivalent to the single substitution

$\{a/Y, f(b)/Z\}$.

This was produced by composing $\{X/Y, W/Z\}$ with $\{V/X\}$ to yield $\{V/Y, W/Z\}$ and then composing this with $\{a/V, f(b)/W\}$ to produce $\{a/Y, f(b)/Z\}$.

Composition is the method by which unification substitutions are combined and returned in the recursive function `unify`, presented next. Composition can be shown to be associative but not commutative. The exercises present these issues in more detail.

A final requirement of the unification algorithm is that the unifier be as general as possible: that the *most general unifier* be found for the two expressions. This is important, as will be seen in the next example, because, if generality is lost in the solution process, it will lessen the scope of the eventual solution or even eliminate the possibility of a solution entirely.

For example, in unifying $p(X)$ and $p(Y)$ any constant expression such as $\{\text{fred}/X, \text{fred}/Y\}$ will do the trick. However, `fred` is not the most general unifier; any variable would work and produce a more general expression: $\{Z/X, Z/Y\}$. The solutions obtained from the first substitution instance would always be restricted by having the constant `fred` limit the resulting inferences; i.e., `fred` would be a unifier, but it would lessen the generality of the result.

DEFINITION

MOST GENERAL UNIFIER (mgu)

If s is any unifier of expressions E and g is the most general unifier of that set of expressions, then for s applied to E there exists another unifier s' such that $Es = Egs'$ (where gs' is the composition of unifiers, as seen above).

The most general unifier for a set of expressions is unique except for alphabetic variations; i.e., whether a variable is eventually called X or Y really does not make any difference to the generality of the resulting unifications.

Unification is critically important for any artificial intelligence problem solver that uses the predicate calculus as a representation language. Unification specifies the conditions under which two (or more) predicate calculus expressions may be said to be equivalent. This underlies the possibility of using inference rules such as *modus ponens* or *resolution* with logical representations such as *PROLOG* or the *LISP*-based logic programming language described in Chapter 10.

We conclude by presenting the pseudo-code for a function, `unify`, that computes the unifying substitutions (when this is possible) between two predicate calculus expressions. `Unify` takes as arguments two expressions in the predicate calculus and returns either the most general unifying substitutions or the constant `FAIL` if no unification is possible. It is defined as a recursive function: first, it recursively attempts to unify the initial components of the expressions. If this succeeds, any substitutions returned by this unification are applied to the remainder of both expressions. These are then passed in a second recursive

call to unify, which attempts to complete the unification. The recursion stops when either argument is a symbol (a predicate, function name, constant, or variable) or the elements of the expression have all been matched.

To simplify the manipulation of predicate calculus expressions, the algorithm assumes a slightly modified expression syntax. Because unify simply performs syntactic pattern matching, it can effectively ignore the predicate calculus distinction between predicates, functions, and arguments. By representing a sentence as a *list* (an ordered sequence of elements) with the predicate or function name as the first element followed by its arguments, we simplify the manipulation of expressions. Expressions in which an argument is itself a predicate or function expression are represented as lists within the list, thus preserving the structure of the expression. Lists are delimited by parentheses, (), and list elements are separated by spaces. Examples of expressions in both predicate calculus (PC) and list syntax are:

PC SYNTAX

p(a,b)
p(f(a),g(X,Y))
equal(eve,mother(cain))

LIST SYNTAX

(p a b)
(p (f a) (g X Y))
(equal eve (mother cain))

We next present the function unify:

```
function unify(E1, E2);
begin
  case
    both E1 and E2 are constants or the empty list:          %recursion stops
      if E1 = E2 then return {}
      else return FAIL;
    E1 is a variable:
      if E1 occurs in E2 then return FAIL
      else return {E2/E1};
    E2 is a variable:
      if E2 occurs in E1 then return FAIL
      else return {E1/E2}
    otherwise:                                                %both E1 and E2 are lists
      begin
        HE1 := first element of E1;
        HE2 := first element of E2;
        SUBS1 := unify(HE1,HE2);
        if SUBS1 := FAIL then return FAIL;
        TE1 := apply(SUBS1, rest of E1);
        TE2 := apply (SUBS1, rest of E2);
        SUBS2 := unify(TE1, TE2);
        if SUBS2 = FAIL then return FAIL;
        else return composition(SUBS1,SUBS2)
      end
  end
end
end
end
```

2.3.3 A Unification Example

The behavior of the preceding algorithm may be clarified by tracing the call

`unify((parents X (father X) (mother bill)), (parents bill (father bill) Y)).`

When `unify` is first called, because neither argument is an atomic symbol, the function will attempt to recursively unify the first elements of each expression, calling

`unify(parents, parents).`

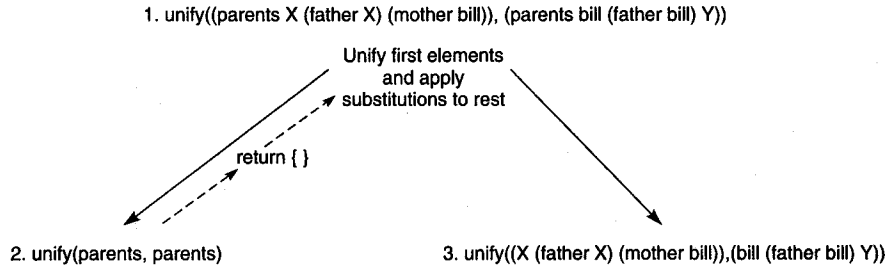

Figure 2.5 Initial steps in the unification of `(parents X (father X) (mother bill))` and `(parents bill (father bill) Y)`.

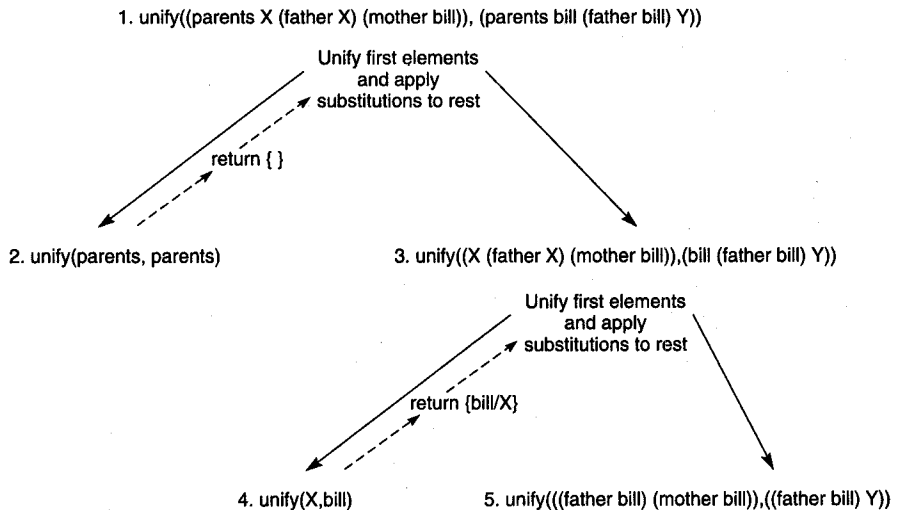

Figure 2.6 Further steps in the unification of `(parents X (father X) (mother bill))` and `(parents bill (father bill) Y)`.

This unification succeeds, returning the empty substitution, $\{ \}$. Applying this to the remainder of the expressions creates no change; the algorithm then calls

$\text{unify}((X (\text{father } X) (\text{mother } \text{bill})), (\text{bill } (\text{father } \text{bill}) Y))$.

A tree depiction of the execution at this stage appears in Figure 2.5.

In the second call to `unify`, neither expression is atomic, so the algorithm separates each expression into its first component and the remainder of the expression. This leads to the call

$\text{unify}(X, \text{bill})$.

This call succeeds, because both expressions are atomic and one of them is a variable. The call returns the substitution $\{\text{bill}/X\}$. This substitution is applied to the remainder of each expression and `unify` is called on the results (Figure 2.6):

$\text{unify}(((\text{father } \text{bill}) (\text{mother } \text{bill})), ((\text{father } \text{bill})Y))$.

The result of this call is to unify `(father bill)` with `(father bill)`. This leads to the calls

$\text{unify}(\text{father}, \text{father})$
 $\text{unify}(\text{bill}, \text{bill})$
 $\text{unify}((), ())$

All of these succeed, returning the empty set of substitutions (Figure 2.7).

`Unify` is then called on the remainder of the expressions:

$\text{unify}(((\text{mother } \text{bill})), (Y))$.

This, in turn, leads to calls

$\text{unify}((\text{mother } \text{bill}), Y)$
 $\text{unify}((), ())$.

In the first of these, `(mother bill)` unifies with `Y`. Notice that unification substitutes the whole *structure* `(mother bill)` for the variable `Y`. Thus, unification succeeds and returns the substitution $\{(\text{mother } \text{bill})/Y\}$. The call

$\text{unify}((), ())$

returns $\{ \}$. These are composed, along with the earlier substitution $\{\text{bill}/X\}$, to return the answer $\{\text{bill}/X (\text{mother } \text{bill})/Y\}$. A trace of the entire execution appears in Figure 2.7. Each call is numbered to indicate the order in which it was made; the substitutions returned by each call are noted on the arcs of the tree.

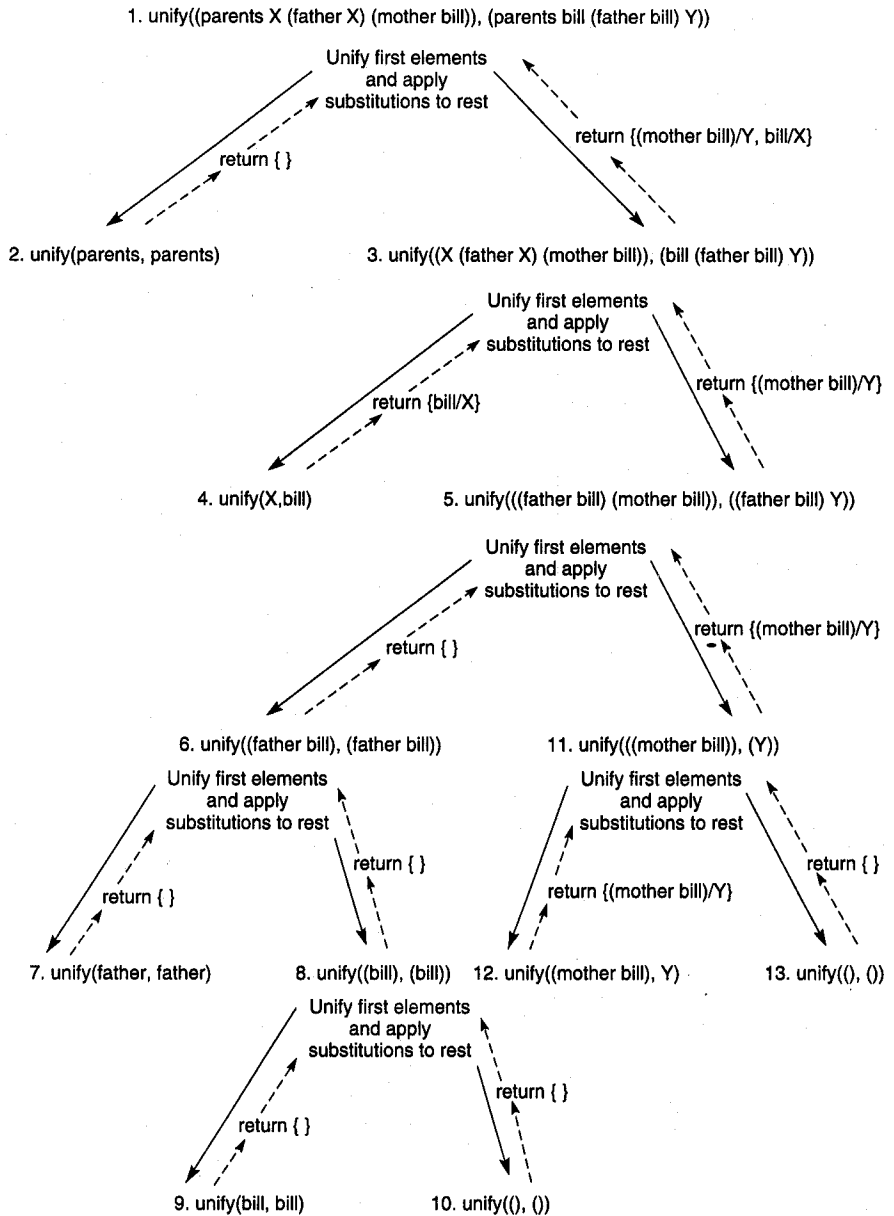

Figure 2.7 Final trace of the unification of (parents X (father X) (mother bill)) and (parents bill (father bill) Y).

2.4 Application: A Logic-Based Financial Advisor

As a final example of the use of predicate calculus to represent and reason about problem domains, we design a simple financial advisor using predicate calculus. Although a simple example, it illustrates many of the issues involved in realistic applications.

The function of the advisor is to help a user decide whether to invest in a savings account or the stock market. Some investors may want to split their money between the two. The investment that will be recommended for individual investors depends on their income and the current amount they have saved according to the following criteria:

1. Individuals with an inadequate savings account should always make increasing the amount saved their first priority, regardless of their income.
2. Individuals with an adequate savings account and an adequate income should consider a riskier but potentially more profitable investment in the stock market.
3. Individuals with a lower income who already have an adequate savings account may want to consider splitting their surplus income between savings and stocks, to increase the cushion in savings while attempting to increase their income through stocks.

The adequacy of both savings and income is determined by the number of dependents an individual must support. Our rule is to have at least \$5,000 in the bank for each dependent. An adequate income must be a steady income and supply at least \$15,000 per year plus an additional \$4,000 for each dependent.

To automate this advice, we translate these guidelines into sentences in the predicate calculus. The first task is to determine the major features that must be considered. Here, they are the adequacy of the savings and the income. These are represented by the predicates `savings_account` and `income`, respectively. Both of these are unary predicates, and their argument could be either `adequate` or `inadequate`. Thus,

```
savings_account(adequate).  
savings_account(inadequate).  
income(adequate).  
income(inadequate).
```

are their possible values.

Conclusions are represented by the unary predicate `investment`, with possible values of its argument being `stocks`, `savings`, or `combination` (implying that the investment should be split).

Using these predicates, the different investment strategies are represented by implications. The first rule, that individuals with inadequate savings should make increased savings their main priority, is represented by

```
savings_account(inadequate) => investment(savings).
```

Similarly, the remaining two possible alternatives are represented by

$$\begin{aligned} & \text{savings_account(adequate)} \wedge \text{income(adequate)} \Rightarrow \text{investment(stocks)}. \\ & \text{savings_account(adequate)} \wedge \text{income(inadequate)} \\ & \quad \Rightarrow \text{investment(combination)}. \end{aligned}$$

Next, the advisor must determine when savings and income are adequate or inadequate. This will also be done using implication. The need to do arithmetic calculations requires the use of functions. To determine the minimum adequate savings, the function `minsavings` is defined. `minsavings` takes one argument, the number of dependents, and returns 5000 times that argument.

Using `minsavings`, the adequacy of savings is determined by the rules

$$\begin{aligned} & \forall X \text{ amount_saved}(X) \wedge \exists Y (\text{dependents}(Y) \wedge \text{greater}(X, \text{minsavings}(Y))) \Rightarrow \\ & \quad \text{savings_account(adequate)}. \\ & \forall X \text{ amount_saved}(X) \wedge \exists Y (\text{dependents}(Y) \wedge \neg \text{greater}(X, \text{minsavings}(Y))) \\ & \quad \Rightarrow \text{savings_account(inadequate)}. \end{aligned}$$

where $\text{minsavings}(X) = 5000 * X$.

In these definitions, `amount_saved(X)` and `dependents(Y)` assert the current amount in savings and the number of dependents of an investor; `greater(X,Y)` is the standard arithmetic test for one number being greater than another and is not formally defined in this example.

Similarly, a function `minincome` is defined as

$$\text{minincome}(X) = 15000 + (4000 * X).$$

`minincome` is used to compute the minimum adequate income when given the number of dependents. The investor's current income is represented by a predicate, `earnings`. Because an adequate income must be both steady and above the minimum, `earnings` takes two arguments: the first is the amount earned, and the second must be equal to either `steady` or `unsteady`. The remaining rules needed for the advisor are

$$\forall X \text{ earnings}(X, \text{steady}) \wedge \exists Y (\text{dependents}(Y) \wedge \text{greater}(X, \text{minincome}(Y))) \Rightarrow \text{income(adequate)}.$$
$$\forall X \text{ earnings}(X, \text{steady}) \wedge \exists Y (\text{dependents}(Y) \wedge \neg \text{greater}(X, \text{minincome}(Y))) \Rightarrow \text{income(inadequate)}.$$
$$\forall X \text{ earnings}(X, \text{unsteady}) \Rightarrow \text{income(inadequate)}.$$

In order to perform a consultation, a description of a particular investor is added to this set of predicate calculus sentences using the predicates `amount_saved`, `earnings`, and `dependents`. Thus, an individual with three dependents, \$22,000 in savings, and a steady income of \$25,000 would be described by

amount_saved(22000).
earnings(25000, steady).
dependents(3).

This yields a logical system consisting of the following sentences:

1. savings_account(inadequate) \Rightarrow investment(savings).
2. savings_account(adequate) \wedge income(adequate) \Rightarrow investment(stocks).
3. savings_account(adequate) \wedge income(inadequate)
 \Rightarrow investment(combination).
4. \forall amount_saved(X) \wedge \exists Y (dependents(Y) \wedge
greater(X, minsavings(Y))) \Rightarrow savings_account(adequate).
5. \forall X amount_saved(X) \wedge \exists Y (dependents(Y) \wedge
 \neg greater(X, minsavings(Y))) \Rightarrow savings_account(inadequate).
6. \forall X earnings(X, steady) \wedge \exists Y (dependents(Y) \wedge
greater(X, minincome(Y))) \Rightarrow income(adequate).
7. \forall X earnings(X, steady) \wedge \exists Y (dependents(Y) \wedge
 \neg greater(X, minincome(Y))) \Rightarrow income(inadequate).
8. \forall X earnings(X, unsteady) \Rightarrow income(inadequate).
9. amount_saved(22000).
10. earnings(25000, steady).
11. dependents(3).

where minsavings(X) = 5000 * X and minincome(X) = 15000 + (4000 * X).

This set of logical sentences describes the problem domain. The assertions are numbered so that they may be referenced in the following trace.

Using unification and modus ponens, a correct investment strategy for this individual may be inferred as a logical consequence of these descriptions. A first step would be to unify the conjunction of 10 and 11 with the first two components of the premise of 7; i.e.,

earnings(25000, steady) \wedge dependents(3)

unifies with

earnings(X, steady) \wedge dependents(Y)

under the substitution {25000/X, 3/Y}. Performing this substitution yields the new implication

earnings(25000, steady) \wedge dependents(3) \wedge \neg greater(25000, minincome(3))
 \Rightarrow income(inadequate).

Evaluating the function `minincome` yields the expression

$$\text{earnings}(25000, \text{steady}) \wedge \text{dependents}(3) \wedge \neg \text{greater}(25000, 27000) \\ \Rightarrow \text{income}(\text{inadequate}).$$

Because all three components of the premise are individually true, by 10, 3, and the mathematical definition of `greater`, their conjunction is true and the entire premise is true. Modus ponens may therefore be applied, yielding the conclusion `income(inadequate)`. This is added as assertion 12.

12. `income(inadequate)`.

Similarly,

$$\text{amount_saved}(22000) \wedge \text{dependents}(3)$$

unifies with the first two elements of the premise of assertion 4 under the substitution $\{22000/X, 3/Y\}$, yielding the implication

$$\text{amount_saved}(22000) \wedge \text{dependents}(3) \wedge \text{greater}(22000, \text{minsavings}(3)) \Rightarrow \\ \text{savings_account}(\text{adequate}).$$

Here, evaluating the function `minsavings(3)` yields the expression

$$\text{amount_saved}(22000) \wedge \text{dependents}(3) \wedge \text{greater}(22000, 15000) \Rightarrow \\ \text{savings_account}(\text{adequate}).$$

Again, because all of the components of the premise of this implication are true, the entire premise evaluates to true and modus ponens may again be applied, yielding the conclusion `savings_account(adequate)`, which is added as expression 13.

13. `savings_account(adequate)`.

As an examination of expressions 3, 12, and 13 indicates, the premise of implication 3 is also true. When we apply modus ponens a third time, the conclusion is `investment(combination)`. This is the suggested investment for this individual.

This example illustrates how predicate calculus may be used to reason about a realistic problem, drawing correct conclusions by applying inference rules to the initial problem description. We have not discussed exactly how an algorithm can determine the correct inferences to make to solve a given problem or the way in which this can be implemented on a computer. These topics are discussed in Chapters 3 and 4.

2.5 Epilogue and References

In this chapter we introduced predicate calculus as a representation language for AI problem solving. The symbols, terms, expressions, and semantics of the language were described and defined. Based on the semantics of predicate calculus, we defined inference rules that allow us to derive sentences that logically follow a given set of expressions. We defined a unification algorithm that determines the variable substitutions that make two expressions match. Matching is essential to the application of inference rules. We concluded the chapter with the example of a financial advisor that represents financial knowledge in predicate calculus and demonstrates logical inference as a problem-solving technique.

Predicate calculus is discussed in detail in a number of computer science books, including: *The Logical Basis for Computer Programming* by Zohar Manna and Richard Waldinger (1985), *Logic for Computer Science* by Jean H. Gallier (1986), *Symbolic Logic and Mechanical Theorem Proving* by Chin-liang Chang and Richard Char-tung Lee (1973), and *An Introduction to Mathematical Logic and Type Theory* by Peter B. Andrews (1986).

Books that describe the use of predicate calculus as an artificial intelligence representation language include: *Logical Foundations of Artificial Intelligence* by Michael Genesereth and Nils Nilsson (1987), *Principles of Artificial Intelligence* by Nils Nilsson (1980), *Automated Reasoning* by Larry Wos et al. (1984), and *Computer Modelling of Mathematical Reasoning* by Alan Bundy (1983). *Readings in Knowledge Representation* by Ronald Brachman and Hector Levesque (1985) includes a number of articles on the use of predicate calculus for knowledge representation.

2.6 Exercises

1. Using truth tables, prove the identities of Section 2.1.2.
2. A new operator, \oplus , or *exclusive-or*, may be defined by the following truth table:

P	Q	$P \oplus Q$
T	T	F
T	F	T
F	T	T
F	F	F

Create a propositional calculus expression using only \wedge , \vee , and \neg that is equivalent to $P \oplus Q$.

Prove their equivalence using truth tables.

3. The logical operator \Leftrightarrow is read "if and only if." $P \Leftrightarrow Q$ is defined as being equivalent to $(P \Rightarrow Q) \wedge (Q \Rightarrow P)$. Based on this definition, show that $P \Leftrightarrow Q$ is logically equivalent to $(P \vee Q) \Rightarrow (P \wedge Q)$:
 - a. By using truth tables.
 - b. By a series of substitutions using the identities in Figure 2.2.
4. Prove that implication is transitive in the propositional calculus, that is, that $((P \Rightarrow Q) \wedge (Q \Rightarrow R)) \Rightarrow (P \Rightarrow R)$.
5.
 - a. Prove that modus ponens is sound for propositional calculus. Hint: use truth tables to enumerate all possible interpretations.
 - b. *Abduction* is an inference rule that infers P from $P \Rightarrow Q$ and Q . Show that abduction is not sound (see Chapter 7).
 - c. Show modus tollens $((P \Rightarrow Q) \wedge \neg Q) \Rightarrow \neg P$ is sound.
6. Attempt to unify the following pairs of expressions. Either show their most general unifiers or explain why they will not unify.
 - a. $p(X, Y)$ and $p(a, Z)$
 - b. $p(X, X)$ and $p(a, b)$
 - c. $\text{ancestor}(X, Y)$ and $\text{ancestor}(\text{bill}, \text{father}(\text{bill}))$
 - d. $\text{ancestor}(X, \text{father}(X))$ and $\text{ancestor}(\text{david}, \text{george})$
 - e. $q(X)$ and $\neg q(a)$
7.
 - a. Compose the substitution sets $\{a/X, Y/Z\}$ and $\{X/W, b/Y\}$.
 - b. Prove that composition of substitution sets is associative.
 - c. Construct an example to show that composition is not commutative.
8. Implement the unify algorithm of Section 2.3.2 in the computer language of your choice.
9. Give two alternative interpretations for the blocks world description of Figure 2.3.
10. Jane Doe has four dependents, a steady income of \$30,000, and \$15,000 in her savings account. Add the appropriate predicates describing her situation to the general investment advisor of the example in Section 2.4 and perform the unifications and inferences needed to determine her suggested investment.
11. Write a set of logical predicates that will perform simple automobile diagnostics (e.g., if the engine won't turn over and the lights won't come on, then the battery is bad). Don't try to be too elaborate, but cover the cases of bad battery, out of gas, bad spark plugs, and bad starter motor.
12. The following story is from N. Wirth's (1976) *Algorithms + data structures = programs*.
 I married a widow (let's call her W) who has a grown-up daughter (call her D). My father (F), who visited us quite often, fell in love with my step-daughter and married her. Hence my father became my son-in-law and my step-daughter became my mother. Some months later, my wife gave birth to a son (S_1), who became the brother-in-law of my father, as well as my uncle. The wife of my father, that is, my step-daughter, also had a son (S_2).

 Using predicate calculus, create a set of expressions that represent the situation in the above story. Add expressions defining basic family relationships such as the definition of father-in-law and use modus ponens on this system to prove the conclusion that "I am my own grandfather."

STRUCTURES AND STRATEGIES FOR STATE SPACE SEARCH

3

In order to cope, an organism must either armor itself (like a tree or a clam) and “hope for the best,” or else develop methods for getting out of harm’s way and into the better neighborhoods of the vicinity. If you follow this later course, you are confronted with the primordial problem that every agent must continually solve: Now what do I do?

—DANIEL C. DENNETT, “*Consciousness Explained*”

*Two roads diverged in a yellow wood,
And sorry I could not travel both
And be one traveler, long I stood
And looked down one as far as I could
To where it bent in the undergrowth;
Then took the other. . .*

—ROBERT FROST, “*The Road Not Taken*”

3.0 Introduction

Chapter 2 introduced predicate calculus as an example of an artificial intelligence representation language. Well-formed predicate calculus expressions provide a means of describing objects and relations in a problem domain, and inference rules such as modus ponens allow us to infer new knowledge from these descriptions. These inferences define a space that is searched to find a problem solution. Chapter 3 introduces the theory of state space search.

To successfully design and implement search algorithms, a programmer must be able to analyze and predict their behavior. Questions that need to be answered include:

Is the problem solver guaranteed to find a solution?

Will the problem solver always terminate, or can it become caught in an infinite loop?

When a solution is found, is it guaranteed to be optimal?

What is the complexity of the search process in terms of time usage? Space usage?

How can the interpreter most effectively reduce search complexity?

How can an interpreter be designed to most effectively utilize a representation language?

The theory of *state space search* is our primary tool for answering these questions. By representing a problem as a *state space graph*, we can use *graph theory* to analyze the structure and complexity of both the problem and the procedures used to solve it.

A graph consists of a set of *nodes* and a set of *arcs* or *links* connecting pairs of nodes. In the state space model of problem solving, the nodes of a graph are taken to represent discrete *states* in a problem-solving process, such as the results of logical inferences or configurations of a game board. The arcs of the graph represent transitions between states. These transitions correspond to logical inferences or legal moves of a game. In expert systems, for example, states describe our knowledge of a problem instance at some stage of a reasoning process. Expert knowledge, in the form of *if . . . then* rules, allows us to generate new information; the act of applying a rule is represented as an arc between states.

Graph theory is our best tool for reasoning about the structure of objects and relations; indeed, this is precisely the need that led to its creation in the early eighteenth century. The Austrian mathematician Leonhard Euler invented graph theory to solve the “bridges of Königsberg problem.” The city of Königsberg occupied both banks and two islands of a river. The islands and the riverbanks were connected by seven bridges, as indicated in Figure 3.1.

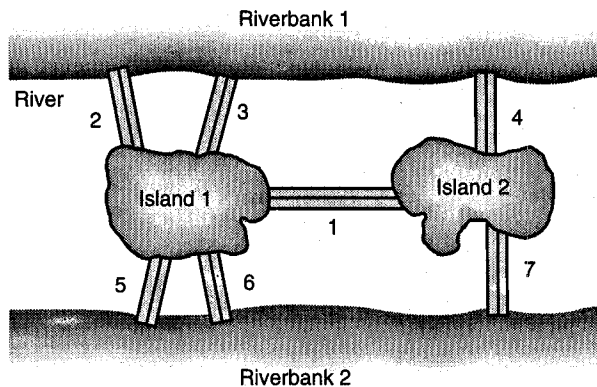

Figure 3.1 The city of Königsberg.

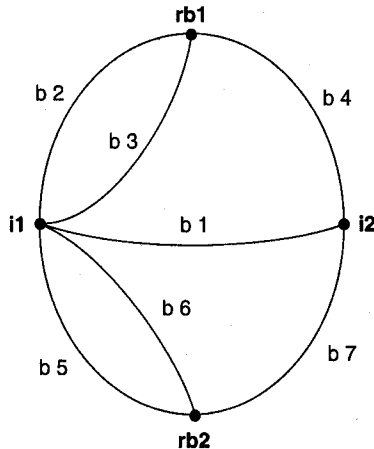

Figure 3.2 Graph of the Königsberg bridge system.

The bridges of Königsberg problem asks if there is a walk around the city that crosses each bridge exactly once. Although the residents had failed to find such a walk and doubted that it was possible, no one had proved its impossibility. Devising a form of graph theory, Euler created an alternative representation for the map, presented in Figure 3.2. The riverbanks (rb1 and rb2) and islands (i1 and i2) are described by the nodes of a graph; the bridges are represented by labeled arcs between nodes (b1, b2, ..., b7). The graph representation preserves the essential structure of the bridge system, while ignoring extraneous features such as distance and direction.

Alternatively, we may represent the Königsberg bridge system using predicate calculus. The `connect` predicate corresponds to an arc of the graph, asserting that two land masses are connected by a particular bridge. Each bridge requires two `connect` predicates, one for each direction in which the bridge may be crossed:

<code>connect(i1,i2,b1).</code>	<code>connect(i2,i1,b1).</code>
<code>connect(rb1,i1,b2).</code>	<code>connect(i1,rb1,b2).</code>
<code>connect(rb1,i1,b3).</code>	<code>connect(i1,rb1,b3).</code>
<code>connect rb1,i2,b4).</code>	<code>connect(i2,rb1,b4).</code>
<code>connect(rb2,i1,b5).</code>	<code>connect(i1,rb2,b5).</code>
<code>connect(rb2,i1,b6).</code>	<code>connect(i1,rb2,b6).</code>
<code>connect(rb2,i2,b7).</code>	<code>connect(i2,rb2,b7).</code>

This is equivalent to the graph representation in that the connectedness is preserved. Indeed, an algorithm could translate between the two representations with no loss of information. However, the structure of the problem can be visualized more directly in the graph representation, whereas it is left implicit in the predicate calculus version. Euler's proof illustrates this distinction.

In proving that the walk was impossible, Euler focused on the *degree* of the nodes of the graph, observing that a node could be of either *even* or *odd* degree. An *even* degree node has an even number of arcs joining it to neighboring nodes. An *odd* degree node has an odd number of arcs.

With the exception of its beginning and ending nodes, the desired walk would have to leave each node exactly as often as it entered it. Nodes of odd degree could be used only as the beginning or ending of the walk, because such nodes could be crossed only a certain number of times before they proved to be a dead end. The traveler could not exit the node without using a previously traveled arc.

Euler noted that unless a graph contained either exactly zero or two nodes of odd degree, the walk was impossible. If there were two odd-degree nodes, the walk could start at the first and end at the second; if there were no nodes of odd degree, the walk could begin and end at the same node. The walk is not possible for graphs containing any other number of nodes of odd degree, as is the case with the city of Königsberg. This problem is now called finding an *Euler path* through a graph.

Note that the predicate calculus representation, though it captures the relationships between bridges and land in the city, does not suggest the concept of the degree of a node. In the graph representation there is a single instance of each node with arcs between the nodes, rather than multiple occurrences of constants as arguments in a set of predicates. For this reason, the graph representation suggests the concept of node degree and the focus of Euler's proof. This illustrates graph theory's power for analyzing the structure of objects, properties, and relationships.

After reviewing basic graph theory, we present the state space description of problems, along with graph search as a problem-solving methodology. Depth-first and breadth-first search are two strategies for searching a state space. We compare these and make the added distinction between goal-driven and data-driven search. Section 3.3 demonstrates how state space search is used to characterize logical reasoning. Throughout the chapter, we use graph theory to analyze the structure and complexity of a variety of problems.

3.1 Graph Theory

3.1.1 Structures for State Space Search

A graph is a set of nodes and arcs that connect them. A *labeled* graph has one or more descriptors (labels) attached to each node that distinguish that node from any other node in the graph. In a state space graph, these descriptors identify states in a problem-solving process. If there are no descriptive differences between two nodes, they are considered the same. The arc between two nodes is indicated by the labels of the connected nodes.

The arcs of a graph may also be labeled. Arc labels are used to indicate that an arc represents a named relationship (as in a semantic network) or to attach weights to arcs (as in the traveling salesperson problem). If there are different arcs between the same two nodes (as in Figure 3.2), these can also be distinguished through labeling.

A graph is *directed* if arcs have an associated directionality. The arcs in a directed graph are usually drawn as arrows or have an arrow attached to indicate direction. Arcs that can be crossed in either direction may have two arrows attached but more often have no direction indicators at all. Figure 3.3 is a labeled, directed graph: arc (a, b) may only be crossed from node a to node b, but arc (b, c) is crossable in either direction.

A *path* through a graph connects a sequence of nodes through successive arcs. The path is represented by an ordered list that records the nodes in the order they occur in the path. In Figure 3.3, [a, b, c, d] represents the path through nodes a, b, c, and d, in that order.

A *rooted* graph has a unique node, called the *root*, such that there is a path from the root to all nodes within the graph. In drawing a rooted graph, the root is usually drawn at the top of the page, above the other nodes. The state space graphs for games are usually rooted graphs with the start of the game as the root. The initial moves of the tic-tac-toe game graph are represented by the rooted graph of Figure II.5. This is a directed graph with all arcs having a single direction. Note that this graph contains no cycles; players cannot (as much as they might sometimes wish!) undo a move.

A *tree* is a graph in which two nodes have at most one path between them. Trees often have roots, in which case they are usually drawn with the root at the top, like a rooted graph. Because each node in a tree has only one path of access from any other node, it is impossible for a path to *loop* or *cycle* continuously through a sequence of nodes.

Terms used to describe relationships between nodes include *parent*, *child*, and *sibling*. These are used in the usual familial fashion with the parent preceding its child along a directed arc. The children of a node are called *siblings*. Similarly, an *ancestor* comes before a *descendant* in some path of a directed graph. In Figure 3.4, b is a *parent* of nodes e and f (which are, therefore, *children* of b and *siblings* of each other). Nodes a and c are *ancestors* of states g, h, and i, and g, h, and i are *descendants* of a and c.

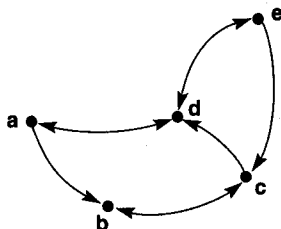

Nodes = {a,b,c,d,e}

Arcs = {(a,b),(a,d),(b,c),(c,b),(c,d),(d,a),(d,e),(e,c),(e,d)}

Figure 3.3 A labeled directed graph.

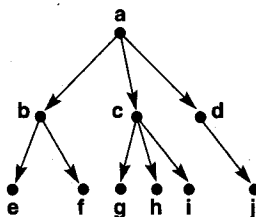

Figure 3.4 A rooted tree, exemplifying family relationships.

Before introducing the state space representation of problems we formally define these concepts.

DEFINITION

GRAPH

A graph consists of:

A set of *nodes* $N_1, N_2, N_3, \dots, N_n, \dots$, which need not be finite.

A set of *arcs* that connect pairs of nodes.

(Arcs are often described as an ordered pair of nodes; i.e., the arc (N_3, N_4) connects node N_3 to node N_4 .)

A *directed* graph has an indicated direction for traversing each arc. For example, a directed graph might have (N_3, N_4) as an arc but not (N_4, N_3) . This would indicate that a path through the graph could go from node N_3 to N_4 but not from N_4 to N_3 .

If a directed arc connects N_j and N_k , then N_j is called the *parent* of N_k and N_k the *child* of N_j . If the graph also contains an arc (N_j, N_i) , then N_k and N_i are called *siblings*.

A *rooted* graph has a unique node N_s from which all paths in the graph originate. That is, the root has no parent in the graph.

A *tip* or *leaf* node is a node that has no children.

An ordered sequence of nodes $[N_1, N_2, N_3, \dots, N_n]$, where each N_i, N_{i+1} in the sequence represents an arc (N_i, N_{i+1}) , is called a *path* of length $n - 1$ in the graph.

On a path in a rooted graph, a node is said to be an *ancestor* of all nodes positioned after it (to its right) as well as a *descendant* of all nodes before it (to its left).

A path that contains any node more than once (some N_j in the definition of path above is repeated) is said to contain a *cycle* or *loop*

A *tree* is a graph in which there is a unique path between every pair of nodes. (The paths in a tree, therefore, contain no cycles.)

The edges in a rooted tree are directed away from the root. Each node in a rooted tree has a unique parent.

Two nodes in a graph are said to be *connected* if a path exists that includes them both.

3.1.2 State Space Representation of Problems

In the *state space representation* of a problem, the nodes of a graph correspond to partial problem solution *states* and the arcs correspond to steps in a problem-solving process. One or more *initial states*, corresponding to the given information in a problem instance, form the root of the graph. The graph also defines one or more *goal* conditions, which are solutions to a problem instance. *State space search* characterizes problem solving as the process of finding a *solution path* from the start state to a goal.

We now formally define the state space representation of problems.

DEFINITION

STATE SPACE SEARCH

A *state space* is represented by a four-tuple $[N, A, S, GD]$, where:

N is the set of nodes or states of the graph. These correspond to the states in a problem-solving process.

A is the set of arcs (or links) between nodes. These correspond to the steps in a problem-solving process.

S , a nonempty subset of N , contains the start state(s) of the problem.

GD , a nonempty subset of N , contains the goal state(s) of the problem. The states in GD are described using either:

1. A measurable property of the states encountered in the search.
2. A property of the path developed in the search.

A *solution path* is a path through this graph from a node in S to a node in GD .

A goal may describe a state, such as a winning board in tic-tac-toe (Figure II.5) or a goal configuration in the 8-puzzle (Figure 3.5). Alternatively, a goal can describe some property of the solution path itself. In the traveling salesperson problem (Figures 3.7 and 3.8), search terminates when the "shortest" path is found through all nodes of the graph. In

the parsing problem (Section 3.3), the path of successful analysis of a sentence indicates termination.

Arcs of the state space correspond to steps in a solution process and paths through the space represent solutions in various stages of completion. Paths are searched, beginning at the start state and continuing through the graph, until either the goal description is satisfied or they are abandoned. The actual generation of new states along the path is done by applying operators, such as “legal moves” in a game or inference rules in a logic problem or expert system, to existing states on a path.

The task of a search algorithm is to find a solution path through such a problem space. Search algorithms must keep track of the paths from a start to a goal node, because these paths contain the series of operations that lead to the problem solution.

One of the general features of a graph, and one of the problems that arise in the design of a graph search algorithm, is that states can sometimes be reached through different paths. For example, in Figure 3.3 a path can be made from state *a* to state *d* either through *b* and *c* or directly from *a* to *d*. This makes it important to choose the *best* path according to the needs of a problem. In addition, multiple paths to a state can lead to loops or cycles in a solution path that prevent the algorithm from reaching a goal. A blind search for goal state *e* in the graph of Figure 3.3 might search the sequence of states *abcdabcbcd . . .* forever!

If the space to be searched is a tree, as in Figure 3.4, the problem of cycles does not occur. It is, therefore, important to distinguish between problems whose state space is a tree and those that may contain loops. General graph search algorithms must detect and eliminate loops from potential solution paths, whereas tree searches may gain efficiency by eliminating this test and its overhead.

Tic-tac-toe and the 8-puzzle exemplify the state spaces of simple games. Both of these examples demonstrate termination conditions of type 1 in the above definition. Example 3.1.3, the traveling salesperson problem, has a goal description of type 2.

EXAMPLE 3.1.1: TIC-TAC-TOE

The state space representation of tic-tac-toe appears in Figure II.5. The start state is an empty board, and the termination or goal description is a board state having three Xs in a row, column, or diagonal (assuming that the goal is a win for X). The path from the start state to a goal state gives the series of moves in a winning game.

The states in the space are all the different configurations of Xs and Os that the game can have. Of course, although there are 3^9 ways to arrange {blank, X, O} in nine spaces, most of them could never occur in an actual game. Arcs are generated by legal moves of the game, alternating between placing an X and an O in an unused location. The state space is a graph rather than a tree, as some states on the third and deeper levels can be reached by different paths. However, there are no cycles in the state space, because the directed arcs of the graph do not allow a move to be undone. It is impossible to “go back up” the structure once a state has been reached. No checking for cycles in path generation is necessary. A graph structure with this property is called a *directed acyclic graph*, or *DAG*, and is common in state space search.

1	2	3	4
12	13	14	5
11		15	6
10	9	8	7

15-puzzle

1	2	3
8		4
7	6	5

8-puzzle

Figure 3.5 The 15-puzzle and the 8-puzzle.

The state space representation provides a means of determining the complexity of the problem. In tic-tac-toe, there are nine first moves with eight possible responses to each of them, followed by seven possible responses to each of these, and so on. It follows that $9 \times 8 \times 7 \times \dots$ or $9!$ different paths can be generated. Although it is not impossible for a computer to search this number of paths (362,880) exhaustively, many important problems also exhibit factorial or exponential complexity, although on a much larger scale. Chess has 10^{120} possible game paths; checkers has 10^{40} , some of which may never occur in an actual game. These spaces are difficult or impossible to search exhaustively. Strategies for searching such large spaces rely on heuristics to reduce the complexity of the search (Chapter 4).

EXAMPLE 3.1.2: THE 8-PUZZLE

In the *15-puzzle* of Figure 3.5, 15 differently numbered tiles are fitted into 16 spaces on a grid. One space is left blank so that tiles can be moved around to form different patterns. The goal is to find a series of moves of tiles into the blank space that places the board in a goal configuration. This is a common game that most of us played as children. (The version we remember was about 3 inches square and had red and white tiles in a black frame.)

A number of interesting aspects of this game have made it useful to researchers in problem solving. The state space is large enough to be interesting but is not completely intractable ($16!$ if symmetric states are treated as distinct). Game states are easy to represent. The game is rich enough to provide a number of interesting heuristics (see Chapter 4).

The *8-puzzle* is a 3×3 version of the 15-puzzle in which eight tiles can be moved around in nine spaces. Because it generates a smaller state space than the full 15-puzzle, it is used for many of the examples in this text.

Although in the physical puzzle moves are made by moving tiles (“move the 7 tile right, provided the blank is to the right of the tile” or “move the 3 tile down”), it is much simpler to think in terms of “moving the blank space” instead. This simplifies the definition of move rules because there are eight tiles but only a single blank. The legal moves are:

- move the blank up ↑
- move the blank right →
- move the blank down ↓
- move the blank left ←

In order to apply a move, we must make sure that it does not move the blank off the board. Therefore, all four moves are not applicable at all times; for example, when the blank is in one of the corners only two moves are possible.

If we specify a beginning state and a goal state for the 8-puzzle, it is possible to give a state space accounting of the problem-solving process (Figure 3.6). States could be represented using a simple 3 × 3 array. A predicate calculus representation could use a "state" predicate with nine parameters (for the locations of numbers in the grid). Four procedures, describing each of the possible moves of the blank, define the arcs in the state space.

As with tic-tac-toe, the state space for the 8-puzzle is a graph (with most states having multiple parents), but unlike tic-tac-toe, cycles are possible. The GD or goal description of the state space is a particular state or board configuration. When this state is found on a path, the search terminates. The path from the start to the goal is the desired series of moves.

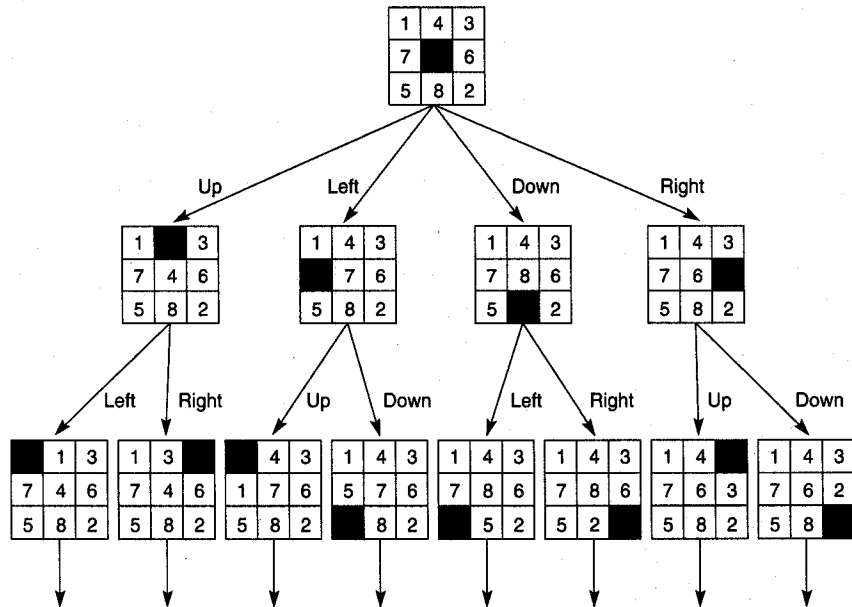

Figure 3.6 State space of the 8-puzzle generated by "move blank" operations.

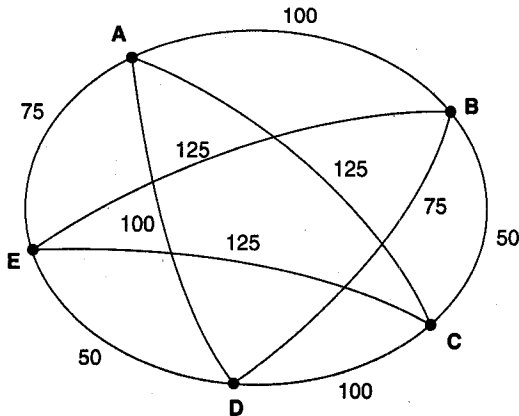

Figure 3.7 An instance of the traveling salesperson problem.

It is interesting to note that the complete state space of the 8- and 15-puzzles consists of two disconnected (and in this case equal-sized) subgraphs. This makes half the possible states in the search space impossible to reach from any given start state. If we exchange (by prying loose!) two immediately adjacent tiles, states in the other component of the space become reachable.

EXAMPLE 3.1.3: THE TRAVELING SALESPERSON

Suppose a salesperson has five cities to visit and then must return home. The goal of the problem is to find the shortest path for the salesperson to travel, visiting each city, and then returning to the starting city. Figure 3.7 gives an instance of this problem. The nodes of the graph represent cities, and each arc is labeled with a weight indicating the cost of traveling that arc. This cost might be a representation of the miles necessary in car travel or cost of an air flight between the two cities. For convenience, we assume the salesperson lives in city A and will return there, although this assumption simply reduces the problem of n cities to a problem of $(n - 1)$ cities.

The path [A,D,C,B,E,A], with associated cost of 450 miles, is an example of a possible circuit. The goal description requires a complete circuit with minimum cost. Note that the goal description is a property of the entire path, rather than of a single state. This is a goal description of type 2 from the definition of state space search.

Figure 3.8 shows one way in which possible solution paths may be generated and compared. Beginning with node A, possible next states are added until all cities are included and the path returns home. The goal is the lowest-cost path.

As Figure 3.8 suggests, the complexity of exhaustive search in the traveling salesperson problem is $(N - 1)!$, where N is the number of cities in the graph. For 9 cities we may exhaustively try all paths, but for any problem instance of interesting size, for example

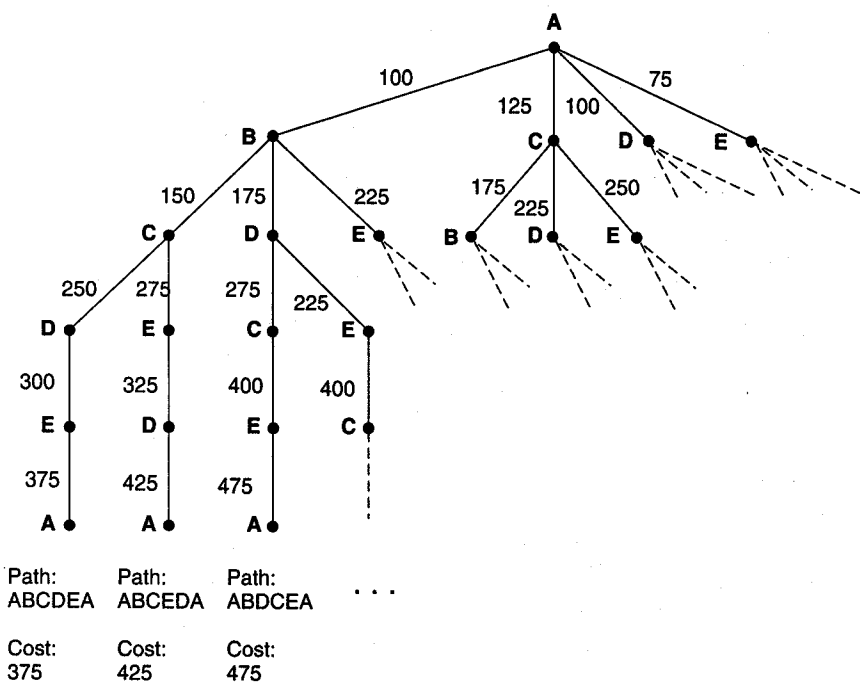

Figure 3.8 Search of the traveling salesperson problem. Each arc is marked with the total weight of all paths from the start node (A) to its endpoint.

with 50 cities, simple exhaustive search cannot be performed within a practical length of time. In fact complexity for an $N!$ search grows so fast that very soon the search combinations become intractable.

Several techniques can reduce the search complexity. One is called *branch and bound* (Horowitz and Sahni 1978). Branch and bound generates paths one at a time, keeping track of the best circuit found so far. This value is used as a *bound* on future candidates. As paths are constructed one city at a time, the algorithm examines each partially completed path. If the algorithm determines that the best possible extension to a path, the branch, will have greater cost than the bound, it eliminates that partial path and *all* of its possible extensions. This reduces search considerably but still leaves an exponential number of paths (1.26^N rather than $N!$).

Another strategy for controlling search constructs the path according to the rule “go to the closest unvisited city.” The “nearest neighbor” path through the graph of Figure 3.7 is [A,E,D,B,C,A], at a cost of 375 miles. This method is highly efficient, as there is only one path to be tried! The nearest neighbor heuristic is fallible, as graphs exist for which it does not find the shortest path, see Figure 3.9, but it is a possible compromise when the time required makes exhaustive search impractical.

Section 3.2 examines strategies for state space search.

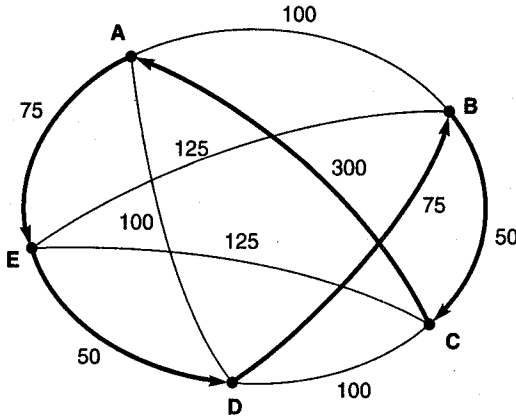

Figure 3.9 An instance of the traveling salesperson problem with the nearest neighbor path in bold. Note that this path (A, E, D, B, C, A), at a cost of 550, is not the shortest path. The comparatively high cost of arc (C, A) defeated the heuristic.

3.2 Strategies for State Space Search

3.2.1 Data-Driven and Goal-Driven Search

A state space may be searched in two directions: from the given data of a problem instance toward a goal or from a goal back to the data.

In *data-driven search*, sometimes called *forward chaining*, the problem solver begins with the given facts of the problem and a set of legal moves or rules for changing state. Search proceeds by applying rules to facts to produce new facts, which are in turn used by the rules to generate more new facts. This process continues until (we hope!) it generates a path that satisfies the goal condition.

An alternative approach is possible: take the goal that we want to solve. See what rules or legal moves could be used to generate this goal and determine what conditions must be true to use them. These conditions become the new goals, or *subgoals*, for the search. Search continues, working backward through successive subgoals until (we hope!) it works back to the facts of the problem. This finds the chain of moves or rules leading from data to a goal, although it does so in backward order. This approach is called *goal-driven reasoning*, or *backward chaining*, and it recalls the simple childhood trick of trying to solve a maze by working back from the finish to the start.

To summarize: data-driven reasoning takes the facts of the problem and applies the rules and legal moves to produce new facts that lead to a goal; goal-driven reasoning focuses on the goal, finds the rules that could produce the goal, and chains backward through successive rules and subgoals to the given facts of the problem.

In the final analysis, both data-driven and goal-driven problem solvers search the same state space graph; however, the order and actual number of states searched can differ. The preferred strategy is determined by the properties of the problem itself. These include the complexity of the rules, the “shape” of the state space, and the nature and availability of the problem data. All of these vary for different problems.

As an example of the effect a search strategy can have on the complexity of search, consider the problem of confirming or denying the statement “I am a descendant of Thomas Jefferson.” A solution is a path of direct lineage between the “I” and Thomas Jefferson. This space may be searched in two directions, starting with the “I” and working along ancestor lines to Thomas Jefferson or starting with Thomas Jefferson and working through his descendants.

Some simple assumptions let us estimate the size of the space searched in each direction. Thomas Jefferson was born about 250 years ago; if we assume 25 years per generation, the required path will be about length 10. As each person has exactly two parents, a search back from the “I” would examine on the order of 2^{10} ancestors. A search that worked forward from Thomas Jefferson would examine more states, as people tend to have more than two children (particularly in the eighteenth and nineteenth centuries). If we assume an average of only three children per family, the search would examine on the order of 3^{10} nodes of the family tree. Thus, a search back from the “I” would examine fewer nodes. Note, however, that both directions yield exponential complexity.

Problem solvers have been written using each of the data- and goal-driven approaches; the decision is based on the structure of the problem to be solved. Goal-driven search is suggested if:

1. A goal or hypothesis is given in the problem statement or can easily be formulated. In a mathematics theorem prover, for example, the goal is the theorem to be proved. Many diagnostic systems consider potential diagnoses in a systematic fashion, confirming or eliminating them using goal-driven reasoning.
2. There are a large number of rules that match the facts of the problem and thus produce an increasing number of conclusions or goals. Early selection of a goal can eliminate most of these branches, making goal-driven search more effective in pruning the space (Figure 3.10). In a mathematics theorem prover, for example, the number of rules that conclude a given theorem is much smaller than the number of rules that may be applied to the entire set of axioms.
3. Problem data are not given but must be acquired by the problem solver. In this case, goal-driven search can help guide data acquisition. In a medical diagnosis program, for example, a wide range of diagnostic tests can be applied. Doctors order only those that are necessary to confirm or deny a particular hypothesis.

Goal-driven search thus uses knowledge of the desired goal to guide the search through relevant rules and eliminate branches of the space.

Data-driven search is appropriate to problems in which:

1. All or most of the data are given in the initial problem statement. Interpretation problems often fit this mold by presenting a collection of data and asking the

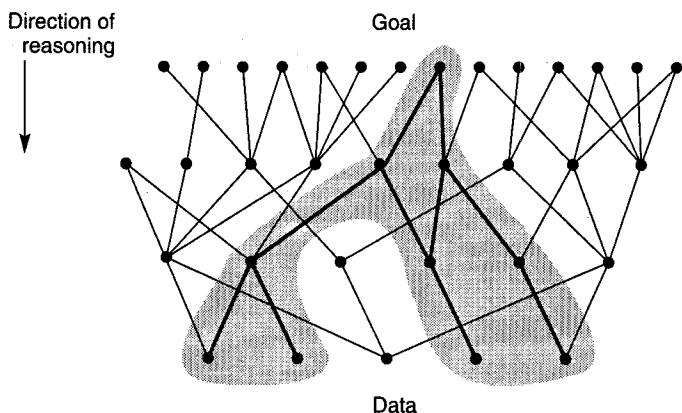

Figure 3.10 State space in which goal-directed search effectively prunes extraneous search paths.

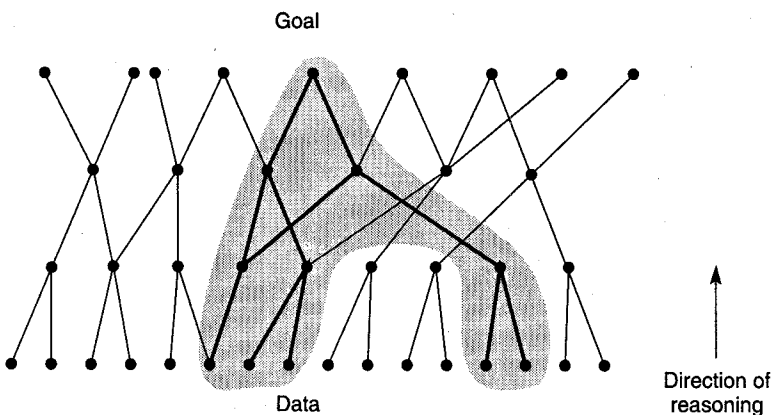

Figure 3.11 State space in which data-directed search prunes irrelevant data and their consequents and determines one of a number of possible goals.

system to provide a high-level interpretation. Systems that analyze particular data (such as the PROSPECTOR or Dipmeter programs, which interpret geological data or attempt to find what minerals are likely to be found at a site) fit the data-driven approach.

2. There are a large number of potential goals, but there are only a few ways to use the facts and given information of a particular problem instance (Figure 3.11). The DENDRAL program, an expert system that finds the molecular structure of organic compounds based on their formula, mass spectrographic data, and

knowledge of chemistry, is an example of this. For any organic compound, there are an enormous number of possible structures. However, the mass spectrographic data on a compound allow DENDRAL to eliminate all but a few of these.

3. It is difficult to form a goal or hypothesis. In a DENDRAL consultation, for example, little is initially known about the possible structure of a compound.

Data-driven search uses the knowledge and constraints found in the given data of a problem to guide search along lines known to be true.

To summarize, there is no substitute for careful analysis of the particular problem, considering such issues as the *branching factor* of rule applications (see Chapter 4; on average, how many new states are generated by rule applications in both directions?), availability of data, and ease of determining potential goals.

3.2.2 Implementing Graph Search

In solving a problem using either goal- or data-driven search, a problem solver must find a path from a start state to a goal through the state space graph. The sequence of arcs in this path corresponds to the ordered steps of the solution. If a problem solver were given an oracle or other infallible mechanism for choosing a solution path, search would not be required. The problem solver would move unerringly through the space to the desired goal, constructing the path as it went. Because oracles do not exist for interesting problems, a problem solver must consider different paths through the space until it finds a goal. *Backtracking* is a technique for systematically trying all paths through a state space.

Backtracking search begins at the start state and pursues a path until it reaches either a goal or a "dead end." If it finds a goal, it quits and returns the solution path. If it reaches a dead end, it "backtracks" to the most recent node on the path having unexamined siblings and continues down one of these branches. The algorithm's behavior at each node is described in the following recursive rule:

If the present state S does not meet the requirements of the goal description, then generate its first descendant S_{child1} , and apply the backtrack procedure recursively to this node. If backtrack does not find a goal node in the subgraph rooted at S_{child1} , repeat the procedure for its sibling, S_{child2} . This continues until either some descendant of a child is a goal node or all the children have been searched. If none of the children of S leads to a goal, then backtrack "fails back" to the parent of S , where it is applied to the siblings of S , and so on.

The algorithm continues in this fashion until it finds a goal or exhausts the state space. Figure 3.12 shows the backtrack algorithm applied to a hypothetical state space. The direction of the dashed arrows on the tree indicates the progress of search up and down the space. The number beside each node indicates the order in which it is visited.

Below, we define an algorithm that performs a backtracking search. It uses three lists to keep track of nodes in the state space:

SL, for state list, lists the states in the current path being tried. If a goal is found, SL contains the ordered list of states on the solution path.

NSL, for new state list, contains nodes awaiting evaluation, i.e., nodes whose descendants have not yet been generated and searched.

DE, for dead ends, lists states whose descendants have failed to contain a goal node. If these states are encountered again, they will be detected as elements of DE and eliminated from consideration immediately.

In defining the backtrack algorithm for the general case (a graph rather than a tree), it is necessary to detect multiple occurrences of any state so that it will not be reentered and cause (infinite) loops in the path. This is accomplished by testing each newly generated state for membership in any of these three lists. If a new state belongs to any of these lists, then it has already been visited and may be ignored.

```
function backtrack;

begin
  SL := [Start]; NSL := [Start]; DE := []; CS := Start;           % initialize:
  while NSL ≠ []           % while there are states to be tried
  do begin
    if CS = goal (or meets goal description)
    then return(SL);           % on success, return list of states in path.
    if CS has no children (excluding nodes already on DE, SL, and NSL)
    then begin
      while SL is not empty and CS = the first element of SL
      do begin
        add CS to DE;           % record state as dead end
        remove first element from SL;           %backtrack
        remove first element from NSL;
        CS := first element of NSL;
      end
      add CS to SL;
    end
    else begin
      place children of CS (except nodes already on DE, SL, or NSL) on NSL;
      CS := first element of NSL;
      add CS to SL
    end
  end
end;
return FAIL;
end.
```

In backtrack, the state currently under consideration is called CS for current state. CS is always equal to the state most recently added to SL and represents the “frontier” of the solution path currently being explored. Inference rules, moves in the game, or other

appropriate problem-solving operators are ordered and applied to CS. The result is an ordered set of new states, the children of CS. The first of these children is made the new current state and the rest are placed in order on NSL for future examination. The new current state is added to SL and search continues. If CS has no children, it is removed from SL (this is where the algorithm “backtracks”) and any remaining children of its predecessor on SL are examined.

A trace of backtrack on the graph of Figure 3.12 is given by:

Initialize: SL = [A]; NSL = [A]; DE = []; CS = A;

AFTER ITERATION	CS	SL	NSL	DE
0	A	[A]	[A]	[]
1	B	[BA]	[BCDA]	[]
2	E	[EBA]	[EFBCDA]	[]
3	H	[HEBA]	[HIEFBCDA]	[]
4	I	[IEBA]	[IEFBCDA]	[H]
5	F	[FBA]	[FBCDA]	[EIH]
6	J	[JFBA]	[JFBCDA]	[EIH]
7	C	[CA]	[CDA]	[BFJEIH]
8	G	[GCA]	[GCDA]	[BFJEIH]

As presented here, backtrack implements data-driven search, taking the root as a start state and evaluating its children to search for the goal. The algorithm can be restructured

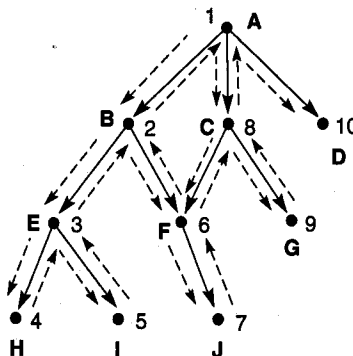

Figure 3.12 Backtracking search of a hypothetical state space.

into a goal-driven search by letting the goal be the root of the graph and evaluating descendants back in an attempt to find a start state. If the goal description is of type 2 (see Section 3.1.2), the algorithm must determine a goal state by examining the path on SL.

backtrack is an algorithm for searching state space graphs. The graph search algorithms in the remainder of the text, including depth-first, breadth-first, and best-first search, exploit the ideas used in **backtrack**, including:

1. The use of a list of unprocessed states (NSL) to allow the algorithm to return (backtrack) to any of these states.
2. A list of "bad" states (DE) to prevent the algorithm from retrying useless paths.
3. A list of nodes (SL) on the current solution path that is returned if a goal is found.
4. Explicit checks for membership of new states in these lists to prevent looping.

The next section introduces search algorithms that, like **backtrack**, use lists to keep track of states in a search space. These algorithms, including *depth-first*, *breadth-first*, and *best-first* (Chapter 4) search, differ from **backtrack** in providing a more flexible basis for implementing alternative graph search strategies.

3.2.3 Depth-First and Breadth-First Search

In addition to specifying a search direction (data-driven or goal-driven), a search algorithm must determine the order in which states are examined in the tree or the graph. This section considers two possibilities for the order in which the nodes of the graph are considered: *depth-first* and *breadth-first* search.

Consider the graph represented in Figure 3.13. States are labeled (A, B, C, . . .) so that they can be referred to in the discussion that follows. In depth-first search, when a state is examined, all of its children and their descendants are examined before any of its siblings. Depth-first search goes deeper into the search space whenever this is possible. Only when no further descendants of a state can be found are its siblings considered. Depth-first search examines the states in the graph of Figure 3.13 in the order A, B, E, K, S, L, T, F, M, C, G, N, H, O, P, U, D, I, Q, J, R. The **backtrack** algorithm of Section 3.2.2 implemented depth-first search.

Breadth-first search, in contrast, explores the space in a level-by-level fashion. Only when there are no more states to be explored at a given level does the algorithm move on to the next level. A breadth-first search of the graph of Figure 3.13 considers the states in the order A, B, C, D, E, F, G, H, I, J, K, L, M, N, O, P, Q, R, S, T, U.

We implement breadth-first search using lists, **open** and **closed**, to keep track of progress through the state space. **open**, like NSL in **backtrack**, lists states that have been generated but whose children have not been examined. The order in which states are removed from **open** determines the order of the search. **closed** records states that have already been examined. **closed** is the union of the DE and SL lists of the **backtrack** algorithm.

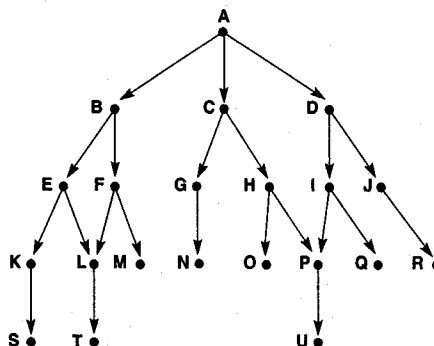

Figure 3.13 Graph for breadth- and depth-first search examples.

```

procedure breadth_first_search;

begin
  open := [Start];                                     % initialize
  closed := [ ];
  while open ≠ [ ]                                     do% states remain
  begin
    remove leftmost state from open, call it X;
    if X is a goal then return(success)                % goal found
    else begin
      generate children of X;
      put X on closed;
      eliminate children of X on open or closed;      % loop check
      put remaining children on right end of open     % queue
    end
  end
  return(failure)                                     % no states left
end.

```

Child states are generated by inference rules, legal moves of a game, or other state transition operators. Each iteration produces all children of the state X and adds them to **open**. Note that **open** is maintained as a *queue*, or first-in-first-out (FIFO) data structure. States are added to the right of the list and removed from the left. This biases search toward the states that have been on **open** the longest, causing the search to be breadth-first. Child states that have already been discovered (already appear on either **open** or **closed**) are eliminated. If the algorithm terminates because the condition of the “while” loop is no longer satisfied (**open** = []) then it has searched the entire graph without finding the desired goal: the search has failed.

A trace of **breadth_first_search** on the graph of Figure 3.13 appears below. Each successive number, 2,3,4, . . . , represents an iteration of the “while” loop. U is the desired goal state.

1. open = [A]; closed = []
2. open = [B,C,D]; closed = [A]
3. open = [C,D,E,F]; closed = [B,A]
4. open = [D,E,F,G,H]; closed = [C,B,A]
5. open = [E,F,G,H,I,J]; closed = [D,C,B,A]
6. open = [F,G,H,I,J,K,L]; closed = [E,D,C,B,A]
7. open = [G,H,I,J,K,L,M] (as L is already on open); closed = [F,E,D,C,B,A]
8. open = [H,I,J,K,L,M,N]; closed = [G,F,E,D,C,B,A]
9. and so on until either U is found or open = []

Figure 3.14 illustrates the graph of Figure 3.13 after six iterations of `breadth_first_search`. The states on `open` and `closed` are highlighted. States not shaded have not been discovered by the algorithm. Note that `open` records the states on the "frontier" of the search at any stage and that `closed` records states already visited.

Because breadth-first search considers every node at each level of the graph before going deeper into the space, all states are first reached along the shortest path from the start state. Breadth-first search is therefore guaranteed to find the shortest path from the start state to the goal. Furthermore, because all states are first found along the shortest path, any states encountered a second time are found along a path of equal or greater length. Because there is no chance that duplicate states were found along a better path, the algorithm simply discards any duplicate states.

It is often useful to keep other information on `open` and `closed` besides the names of the states. For example, note that `breadth_first_search` does not maintain a list of states on the current path to a goal as `backtrack` did on the list `SL`; all visited states are kept on `closed`. If the path is required for a solution, it can be returned by the algorithm. This can be done by storing ancestor information along with each state. A state may be saved along with a record of its parent state, i.e., as a (state, parent) pair. If this is done in the search of Figure 3.13, the contents of `open` and `closed` at the fourth iteration would be:

`open = [(D,A), (E,B), (F,B), (G,C), (H,C)]; closed = [(C,A), (B,A), (A,nil)]`

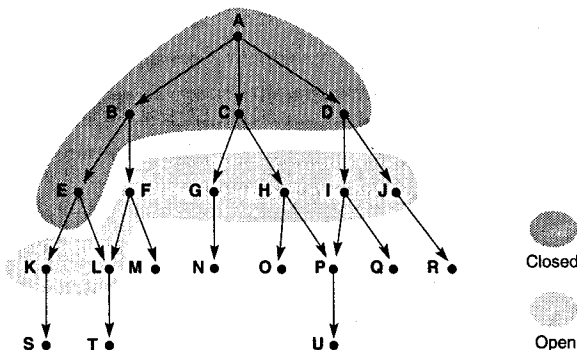

Figure 3.14 Graph of Figure 3.13 at iteration 6 of breadth-first search. States on `open` and `closed` are highlighted.

The path (A, B, F) that led from A to F could easily be constructed from this information. When a goal is found, the algorithm may construct the solution path by tracing back along parents from the goal to the start state. Note that state A has a parent of nil, indicating that it is a start state; this stops reconstruction of the path. Because breadth-first search finds each state along the shortest path and retains the first version of each state, this is the shortest path from a start to a goal.

Figure 3.15 shows the states removed from *open* and examined in a breadth-first search of the graph of the 8-puzzle. As before, arcs correspond to moves of the blank up, to the right, down, and to the left. The number next to each state indicates the order in which it was removed from *open*. States left on *open* when the algorithm halted are not shown.

Next we create a depth-first search algorithm. In examining the algorithm, note that the descendant states are both added and removed from the *left* end of *open*: *open* is maintained as a *stack*, or last-in-first-out (LIFO), structure. The organization of *open* as a stack biases search toward the most recently generated states, giving search a depth-first order.

Depth-first search is implemented by modifying the algorithm for breadth-first search:

```

procedure depth_first_search;

begin
  open := [Start];                               % initialize
  closed := [ ];
  while open ≠ [ ] do                             % states remain
    begin
      remove leftmost state from open, call it X;
      if X is a goal then return(success)          % goal found
      else begin
        generate children of X;
        put X on closed;
        eliminate children of X on open or closed; % loop check
        put remaining children on left end of open % stack
      end
    end;
  return(failure)                                 % no states left
end.

```

A trace of *depth_first_search* on the graph of Figure 3.13 appears below. Each successive iteration of the “while” loop is indicated by a single line (2, 3, 4, . . .). The initial states of *open* and *closed* are given on line 1. Assume U is the goal state.

1. open = [A]; closed = []
2. open = [B,C,D]; closed = [A]
3. open = [E,F,C,D]; closed = [B,A]
4. open = [K,L,F,C,D]; closed = [E,B,A]
5. open = [S,L,F,C,D]; closed = [K,E,B,A]

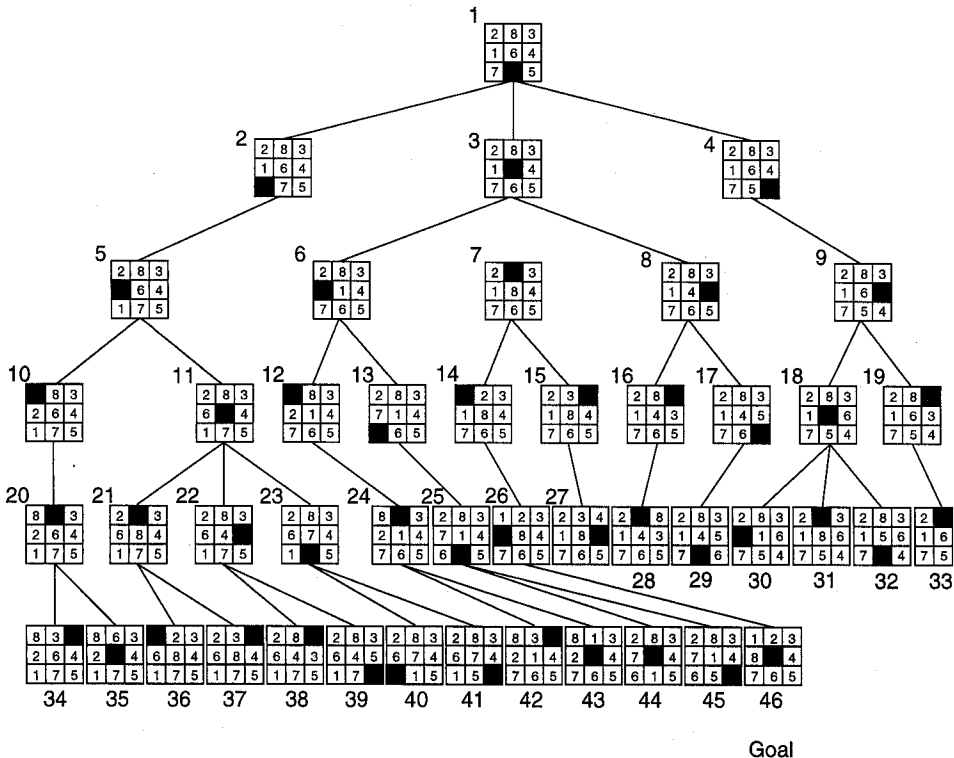

Figure 3.15 Breadth-first search of the 8-puzzle, showing order in which states were removed from open.

- 6. open = [L,F,C,D]; closed = [S,K,E,B,A]
- 7. open = [T,F,C,D]; closed = [L,S,K,E,B,A]
- 8. open = [F,C,D]; closed = [T,L,S,K,E,B,A]
- 9. open = [M,C,D], as L is already on closed; closed = [F,T,L,S,K,E,B,A]
- 10. open = [C,D]; closed = [M,F,T,L,S,K,E,B,A]
- 11. open = [G,H,D]; closed = [C,M,F,T,L,S,K,E,B,A]

and so on until either U is discovered or open = [].

As with `breadth_first_search`, open lists all states discovered but not yet evaluated (the current “frontier” of the search), and closed records states already considered. Figure 3.16 shows the graph of Figure 3.13 at the sixth iteration of the `depth_first_search`. The contents of open and closed are highlighted. As with `breadth_first_search`, the algorithm could store a record of the parent along with each state, allowing the algorithm to reconstruct the path that led from the start state to a goal.

Unlike breadth-first search, a depth-first search is not guaranteed to find the shortest path to a state the first time that state is encountered. Later in the search, a different path may be found to any state. If path length matters in a problem solver, when the algorithm

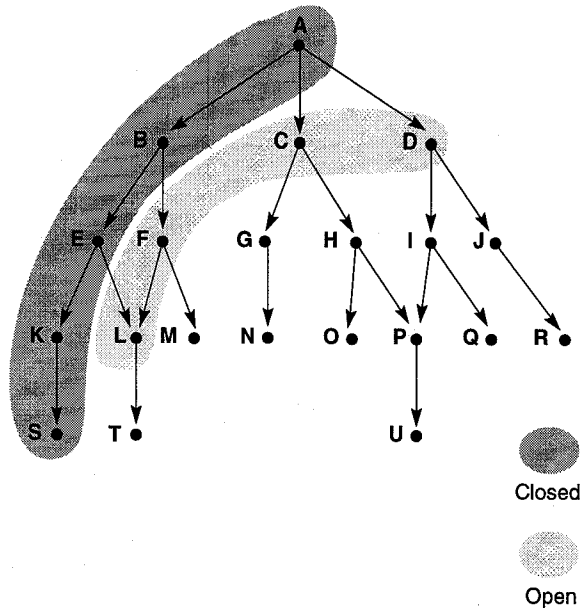

Figure 3.16 Graph of Figure 3.13 at iteration 6 of depth-first search. States on open and closed are highlighted.

encounters a duplicate state, the algorithm should save the version reached along the shortest path. This could be done by storing each state as a triple: (state, parent, length_of_path). When children are generated, the value of the path length is simply incremented by one and saved with the child. If a child is reached along multiple paths, this information can be used to retain the best version. This is treated in more detail in the discussion of *algorithm A* in Chapter 4. Note that retaining the best version of a state in a simple depth-first search does not guarantee that a goal will be reached along the shortest path.

Figure 3.17 gives a depth-first search of the 8-puzzle. As noted previously, the space is generated by the four “move blank” rules (up, down, left, and right). The numbers next to the states indicate the order in which they were considered, i.e., removed from open. States left on open when the goal is found are not shown. A depth bound of 5 was imposed on this search to keep it from getting lost deep in the space.

As with choosing between data- and goal-driven search for evaluating a graph, the choice of depth-first or breadth-first search depends on the specific problem being solved. Significant features include the importance of finding the shortest path to a goal, the branching of the state space, the available time and space resources, the average length of paths to a goal node, and whether we want all solutions or only the first solution. In making these decisions, there are advantages and disadvantages for each approach.

Breadth-First Because it always examines all the nodes at level n before proceeding to level $n + 1$, breadth-first search always finds the shortest path to a goal node. In a problem

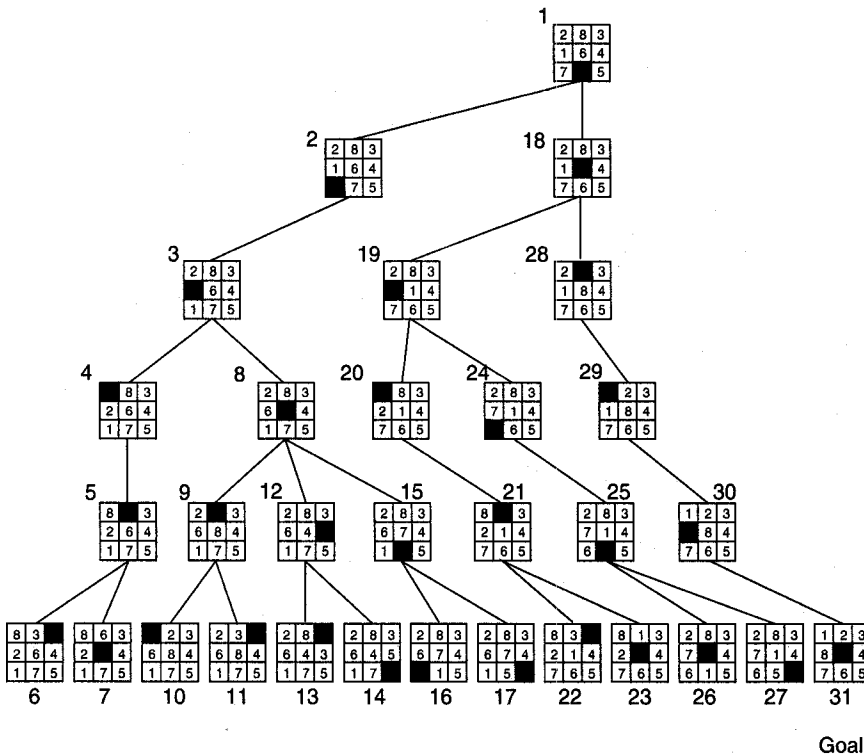

Figure 3.17 Depth-first search of the 8-puzzle with a depth bound of 5.

where it is known that a simple solution exists, this solution will be found. Unfortunately, if there is a bad branching factor, i.e., states have a high average number of descendants, the combinatorial explosion may prevent the algorithm from finding a solution using the available space. This is due to the fact that all unexpanded nodes for each level of the search must be kept on *open*. For deep searches, or state spaces with a high branching factor, this can become quite cumbersome.

The space utilization of breadth-first search, measured in terms of the number of states on *open*, is an exponential function of the length of the path at any time. If each state has an average of B children, the number of states on a given level is B times the number of states on the previous level. This gives B^n states on level n . Breadth-first search would place all of these on *open* when it begins examining level n . This can be prohibitive if solution paths are long.

Depth-First Depth-first search gets quickly into a deep search space. If it is known that the solution path will be long, depth-first search will not waste time searching a large number of “shallow” states in the graph. On the other hand, depth-first search can get “lost” deep in a graph, missing shorter paths to a goal or even becoming stuck in an infinitely long path that does not lead to a goal.

Depth-first search is much more efficient for search spaces with many branches because it does not have to keep all the nodes at a given level on the open list. The space usage of depth-first search is a linear function of the length of the path. At each level, open retains only the children of a single state. If a graph has an average of B children per state, this requires a total space usage of $B \times n$ states to go n levels deep into the space.

The best answer to the “depth-first versus breadth-first” issue is to examine the problem space carefully and consult experts in the area. In chess, for example, breadth-first search simply is not possible. In simpler games, breadth-first search not only may be possible but also may be the only way to avoid losing.

3.2.4 Depth-First Search with Iterative Deepening

A nice compromise on these trade-offs is to use a depth bound on depth-first search. The depth bound forces a failure on a search path once it gets below a certain level. This causes a breadth-like sweep of the search space at that depth level. When it is known that a solution lies within a certain depth or when time constraints, such as occur in an extremely large space like chess, limit the number of states that can be considered; then a depth-first search with a depth bound may be most appropriate. Figure 3.17 showed a depth-first search of the 8-puzzle in which a depth bound of 5 caused the sweep across the space at that depth.

This insight leads to a search algorithm that remedies many of the drawbacks of both depth-first and breadth-first search. *Depth-first iterative deepening* (Korf 1987) performs a depth-first search of the space with a depth bound of 1. If it fails to find a goal, it performs another depth-first search with a depth bound of 2. This continues, increasing the depth bound by one at each iteration. At each iteration, the algorithm performs a complete depth-first search to the current depth bound. No information about the state space is retained between iterations.

Because the algorithm searches the space in a level-by-level fashion, it is guaranteed to find a shortest path to a goal. Because it does only depth-first search at each iteration, the space usage at any level n is $B \times n$, where B is the average number of children of a node.

Interestingly, although it seems as if depth-first iterative deepening would be much less time efficient than either depth-first or breadth-first search, its time complexity is actually of the same order of magnitude as either of these: $O(B^n)$. An intuitive explanation for this seeming paradox is given by Korf (1987):

Since the number of nodes in a given level of the tree grows exponentially with depth, almost all the time is spent in the deepest level, even though shallower levels are generated an arithmetically increasing number of times.

Unfortunately, all the search strategies discussed in this chapter—depth-first, breadth-first, and depth-first iterative deepening—may be shown to have worst-case exponential time complexity. This is true for all *uninformed* search algorithms. The only approaches to search that reduce this complexity employ heuristics to guide search.

Best-first search is a search algorithm that is similar to the algorithms for depth- and breadth-first search just presented. However, best-first search orders the states on the open list, the current fringe of the search, according to some measure of their heuristic merit. At each iteration, it considers neither the deepest nor the shallowest but the “best” state. Best-first search is the main topic of Chapter 4.

3.3 Using the State Space to Represent Reasoning with the Predicate Calculus

3.3.1 State Space Description of a Logical System

When we defined state space graphs in Section 3.1, we noted that nodes must be distinguishable from one another, with each node representing some state of the solution process. Predicate calculus can be used as the formal specification language for making these distinctions as well as for mapping the nodes of a graph onto the state space. Furthermore, inference rules can be used to create and describe the arcs between states. In this fashion, problems in the predicate calculus, such as determining whether a particular expression is a logical consequence of a given set of assertions, may be solved using search.

The soundness and completeness of predicate calculus inference rules guarantee the correctness of conclusions derived through this form of graph-based reasoning. This ability to produce a formal proof of the integrity of a solution through the same algorithm that produces the solution is a unique attribute of much artificial intelligence and theorem proving based problem solving.

Although many problems (such as tic-tac-toe) may be more naturally described by other data structures (such as arrays), the power and generality of logical representation allow most AI problem solving to use predicate calculus descriptions and inference rules as just described. Other representations such as rules (Chapter 6), semantic networks, or frames (Chapter 8) employ similar search strategies and may also be understood using the graph search algorithms introduced in this chapter.

EXAMPLE 3.3.1

The first example of how a set of logical assertions may be viewed as defining a graph is from the propositional calculus. Assume the following set of assertions:

$q \Rightarrow p$
 $r \Rightarrow p$
 $v \Rightarrow q$
 $s \Rightarrow r$
 $t \Rightarrow r$
 $s \Rightarrow u$
 s
 t

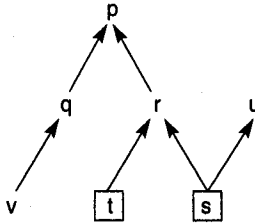

Figure 3.18 State space graph of a set of implications in the propositional calculus.



Figure 3.19 And/or graph of the expression $q \wedge r \Rightarrow p$.

From this set of assertions and the inference rule modus ponens, certain propositions (p , r , and u) may be inferred; others (such as v and q) may not be so inferred and indeed do not logically follow from these assertions. The relationship between the initial assertions and these inferences is expressed in the directed graph in Figure 3.18.

In Figure 3.18 the arcs correspond to logical implications (\Rightarrow). Propositions that are given as true (s and t) correspond to the given data of the problem. Propositions that are logical consequences of this set of assertions correspond to the nodes that may be reached along a directed path from a state representing a true proposition; such a path corresponds to a sequence of applications of modus ponens. For example, the path $[s, r, p]$ corresponds to the sequence of inferences:

s and $s \Rightarrow r$ yields r .
 r and $r \Rightarrow p$ yields p .

Given this representation, determining whether a given proposition is a logical consequence of a set of propositions becomes a problem of finding a path from a boxed node (the start node) to the proposition (the goal node). It has been cast as a graph search problem. The search strategy used here is data-driven, because it proceeds from what is known (the true propositions) toward the goal. Alternatively, a goal-directed strategy could be applied to the same state space by starting with the proposition to be proved (the goal) and searching back along arcs to find support for the goal among the true propositions. In addition, we can search this space of inferences in either a depth-first or breadth-first fashion.

3.3.2 And/Or Graphs

In Example 3.3.1, all of the assertions were simple implications of the form $p \Rightarrow q$. We did not discuss the way in which the logical operators **and** and **or** could be represented in such a graph. Expressing the logical relationships defined by these operators requires an extension to the basic graph model known as an *and/or graph*. And/or graphs are an important tool for describing the search spaces generated by many AI problems, including those solved by logical theorem provers and expert systems.

In expressions of the form $q \wedge r \Rightarrow p$, both q and r must be true for p to be true. In expressions of the form $q \vee r \Rightarrow p$, the truth of either q or r is sufficient to prove p is true. Because implications containing disjunctive premises may be written as separate implications, this expression is often written as $q \Rightarrow p, r \Rightarrow p$. To represent these different relationships graphically, and/or graphs distinguish between **and** nodes and **or** nodes. If the premises of an implication are connected by an \wedge operator, they are called **and** nodes in the graph and the arcs from this node are joined by a curved link. The expression $q \wedge r \Rightarrow p$ is represented by the and/or graph of Figure 3.19.

The link connecting the arcs in Figure 3.19 captures the idea that both q and r must be true to prove p . If the premises are connected by an **OR** operator, they are regarded as **OR** nodes in the graph. Arcs from **OR** nodes to their parent node are not so connected (Figure 3.20). This captures the notion that the truth of any one of the premises is independently sufficient to determine the truth of the conclusion.

An and/or graph is actually a specialization of a type of graph known as a *hypergraph*, which connects nodes by sets of arcs rather than by single arcs. A hypergraph is defined as follows:

DEFINITION

HYPERGRAPH

A hypergraph consists of:

N , a set of nodes.

H , a set of hyperarcs defined by ordered pairs in which the first element of the pair is a single node from N and the second element is a subset of N .

An ordinary graph is a special case of hypergraph in which all the sets of descendant nodes have a cardinality of 1.

Hyperarcs are also known as *k-connectors*, where k is the cardinality of the set of descendant nodes. If $k = 1$, the descendant may be thought of as an **OR** node. If $k > 1$, the elements of the set of descendants may be thought of as **and** nodes. In this case, the connector is drawn with individual edges from the parent node to each of the descendant nodes; these individual edges are then joined with a curved link as in the example above.

EXAMPLE 3.3.2

The second example is also from the propositional calculus but generates a graph that contains both **and** and **or** descendants. Assume a situation in the world where the following propositions are true:

a
b
c
 $a \wedge b \Rightarrow d$
 $a \wedge c \Rightarrow e$
 $b \wedge d \Rightarrow f$
 $f \Rightarrow g$
 $a \wedge e \Rightarrow h$

This set of assertions generates the and/or graph in Figure 3.21.

Questions that might be asked (answers deduced by the search of this graph) are:

1. Is **h** true?
2. Is **h** true if **b** is no longer true?
3. What is the shortest path (i.e., the shortest sequence of inferences) to show that **X** (some proposition) is true?
4. Show that the proposition **p** (note that **p** is not supported) is false. What does this mean? What would be necessary to achieve this conclusion?

And/or graph search requires only slightly more record keeping than search in regular graphs, an example of which was the **backtrack** algorithm, previously discussed. The **or** descendants are checked as they were in **backtrack**: once a path is found connecting a goal to a start node along **or** nodes, the problem will be solved. If a path leads to a failure, the algorithm may backtrack and try another branch. In searching **and** nodes, however, all of the **and** descendants of a node must be solved (or proved true) to solve the parent node.

In the example of Figure 3.21, a goal-directed strategy for determining the truth of **h** first attempts to prove both **a** and **e**. The truth of **a** is immediate, but the truth of **e** requires the truth of both **c** and **a**; these are given as true. Once the problem solver has traced all these arcs down to true propositions, the true values are recombined at the **and** nodes to verify the truth of **h**.

A data-directed strategy for determining the truth of **h**, on the other hand, begins with the known facts (**c**, **a**, and **b**) and begins adding new propositions to this set of known facts according to the constraints of the and/or graph. **e** or **d** might be the first proposition added to the set of facts. These additions make it possible to infer new facts. This process continues until the desired goal, **h**, has been proved.

One way of looking at and/or graph search is that the \wedge operator (hence the **and** nodes of the graph) indicates a problem decomposition in which the problem is broken into subproblems such that all of the subproblems must be solved to solve the original

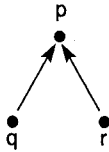

Figure 3.20 And/or graph of the expression $q \vee r \Rightarrow p$.

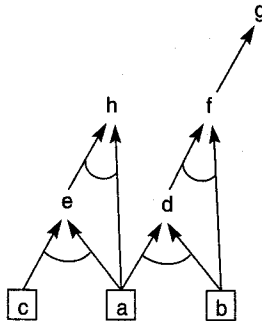

Figure 3.21 And/or graph of a set of propositional calculus expressions.

problem. An \vee operator in the predicate calculus representation of the problem indicates a selection, a point at which a choice may be made between alternative problem-solving strategies, any of which, if successful, is sufficient to solve the problem.

3.3.3 Further Examples and Applications

EXAMPLE 3.3.3

One natural example of an and/or graph is a program for symbolically integrating mathematical functions. MACSYMA is a well-known program that is used extensively by mathematicians. The reasoning of MACSYMA can be represented as an and/or graph. In performing integrations, one important class of strategies involves breaking an expression into sub-expressions that may be integrated independently of one another, with the result being combined algebraically into a solution expression. Examples of this strategy include the rule for integration by parts and the rule for decomposing the integral of a sum into the sum of the integrals of the individual terms. These strategies, representing the decomposition of a problem into independent subproblems, can be represented by and nodes in the graph.

Another class of strategies involves the simplification of an expression through various algebraic substitutions. Because any given expression may allow a number of

different substitutions, each representing an independent solution strategy, these strategies are represented by or nodes of the graph. Figure 3.22 illustrates the space searched by such a problem solver. The search of this graph is goal-directed, in that it begins with the query “find the integral of ???” and searches back to the algebraic expressions that define that integral. Note that this is an example in which goal-directed search is the obvious strategy. It would be practically impossible for a problem solver to determine the algebraic expressions that formed the desired integral without working back from the query.

EXAMPLE 3.3.4

This example is taken from the predicate calculus and represents a goal-driven graph search where the goal to be proved true is a predicate calculus expression, often containing variables. The axioms are the logical descriptions of a relationship between a dog, Fred, and his master, Sam.

The facts and rules of this example are given as English sentences followed by their predicate calculus equivalents:

1. Fred is a collie.
collie(fred).
2. Sam is Fred's master.
master(fred,sam).
3. It is Saturday.
day(saturday).
4. It is cold on Saturday.
 \neg (warm(saturday)).
5. Fred is a trained dog.
trained(fred).
6. Spaniels or collies that are trained are good dogs.
 $\forall X[\text{spaniel}(X) \vee (\text{collie}(X) \wedge \text{trained}(X)) \Rightarrow \text{gooddog}(X)]$
7. If a dog is a good dog and has a master then he will be with his master.
 $\forall (X,Y,Z) [\text{gooddog}(X) \wedge \text{master}(X,Y) \wedge \text{location}(Y,Z) \Rightarrow \text{location}(X,Z)]$
8. If it is Saturday and warm, then Sam is at the park.
 $\text{day}(\text{saturday}) \wedge \text{warm}(\text{saturday}) \Rightarrow \text{location}(\text{sam},\text{park})$.
9. If it is Saturday and not warm, then Sam is at the museum.
 $\text{day}(\text{saturday}) \wedge \neg (\text{warm}(\text{saturday})) \Rightarrow \text{location}(\text{sam},\text{museum})$.

The goal is the expression $\exists X \text{location}(\text{fred},X)$, meaning “where is fred?” A backward search algorithm examines alternative means of establishing this goal: “if fred is a good dog and fred has a master and fred's master is at a location then fred is at that location also.” The premises of this rule are then examined: what does it mean to be a “good dog,” etc.? This process continues, constructing the and/or graph of Figure 3.23.

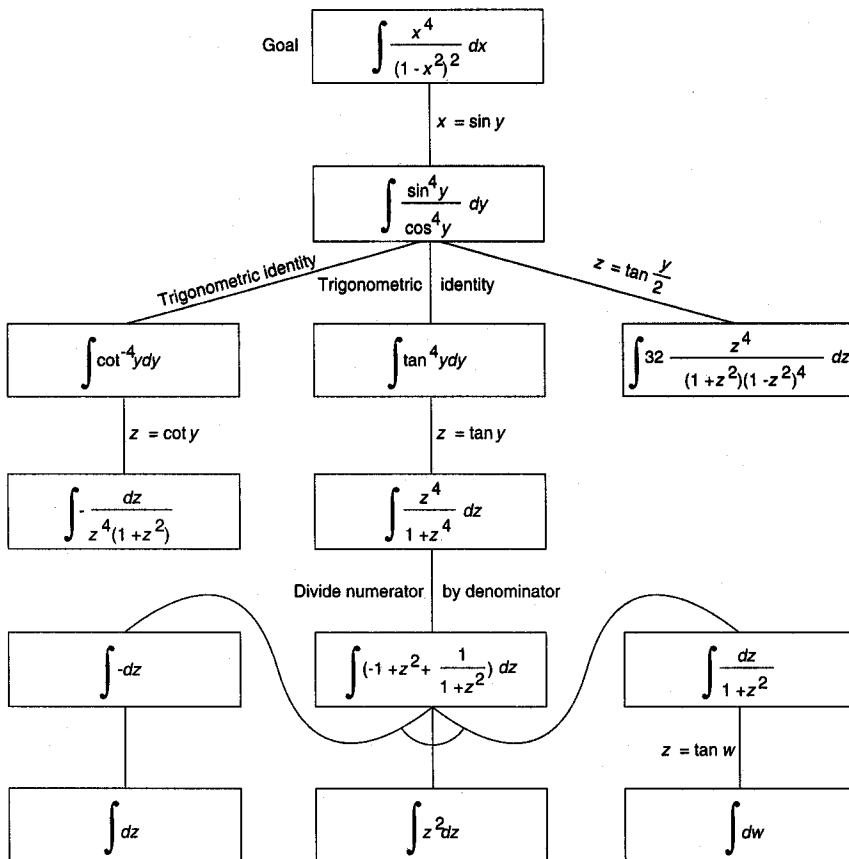

Figure 3.22 And/or graph representing part of the state space for integrating a function.

Let us examine the search of Example 3.3.4 in more detail, particularly because it is the first example of goal-driven search using the predicate calculus and it illustrates the role of unification in the generation of the search space. The problem to be solved is “where is fred?” More formally, it may be seen as determining a substitution for the variable X, if such a substitution exists, under which $\text{location}(\text{fred}, X)$ is a logical consequence of the initial assertions.

When it is desired to determine Fred’s location, clauses are examined that have location as their conclusion. The first of these is clause 7. This conclusion, $\text{location}(P, Q)$, is then unified with $\text{location}(\text{fred}, X)$ by the substitutions $\{\text{fred}/P, X/Q\}$. The premises of this rule, under the same substitution set, form the and descendants of the top goal in the graph:

$$\text{gooddog}(\text{fred}) \wedge \text{master}(\text{fred}, Y) \wedge \text{location}(Y, Z).$$

This expression may be interpreted as meaning that one way to find Fred is to see if Fred is a good dog, find out who Fred's master is, and find out where the master is. The initial goal has thus been replaced by three subgoals. These are and nodes and all of them must be solved.

To solve these subgoals, the problem solver first determines whether Fred is a good dog. This matches the conclusion of clause 6. The premise of clause 6 is the or of two expressions:

$$\forall X \text{spaniel}(X) \vee (\text{collie}(X) \wedge \text{trained}(X))$$

The first of these or nodes is $\text{spaniel}(X)$. The database does not contain this assertion, so the problem solver must assume it is false. The other or node is $(\text{collie}(X) \wedge \text{trained}(X))$, i.e., is Fred a collie and is Fred trained. Both of these need to be true, which they are by clauses 1 and 5.

This proves that $\text{gooddog}(\text{fred})$ is true. The problem solver then examines the second of the premises of clause 7: $\text{master}(X,Y)$. Under the substitution $\{\text{fred}/X\}$, this becomes $\text{master}(\text{fred},Y)$, which unifies with the fact (clause 2) of $\text{master}(\text{fred},\text{sam})$. This produces the unifying substitution of $\{\text{sam}/Y\}$, which also gives the value of sam to the third subgoal of clause 7, creating the new goal $\text{location}(\text{sam},Z)$.

In solving this, assuming the problem solver tries rules in order, the goal $\text{location}(\text{sam},Z)$ will first unify with the conclusion of clause 7. Note that the same rule is being tried with different bindings for X. Recall (Chapter 2) that X is a "dummy" variable and could have any name (any string beginning with an uppercase letter). Because the extent of the meaning of any variable name is contained within the clause in which it appears, the predicate calculus has no global variables. Another way of saying this is that values of variables are passed to other clauses as parameters and have no fixed (memory) locations. Thus, the multiple occurrences of X in different rules in this example indicate *different* formal parameters (Section 12.3).

In attempting to solve the premises of rule 7 with these new bindings, the problem solver will fail because sam is not a gooddog. Here, the search will backtrack to the goal $\text{location}(\text{sam},Z)$ and try the next match, the conclusion of rule 8. This will also fail, causing another backtrack and a unification with the conclusion of clause 9, $\text{at}(\text{sam},\text{museum})$.

Because the premises of clause 9 are supported in the set of assertions (clauses 3 and 4), it follows that the conclusion of clause 9 may be taken as true. This final unification goes all the way back up the tree to finally answer $\text{location}(\text{fred},X)?$ with $\text{location}(\text{fred},\text{museum})$.

It is important to examine carefully the nature of the goal-driven search of a graph and compare it with the data-driven search of Example 3.3.2. Further discussion of this issue, including a more rigorous comparison of these two methods of searching a graph, continues in the next example, but is seen in full detail only in the discussion of production systems in Chapter 5 and in the application to expert systems in Part IV. Another point implicit in this example is that the order of clauses affects the order of search. In the example above, the multiple location clauses were tried in order, with backtracking search eliminating those that failed to be proved true.

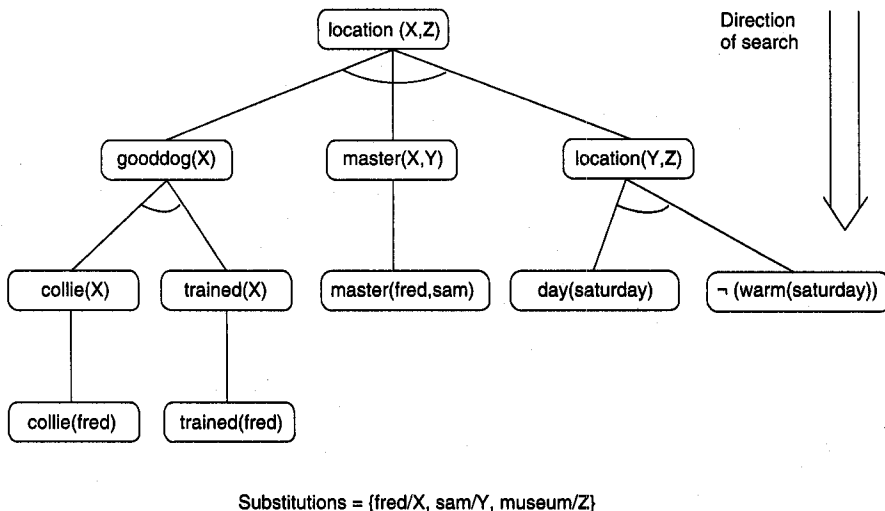

Figure 3.23 And/or graph showing fred is at the museum.

EXAMPLE 3.3.5

In the last example of Chapter 2 we used predicate calculus to represent a set of rules for giving investment advice. In that example, modus ponens was used to infer a proper investment for a particular individual. We did not discuss the way in which a program might determine the appropriate inferences. This is, of course, a search problem; the present example illustrates one approach to implementing the logic-based financial advisor, using goal-directed, depth-first search with backtracking. The discussion uses the predicates found in Section 2.4; these predicates are not duplicated here.

Assume that the individual has two dependents, \$20,000 in savings, and a steady income of \$30,000. As discussed in Chapter 2, we can add predicate calculus expressions describing these facts to the set of predicate calculus expressions. Alternatively, the program may begin the search without this information and ask the user to add it as needed. This has the advantage of not requiring data that may not prove necessary for a solution. This approach, often taken in expert systems, is illustrated in this example.

In performing a consultation, the goal is to find an investment; this is represented as the predicate calculus expression $investment(X)$. Note the use of the unbound variable X in the goal. This goal is also referred to as a *query*. There are three rules (1, 2, and 3) that conclude about investments, because the query will unify with the conclusion of these rules. If we select rule 1 for initial exploration, its premise $savings_account(inadequate)$ becomes the subgoal, i.e., the child node that will be expanded next.

In generating the children of $savings_account(inadequate)$, the only rule that may be applied is rule 5. This produces the and node:

$$amount_saved(X) \wedge dependents(Y) \wedge \neg greater(X, minsavings(Y))$$

If we attempt to satisfy these in left-to-right order, `amount_saved(X)` is taken as the first subgoal. Because the system contains no rules that conclude this subgoal, it will query the user. When `amount_saved(20000)` is added the first subgoal will succeed, with unification substituting 20000 for X. Note that because an `and` node is being searched, a failure here would eliminate the need to examine the remainder of the expression.

Similarly, the subgoal `dependents(Y)` leads to a user query, and the response, `dependents(2)`, is added to the logical description. The subgoal matches this expression with the substitution $\{2/Y\}$. The search will then evaluate the truth of

$\neg \text{greater}(X, \text{minsavings}(Y)).$

This evaluates to false, causing failure of the entire `and` node. The search then backtracks to the parent node, `savings_account(inadequate)`, and attempts to find an alternative way to prove that node true. This corresponds to the generation of the next child in the search. Because no other rules conclude this subgoal, search fails back to the top-level goal, `investment(X)`. The next rule whose conclusions unify with this goal is rule 2, producing the new subgoals

$\text{savings_account(adequate)} \wedge \text{income(adequate)}.$

Continuing the search, `savings_account(adequate)` is proved true as the conclusion of rule 4, and `income(adequate)` follows as the conclusion of rule 6. Although the details of the remainder of the search will be left to the reader, the `and/or` graph that is ultimately searched appears in Figure 3.24.

EXAMPLE 3.3.6

The final example is not from the predicate calculus but consists of a set of rewrite rules for parsing sentences in a subset of English grammar. Rewrite rules take an expression and transform it into another by replacing the pattern on one side of the arrow (\leftrightarrow) with the pattern on the other side. For example, a set of rewrite rules could be defined to change an expression in one language, such as English, into another language (perhaps French or a predicate calculus clause). The rewrite rules given here transform a subset of English sentences into higher level grammatical constructs such as noun phrase, verb phrase, and sentence. These rules are used to *parse* sequences of words, i.e., to determine whether they are well-formed sentences (are grammatically correct or not) and to model the linguistic structure of the sentences.

Five rules for a simple subset of English grammar are:

1. A sentence is a noun phrase followed by a verb phrase.
 $\text{sentence} \leftrightarrow \text{np vp}$
2. A noun phrase is a noun.
 $\text{np} \leftrightarrow \text{n}$

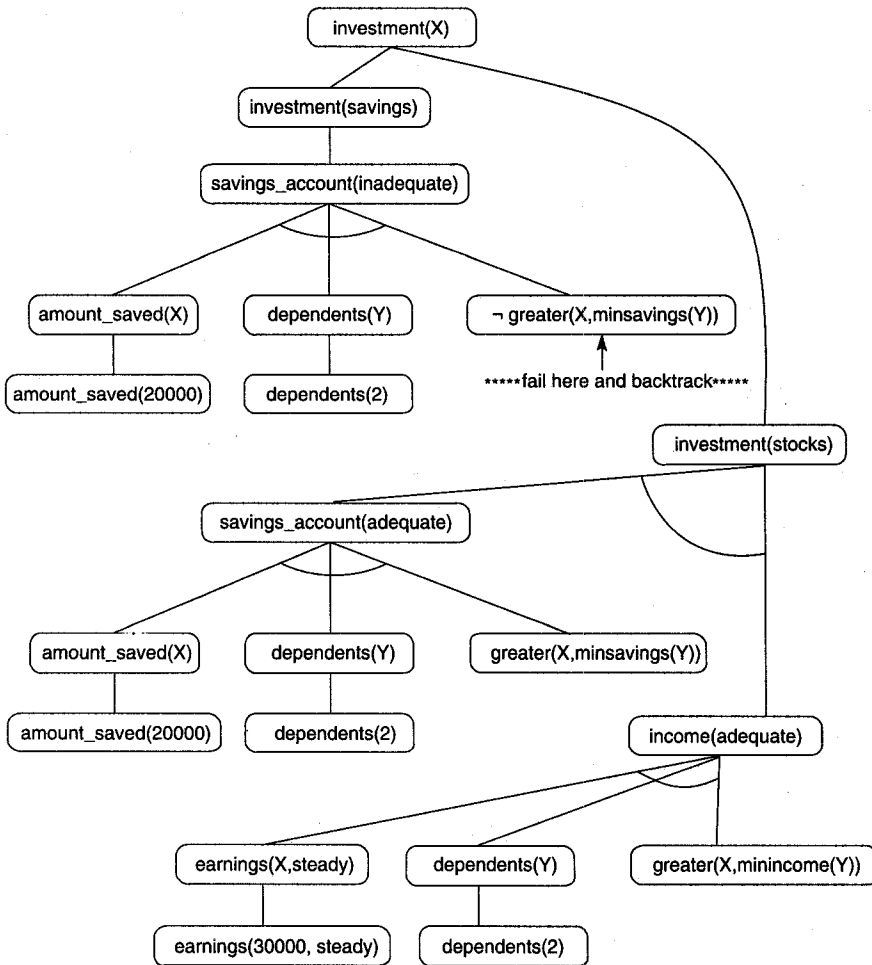

Figure 3.24 And/or graph searched by the financial advisor.

3. A noun phrase is an article followed by a noun.
 $np \leftrightarrow art\ n$
4. A verb phrase is a verb.
 $vp \leftrightarrow v$
5. A verb phrase is a verb followed by a noun phrase.
 $vp \leftrightarrow v\ np$

In addition to these grammar rules, a parser needs a dictionary of words in the language. These words are called the *terminals* of the grammar. They are defined by their parts of speech using rewrite rules. In the following “dictionary,” “a,” “the,” “man,” “dog,” “likes,” and “bites” are the terminals of our simple grammar:

6. art \leftrightarrow a
7. art \leftrightarrow the
("a" and "the" are articles)
8. n \leftrightarrow man
9. n \leftrightarrow dog
("man" and "dog" are nouns)
10. v \leftrightarrow likes
11. v \leftrightarrow bites
("likes" and "bites" are verbs)

These rewrite rules define the and/or graph of Figure 3.25. **sentence** is the root. The elements on the left of a rewrite rule correspond to **and** nodes in the graph. Multiple rules with the same conclusion form the **OR** nodes. Notice that the leaf or terminal nodes of this graph are the English words in the grammar (hence, they are called *terminals*).

An expression is *well formed* in a grammar if it consists entirely of terminal symbols and there is a series of substitutions in the expression using rewrite rules that reduce it to the **sentence** symbol. Alternatively, this may be seen as constructing a *parse tree* that has the words of the expression as its leaves and the **sentence** symbol as its root.

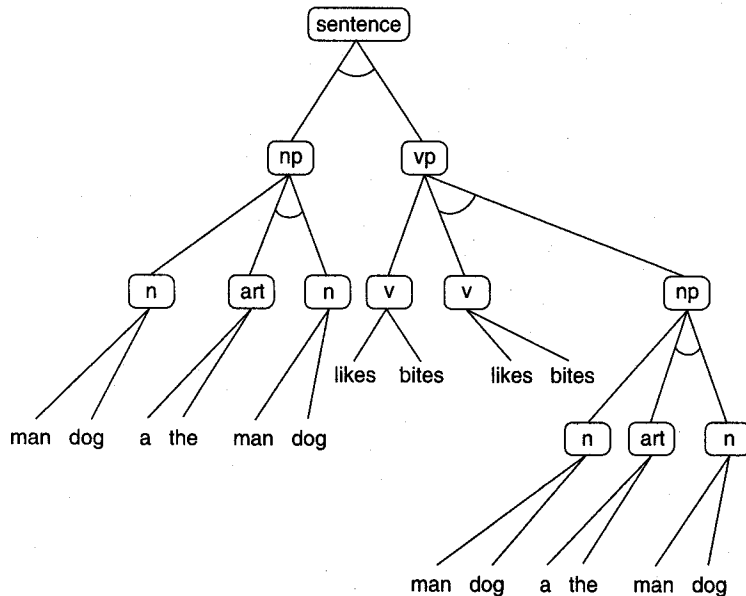

Figure 3.25 And/or graph for the grammar of Example 3.3.6. Some of the nodes (np, art, etc.) have been written more than once to simplify drawing the graph.

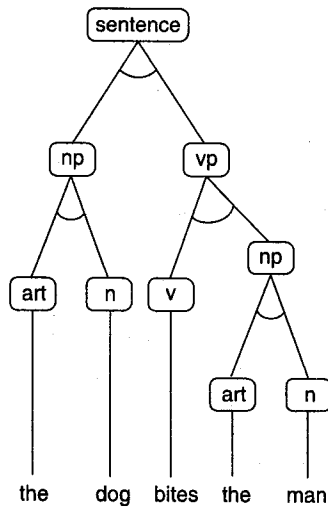

Figure 3.26 Parse tree for the sentence “The dog bites the man.”
 Note that this is a subtree of the graph of Figure 3.25.

For example, we may parse the sentence **the dog bites the man**, constructing the parse tree of Figure 3.26. This tree is a subtree of the and/or graph of Figure 3.25 and is constructed by searching this graph. A *data-driven parsing* algorithm would implement this by matching right-hand sides of rewrite rules with patterns in the sentence, trying these matches in the order in which the rules are written. Once a match is found, the part of the expression matching the right-hand side of the rule is replaced by the pattern on the left-hand side. This continues until the sentence is reduced to the symbol **sentence** (indicating a successful parse) or no more rules can be applied (indicating failure). A trace of the parse of **the dog bites the man** is:

1. The first rule that will match is 7, rewriting **the** as **art**. This yields: **art dog bites the man**.
2. The next iteration would find a match for 7, yielding **art dog bites art man**.
3. Rule 8 will fire, producing **art dog bites art n**.
4. Rule 3 will fire to yield **art dog bites np**.
5. Rule 9 produces **art n bites np**.
6. Rule 3 may be applied, giving **np bites np**.
7. Rule 11 yields **np v np**.
8. Rule 5 yields **np vp**.
9. Rule 1 reduces this to **sentence**, accepting the expression as correct.

The above example implements a data-directed depth-first parse, as it always applies the highest-level rule to the expression; e.g., *art n* reduces to *np* before *bites* reduces to *v*. Parsing could also be done in a goal-directed fashion, taking *sentence* as the starting string and finding a series of replacements of patterns that match left-hand sides of rules leading to a series of terminals that match the target sentence.

Parsing is important, not only for natural language (Chapter 11) but also for constructing compilers and interpreters for computer languages (Aho and Ullman 1977). The literature is full of parsing algorithms for all classes of languages. These use various techniques to manage the combinatorics of complex grammars. For example, many goal-directed parsing algorithms look ahead in the input stream to determine which rule to apply next.

In this example we have taken a very simple approach of searching the and/or graph in an uninformed fashion. One thing that is interesting in this example is the implementation of the search. This approach of keeping a record of the current expression and trying to match the rules in order is an example of using the *production system* to implement search. This is a major topic of Chapter 5.

Rewrite rules are also used to generate legal sentences according to the specifications of the grammar. Sentences may be generated by a goal-driven search, beginning with *sentence* as the top-level goal and ending when no more rules can be applied. This produces a string of terminal symbols that is a legal sentence in the grammar. For example:

A sentence is a *np* followed by a *vp* (rule 1).

np is replaced by *n* (rule 2), giving *n vp*.

man is the first *n* available (rule 8), giving *man vp*.

Now *np* is satisfied and *vp* is attempted. Rule 3 replaces *vp* with *v*, *man v*.

Rule 10 replaces *v* with *likes*.

man likes is found as the first acceptable sentence.

If it is desired to create all acceptable sentences, this search may be systematically repeated until all possibilities are tried and the entire state space has been searched exhaustively. This generates sentences including *a man likes*, *the man likes*, and so on. There are 84 correct sentences that are produced by an exhaustive search. These include such semantic anomalies as *the man bites the dog*.

Parsing and generation can be used together in a variety of ways to handle different problems. For instance, if it is desired to find all sentences to complete the string "the man," then the problem solver may be given an incomplete string *the man...* It can work upward in a data-driven fashion to produce the goal of completing the sentence rule (rule 1), where *np* is replaced by *the man*, and then work in a goal-driven fashion to determine all possible *vps* that will complete the sentence. This would create sentences such as *the man likes*, *the man bites the man*, and so on. Again, this example deals only with syntactic correctness. The issue of semantics (whether the string has a mapping into some "world" with "truth") is entirely different. Chapter 2 examined the issue of constructing a semantics for expressions in formal logic; for expressions in natural language, the issue is much more difficult and is discussed in Chapters 8 and 12.

This last example illustrates the extreme flexibility with which state spaces may be searched. In the next chapter we discuss the use of heuristics to focus search on the smallest possible portion of the state space. Chapter 5 discusses the production system, a formalism for controlling the application of problem-solving rules and other techniques for implementing search in a variety of problems and representation languages.

3.4 Epilogue and References

Chapter 3 introduced the theoretical foundations of state space search, using graph theory to analyze the structure and complexity of problem-solving strategies. In reviewing the basics of graph theory, we showed how it may be used to model problem solving as a search through a graph of problem states. The chapter compared data-driven and goal-driven reasoning and depth-first and breadth-first search.

And/or graphs allow us to apply state space search to the implementation of logical reasoning. The search strategies of Chapter 3 were demonstrated on a number of examples, including the financial advisor introduced in Chapter 2.

Basic graph search is discussed in a number of textbooks on computer algorithms. These include *Introduction to Algorithms* by Thomas Cormen, Charles Leiserson, and Ronald Rivest (1990), *Walls and Mirrors* by Paul Helman and Robert Veroff (1986), *Algorithms* by Robert Sedgewick (1983), and *Fundamentals of Computer Algorithms* by Ellis Horowitz and Sartaj Sahni (1978). More complete algorithms for and/or graph search are presented in Chapter 12, "Automated Reasoning," and are built in the PROLOG and LISP chapters.

The use of graph search to model intelligent problem solving is presented in *Human Problem Solving* by Alan Newell and Herbert Simon (1972). Artificial intelligence texts that discuss search strategies include Nils Nilsson's *Principles of Artificial Intelligence* (1980), Patrick Winston's *Artificial Intelligence* (1992), and *Artificial Intelligence* by Eugene Charniak and Drew McDermott (1985). *Heuristics* by Judea Pearl (1984) presents search algorithms and lays a groundwork for the material we present in Chapter 4. Alternative perspectives on search may be found in Rich and Knight (1991).

3.5 Exercises

1. A Hamiltonian path is a path that uses every node of the graph exactly once. What conditions are necessary for such a path to exist? Is there such a path in the Königsberg map?
2. Give the graph representation for the farmer, wolf, goat, and cabbage problem of Section 9.3 (see Figures 9.1 and 9.2). Let the nodes represent states of the world; e.g., the farmer and the goat are on the west bank and the wolf and cabbage on the east. Discuss the advantages of breadth-first and depth-first for searching this space.
3. Give an instance of the traveling salesperson problem for which the nearest-neighbor strategy fails to find an optimal path. Suggest another heuristic for this problem.

4. "Hand run" the backtrack algorithm on the graph in Figure 3.27. Begin from state A. Keep track of the successive values of NSL, SL, CS, etc.
5. Implement a backtrack algorithm in a programming language of your choice.
6. Determine whether goal-driven or data-driven search would be preferable for solving each of the following problems. Justify your answer.
 - a. Diagnosing mechanical problems in an automobile.
 - b. You have met a person who claims to be your distant cousin, with a common ancestor named John Doe. You would like to verify her claim.
 - c. Another person claims to be your distant cousin. He does not know the common ancestor's name but knows that it was no more than eight generations back. You would like to either find this ancestor or determine that she did not exist.
 - d. A theorem prover for plane geometry.
 - e. A program for examining sonar readings and interpreting them, such as telling a large submarine from a small submarine from a whale from a school of fish.
 - f. An expert system that will help a human classify plants by species, genus, etc.
7. Choose and justify a choice of breadth- or depth-first search for examples of Exercise 6.
8. Write a backtrack algorithm for and/or graphs.
9. Trace the good-dog problem of Example 3.3.4 in a data-driven fashion.
10. Give another example of an and/or graph search problem and develop part of the search space.
11. Trace a data-driven execution of the financial advisor of Example 3.3.5 for the case of an individual with four dependents, \$18,000 in the bank, and a steady income of \$25,000 per year. Based on a comparison of this problem and the example in the text, suggest a generally "best" strategy for solving the problem.
12. Add rules defining adjectives and adverbs to the grammar of Example 3.3.6.
13. Add rules for (multiple) prepositional phrases to Example 3.3.6.
14. Add grammar rules to Example 3.3.6 that allows complex sentences, such as, sentence \leftrightarrow sentence ?? sentence.

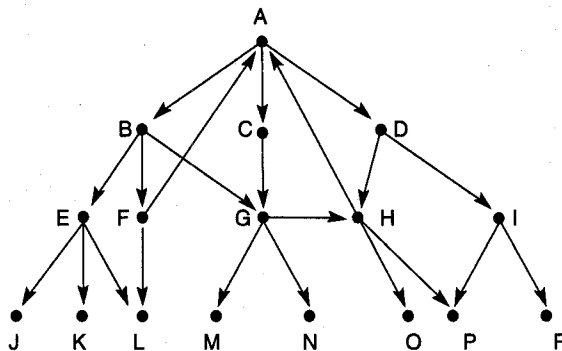

Figure 3.27 A graph to be searched.

4

HEURISTIC SEARCH

The task that a symbol system is faced with, then, when it is presented with a problem and a problem space, is to use its limited processing resources to generate possible solutions, one after another, until it finds one that satisfies the problem defining test. If the symbol system had some control over the order in which potential solutions were generated, then it would be desirable to arrange this order of generation so that actual solutions would have a high likelihood of appearing early. A symbol system would exhibit intelligence to the extent that it succeeded in doing this. Intelligence for a system with limited processing resources consists in making wise choices of what to do next. . . .

—NEWELL AND SIMON, 1976 Turing Award Lecture

*I been searchin' . . .
Searchin' . . . Oh yeah
Searchin' every which-a-way . . .*

—LIEBER AND STOLLER

4.0 Introduction

George Polya defines *heuristic* as “the study of the methods and rules of discovery and invention” (Polya 1945). This meaning can be traced to the term’s Greek root, the verb *eurisco*, which means “I discover.” When Archimedes emerged from his famous bath clutching the golden crown, he shouted “Eureka!” meaning “I have found it!”. In state space search, *heuristics* are formalized as rules for choosing those branches in a state space that are most likely to lead to an acceptable problem solution.

AI problem solvers employ heuristics in two basic situations:

1. A problem may not have an exact solution because of inherent ambiguities in the problem statement or available data. Medical diagnosis is an example of this. A given set of symptoms may have several possible causes; doctors use heuristics to

choose the most likely diagnosis and formulate a plan of treatment. Vision is another example of an inherently inexact problem. Visual scenes are often ambiguous, allowing multiple interpretations of the connectedness, extent, and orientation of objects. Optical illusions exemplify these ambiguities. Vision systems use heuristics to select the most likely of several possible interpretations of a given scene.

2. A problem may have an exact solution, but the computational cost of finding it may be prohibitive. In many problems (such as chess), state space growth is combinatorially explosive, with the number of possible states increasing exponentially or factorially with the depth of the search. In these cases, exhaustive, *brute-force* search techniques such as depth-first or breadth-first search may fail to find a solution within any practical length of time. Heuristics attack this complexity by guiding the search along the most “promising” path through the space. By eliminating unpromising states and their descendants from consideration, a heuristic algorithm can (its designer hopes) defeat this combinatorial explosion and find an acceptable solution.

Unfortunately, like all rules of discovery and invention, heuristics are fallible. A heuristic is only an informed guess of the next step to be taken in solving a problem. It is often based on experience or intuition. Because heuristics use limited information, such as the descriptions of the states currently on the open list, they are seldom able to predict the exact behavior of the state space farther along in the search. A heuristic can lead a search algorithm to a suboptimal solution or fail to find any solution at all. This is an inherent limitation of heuristic search. It cannot be eliminated by “better” heuristics or more efficient search algorithms (Garey and Johnson 1979).

Heuristics and the design of algorithms to implement heuristic search have long been a core concern of artificial intelligence research. Game playing and theorem proving are two of the oldest applications in artificial intelligence; both of these require heuristics to prune spaces of possible solutions. It is not feasible to examine every inference that can be made in a mathematics domain or every possible move that can be made on a chessboard. Heuristic search is often the only practical answer.

More recently, expert systems research has affirmed the importance of heuristics as an essential component of problem solving. When a human expert solves a problem, he or she examines the available information and makes a decision. The “rules of thumb” that a human expert uses to solve problems efficiently are largely heuristic in nature. These heuristics are extracted and formalized by expert systems designers.

It is useful to think of heuristic algorithms as consisting of two parts: the heuristic measure and an algorithm that uses it to search the state space. In Section 4.1.1 we present an algorithm for heuristic or *best-first* search. The design and evaluation of effective heuristics are covered in the remainder of the chapter.

Consider the game of tic-tac-toe, Figure II.5. The combinatorics for exhaustive search are high but not insurmountable. Each of the nine first moves has eight possible responses, which in turn have seven continuing moves, and so on. A simple analysis puts the total number of states that need to be considered in an exhaustive search at $9 \times 8 \times 7 \times 6 \dots$ or $9!$

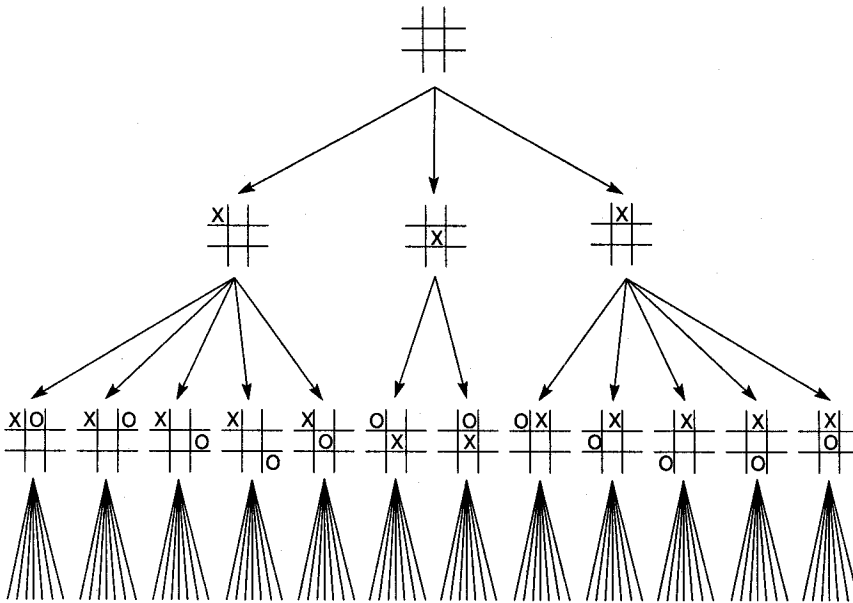

Figure 4.1 First three levels of the tic-tac-toe state space reduced by symmetry.

Symmetry reduction can decrease the search space a little. Many problem configurations may be actually equivalent under symmetric operations on the game board. For example, there are really only three initial moves: to a corner, to the center of a side, and to the center of the grid. Symmetry reductions on the second level of states further reduce the number of possible paths through the space to a total of $12 \times 7!$ This reduced space is seen in Figure 4.1. It is smaller than the original space but is still factorial in its growth.

A simple heuristic, however, can almost eliminate search entirely: we may move to the board in which X has the most winning lines. (The first three states in the tic-tac-toe game are so measured in Figure 4.2.) In case of states with equal numbers of potential wins, take the first such state found. The algorithm then selects and moves to the state with the highest heuristic value. In this case X takes the center of the grid. Note that not only are the other alternatives eliminated, but so are all their descendants. Two-thirds of the space is pruned away with the first move, Figure 4.3.

After the first move, the opponent can choose either of two alternative moves (as seen in Figure 4.3). Whichever is chosen, the heuristic can be applied to the resulting state of the game, again using the “most winning lines” heuristic to select among the possible moves. As search continues, each move evaluates the children of a single node; exhaustive search is not required. Figure 4.3 shows the reduced search after three steps in the game. States are marked with their heuristic values.

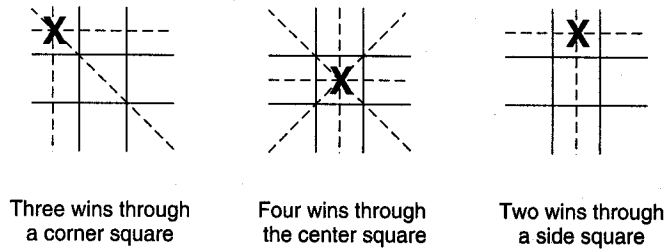

Figure 4.2 The “most wins” heuristic applied to the first children in tic-tac-toe.

Although it is difficult to compute the exact number of states that must be so examined, a crude upper bound can be computed by assuming a maximum of nine moves in a game and eight children per move. In reality, the number of states will be much smaller, as the board fills and reduces our options. In addition, our opponent is

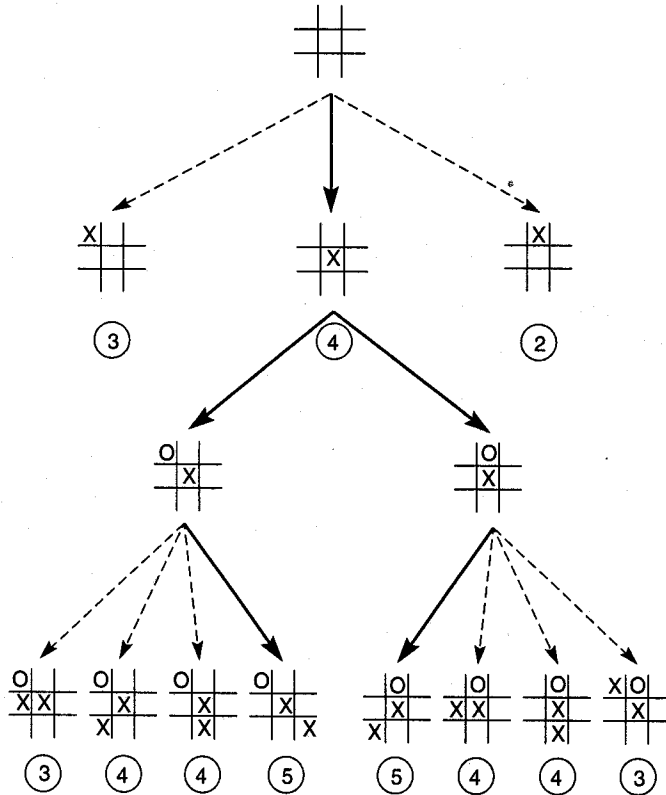

Figure 4.3 Heuristically reduced state space for tic-tac-toe.

responsible for half the moves. Nonetheless, even this crude upper bound of 8×9 or 72 states is an improvement of four orders of magnitude over 9!

The next section (4.1) presents an algorithm for implementing heuristic search and demonstrates its performance using various heuristics to solve the 8-puzzle. In Section 4.2 we discuss some theoretical issues related to heuristic search, such as *admissibility* and *monotonicity*. Section 4.3 examines the use of *minimax* and *alpha-beta pruning* to apply heuristics to multiple-person games. The final section examines the complexity of heuristic search and reemphasizes its essential role in intelligent problem solving.

4.1 An Algorithm for Heuristic Search

4.1.1 Implementing “Best-First” Search

The simplest way to implement heuristic search is through a procedure called *hill climbing* (Pearl 1984). Hill-climbing strategies expand the current state in the search and evaluate its children. The best child is selected for further expansion; neither its siblings nor its parent are retained. Search halts when it reaches a state that is better than any of its children. Hill climbing is named for the strategy that might be used by an eager, but blind mountain climber: go uphill along the steepest possible path until you can go no farther. Because it keeps no history, the algorithm cannot recover from failures of its strategy.

A major problem of hill-climbing strategies is their tendency to become stuck at local maxima. If they reach a state that has a better evaluation than any of its children, the algorithm halts. If this state is not a goal, but just a local maximum, the algorithm fails to find a solution. That is, performance might well improve in a limited setting, but because of the shape of the entire space, it may never reach the overall best. An example of local maxima in games occurs in the 8-puzzle. Very often, in order to move a particular tile to its destination, other tiles that are already in goal position have to be moved. This is necessary to solve the puzzle but temporarily worsens the board state. Because “better” need not be “best” in an absolute sense, hill-climbing methods are unable to distinguish between local and global maxima. There are various approaches to getting around this problem, such as randomly perturbing the evaluation function to break out of local maxima, but in general there is no way of guaranteeing optimal performance with hill-climbing techniques. We give an example of hill climbing with Samuel’s checker-playing program in Section 4.3.2.

In spite of its limitations, hill climbing can be used effectively if the evaluation function is sufficiently informative to avoid local maxima and infinite paths. In general, however, heuristic search requires a more informed algorithm: this is provided by *best-first search*.

Like the depth-first and breadth-first search algorithms of Chapter 3, best-first search uses lists to maintain states: *open* to keep track of the current fringe of the search and *closed* to record states already visited. An added step in the algorithm orders the states on *open* according to some heuristic estimate of their “closeness” to a goal. Thus, each

iteration of the loop considers the most “promising” state on the open list. The pseudo-code for best-first search appears below.

```

procedure best_first_search;

begin
  open := [Start];                                % initialize
  closed := [];
  while open ≠ [] do                               % states remain
  begin
    remove the leftmost state from open, call it X;
    if X = goal then return the path from Start to X
    else begin
      generate children of X;
      for each child of X do
      case
        the child is not on open or closed:
          begin
            assign the child a heuristic value;
            add the child to open
          end;
        the child is already on open:
          if the child was reached by a shorter path
          then give the state on open the shorter path
        the child is already on closed:
          if the child was reached by a shorter path then
          begin
            remove the state from closed;
            add the child to open
          end;
      end;                                       % case
      put X on closed;
      re-order states on open by heuristic merit (best leftmost)
    end;
  return failure                                  % open is empty
end.

```

At each iteration, `best_first_search` removes the first element from the open list. If it meets the goal conditions, the algorithm returns the solution path that led to the goal. Note that each state retains ancestor information to determine if it had previously been reached by a shorter path and to allow the algorithm to return the final solution path. (See Section 3.2.3.).

If the first element on `open` is not a goal, the algorithm applies all matching production rules or operators to generate its descendants. If a child state is already on `open` or `closed`, the algorithm checks to make sure that the state records the shorter of the two partial solution paths. Duplicate states are not retained. By updating the ancestor history of nodes on `open` and `closed` when they are rediscovered, the algorithm is more likely to find a shorter path to a goal.

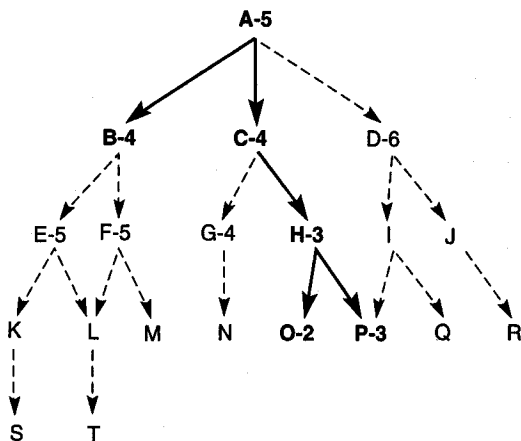

Figure 4.4 Heuristic search of a hypothetical state space.

`best_first_search` then applies a heuristic evaluation to the states on `open`, and the list is sorted according to the heuristic values of those states. This brings the “best” states to the front of `open`. Note that because these estimates are heuristic in nature, the next state to be examined may be from any level of the state space. When `open`, is maintained as a sorted list, is often referred to as a *priority queue*.

Figure 4.4 shows a hypothetical state space with heuristic evaluations attached to some of its states. The states with attached evaluations are those actually generated in `best_first_search`. The states expanded by the heuristic search algorithm are indicated in bold; note that it does not search all of the space. The goal of best-first search is to find the goal state by looking at as few states as possible; the more *informed* (Section 4.2.3) the heuristic, the fewer states are processed in finding the goal.

A trace of the execution of `best_first_search` on this graph appears below. Suppose P is the goal state in the graph of Figure 4.4. Because P is the goal, states along the path to P tend to have low heuristic values. The heuristic is fallible: the state O has a lower value than the goal itself and is examined first. Unlike hill climbing, which does not maintain a priority queue for the selection of “next” states, the algorithm recovers from this error and finds the correct goal.

1. `open = [A5]; closed = []`
2. `evaluate A5; open = [B4,C4,D6]; closed = [A5]`
3. `evaluate B4; open = [C4,E5,F5,D6]; closed = [B4,A5]`
4. `evaluate C4; open = [H3,G4,E5,F5,D6]; closed = [C4,B4,A5]`
5. `evaluate H3; open = [O2,P3,G4,E5,F5,D6]; closed = [H3,C4,B4,A5]`

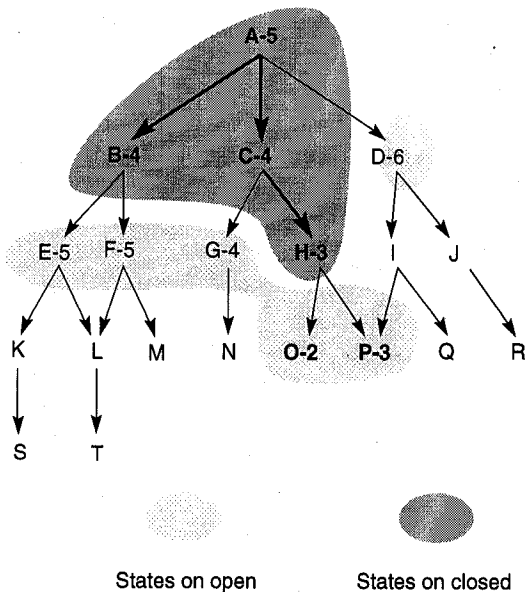

Figure 4.5 Heuristic search of a hypothetical state space with open and closed states highlighted.

6. evaluate O2; open = [P3,G4,E5,F5,D6]; closed = [O2,H3,C4,B4,A5]
7. evaluate P3; the solution is found!

Figure 4.5 shows the space as it appears after the fifth iteration of the while loop. The states contained in `open` and `closed` are indicated. `open` records the current frontier of the search and `closed` records states already considered. Note that the frontier of the search is highly uneven, reflecting the opportunistic nature of best-first search.

The best-first search algorithm always selects the most promising state on `open` for further expansion. However, as it is using a heuristic that may prove erroneous, it does not abandon all the other states but maintains them on `open`. In the event a heuristic leads the search down a path that proves incorrect, the algorithm will eventually retrieve some previously generated, “next best” state from `open` and shift its focus to another part of the space. In the example of Figure 4.4, after the children of state B were found to have poor heuristic evaluations, the search shifted its focus to state C. The children of B were kept on `open` in case the algorithm needed to return to them later. In `best_first_search`, as in the algorithms of Chapter 3, the `open` list allows backtracking from paths that fail to produce a goal.

4.1.2 Implementing Heuristic Evaluation Functions

We now evaluate the performance of several different heuristics for solving the 8-puzzle. Figure 4.6 shows a start and goal state for the 8-puzzle, along with the first three states generated in the search.

The simplest heuristic counts the tiles out of place in each state when it is compared with the goal. This is intuitively appealing, because it would seem that, all else being equal, the state that had fewest tiles out of place is probably closer to the desired goal and would be the best to examine next.

However, this heuristic does not use all of the information available in a board configuration, because it does not take into account the distance the tiles must be moved. A “better” heuristic would sum all the distances by which the tiles are out of place, one for each square a tile must be moved to reach its position in the goal state.

Both of these heuristics can be criticized for failing to acknowledge the difficulty of tile reversals. That is, if two tiles are next to each other and the goal requires their being in opposite locations, it takes (many) more than two moves to put them back in place, as the tiles must “go around” each other (Figure 4.7).

A heuristic that takes this into account multiplies a small number (2, for example) times each direct tile reversal (where two adjacent tiles must be exchanged to be in the order of the goal). Figure 4.8 shows the result of applying each of these three heuristics to the three child states of Figure 4.6.

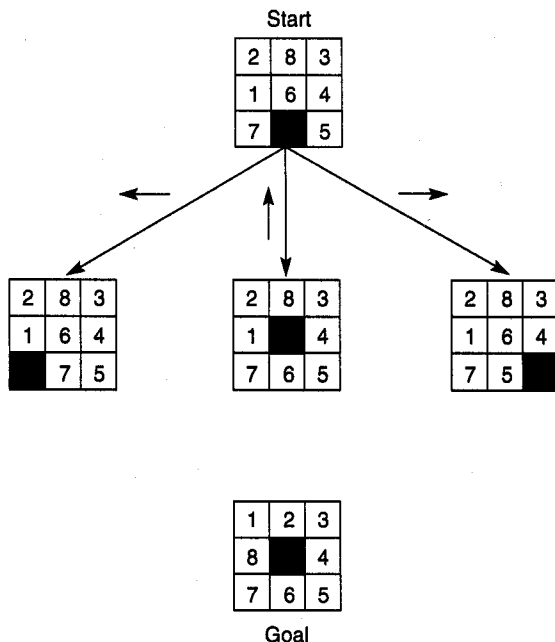

Figure 4.6 The start state, first set of moves, and goal state for an 8-puzzle instance.

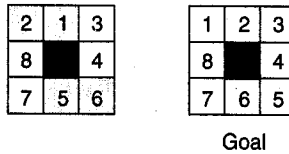

Figure 4.7 An 8-puzzle state with a goal and two reversals: 1 and 2, 5 and 6.

In Figure 4.8's summary of evaluation functions, the "sum of distances" heuristic does indeed seem to provide a more accurate estimate of the work to be done than the simple count of the number of tiles out of place. Also, note that the tile reversal heuristic fails to distinguish between these states, giving each an evaluation of 0. Although it is an intuitively appealing heuristic, it breaks down since none of these states have any direct reversals. A fourth heuristic, which may overcome the limitations of the tile reversal heuristic, adds the sum of the distances out of place and 2 times the number of direct reversals.

This example illustrates the difficulty of devising good heuristics. Our goal is to use the limited information available in a single state descriptor to make intelligent choices. Each of the heuristics proposed above ignores some critical bit of information and is subject to improvement. The design of good heuristics is an empirical problem; judgment and intuition help, but the final measure of a heuristic must be its actual performance on problem instances.

Because heuristics are fallible, it is possible that a search algorithm can be misled down some path that fails to lead to a goal. This problem arose in depth-first search, where a depth count was used to detect fruitless paths. This idea may also be applied to heuristic search. If two states have the same or nearly the same heuristic evaluations, it is generally preferable to examine the state that is nearest to the root state of the graph. This state will have a greater probability of being on the *shortest* path to the goal. The distance from the starting state to its descendants can be measured by maintaining a depth count for each state. This count is 0 for the beginning state and is incremented by 1 for each level of the search. It records the actual number of moves that have been used to go from the starting state in the search to each descendant. This can be added to the heuristic evaluation of each state to bias search in favor of states found shallower in the graph.

This makes our evaluation function, f , the sum of two components:

$$f(n) = g(n) + h(n)$$

where $g(n)$ measures the actual length of the path from any state n to the start state and $h(n)$ is a heuristic estimate of the distance from state n to a goal.

In the 8-puzzle, for example, we can let $h(n)$ be the number of tiles out of place. When this evaluation is applied to each of the child states in Figure 4.6, their f values are 6, 4, and 6, respectively, see Figure 4.9.

The full best-first search of the 8-puzzle graph, using f as defined above, appears in Figure 4.10. Each state is labeled with a letter and its heuristic weight, $f(n) = g(n) + h(n)$.

<table border="1"> <tr><td>2</td><td>8</td><td>3</td></tr> <tr><td>1</td><td>6</td><td>4</td></tr> <tr><td>■</td><td>7</td><td>5</td></tr> </table>	2	8	3	1	6	4	■	7	5	5	6	0
2	8	3										
1	6	4										
■	7	5										
<table border="1"> <tr><td>2</td><td>8</td><td>3</td></tr> <tr><td>1</td><td>■</td><td>4</td></tr> <tr><td>7</td><td>6</td><td>5</td></tr> </table>	2	8	3	1	■	4	7	6	5	3	4	0
2	8	3										
1	■	4										
7	6	5										
<table border="1"> <tr><td>2</td><td>8</td><td>3</td></tr> <tr><td>1</td><td>6</td><td>4</td></tr> <tr><td>7</td><td>5</td><td>■</td></tr> </table>	2	8	3	1	6	4	7	5	■	5	6	0
2	8	3										
1	6	4										
7	5	■										
	Tiles out of place	Sum of distances out of place	2 x the number of direct tile reversals									

1	2	3
8	■	4
7	6	5

Goal

Figure 4.8 Three heuristics applied to states in the 8-puzzle.

The number at the top of each state indicates the order in which it was taken off the open list. Some states (h, g, b, d, n, k, and i) are not so numbered, because they were still on open when the algorithm terminated.

The successive stages of open and closed that generate this graph are:

1. open = [a4];
closed = []
2. open = [c4, b6, d6];
closed = [a4]
3. open = [e5, f5, g6, b6, d6];
closed = [a4, c4]
4. open = [f5, h6, g6, b6, d6, l7];
closed = [a4, c4, e5]
5. open = [j5, h6, g6, b6, d6, k7, l7];
closed = [a4, c4, e5, f5]
6. open = [l5, h6, g6, b6, d6, k7, l7];
closed = [a4, c4, e5, f5, j5]
7. open = [m5, h6, g6, b6, d6, n7, k7, l7];
closed = [a4, c4, e5, f5, j5, l5]
8. success, m = goal!

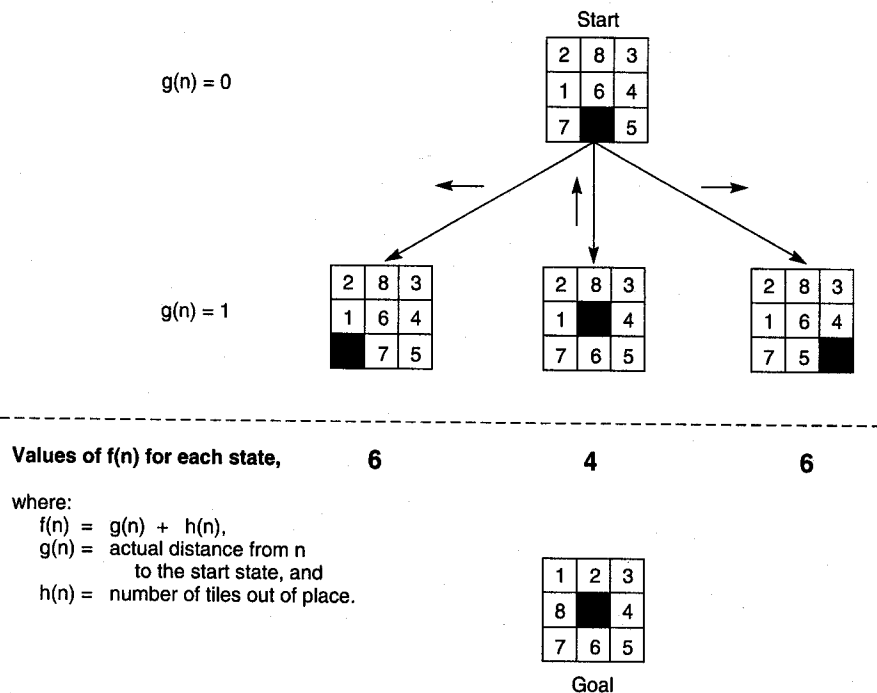

Figure 4.9 The heuristic f applied to states in the 8-puzzle.

In step 3 of the execution, both e and f have a heuristic evaluation of 5. State e is examined first, producing its children, h and i . Although state h , the immediate child of e , has the same number of tiles out of place as f , it is one level deeper in the state space. The depth measure, $g(n)$, therefore causes the algorithm to select f for evaluation in step 4. The algorithm goes back to the shallower state and continues to the goal. The state space graph at this stage of the search, with open and closed highlighted, appears in Figure 4.11. Notice the opportunistic nature of best-first search.

In effect, the $g(n)$ component of the evaluation function gives the search more of a breadth-first flavor. This prevents it from being misled by an erroneous evaluation: if a heuristic continuously returns “good” evaluations for states along a path that fails to reach a goal, the g value will grow to dominate h and force search back to a shorter solution path. This guarantees that the algorithm will not become permanently lost, descending an infinite branch. Section 4.2 examines the conditions under which best-first search using this evaluation function can actually be guaranteed to produce the shortest path to a goal.

To summarize:

1. Operations on states generate children of the state currently under examination.
2. Each new state is checked to see whether it has occurred before (is on either open or closed), thereby preventing loops.

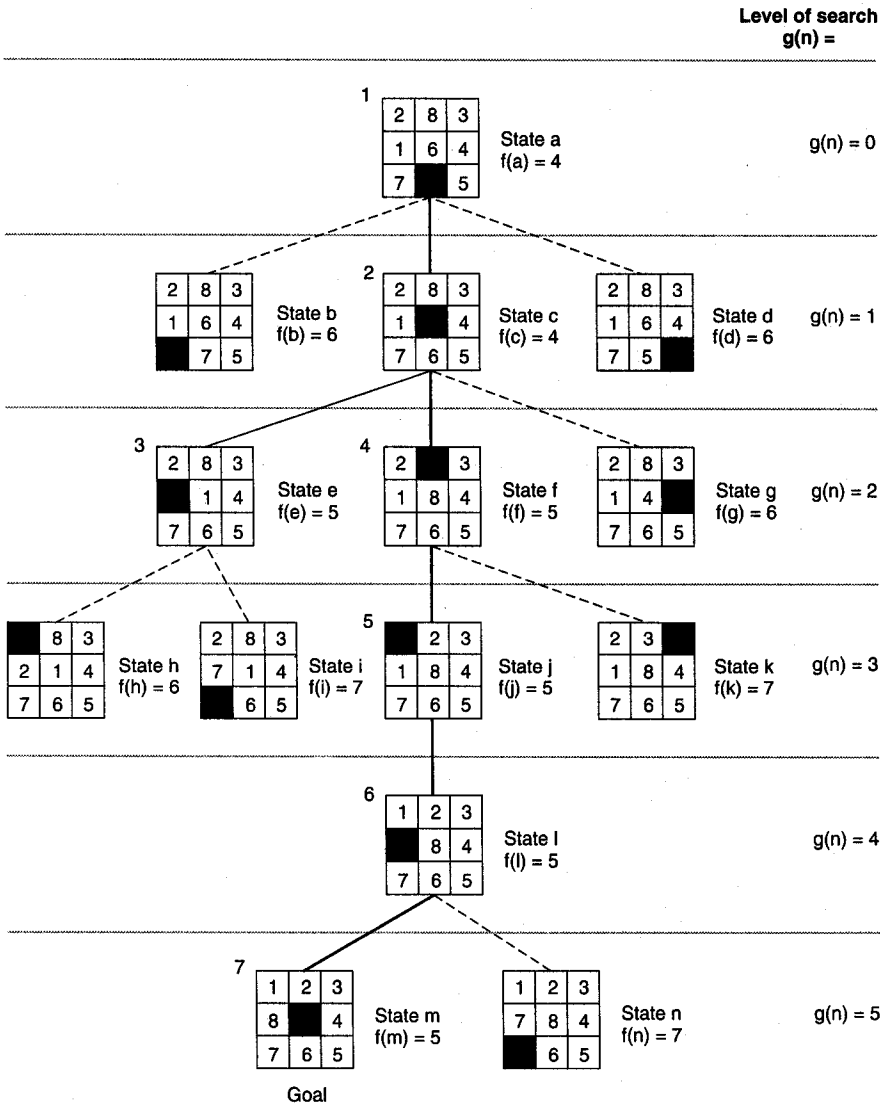

Figure 4.10 State space generated in heuristic search of the 8-puzzle graph.

3. Each state n is given an f value equal to the sum of its depth in the search space $g(n)$ and a heuristic estimate of its distance to a goal $h(n)$. The h value guides search toward heuristically promising states while the g value prevents search from persisting indefinitely on a fruitless path.
4. States on **open** are sorted by their f values. By keeping all states on **open** until they are examined or a goal is found, the algorithm can go back from fruitless

paths. At any one time, *open* may contain states at different levels of the state space graph, allowing full flexibility in changing the focus of the search.

5. The efficiency of the algorithm can be improved by careful maintenance of the *open* and *closed* lists, perhaps as a *heap* or *leftist tree*.

Best-first search is a general algorithm for heuristically searching any state space graph (as were the breadth- and depth-first algorithms presented earlier). It is equally applicable to data- and goal-driven searches and supports a variety of heuristic evaluation functions. It will continue (Section 4.2) to provide a basis for examining the behavior of heuristic search. Because of its generality, best-first search can be used with a variety of heuristics, ranging from subjective estimates of state's "goodness" to sophisticated measures based on the probability of a state leading to a goal. Bayesian statistical measures (Chapter 7) offer an important example of this approach.

Another interesting approach to implementing heuristics is the use of confidence measures by expert systems to weigh the results of a rule. When human experts employ a heuristic, they are usually able to give some estimate of their confidence in its conclusions. Expert systems employ *confidence measures* to select the conclusions with the highest likelihood of success. States with extremely low confidences can be eliminated entirely. This approach to heuristic search is examined in the next section and again in Chapter 7.

4.1.3 Heuristic Search and Expert Systems

Simple games such as the 8-puzzle are ideal vehicles for exploring the design and behavior of heuristic search algorithms for a number of reasons:

1. The search spaces are large enough to require heuristic pruning.
2. Most games are complex enough to suggest a rich variety of heuristic evaluations for comparison and analysis.
3. Games generally do not involve complex representational issues. A single node of the state space is just a board description and usually can be captured in a straightforward fashion. This allows researchers to focus on the behavior of the heuristic, rather than the problems of knowledge representation.
4. Because each node of the state space has a common representation (e.g., a board description), a single heuristic may be applied throughout the search space. This contrasts with systems such as the financial advisor, where each node represents a different subgoal with its own distinct description.

More realistic problems greatly complicate the implementation and analysis of heuristic search by requiring multiple heuristics to deal with different situations in the problem space. However, the insights gained from simple games generalize to problems such as those found in expert systems applications, planning, intelligent control, and machine learning. Unlike the 8-puzzle, a single heuristic may not apply to each state in these

domains. Instead, situation specific problem-solving heuristics are encoded in the syntax and content of individual problem solving operators. Each solution step incorporates its own heuristic that determines when it should be applied; the pattern matcher matches the appropriate operation (heuristic) with the relevant state in the space.

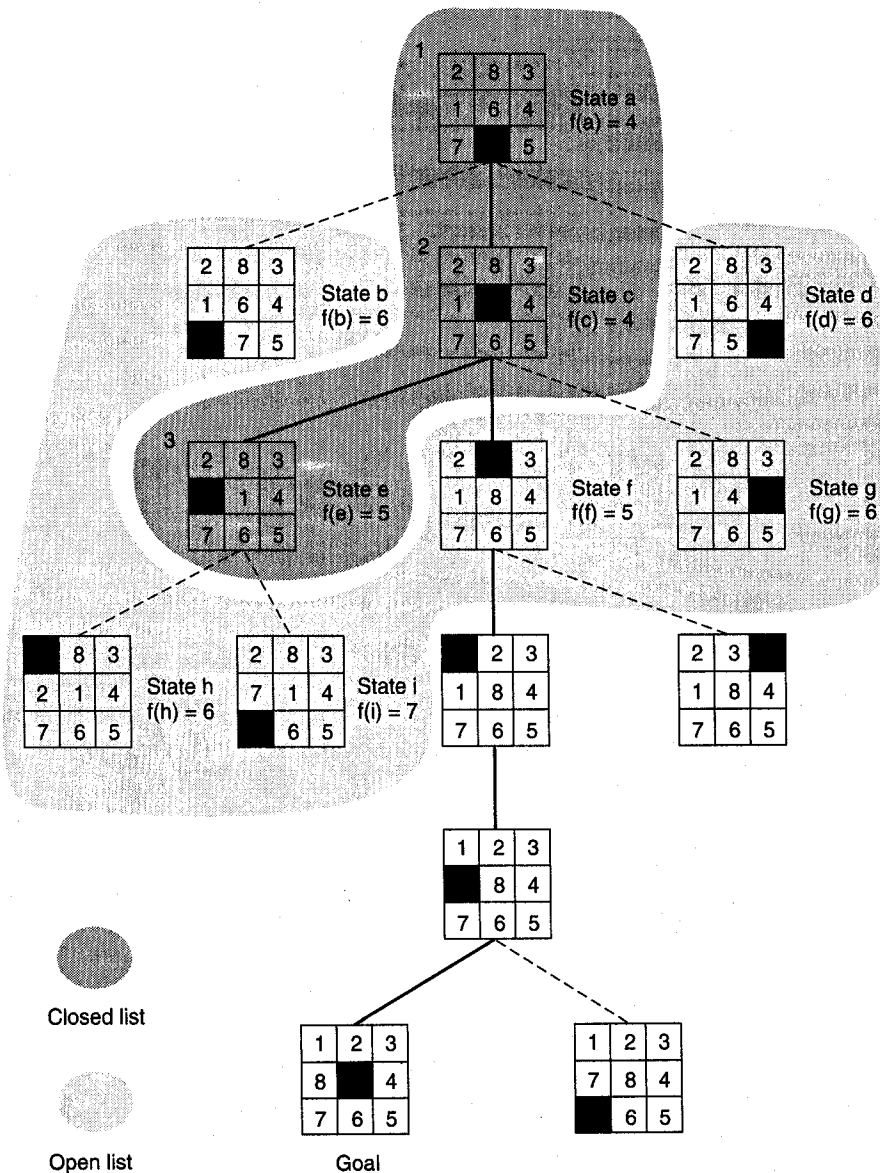

Figure 4.11 open and closed as they appear after the third iteration of heuristic search.

EXAMPLE 4.1.1: THE FINANCIAL ADVISOR

Reconsider the financial advisor presented in Chapters 2 and 3. So far, the knowledge base has been treated as a set of logical implications, whose conclusions are either true or false, depending on the truth value of the premises. In actuality, these rules are highly heuristic in nature. For example, one rule states that an individual with adequate savings and income should invest in stocks:

$$\text{savings_account(adequate)} \wedge \text{income(adequate)} \Rightarrow \text{investment(stocks)}.$$

In reality, it is possible that such an individual may prefer the added security of a combination strategy or even that of placing all investment money in savings. Thus, the rule is a heuristic, and the problem solver should try to account for this uncertainty. We could take additional factors, such as the age of the investor and the long-term prospects for security and advancement in the investor's profession, into account to make the rules more informed and capable of finer distinctions. However, this does not change the fundamentally heuristic nature of financial advice.

One way in which expert systems have addressed this issue is to attach a numeric weight (called a *confidence measure* or *certainty factor*) to the conclusion of each rule. This measures the confidence that may be placed in their conclusions.

Each rule conclusion is given a confidence measure, a real number between -1 and 1 , with 1 corresponding to certainty (true) and -1 to a definite value of false. Values in between reflect varying confidence in the conclusion. For example, the preceding rule may be given a confidence of, say, 0.8 , reflecting a small possibility that it may not be correct. Other conclusions may be drawn with different confidence weights:

$$\begin{aligned} &\text{savings_account(adequate)} \wedge \text{income(adequate)} \Rightarrow \text{investment(stocks)} \\ &\text{with confidence} = 0.8. \end{aligned}$$

$$\begin{aligned} &\text{savings_account(adequate)} \wedge \text{income(adequate)} \Rightarrow \text{investment(combination)} \\ &\text{with confidence} = 0.5. \end{aligned}$$

$$\begin{aligned} &\text{savings_account(adequate)} \wedge \text{income(adequate)} \Rightarrow \text{investment(savings)} \\ &\text{with confidence} = 0.1. \end{aligned}$$

These rules reflect the common investment advice that although an individual with adequate savings and income would be most strongly advised to invest in stocks, there is some possibility that a combination strategy should be pursued and a slight chance that they may want to continue investing in savings. Heuristic search algorithms can use these certainty factors in a number of ways. For example, the results of all applicable rules could be produced along with their associated confidences. This is an exhaustive search, with varying certainties placed on multiple conclusions. Alternatively, the program might return only the result with the strongest confidence value. This allows the program to ignore other rules, radically pruning the search space. A more conservative pruning strategy could ignore rules that draw a conclusion with a confidence less than a certain value, 0.2 for example.

A number of important issues must be addressed in using confidence measures to weight rule conclusions. What does it really mean to have a “numeric confidence measure”? For example, how are the confidences handled if the conclusion of one rule is used as the premise of others? How are confidences combined in the event that more than one rule draws the same conclusion? How are the proper confidence measures assigned to rules in the first place? These issues are discussed in detail in Chapter 7.

4.2 Admissibility, Monotonicity, and Informedness

We may evaluate the behavior of heuristics along a number of dimensions. For instance, we may not only desire a solution but also may require the algorithm to find the shortest path to the goal. This could be important when an application might have an excessive cost for extra solution steps, such as planning a path for an autonomous robot through a dangerous environment. Heuristics that find the shortest path to a goal whenever it exists are said to be *admissible*. In other applications a minimal solution path might not be as important as overall problem-solving efficiency.

We may want to ask whether any better heuristics are available. In what sense is one heuristic “better” than another? This is the *informedness* of a heuristic.

When a state is discovered by using heuristic search, is there any guarantee that the same state won’t be found later in the search at a cheaper cost (with a shorter path from the start state)? This is the property of *monotonicity*. The answers to these and other questions related to the effectiveness of heuristics make up the content of this section.

4.2.1 Admissibility Measures

A search algorithm is *admissible* if it is guaranteed to find a minimal path to a solution whenever such a path exists. Breadth-first search is an admissible search strategy. Because it looks at every state at level n of the graph before considering any state at the level $n + 1$, any goal nodes are found along the shortest possible path. Unfortunately, breadth-first search is often too inefficient for practical use.

Using the evaluation function $f(n) = g(n) + h(n)$ that was introduced in the last section, we may characterize a class of admissible heuristic search strategies. If n is a node in the state space graph, $g(n)$ measures the depth at which that state has been found in the graph, and $h(n)$ is the heuristic estimate of the distance from n to a goal. In this sense $f(n)$ estimates the total cost of the path from the start state through n to the goal state. In determining the properties of admissible heuristics, we define an evaluation function f^* :

$$f^*(n) = g^*(n) + h^*(n)$$

where $g^*(n)$ is the cost of the *shortest* path from the start node to node n and h^* returns the *actual* cost of the shortest path from n to the goal. It follows that $f^*(n)$ is the actual cost of the optimal path from a start node to a goal node that passes through node n .

If we employ `best_first_search` with the evaluation function f^* , the resulting search strategy is admissible. (Proof is left to the reader.) Although *oracles* such as f^* do not exist for most real problems, we would like the evaluation function f to be a close estimate of f^* . In algorithm A, $g(n)$, the cost of the current path to state n , is a reasonable estimate of g^* , but they may not be equal: $g(n) \geq g^*(n)$. These are equal only if the graph search has discovered the optimal path to state n .

Similarly, we replace $h^*(n)$ with $h(n)$, a heuristic estimate of the minimal cost to a goal state. Although we usually may not compute h^* , it is often possible to determine whether or not the heuristic estimate, $h(n)$, is bounded from above, i.e., is always less than or equal to the actual cost of a minimal path, $h^*(n)$. If algorithm A uses an evaluation function f in which $h(n) \leq h^*(n)$, it is called *algorithm A**.

DEFINITION

ALGORITHM A, ADMISSIBILITY, ALGORITHM A*

Consider the evaluation function $f(n) = g(n) + h(n)$, where

n is any state encountered in the search.

$g(n)$ is the cost of n from the start state.

$h(n)$ is the heuristic estimate of the cost of going from n to a goal.

If this evaluation function is used with the `best_first_search` algorithm of Section 4.1, the result is called *algorithm A*.

A search algorithm is *admissible* if, for any graph, it always terminates in the optimal solution path whenever a path from the start to a goal state exists.

If algorithm A is used with an evaluation function in which $h(n)$ is less than or equal to the cost of the minimal path from n to the goal, the resulting search algorithm is called *algorithm A** (pronounced "A STAR").

It is now possible to state a property of A* algorithms:

All A* algorithms are admissible.

The admissibility of A* algorithms is a theorem and an exercise at the end of the chapter give hints for its proof. The theorem says that any A* algorithm, i.e., one that uses a heuristic $h(n)$ such that $h(n) \leq h^*(n)$ for all n , is guaranteed to find the minimal path from n to the goal, if such a path exists.

Note that breadth-first search may be characterized as an A* algorithm in which $f(n) = g(n) + 0$. The decision for considering a state is based solely on its distance from the start state. We will show (Section 4.2.3) that the set of nodes considered by an A* algorithm is a subset of the states examined in breadth-first search.

Several heuristics from the 8-puzzle provide examples of A* algorithms. Although we may not be able to compute the value of $h^*(n)$ for the 8-puzzle, we may determine when a heuristic is bounded from above by the actual cost of the shortest path to a goal.

For instance, the heuristic of counting the number of tiles not in the goal position is certainly less than or equal to the number of moves required to move them to their goal position. Thus, this heuristic is admissible and guarantees an optimal (or shortest) solution path. The sum of the direct distances of tiles out of place is also less than or equal to the minimum actual path. Using small multipliers for direct tile reversals gives an admissible heuristic.

This approach to proving admissibility of 8-puzzle heuristics may be applied to any heuristic search problem. Even though the actual cost of the shortest path to a goal may not always be computed, we can often prove that a heuristic is bounded from above by this value. When this can be done, the resulting search will terminate in the discovery of the shortest path to the goal, when such a path exists.

4.2.2 Monotonicity

Recall that the definition of A* algorithms did not require that $g(n) = g^*(n)$. This means that admissible heuristics may initially reach non-goal states along a suboptimal path, as long as the algorithm eventually finds an optimal path to all states on the path to a goal. It is natural to ask if there are heuristics that are "locally admissible," i.e., that consistently find the minimal path to each state they encounter in the search. This property is called *monotonicity*.

DEFINITION

MONOTONICITY

A heuristic function h is monotone if

1. For all states n_i and n_j , where n_j is a descendant of n_i ,

$$h(n_i) - h(n_j) \leq \text{cost}(n_i, n_j),$$

where $\text{cost}(n_i, n_j)$ is the actual cost (in number of moves) of going from state n_i to n_j .

2. The heuristic evaluation of the goal state is zero, or $h(\text{Goal}) = 0$.

One way of describing the monotone property is that the search space is everywhere locally consistent with the heuristic employed. The difference between the heuristic measure for a state and any one of its successors is bound by the actual cost of going between that state and its successor. This is to say that the heuristic is everywhere admissible, reaching each state along the shortest path from its ancestors.

If the graph search algorithm for best-first search is used with a monotonic heuristic, an important step may be omitted. Because the heuristic finds the shortest path to any state the first time that state is discovered, when a state is encountered a second time, it is not necessary to check whether the new path is shorter. It won't be! This allows any state that is rediscovered in the space to be dropped immediately without updating the path information retained on open or closed.

When using a monotonic heuristic, as the search moves through the space, the heuristic measure for each state n is replaced by the actual cost for generating that piece of the path to n . Because the actual cost is equal to or larger than the heuristic in each instance, f will not decrease; i.e., f is monotonically nondecreasing (hence the name).

A simple argument can show that any monotonic heuristic is admissible. This argument considers any path in the space as a sequence of states s_1, s_2, \dots, s_g , where s_1 is the start state and s_g is the goal. For the sequence of moves in this arbitrarily selected path:

s_1 to s_2	$h(s_1) - h(s_2) \leq \text{cost}(s_1, s_2)$	by monotone property
s_2 to s_3	$h(s_2) - h(s_3) \leq \text{cost}(s_2, s_3)$	by monotone property
s_3 to s_4	$h(s_3) - h(s_4) \leq \text{cost}(s_3, s_4)$	by monotone property
.	.	by monotone property
.	.	by monotone property
s_{g-1} to s_g	$h(s_{g-1}) - h(s_g) \leq \text{cost}(s_{g-1}, s_g)$	by monotone property

Summing each column and using the monotone property of $h(s_g) = 0$:

$$\text{path } s_1 \text{ to } s_g \quad h(s_1) \leq \text{cost}(s_1, s_g)$$

This means that monotone heuristic h is A^* and admissible. It is left as an exercise whether the admissibility property of a heuristic implies monotonicity.

4.2.3 When One Heuristic Is Better: More Informed Heuristics

The final issue of this subsection compares two heuristics' ability to find the minimal path. An interesting case occurs when the heuristics are A^* .

DEFINITION

INFORMEDNESS

For two A^* heuristics h_1 and h_2 , if $h_1(n) \leq h_2(n)$, for all states n in the search space, heuristic h_2 is said to be *more informed* than h_1 .

We can use this definition to compare the heuristics proposed for solving the 8-puzzle. As pointed out previously, breadth-first search is equivalent to the A* algorithm with heuristic h_1 , such that $h_1(x) = 0$ for all states x . This is, trivially, less than h^* . We have also shown that h_2 , the number of tiles out of place with respect to the goal state, is a lower bound for h^* . In this case $h_1 \leq h_2 \leq h^*$. It follows that the “number of tiles out of place” heuristic is more informed than breadth-first search. Figure 4.12 compares the spaces searched by these two heuristics. Both h_1 and h_2 find the optimal path, but h_2 evaluates many fewer states in the process.

Similarly, we can argue that the heuristic that calculates the sum of the direct distances by which all the tiles are out of place is again more informed than the calculation

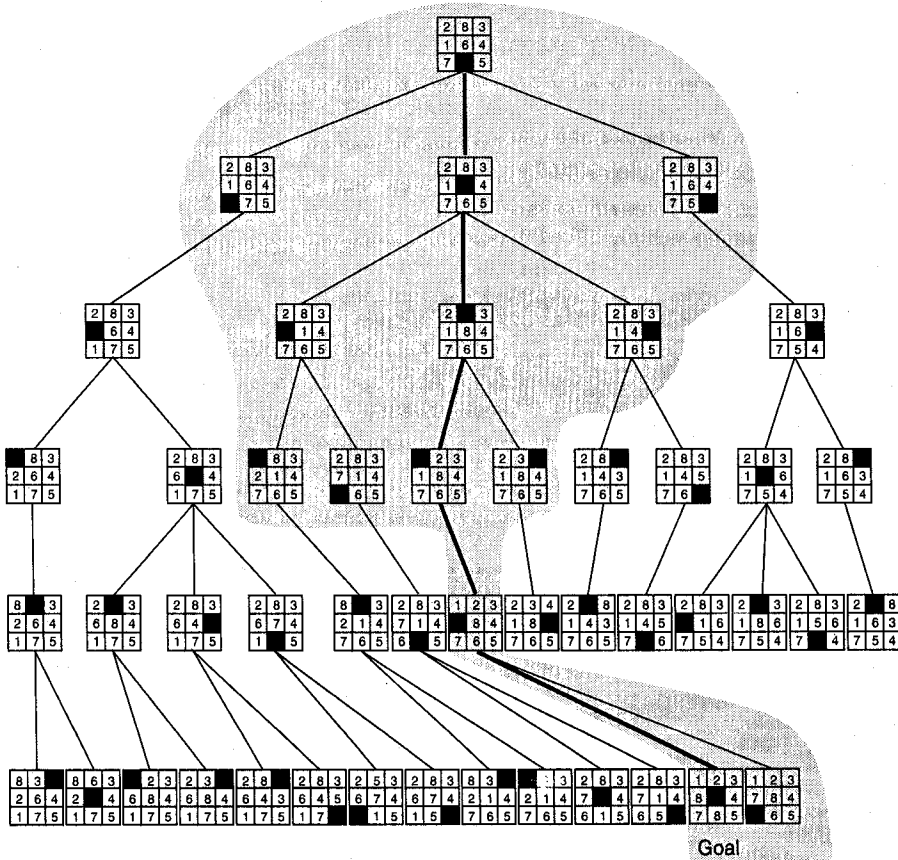

Figure 4.12 Comparison of state space searched using heuristic search with space searched by breadth-first search. The portion of the graph searched heuristically is shaded. The optimal solution path is in bold. Heuristic used is $f(n) = g(n) + h(n)$ where $h(n)$ is tiles out of place.

of the number of tiles that are out of place with respect to the goal state, and indeed this is the case. One can visualize a sequence of search spaces, each smaller than the previous one, converging on the direct optimal path solution.

If a heuristic h_2 is more informed than h_1 , then the set of states examined by h_2 is a subset of those expanded by h_1 . This can be verified by assuming the opposite (that there is one state expanded by h_2 and not by h_1). However, because h_2 is more informed than h_1 , for all n , $h_2(n) \leq h_1(n)$, which is contradicted by our assumption.

In general, then, the more informed an A^* algorithm, the less of the space it needs to expand to get the optimal solution. We must be careful, however, that the computations necessary to employ the more informed heuristic are not so inefficient as to offset the gains from reducing the number of states searched.

Computer chess programs provide an interesting example of this trade-off. One school of thought uses simple heuristics and relies on the speed of the computer to search as deeply as possible into the search space. These programs often use specialized hardware to increase the depth of the search. Another school relies upon more sophisticated heuristics to reduce the number of board states searched. These heuristics include calculations of piece advantages, control of board geography, possible attack strategies, defensive strategies, passed pawns, and so on. Calculation of these heuristics can itself involve exponential complexity. As the total time for the first 40 moves of the game is limited, it is extremely important to optimize this trade-off between search and evaluation of heuristics; see also Figure 4.22. The optimal blend of search and heuristics remains an open empirical question in computer chess.

4.3 Using Heuristics in Games

4.3.1 The Minimax Procedure on Exhaustively Searchable Graphs

Games have always been an important application area for heuristic algorithms. Two-person games are more complicated than simple puzzles because of the existence of a “hostile” and essentially unpredictable opponent. Thus, they provide some interesting opportunities for developing heuristics, as well as greater difficulties in developing search algorithms.

First we consider games whose state space is small enough to be exhaustively searched; here the problem is systematically searching the space of possible moves and countermoves by the opponent. Then we look at games in which it is either impossible or undesirable to exhaustively search the game graph. Because only a portion of the state space can be generated and searched, the game player must use heuristics to guide play along a path to a winning state.

Consider *nim*, a game whose state space may be exhaustively searched. To play *nim*, a number of tokens are placed on a table between the two opponents; at each move, the player must divide a pile of tokens into two nonempty piles of different sizes. Thus, 6 tokens may be divided into piles of 5 and 1 or 4 and 2, but not 3 and 3. The first player who

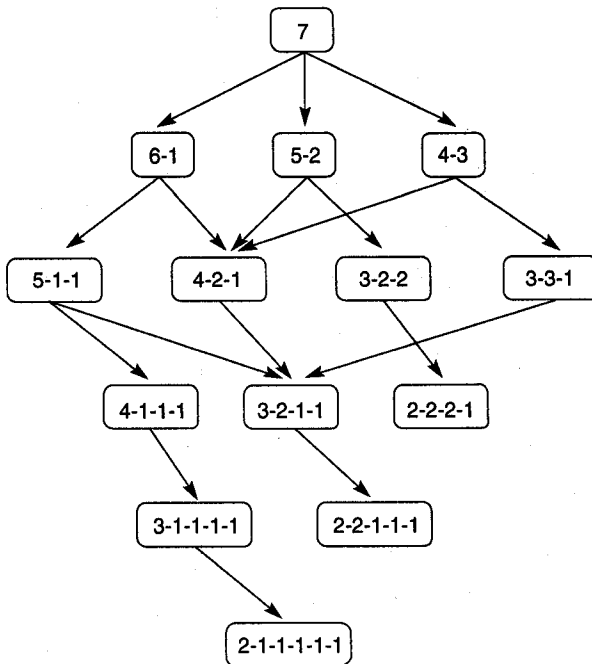

Figure 4.13 State space for the game of nim. Each state partitions the seven matches into one or more piles.

can no longer make a move loses the game. For a reasonable number of tokens, the state space can be exhaustively searched. Figure 4.13 illustrates the space for a game with 7 tokens.

In playing games whose state space may be exhaustively delineated, the primary difficulty is in accounting for the actions of the opponent. A simple way to handle this assumes that your opponent uses the same knowledge of the state space as you use and applies that knowledge in a consistent effort to win the game. Although this assumption has its limitations (which are discussed in Section 4.3.2), it provides a reasonable basis for predicting an opponent's behavior. *Minimax* searches the game space under this assumption.

The opponents in a game are referred to as MIN and MAX. Although this is partly for historical reasons, the significance of these names is straightforward: MAX represents the player trying to win, or to MAXimize her advantage. MIN is the opponent who attempts to MINimize MAX's score. We assume that MIN uses the same information and always attempts to move to a state that is worst for MAX.

In implementing minimax, we label each level in the search space according to whose move it is at that point in the game, MIN or MAX. In the example of Figure 4.14, MIN is allowed to move first. Each leaf node is given a value of 1 or 0, depending on whether it is a win for MAX or for MIN. Minimax propagates these values up the graph through successive parent nodes according to the rule:

If the parent state is a MAX node, give it the maximum value among its children.

If the parent is a MIN node, give it the minimum value of its children.

The value that is thus assigned to each state indicates the value of the best state that this player can hope to achieve (assuming the opponent plays as predicted by the minimax algorithm). These derived values are used to choose among possible moves. The result of applying minimax to the state space graph for nim appears in Figure 4.14.

The values of the leaf nodes are propagated up the graph using minimax. Because all of MIN's possible first moves lead to nodes with a derived value of 1, the second player, MAX, always can force the game to a win, regardless of MIN's first move. MIN could win only if MAX played foolishly. In Figure 4.14, MIN may choose any of the first move alternatives, with the resulting win paths for MAX in bold arrows.

Although there are games where it is possible to exhaustively search the state space, the most interesting cases do not allow exhaustive search. We examine the heuristic application of minimax in the next section.

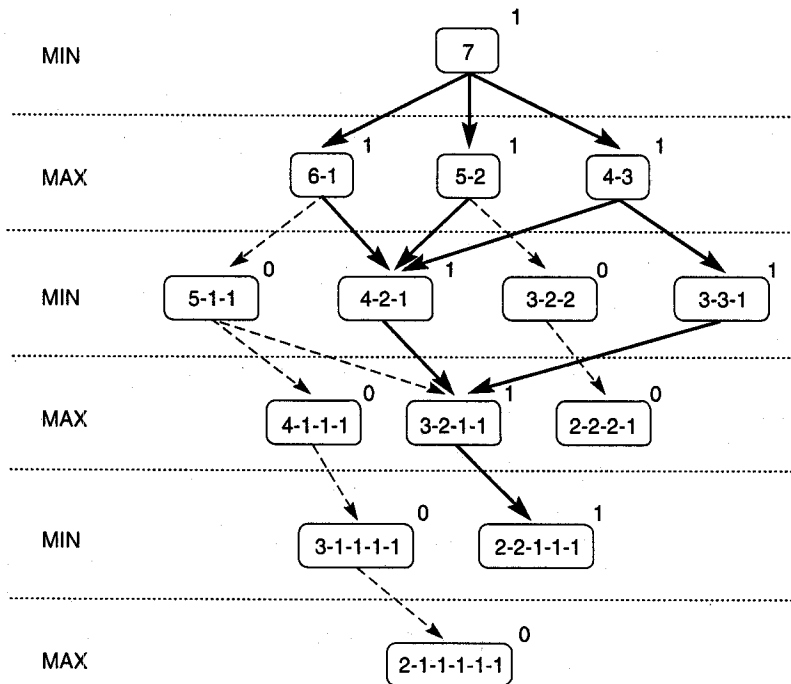

Figure 4.14 Exhaustive minimax for the game of nim. Bold lines indicate forced win for MAX. Each node is marked with its derived value (0 or 1) under minimax.

4.3.2 Minimizing to Fixed Ply Depth

In applying minimax to more complicated games, it is seldom possible to expand the state space graph out to the leaf nodes. Instead, the state space is searched to a predefined number of levels, as determined by available resources of time and memory. This strategy is called an *n-move look-ahead*, where *n* is the number of levels explored. As the leaves of this subgraph are not final states of the game, it is not possible to give them values that reflect a win or a loss. Instead, each node is given a value according to some heuristic evaluation function. The value that is propagated back to the root node is not an indication of whether or not a win can be achieved (as in the previous example) but is simply the heuristic value of the best state that can be reached in *n* moves from this start node. Look-ahead increases the power of a heuristic by allowing it to be applied over a greater area of the state space. Minimax consolidates these separate evaluations into a single value of an ancestor state.

In a game of conflict, each player attempts to overcome the other, so many game heuristics directly measure the advantage of one player over another. In checkers or chess, piece advantage is important, so a simple heuristic might take the difference in the number of pieces belonging to MAX and MIN and try to maximize the difference between these piece measures. A more sophisticated strategy might assign different values to the pieces, depending on their value (e.g., queen vs. pawn or king vs. ordinary checker) or location on the board. Most games provide limitless opportunities for designing heuristics.

Game graphs are searched by level, or *ply*. As we saw in Figure 4.14, MAX and MIN alternately select moves. Each move by a player defines a new ply of the graph. Game-playing programs typically look ahead a fixed ply depth, often determined by the space/time limitations of the computer. The states on that ply are measured heuristically and the values are propagated back up the graph using minimax. The search algorithm then uses these *derived values* to select among possible next moves.

After assigning an evaluation to each state on the selected ply, the program propagates a value up to each parent state. If the parent is on a MIN level, the minimum value of the children is backed up. If the parent is a MAX node, minimax assigns it the maximum value of its children.

Maximizing for MAX parents and minimizing for MIN, the values go back up the graph to the children of the current state. These values are then used by the current state to select among its children. Figure 4.15 shows minimax on a hypothetical state space with a four-ply look-ahead.

The earliest AI work in this area was Samuel's checker-playing program (1959). This program was exceptional for its time, particularly given the limitations of the 1950s computers. Not only did Samuel's checker player apply heuristic search to checker playing, but it also implemented a simple form of learning. Indeed, it pioneered many of the techniques still used in game-playing and machine learning programs.

Samuel's program evaluated board states with a weighted sum of several different heuristic measures:

$$\sum_i a_i x_i$$

The x_i in this sum was a feature of the game board such as piece advantage, piece location, control of center position, opportunities to sacrifice pieces in order to jump more of the opponent's pieces, and even a calculation of moments of inertia of one player's pieces about an axis of the board. The coefficients of these x_i were specially tuned weights that tried to model the importance of that factor in the overall board evaluation. Thus, if piece advantage was more important than control of the center, the piece advantage coefficient would be greater.

Samuel's program would look ahead in the search space the desired number of plies (usually imposed by space and/or time limitations of the computer) and evaluate all the states at that level with the evaluation polynomial. Using a variation on minimax, it propagated these values back up the graph. The checker player would then move to the best state; after the opponent's move, the process would be repeated for the new board state.

If the evaluation polynomial led to a losing series of moves, the program adjusted its coefficients in an attempt to improve performance. Evaluations with large coefficients were given most of the blame for losses and had their weights decreased, while smaller weights were increased to give these evaluations more influence. If the program won, the opposite was done. The program trained by playing either against a human partner or against another version of itself.

Samuel's program thus took a hill-climbing approach to learning, attempting to improve performance through local improvements on the evaluation polynomial. Samuel's checker player was able to improve its performance until it played a very good game of checkers. However, because it relied on hill climbing, it retained certain interesting limitations. For example, because it had no notion of a global strategy, it was vulnerable to strategies that used the evaluation function to lead the program into traps. The learning component of the program was vulnerable to inconsistencies in the opponent's play; for example, if the opponent used widely varying strategies, or simply played foolishly, the weights on the evaluation polynomial might begin to take on "random" values, leading to an overall degradation of performance.

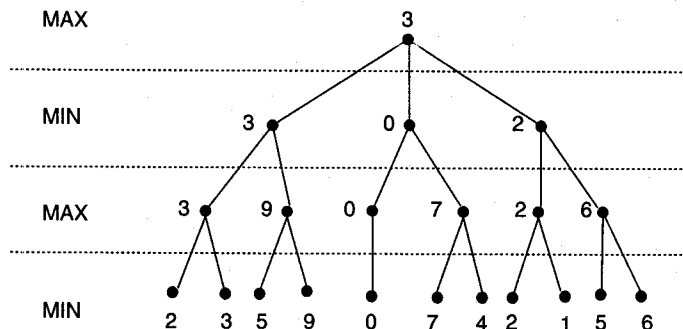
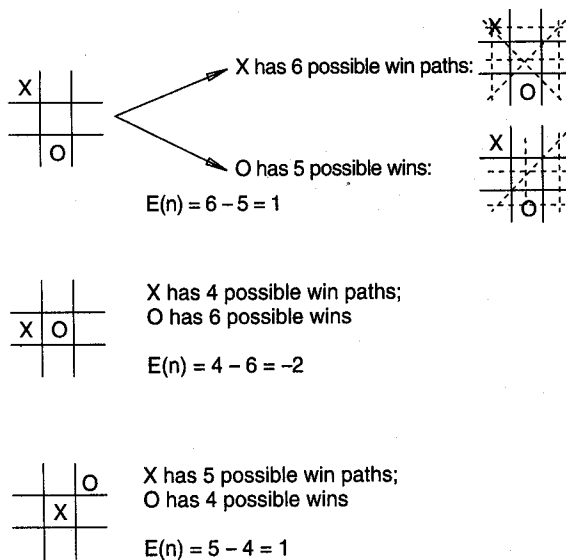

Figure 4.15 Minimax to a hypothetical state space. Leaf states show heuristic values; internal states show backed-up values.

We can make several final points about the minimax procedure. First, and most important, evaluations to any (previously decided) fixed ply depth may be seriously misleading. When a heuristic is applied with a limited look-ahead, it is possible that the depth of the look-ahead may not detect that a heuristically promising path leads to a bad situation later in the game. If your opponent in chess offers a rook as a lure to take your queen, and the evaluation only looks ahead to the ply where the rook is offered, the evaluation is going to be biased toward this state. Unfortunately, selection of the state may cause the entire game to be lost! This is referred to as the *horizon effect*. It is usually countered by searching several plies deeper from states that look exceptionally good. This selective deepening of search in important areas will not make the horizon effect go away, however. The search must stop somewhere and will be blind to states beyond that point.

There is another effect that occurs in minimaxing on the basis of heuristic evaluations. The evaluations that take place very deep in the space can be biased by their very depth (Pearl 1984). In the same way that the average of products differs from the product of averages, the estimate of minimax (which is what we desire) is different from the minimax of estimates (which is what we are doing). In this sense, deeper search with evaluation and



Heuristic is $E(n) = M(n) - O(n)$

where $M(n)$ is the total of My possible winning lines

$O(n)$ is total of Opponent's possible winning lines

$E(n)$ is the total Evaluation for state n

Figure 4.16 Heuristic measuring conflict applied to states of tic-tac-toe.

minimax need not always mean better search. Further discussion of these issues and possible remedies is found in Pearl (1984).

In concluding the discussion of minimax, we present its application to tic-tac-toe (Section 4.1) (Nilsson 1980). We use a slightly more complex heuristic, one that attempts to measure the conflict in the game. The heuristic takes a state to be measured, counts all winning lines open to MAX, and then subtracts the total number of winning lines open to MIN. The search attempts to maximize this difference. If a state is a forced win for MAX, it is evaluated as $+\infty$; a forced win for MIN, as $-\infty$. Figure 4.16 shows this heuristic applied to several sample states.

The three figures that follow show the heuristic of Figure 4.16 with a two-ply minimax MAX (X) has the first move in the game. The next three Figures, 4.17, 4.18, and 4.19, show the heuristic evaluation, the minimax backup, and MAX's choice of move.

4.3.3 The Alpha-Beta Procedure

Straight minimax requires a two-pass analysis of the search space, the first to descend to the ply depth and there apply the heuristic and the second to propagate values back up the tree. Minimax pursues all branches in the space, including many that could be ignored or pruned by a more intelligent algorithm. Researchers in game playing have developed a class of search techniques called *alpha-beta* pruning to improve the efficiency of search in two-person games (Pearl 1984).

The idea for alpha-beta search is simple: rather than searching the entire space to the ply depth, alpha-beta search proceeds in a depth-first fashion. Two values, called *alpha* and *beta*, are created during the search. The alpha value, associated with MAX nodes, can

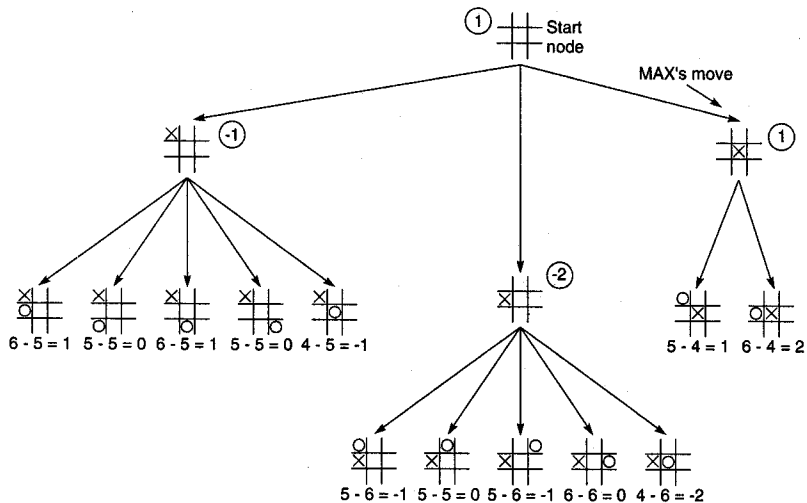

Figure 4.17 Two-ply minimax applied to the opening move of tic-tac-toe.

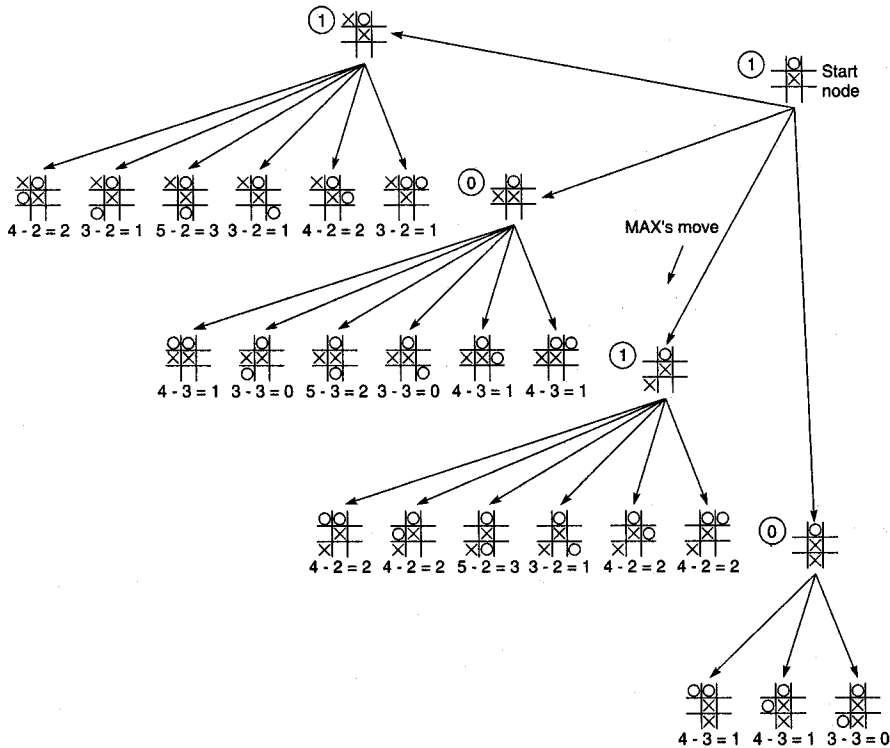

Figure 4.18 Two-ply minimax applied to X's second move of tic-tac-toe.

never decrease, and the beta value, associated with MIN nodes, can never increase. Suppose a MAX node's alpha value is 6. Then MAX need not consider any backed-up value less than or equal to 6 that is associated with any MIN node below it. Alpha is the worst that MAX can "score" given that MIN will also do its "best." Similarly, if MIN has a beta value of 6, it need not consider any MAX node below it that has a value of 6 or more.

To begin alpha-beta search, we descend to full ply depth in a depth-first fashion and apply our heuristic evaluation to a state and all its siblings. Assume these are MIN nodes. The maximum of these MIN values is then backed up to the parent (a MAX node, just as in minimax). This value is then offered to the grandparent of these MINs as a potential beta cutoff.

Next, the algorithm descends to other grandchildren and terminates exploration of their parent if any of their values is equal to or larger than this beta value. Similar procedures can be described for alpha pruning over the grandchildren of a MAX node.

Two rules for terminating search, based on alpha and beta values, are:

1. Search can be stopped below any MIN node having a beta value less than or equal to the alpha value of any of its MAX ancestors.

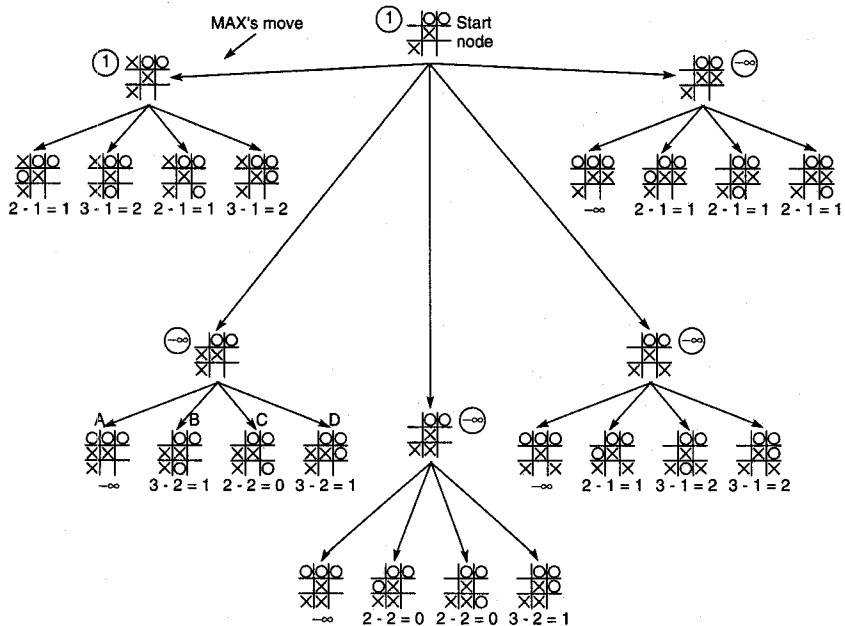

Figure 4.19 Two-ply minimax applied to X's move near end game.

- Search can be stopped below any MAX node having an alpha value greater than or equal to the beta value of any of its MIN node ancestors.

Alpha-beta pruning thus expresses a relation between nodes at ply n and nodes at ply $n + 2$ under which entire subtrees rooted at level $n + 1$ can be eliminated from consideration. As an example, Figure 4.20 takes the space of Figure 4.15 and applies alpha-beta pruning. Note that the resulting backed-up value is identical to the minimax result and the search saving is considerable.

With a fortuitous ordering of states in the search space, alpha-beta can effectively double the depth of the search space considered with a fixed space/time computer commitment (Nilsson 1980). If there is a particular unfortunate ordering, alpha-beta searches no more of the space than normal minimax; however, the search is done in only one pass.

4.4 Complexity Issues

The most difficult aspect of combinatorial problems is that the "explosion" often takes place without program designers realizing that it is happening. Because most activity, computing and otherwise, takes place in a world of linear algorithms and processing, we have difficulty appreciating the full meaning of exponential growth. The complaint is too

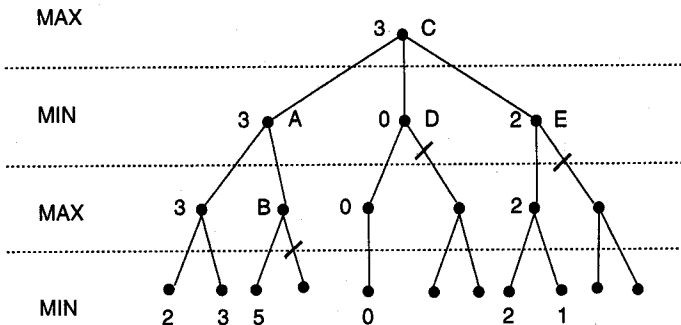

- A has $\beta = 3$ (A will be no larger than 3)
- B is β pruned, since $5 > 3$
- C has $\alpha = 3$ (C will be no smaller than 3)
- D is α pruned, since $0 < 3$
- E is α pruned, since $2 < 3$
- C is 3

Figure 4.20 Alpha-beta pruning applied to state space of Figure 4.15. States without numbers are not evaluated.

often heard, “If only I had a larger (or faster or highly parallel...) computer my problem would be solved.” Such claims, often made in the aftermath of the explosion, are usually rubbish. The problem wasn’t understood properly and/or appropriate steps were not taken to address the combinatorics of the situation.

The full extent of combinatorial growth staggers the imagination. It has been estimated that the number of states produced by a full search of the space of possible chess moves is about 10^{20} . This is not “just another large number;” it is comparable to the number of molecules in the universe or the number of nanoseconds since the “big bang.”

Several measures have been developed to help calculate complexity. One of these is the *branching factor* of a space. This is defined as the average number of descendants that emerge from any state in the space. The number of states at depth n of the search is equal to the branching factor raised to the n th power. Once the branching factor is computed for a space it is possible to estimate the search cost to generate a path of any particular length. Figure 4.21 gives the relationship between B (branching), L (path length), and T (total states in the search) for small values. The figure is logarithmic in T , so L is not the straight line it looks in the graph.

Several examples using this figure show how bad things can get. If the branching factor is 2 (in a binary tree, for example), it takes a search of about 100 states to examine all paths that extend six levels deep into the search space. It takes a search of about 10,000 states to consider paths 12 moves deep. If the branching can be cut down to 1.5 (by some heuristic or reformulation of the problem), then a path twice as long can be considered for the same amount of states searched.

The mathematical formula that produced the relationships of Figure 4.21 is straightforward:

$$T = B + B^2 + B^3 + \dots + B^L$$

where T is total states, L is path length, and B is branching factor. This equation reduces to:

$$T = B(B^L - 1)/(B - 1)$$

Measuring a search space is by and large empirical and done by considerable playing about with and testing of a problem. Suppose, for example, we wish to establish the branching factor of the 8-puzzle. We calculate the total number of possible moves: 2 from each corner for a total of 8 corner moves, 3 from the center of each side for a total of 12, and 4 from the center of the grid for a grand total of 24. This divided by 9, the different number of possible locations of the blank, gives an average branching factor of 2.67. As can be seen in Figure 4.21, this is not very good for a deep search. If we eliminate moves directly back to a parent state (already built into the search algorithms of this chapter) there is one move fewer from each state. This gives a branching factor of 1.67, a considerable improvement, which might (in some state spaces) make exhaustive search possible.

As we considered in Chapter 3, the complexity cost of an algorithm can also be measured by the sizes of the open and closed lists. One method of keeping the size of open reasonable is to save on open only a few of the (heuristically) best states. This can produce a better focused search but has the danger of possibly eliminating the best, or even the only, solution path. This technique of maintaining a size bound, often a function of the number of steps taken in the search, is called *beam search*.

In the attempt to bring down the branching of a search or otherwise constrain the search space, we presented the notion of *more informed* heuristics. The more informed the search, the less the space must be searched to get the minimal path solution. As we pointed out in Section 4.3, the computational costs of the additional information needed to further cut down the search space may not always be acceptable. In solving problems on a computer, it is not enough to find a minimum path. We must also minimize total cpu costs.

Figure 4.22, taken from an analysis by Nilsson (1980), is an informal attempt to get at these issues. The "informedness" coordinate marks the amount of information that is included in the evaluation heuristic to improve its performance. The cpu coordinate marks the cpu costs for implementing aspects of the search. As the information included in the heuristic increases, the cpu cost of the heuristic increases. Similarly, as the heuristic gets more informed, the cpu cost of evaluating states gets smaller, because fewer states are considered. The critical cost, however, is the total cost of computing the heuristic PLUS evaluating states, and it is usually desirable that this cost be minimized.

Finally, heuristic search of and/or graphs is an important area of concern, as the state spaces for expert systems are often of this form. The fully general search of these structures is made up entirely of the components already discussed in this and the preceding chapter. Because all and children must be searched to find a goal, the heuristic estimate of the cost of searching an and node is the sum of the estimates of searching the children.

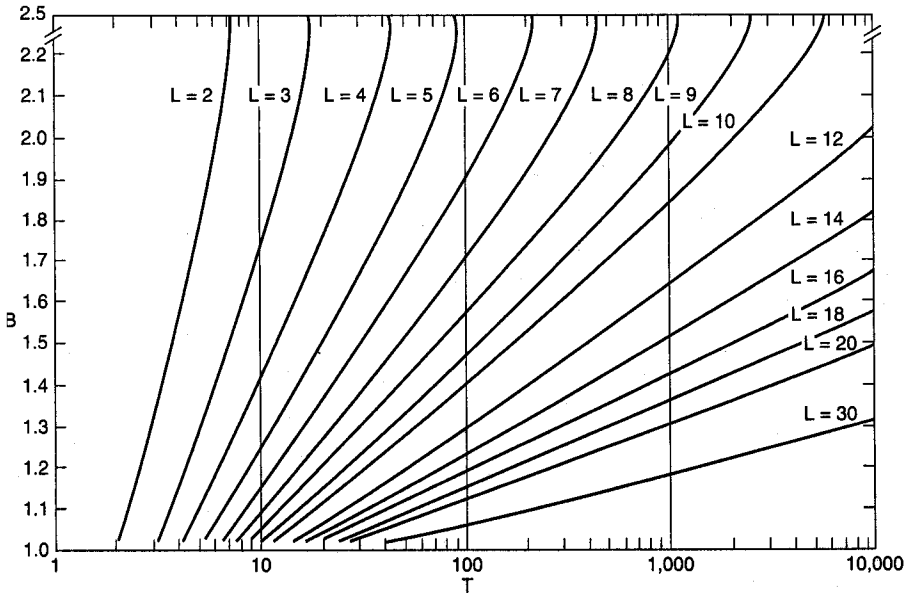

Figure 4.21 Number of nodes generated as a function of branching factor, B , for various lengths, L , of solution paths. The relating equation is: $T = B(B^L - 1)/(B - 1)$.

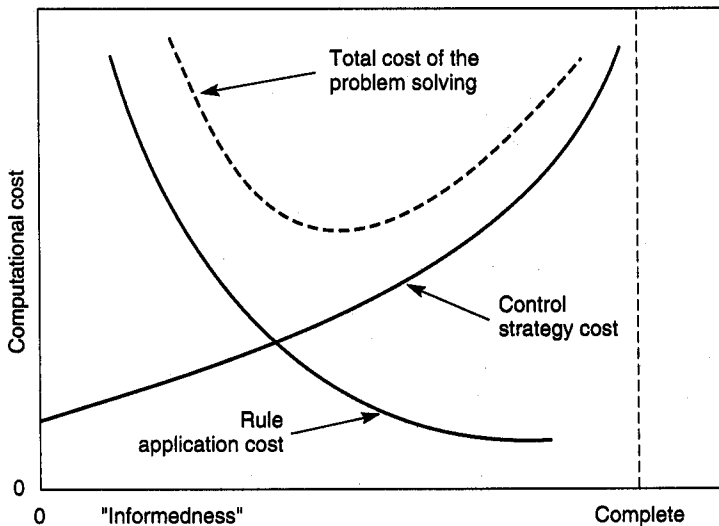

Figure 4.22 Informal plot of cost of searching and cost of computing heuristic evaluation against informedness of heuristic.

4.5 Epilogue and References

The search spaces for interesting problems tend to grow exponentially; heuristic search is a primary tool for managing this combinatorial explosion. After presenting an algorithm for implementing best-first search, the chapter analyzed the behavior of heuristic algorithms, considering properties such as admissibility, monotonicity, and informedness.

Heuristic search was introduced using simple games such as the 8-puzzle and extended to the more complex problem spaces generated by rule-based expert systems (Chapter 6). The chapter also applied heuristic search to two-person games, using minimax and alpha-beta pruning to implement look-ahead and predict the behavior of the opponent.

The discipline of complexity theory has essential ramifications for virtually every branch of computer science, especially the analysis of state space growth and heuristic pruning. Complexity theory examines the inherent complexity of problems (as opposed to algorithms). The key conjecture in complexity theory is that there exists a class of inherently intractable problems. This class, referred to as NP (Nondeterministically Polynomial), consists of problems that may not be solved in less than exponential time without resorting to the use of heuristics. Almost all search problems belong to this class. We especially recommend *Computers and Intractability* by Michael R. Garey and David S. Johnson (1979) and *Algorithms from P to NP, Vol. I: Design and Efficiency* by Bernard Moret and Henry Shapiro (1991) for this material.

Heuristics by Judea Pearl (1984) provides a comprehensive treatment of the design and analysis of heuristics for computer problem solving. R. E. Korf (1987) has continued to examine search algorithms. His work includes a thorough analysis of iterative deepening and the development of the IDA* algorithm, which integrates iterative deepening with the heuristic control of A* to obtain linear bounds on open for heuristic search. We are also indebted to Nils Nilsson (1980) for the general approach and many of the particular examples presented in this chapter.

4.6 Exercises

1. Give a heuristic that a block-stacking program might use to solve problems of the form “stack block X on block Y.” Is it admissible? Monotonic?
2. The sliding-tile puzzle consists of three black tiles, three white tiles, and an empty space in the configuration shown in Figure 4.23. The puzzle has two legal moves with associated costs:

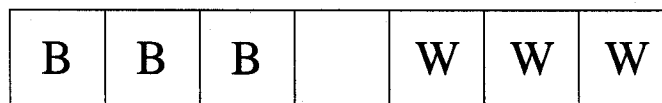

Figure 4.23 The sliding block puzzle.

A tile may move into an adjacent empty location. This has a cost of 1. A tile can hop over one or two other tiles into the empty position. This has a cost equal to the number of tiles jumped over.

The goal is to have all the white tiles to the left of all the black tiles. The position of the blank is not important.

- a. Analyze the state space with respect to complexity and looping.
 - b. Propose a heuristic for solving this problem and analyze it with respect to admissibility, monotonicity, and informedness.
3. Compare the three 8-puzzle heuristics of Figure 4.8 with the heuristic of adding the sum of distances out of place to 2 times the number of direct reversals. Compare them in terms of:
- a. Accuracy in estimating distance to a goal. This requires that you first derive the shortest path solution and use it as a standard.
 - b. Informedness. Which heuristic most effectively prunes the state space?
 - c. Admissibility. Which of these heuristics are bounded from above by the actual cost of a path to the goal? Either prove your conclusions for the general case or give a counterexample.
4. a. As presented in the text, best-first search uses the **closed** list to implement loop detection. What would be the effect of eliminating this test and relying on the depth test, $g(n)$, to detect loops? Compare the efficiencies of the two approaches.
- b. **best_first_search** does not test a state to see whether it is a goal until it is removed from the **open** list. This test could be performed when new states are generated. What effect would doing so have on the efficiency of the algorithm? Admissibility?
5. Prove A^* is admissible. Hint: the proof should show that:
- a. During its execution there is always a node on **open** that lies on an optimal path to the goal.
 - b. If there is a path to a goal, A^* will terminate by finding the optimal path.
6. Does (or when does) admissibility imply monotonicity of a heuristic?
7. Prove that the set of states expanded by algorithm A^* is a subset of those examined by breadth-first search.
8. Prove that more informed heuristics develop the same or less of the search space. Hint: formalize the argument presented in Section 4.2.3.
9. A Caesar cipher is a simple encryption scheme based on cyclic permutations of the alphabet, with the i th letter of the alphabet replaced by the $(i + n)$ th letter of the alphabet. For example, in a Caesar cipher with a shift of 4, "Caesar" would be encrypted as "Geiwev."
- a. Give three heuristics that might be used for solving Caesar ciphers.
 - b. In a simple substitution cipher, each letter is replaced by another letter under some arbitrary one-to-one mapping. Which of the heuristics proposed for the Caesar cipher may be used to solve substitution ciphers? Explain. (Thanks to Don Morrison for this problem.)
10. Perform minimax on the tree shown in Figure 4.24.
11. Perform a left-to-right alpha-beta prune on the tree of Exercise 10. Perform a right-to-left prune on the same tree. Discuss why different pruning occurs.

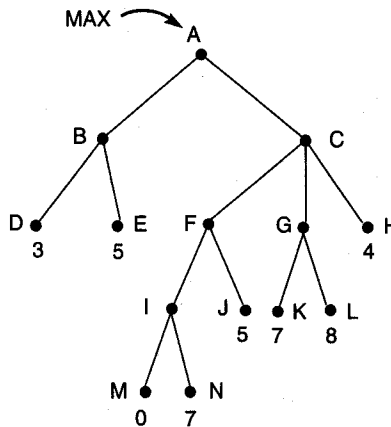
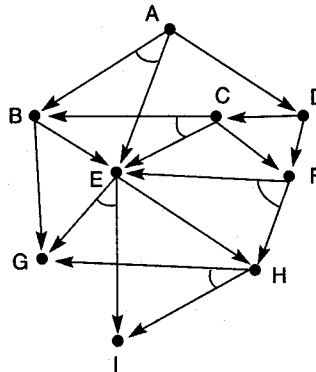

Figure 4.24

12. Consider three-dimensional tic-tac-toe. Discuss representational issues; analyze the complexity of the state space. Propose a heuristic for playing this game.
13. Perform alpha-beta pruning on the tic-tac-toe search of Figures 4.17, 4.18, and 4.19. How many leaf nodes can be eliminated in each case?
14. a. Define an algorithm for heuristically searching and/or graphs. Note that all descendants of an **and** node must be solved to solve the parent. Thus, in computing heuristic estimates of costs to a goal, the estimate of the cost to solve an **and** node must be at least the sum of the estimates to solve the different branches.
 b. Use this algorithm to search the graph in Figure 4.25.



$h(A) = 1$	$h(F) = 5$
$h(B) = 2$	$h(G) = 1$
$h(C) = 5$	$h(H) = 3$
$h(D) = 3$	$h(I) = 1$
$h(E) = 2$	

Figure 4.25

CONTROL AND IMPLEMENTATION OF STATE SPACE SEARCH

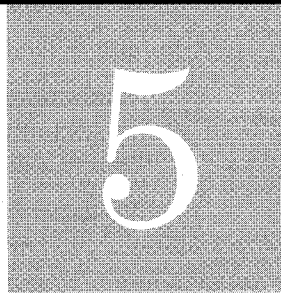

If we carefully factor out the influences of the task environments from the influences of the underlying hardware components and organization, we reveal the true simplicity of the adaptive system. For, as we have seen, we need postulate only a very simple information processing system in order to account for human problem solving in such tasks as chess, logic, and cryptarithmic. The apparently complex behavior of the information processing system in a given environment is produced by the interaction of the demands of the environment with a few basic parameters of the system, particularly characteristics of its memories.

—A. NEWELL AND H. A. SIMON, “Human Problem Solving”

*What we call the beginning is often the end
And to make an end is to make a beginning.
The end is where we start from . . .*

T. S. ELIOT, “Four Quartets”

5.0 Introduction

Chapters 3 and 4 represented problem solving as search through a set of problem states. The state space model of problem solving allows graph theory to be used as a tool for designing and analyzing intelligent programs. Chapter 3 defined a general backtracking graph search algorithm as well as algorithms for both depth-first and breadth-first search. Chapter 4 presented algorithms for heuristic search. The following definitions characterize the data and control structures used to implement state space search:

1. Representation of a problem solution as a path from a start state to a goal.
2. Search to test systematically alternative paths to a goal.

3. Backtracking to allow an algorithm to recover from paths that fail to find a goal.
4. Lists to keep explicit records of states under consideration.
 - a. The *open* list allows the algorithm to explore untried states if necessary.
 - b. The *closed* list of visited states allows the algorithm to implement loop detection and avoid repeating fruitless paths.
5. Implementation of the *open* list as a *stack* for depth-first search, a *queue* for breadth-first search, and a *priority queue* for best-first search.

Chapter 5 introduces higher-level techniques for implementing search algorithms. The first of these, *recursive search*, implements depth-first search with backtracking in a more concise, natural fashion than in Chapter 3 and forms the basis for many of the algorithms in this text, Section 5.1. Recursive search is augmented through the use of *unification* to search the state space generated by predicate calculus assertions. This *pattern-directed* search algorithm, Section 5.2, is the basis of PROLOG, see Chapter 9, and many of the expert system shells discussed in Chapter 6. Next, in Section 5.3 we introduce *production systems*, a general architecture for pattern-directed problem solving that has been used extensively both to model human problem solving and to build expert systems and other AI applications. In Section 5.4 we show how predicate calculus and pattern matching may be used in robot planning or problem solving across time periods. Finally we present another AI problem-solving technique, the *blackboard*.

5.1 Recursion-Based Search

5.1.1 Recursion

In mathematics, a recursive definition uses the term being defined as part of its own definition. In computer science, recursion is used to define and analyze both data structures and procedures. A recursive procedure consists of:

1. A recursive step in which the procedure calls itself to repeat a sequence of actions.
2. A terminating condition that stops the procedure from recurring endlessly (the recursive version of an endless loop).

Both these components are essential and appear in all recursive definitions and algorithms. Recursion is a natural control construct for data structures that have no definite size, such as lists, trees, and graphs, and particularly appropriate for state space search.

A simple example of recursion is an algorithm for determining if an item is a member of a list. Lists are ordered sequences of elements and fundamental building blocks for computer science data structures. Lists have already been used as an alternative syntax for predicate calculus expressions (Chapter 2) and to implement the open and closed lists in the search algorithms of Chapter 3. A procedure for testing whether an element is a member of a list is defined recursively by:

```

function member(item, list);

begin
  if list is empty
  then return (fail)           % terminate
  else
    if item = first element of list
    then return (success)     % terminate
    else
      begin
        tail:=list with its first item removed;
        member(item, tail)    % recur
      end
    end
end.

```

This procedure first tests whether *list* is empty; if so, the algorithm returns *fail*. Otherwise, it compares *item* to the first element of *list*; if these are equal, the procedure halts with success. These are the terminating conditions of the procedure. If neither terminating condition is met, *member* removes the first element from *list* and calls itself on the shortened list. In this fashion, *member* examines each element of the list in turn. Note that because *list* is finite and each step reduces its size by one element, the algorithm halts.

This algorithm uses two fundamental list operations: one that returns the first element (the *head*) of a list and a *tail* operation, which returns the list with its first element removed. When coupled with recursion, these operations are the basis for higher-level list operations such as *member*. These operations are supported by both LISP and PROLOG and are described in detail in the chapters on each language.

When supported by a programming language, recursion offers all the power of more traditional control constructs such as loops and conditional branching. In other words, *anything* that can be done using explicit iteration can be done recursively. The benefit of recursive formulations is greater clarity and compactness of expression. Mathematical notations such as logic or functions do not support such concepts as sequencing, branching, and iteration; instead, they use recursion to indicate repetition. As recursion is easier to describe mathematically than explicit iteration, it is easier to analyze formally the correctness and complexity of recursive algorithms. Recursive formulations are also used frequently by systems that automatically generate or verify programs, and they play an important role in implementing compilers and interpreters. More important, however, is the power and naturalness of recursion as a tool for implementing AI problem-solving strategies such as graph search.

5.1.2 Recursive Search

A direct translation of the depth-first search algorithm of Chapter 3 into recursive form illustrates the equivalence of recursion and iteration. This algorithm uses global variables *closed* and *open* to maintain lists of states:

```

function depthsearch;                                     % open & closed global
begin
  if open is empty
    then return(fail);
  current_state := the first element of open;
  if current_state is a goal state
    then return(success)
  else
    begin
      open := the tail of open;
      closed := closed with current_state added;
      for each child of current_state
        if not on closed or open                               % build stack
          then add the child to the front of open
      end;
      depthsearch                                           % recur
    end.
end.

```

Breadth-first search can be designed with virtually the same algorithm, that is, by retaining closed as a global data structure and by implementing the open list as a queue rather than as a stack.

Depth-first search as just presented does not utilize the full power of recursion. It is possible to simplify the procedure further by using recursion itself (rather than an explicit open list) to organize states and paths through the state space. In this version of the algorithm, a global closed list is used to detect duplicate states and prevent loops, and the open list is implicit in the activation records of the recursive environment.

```

function depthsearch (current_state);                   % closed is global
begin
  if current_state is a goal
    then return(success);
  add current_state to closed;
  while current_state has unexamined children
    begin
      child := next unexamined child;
      if child not member of closed
        then if depthsearch(child) = success
              then return(success)
      end;
    return(fail)                                         % search exhausted
  end
end

```

Rather than generating all children of a state and placing them on an open list, this algorithm produces the child states one at a time and recursively searches the descendants of each child before generating its sibling. Note that the algorithm assumes an order to the

state generation operators. In recursively searching a child state, if some descendant of that state is a goal, the recursive call returns success and the algorithm ignores the siblings. If the recursive call on the child state fails to find a goal, the next sibling is generated and all of its descendants are searched. In this fashion, the algorithm searches the entire graph in a depth-first order. The reader should verify that it actually searches the graph in the same order as the depth-first search algorithm of Section 3.2.3.

The omission of an explicit open list is made possible through recursion. The mechanisms by which a programming language implements recursion include a separate *activation record* (Aho and Ullman 1977) of each recursive call. Each activation record captures the local variables and state of execution of each procedure call. When the procedure is called recursively with a new state, a new activation record stores its parameters (the state), any local variables, and the current state of execution. In a recursive search algorithm, the series of states on the current path are recorded in the sequence of activation records of the recursive calls. The record of each call also indicates the last operation used to generate a child state; this allows the next sibling to be generated when needed.

Backtracking is effected when all descendants of a state fail to include a goal, causing the recursive call to fail. This returns fail to the procedure expanding the parent state, which then generates and recurs on the next sibling. In this situation, the internal mechanisms of recursion do the work of the open list used in the iterative version of the algorithm. The recursive implementation allows the programmer to restrict his or her point of view to a single state and its children rather than having to explicitly maintain an open list of states. The ability of recursion to express global concepts in a closed form is a major source of its power.

State space search is an inherently recursive process. To find a path from a current state to a goal, move to a child state and recur. If that child state does not lead to a goal, try its siblings in order. Recursion breaks a large and difficult problem (searching the whole space) into smaller, simpler pieces (generate the children of a single state) and applies this strategy (recursively) to each of them. This process continues until a goal state is discovered or the space is exhausted.

Symbolic integration, discussed in Section 3.3.3, is an excellent example of the power of a recursive approach to search problems. When attempting to integrate an expression, it applies either a substitution or a decomposition to the expression, replacing it with one (in the case of a substitution) or more (in the case of a decomposition) simpler subproblems. These subproblems are then solved recursively, with the separate solutions being recombined into a final answer. For example, after applying the rule that the integral of a sum equals the sum of the integrals of the terms, it recursively attempts to integrate each term. This may lead to further decompositions or substitutions, until each term has been integrated. These results are then combined (summed) to produce the final result. Recursion is a natural tool for systematically decomposing a problem and recombining partial solutions into a final answer.

In the next section, this recursive approach to problem solving is extended into a controller for a logic-based problem solver that uses unification and inference to generate and search a space of logical relations. The algorithm supports the *and* of multiple goals as well as back chaining from a goal to premises.

5.2 Pattern-Directed Search

In Section 5.2 we apply recursive search to a space of logical inferences; the result is a general search procedure for predicate calculus.

Suppose, for example, we want to write an algorithm that determines whether a predicate calculus expression is a logical consequence of some set of assertions. The algorithm must find a sequence of inferences that produce the goal expression. This suggests a goal-directed search with the initial query forming the goal, and modus ponens defining the transitions between states. Given a goal (such as $p(a)$), the algorithm uses unification to select the implications whose conclusions match the goal (e.g., $q(X) \rightarrow p(X)$). Because the algorithm treats implications as potential rules for solving the query, they are often simply called *rules*. After unifying the goal with the conclusion of the implication (or rule) and applying the resulting substitutions throughout the rule, the rule premise becomes a new goal ($q(a)$). This is called a *subgoal*. The algorithm then recurs on the subgoal. If a subgoal matches a fact in the knowledge base, search terminates. The series of inferences that led from the initial goal to the given facts prove the truth of the original goal.

```
function pattern_search (current_goal);

begin
  if current_goal is a member of closed                               % test for loops
  then return fail
  else add current_goal to closed;
  while there remain in data base unifying facts or rules do
  begin
    case
      current_goal unifies with a fact:
        return success;
      current_goal is a conjunction ( $p \wedge \dots$ ):
        begin
          for each conjunct do
            call pattern_search on conjunct;
          if pattern_search succeeds for all conjuncts
          then return success
          else return fail
        end;
      current_goal unifies with rule conclusion ( $p \text{ in } q \rightarrow p$ ):
        begin
          apply goal unifying substitutions to premise ( $q$ );
          call pattern_search on premise;
          if pattern_search succeeds
          then return success
          else return fail
        end;
    end;
  end;
  return fail
end.
```

In the function `pattern_search`, search is performed by a modified version of the recursive search algorithm that uses unification, Section 2.3.2, to determine when two expressions match and modus ponens to generate the children of states. The current focus of the search is represented by the variable `current_goal`. If `current_goal` matches with a fact, the algorithm returns `success`. Otherwise the algorithm attempts to match `current_goal` with the conclusion of some rule, recursively attempting to solve the premise. If `current_goal` does not match any of the given assertions, the algorithm returns `fail`. This algorithm also handles conjunctive goals such as are often found in the premise of a rule.

For simplicity, this algorithm does not address the problem of maintaining consistency among the variable substitutions produced by unification. This is important when solving conjunctive queries with shared variables (as in $p(X) \wedge q(X)$). Not only must both conjuncts succeed, but they must succeed with unifiable bindings for X , Section 2.3.2. This problem is addressed at the end of this section.

The major advantage of using general methods such as unification and modus ponens to generate states is that the resulting algorithm may search *any* space of logical inferences. The specifics of a problem are described using predicate calculus assertions. Thus, we have a means of separating problem-solving knowledge from its control and implementation on the computer. `pattern_search` provides our first implementation of the separation of knowledge and control.

5.2.1 Example: Recursive Search in the Knight's Tour Problem

The use of predicate calculus with a general controller to solve search problems is illustrated through an example: a reduced version of the *knight's tour problem*. In the game of chess, a knight can move two squares either horizontally or vertically followed by one square in an orthogonal direction as long as it does not move off the board. There are thus at most eight possible moves that the knight may make (Figure 5.1).

As traditionally defined, the knight's tour problem attempts to find a series of legal moves in which the knight lands on each square of the chessboard exactly once. This problem has been a mainstay in the development and presentation of search algorithms. The example given in this chapter is a simplified version of the knight's tour problem: is there a series of legal moves that will take the knight from one square to another on a reduced-size (3×3) chessboard? (The details of the full knight's tour problem on an 8×8 chessboard are discussed in Examples 5.3.2 and 5.3.3.)

Figure 5.2 shows a 3×3 chessboard with each square labeled with integers 1 to 9. This labeling scheme is used instead of the more general approach of giving each space a row and column number in order to further simplify the example. Because of the reduced size of the problem, we simply enumerate the alternative moves rather than developing a general move operator. The legal moves on the board are then described in predicate calculus using a predicate called `move`, whose parameters are the starting and ending squares of a legal move. For example, `move(1,8)` takes the knight from the upper left-hand corner to the middle of the bottom row. The predicates of Figure 5.2 enumerate all possible moves for the 3×3 chessboard.

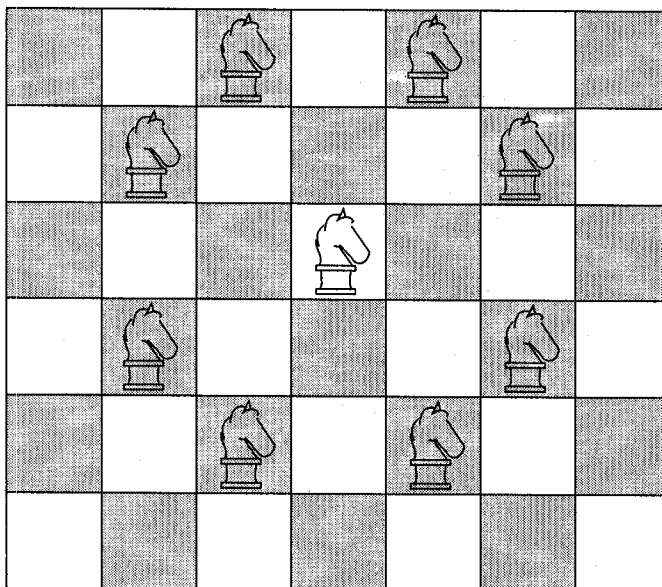

Figure 5.1 Legal moves of a chess knight.

move(1,8). move(6,1).
 move(1,6). move(6,7).
 move(2,9). move(7,2).
 move(2,7). move(7,6).
 move(3,4). move(8,3).
 move(3,8). move(8,1).
 move(4,9). move(9,2).
 move(4,3). move(9,4).

1	2	3
4	5	6
7	8	9

Figure 5.2 A 3×3 chessboard with move rules.

These predicates form the knowledge base for the knight's tour problem. As an example of how unification is used to access this knowledge base, we test for the existence of various moves on the board. To determine whether there is a move from 1 to 8, call `pattern_search(move(1,8))`. Because this goal unifies with `move(1,8)` in the knowledge base, the result is `success`, with no variable substitutions required.

Another request might be to find where the knight can move from a particular location, such as square 2. The goal `move(2,X)` unifies with two different predicates in the knowledge base, with the substitutions of `{7/X}` and `{9/X}`. Given the goal `move(2,3)`, the response is `fail`, because no `move(2,3)` exists in the knowledge base. The goal query `move(5,Y)` also fails because no assertions exist that define a move from square 5.

The next task in constructing a search algorithm is to devise a general definition for a path of successive moves around the board. This is done through the use of predicate calculus implications. These are added to the knowledge base as *rules* for creating paths of successive moves. To emphasize the goal-directed use of these rules, we have reversed the direction of the implication arrow; i.e., the rules are written as **Conclusion ← Premise**.

For example, a two-move path could be formulated as:

$$\forall X,Y [\text{path2}(X,Y) \leftarrow \exists Z [\text{move}(X,Z) \wedge \text{move}(Z,Y)]]$$

This rule says that for all locations *X* and *Y*, a two-move path exists between them if there exists a location *Z* such that the knight can move from *X* to *Z* and then move from *Z* to *Y*.

The general *path2* rule can be applied in a number of ways. First, it may be used to determine whether there is a two-move path from one location to another. If *pattern_search* is called with the goal *path2*(1,3), it matches the goal with the consequence of the rule *path2*(*X*,*Y*), and the substitutions are made in the rule's premise; the result is a specific rule that defines the conditions required for the path:

$$\text{path2}(1,3) \leftarrow \exists Z [\text{move}(1,Z) \wedge \text{move}(Z,3)]$$

pattern_search then calls itself on this premise. Because this is a conjunction of two expressions, *pattern_search* will attempt to solve each subgoal separately. This requires not only that both subgoals succeed but also that any variable bindings be consistent across subgoals. Substituting 8 for *Z* allows both subgoals to succeed.

Another request might be to find all locations that can be reached in two moves from location 2. This is accomplished by giving *pattern_search* the goal *path2*(2,*Y*). Through a similar process, a number of such substitutions may be found, including {6/*Y*} and {2/*Y*} (with intermediate *Z* being 7) and {2/*Y*} and {4/*Y*} (with intermediate location 9). Further requests could be to find a two-move path from a number to itself, from any number to 5, and so on. Notice here one of the advantages of pattern-driven control: a variety of queries may be taken as the initial goal.

Similarly, a three-move path is defined as including two intermediate locations that are part of the path from the initial location to the goal. This is defined by:

$$\forall X,Y [\text{path3}(X,Y) \leftarrow \exists Z,W [\text{move}(X,Z) \wedge \text{move}(Z,W) \wedge \text{move}(W,Y)]]$$

This clause can solve such goals as *path3*(1,2), *path3*(1,*X*), or even *path3*(*X*,*Y*). Tracing the results of these queries is left as an exercise.

It soon becomes evident that the path moves are the same for a path of any length, simply requiring the proper number of intermediate places to "land." It is also evident that the path moves could be stated in terms of each other, such as:

$$\forall X,Y [\text{path3}(X,Y) \leftarrow \exists Z [\text{move}(X,Z) \wedge \text{path2}(Z,Y)]]$$

This suggests the single, general recursive rule:

$$\forall X,Y [\text{path}(X,Y) \leftarrow \exists Z [\text{move}(X,Z) \wedge \text{path}(Z,Y)]]$$

The last path rule can be used to determine whether a path of any length exists. The rule may be stated as “to find a path from one square to another, first make a move from the starting square to an intermediate location and then find a path from the intermediate to the final square.”

This recursive “path” rule is incomplete in that it includes no terminating condition. Any attempt to solve a goal involving the path predicate would fail to halt because each attempt to solve the rule premise would lead to another recursive call on path(Z,Y). There is no test in the rule to determine whether the desired goal state is ever reached. This can be remedied by adding the clause path(X,X) to the knowledge base. Because path(X,X) will unify only with predicates such as path(3,3) or path(5,5), it defines the desired terminating condition. The general recursive path definition is then given by two predicate calculus formulas:

$$\begin{aligned} &\forall X \text{ path}(X,X) \\ &\forall X,Y [\text{path}(X,Y) \leftarrow \exists Z [\text{move}(X,Z) \wedge \text{path}(Z,Y)]] \end{aligned}$$

Note once again the elegance and simplicity of the recursive formulation. When combined with the recursive control provided by pattern_search, these rules will search the space of possible paths in the knight’s tour problem. Combined with the move rules, this yields the complete problem description (or knowledge base):

move(1,8).	move(1,6).	move(2,9).	move(2,7).
move(3,4).	move(3,8).	move(4,9).	move(4,3).
move(6,1).	move(6,7).	move(7,2).	move(7,6).
move(8,3).	move(8,1).	move(9,2).	move(9,4).

$$\begin{aligned} &\forall X \text{ path}(X,X) \\ &\forall X,Y [\text{path}(X,Y) \leftarrow \exists Z [\text{move}(X,Z) \wedge \text{path}(Z,Y)]] \end{aligned}$$

It is important to note that the solution to the problem is implemented through *both* the logical descriptions that define the state space and the use of pattern_search to control search of that space. Although the path rule is a satisfactory definition of a path, it does not tell us how to find that path. Indeed, many undesirable or meaningless paths around the chessboard also fit this definition. For example, without some way to prevent loops, the goal path(1,3) could lead to a path that simply goes back and forth between 1 and 8, instead of finding the correct path from 1 to 8 to 3. Both the loop and the correct path are logical consequences of the knowledge base. Similarly, if the recursive rule is tried before the terminating condition, the fact that path(3,3) should terminate the search could be overlooked, allowing the search to continue meaninglessly.

5.2.2 Refining the Pattern-search Algorithm

Although the initial version of pattern_search defined the behavior of a search algorithm for predicate calculus expressions, several subtleties must still be addressed. These include the order with which the algorithm tries alternative matches and proper

handling of the full set of logical operators (\wedge , \vee , and \neg). Logic is nondeterministic: it defines a space of possible inferences but does not tell a problem solver how to make the useful ones.

To reason with predicate calculus, we need a control regime that systematically searches the space, avoiding meaningless paths and loops. A control algorithm such as `pattern_search` must try alternative matches in some sequential order. Knowing this order allows the program designer to control search by properly ordering rules in the knowledge base. The simplest way to define such an order is to require that the algorithm try rules and facts in the order in which they appear in the knowledge base. In the knight's tour, this ensures that the terminating condition (`path(X,X)`) is tried before the recursive step.

A second issue is the existence of logical connectives in the rule premises: e.g., implications of the form " $p \leftarrow q \wedge r$ " or " $p \leftarrow q \vee (r \wedge s)$." As will be recalled from the discussion of and/or graphs, an \wedge operator indicates that both expressions must be shown to be true for the entire premise to be true. In addition, the conjuncts of the expression must be solved with consistent variable bindings. Thus, to solve $p(X) \wedge q(X)$, it is not sufficient to solve $p(X)$ with the substitution $\{a/X\}$ and $q(X)$ with the substitution $\{b/X\}$. Both must be solved with the same or unifiable bindings for X . An \vee operator, on the other hand, indicates that either expression must be found to be true. The search algorithm must take this into account.

The last addition to the algorithm is the ability to solve goals involving logical negation (\neg). `pattern_search` handles negated goals by first solving the operand of the \neg . If this subgoal succeeds, then `pattern_search` returns `fail`. If the operand fails, then `pattern_search` returns an empty substitution set, indicating success. Note that even though a subgoal may contain variables, the result of solving its negation may not contain any substitutions. This is because \neg can succeed only if its operand *fails*; hence, it cannot return any bindings for the operand.

Finally, the algorithm should not return `success` but should return the bindings involved in the solution. Consider the goal `move(1,X)`; the substitutions $\{6/X\}$ and $\{8/X\}$ are an essential part of the solution.

The complete version of `pattern_search`, which returns the set of unifications that satisfies each subgoal, is:

```
function pattern_search(current_goal);  
  
begin  
  
    if current_goal is a member of closed                               % test for loops  
    then return fail else add current_goal to closed;  
    while there remain unifying facts or rules do  
    begin  
  
        case  
  
            current_goal unifies with a fact:  
            return unifying substitutions;
```

```

current_goal is negated ( $\neg p$ ):
  begin
    call pattern_search on p;
    if pattern_search returns fail
      then return {};
    else return fail;
  end;
% negation is true

current_goal is a conjunction ( $p \wedge \dots$ ):
  begin
    for each conjunct do
      begin
        call pattern_search on conjunct;
        if pattern_search returns fail
          then return fail;
        else apply substitutions to other conjuncts;
      end;
    if pattern_search succeeds for all conjuncts
      then return composition of unifications ;
    else return fail;
  end;

current_goal is a disjunction ( $p \vee \dots$ ):
  begin
    repeat for each disjunct
      call pattern_search on disjunct
    until no more disjuncts or success;
    if pattern_search succeeds
      then return substitutions
    else return fail;
  end;

current_goal unifies with rule conclusion ( $p$  in  $p \leftarrow q$ ):
  begin
    apply goal unifying substitutions to premise (q);
    call pattern_search on premise;
    if pattern_search succeeds
      then return composition of p and q substitutions
    else return fail;
  end;
end;
% end case

return fail
end.

```

This algorithm for searching a space of predicate calculus rules and facts is the basis of PROLOG and many goal-directed expert system shells. Its behavior is further illustrated in Chapters 9 and 10. An alternative control structure for pattern-directed search is provided by the *production system*, discussed in the next section.

5.3 Production Systems

5.3.1 Definition and History

The *production system* is a model of computation that has proved particularly important in AI, both for implementing search algorithms and for modeling human problem solving. A production system provides pattern-directed control of a problem-solving process and consists of a set of *production rules*, a *working memory*, and a *recognize-act* control cycle.

DEFINITION

PRODUCTION SYSTEM

A *production system* is defined by:

1. *The set of production rules.* These are often simply called *productions*. A production is a *condition-action* pair and defines a single chunk of problem-solving knowledge. The *condition part* of the rule is a pattern that determines when that rule may be applied to a problem instance. The *action part* defines the associated problem-solving step.
2. *Working memory* contains a description of the *current state of the world* in a reasoning process. This description is a pattern that is matched against the condition part of a production to select appropriate problem-solving actions. When the condition element of a rule is matched by the contents of working memory, the action associated with that condition may then be performed. The actions of production rules are specifically designed to alter the contents of working memory.
3. *The recognize-act cycle.* The control structure for a production system is simple: *Working memory* is initialized with the beginning problem description. The current state of the problem-solving is maintained as a set of patterns in working memory. These patterns are matched against the conditions of the production rules; this produces a subset of the production rules, called the *conflict set*, whose conditions match the patterns in working memory. The productions in the conflict set are said to be *enabled*. One of the productions in the conflict set is then selected (*conflict resolution*) and the production is *fired*. To fire a rule, its *action* is performed, changing the contents of working memory. After the selected production rule is fired, the control cycle repeats with the modified working memory. The process terminates when the contents of working memory do not match any rule conditions.

Conflict resolution chooses a rule from the conflict set for firing. Conflict resolution strategies may be simple, such as selecting the first rule whose condition

matches the state of the world, or may involve complex rule selection heuristics. This is an important way in which a production system allows the addition of heuristic control to a search algorithm.

The *pure* production system model has no mechanism for recovering from dead ends in the search; it simply continues until no more productions are enabled and halts. Many practical implementations of production systems allow backtracking to a previous state of working memory in such situations.

A schematic drawing of a production system is presented in Figure 5.3.

A very simple example of production system execution appears in Figure 5.4. This is a production system program for sorting a string composed of the letters a, b, and c. In this example, a production is enabled if its condition matches a portion of the string in working memory. When a rule is fired, the substring that matched the rule condition is replaced by the string on the right-hand side of the rule. Production systems are a general model of computation that can be programmed to do anything that can be done on a computer. Their real strength, however, is as an architecture for knowledge-based systems.

The idea for the “production”-based design for computing came originally from writings of Post (1943), who proposed a production rule model as a formal theory of computation. The main construct of this theory was a set of rewrite rules for strings in many ways similar to the parsing rules in Example 3.3.6. It is also closely related to the approach taken by Markov algorithms (Markov 1954) and, like them, is equivalent in power to a Turing machine.

An interesting application of production rules to modeling human cognition is found in the work of Newell and Simon at the Carnegie Institute of Technology (now Carnegie Mellon University) in the 1960s and 1970s. The programs they developed, including the *General Problem Solver*, are largely responsible for the importance of production systems in AI. In this research, human subjects were monitored in various problem-solving activities such as solving problems in predicate logic and playing games like chess. The *protocol* (behavior patterns, including verbal descriptions of the problem-solving process, eye movements, etc.) of problem-solving subjects was recorded and broken down to its elementary components. These components were regarded as the basic bits of problem-solving knowledge in the human subjects and were composed as a search through a graph (called the *problem behavior graph*). A production system was then used to implement search of this graph.

The production rules represented the set of problem-solving skills of the human subject. The present focus of attention was represented as the current state of the world. In executing the production system, the “attention” or “current focus” of the problem solver would match a production rule, which would change the state of “attention” to match another production-encoded skill, and so on.

It is important to note that in this work Newell and Simon used the production system not only as a vehicle for implementing graph search but also as an actual model of human problem-solving behavior. The productions corresponded to the problem-solving skills in

the human's *long-term memory*. Like the skills in long-term memory, these productions are not changed by the execution of the system; they are invoked by the "pattern" of a particular problem instance, and new skills may be added without requiring "recoding" of the previously existing knowledge. The production system's working memory corresponds to *short-term memory* or current focus of attention in the human and describes the current stage of solving a problem instance. The contents of working memory are generally not retained after a problem has been solved.

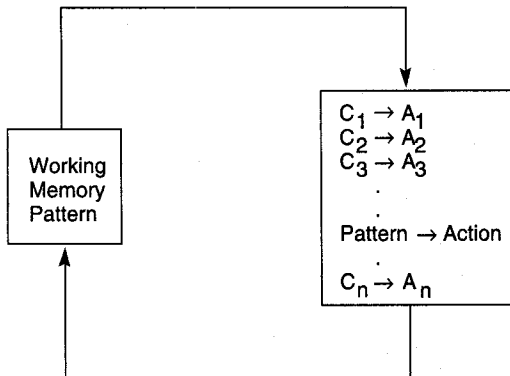

Figure 5.3 A production system. Control loops until working memory pattern no longer matches the conditions of any productions.

Production set:

1. $ba \rightarrow ab$
2. $ca \rightarrow ac$
3. $cb \rightarrow bc$

Iteration #	Working memory	Conflict set	Rule fired
0	cbaca	1, 2, 3	1
1	cabca	2	2
2	acbca	3, 2	2
3	acbac	1, 3	1
4	acabc	2	2
5	aacbc	3	3
6	aabcc	\emptyset	Halt

Figure 5.4 Trace of a simple production system.

This research is described in *Human Problem Solving* by Newell and Simon (1972) and in Luger (1978, 1994). Newell, Simon, and others have continued to use production rules to model the difference between novices and experts (Larkin et al. 1980; Simon and Simon 1978) in areas such as solving algebra word problems and physics problems. Production systems also form a basis for studying learning in both humans and computers (Klahr et al. 1987); ACT* (Anderson 1983b) and SOAR (Newell 1990) build on this tradition.

Production systems provide a model for encoding human expertise in the form of rules and designing pattern-driven search algorithms, tasks that are central to the design of the rule-based expert system. In expert systems, the production system is not necessarily assumed to actually model human problem-solving behavior; however, the aspects of production systems that make them useful as a potential model of human problem solving (modularity of rules, separation of knowledge and control, separation of working memory and problem-solving knowledge) make them an ideal tool for designing and building expert systems.

An important family of AI languages comes directly out of the production system language research at Carnegie Mellon. These are the OPS languages; OPS stands for Official Production System. Although their origins are in modeling human problem solving, these languages have proved highly effective for programming expert systems and for other AI applications. OPS5 is the implementation language for the VAX configurer XCON and other expert systems developed at Digital Equipment Corporation (McDermott 1981, 1982; Soloway et al. 1987; Barker and O'Connor 1989). OPS interpreters are widely available for PCs and workstations. CLIPS, implemented in the C programming language, is a widely used, object-oriented version of a production system built by NASA.

In the next section we give examples of how the production system may be used to solve a variety of search problems.

5.3.2 Examples of Production Systems

EXAMPLE 5.3.1: THE 8-PUZZLE

The search space generated by the 8-puzzle, introduced in Chapter 3, is both complex enough to be interesting and small enough to be tractable, so it is frequently used to explore different search strategies, such as depth-first and breadth-first search, as well as the heuristic strategies discussed in Chapter 4. It also lends itself to solution using a production system.

Recall that we gain generality by thinking of “moving the blank space” rather than moving a numbered tile. Legal moves are defined by the productions in Figure 5.5. Of course, all four of these moves are applicable only when the blank is in the center; when it is in one of the corners only two moves are possible. If a beginning state and a goal state for the 8-puzzle are now specified, it is possible to make a production system accounting of the problem’s search space.

An actual implementation of this problem might represent each board configuration with a “state” predicate with nine parameters (for nine possible locations of the eight tiles

Start state:

2	8	3
1	6	4
7	■	5

Goal state:

1	2	3
8	■	4
7	6	5

Production set:

Condition	Action
goal state in working memory	→ halt
blank is not on the top edge	→ move the blank up
blank is not on the right edge	→ move the blank right
blank is not on the bottom edge	→ move the blank down
blank is not on the left edge	→ move the blank left

Working memory is the present board state and goal state.

Control regime:

1. Try each production in order.
2. Do not allow loops.
3. Stop when goal is found.

Figure 5.5 The 8-puzzle as a production system.

and the blank); rules could be written as implications whose premise performs the required condition check. Alternatively, arrays or list structures could be used for board states.

An example of the space searched in finding a solution for the problem given in Figure 5.5 follows in Figure 5.6. Because this solution path can go very deep if unconstrained, a depth bound has been added to the search. (A simple means for adding a depth bound is to keep track of the length of the current path and to force backtracking if this bound is exceeded.) A depth bound of 5 is used in the solution of Figure 5.6. Note that the number of possible states of working memory grows exponentially with the depth of the search.

EXAMPLE 5.3.2: THE KNIGHT'S TOUR PROBLEM

The 3×3 knight's tour problem presented in Section 5.2 may be solved using a production system approach. Here each move would be represented as a rule whose condition is the location of the knight on a particular square and whose action moves the knight to another square. Sixteen productions represent all possible moves of the knight.

Working memory contains both the current board state and the goal state. The control regime applies rules until the current state equals the goal state and then halts. A simple conflict resolution scheme would fire the first rule that did not cause the search to loop. Because the search may lead to dead ends (from which every possible move leads to a

previously visited state and, consequently, a loop), the control regime should also allow backtracking: An execution of this production system that determines whether a path exists from square 1 to square 2 is charted in Figure 5.7.

RULE #	CONDITION	ACTION
1	knight on square 1	→ move knight to square 8
2	knight on square 1	→ move knight to square 6
3	knight on square 2	→ move knight to square 9
4	knight on square 2	→ move knight to square 7
5	knight on square 3	→ move knight to square 4
6	knight on square 3	→ move knight to square 8
7	knight on square 4	→ move knight to square 9
8	knight on square 4	→ move knight to square 3

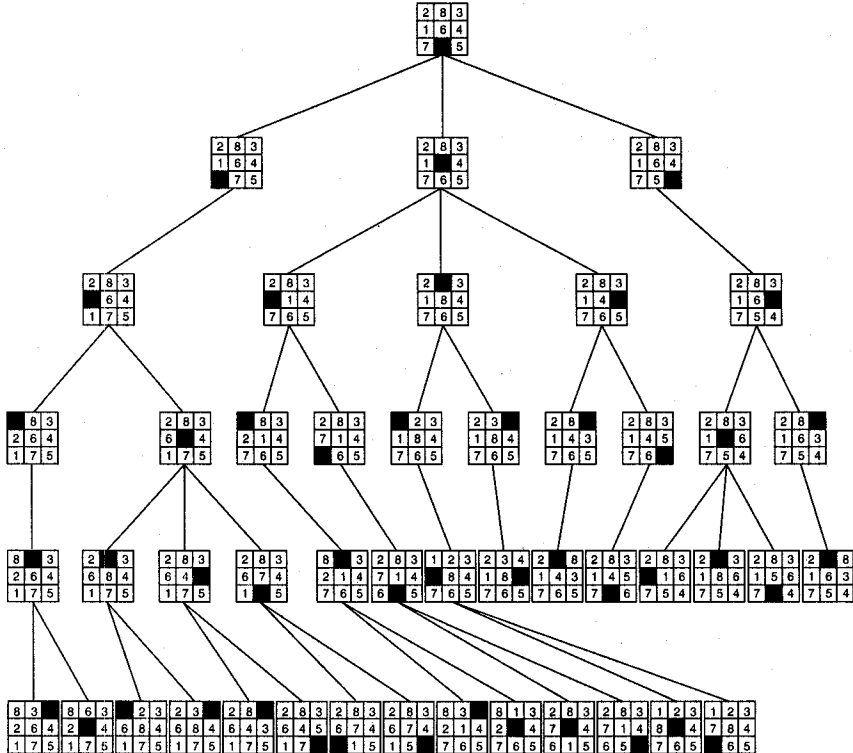

Figure 5.6 State space of the 8-puzzle searched by a production system with loop detection and a depth bound of 5.

RULE #	CONDITION	ACTION
9	knight on square 6	→ move knight to square 1
10	knight on square 6	→ move knight to square 7
11	knight on square 7	→ move knight to square 2
12	knight on square 7	→ move knight to square 6
13	knight on square 8	→ move knight to square 3
14	knight on square 8	→ move knight to square 1
15	knight on square 9	→ move knight to square 2
16	knight on square 9	→ move knight to square 4

It is interesting to note that in implementing the path predicate in the knight's tour example of Section 5.2, we have actually implemented this production system solution! From this point of view, `pattern_search` is simply an interpreter, with the actual search implemented by the `path` definition. The productions are the `move` facts, with the first parameter specifying the condition (the square the piece must be on to make the move) and the second parameter, the action (the square to which it can move). The recognize-act cycle is implemented by the recursive `path` predicate. Working memory contains the current state and the desired goal state and is represented as the parameters of the `path` predicate. On a given iteration, the conflict set is all of the move expressions that will unify with the goal `move(X,Z)`. This program uses the simple conflict resolution strategy of selecting and firing the first move predicate encountered in the knowledge base that does not lead to a repeated state. The controller also backtracks from dead-end states. This characterization of the `path` definition as a production system is given in Figure 5.8.

Production systems are capable of generating infinite loops when searching a state space graph. These loops are particularly difficult to spot in a production system because the rules can fire in any order. That is, looping may appear in the execution of the system, but it cannot easily be found from a syntactic inspection of the rule set. For example, with

Iteration #	Working memory		Conflict set (rule #'s)	Fire rule
	Current square	Goal square		
0	1	2	1, 2	1
1	8	2	13, 14	13
2	3	2	5, 6	5
3	4	2	7, 8	7
4	9	2	15, 16	15
5	2	2		Halt

Figure 5.7 Production system solution to the 3×3 knight's tour problem.

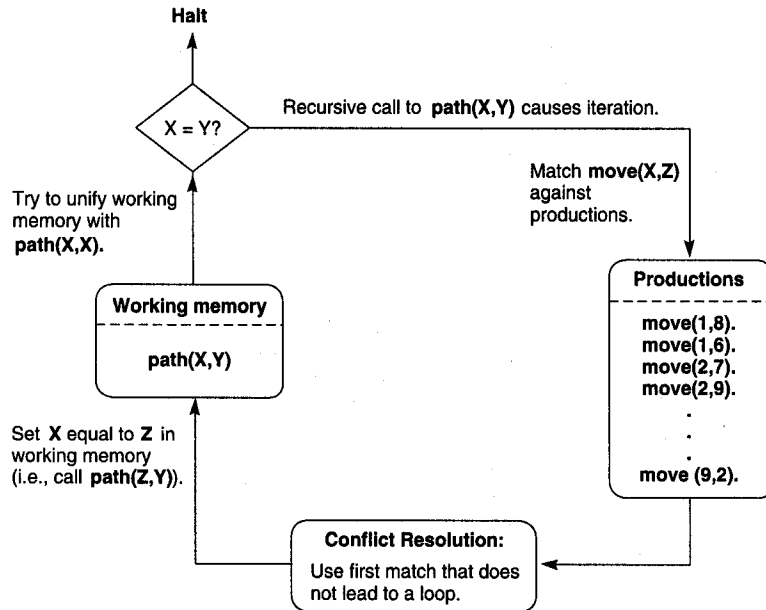

Figure 5.8 Recursive path algorithm as a production system.

the “move” rules of the knight’s tour problem ordered as in Section 5.2 and a conflict resolution strategy of selecting the first match, the pattern $\text{move}(2,X)$ would match with $\text{move}(2,9)$, indicating a move to square 9. On the next iteration, the pattern $\text{move}(9,X)$ would match with $\text{move}(9,2)$, taking the search back to square 2, causing a loop.

To prevent looping, `pattern_search` checked a global list (`closed`) of visited states. The actual conflict resolution strategy was therefore: select the first matching move *that leads to an unvisited state*.

In a production system, the proper place for recording such case-specific data as a list of previously visited states is not a global `closed` list but the working memory itself. We can alter the `path` predicate to use working memory for loop detection.

Assume that `pattern_search` does not maintain a global `closed` list or otherwise perform loop detection. Assume that our predicate calculus language is augmented by the addition of a special construct, `assert(X)`, which causes its argument `X` to be entered into the working memory. `assert` is not an ordinary predicate but an action that is performed; hence, it always succeeds.

`assert` is used to place a “marker” in working memory to indicate when a state has been visited. This marker is represented as a unary predicate, `been(X)`, which takes as its argument a square on the board. `been(X)` is added to working memory when a new state `X` is visited. Conflict resolution may then require that `been(Z)` must not be in working memory before `move(X,Z)` can fire. For a specific value of `Z` this can be tested by matching a pattern against working memory.

The modified recursive path definition is written:

$\forall X \text{ path}(X,X).$

$\forall X,Y \text{ path}(X,Y) \leftarrow \exists Z \text{ move}(X,Z) \wedge \neg (\text{been}(Z)) \wedge \text{assert}(\text{been}(Z)) \wedge \text{path}(Z,Y).$

In this definition, $\text{move}(X,Z)$ succeeds on the first match with a move predicate. This binds a value to Z . If $\text{been}(Z)$ matches with an entry in working memory, $\neg(\text{been}(Z))$ will cause a failure (i.e., it will be false). pattern_search will then backtrack and try another match for $\text{move}(X,Z)$. If square Z is a new state, the search will continue, with $\text{been}(Z)$ asserted to the working memory to prevent future loops. The actual firing of the production takes place when the path algorithm recurs. Thus, the presence of been predicates in working memory implements loop detection in this production system.

Note that although predicate calculus is used as the language for both productions and working memory entries, the procedural nature of production systems requires that the goals be tested in left-to-right order in the path definition. This order of interpretation is provided by pattern_search .

EXAMPLE 5.3.3: THE FULL KNIGHT'S TOUR

We may generalize the knight's tour solution to the full 8×8 chessboard. Because it makes little sense to enumerate moves for such a complex problem, we replace the 16 move facts with a set of 8 rules to generate legal knight moves. These moves (productions) correspond to the 8 possible ways a knight can move (Figure 5.1).

If we index the chessboard by row and column numbers, we can define a production rule for moving the knight down two squares and right one square:

CONDITION: $\text{current row} \leq 6 \wedge \text{current column} \leq 7$

ACTION: $\text{new row} = \text{current row} + 2 \wedge \text{new column} = \text{current column} + 1$

If we use predicate calculus to represent productions, then a board square could be defined by the predicate $\text{square}(R,C)$, representing the R th row and C th column of the board. The above rule could be rewritten in predicate calculus as:

$\text{move}(\text{square}(\text{Row}, \text{Column}), \text{square}(\text{Newrow}, \text{Newcolumn})) \leftarrow$
 $\text{less_than_or_equals}(\text{Row}, 6) \wedge$
 $\text{equals}(\text{Newrow}, \text{plus}(\text{Row}, 2)) \wedge$
 $\text{less_than_or_equals}(\text{Column}, 7) \wedge$
 $\text{equals}(\text{Newcolumn}, \text{plus}(\text{Column}, 1)).$

plus is a function for addition; $\text{less_than_or_equals}$ and equals have the obvious arithmetic interpretations. Seven additional rules can be designed that similarly compute the remaining possible moves. These eight rules replace the move facts in the 3×3 version of the problem.

The path definition from the 3×3 example defines the control loop for this problem. As we have seen, when predicate calculus descriptions are interpreted procedurally, such as through the pattern_search algorithm, subtle changes are made to the semantics of predicate calculus. One such change is the sequential fashion in which goals are solved. This imposes an ordering, or *procedural semantics*, on predicate calculus expressions.

Production set:

1. $p \wedge q \rightarrow \text{goal}$
2. $r \wedge s \rightarrow p$
3. $w \wedge r \rightarrow q$
4. $t \wedge u \rightarrow q$
5. $v \rightarrow s$
6. $\text{start} \rightarrow v \wedge r \wedge q$

Trace of execution:

Iteration #	Working memory	Conflict set	Rule fired
0	start	6	6
1	start, v, r, q	6, 5	5
2	start, v, r, q, s	6, 5, 2	2
3	start, v, r, q, s, p	6, 5, 2, 1	1
4	start, v, r, q, s, p, goal	6, 5, 2, 1	halt

Space searched by execution:**Figure 5.9** Data-driven search in a production system.

Another change is the introduction of *meta-logical* predicates such as **assert**, which indicate actions beyond the truth value interpretation of predicate calculus expressions. These issues are discussed in more detail in the PROLOG, Chapter 9, and in the LISP implementation of a logic programming engine, Chapter 10.

EXAMPLE 5.3.4: THE FINANCIAL ADVISOR AS A PRODUCTION SYSTEM

In Chapters 2 and 3, we developed a small financial advisor, using predicate calculus to represent the financial knowledge and graph search to make the appropriate inferences in a consultation. The production system provides a natural vehicle for its implementation. The implications of the logical description form the productions. The case-specific information (an individual's salary, dependents, etc.) is loaded into working memory. Rules are enabled when their premises are satisfied. A rule is chosen from this conflict set and fired, adding its conclusion to working memory. This continues until all possible top-level conclusions have been added to the working memory. Indeed, many expert system "shells" are production systems with added features for supporting the user interface, handling uncertainty in the reasoning, editing the knowledge base, and tracing execution.

5.3.3 Control of Search in Production Systems

The production system model offers a range of opportunities for adding heuristic control to a search algorithm. These include the choice of data-driven or goal-driven strategies, the structure of the rules themselves, and the choice of strategies for conflict resolution.

Production set:

1. $p \wedge q \rightarrow \text{goal}$
2. $r \wedge s \rightarrow p$
3. $w \wedge r \rightarrow p$
4. $t \wedge u \rightarrow q$
5. $v \rightarrow s$
6. $\text{start} \rightarrow v \wedge r \wedge q$

Trace of execution:

Iteration #	Working memory	Conflict set	Rule fired
0	goal	1	1
1	goal, p, q	1, 2, 3, 4	2
2	goal, p, q, r, s	1, 2, 3, 4, 5	3
3	goal, p, q, r, s, w	1, 2, 3, 4, 5	4
4	goal, p, q, r, s, w, t, u	1, 2, 3, 4, 5	5
5	goal, p, q, r, s, w, t, u, v	1, 2, 3, 4, 5, 6	6
6	goal, p, q, r, s, w, t, u, v, start	1, 2, 3, 4, 5, 6	halt

Space searched by execution:

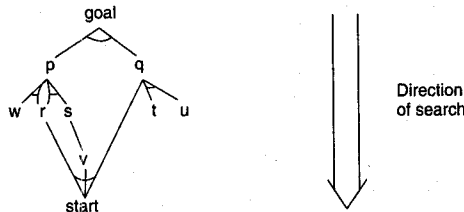

Figure 5.10 Goal-driven search in a production system.

Control through Choice of Data-Driven or Goal-Driven Search Strategy

Data-driven search begins with a problem description (such as a set of logical axioms, symptoms of an illness, or a body of data that needs interpretation) and infers new knowledge from the data. This is done by applying rules of inference, legal moves in a game, or other state-generating operations to the current description of the world and adding the results to that problem description. This process continues until a goal is reached.

This description of data-driven reasoning emphasizes its close fit with the production system model of computation. The “current state of the world” (data that have been either assumed to be true or deduced as true with previous use of production rules) is placed in working memory. The recognize-act cycle then matches the current state against the (ordered) set of productions. When these data match (are unified with) the condition(s) of one of the production rules, the action of the production adds (by modifying working memory) a new piece of information to the current state of the world.

All productions have the form **CONDITION** \rightarrow **ACTION**. When the **CONDITION** matches some elements of working memory, its **ACTION** is performed. If the production rules are formulated as logical implications and the **ACTION** adds assertions to working memory, then the act of firing a rule corresponds to an application of modus ponens. This creates a new state of the graph.

Figure 5.9 presents a simple data-driven search on a set of productions expressed as propositional calculus implications. The conflict resolution strategy is a simple one of choosing the enabled rule that has fired least recently (or not at all); in the event of ties, the first rule is chosen. Execution halts when a goal is reached. The figure also presents the sequence of rule firings and the stages of working memory in the execution, along with a graph of the space searched.

Although we have treated production systems in a data-driven fashion, they may also be used to characterize goal-driven search. As defined in Chapter 3, goal-driven search begins with a goal and works backward to establish its truth. To implement this in a production system, the goal is placed in working memory and matched against the **ACTIONS** of the production rules. These **ACTIONS** are matched (by unification, for example) just as the **CONDITIONS** of the productions were matched in the data-driven reasoning. All production rules whose conclusions (**ACTIONS**) match the goal form the conflict set.

When the **ACTION** of a rule is matched, the **CONDITIONS** are added to working memory and become the new subgoals (states) of the search. The new states are then matched to the **ACTIONS** of other production rules. The process continues until a fact is found, usually in the problem's initial description or, as is often the case in expert systems, by directly asking the user for specific information. The search stops when the **CONDITIONS** of all the productions fired in this backward fashion are found to be true. These **CONDITIONS** and the chain of rule firings leading to the original goal form a proof of its truth through successive inferences such as *modus ponens*. See Figure 5.10 for an instance of goal-driven reasoning on the same set of productions used in Figure 5.9. Note that the goal-driven search fires a different series of productions and searches a different space than the data-driven version.

As this discussion illustrates, the production system offers a natural characterization of both goal-driven and data-driven search. The production rules are the encoded set of inferences (the "knowledge" in a rule-based expert system) for changing state within the graph. When the current state of the world (the set of true statements describing the world) matches the **CONDITIONS** of the production rules and this match causes the **ACTION** part of the rule to create another (true) descriptor for the world, it is referred to as data-driven search.

Alternatively, when the goal is matched against the **ACTION** part of the rules in the production rule set and their **CONDITIONS** are then set up as subgoals to be shown to be "true" (by matching the **ACTIONS** of the rules on the next cycle of the production system), the result is goal-driven problem solving.

Because a set of rules may be executed in either a data-driven or goal-driven fashion, we can compare and contrast the efficiency of each approach in controlling search. The complexity of search for either strategy is measured by such notions as *branching factor* or *penetrance* (Section 4.4). These measures of search complexity can provide a cost estimate for both the data-driven and goal-driven versions of a problem solver and therefore help in selecting the most effective strategy.

We can also employ combinations of strategies. For example, we can search in a forward direction until the number of states becomes large and then switch to a goal-directed search to use possible subgoals to select among alternative states. The danger in

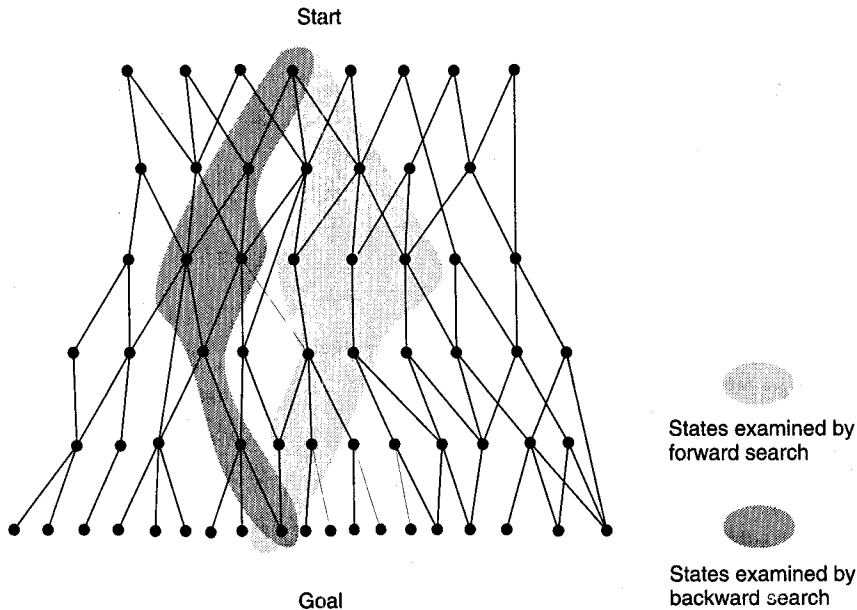

Figure 5.11 Bidirectional search missing in both directions, resulting in excessive search.

this situation is that, when heuristic or best-first search (Chapter 4) is used, the parts of the graphs actually searched may “miss” each other and ultimately require more search than a simpler approach, as in Figure 5.11. However, when the branching of a space is constant and exhaustive search is used, a combined search strategy can cut back drastically the amount of space searched. (See Figure 5.12)

Control of Search through Rule Structure

The structure of rules in a production system, including the distinction between the condition and the action and the order in which conditions are tried, determines the fashion in which the space is searched. In introducing predicate calculus as a representation language, we emphasized the *declarative* nature of its semantics. That is, predicate calculus expressions simply define true relationships in a problem domain and make no assertion about the order in which their components are interpreted. Thus, an individual rule might be $\forall X (\text{foo}(X) \wedge \text{goo}(X) \rightarrow \text{moo}(X))$. Under the rules of predicate calculus, an alternative form of the same rule is $\forall X (\text{foo}(X) \rightarrow \text{moo}(X) \vee \neg \text{goo}(X))$. The equivalence relationship between these two clauses can be demonstrated by the truth table method of Section 2.1.

Although these formulations are logically equivalent, they do not lead to the same results when interpreted as productions because the production system implementation imposes an order on the matching and firing of rules. For this reason, the specific form of the rules determines the ease (or possibility) of matching a rule against a problem instance.

This is a result of differences in the way in which the production system *interprets* the rules. The production system imposes a *procedural semantics* on the declarative language used to form the rules.

Because the production system tries rules in a specific order, the programmer may control search through the structure and order of rules in the production set. Although logically equivalent, $\forall X (\text{foo}(X) \wedge \text{goo}(X) \rightarrow \text{moo}(X))$ and $\forall X (\text{foo}(X) \rightarrow \text{moo}(X) \vee \neg \text{goo}(X))$ do not have the same behavior in a search implementation.

Human experts encode crucial heuristics within their rules of expertise. The order of premises encodes important procedural information for solving the problem. It is important that this form be preserved in building a program that “solves problems like the expert.” When a mechanic says, “If the engine won’t turn over and the lights don’t come on, then check the battery,” he or she is suggesting a specific sequence of actions. This information is not captured by the logically equivalent statement “the engine turns over or the lights come on or check the battery.” This form of the rules is critical in controlling search, making the system behave logically, making traces of rule firings more understandable, etc.

Control of Search through Conflict Resolution

Though production systems (like all architectures for knowledge-based systems) allow heuristics to be encoded in the knowledge content of rules themselves, they offer other opportunities for heuristic control through conflict resolution. Although the simplest such strategy is to choose the first rule that matches the contents of working memory, any strategy may potentially be applied to conflict resolution. For example, conflict resolution strategies supported by OPS5 (Brownston et al. 1985) include:

1. *Refraction*. Refraction specifies that once a rule has fired, it may not fire again until the working memory elements that match its conditions have been modified. This discourages looping.
2. *Recency*. The recency strategy prefers rules whose conditions match with the patterns most recently added to working memory. This focuses the search on a single line of reasoning.
3. *Specificity*. This strategy assumes that a more specific problem-solving rule is preferable to a general rule. A rule is more specific than another if it has more conditions. This implies that it will match fewer potential working memory patterns.

5.3.4 Advantages of Production Systems for AI

As illustrated by the preceding examples, the production system offers a general framework for implementing search. Because of its simplicity, modifiability, and flexibility in applying problem-solving knowledge, the production system has proved to be an important tool for the construction of expert systems and other AI applications. The major advantages of production systems for artificial intelligence include:

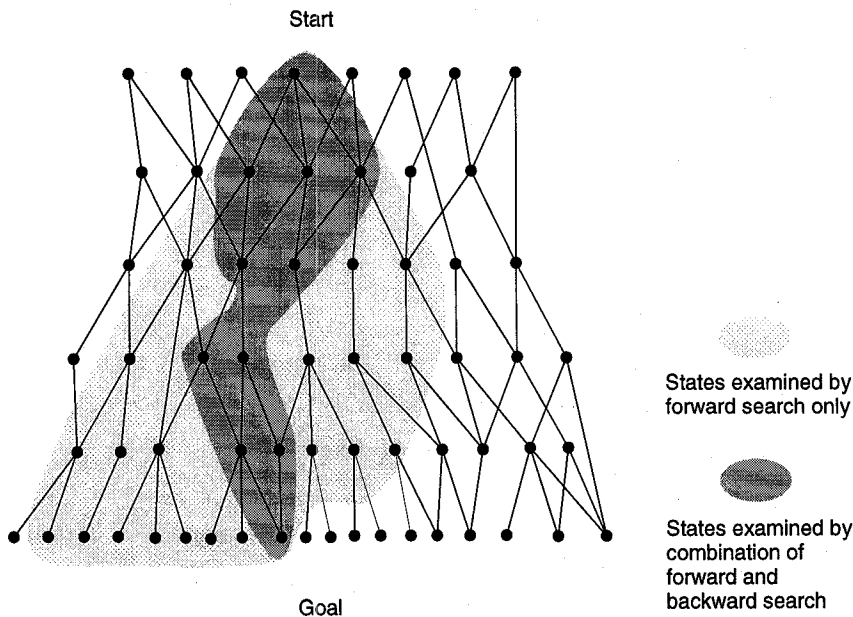

Figure 5.12 Bidirectional search meeting in the middle, eliminating much of the space examined by unidirectional search.

Separation of Knowledge and Control. The production system is an elegant model of separation of knowledge and control in a computer program. Control is provided by the recognize-act cycle of the production system loop, and the problem-solving knowledge is encoded in the rules themselves. The advantages of this separation include ease of modifying the knowledge base without requiring a change in the code for program control and, conversely, the ability to alter the code for program control without changing the set of production rules.

A Natural Mapping onto State Space Search. The components of a production system map naturally into the constructs of state space search. The successive states of working memory form the nodes of a state space graph. The production rules are the set of possible transitions between states, with conflict resolution implementing the selection of a branch in the state space. These rules simplify the implementation, debugging, and documentation of search algorithms.

Modularity of Production Rules. An important aspect of the production system model is the lack of any syntactic interactions between production rules. Rules may only effect the firing of other rules by changing the pattern in working memory; they may not “call” another rule directly as if it were a subroutine, nor may they set the value of variables in other production rules. The scope of the variables of these rules is confined to the individual rule. This syntactic independence supports the incremental development of expert systems by successively adding, deleting, or changing the knowledge (rules) of the system.

Pattern-Directed Control. The problems addressed by AI programs require particular flexibility in program execution. This goal is served by the fact that the rules in a production system may fire in any sequence. The descriptions of a problem that make up the current state of the world determine the conflict set and, consequently, the particular search path and solution.

Opportunities for Heuristic Control of Search. (Described in the preceding section.)

Tracing and Explanation. The modularity of rules and the iterative nature of their execution make it easier to trace execution of a production system. At each stage of the recognize-act cycle, the selected rule may be displayed. Because each rule corresponds to a single “chunk” of problem-solving knowledge, the rule content should provide a meaningful explanation of the system’s current state and action. In contrast, a single line of code in a traditional language such as Pascal or FORTRAN is virtually meaningless.

Language Independence. The production system control model is independent of the representation chosen for rules and working memory, as long as that representation supports pattern matching. We described production rules as predicate calculus implications of the form $A \Rightarrow B$, where the truth of A and the inference rule modus ponens allow us to conclude B . Although there are many advantages to using logic as both the basis for representation of knowledge and the source of sound inference rules, the production system model may be used with other representations.

Although predicate calculus offers the advantage of logically sound inference, many problems require reasoning that is not sound in the logical sense. Instead, they involve probabilistic reasoning, use of uncertain evidence, and default assumptions. Later chapters (6, 7, and 8) discuss alternative inference rules that provide these capabilities. Regardless of the type of inference rules employed, however, the production system provides a vehicle for searching the state space.

A Plausible Model of Human Problem Solving. Modeling human problem solving was among the first uses of production systems; they continue to be used as a model for human performance in much cognitive science research (Chapter 16).

Pattern-directed search gives us the ability to explore the space of logical inferences in the predicate calculus. Many problems build on this technique by using predicate calculus to model specific aspects of the world such as time and change. *Robot planning*, or often simply *planning*, must model the changes in the state of a world caused by actions of a robot or other agent. We use *add* and *delete* lists to represent these changes to the world and to specify new states of the search space.

5.4 Predicate Calculus and Planning

The task of a planner is to find a sequence of actions that allow a problem solver, often a robot, to accomplish some specific task. In addition to its obvious robotics applications,

planning plays a role in expert systems when they must reason about events occurring over time. Planning has many applications in manufacturing, such as automatic process control. It is also important in natural language understanding, where humans frequently discuss plans, goals, and intentions.

In this discussion, we use examples from robotics. The component steps in a plan are the *atomic actions* of a robot. For planning purposes, we do not describe these capabilities in hardware or micro-level terms such as "turn the sixth stepper motor one revolution." Instead, planners specify actions at a higher level, in terms of their effect on the world. For example, a planner for a blocks world robot might include such actions as "pick up object a" or "go to location x." The micro control of steps to actually make a robot perform the plans is built into these higher-level actions.

Thus, a sequence of actions to "go get block a from room b" might be:

1. put down what you have
2. go to room b
3. go over to block a
4. pick up block a
5. leave room b
6. return to original location

Plans are created by searching through a space of possible actions until the sequence necessary to accomplish the task is discovered. This space represents states of the world that are changed by applying each of the actions. The search terminates when the goal state (the description of the world) is produced. Thus, many of the issues of heuristic search, including finding A* algorithms, are also appropriate in this domain.

The act of planning does not necessarily depend on the existence of an actual robot to carry out the plans. In the early years of computer planning (1960s), entire plans were formulated before the robot performed its first act. Thus plans were devised without the presence of a robot at all! Only more recently, with the implementation of more sophisticated sensing devices, has research focused on more integrated plan/action sequencing.

Planning relies on search techniques, and raises a number of unique issues. For one, the description of the states of the world may be considerably more complex than in previous examples of search. Consider the number of predicates necessary to describe rooms and corridors and objects in the robot's environment. Not only must we represent the robot's world; we must also represent the effect of atomic actions on that world. The full description of each state of the problem space can be quite extensive.

Another difference in planning is the need to characterize what is *not* changed by a particular action. Picking up an object does change (a) the location of the object and (b) the fact that the robot hand is now grasping the object. It does not change (a) the locations of the doors and the rooms or (b) the locations of other objects. The specification of what is true in one state of the world and exactly what is changed by performing some action in the world has become known as the *frame problem* (McCarthy 1980, McCarthy and Hayes

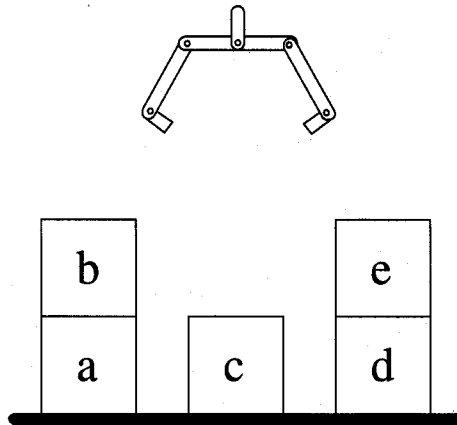

Figure 5.13 The blocks world.

1969). As the complexity of the problem space increases, the issue of keeping track of the changes that occur with each action and the features of a state description that remain unchanged becomes more important. We present two solutions for coping with the frame problem, but, as will be seen, neither of these is totally satisfactory.

Other important issues include generating plans, saving and generalizing good plans, recovering from unexpected plan failures (part of the world might not be as expected, perhaps by being accidentally moved from its anticipated location), and maintaining consistency between the world and a program's internal model of the world.

In the examples of this section, we limit our robot's world to a set of blocks on a tabletop and the robot's actions to an arm that can stack, unstack, and otherwise move the blocks about the table. In Figure 5.13 we have five blocks, labeled a, b, c, d, e, sitting on the top of a table. The blocks are all cubes of the same size, and stacks of blocks, as in the figure, have blocks directly on top of each other. The robot arm has a gripper that can grasp any clear block (one with no block on top of it) and move it to any location on the tabletop or place it on top of any other clear block.

We assume the robot arm can perform the following tasks (U, V, W, X, Y, and Z are variables):

- | | |
|-------------|---|
| goto(X,Y,Z) | Goto location described by coordinates X, Y, and Z. This location might be implicit in the command pickup (W) where block W has location X, Y, Z. |
| pickup(W) | Pick up block W from its current location and hold it. It is assumed that the block has nothing on top, the gripper is empty at the time of the pickup order, and the computer knows the location of block W. |
| putdown(W) | Place block W down at some location on the table and record the new location for block W. W must be held by the gripper at the time. |

stack(U,V)	Place block U on top of block V. The gripper must be holding U and the top of V must be clear of other blocks.
unstack(U,V)	Remove block U from the top of V. U must be clear of other blocks, V must have block U on top of it, and the hand must be empty before this command can be executed.

We represent the state of the world using a set of predicates and predicate relationships:

location(W,X,Y,Z)	Block W is at coordinates X, Y, Z.
on(X,Y)	Block X is immediately on top of block Y.
clear(X)	Block X has nothing on top of it.
gripping(X)	The robot arm is holding block X.
gripping()	The robot gripper is empty.
ontable(W)	Block W is on the table.

ontable(W) is a short form for the predicate location(W,X,Y,Z), where Z is the table level. Similarly, on(X,Y) indicates that block X is located with its bottom coincident with the top of block Y. We can greatly simplify the world descriptions by having the computer record the present location(X,Y,Z) of each block and keep track of its movements to new locations. With this location assumption, the goto command becomes unnecessary; a command such as pickup(X) or stack(X) implicitly contains the location of X.

A number of truth relations (in the declarative sense) or rules for performance (in the procedural sense) are implicit in the blocks world descriptions seen so far, including specifications for clear(X), ontable(X), and gripping():

1. $(\forall X) (\text{clear}(X) \leftarrow \neg (\exists Y) (\text{on}(Y,X)))$
2. $(\forall Y) (\forall X) \neg (\text{on}(Y,X) \leftarrow \text{ontable}(Y))$
3. $(\forall Y) \text{gripping}(\) \leftrightarrow \neg (\text{gripping}(Y))$

The first statement says that if block X is clear, there does not exist any block Y such that Y is on top of X. Interpreted procedurally, this can be read "to clear block X go and remove any block Y that might be on top of X." The second relationship says that if any block is on the table, it is not on top of any other block.

The blocks world of Figure 5.13 may now be represented by the following predicates. We call this collection of predicates STATE 1 for our continuing example.

STATE 1

ontable(a).	on(b, a).	clear(b).
ontable(c).	on(e, d).	clear(c).
ontable(d).	gripping().	clear(e).

Because these predicates describing the state of the world for Figure 5.13 are all true at the same time, the full state description is the conjunction (\wedge) of these predicates. To produce new states from this description, we design rules for operating on states. The four operators (pickup, putdown, stack, unstack) are described by predicate calculus rules:

4. $(\forall X) (\text{pickup}(X) \rightarrow (\text{gripping}(X) \leftarrow (\text{gripping}(\) \wedge \text{clear}(X))))$.
5. $(\forall X) (\text{putdown}(X) \rightarrow ((\text{gripping}(\) \wedge \text{ontable}(X) \wedge \text{clear}(X)) \leftarrow \text{gripping}(X)))$.
6. $(\forall X) (\forall Y) (\text{stack}(X,Y) \rightarrow ((\text{on}(X,Y) \wedge \text{gripping}(\) \wedge \text{clear}(X)) \leftarrow (\text{clear}(Y) \wedge \text{gripping}(X))))$.
7. $(\forall X)(\forall Y) (\text{unstack}(X,Y) \rightarrow ((\text{clear}(Y) \wedge \text{gripping}(X)) \leftarrow (\text{on}(X,Y) \wedge \text{clear}(X) \wedge \text{gripping}(\))))$.

The fourth rule states that for all blocks X , $\text{pickup}(X)$ means $\text{gripping}(X)$ if the hand is empty and X is clear. Note the form of these rules: $A \rightarrow (B \leftarrow C)$. This says that operator A allows us to produce new predicate(s) B when condition(s) C is true. We use these rules to generate new states in a space. That is, if predicates C are true in a state, then B is true in its child state. In other words, operator A can be used to create a new state described by predicates B when predicates C are true.

But we must first address the *frame problem* before we can use these rule relationships to generate new states of the blocks world. *Frame relations* are rules to tell what predicates describing a state are *not* changed by rule applications and are thus carried over intact to help describe the new state of the world. For example, if we apply the operator pickup block b in Figure 5.13, then all predicates related to the rest of the blocks remain true in the child state. For our world of blocks we can specify several such frame rules:

8. $(\forall X) (\forall Y) (\forall Z) (\text{unstack}(Y,Z) \rightarrow (\text{ontable}(X) \leftarrow \text{ontable}(X)))$.
9. $(\forall X) (\forall Y) (\forall Z) (\text{stack}(Y,Z) \rightarrow (\text{ontable}(X) \leftarrow \text{ontable}(X)))$.

These two rules say that **ontable** is not affected by the **stack** and **unstack** operators. This is true even when X and Z are identical; if $Y = Z$ either 6 or 7 above won't be true.

Other frame axioms say that **on** and **clear** are affected by **stack** and **unstack** operators only when that particular **on** relation is **unstacked** or when a **clear** relation is **stacked**. Thus, in our example, $\text{on}(b,a)$ is not affected by $\text{unstack}(c,d)$.

Similarly, frame axioms say that **clear**(X) relations are unaffected by **gripping**(Y) even when $X = Y$ or $\text{gripping}(\)$ is true. More axioms say that **gripping** does not affect $\text{on}(X,Y)$ relations but affects only the $\text{ontable}(X)$ relation where X is gripped. Thus, a number of other frame relations need to be specified for our example.

Together, these operators and frame axioms define a state space, as illustrated by the operator **unstack**. $\text{unstack}(X,Y)$ requires three conditions to be true, namely that $\text{on}(X,Y)$ and $\text{gripping}(\)$ and $\text{clear}(X)$ are all true. When these conditions are met the new predicates $\text{gripping}(X)$ and $\text{clear}(Y)$ are produced by **unstack**. A number of other predicates also true for STATE 1 will remain true in STATE 2. These states are preserved

by the frame axioms. We now produce the nine predicates describing STATE 2 by applying the `unstack` operator and the frame axioms to the nine predicates of STATE 1:

STATE 2

<code>ontable(a).</code>	<code>on(b,a).</code>	<code>clear(b).</code>
<code>ontable(c).</code>	<code>clear(c).</code>	<code>clear(d).</code>
<code>ontable(d).</code>	<code>gripping(e).</code>	<code>clear(e).</code>

To summarize:

1. Planning may be seen as a state space search.
2. New states are produced by general operators such as `stack` and `unstack` plus frame rules.
3. The techniques of graph search may be applied to find a path from the start state to the goal state. The operations on this path constitute a plan.

Figure 5.14 shows an example of a state space searched by applying the operators as described above. If a goal description is added to this problem-solving process, then a plan may be seen as a set of operators that produces a path that leads from the present state of this graph to the goal. (See Section 3.1.2.)

This characterization of the planning problem defines its theoretical roots in state space search and predicate calculus representation and inferencing. However, it is important to note how complex this manner of solution can be. In particular, using the frame rules to calculate what remains unchanged between states can add exponentially to the search, as can be seen from the complexity of the very simple blocks problem. In fact, when any new predicate descriptor is introduced, for color, shape, or size, new frame rules must be defined to relate it to all appropriate actions!

This discussion also assumes that the subproblems that make up a task are independent and may thus be solved in an arbitrary order. This very seldom is the case in interesting problem areas, where the actions required to achieve one subgoal can conflict with the actions required to achieve another. Next we illustrate these problems and discuss an approach to planning that greatly assists in handling this complexity.

STRIPS, developed at what is now SRI International, stands for STanford Research Institute Planning System (Fikes and Nilsson 1971, Fikes et al. 1972). This controller was used to drive the *SHAKY* robot of the early 1970s. *STRIPS* addressed the problem of efficiently representing and implementing the operations of a planner. It addressed the problem of conflicting subgoals and provided an early model of learning; successful plans were saved and generalized as *macro operators*, which could be used in similar future situations. In the remainder of this section, we present a version of *STRIPS*-style planning and *triangle tables*, the data structure used to organize and store macro operations.

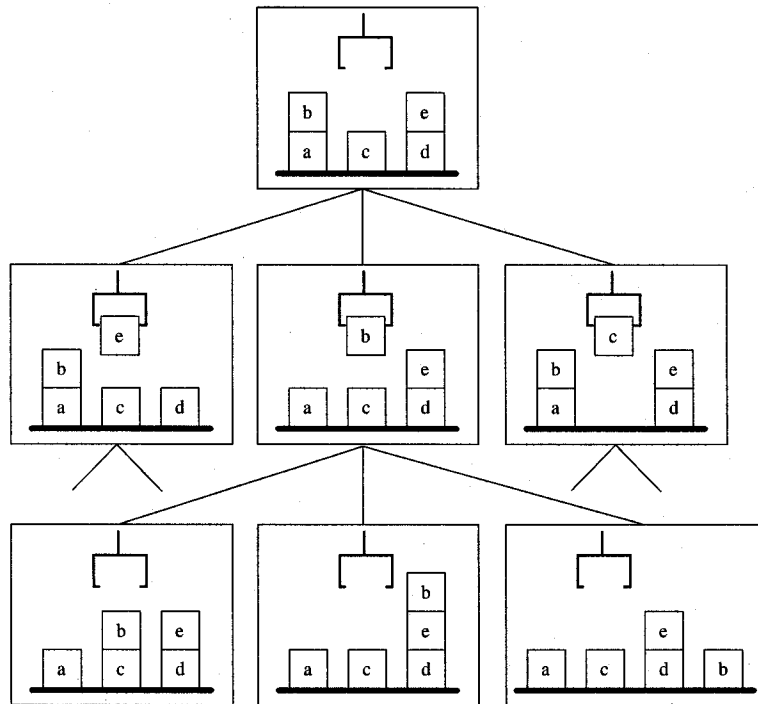

Figure 5.14 Portion of the state space for a portion of the blocks world.

Using the blocks example, the four operators *pickup*, *putdown*, *stack*, and *unstack* are represented as triples of descriptions. The first element of the triple is the set of *preconditions* (P), or conditions the world must meet for an operator to be applied. The second element of the triple is the *add list* (A), or the additions to the state description that are a result of applying the operator. Finally, there is the *delete list* (D), or the items that are removed from a state description to create the new state when the operator is applied. These lists eliminate the need for separate frame axioms. We can represent the four operators in this fashion:

pickup(X) P: $\text{gripping}() \wedge \text{clear}(X) \wedge \text{ontable}(X)$
 A: $\text{gripping}(X)$
 D: $\text{ontable}(X) \wedge \text{gripping}()$

putdown(X) P: $\text{gripping}(X)$
 A: $\text{ontable}(X) \wedge \text{gripping}() \wedge \text{clear}(X)$
 D: $\text{gripping}(X)$

$stack(X,Y)$ P: $clear(Y) \wedge gripping(X)$
 A: $on(X,Y) \wedge gripping() \wedge clear(X)$
 D: $clear(Y) \wedge gripping(X)$

$unstack(X,Y)$ P: $clear(X) \wedge gripping() \wedge on(X,Y)$
 A: $gripping(X) \wedge clear(Y)$
 D: $gripping() \wedge on(X,Y)$

The important thing about the add and delete lists is that they specify *everything* that is necessary to satisfy the frame axioms! Some redundancy exists in the add and delete list approach. For example, in `unstack` the *add* of `gripping(X)` could imply the *delete* of `gripping()`. But the gain of this redundancy is that every descriptor of a state that is not mentioned by the *add* or *delete* remains the same in the new state description.

A related weakness of the precondition-add-delete list approach is that we are no longer using a theorem-proving process to produce (by inference) the new states. This is not a serious problem, however, as proofs of the equivalence of the two approaches can guarantee the correctness of the precondition-add-delete method.

The precondition-add-delete list approach may be used to produce the same results we produced with the inference rules and frame axioms in our earlier example. The state space search, as in Figure 5.14, would be identical for both approaches.

A number of other problems inherent in planning are not solved by either of the two approaches presented so far. In solving a goal we often divide it into subproblems, for instance, `unstack(e,d)` and `unstack(b,a)`. Attempting to solve these subgoals independently can cause problems if the actions needed to achieve one goal actually undo the other. Incompatible subgoals may result from a false assumption of *linearity* (independence) of subgoals. This can make solution searches unnecessarily difficult or even impossible.

We now show a very simple example of an incompatible subgoal using the start state STATE 1 of Figure 5.13. Suppose the goal of the plan is STATE G as in Figure 5.15, with $on(b,a) \wedge on(a,c)$ and blocks `d` and `e` remaining as in STATE 1. It may be noted that one of the parts of the conjunctive goal $on(b,a) \wedge on(a,c)$ is true in STATE 1, namely $on(b,a)$. This already satisfied part of the goal must be undone before the second subgoal, $on(a,c)$, can be accomplished.

The *triangle table* representation (Fikes and Nilsson 1972, Nilsson 1980) is aimed at alleviating some of these anomalies. A triangle table is a data structure for organizing sequences of actions, including potentially incompatible subgoals, within a plan. It addresses the problem of conflicting subgoals by representing the global interaction of sequences of operations. A triangle table relates the preconditions of one action with the postconditions, the combined add and delete lists, of all the actions preceding it.

Triangle tables are used to determine when that macro operator could be used in building a plan. By saving these macro operators and reusing them, STRIPS increases the efficiency of its planning search. Indeed, we can generalize a macro operator, using variable names to replace the block names in a particular example. Then we can call the

new generalized macro to prune search. In Chapter 12, with our presentation of learning, we discuss techniques for generalizing macro operations.

The reuse of macro operators also helps to solve the problem of conflicting subgoals. As the following example illustrates, once the planner has developed a plan for goals of the form $\text{stack}(X,Y) \wedge \text{stack}(Y,Z)$, it may store and reuse that plan. This eliminates the need to break the goal into subgoals and avoids the complications that may follow.

Figure 5.16 presents a sample triangle table for the macro action $\text{stack}(X,Y) \wedge \text{stack}(Y,Z)$. This macro action can be applied to states where $\text{on}(X,Y) \wedge \text{clear}(X) \wedge \text{clear}(Z)$ is true. This triangle table is appropriate for starting STATE 1 with $X = b$, $Y = a$, and $Z = c$.

The atomic acts of the plan are recorded along the diagonal. These are the four actions, *pickup*, *putdown*, *stack*, and *unstack*, discussed in this section. The preconditions of each of these acts are in the row preceding that act, and the postconditions of each act are in the column below the act. For example, row 5 lists the preconditions for *pickup(X)*, and column 6 lists the postconditions (the add and delete lists) of *pickup(X)*. These postconditions are placed in the row of the action that uses them as its preconditions, organizing them in a manner relevant to succeeding actions. Thus, the triangle table's purpose is to properly interleave the preconditions and postconditions of each of the smaller actions that make up the larger goal.

One advantage of triangle tables is the assistance they can offer in attempting to recover from unexpected happenings, such as a block being slightly out of place, or accidents, such as dropping a block. Often an accident can require backing up several steps before the plan can be resumed. When something goes wrong with a solution the planner can go back into the rows and columns of the triangle table to check what is still true. Once the planner has figured out what is still true within the rows and columns, it then knows what the next step must be if the larger solution is to be restarted. This is formalized with the notion of a *kernel*.

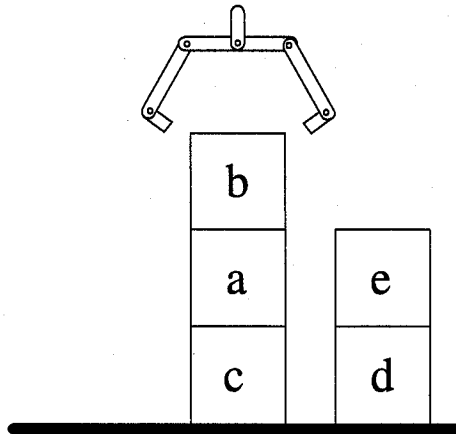

Figure 5.15 Goal state for the blocks world.

The *n*th kernel is the intersection of all rows below and including the *n*th row and all columns to the left of and including the *n*th column. In Figure 5.16 we have outlined the third kernel in bold. In carrying out a plan represented in a triangle table, the *i*th operation (that is, the operation in row *i*) may be performed only if all predicates contained in the *i*th kernel are true. This offers a straightforward way of verifying that a step can be taken and also allows us to recover systematically from any disruption of a plan. Given a triangle table, we find and execute the highest-numbered action whose kernel is enabled. This not only lets us back up in a plan but also allows for the possibility that an unexpected event might let us jump forward in a plan.

The conditions in the leftmost column are the preconditions for the macro action as a whole. The conditions in the bottom row are the conditions added to the world by the macro operator. A triangle table may be saved as a *macro operator* with its own set of preconditions and add and delete lists.

Of course, the triangle table approach does lose some of the semantic purity of the previous planning models. Notice, for example, that only those postconditions of an act are retained that are also preconditions of later acts. Thus, if guaranteed correctness is a desired result, further verification of the triangle tables, perhaps with additional information that might allow sequences of triangle tables to be composed, might be desirable.

Other problems arise with the use of macro operators in planning. As the number of macro operators increases, the planner has more powerful operations to use, decreasing the size of the state space that must be searched. Unfortunately, at each step of the search, all of these operators must be examined. The pattern matching needed to determine

1	gripping() clear(X) on(X,Y)	unstack(X,Y)					
2		gripping(X)	putdown(X)				
3	ontable(Y)	clear(Y)	gripping()	pickup(Y)			
4	clear(Z)			gripping(Y)	stack(Y,Z)		
5			clear(X) ontable(X)		gripping()	pickup(X)	
6					clear(Y)	gripping(X)	stack(X,Y)
7					on(Y,Z)		on(X,Y) clear(X) gripping()
	1	2	3	4	5	6	7

Figure 5.16 Triangle table.

whether an operator may be applied can add considerable overhead to the search process, counteracting the gains made by saving macro operations. The problems of determining when a macro operation should be saved and the best way to determine the next operator to use remain the subject of much research.

5.5 The Blackboard Architecture for Problem Solving

The *blackboard* is the final control mechanism presented in this chapter. Where pattern search examined the states in a space of logical inferences in a very deterministic fashion, production systems provide greater flexibility by allowing us to represent multiple partial solutions simultaneously in working memory and to select the next state through conflict resolution. Blackboards extend production systems by allowing us to organize working memory into separate modules, each of which corresponds to a different subset of the production rules. Blackboards allow us to integrate separate sets of production rules in a single agent or to coordinate the actions of multiple cooperating problem solvers in a single global structure.

Many problems require the coordination of a number of different types of knowledge. For example, a speech understanding program must first manipulate an utterance represented as a digitized waveform. As the understanding process continues, it must find words in this utterance, form these into sentences, and finally produce a semantic representation of the utterance's meaning.

A related problem occurs when multiple processes must cooperate to solve a single problem. An example of this is the distributed sensing problem (Lesser and Corkill 1983). Assume that we have a network of sensors, each of which is monitored by a separate process. Assume also that the processes can communicate and that proper interpretation of each sensor's data depends on the data received by other sensors in the network. This problem arises in situations as diverse as tracking an airplane across multiple radar sites and combining the readings of multiple sensors in a manufacturing process.

The *blackboard architecture* is a model of control that has been applied to these and other problems requiring the coordination of multiple processes or knowledge sources. A *blackboard* is a central global data base for the communication of independent asynchronous knowledge sources focusing on related aspects of a particular problem. Figure 5.17 gives a schematic of the blackboard design.

In Figure 5.17 each *knowledge source* KS_i gets its data from the blackboard, processes the data, and returns its results to the blackboard to be used by the other knowledge sources. Each KS_i is independent in that it is a separate process operating according to its own specifications and, when a multiprocessing or multiprocessor system is used, it is independent of the other processing in the problem. It is an asynchronous system in that each KS_i begins its operation whenever it finds appropriate input data posted on the blackboard. When it finishes its processing it posts its results and awaits new input data.

The blackboard approach to organizing a large program was first presented in the HEARSAY-II research (Erman et al. 1980, Reddy 1976). HEARSAY-II was a speech understanding program; it was initially designed as the front end for a library database of

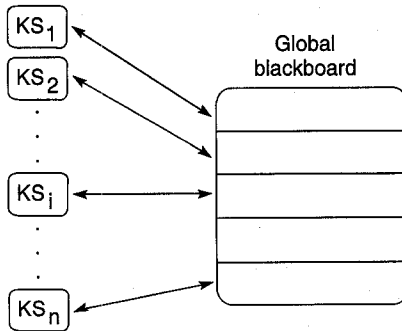

Figure 5.17 Blackboard architecture.

computer science articles. The user of the library would address the computer in spoken English with queries such as, "Are any by Feigenbaum and Feldman?" and the computer would answer the question with information from the library database. Speech understanding requires that we integrate a number of different processes, all of which require very different knowledge and algorithms, all of which can be exponentially complex. Signal processing; recognition of phonemes, syllables, and words; syntactic parsing; and semantic analysis mutually constrain each other in interpreting speech.

The blackboard architecture allowed HEARSAY-II to coordinate the several different knowledge sources required for this complex task. The blackboard is usually organized along two dimensions. With HEARSAY-II these dimensions were the time as the speech act was produced and the level of analysis of the utterance. Each level of analysis was processed by a different class of knowledge sources. The levels of analysis of the utterance were:

- KS₁ The waveform of the acoustic signal.
- KS₂ The phonemes or possible sound segments of the acoustic signal.
- KS₃ The syllables that the phonemes could produce.
- KS₄ The possible words as analyzed by one KS.
- KS₅ The possible words as analyzed by a second KS (usually considering words from different parts of the data).
- KS₆ A KS to try to generate possible word sequences.
- KS₇ A KS that puts word sequences into possible phrases.

We can visualize these processes as components of Figure 5.17. In processing spoken speech, the waveform of the spoken signal is entered at the lowest level. Knowledge sources for processing this entry are enabled and post their interpretations to the blackboard, to be picked up by the appropriate process. Because of the ambiguities of spoken language, multiple competing hypotheses may be present at each level of the blackboard. The knowledge sources at the higher levels attempt to disambiguate these competing hypotheses.

The analysis of HEARSAY-II should not be seen as simply one lower level producing data that the higher levels can then analyze. It is much more complex than that. If a KS at

one level cannot process (make sense of) the data sent to it, that KS can request the KS that sent it the data to go back for another try or to make another hypothesis about the data. Furthermore, different KSs can be working on different parts of the utterance at the same time. All the processes, as mentioned previously, are asynchronous and data-driven; they act when they have input data, continue acting until they have finished their task, and then post their results and wait for their next task.

One of the KSs, called the *scheduler*, handles the “consume-data post-result” communication between the KSs. This scheduler has ratings on the results of each KS’s activity and thus is able to supply, by means of a priority queue, some direction in the problem solving. If no KS is active, the scheduler determines that the task is finished and shuts down.

When the HEARSAY program had a database of about 1,000 words it worked quite well, although a bit slowly. When the database was further extended, the data for the knowledge sources got more complex than they could handle. HEARSAY-III (Balzer et al. 1980, Erman et al. 1981) is a generalization of the approach taken by HEARSAY-II. The time dimension of HEARSAY-II is no longer needed, but the multiple KSs for levels of analysis are retained. The blackboard for HEARSAY-III is intended to interact with a general-purpose relational database system. Indeed, HEARSAY-III is a general shell for the design of expert systems.

An important change in HEARSAY-III has been to split off the scheduler KS (as described above for HEARSAY-II) and to make it a separate blackboard controller for the first (or domain) blackboard. This second blackboard allows the scheduling process to be broken down, just as the domain of the problem is broken down, into separate KSs concerned with different aspects of the solution procedure (for example, when and how to apply the domain knowledge). The second blackboard can thus compare and balance different solutions for each problem (Nii and Aiello 1979, Nii 1986a, 1986b).

An alternative model of the blackboard scheme retains important parts of the knowledge base in the blackboard, rather than distributing it across multiple knowledge sources (Skinner and Luger 1991, 1992).

5.6 Epilogue and References

Chapter 5 discussed the implementation of the search strategies of Chapters 3 and 4. It presented recursion as an important tool for programming graph search, implementing the backtrack algorithm of Chapter 3 in recursive form. Pattern-directed search using unification and inference rules (Chapter 2) simplifies the implementation of search through a space of logical inferences.

The production system was shown as a natural architecture for modeling problem solving and implementing search algorithms. The chapter concluded with examples of production system implementations of data-driven and goal-driven search. The production system is also an important architecture for cognitive science; see Section 16.3.

The references listed in the epilogue to Chapter 3 are also appropriate to this chapter. For references on recursion see Chapter 5.

The production system has always been an important paradigm for AI programming, beginning with work by Newell and Simon and their colleagues at Carnegie Mellon University (Newell and Simon 1972, Klahr et al. 1987). Two references on current implementations of production systems are *Programming Expert Systems in OPS5* by Lee Brownston et al. (1985) and *Pattern Directed Inference Systems* by Donald Waterman and Frederick Hayes-Roth (1978).

The planning section demonstrates some of the data structures and search techniques used for general-purpose planners. Further references include ABSTRIPS or ABSTRACT specification for STRIPS generator relationships (Sacerdotti 1974) and NOAH for nonlinear or hierarchical planning (Sacerdotti 1975, 1977). For a more modern planner see *teleo-reactive* planning, Section 15.3 (Benson and Nilsson 1995).

Meta-planning is a technique for reasoning not just about the plan but also about the process of planning. This can be important in expert systems solutions. References include Meta-DENDRAL for DENDRAL solutions (Lindsay et al. 1980) and Teiresias for MYCIN solutions (Chapter 8). For plans that interact continuously with the world, that is, model a changing environment, see McDermott (1978).

Further research includes *opportunistic planning* using blackboards and planning based on an object-oriented specification (Smoliar 1985). Finally, there are several surveys of planning research in the *Handbook of Artificial Intelligence* (Barr and Feigenbaum 1989, Cohen and Feigenbaum 1982) and the *Encyclopedia of Artificial Intelligence* (Shapiro 1987b).

Early work in blackboard models is described in HEARSAY-II research (Reddy 1976, Erman et al. 1980). Later work is described in the HEARSAY-III work (Lesser and Corkill 1983, Nii 1986a, Nii 1986b). Current research may be found in Skinner and Luger (1992).

Research in production systems, planning, and blackboard architectures remains an active part of artificial intelligence. We recommend that the interested reader consult recent proceedings of the American Association for Artificial Intelligence Conference and the International Joint Conference on Artificial Intelligence. Morgan Kaufmann has published other conference proceedings, as well as collections of readings on AI topics. *Readings in Planning* (Allen et al. 1990) is particularly relevant to the material in this chapter.

5.7 Exercises

1. The member algorithm of Section 5.1.1 recursively determines whether a given element is a member of a list.
 - a. Write an algorithm to count the number of elements in a list.
 - b. Write an algorithm to count the number of atoms in a list.(The distinction between atoms and elements is that an element may itself be a list.)
2. Write a recursive algorithm (using open and closed lists) to implement breadth-first search. Does recursion allow the omission of the open list when implementing breadth-first search? Explain.

3. Trace the execution of the recursive depth-first search algorithm (the version that does not use an open list) on the state space of Figure 3.10.
4. In an ancient Hindu tea ceremony, there are three participants: an elder, a servant, and a child. The four tasks they perform are feeding the fire, serving cakes, pouring tea, and reading poetry; this order reflects the decreasing importance of the tasks. At the beginning of the ceremony, the child performs all four tasks. They are passed one at a time to the servant and the elder until, at the end of the ceremony, the elder is performing all four tasks. No one can take on a less important task than those they already perform. Generate a sequence of moves to transfer all the tasks from the child to the elder. Write a recursive algorithm to perform the move sequence.
5. Using the **move** and **path** definitions for the knight's tour of Section 5.2, trace the execution of **pattern_search** on the goals:
 - a. `path(1,9)`.
 - b. `path(1,5)`.
 - c. `path(7,6)`.

When the **move** predicates are attempted in order, there is often looping in the search. Discuss loop detection and backtracking in this situation.

6. Write the pseudo-code definition for a breadth-first version of **pattern_search** (Section 5.2). Discuss the time and space efficiency of this algorithm.
7. Using the rule in Example 5.3.3 as a model, write the eight move rules needed for the full 8×8 version of the knight's tour.
8. Using the goal and start states of Figure 5.5, hand run the production system solution to the 8-puzzle:
 - a. In goal-driven fashion.
 - b. In data-driven fashion.
9. Consider the financial advisor problem discussed in Chapters 2, 3, and 4. Using predicate calculus as a representation language:
 - a. Write the problem explicitly as a production system.
 - b. Generate the state space and stages of working memory for the data-driven solution to the example in Chapter 3.
 - c. Repeat b for a goal-driven solution.
10. Section 5.3.3 presented the general conflict resolution strategies of refraction, recency, and specificity. Propose and justify two more such strategies.
11. Create the remaining *frame axioms* necessary for the four operators **pickup**, **putdown**, **stack**, and **unstack** described in rules 4 through 7 of Section 5.4.
12. Use the operators and frame axioms of the previous question to generate the search space of Figure 5.14.
13. Show how the *add* and *delete* lists can be used to replace the frame axioms in the generation of STATE 2 from STATE 1 in Section 5.4.
14. Use *add* and *delete* lists to generate the search space of Figure 5.14.
15. Suggest an automated controller that could use *add* and *delete* lists to generate a graph search similar to that of Figure 5.14.

16. Show two more incompatible (precondition) subgoals in the blocks world operators of Figure 5.14.
17. Read the ABSTRIPS research (Sacerdotti 1974) and show how it handles the linearity (or incompatible subgoal) problem in planning.
18. A more modern planner has been created by Nilsson and his students at Stanford (Benson and Nilsson 1995). *Teleo-reactive* planning allows actions described as *durative*, i.e., that must continue to be true across time periods. See Section 15.3 and the reference for a description of this planner. How might teleo-reactive planning be preferred over a STRIPS-like planner? Build a teleo-reactive planner in PROLOG.
19. Suggest two applications appropriate for solution using the blackboard architecture. Briefly characterize the organization of the blackboard and knowledge sources for each implementation.

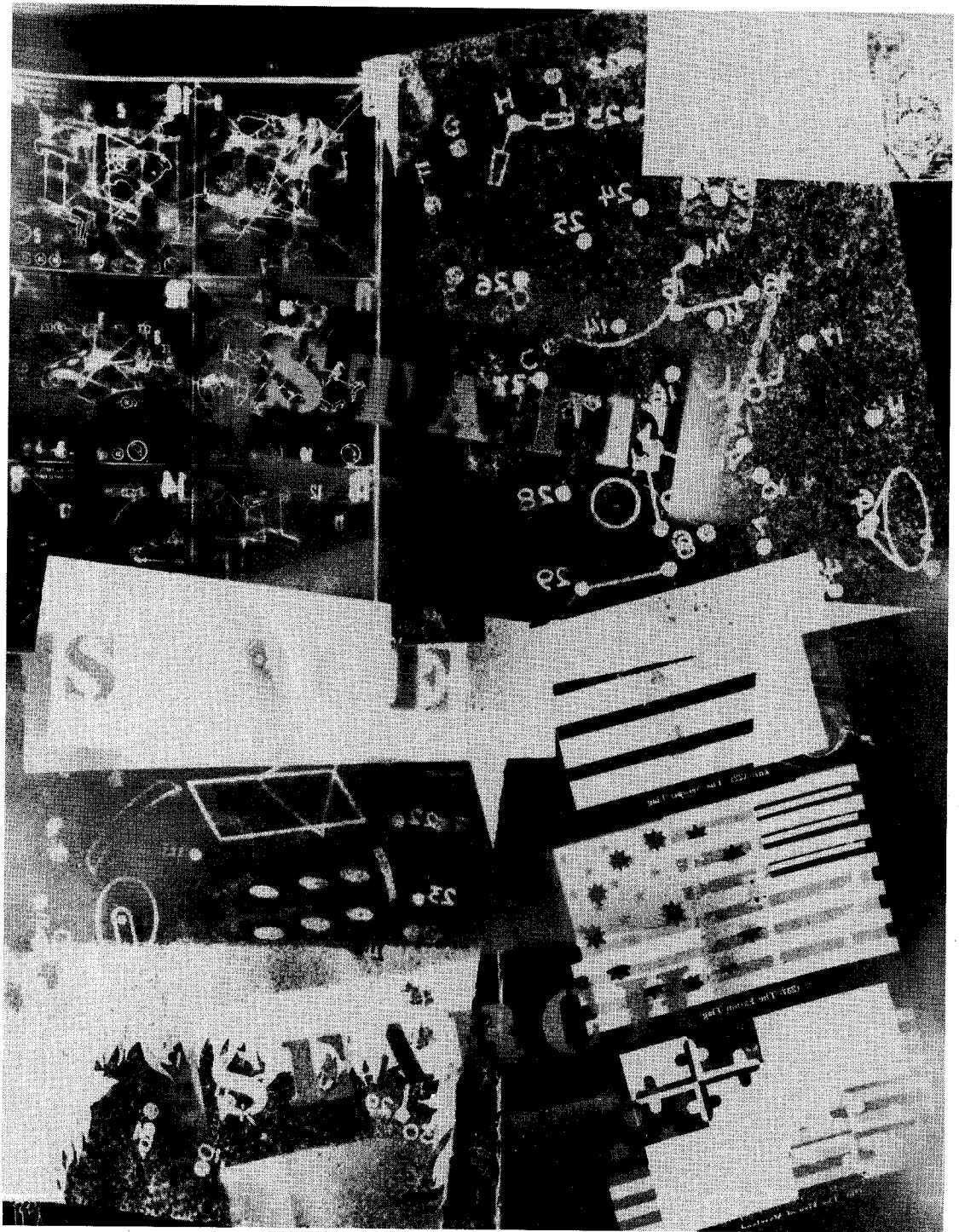

PART III

REPRESENTATIONS FOR KNOWLEDGE-BASED PROBLEM SOLVING

Nam et ipsa scientia potestas est (Knowledge is power).

—FRANCIS BACON

Horatio: O day and night but this is wondrous strange!

Hamlet: And therefore as a stranger give it welcome.

There are more things in heaven and earth, Horatio,

Than are dreamt of in your philosophy.

But come ...

—WILLIAM SHAKESPEARE, *Hamlet*

In the late 1950s and early 1960s, Alan Newell and Herbert Simon wrote several computer programs to test the hypothesis that intelligent behavior resulted from heuristic search. Their first major program, the *Logic Theorist*, developed in conjunction with J. C. Shaw (Newell and Simon 1963a), proved theorems in elementary logic using the notation and axioms provided by Russell and Whitehead's *Principia Mathematica*. The authors describe their research as being

aimed at understanding the complex processes (heuristics) that are effective in problem solving. Hence, we are not interested in methods that guarantee solutions, but which require vast amounts of computation. Rather we wish to understand how a mathematician, for example, is able to prove a theorem even though he does not know when he starts how, or if, he is going to succeed.

A later program, Newell and Simon's *General Problem Solver* (GPS) (Newell and Simon 1963b, 1972), continued this effort to find general principles of intelligent problem solving. The GPS solved problems formulated as state space search; legal problem-solving steps were a set of operations for modifying state representations. The General Problem Solver searched for a sequence of operations that would transform the start state into the

goal state, searching a space of possible state transformations in the same fashion as the search algorithms discussed in earlier chapters of this text.

GPS used *means-ends analysis*, a general heuristic for selecting among alternative state transformation operations, to guide search through the problem space. Means-ends analysis examines the *syntactic* differences between the current state and the goal state and selects an operator that reduces these differences. Suppose, for example, that GPS is attempting to prove the equivalence of two logical expressions. If the current state contains an \wedge operator and the goal does not contain an \wedge , then means-ends analysis would select a transformation such as de Morgan's law, to remove \wedge from expressions.

Like all heuristics, means-ends analysis is not foolproof; it fails, for example, when given expressions that must first have their differences temporarily increased in order to find a solution path. Consider, for example, the 8-puzzle board of Figure III.1. Although only one tile, 3, is out of place, the only possible next step is to move either tile 2 or tile 4. Because either of these moves increases the difference between the board and the goal, a strictly applied difference reduction heuristic cannot select either of them. In fact, it would be difficult for means-ends analysis to determine whether a solution exists in this case.

A fundamental aspect of the GPS is its restriction to a heuristic based solely on the syntactic form of state descriptors. By using a heuristic that examines only the syntactic form of states, it was hoped that GPS would indeed prove to be a *general* architecture for intelligent problem solving, no matter what the domain. Programs like the GPS, which restrict themselves to strategies that can be applied across a wide variety of applications, are known as *weak problem solvers*. Because they attempt to implement general strategies, such as those described in Chapters 2 through 5, weak problem solvers may only examine the syntactic form of state descriptions. They may not use theoretical or empirical knowledge about a specific problem domain.

Unfortunately, there does not seem to be a single heuristic that can successfully be applied to all problem domains. In general, the methods we use to solve problems employ a great deal of knowledge about the domain. Doctors are able to diagnose illness because they have extensive knowledge of medicine, in addition to their general problem-solving abilities. Architects are able to design houses because they know about architecture. Indeed, the heuristics used in medical diagnosis would be useless in designing an office building.

Weak methods stand in sharp contrast to *strong methods*, which use explicit knowledge of a particular problem domain. For example, a strong method heuristic for diagnosing automotive problems might be:

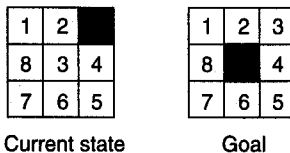

Figure III.1 A state that must temporarily be moved farther from the goal in order to find a solution path.

```
if
the engine does not turn over, and
the lights do not come on
then
the problem is battery or cables
```

This heuristic, phrased as an *if... then...* rule, focuses search on the battery/cable subsystem of the automobile, eliminating other components and pruning the search space. Notice that this particular heuristic, unlike means–ends analysis, uses empirical knowledge of how automobiles function, such as knowledge of the relationships between the battery, lights, and starter. It is useless in any problem domain except auto repair.

Not only do strong method problem solvers use domain-specific heuristics, but they generally require large amounts of such knowledge to be effective. The bad-battery heuristic, for example, would not be of much use in diagnosing a bad carburetor; an automotive diagnostic program must have a number of such specific rules to handle a range of possible diagnoses. A major challenge in designing a knowledge-based program is the acquisition and organization of large amounts of specific problem-solving knowledge.

Most of the techniques that AI has developed for solving these problems depend on the separation of the knowledge and control aspects of the program. Levesque and Brachman (1985) have given a simple illustration of the benefits of this separation in the form of two logic programs:

% Version 1:

```
print_color(rose) ← write(red).
print_color(sky) ← write(yellow).
print_color(grass) ← write(green).
print_color(_) ← write('color not known').
```

% Version 2 :

```
print_color(X) ← color(X,Y),write(Y).
print_color(_) ← write('color not known').
color(rose,red).
color(sky,yellow).
color(grass,green).
```

Although both of these programs have identical behavior, the second has represented the relationship between an object and its color explicitly using the `color` predicate. These `color` predicates constitute a *knowledge base* that is distinct from the control and implementation details found in the definition of `print_color`. A *knowledge-based system* is one that uses a separate base of explicitly represented problem-solving knowledge.

The separation of knowledge and control is so intuitively appealing and so common in AI that it is often taken for granted as the best way to design an intelligent program. Before proceeding with Part III, we would like to emphasize that in following this approach, we are making certain assumptions about the nature of intelligent systems.

These assumptions have been formalized by Brian Smith (1985) as the *knowledge representation hypothesis*. This hypothesis states that

any mechanically embodied intelligent process will be comprised of structural ingredients that (a) we as external observers naturally take to represent a propositional account of the knowledge that the overall process exhibits, and (b) independent of such external semantical attribution, play a formal role in engendering the behavior that manifests that knowledge.

The important aspects of this hypothesis include the assumption that knowledge will be represented *propositionally*, that is, in a form that explicitly represents the knowledge in question and that may be seen by an outside observer as a “natural” description of that knowledge. The second major assumption is that the behavior of the system should be directly caused by the propositions in the knowledge base and that this behavior should be consistent with our perceived meaning of those propositions. Note that this assumption does not require a particular syntax for the representation, such as expressions in formal logic; it only requires that we be able to understand the intended meaning by examining the contents of the knowledge base. In fact, the knowledge representation hypothesis makes explicit the assumptions underlying the majority of work in AI, and most especially that in knowledge-based problem solving.

In Chapter 6 we discuss rule-based systems and examine the problems involved in the acquisition, formalization, and debugging of a knowledge base. We also present different inference schemes for rule systems, including goal-driven and data-driven reasoning. Besides rule-based reasoning, we present two other knowledge-intensive approaches to reasoning: model-based and case-based reasoning. The first of these tries to represent explicitly the theoretical foundations and functionality of a domain, e.g., an electronic circuit, while the second approach builds an explicit database of past successes and failures in a problem domain to assist with future problem solving.

In Chapter 7 we present a number of techniques that address the problem of reasoning in situations of vagueness and uncertainty. Much interesting and important problem solving does not fit comfortably under the umbrella of deductive logic. For reasoning in these situations, sometimes termed *abductive*, we introduce a number of other potent tools. Along with the best-first approach of Chapter 4, we introduce the Bayesian, Dempster-Shafer, and Stanford Certainty Factor based approaches to inference. We also present nonmonotonic and truth-maintenance logics. We also have a section on fuzzy reasoning. We conclude with some comments on evaluating reasoning systems operating in uncertain domains.

In spite of the benefits of logical and rule-based representations, the demands of knowledge-based problem solving have continued to stimulate work in the design of knowledge representation languages. In Chapter 8 we examine the major alternatives to rules and logic, including *semantic networks*, *frames*, and *objects*. We present these data and control structures from an evolutionary viewpoint, showing how modern tools grew from forty years of AI research.

In Part IV we build many of these problem solving representations in both LISP and PROLOG.

KNOWLEDGE-INTENSIVE PROBLEM SOLVING

6

The first principle of knowledge engineering is that the problem-solving power exhibited by an intelligent agent's performance is primarily the consequence of its knowledge base, and only secondarily a consequence of the inference method employed. Expert systems must be knowledge-rich even if they are methods-poor. This is an important result and one that has only recently become well understood in AI. For a long time AI has focused its attentions almost exclusively on the development of clever inference methods; almost any inference method will do. The power resides in the knowledge.

—EDWARD FEIGENBAUM, Stanford University

6.0 Introduction

Human experts are able to perform at a high level because they know a great deal about their areas of expertise. This simple, seemingly obvious observation is the underlying rationale for the design of knowledge-based problem solvers. An *expert system*, as these programs are often called, uses domain specific knowledge to provide “expert quality” performance in a problem domain. Generally, expert system designers acquire this knowledge with the help of human domain experts, and the system emulates their methodology and performance. As with skilled humans, expert systems tend to be specialists, focusing on a narrow set of problems. Also, like humans, their knowledge is both theoretical and practical: the human experts that provide the system's knowledge have generally augmented their own theoretical understanding of the problem domain with tricks, shortcuts, and heuristics for *using* that knowledge they have gained through problem-solving experience. Unlike a human, however, current programs cannot learn from their own experience: knowledge must be extracted from humans and encoded in a formal language. This is the major task facing designers of knowledge-intensive problem solvers.

Expert systems should not be confused with cognitive modeling programs, which attempt to simulate human mental architecture in detail. Expert systems neither copy the

structure of the human mind, nor are they mechanisms for general intelligence. They are practical programs that use heuristic strategies developed by humans to solve specific classes of problems.

Because of the heuristic, knowledge-intensive nature of expert-level problem-solving, expert systems generally:

1. Support inspection of their reasoning processes, both in presenting intermediate steps and in answering questions about the solution process.
2. Allow easy modification, both in adding and in deleting skills from the knowledge base.
3. Reason heuristically, using (often imperfect) knowledge to obtain useful problem solutions.

The reasoning of an expert system should be open to inspection, providing information about the state of its problem-solving, and explanations of the choices and decisions that the program is making. Explanations are important for several reasons: first, if a human expert such as a doctor or an engineer is to accept a recommendation from the computer, he or she must be satisfied the solution is correct. Indeed, few human experts will accept advice from another human, let alone a machine, without understanding the justifications for it. This need to have answers explained is more than mistrust on the part of users: explanations help people relate the advice to their existing understanding of the domain and apply it in a more confident and flexible manner.

Second, when a solution is open to inspection, we can evaluate every decision taken during the solution process, allowing for partial agreement and the addition of new information or rules to improve performance. This helps greatly in debugging the system and refining the knowledge base.

The exploratory nature of AI and expert system programming requires that programs be easily prototyped, tested, and changed. AI programming languages and environments are designed to support this iterative development methodology. In a pure production system, for example, the modification of a single rule has no global syntactic side effects. Rules may be added or removed without requiring further changes to the larger program. Expert system designers have commented that easy modification of the knowledge base is a major factor in producing a successful program (McDermott 1981).

The third feature of expert systems is their use of heuristic problem-solving methods. As expert system designers have discovered, informal "tricks of the trade" and "rules of thumb" are an essential complement to the standard theory presented in textbooks and classes. Sometimes these rules augment theoretical knowledge in understandable ways; often they are simply shortcuts that seem unrelated to the theory but have been empirically shown to work.

The heuristic nature of expert problem-solving knowledge creates problems in the evaluation of program performance. Although we know that heuristic methods will occasionally fail, it is not clear exactly how often a program must be correct to be accepted: 98% of the time? 90%? 80%? Perhaps the best way to evaluate a program is to

compare its results to those obtained by human experts in the same area. This suggests a variation of the Turing test (Chapter 1) for evaluating the performance of expert systems: a program has achieved expert-level performance if people working in the area cannot differentiate, in a blind evaluation, between the best human efforts and those of the program. For example, MYCIN was an early expert system for diagnosing meningitis infections. Its developers asked a number of infectious-disease experts to blindly evaluate the performance of both MYCIN and a number of human specialists in infectious diseases. MYCIN's ranking was comparable to that of the human specialists (Buchanan & Shortliffe 1984). Similarly, Digital Equipment Corporation decided that XCON, a program for configuring VAX computers, was ready for commercial use when its performance was comparable to that of human engineers (McDermott 1981).

Expert systems have been built to solve a range of problems in domains such as medicine, mathematics, engineering, chemistry, geology, computer science, business, law, defense, and education. These programs have addressed a wide range of problem types; the following list, adapted from Waterman (1986), is a useful summary of general expert system problem categories.

1. *Interpretation*—forming high-level conclusions or descriptions from collections of raw data.
2. *Prediction*—projecting probable consequences of given situations.
3. *Diagnosis*—determining the cause of malfunctions in complex situations based on observable symptoms.
4. *Design*—finding a configuration of system components that meets performance goals while satisfying a set of design constraints.
5. *Planning*—devising a sequence of actions that will achieve a set of goals given certain starting conditions and run-time constraints.
6. *Monitoring*—comparing a system's observed behavior to its expected behavior.
7. *Debugging and Repair*—prescribing and implementing remedies for malfunctions.
8. *Instruction*—detecting and correcting deficiencies in students' understanding of a subject domain.
9. *Control*—governing the behavior of a complex environment.

In this chapter we first (Section 6.1) examine the technology that makes knowledge intensive problem-solving possible. Successful *knowledge engineering* must address a range of problems, from the choice of an appropriate application domain, to the design of the basic software architecture, to the acquisition and formalization of problem-solving knowledge. In Section 6.2 we present the production system as a basic software architecture for rule-based problem-solving. Section 6.3 examines techniques for model-based reasoning. Case-based reasoning (Section 6.4) emulates yet another common human problem-solving strategy: reasoning directly from collected examples of previous problem-solving experiences. Rather than applying general rules or models to problem-

solving, case-based reasoners begin with a set of *cases*, representing solutions to specific problems: on encountering a new problem, a case-based reasoner will select a solution to a similar problem, and attempt to modify it for the new situation. Section 6.5 summarizes knowledge-based problem-solving by considering the strengths and weakness of each of the approaches presented in this chapter. Chapter 7, presenting methods for reasoning in situations of uncertainty, and Chapter 8, describing a broad set of knowledge representation techniques, address further important issues in knowledge-intensive problem solving.

6.1 Overview of Expert System Technology

6.1.1 The Design of Rule-Based Expert Systems

Figure 6.1 shows the most important modules that make up a rule-based expert system. The user interacts with the expert system through a *user interface* that simplifies communication and hides much of the system complexity (e.g., the internal structure of the rule base). Expert systems employ a variety of interface styles, including question-and-answer, menu-driven, natural language, or graphics interfaces, where the final decision on interface type is a compromise between user needs and the requirements of the knowledge base and inferencing system.

The heart of the expert system is the *general knowledge base*, which contains the problem-solving knowledge of the particular application. In a rule-based expert system this knowledge is represented in the form of *if... then...* rules, as in our examples of Section 6.2. The knowledge base contains both *general knowledge* as well as *case-specific* information.

The *inference engine* applies the knowledge to the solution of actual problems. It is essentially an interpreter for the knowledge base. In the production system, the inference

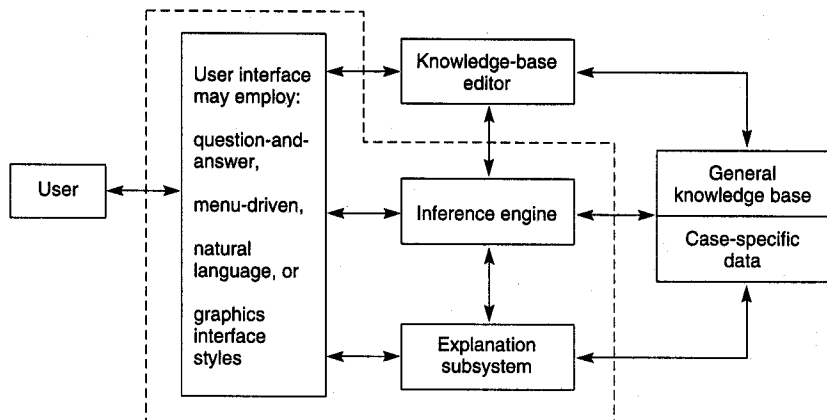

Figure 6.1 Architecture of a typical expert system.

engine performs the recognize-act control cycle. The procedures that implement the control cycle are separate from the production rules themselves. It is important to maintain this separation of the knowledge base and inference engine for several reasons:

1. The separation of the problem-solving knowledge and the inference engine makes it possible to represent knowledge in a more natural fashion. If ... then... rules, for example, are closer to the way in which human beings describe their own problem-solving techniques than a program that embeds this knowledge in lower-level computer code.
2. Because the knowledge base is separated from the program's lower-level control structures, expert system builders can focus directly on capturing and organizing problem-solving knowledge rather than on the details of its computer implementation.
3. The separation of knowledge and control, along with the modularity provided by rules and other representational structures used in building knowledge bases, allows changes to be made in one part of the knowledge base without creating side effects in other parts of the program.
4. The separation of the knowledge and control elements of the program allows the same control and interface software to be used in a variety of systems. The *expert system shell* has all the components of Figure 6.1 except that the knowledge base and, of course, the case-specific data contain no information. Programmers can use the "empty shell" and create a new knowledge base appropriate to their application. The broken lines of Figure 6.1 indicate the shell modules.
5. As illustrated in the discussion of production systems (Chapter 5), this modularity allows us to experiment with alternative control regimes for the same rule base.

The program must keep track of *case-specific data*: the facts, conclusions, and other information relevant to the case under consideration. This includes the data given in a problem instance, partial conclusions, confidence measures of conclusions, and dead ends in the search process. This information is separate from the general knowledge base.

The *explanation subsystem* allows the program to explain its reasoning to the user. These explanations include justifications for the system's conclusions (in response to *how queries*, as discussed in Section 6.2), explanations of why the system needs a particular piece of data (*why queries*, Section 6.2), and, where useful, tutorial explanations or deeper theoretical justifications of the program's actions.

Many systems also include a *knowledge-base editor*. Knowledge-base editors help the programmer locate and correct bugs in the program's performance, often accessing the information provided by the explanation subsystem. They also may assist in the addition of new knowledge, help maintain correct rule syntax, and perform consistency checks on the updated knowledge base.

The use of an expert system shell can reduce the design and implementation time of a program considerably. For example, the MYCIN expert system for diagnosing spinal

meningitis was developed in about 20 person-years. EMYCIN (Empty MYCIN) is a general expert system shell that was produced by removing the specific domain knowledge from the MYCIN program. Using EMYCIN, knowledge engineers implemented PUFF, a program to analyze pulmonary problems in patients, in about 5 person-years. This is a remarkable saving and an important aspect of the commercial viability of expert system technology. Expert system shells are available for all classes of computers.

It is important that the programmer choose the proper expert system shell. Different problems often require different reasoning processes: goal-driven vs. data-driven search, for instance. The control strategy provided by the shell must be appropriate to the application; the medical reasoning required for the PUFF application was much like that used in the original MYCIN work; this made the use of the EMYCIN shell appropriate. If the shell does not support the appropriate reasoning processes, its use can be a mistake and worse than starting from nothing. As we shall see, part of the responsibility of the expert system builder is to correctly characterize the reasoning processes required for a given problem situation and then to either select or construct an inference engine that implements these structures.

Unfortunately, shell programs do not solve all of the problems involved in building expert systems. Although the separation of knowledge and control, the modularity of the production system architecture, and the use of an appropriate knowledge representation language all help with the building of an expert system, the acquisition and formalization of domain knowledge remain very difficult tasks.

6.1.2 Selecting a Problem for Expert System Development

Expert systems often involve a considerable investment of money and human effort. Attempts to solve a problem that is too complex, too poorly understood, or otherwise unsuited to the available technology can lead to costly and embarrassing failures. Researchers have developed an informal set of guidelines for determining whether a problem is appropriate for expert system solution:

1. **The need for the solution justifies the cost and effort of building an expert system.** For example, Digital Equipment Corporation had experienced considerable financial expense because of errors in configuring VAX and PDP-11 computers. If a computer is shipped with missing or incompatible components, the company is obliged to correct this situation as quickly as possible, often incurring added shipping expense or absorbing the cost of parts not taken into account when the original price was quoted. Because this expense was considerable, DEC was extremely interested in automating the configuration task. The resulting expert system, XCON, has paid for itself in both financial savings and customer goodwill (McDermott and Bachant 1984). Similarly, many expert systems have been built in domains such as mineral exploration, business, defense, and medicine where a large potential exists for savings in money, time, and human life. In recent years, the cost of building expert systems has gone down as software tools and expertise in AI are more available. The range of potentially profitable applications has grown correspondingly.

2. **Human expertise is not available in all situations where it is needed.** Much expert system work has been done in medicine, for example, because the specialization and technical sophistication of modern medicine have made it difficult for doctors to keep up with advances in diagnostics and treatment methods. Specialists with this knowledge are rare and expensive, and expert systems are seen as a way of making their expertise available to a wider range of doctors. In geology, there is a need for expertise at remote mining and drilling sites. Often, geologists and engineers find themselves traveling large distances to visit sites, with resulting expense and wasted time. By placing expert systems at remote sites, many problems may be solved without needing a visit by a human expert. Similarly, loss of valuable expertise through employee turnover or pending retirement may justify building an expert system. Many other jobs in our society require expertise that is not always available. These jobs include insurance claims adjustment, credit approval, regulatory compliance, and forms handling.

3. **The problem may be solved using symbolic reasoning techniques.** Problem solutions should not require physical dexterity or perceptual skill. Although robots and vision systems are available, they currently lack the sophistication and flexibility of human beings. Expert systems should be restricted to problems that humans can solve through symbolic reasoning.

4. **The problem domain is well structured and does not require commonsense reasoning.** Although expert systems have been built in a number of areas requiring specialized technical knowledge, more mundane commonsense reasoning is well beyond current capabilities. Highly technical fields have the advantage of being well studied and formalized: terms are well defined and domains have clear and specific conceptual models. Most significantly, however, the amount of knowledge required to solve such problems is small in comparison to the amount of knowledge used by human beings in commonsense reasoning.

5. **The problem may not be solved using traditional computing methods.** Expert system technology should not be used to "reinvent the wheel." If a problem can be solved satisfactorily using more traditional techniques such as numerical, statistical, or operations research methods, then it is not a candidate for an expert system. Because expert systems rely on heuristic approaches, it is unlikely that an expert system will outperform an algorithmic solution if such a solution exists.

6. **Cooperative and articulate experts exist.** The knowledge used by expert systems is seldom found in textbooks but comes from the experience and judgment of humans working in the domain. It is important that these experts be both willing and able to share that knowledge. This implies that the experts should be articulate and believe that the project is both practical and beneficial. If, on the other hand, the experts feel threatened by the system, fearing that they may be replaced by it or that the project cannot succeed and is therefore a waste of time, it is unlikely that they will give it the necessary time and effort. It is also important that management support the project and allow domain experts to take time from their usual responsibilities to work with the knowledge engineers.

7. **The problem is of proper size and scope.** It is important that the problem not exceed the capabilities of current technology. For example, a program that attempted to capture all of the expertise of a medical doctor would not be feasible; a program that advised MDs on the use of a particular piece of diagnostic equipment would be more appropriate. As a rule of thumb, problems that require days or weeks for human experts to solve are probably too complex for current expert system technology.

Although a large problem may not be amenable to expert system solution, it may be possible to break it into smaller, independent subproblems that are. This corresponds to the "top-down" decomposition strategy used in traditional software engineering. Alternatively, we may be able to start with a simple program that solves a portion of the problem and gradually increase its functionality to handle more of the problem domain. This strategy is often called a "thin line" strategy, alluding to its goal of producing a prototype that sacrifices breadth of applicability in favor of providing a complete solution to a small set of test problems. It has proven a useful technique for exploring complex, poorly understood problem domains. This was done successfully in the creation of XCON: initially the program was designed only to configure VAX 780 computers; later it was expanded to include the full VAX and PDP-11 series (Bachant and McDermott 1984).

6.1.3 The Knowledge Engineering Process

The primary people involved in building an expert system are the *knowledge engineer*, the *domain expert*, and the *end user*.

The knowledge engineer is the AI language and representation expert. His or her main task is to select the software and hardware tools for the project, help the domain expert articulate the necessary knowledge, and implement that knowledge in a correct and efficient knowledge base. Often, the knowledge engineer is initially ignorant of the application domain.

The domain expert provides the knowledge of the problem area. The domain expert is generally someone who has worked in the domain area and understands its problem-solving techniques, such as shortcuts, handling imprecise data, evaluating partial solutions, and all the other skills that mark a person as an expert problem solver. The domain expert is primarily responsible for spelling out these skills to the knowledge engineer.

As in most applications, the end user determines the major design constraints. Unless the user is happy, the development effort is by and large wasted. The skills and needs of the user must be considered throughout the design cycle: Will the program make the user's work easier, quicker, more comfortable? What level of explanation does the user need? Can the user provide correct information to the system? Is the user interface appropriate? Does the user's work environment place any restrictions on the program's use? An interface that required typing, for example, would not be appropriate for use in the cockpit of a jet fighter.

Like most AI programming, building expert systems requires a nontraditional development cycle based on early prototyping and incremental revision of the code. This exploratory programming methodology (described in the introduction to Part IV) is complicated by the interaction between the knowledge engineer and the domain expert.

Generally, work on the system begins with the knowledge engineer attempting to gain some familiarity with the problem domain. This helps in communicating with the domain expert. This is done in initial interviews with the expert, by observing experts during the performance of their job, or by reading introductory texts in the domain area. Next, the knowledge engineer and expert begin the process of extracting the expert's problem-solving knowledge. This is often done by giving the domain expert a series of sample problems and having him or her explain the techniques used in their solution. We have found the use of video and/or audio tapes to be essential in this process.

It is often useful for the knowledge engineer to be a novice in the problem domain. Human experts are notoriously unreliable in explaining exactly what goes on in solving a complex problem. Often they forget to mention steps that have become obvious or even automatic to them after years of work in their field. Knowledge engineers, by virtue of their relative naiveté in the domain, should be able to spot these conceptual jumps and ask for clarification.

Once the knowledge engineer has obtained a general overview of the problem domain and gone through several problem-solving sessions with the expert, he or she is ready to begin actual design of the system: selecting a way to represent the knowledge, such as rules or frames, determining the search strategy, forward, backward, depth-first, best-first etc., and designing the user interface. After making these design commitments, the knowledge engineer builds a prototype.

This prototype should be able to solve problems in a small area of the domain and provide a test bed for preliminary design assumptions. Once the prototype has been implemented, the knowledge engineer and domain expert test and refine its knowledge by giving it problems to solve and correcting its shortcomings. Should the assumptions made in designing the prototype prove correct, the prototype can be built into a final system.

Expert systems are built by progressive approximations, with the program's mistakes leading to corrections or additions to the knowledge base. In a sense, the knowledge base is "grown" rather than constructed. Figure 6.2 presents a flow chart describing the exploratory programming development cycle. This approach to programming was investigated by Seymour Papert with his LOGO language (Papert 1980) as well as Alan Kay's work at Xerox PARC. The LOGO philosophy argues that watching the computer respond to the improperly formulated ideas represented by the code leads to their correction (being *debugged*) and clarification with more precise code. This process of trying and correcting candidate designs is common to expert systems development, and contrasts with such neatly hierarchical processes as top-down design.

It is also understood that the prototype may be thrown away if it becomes too cumbersome or if the designers decide to change their basic approach to the problem. The prototype lets program builders explore the problem and its important relationships by actually constructing a program to solve it. After this progressive clarification is complete, they can then often write a cleaner version, usually with fewer rules (McDermott 1981).

The second major feature of expert system programming is that the program need never be considered "finished." A large heuristic knowledge base will always have limitations. The modularity of the production system model make it natural to add new rules or make up for the shortcomings of the present rule base at any time.

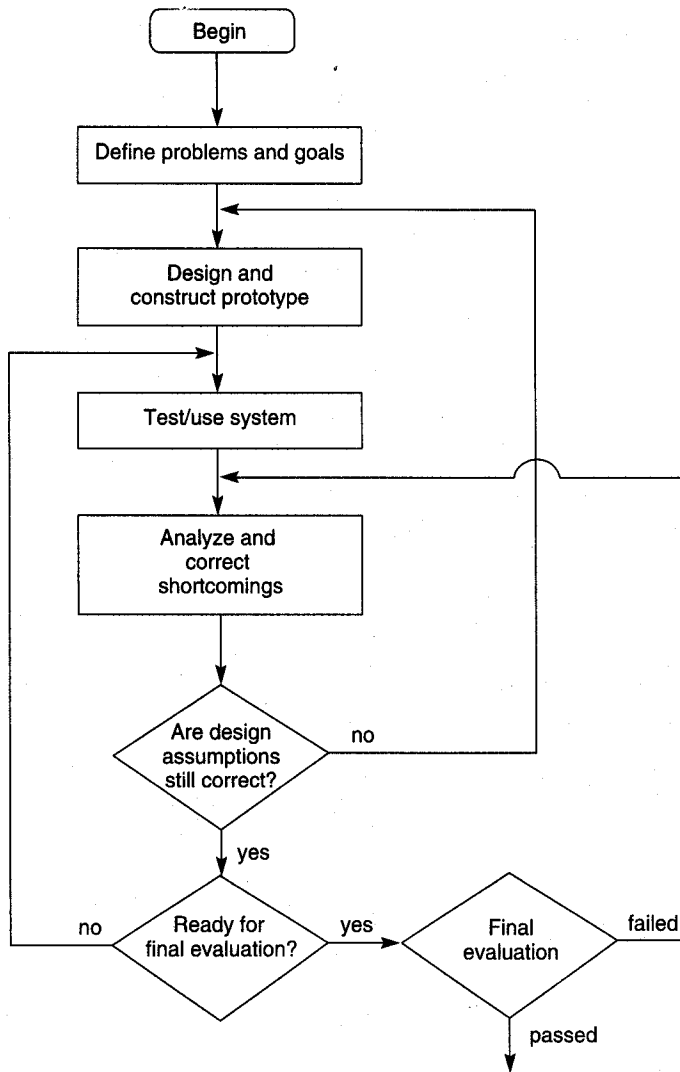

Figure 6.2 Exploratory development cycle.

6.1.4 Conceptual Models and Their Role in Knowledge Acquisition

Figure 6.3 presents a simplified model of the knowledge acquisition process that will serve as a useful “first approximation” for understanding the problems involved in acquiring and formalizing human expert performance. The human expert, working in an application area, operates in a domain of knowledge, skill, and practice. This knowledge is often vague, imprecise, and only partially verbalized. The knowledge engineer must translate

Knowledge Acquisition

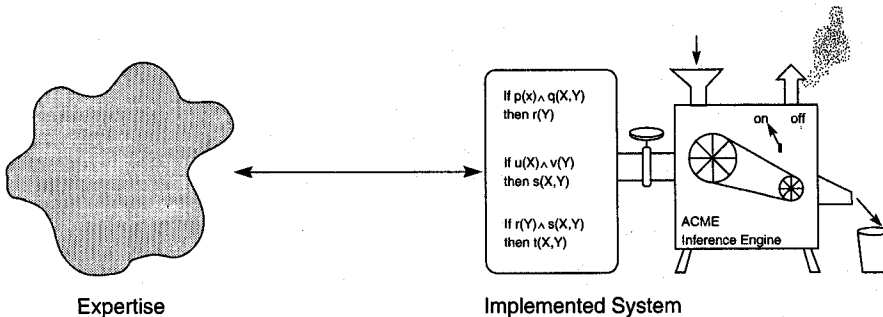

Figure 6.3 The standard view of building an expert system.

this informal expertise into a formal language suited to a computational system. The simplified model of Figure 6.3 helps us articulate several important problems in knowledge acquisition:

1. Human skill is often inaccessible to the conscious mind. As Aristotle points out in his *Ethics*, "what we have to learn to do, we learn by doing." Skills such as those possessed by medical doctors are learned as much in years of internship and residency, with their constant focus on patients, as they are in physiology lectures, where emphasis is on experiment and theory. Delivery of medical care is to a great extent practice driven. After years of performance these skills become highly integrated and function at a largely unconscious level. It may be difficult for experts to describe exactly what they do in problem-solving.
2. Human expertise often takes the form of knowing *how* to cope in a situation rather than knowing *what* a rational characterization of the situation might be, of developing skilled performance mechanisms rather than a fundamental understanding of what these mechanisms are. An obvious example of this is riding a unicycle: the successful rider is not, in real time, consciously solving multiple sets of simultaneous differential equations to keep in balance; rather she is using an intuitive combination of feelings of "gravity," "momentum," and "inertia" to form a usable control procedure. In fact, we find a huge gap often exists between human expertise in an application area and any precise accounting of this skill. Many of the reasons behind this have been considered by cognitive scientists and philosophers, as we present in Chapter 16 (see also Luger 1994).
3. We often think of knowledge acquisition as gaining factual knowledge of an objective reality, the so-called "real world." As both theory and practice have shown, human expertise represents an individual's or a community's model of the world. Such models are as influenced by convention, social processes, and hidden agendas as they are by empirical methodologies.

- Expertise changes. Not only do human experts gain new knowledge, but also existing knowledge may be subject to radical reformulation, as evidenced by ongoing controversies in both scientific and nonscientific fields.

Consequently, knowledge engineering is difficult and should be viewed as spanning the life cycle of any expert system. To simplify this task, it is useful to have, as in Figure 6.4, a *conceptual model* that lies between the human expertise and the implemented program. By conceptual model, we mean the knowledge engineer's evolving conception of the domain knowledge. Although this is undoubtedly different from the domain expert's, it is this model that actually determines the construction of the formal knowledge base.

Because of the complexity and multiple sources of ambiguity in the problem, we should not take this intermediate stage for granted. Knowledge engineers should document and make public their assumptions about the domain through common software engineering methodologies. An expert system should include a requirements document; however, because of the constraints of exploratory programming, expert system requirements should be treated as co-evolving with the prototype. Data dictionaries, graphic representations of state spaces, and comments in the code itself are all part of this model. By publicizing these design decisions, we reduce errors in both the implementation and maintenance of the knowledge base.

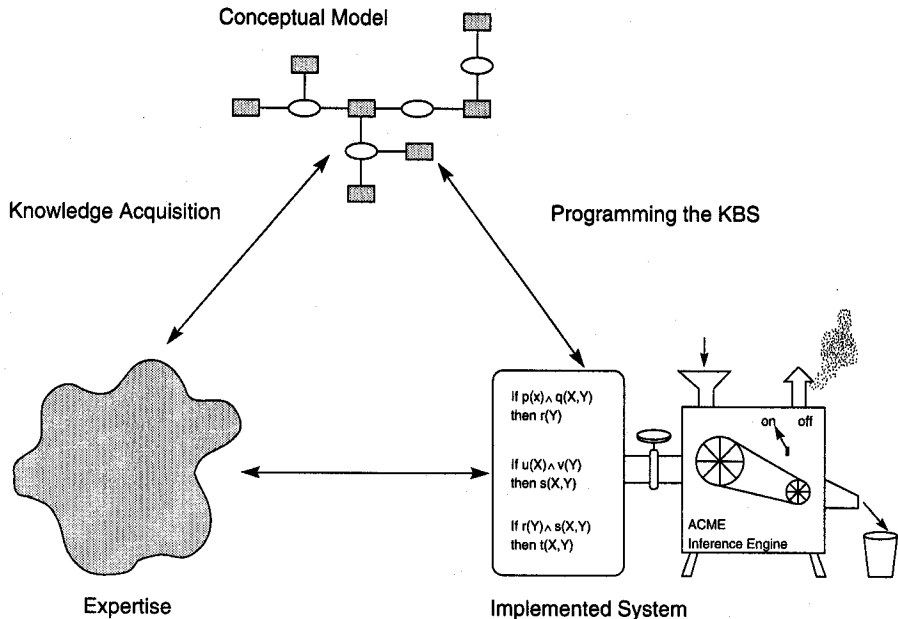

Figure 6.4 The role of mental or conceptual models in problem-solving.

Knowledge engineers should save recordings of interviews with domain experts. Often, as knowledge engineers' understanding of the domain grows, they form new interpretations or discover new information about the domain. The recordings, along with documentation of the interpretation given them, play a valuable role in reviewing design decisions and testing prototypes. Finally, this model serves an intermediate role in the formalization of knowledge. The choice of a representation language exerts a strong influence on a knowledge engineer's model of the domain.

The conceptual model is not formal or directly executable on a computer. It is an intermediate design construct, a template to begin to constrain and codify human skill. It can, if the knowledge engineer uses a predicate calculus model, begin as a number of simple networks representing the expert's states of reasoning through typical problem-solving situations. Only after further refinement does this network become explicit if... then... rules.

Questions often asked in the context of a conceptual model include: Is the problem solution deterministic or search-based? Is the reasoning data-driven, perhaps with a generate-and-test flavor, or goal-driven, based on a small set of hypotheses about situations? Are there stages of reasoning? Is the domain well understood and capable of providing deep predictive models, or is all problem-solving knowledge essentially heuristic? Can we use examples of past problems and their solutions to solve future problems directly, or must we first convert these examples into general rules? Is the knowledge exact or is it "fuzzy" and approximate, lending itself to numeric ratings of certainty (Sections 7.1 and 7.3)? Will our reasoning strategies allow us to infer stable facts about the domain, or do change and uncertainty require nonmonotonic reasoning, the ability to make assertions about the domain that may later be modified or retracted (Section 7.2)? Does the structure of the domain knowledge require us to abandon rules and rule-based inference entirely in favor of such alternative representations as neural networks or genetic algorithms?

The eventual users' needs should also be addressed in the context of the conceptual model: What are their expectations of the eventual program? Where is their level of expertise: novice, intermediate, or expert? What levels of explanation are appropriate? What interface best serves their needs?

Based on the answers to these and other questions, the knowledge obtained from domain experts and the resulting conceptual model, we can begin development of the expert system. Because the production system, first presented in Chapter 5, offers a number of inherent strengths for organizing and applying knowledge, it is often used as the basis for knowledge representation in rule-based expert systems.

6.2 Rule-based Expert Systems

Rule-based expert systems represent problem-solving knowledge as if... then... rules. This approach lends itself to the architecture of Figure 6.1, and is one of the oldest techniques for representing domain knowledge in an expert system. It is also one of the most natural, and remains widely used in practical and experimental expert systems.

6.2.1 The Production System and Goal-driven problem-solving

The architecture of rule-based expert systems may be understood in terms of the production system model for problem-solving presented in Part II. In fact, the parallel between the two is more than a simple analogy: the production system was the intellectual precursor of modern expert system architecture. When Newell and Simon began developing the production system model, their goal was to find a way to model human performance in problem-solving.

If we regard the expert system architecture in Figure 6.1 as a production system, the knowledge base is the set of production rules. In a rule-based system, these condition-action pairs are represented as if... then... rules, with the premises of the rules, the *if* portion, corresponding to the condition, and the conclusion, the *then* portion, corresponding to the action: when the condition is satisfied, the expert system takes the action of asserting the conclusion as true. Case-specific data are kept in the working memory. The inference engine implements the recognize-act cycle of the production system; this control may be either data-driven or goal-driven.

Many problem domains seem to lend themselves more naturally to forward search. In an interpretation problem, for example, most of the data for the problem are initially given and it is often difficult to formulate an hypotheses or goal. This suggests a forward reasoning process in which the facts are placed in working memory and the system searches for an interpretation. These issues were first discussed in Chapter 3, and in more detail in Section 6.2.3.

In a goal-driven expert system, the goal expression is initially placed in working memory. The system matches rule *conclusions* with the goal, selecting one rule and placing its *premises* in the working memory. This corresponds to a decomposition of the problem's goal into simpler subgoals. The process continues in the next iteration of the production system, with these premises becoming the new goals to match against rule conclusions. The system thus works back from the original goal until all the subgoals in working memory are known to be true, indicating that the hypothesis has been verified. Thus, backward search in an expert system corresponds roughly to the process of hypothesis testing in human problem-solving.

In an expert system, subgoals are often solved by asking the user for information. Most expert system shells allow the system designer to specify which subgoals may be solved by asking the user. Other inference engines simply ask about all subgoals that fail to match the conclusion of some rule in the knowledge base; i.e., if the program cannot infer the truth of a subgoal, it asks the user.

As a more detailed example of goal-driven problem-solving, consider the following small expert system for diagnosing automotive problems:

```
Rule 1: if
    the engine is getting gas, and
    the engine will turn over,
    then
    the problem is spark plugs.
```

- Rule 2: if
 the engine does not turn over, and
 the lights do not come on
 then
 the problem is battery or cables.
- Rule 3: if
 the engine does not turn over, and
 the lights do come on
 then
 the problem is the starter motor.
- Rule 4: if
 there is gas in the fuel tank, and
 there is gas in the carburetor
 then
 the engine is getting gas.

To run this knowledge base under a goal-directed control regime, place the top-level goal, the problem is X, in working memory as shown in Figure 6.5. X is a variable that can match with any phrase, for example the problem is battery or cables; it will become bound to the solution when the problem is solved.

Three rules match with the expression in working memory: rule 1, rule 2, and rule 3. If we resolve conflicts in favor of the lowest-numbered rule, then rule 1 will fire. This causes X to be bound to the value spark plugs and the premises of rule 1 to be placed in the working memory as in Figure 6.6. The system has thus chosen to explore the possible

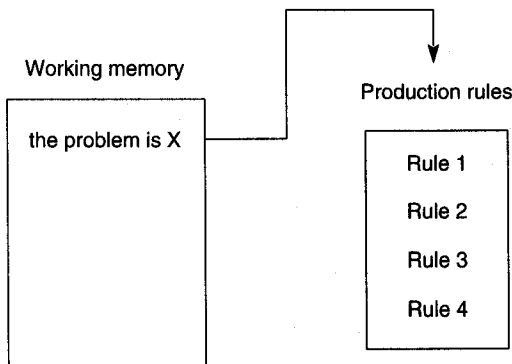

Figure 6.5 The production system at the start of a consultation in the car diagnostic example.

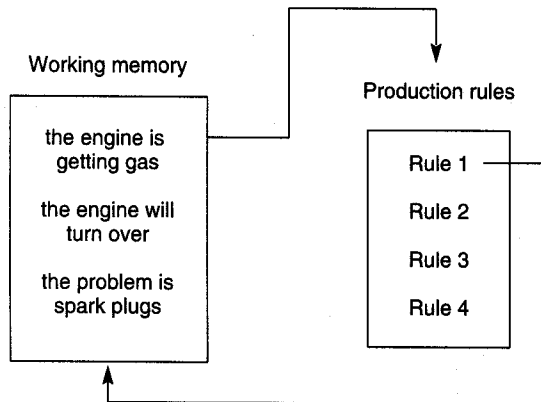

Figure 6.6 The production system after Rule 1 has fired.

hypothesis that the spark plugs are bad. Another way to look at this is that the system has selected an **or** branch in an **and/or** graph (Chapter 3).

Note that there are two premises to rule 1, both of which must be satisfied to prove the conclusion true. These are **and** branches of the search graph representing a decomposition of the problem (finding whether the problem is spark plugs) into two subproblems (finding whether the engine is getting gas and whether the engine will turn over). We may then fire rule 4, whose conclusion matches with the engine is getting gas, causing its premises to be placed in working memory as in Figure 6.7.

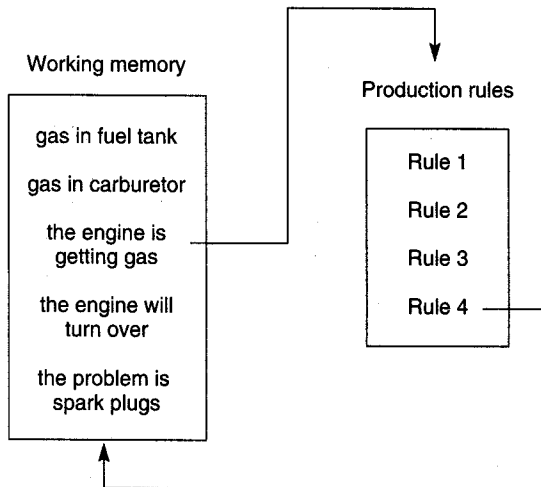

Figure 6.7 The production system after Rule 4 has fired.

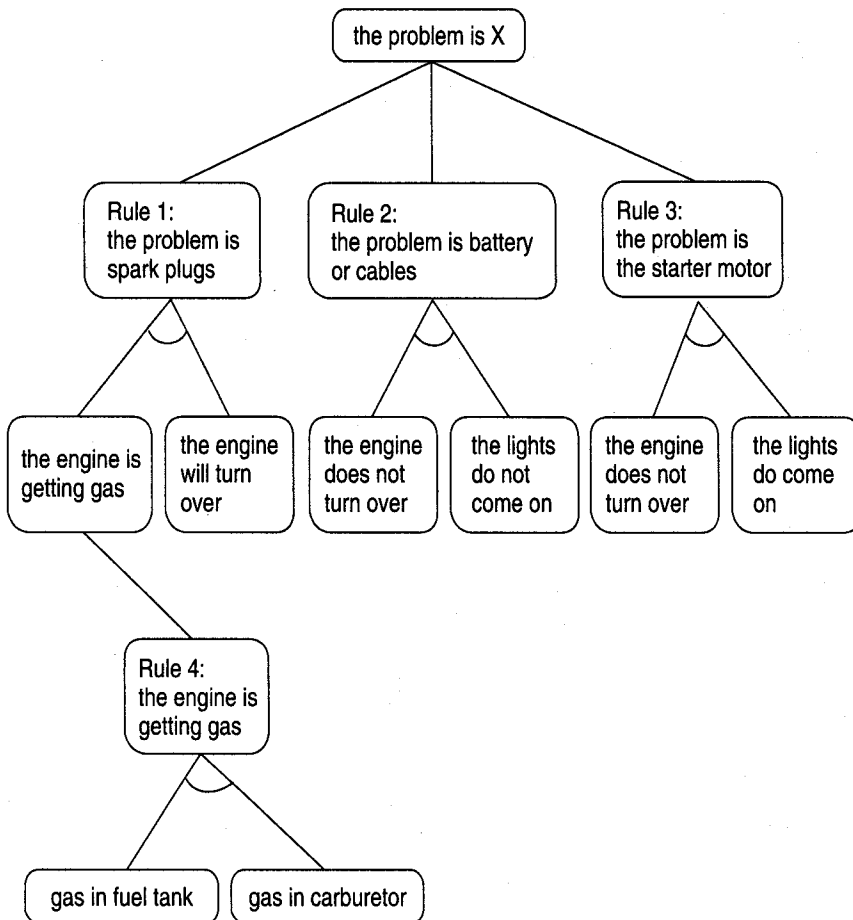

Figure 6.8 The and/or graph searched in the car diagnosis example.

At this point, there are three entries in working memory that do not match with any rule conclusions. Our expert system will, in this situation, query the user directly about these subgoals. If the user confirms all three of these as true, the expert system will have successfully determined that the car will not start because the spark plugs are bad. In finding this solution, the system has searched the leftmost branch of the and/or graph presented in Figure 6.8.

This is, of course, a very simple example. Not only is its automotive knowledge limited at best, but it also ignores a number of important aspects of real implementations. The rules are phrased in English, rather than a formal language. On finding a solution, a real expert system will tell the user its diagnosis (our model simply stops). Also, we should maintain enough of a trace of the reasoning to allow backtracking if necessary. In our example, had we failed to determine that the spark plugs were bad, we would have needed to back up to the top level and try rule 2 instead. Notice that this information is

implicit in the ordering of subgoals in working memory of Figure 6.7 and in the graph of Figure 6.8. In spite of its simplicity, however, this example underscores the importance of production system based search and its representation by the **and/or** graph as the foundation for rule-based expert systems.

At the beginning of this chapter, we emphasized that an expert system needed to be open to inspection, easily modified, and heuristic in nature. The production system architecture is an important factor in each of these requirements. Ease of modification, for example, is made possible by the syntactic independence of production rules: each rule is a chunk of knowledge that can be independently modified. The next section discusses the way in which the production system architecture supports explanations and inspection of the reasoning process.

6.2.2 Explanation and Transparency in Goal-driven Reasoning

The production system implements a graph search. The explanation routines of Figure 6.1 keep track of the graph search and use a trace of the search to answer user queries. The production rules themselves document each step of the reasoning process.

In general, the two questions answered by rule-based expert systems are *why?* and *how?* A *why* query occurs when the program asks the user for information and the user responds with *why*, meaning “why did you ask for that information?”. The answer is the current rule that the production system is attempting to fire. The answer to “how did you get that result?” is the sequence of rules that were used to conclude a goal.

Suppose our automotive expert system has an explanation facility, and assume that the consultation has reached the stage represented by the working memory configuration in Figure 6.7. The following dialogue begins with the computer asking the user about the goals present in working memory. User responses are in bold type.

gas in fuel tank?
yes
gas in carburetor?
yes
engine will turn over?
why

Here the user enters a *why* query, i.e., why do you want to know whether the engine will turn over? The system responds:

It has been established that:

1. the engine is getting gas,
therefore if
2. the engine will turn over,
then the problem is spark plugs.

Because the user answered **yes** to the first two questions, rule 4 was able to fire, verifying the first premise of rule 1. When the **why** query was made, the system was trying to solve the second premise of rule 1. Note that the explanation for the system's behavior is just a restatement of the current rule under consideration. However, this provides an adequate explanation for why the program wants to know whether the engine will turn over. In the response to the **why** query, the system states that it has concluded that the engine is getting gas. Suppose the user then asks:

how the engine is getting gas

The system will respond to how it concluded that the engine is getting gas. The response is a trace of the reasoning that led to this conclusion, working back from the goal along the rules that support it to the user responses:

This follows from rule 4:

if

gas in fuel tank, and

gas in carburetor

then

engine is getting gas.

gas in fuel tank was given by the user

gas in carburetor was given by the user

Once again, the production system architecture provides an essential basis for these explanations. Each cycle of the control loop selects and fires another rule. The program may be stopped after each cycle and inspected. Because each rule represents a complete chunk of problem-solving knowledge, the current rule provides a context for the explanation. Contrast this production system approach with more traditional program architectures: if we stop a C or C++ program in mid execution, it is doubtful that the current statement will have much meaning.

In summary, the knowledge-based system answers **why** queries by showing the current rule that it is attempting to fire; it answers **how** queries by giving a trace of the reasoning that led to a goal. Although the mechanisms are conceptually simple, they can exhibit remarkable explanatory power if the knowledge base is organized in a logical fashion. The chapters on LISP and PROLOG, Part IV, demonstrate the use of rule stacks and proof trees to implement these explanations.

If explanations are to behave logically, it is important not only that the knowledge base get the correct answer but also that each rule correspond to a single logical step in the problem-solving process. If a knowledge base combines several steps into a single rule or if it breaks up the rules in an arbitrary fashion, it may get correct answers but seem vague, arbitrary or illogical in responding to **how** and **why** queries. This not only undermines the user's faith in the system but also makes the program much more difficult for its builders to understand and modify.

6.2.3 Using the Production System for Data-driven Reasoning

The automobile diagnosis demonstration of Section 6.2.1 illustrated the use of a production system to implement goal-driven search. Search was also depth-first in that it searched each subgoal found in the rule base exhaustively before moving onto any sibling goals. As we saw in Section 5.3, however, the production system is also an ideal architecture for data-driven reasoning. Example 5.3.1 demonstrated this process with the 8-puzzle and Examples 5.3.2 and 5.3.3 with the Knight's Tour. In each of these problems we did conflict resolution by taking the first rule found in the knowledge base and then followed the results of that rule. This gave the search a depth-first flavor, although there was no mechanism, such as backtracking, to handle the problem of "dead ends" in the search space.

Breadth-first search is even more common in data-driven reasoning. The algorithm for this is simple: Compare the contents of working memory with the conditions of each rule in the rule base using the ordering of the rule base. If the data in working memory supports a rule's firing the result is placed in working memory and then control moves on to the next rule. Once all rules have been considered search starts again at the beginning of the rule set.

Consider, for example, the automobile diagnosis problem and the rules of Section 6.2.1. If a piece of information that makes up (part of) the premise of a rule is not the conclusion of some other rule then that fact will be deemed "askable" when control comes to the situation (rule) where that information is needed. For example, the engine is getting gas is not askable in the premise of rule 1, because that fact is a conclusion of another rule, namely rule 4.

The breadth-first, data-driven example begins as in Figure 6.5, except that there is no information in working memory, as in Figure 6.9, and we examine premises of the four rules in order to see what information is "askable." The premise, the engine is getting gas is not askable, so rule 1 fails and control moves to rule 2. The engine does not turn over is askable. Suppose the answer to this query is false, so the engine will turn over is placed in working memory, as in Figure 6.10.

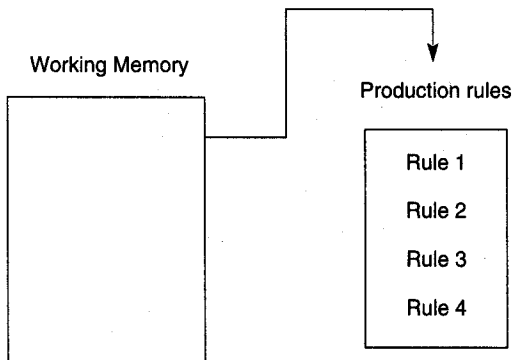

Figure 6.9 The production system in the start of a consultation for data-driven reasoning.

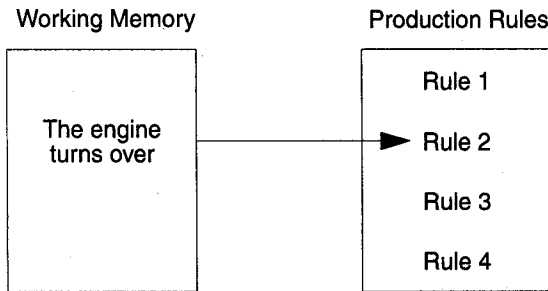

Figure 6.10 The production system after evaluating the first premise of Rule 2, which then fails.

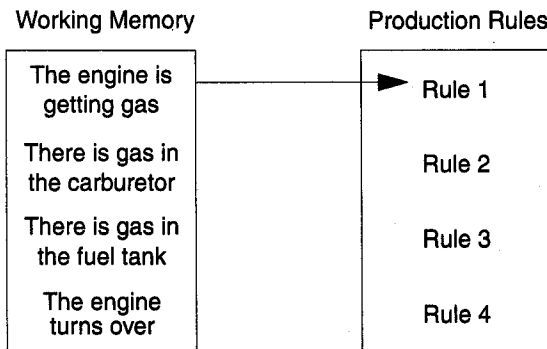

Figure 6.11 The data-driven production system after considering Rule 4, beginning its second pass through the rules.

But rule 2 fails, since the first of two and premises is false, and consideration moves to rule 3, where again, the first premise fails. At rule 4, both premises are askable. Suppose the answer to both questions is true. Then **there is gas in the fuel tank** and **there is gas in the carburetor** are placed in working memory, as is the conclusion of the rule, **the engine is getting gas**.

At this point all the rules have been considered so search now returns, with the new contents of working memory, to consider the rules in order a second time. As is seen in Figure 6.11, when the working memory is matched to rule 1, its conclusion, **the problem is spark plugs**, is placed in working memory. In this example no more rules will match and fire and the problem-solving session is completed. A graph of the search process, with the information content of working memory (WM) as the nodes of the graph, is presented as Figure 6.12.

An important refinement on the breadth-first search strategy used in the previous example is what is called *opportunistic search*. This search strategy is simple: whenever a rule fires to conclude new information, control moves to consider those rules which have

that new information as a premise. This makes any new *concluded* information (search does not change as the result of “askable” premises) the controlling force for finding the next rules to fire. This is termed opportunistic because each conclusion of new information drives the search. By the accident of rule ordering, the very simple example just presented was also opportunistic.

We conclude this section on data-driven reasoning with several comments on explanation and transparency in forward chaining systems. First, in comparison with goal-driven systems, Sections 6.2.1–2, data-driven reasoning is much less “focused” in its search. The reason for this is obvious: in a goal-driven system, reasoning is in pursuit of a particular goal; that goal is broken into subgoals that support the top-level goal and these subgoals may be even further broken down. As a result search is always directed through this goal and subgoal hierarchy. In data-driven systems this goal orientation does not exist. Rather the search moves about the tree depending only on rule order and the discovery of new information. As a result, the progress of search can often seem very diffuse and unfocused.

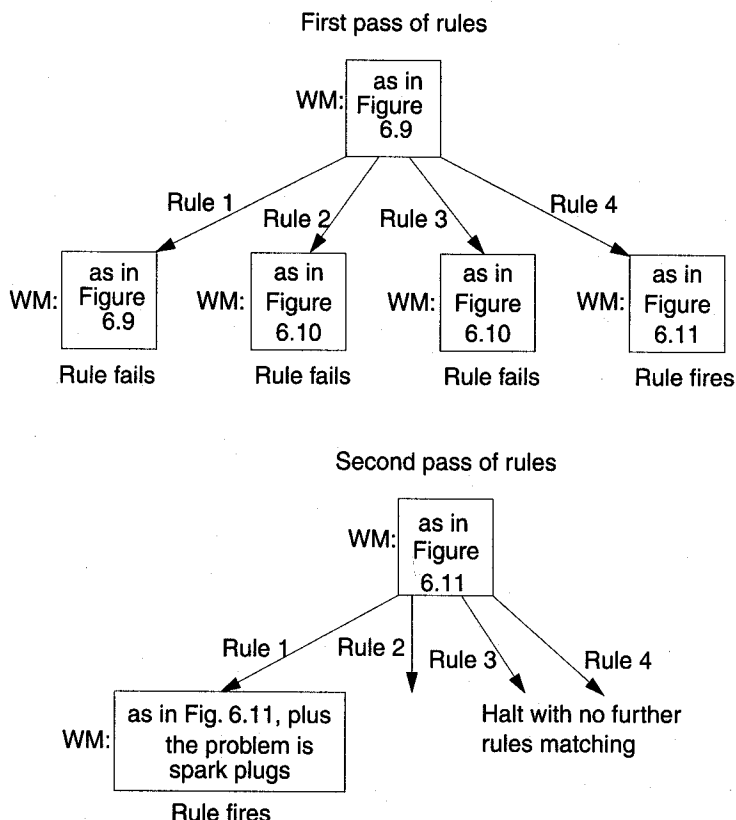

Figure 6.12 The search graph as described by the contents of working memory (WM) for the data-driven breadth-first search of the rule set of Section 6.2.1.

Second, and as a direct result of the first point, the explanation available to the user at any time in the search is quite limited. There is always a rule-level accountability in that when the user asks why some information is required, the current rule under consideration can be presented. We saw this response to the why query in Section 6.2.2. The explanation cannot go much further, however, unless explicit rule tracking information is added into the system, say with opportunistic search. The diffuse nature of the data-driven search makes this difficult to do. Finally, when a goal is achieved, getting a full how explanation for that goal is also difficult. About the only thing that can be used as a partial and very limited explanation is a presentation of the contents of the working memory or a list of rules fired. But again, these will not offer the consistent focused accountability we saw with goal-driven reasoning.

6.2.4 Heuristics and Control in Expert Systems

Because of the separation of the knowledge base and the inference engine, and the fixed control regimes provided by the inference engine, a further important manner in which the programmer can control the search is through the structuring and ordering of the rules in the knowledge base. This micro-managing of the rule set offers an important opportunity, as the control strategies required for expert-level problem-solving tend to be domain specific and knowledge intensive. Although a rule of the form if p, q, and r then s resembles a logical expression, it may also be interpreted as a series of procedures for solving a problem: to do s, first do p, then do q, then do r. The role of rule and premise ordering was implicit in the examples of Section 6.2 just presented.

Although the procedural interpretation of rules reduces many of the advantages of “purely” declarative representation, it is an essential component of practical knowledge engineering and often reflects the human expert’s solution strategy. For example, we may order the premises of a rule so that the premise that is most likely to fail or is easiest to confirm will be tried first. This gives the opportunity of eliminating a rule (and hence a portion of the search space) as early in the search as possible. Rule 1 in the automotive example tries to determine whether the engine is getting gas before it asks if the engine turns over. This is inefficient, in that trying to determine whether the engine is getting gas invokes another rule and eventually asks the user two questions. By reversing the order of the premises, a negative response to the query “engine will turn over?” eliminates this rule from consideration before the more involved condition is examined.

Also, it makes more sense to determine whether the engine is turning over before checking to see whether it is getting gas; if the engine won’t turn over it doesn’t matter whether it is getting gas! Rule 4 asks the user to check for gas in the fuel tank before asking that the user open up the carburetor and look there. In this situation, it is performing the easier check first.

In addition to the ordering of a rule’s premises, the content of a rule itself may be fundamentally heuristic in nature. In the automotive example, all the rules are heuristic. Consequently, the system may obtain erroneous results. For example, if the engine is getting gas and turning over, the problem may be a bad distributor rather than bad spark plugs.

Data-driven reasoning provides additional problems and opportunities for control of reasoning. Some of these include the high level-heuristics, such as refraction, recency (opportunistic search), and specificity presented in Section 5.3.3. A more domain-specific approach groups sets of rules according to stages of the solution process. For example, in diagnosing car problems we might create the four distinct stages of 1) organize situation, 2) collect the data, 3) do the analysis (there may be more than one problem with the car), and finally, 4) report the conclusions and recommended fixes.

This staged problem-solving can be accomplished by creating descriptors for each stage of the solution and placing that description as the first premise in all rules that belong to that stage. For example, we might begin by placing the assertion *organize situation* in working memory. If no other stage descriptions occur in working memory, then only rules that have *organize situation* in their set of premises will fire. Of course, this should be the first premise for each of these rules. We would move to the next stage by having the last rule to fire in the organizational stage *remove* (retract) the fact that stage is *organize solution* and assert the new fact that the stage is *data collection*. All the rules in the *data collection* stage would then have their first premise *IF stage is data collection and . . .* When the *data collection* stage is finished, the last rule would retract this fact, and assert the *data analysis* fact into working memory to match only those rules whose premises begin with the fact *IF stage is data analysis . . .*

In our discussion so far, we have described the behavior of the production system in terms of exhaustive considerations of the rule base. Although this is expensive, it captures the intended semantics of the production system. There are, however, a number of algorithms such as RETE (Forgy 1982) that can be used to optimize search for all potentially usable rules. Essentially, the RETE algorithm compiles rules into a network structure that allows the system to match rules with data by directly following a pointer to the rule. This algorithm greatly speeds execution, especially for larger rule sets, while retaining the semantic behavior we have described in this section.

6.2.5 Conclusions: Rule-Based Reasoning

Rules are the oldest approach to knowledge representation in expert systems, and remain an important technique for building knowledge-intensive problem solvers. Typically, an expert system's rules attempt to capture human expert knowledge as it is used in practice; consequently, they are often a blend of theoretical knowledge, heuristics derived from experience, and special-purpose rules for handling odd cases and other exceptions to normal practice. In many situations, this approach has proven effective. Nonetheless, strongly heuristic systems may fail, either on encountering a problem that does not fit any available rules, or by misapplying a heuristic rule to an inappropriate situation. Human experts do not suffer from these problems, because they have a deeper, theoretical understanding of the problem domain that allows them to apply the heuristic rules intelligently, or resort to reasoning from "first principles" in novel situations. *Model-based* approaches, described in Section 6.3, attempt to give an expert system this power and flexibility.

The ability to learn from examples is another human capability that knowledge-intensive problem solvers have recently attempted to emulate. *Case-based* reasoners,

discussed in Section 6.4, maintain a knowledge base of example problem solutions, or *cases*. When confronted with a new problem, the reasoner will select from this stored set a case that resembles the present problem, and then attempt to apply a form of its solution strategy to this problem. Legal reasoning, especially argument through precedent, is one of the best and most common examples of case-based reasoning.

6.3 Model-based Reasoning

6.3.1 Introduction

Human expertise is an extremely complex amalgamation of theoretical knowledge, experience-based problem-solving heuristics, examples of past problems and their solutions, perceptual and interpretive skills and other abilities that are so poorly understood that we can only describe them as intuitive. Through years of experience, human experts develop very powerful rules for dealing with commonly encountered situations. These rules are often highly “compiled,” taking the form of direct associations between observable symptoms and final diagnoses, and hiding their theoretical, more deeply explanatory foundations.

For example, the MYCIN expert system would propose a diagnosis based on such observable symptoms as “headaches,” “nausea,” or “high fever.” Although these parameters can be indicative of an illness, rules that link them directly to a diagnosis do not reflect any deeper, causal understanding of human physiology. MYCIN’s rules indicate the results of an infection, but do not explain its causes. A more deeply explanatory approach would detect the presence of infecting agents, note the resulting inflammation of cell linings, the presence of inter-cranial pressures, and infer the causal connection to the observed symptoms of headache, elevated temperatures and nausea.

In an example from semiconductor failure analysis, an approach based on descriptive symptoms might base a diagnosis of circuit failure on such symptoms as the discoloration of components (possibly indicating a burned out component), the history of faults in similar devices, or even observations of component interiors using an electron microscope. However, approaches that use rules to link observations and diagnoses do not offer the benefits of a deeper analysis of the device’s structure and function. A more robust, deeply explanatory approach would begin with a detailed model of the physical structure of the circuit and equations describing the expected behavior of each component and their interactions. It would base its diagnosis on signal readings from various locations in the device, using this data and its model of the circuit to determine the exact points of failure.

Because first generation expert systems relied upon heuristic rules gained from the human expert’s description of his or her problem-solving techniques, they exhibited a number of fundamental limitations (Clancy 1985). If a problem instance did not match their heuristics, they simply failed, even though a more theoretical analysis would have found a solution. Often, expert systems applied heuristics in inappropriate situations, situations where a deeper understanding of the problem would have indicated a different course. These are the limitations that model-based approaches attempt to address. A knowledge-based reasoner whose analysis is founded directly on the specification and functionality of a physical system is called a model-based system. In its design and use, a

model-based reasoner creates a software simulation of the function of that which we want to understand or fix.

The earliest model-based reasoners appeared in the mid-1970s and continued to mature through the 1980s (Davis and Hamscher 1988). It is interesting to note that some of the earliest work was intended to create software models of various physical devices, such as electronic circuits, for instructional purposes (deKleer 1976, Brown et al. 1982). In these early intelligent tutoring situations, the specifications for a device or circuit were reflected in sets of rules (Kirchoff's and Ohm's laws, for example). It was the task of the tutoring system both to test the student's knowledge of the device or circuit as well as to convey to the student any knowledge he or she might be missing. Rules were both the representation of the functionality of the hardware as well as the medium for conveying this knowledge to the student.

From these early tutoring systems, where the task was to both model and teach the functionality of a system, model-based reasoners moved to trouble-shooting systems. In trouble-shooting faults in a physical system the model leads to sets of predicted behaviors. A fault is reflected in the discrepancy between predicted and observed behavior. The model-based system tells its user what to expect, and when observations differ from these expectations, how these discrepancies lead to identification of faults.

Model-based diagnosis requires:

1. A description of each component in the device. These descriptions can simulate the behavior of the component.
2. A description of the device's internal structure. This is typically a representation of its components and their interconnections, along with the ability to simulate component interaction.
3. Diagnosis of a particular problem requires observations of the device's actual performance, typically measurements of its inputs and outputs. I/O measurements are easiest to obtain, but in fact, any measure could be used.

The task is then to determine which of the components could have failed in a way that accounts for the observed behaviors. This requires additional rules that describe known failure modes for the different components and their interconnections. The reasoner must find the most probable failures that can explain the observed system behavior.

A number of data structures can be used for representing the causal and structural information in models. Many model-based program designers use rules to reflect the causality and functionality of a device. Rules can also be used to capture the relationships between components. An object-oriented system, see Section 8.5, also offers an excellent representational tool for reflecting device and component structure within a model, with the slots of an object representing a device or component's state, and its methods defining its functionality.

To be more concrete in the design and evaluation of a model, we now consider several examples of device and circuit analysis from Davis and Hamscher (1988). Device behavior will be represented by a set of expressions that capture the relationships between

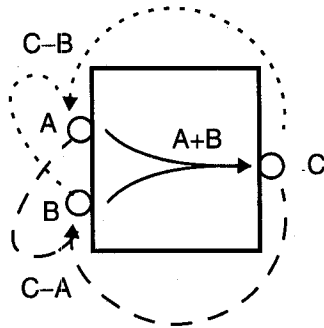

Figure 6.13 The behavior description of an adder (after Davis and Hamscher 1988).

values on the terminals of the device. For the adder of Figure 6.13, for example, there will be three expressions:

- If we know the values at A and B , the value of C is $A + B$ (the solid line).
- If we know C and A the value at B is $C - A$ (the dashed line).
- If we know C and B , the value at A is $C - B$ (the dotted line).

We need not have used an algebraic form to represent these relationships. We could equally well have used relational tuples or represented the constraints with LISP functions. The goal in model-based reasoning is to represent the knowledge that captures the functionality of the adder.

In a second example, consider the circuit of three multipliers and two adders linked as in Figure 6.14. In this example the input values are given at $A - E$ and the output values at F and G . The expected output values are given in () and the actual outputs in []. The task is to determine where the fault lies that will explain this discrepancy. At F we have a conflict, expecting a 12 and getting a 10. We check the dependencies at this point and determine that the value at F is a function of $ADD-1$ which in turn depends on the outputs of $MULT-1$ and $MULT-2$. One of these three devices must have a fault, and so we have three hypotheses to consider: either the adder behavior is bad or one of its two inputs was incorrect, and the problem lies further back in the circuit.

Reasoning from the result (10) at F and assuming correct behavior of $ADD-1$ and one of its inputs X (6), input Y to $ADD-1$ must be a 4. But that conflicts with the expectation of 6, which is the correct behavior of $MULT-2$ and inputs B and D . We have observed these inputs and know they are correct, so along this line of reasoning $MULT-2$ must be faulty. In a parallel argument, our second hypothesis is that $ADD-1$ is correct and $MULT-1$ is faulty.

Continuing our reasoning, if the first input X to $ADD-1$ is correct and $ADD-1$ itself is correct, then the second input Y must be a 4. If it were a 4, G would be 10 rather than 12, so the output of $MULT-2$ must be a 6 and correct. We are left with the hypotheses that the

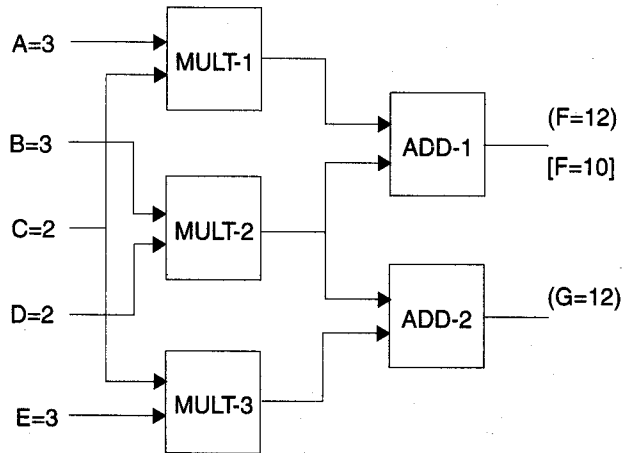

Figure 6.14 Taking advantage of direction of information flow (after Davis and Hamscher 1988).

fault lies in either MULT-1 or ADD-1 and we can continue to constrain these devices with further testing.

In our reasoning about the situation of Figure 6.14 we had three tasks:

1. Hypothesis generation, in which, given a discrepancy, we hypothesized which components of the device could have caused it.
2. Hypothesis testing, in which, given a collection of potential faulty components, we determined which of them could have explained the observed behavior.
3. Hypothesis discrimination, in which when more than one hypothesis survives the testing phase, as happened in the case of Figure 6.14, we must determine what additional information can be gathered to continue the search for the fault.

Finally, we should note that in the example of Figure 6.14 there was assumed to be a single faulty device. The world is not always this simple, although a single fault assumption is a useful, and often correct, heuristic.

Because they are based on a theoretical understanding of the devices in question, model-based techniques remedy many of the limitations of more heuristic approaches. Rather than reasoning directly from observed phenomena to causal explanations, model-based approaches attempt to represent devices and configurations of devices on a causal or functional level. The program code reflects both the function of devices and the dependencies within a system of devices. Such models are usually more robust than heuristic approaches; however, the down side of this explicit modeling of function is that the knowledge acquisition stage can be quite demanding and the resulting program large, cumbersome, and slow. Because heuristic approaches “compile” typical cases into a single rule, they will always be more efficient, so long as the system has the appropriate rules.

There are deeper problems, however, with this approach. The model of a system is just that, a model. It will of necessity be an abstraction of the system, and at some level of detail, be incorrect. For example, consider the input wires of Figure 6.14. In our discussion we considered these values as given and correct. We did not examine the state of the wire itself, and in particular, the other end where it joined the multipliers. What if the wire was broken, or had a faulty connection to the multiplier? If the user failed to detect this faulty connection, the model would not match the actual device.

Any model attempts to describe the ideal situation, what the system is supposed to do, and not necessarily what the system does do. A “bridging” fault is a contact point in the system where two wires or devices are inadvertently linked, as when a bad solder joint bridges between two wires that should not be in contact. Model-based reasoning can never hypothesize a bridging fault because of the assumptions underlying the model and the search method for determining anomalies. Bridges are simply wires that don’t show up in the design. There is an implicit “closed world assumption” with the model, that the structure description is assumed to be complete and anything not in the model simply doesn’t exist.

But, in spite of these shortcomings, model-based reasoning is an important addition to the knowledge engineer’s tool kit. Researchers continue to expand our understanding of diagnosis, both how human experts do it so efficiently, as well as how better algorithms can be implemented on machines (Stern and Luger 1997).

6.4 Case-based Reasoning

6.4.1 Introduction

Heuristic rules and theoretical models are two types of information human experts use to solve problems. Another powerful strategy experts use is reasoning from cases, examples of past problems and their solutions. *Case-based reasoning* (CBR) uses an explicit database of problem solutions to address new problem-solving situations. These solutions may be collected from human experts through the knowledge engineering process or may reflect the results of previous search-based successes or failures. For example, medical education does not rely solely on theoretical models of anatomy, physiology, and disease; it also depends heavily on case histories and the intern’s experience with other patients and their treatment. CASEY (Koton 1988*a, b*) and PROTOS (Bareiss et al. 1988) are examples of case-based reasoning applied to medicine.

A lawyer will select past law cases that are similar to her client’s and that suggest a favorable decision, and try to convince the court that these similarities merit finding in her client’s favor. Although general laws are made by democratic processes, their interpretation by the courts is usually based on legal precedents. How a law was interpreted in some earlier situation is critical for its current interpretation. Thus, an important component of legal reasoning is identifying from case law precedents for decisions in a particular case. Rissland (1983) and Rissland and Ashley (1987) have designed case-based reasoners to support legal arguments.

Computer programmers often reuse their code, adapting an old program to fit a new situation with similar structure. Architects draw on their knowledge of esthetically pleasing and useful buildings of the past to design new buildings that people find pleasing and comfortable. Historians use stories from the past to help statesmen, bureaucrats, and citizens understand past events and plan for the future. The ability to reason from cases is fundamental to human intelligence.

Other obvious areas for reasoning from cases include design, where aspects of a successfully executed artifact may be appropriate for a new situation, and diagnosis, where the failures of the past often recur. Hardware diagnosis is a good example of this. An expert in this area, besides using extensive theoretical knowledge of electronic and mechanical systems, brings past successful and failed experiences in diagnosis to bear on the current problem. CBR has been an important component of many hardware diagnostic systems, including work on the maintenance of signal sources and batteries in earth orbiting satellites (Skinner and Luger 1992) and the failure analysis of discrete component semiconductors (Stern and Luger 1997).

CBR offers a number of advantages for the construction of expert systems. Knowledge acquisition can be simplified if we record a human expert's solutions to a number of problems and let a case-based reasoner select and reason from the appropriate case. This would save the knowledge engineer the trouble of building general rules from the expert's examples; instead, the reasoner would generalize the rules automatically, through the process of applying them to new situations.

Case-based approaches can also enable an expert system to learn from its experience. After reaching a search based solution to a problem, a system can save that solution, so that next time a similar situation occurs, search would not be necessary. It can also be important to retain in the case base information about the success or failure of previous solution attempts; thus, CBR offers a powerful model of learning. An early example of this is Samuel's (1959, Section 4.3.2) checker-playing program, where board positions that were found through search or experience to be important are retained in the chance that this position might occur again in a later game.

All case-based reasoners share a common structure. On addressing a new problem, the case-based reasoner must:

1. Retrieve appropriate cases from its memory. A case is appropriate if its solution may be successfully applied to the new situation. Since reasoners cannot know this in advance, reasoners typically use the heuristic of choosing cases that are similar to the problem instance. Both humans and artificial reasoners determine similarity on the basis of common features: for example, if two patients share a number of common features in their symptoms and medical histories, there is a good probability that they have the same disease and will respond to the same treatment. Retrieving cases efficiently also requires that the case memory be organized to aid such retrieval. Typically, cases are indexed by their significant features, enabling efficient retrieval of cases that have the most features in common with the current problem. The identification of salient features is highly situation dependent. We will discuss this further.

2. Modify a retrieved case so that it will apply to the current situation. Typically a case recommends a sequence of operations that transform a starting state into a goal state. The reasoner must transform the stored solution into operations suitable for the current problem. Analytic methods, such as curve fitting of parameters common to stored cases and new problems may be useful, as in determining temperatures or materials for automated welding. When analytic relations between cases are not available more heuristic methods may be appropriate, as in help desks for hardware diagnosis.
3. Apply the transformed case to the new problem. Step 2 modifies a stored case for the new situation. This may not guarantee the production of a satisfactory solution in the new situation. This may require further modifications in the solution process.
4. Save the solution, with a record of its success or failure, for future use. Storage of the new case requires updating of the index structure. There are methods that can be used to maintain indices, including clustering algorithms (Fisher 1987) and other techniques from machine learning (Stubblefield and Luger 1996).

The data structures for case-based reasoning can be quite varied. In the simplest situation, cases are recorded as relational tuples where a subset of the arguments record the features to be matched and other arguments point to solution steps. Cases can also be represented as more complex structures, such as proof trees. A fairly common mechanism for storing cases is to represent the cases as a set of large situation-action rules. The facts that describe the situation of the rule are the salient features of the recorded case and the operators that make up the action of the rule are the transformations to be used in the new situation. When this type of rule representation is used algorithms such as RETE (Forgy 1982) can be used to organize and optimize the search for appropriate cases.

The most difficult issue in case-based problem-solving, regardless of the data structure selected for case representation, is the selection of salient features for the indexing and retrieval of cases. Kolodner (1993) and others actively involved in case-based problem-solving set as a cardinal rule that cases be organized by the goals and needs of the problem solver. That is, that a careful analysis be made of case descriptors in the context of how these cases will be used in the solution process.

For example, suppose a weak communication signal problem occurs in a satellite at 10:24:35 GMT. Analysis is made, and it is also determined that the power system is low. The low power can occur because the solar panels are not properly oriented towards the sun. The ground controllers make adjustments in the satellite's orientation, the power improves, and the communication signal is again strong. There are a number of salient features that might be used to record this case, the most obvious that there is a weak communication signal or that the power supply is low. Another feature to describe this case is that the time of the problem was 10:24:35 GMT. The goals and needs of the problem solver in this case suggest that the salient features are weak communication signal and/or low power supply; the time this all happens may well be irrelevant, unless, of course, the fault occurs just after the sun disappears over the horizon (Skinner and Luger 1995).

Another essential problem to be addressed is the representation of such notions as weak signal or low power. Since the precise situation will probably never again be matched, e.g., some exact real number describing signal strength, the reasoner will probably represent the values as a range of real numbers, i.e., good, borderline-good, weak, and danger-alert levels.

Kolodner (1993) offers a set of possible preference heuristics to help organize the storage and retrieval of cases. These include:

1. *Goal-directed preference.* Organize cases, at least in part, by goal descriptions. Retrieve cases that have the same goal as the current situation.
2. *Salient-feature preference.* Prefer cases that match the most important features or those matching the largest number of important features.
3. *Specify preference.* Look for as exact as possible matches of features before considering more general matches.
4. *Frequency preference.* Check first the most frequently matched cases.
5. *Recency preference.* Prefer cases used most recently.
6. *Ease of adaptation preference.* Use first cases most easily adapted to the current situation.

Case-based reasoning has a number of advantages for the design of expert systems. Once knowledge engineers have arrived at the proper case representation, continued knowledge acquisition is straightforward: simply gather and store more cases. Often, case acquisition can be done from historical records or by monitoring current operations, minimizing demands on the human expert's time.

In addition, CBR raises a number of important theoretical questions relating to human learning and reasoning. One of the most subtle and critical issues raised by CBR is the question of defining *similarity*. Although the notion that similarity is a function of the number of features two cases have in common is quite reasonable, it masks a number of profound subtleties. For example, most objects and situations have an infinite number of potential descriptive properties; case-based reasoners typically select cases on the basis of a tiny retrieval vocabulary. Typically, case-based reasoners require that the knowledge engineer define an appropriate vocabulary of highly relevant features. Although there has been work on enabling a reasoner to determine relevant features from its own experience (Stubblefield 1995), determining relevance remains a difficult problem.

Another important problem in case-based reasoning deals with store/compute trade-offs. As a case-based reasoner acquires more cases, it becomes more intelligent, better able to solve a variety of target problems. Indeed, as we add cases to a reasoner, its performance will improve – up to a point. The problem is that as the case-base grows, the time needed to retrieve an appropriate case also grows. Eventually, the cost of finding a case will be greater than the time needed to infer a solution by reasoning from rules or

models. The obvious solution to this problem is to only save the "best" cases, deleting those that are redundant or used infrequently; i.e., the reasoner can "forget" those cases that fail to prove useful. See Samuel's (1959) retention algorithm for saving checker board positions for an important early example of this. In general, however, it is not clear how we can automate such decisions; this remains an active research area (Kolodner 1993).

An automated explanation for why a solution is recommended is also difficult for a case-based reasoner. When asked why a solution was selected to remedy a current situation, the only explanation the system can provide is to say that this particular fix worked at a previous time period. There may also be weak explanations based on similarities of top-level goal descriptions between the current situation and a set of stored cases. In the example of the satellite communication problem, the relevant case was chosen on the basis of a weak communication signal. This mode of reasoning has no deeper explanation than that it worked before in a similar situation. But as noted previously, this may be sufficient explanation for many situations.

Many researchers, however, feel that the simple repetition of top-level goals and the case to be applied offers insufficient explanation (Leake 1992, Stern and Luger 1992), especially when we need an explanation of why some fix doesn't work. Take the satellite situation again. Suppose the solar panel reorientation works but three hours later the signal again becomes weak. Using both the frequency and recency heuristics, we again reorient the solar panel. In three hours the weak signal recurs. And again three hours later; we always apply the same fix. This example is based on an actual satellite situation in which it was found that a more complex problem existed, namely a gyroscope was overheating and giving a distorted reading that disoriented the satellite. The expert system that finally solved the problem used a model-based reasoner to simulate the behavior of the system with respect to its functional description to determine the root causes of the weak communication signal (Skinner and Luger 1995).

Case-based reasoning is related to the problem of learning through analogy. To reuse past experiences we must both recognize the salient features of the past as well as build a mapping of how that experience may be used in the present situation. *Transformational analogy* (Carbonell 1983) is an example of a case-based approach to problem-solving. It solves new problems by modifying existing solutions until they may be applied to the new instance. Operators that modify complete problem solutions define a higher-level space in which states are problem solutions and operators transform these solutions, as in Figure 6.15. The goal is to transform a source solution into a solution to the target problem. Operators modify solutions in ways such as inserting or deleting steps in a solution path, reordering steps in a solution, splicing new solutions into a portion of an old solution, or changing the bindings of parameters in the current solution.

Transformational analogy typifies the approach used by case-based problem-solving. Later work has refined the approach, considering such issues as the representation of cases, strategies for organizing a memory of prior cases, retrieval of relevant prior cases, and the use of cases in solving new problems. For further information on case-based reasoning, see Hammond (1989) and Kolodner (1988a, b).

Reasoning through analogies is discussed further in the context of symbol-based machine learning (see Section 13.5.4).

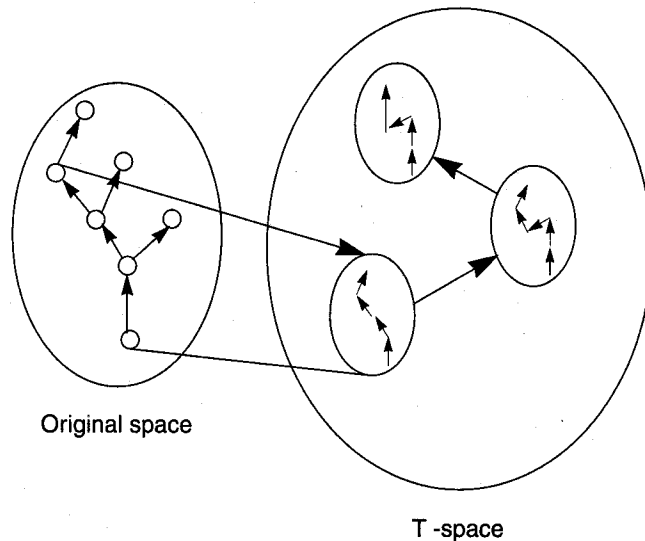

Figure 6.15 Transformational analogy (Carbonell 1983).

6.5 The Knowledge-Representation Problem

Successes in building expert systems that solve hard, practical problems have demonstrated the truth of the central idea behind knowledge-based systems: that the power of a reasoner is in its domain knowledge rather than the sophistication of its reasoning methods. This observation, however, raises one of the central issues in artificial intelligence: that of knowledge representation. At a practical level, every knowledge engineer must make choices about how to represent domain knowledge in a way that will be most appropriate to the given domain. Knowledge representation also raises a number of theoretically important, intellectually difficult issues, such as the handling of missing and uncertain information, the measurement of a representation's expressiveness, the relationship between a representation language and such issues as learning, knowledge acquisition, and the efficiency of a reasoner. Chapters 7 and 8 further explore the subtleties inherent in these problems.

In this chapter, we considered a number of basic approaches to knowledge representation: rule-based expert systems, model-based reasoners and case-based reasoners. As an aid to practical knowledge engineering, we summarize the strengths and weaknesses of each knowledge-intensive approach to problem solving.

Rule-based Reasoning

The advantages of a rule-based approach include:

1. The ability to use, in a very direct fashion, experiential knowledge acquired from human experts. This is particularly important in domains that have not been well formalized, or that rely heavily on heuristics to manage complexity or missing information.
2. The modularity of rules eases construction and maintenance. This supports the iterative development cycle required for expert systems.
3. Good performance is possible in limited domains. Because of the large amounts of knowledge required for intelligent problem-solving, expert systems are limited to narrow domains. However, there are many such domains where design of an appropriate system can prove extremely useful.
4. Good explanation facilities. Although the basic rule-based reasoning framework supports flexible, problem-specific explanations, it must be mentioned that the ultimate quality of these explanations depends upon the structure and content of the rules. Knowledge engineers must pay attention to these issues in designing rules. We have also shown how explanation facilities differ widely between data-driven and goal-driven rule systems.
5. Rules map naturally into state space search.
6. Rule chaining is fairly easy to trace and debug. Good explanation facilities further support debugging.
7. Steps within the problem solution process are open to inspection. This supports both explanations and debugging. It also gives user interface designers a very flexible means of designing interactive user dialogs.
8. The separation of knowledge from control further simplifies development of expert systems by enabling an iterative development process where the engineer acquires, implements and tests individual rules.

Disadvantages of rule-based reasoning:

1. Often the rules obtained from human experts are highly heuristic in nature, and lack a deeper, functional knowledge of the domain.
2. Heuristic rules tend to be "brittle" and cannot handle missing information or unexpected data values.
3. Another aspect of the brittleness of rules is a tendency to degrade rapidly near "edges" of the domain knowledge. Unlike humans, rule-based expert systems are usually unable to fall back on first principles when confronted with novel problems.
4. Explanations function at the descriptive level only, omitting deeper, theoretical explanations. This follows from the fact that heuristic rules gain much of their power by directly associating problem symptoms with solutions, without requiring (or enabling) deeper reasoning.

5. The knowledge tends to be very task dependent. Unlike human intelligence, formalized domain knowledge tends to be very specific in its applicability. Currently, knowledge representation languages cannot approach human flexibility.

Case-based Reasoning

Case-based reasoning is a valuable knowledge representation technique that has a number of advantages:

1. The ability to encode historical knowledge directly. In many domains, cases can be obtained from existing case histories, repair logs, or other sources, eliminating the need for intensive knowledge acquisition with a human expert.
2. Allows shortcuts in reasoning. If an appropriate case can be found, new problems can often be solved in much less time than it would take to generate a solution from rules or models.
3. It allows a system to avoid past errors and exploit past successes. CBR provides a model of learning that is both theoretically interesting and practical enough to apply to complex problems.
4. Extensive analysis of domain knowledge is not required. Unlike a rule-based system, where the knowledge engineer must anticipate rule interactions, CBR allows a simple accretive model of knowledge acquisition. This happens once an appropriate representation for cases, a useful retrieval index, and a case adaptation strategy are designed.
5. Knowledge acquisition and coding are relatively easy.
6. Appropriate indexing strategies add insight and problem-solving power. The ability to distinguish differences in target problems and select an appropriate case is an important source of a case-based reasoner's power; often, indexing algorithms can provide this functionality automatically.

Disadvantages of case-based reasoners:

1. Cases lack deeper knowledge of the domain. This handicaps explanation facilities. In many situations, it allows the possibility that cases may be misapplied, leading to wrong or poor quality advice.
2. A large case base can suffer problems from store/compute trade-offs.
3. It is difficult to get good criteria for indexing and matching of cases. Currently, retrieval vocabularies and similarity matching algorithms must be carefully hand crafted. This can offset many of the advantages CBR offers for knowledge acquisition.

Model-based Reasoning

Model-based reasoning with its explicit functional accounting of situations has advantages:

1. The ability to use functional/structural knowledge of the domain in problem-solving. This increases the reasoner's ability to handle a variety of problems, including those that may not have been anticipated by the system's designers.
2. Unlike rule-based expert systems, model-based reasoners tend to be very robust. For the same reasons that humans often retreat to first principles when confronted with a novel problem, model-based reasoners tend to be robust and flexible problem solvers.
3. Some knowledge is transferable between tasks. Model-based reasoners are often built using scientific, theoretical knowledge. Because science strives for generally applicable theories, this generality often extends to model-based reasoners.
4. Often, model-based reasoners can provide causal explanations. These can convey a deeper understanding of the fault to human users, and can also play an important tutorial role (see also Section 16.2).

Disadvantages of model-based reasoning include:

1. A lack of experiential (descriptive) knowledge of domain. The heuristic methods used by rule-based approaches reflect a valuable class of expertise.
2. It requires an explicit domain model. Many domains, such as the diagnosis of failures in electronic circuits, have a strong scientific basis that supports model-based approaches. However, many domains, such as some medical specialties, most design problems or many financial applications lack a well defined scientific theory. Model-based approaches cannot be used in such cases.
3. High complexity. Model-based reasoning generally operates at a level of detail that leads to significant complexity; this is, after all, one of the main reasons human experts develop heuristics in the first place.
4. Exceptional situations. Unusual circumstances, such as a bridging fault in an electronic circuit, can alter the functionality of a system in ways impossible to predict a priori.

Hybrid Design

An interesting and important area of research and potential application is the hybrid combination of different reasoning models. With a hybrid architecture two or more reasoning paradigms are integrated to get a cooperative effect where the strengths of one

system can compensate for the weakness of another. In combination, we can address some of the disadvantages noted in the previous discussion.

For example, the combination of rule-based and case-based systems can:

1. Offer a natural first check against known cases before undertaking rule-based reasoning and the associated search costs.
2. Provide a record of examples and exceptions to solutions through the case base.
3. Assist in addressing incomplete or inconsistent reasoning situations by resorting to cases that have proven useful in the past.
4. Record search-based results as cases for future use. By saving appropriate cases, a reasoner can avoid duplicating costly search.

The combination of rule-based and model-based systems can:

1. Enhance explanations with functional knowledge. This can be particularly useful in tutorial applications.
2. Improve robustness when rules fail. If there are no heuristic rules that apply to a given problem instance, the reasoner can resort to reasoning from first principles.
3. Add heuristic search to model-based search. This can help manage the complexity of model-based reasoning and allow the reasoner to choose intelligently between possible alternatives.

The combination of model-based and case-based systems can:

1. Give more mature explanations to the situations recorded in cases.
2. Offer a natural first check against stored cases before beginning the more extensive search required by model-based reasoning.
3. Provide a record of examples and exceptions in a case base that can be used to guide model-based inference.
4. Record results of model-based inference for future use.

Because of their promise, hybrid methods deserve the attention of researchers and application developers alike. However, building such systems is not a simple matter, requiring the resolution of such problems as determining which reasoning method to apply in a given situation, deciding when to change reasoning methods, resolving differences between reasoning methods and designing representational strategies that allow knowledge to be shared by different approaches. Research continues on all these dimensions.

6.6 Epilogue and References

The architecture for the rule-based expert system is the production system. Whether the final product is data-driven or goal-driven, the model for the software is production system-generated graph search. This approach was presented in Chapter 5. We implement simple production system-based expert system shells in PROLOG and LISP in Chapters 9 and 10, respectively. These shells, and some sample rules presented with them, are able to create a goal-driven search much like MYCIN's. The rules can include certainty measures in a limited form for design of a heuristic based search.

A number of references complement the material presented in this chapter; especially recommended is a collection of the original MYCIN publications from Stanford entitled *Rule-Based Expert Systems* by Buchanan and Shortliffe (1984). For a robust implementation of data-driven rule-based search we recommend the CLIPS software, distributed by NASA. An excellent reference for CLIPS is Giarratano and Riley (1989).

Other important books on general knowledge engineering include *Building Expert Systems* by Hayes-Roth et al. (1984), *A Guide to Expert Systems* by Waterman (1986), *Expert Systems: Concepts and Examples* by Alty and Coombs (1984), *Expert Systems Technology: A Guide* by Johnson and Keravnou (1985), *Expert Systems: Tools and Applications* by Harmon et al. (1988), and *Expert Systems and Fuzzy Systems* by Negoita (1985). See also *Introduction to Expert Systems* by Ignizio (1991), *An Introduction to Expert Systems* by Mockler and Dologite (1992), and *Expert Systems: Design and Development* by John Durkin (1994).

Because of the domain specificity of expert system solutions, case studies are an important source of knowledge in the area. Books in this category include *Expert Systems: Techniques, Tools and Applications* by Klahr and Waterman (1986), *Competent Expert Systems: A Case Study in Fault Diagnosis* by Keravnou and Johnson (1986), *The CRI Directory of Expert Systems* by Smart and Langeland-Knudsen (1986), *Developments in Expert Systems* by Coombs (1984), and *Development and Management of Expert Systems* by Prerau (1990). We especially recommend *Expert Systems: Design and Development* by Durkin (1994) for its vast number of practical suggestions on building systems.

A number of techniques for knowledge acquisition have been developed. For more information on specific methodologies see *Knowledge Acquisition: Principles and Guidelines* by McGraw and Harbison-Briggs (1989) and *Knowledge Engineering* by Chorafas (1990), as well as *An Introduction to Expert Systems* by Mockler and Dologite (1992) and other books on expert systems.

Case-based reasoning is an offshoot of earlier research by Schank's group at Yale and their work on scripts and mops (see Sections 8.2 and 8.4). *Case-Based Reasoning* by Kolodner (1993) is a comprehensive introduction to the area as well as offering valuable insights into the design and building of these systems. Leake (1992, 1996) offers important comment on explanations in case-based systems. There are now available a number of commercial software products supporting the case-based technology.

Model-based reasoning has its beginning in the explicit representation of log circuits and mathematical domains for the purpose of teaching (Brown and Burton 1978, Brown and VanLehn 1980, Brown et al. 1982). More modern research issues are presented in

Model-based Diagnosis (edited by Hamscher et al. 1992) and *Diagnosis Based on Description of Structure and Function* (Davis et al. 1982). Skinner and Luger (1995) and other writers on agent architectures (Russell & Norvig 1995) describe hybrid expert systems, where the interactions of multiple approaches to problem solving can create a synergistic effect with the strengths of one system compensating for the weaknesses of others.

6.7 Exercises

1. In Section 6.2 we introduced a set of rules for diagnosing automobile problems. Identify possible knowledge engineers, domain experts, and potential end users for such an application. Discuss the expectations, abilities, and needs of each of these groups.
2. Take Exercise 1 above. Create in English or pseudocode 15 if-then rules (other than those prescribed in Section 8.2) to describe relations within this domain. Create a graph to represent the relationships among these 15 rules.
3. Consider the graph of Exercise 2 above. Do you recommend data-driven or goal-driven search? breadth-first or depth-first search? In what ways could heuristics assist the search? Justify your answers to these questions.
4. Pick another area of interest for designing an expert system. Answer Exercises 1–3 for this application.
5. Implement an expert system using a commercial shell program. These are widely available for personal computers as well as larger machines. We especially recommend CLIPS from NASA (Giarratano and Riley 1989).
6. Critique the shell you used to do Exercise 5. What are its strengths and weaknesses? What would you do to improve it? Was it appropriate to your problem? What problems are best suited to that tool?
7. Create a model-based reasoning system for a simple electronic device. Combine several small devices to make a larger system. You can use if... then... rules to characterize the system functionality.
8. Read and comment on the paper *Diagnosis based on description of structure and function* (Davis et al., 1982.)
9. Read one of the early papers using model-based reasoning to teach children arithmetic (Brown & Burton 1978) or electronic skills (Brown & VanLehn 1980). Comment on this approach.
10. Build a case-based reasoner for an application of your choice. One area might be for the selection of computer science courses to complete an undergraduate major or a MS degree.
11. Use commercial software for building the case-based reasoning system of exercise 10. If no software is immediately available, consider building such a system in PROLOG, LISP, or Java.
12. Read and comment on *Improving human decision making through case-based decision aiding* (Kolodner 1991).

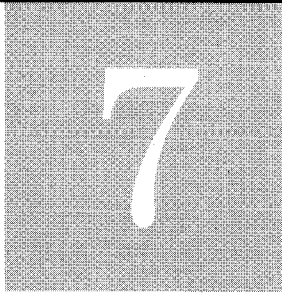

REASONING WITH UNCERTAIN OR INCOMPLETE INFORMATION

All traditional logic habitually assumes that precise symbols are being employed. It is therefore not applicable to this terrestrial life but only to an imagined celestial existence.

—BERTRAND RUSSELL

It is the mark of an instructed mind to rest satisfied with that degree of precision which the nature of the subject admits, and not to seek exactness where only an approximation of the truth is possible.

—ARISTOTLE

So far as the laws of mathematics refer to reality they are not certain. And so far as they are certain they do not refer to reality.

—ALBERT EINSTEIN

7.0 Introduction

Through Parts I and II, and much of Chapter 6, our inference procedures followed the model of reasoning used in the predicate calculus: from correct premises, sound inference rules produce new, guaranteed correct conclusions. As we saw in Chapter 6, however, there are many situations that will not fit this approach; that is, we must draw useful conclusions from poorly formed and uncertain evidence using unsound inference rules.

Drawing useful conclusions from incomplete and imprecise data with unsound reasoning is not an impossible task; we do it very successfully in almost every aspect of our daily life. We deliver correct medical diagnoses and recommend treatment from ambiguous symptoms; we analyze problems with our cars or stereos; we comprehend language

statements that are often ambiguous or incomplete; we recognize friends from their voices or their gestures; and so on.

To demonstrate the problem of reasoning in ambiguous situations, consider Rule 2 from the automobile expert system presented in Chapter 6:

```
if
  the engine does not turn over, and
  the lights do not come on
then
  the problem is battery or cables.
```

On the surface, this rule looks like a normal predicate relation to be used in sound inferencing (*modus ponens*). However, it is not; it is heuristic in nature. It could be possible, though very unlikely, that the battery and cables are fine but that the car simply has a bad starter motor and burned-out headlights. Failure of the engine to turn over and the lights to come on does not necessarily imply that the battery and cables are bad. It is interesting that the *converse* of the rule is true:

```
if
  the problem is battery or cables
then
  the engine does not turn over, and
  the lights do not come on.
```

Barring the supernatural, with a dead battery, neither the lights nor the starter will work!

Our expert system offers an example of *abductive* reasoning. Formally, abduction states that from $P \rightarrow Q$ and Q it is possible to infer P . Abduction is an *unsound* rule of inference, meaning that the conclusion is not necessarily true for every interpretation in which the premises are true (Section 2.2). In knowledge-based systems, we often attach a certainty factor to the rule to measure our confidence in its conclusion. For example, the rule, $P \rightarrow Q$ (.9), expresses the belief "If you believe P to be true, then you believe Q will happen 90% of the time." Thus, heuristic rules can express an explicit policy for belief.

Another constraining problem for expert system reasoning is that useful results must be drawn from data sets with missing, incomplete, or incorrect information. We may also use certainty factors to reflect our belief in the quality of the data, for example, **the lights do come on** (.2) can indicate that the headlights do come on, but are weak and barely visible. Finally, beliefs and imperfect data are propagated through rule sets. This chapter shows how heuristic rules can be combined to extend beliefs.

Although abduction is unsound, it is often essential to solving problems. The "logically correct" version of the battery rule is not very useful in diagnosing car troubles since its premise, the bad battery, is our goal and its conclusions are the observable symptoms with which we must work. The rule must be used in an abductive fashion, as are rules in most diagnostic expert systems. Faults or diseases cause (imply) symptoms, not the other way around; but diagnosis must work from symptoms back to their causes.

In this chapter, we discuss several ways of managing abductive inference and uncertainty, especially as it is required for knowledge-intensive problem solving. In Section 7.1, we consider the Bayesian approach to uncertainty, Bayesian belief networks, and the Dempster–Shafer theory of evidence. We end Section 7.1 with the Stanford certainty factor algebra and causal networks, simple calculi designed to address some of the inadequacies of the Bayesian approach.

In Section 7.2, we return to the formalisms of logic to consider nonmonotonic reasoning, circumscriptive logic, and truth maintenance systems. In Section 7.3, we present fuzzy reasoning, another algebra for handling ambiguity. Finally, in Section 7.4, we consider the MYCIN experiments, a case study of expert reasoning, and also discuss evaluation techniques available for knowledge-based software.

7.1 The Statistical Approach to Uncertainty

Using probability theory, we can determine, often from a priori argument, the chances of events occurring. We can also describe how combinations of events influence each other. Although the final touches on probability theory awaited the mathematicians of the early twentieth century, including Fisher, Neyman, and Pearson, the attempt to create a combinatorial algebra goes back through the middle ages to the Greeks, including Lull, Porphyry, and Plato (Glymour et al. 1995a). The insight supporting probability theory is that we can understand the frequency with which events occur and reason about the frequencies of combinations of events. For example, we may use probability to compute the chances of having a winning ticket in an honest lottery, or the chances in poker of drawing the cards needed for an inside straight.

There are a number of situations when probabilistic analysis is appropriate. First, when the world is genuinely random, as in playing a game with well-shuffled cards, or spinning a fair roulette wheel. In cards, for example, the next card to be dealt is a function of the type of deck (pinochle, poker) and the cards already seen. Another situation for probability theory is to describe the “normal” world. Although events in the world may not be truly random, it is often impossible to know and measure all causes and their interactions well enough to predict events. Statistical correlations are a useful substitute for this causal analysis. A further use of probabilities is to predict possible exceptions to general relationships. The statistical approach groups all exceptions to a relationship together and then uses this measure to describe how often an exception of any type might be expected to occur. Another important role for statistics is as a basis for induction and learning (see, for example, the ID3 algorithm in Section 13.3).

In knowledge-based problem solving we often find ourselves reasoning with limited knowledge and incomplete information. A number of research groups have used forms of probabilistic reasoning to guide their work. In this section, we first present Bayesian correlational analysis, followed by a restricted form of Bayesian inference called belief networks. We then present the Dempster–Shafer theory of evidence, the Stanford certainty factor algebra used in the MYCIN program, and finally, causal networks, an approach to reasoning often used in medical diagnosis.

7.1.1 Bayesian Reasoning

Bayesian reasoning is based in formal probability theory and is used extensively in several current areas of research, including pattern recognition and classification. Assuming a random sampling of events, Bayesian theory supports the calculation of more complex probabilities from previously known results. In simple probability calculations, we are able to conclude, for example, how cards might be distributed to a number of players. Suppose that I am one person of a four-person card game where all the cards are equally distributed. If I do not have the queen of spades, I can conclude that each of the other players has it with probability $1/3$. Similarly, I can conclude that each player has the ace of hearts with probability $1/3$ and that any one player has both cards with probability $1/3 \times 1/3$, or $1/9$.

In the mathematical theory of probability, individual probabilities are either computed analytically, through combinatorial methods, or empirically, by sampling a population. Combinations of probabilities are computed using rules such as:

$$\text{probability}(A \& B) = \text{probability}(A) \times \text{probability}(B)$$

given that A and B are independent.

DEFINITION

PRIOR PROBABILITY

The *prior probability*, often called the *unconditioned probability*, of an event is the probability assigned to an event in the absence of knowledge supporting its occurrence or absence, that is, the probability of the event prior to any evidence. The prior probability of an event is symbolized: $P(\text{event})$.

POSTERIOR PROBABILITY

The *posterior* (after the fact) *probability*, often called the *conditional probability*, of an event is the probability of an event given some evidence. Posterior probability is symbolized $P(\text{event} \mid \text{evidence})$.

The prior probability of getting a two or a three on the roll of a fair die is the sum of these two options divided by the total number of possible options or $2/6$. The prior probability of a person having a disease is the number of people with the disease divided by the number of people in the domain of concern.

The posterior probability of a person having a disease d with symptom s is:

$$P(d|s) = \frac{|d \cap s|}{|s|}$$

where “|”s surrounding a set indicate *the number of elements in that set*. The right side of this equation can be read, “the number of people having both (intersection) the disease d and symptom s divided by the total number of people having the symptom s .”

Bayes (given one disease and one symptom) calculates $P(d | s)$ by:

$$P(d|s) = \frac{P(d) \times P(s|d)}{P(s)}$$

This formula can be proven by using the previous definitions and simplifying:

$$\frac{|d \cap s|}{|s|} = \frac{|d|}{|\text{population}|} \times \frac{\left(\frac{|d \cap s|}{|d|}\right)}{\left(\frac{|s|}{|\text{population}|}\right)}$$

The important thing about Bayes' theorem is that the numbers on the right-hand side of the equation for $P(d | s)$ are easily available, at least when compared to the left-hand side of the equation. For example, because the population is smaller, it is much easier to determine the number of meningitis patients who have headaches than it is to determine the percentage of headache sufferers with meningitis. Even more importantly, for the simple case of a single disease and a single symptom, not very many numbers are needed. Troubles begin, however, when we consider multiple diseases d_m from the domain of diseases D and multiple symptoms s_n from a set S of possible symptoms. When we consider each disease from D and each symptom from S singly, we have $m \times n$ measures to collect and integrate. (Actually $m \times n$ posterior probabilities plus $(m + n)$ prior probabilities.)

Unfortunately, our analysis is about to get much more complex. To this point, we considered symptoms singly. In actual situations, single symptoms are rarely the case. When a doctor is considering a patient, for instance, there are often many combinations of symptoms she must consider. We require a form of Bayes with multiple symptoms.

$$P(d|s_1 \& s_2 \& \dots \& s_n) = \frac{P(d)P(s_1 \& s_2 \& \dots \& s_n|d)}{P(s_1 \& s_2 \& \dots \& s_n)}$$

With one disease and a single symptom we needed only $m \times n$ measurements. Now, for every pair of symptoms s_i and s_j and a disease d , we need to know both $P(s_i \& s_j | d)$ and $P(s_i \& s_j)$. The number of such pairs is $n \times (n - 1)$, or approximately n^2 , when there are n symptoms in S . Now, if we want to use Bayes, there will be about $(m \times n^2 \text{ conditional probabilities}) + (n^2 \text{ symptom probabilities}) + (m \text{ disease probabilities})$ or about $m \times n^2 + n^2 + m$ pieces of information to collect. In a realistic medical system with 200 diseases and 2000 symptoms, this value is over 800,000,000!

There is some hope, however. Many of these symptom pairs will be independent, that is $P(s_i | s_j) = P(s_i)$. Independence means, of course, that the probability of s_i is not affected by the presence of s_j . In medicine, for example, most symptoms are not related, e.g., hair loss and sore elbow. But even if only ten percent of our example symptoms are not independent, there are still about 80,000,000 relationships to consider.

In many diagnostic situations, we must also deal with negative information, e.g., when a patient does not have a symptom, for instance bad blood pressure. We require both:

$$P(\text{not } s) = 1 - P(s) \text{ and } P(\text{not } d|s) = 1 - P(d|s).$$

Finally, it should be noted that $P(s|d)$ and $P(d|s)$ are not the same and, in any situation, may have different values. These different relationships, and the need to avoid circular reasoning using their values, is important to Bayesian belief networks (Section 7.1.2).

We next present one of the most important results of probability theory, the general form of Bayes' theorem. Bayes provides a way of computing the probability of a hypothesis H_i , following from a particular piece of evidence, given only the probabilities with which the evidence follows from actual causes (hypotheses).

$$p(H_i|E) = \frac{P(E|H_i) \times P(H_i)}{\sum_{k=1}^n P(E|H_k) \times P(H_k)}$$

where:

$P(H_i|E)$ is the probability that H_i is true given evidence E .

$P(H_i)$ is the probability that H_i is true overall.

$P(E|H_i)$ is the probability of observing evidence E when H_i is true.

n is the number of possible hypotheses.

As an example, suppose we want to examine the geological evidence at some location to see whether it is suited to finding copper. We must know in advance the probability of finding each of a set of minerals and the probability of certain evidence being present when each particular mineral is found. Then we can use Bayes' theorem to determine the likelihood that copper will be present, using the evidence we collect at the location. This approach is used by PROSPECTOR, built at Stanford University and SRI International and employed in mineral exploration (copper, molybdenum, and others). PROSPECTOR has found commercially significant mineral deposits at several sites (Duda et al. 1979a).

There are two major requirements for the use of Bayes' theorem: first all the probabilities on the relationships of the evidence with the various hypotheses must be known, as well as the probabilistic relationships among the pieces of evidence. Second, and sometimes more difficult to establish, is that all relationships between evidence and hypotheses, or $P(E|H_k)$, must be independent. In general, and especially in areas such as medicine, this assumption of independence cannot be justified.

A final problem, which again makes keeping the statistics of complex Bayesian systems intractable, is the need to rebuild probability tables when new relationships between hypotheses and evidence are discovered. In many active research areas such as medicine, new discoveries happen continuously. Bayesian reasoning requires complete and up-to-date probabilities, including joint probabilities, if its conclusions are to be correct. In many domains, such extensive data collection and verification are not possible.

Where these assumptions are met, Bayesian approaches offer the benefit of a mathematically founded handling of uncertainty. Most expert system domains do not meet these requirements and must rely on heuristic approaches. Furthermore, we know that the human expert does not use full Bayesian techniques for successful problem solving. We

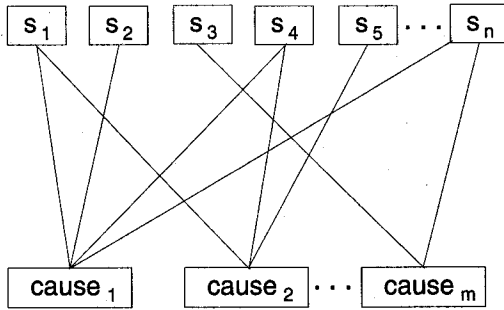

Figure 7.1 A set of symptom/cause relationships for diagnosis.

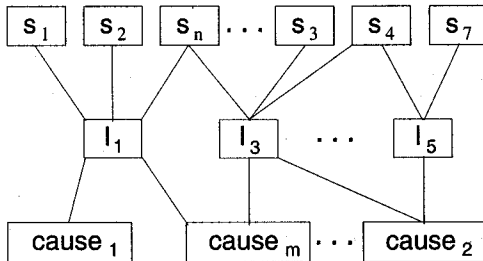

Figure 7.2 A symptom/cause network mediated by intermediate states, *i*. In medicine these states are called pathological.

end this section with a brief example to show how an heuristic Bayesian approach might work to simplify hypothesis/evidence relationships. Figure 7.1 shows how a set of symptoms might be related to a set of causes. This jungle of interwoven relationships may be close to the viewpoint of the non-expert viewing an application domain. The expert in a diagnostic area, however, both through training and practice, learns to group together related symptoms with their possible causes. This discovery of invariances in hypothesis/evidence sets is a hallmark of the expert. In a solution domain, these invariances generally will be given names, as in Figure 7.2, and will play important intermediate points in the search for causes of an observed set of symptoms.

Experts enforce a heuristic decomposition of a diagnostic domain into clusters of symptoms and their relations to causes. These clusters of patterns are often given names, for example, a *coeval volcanic rock* formation, in the search for minerals, or *kidney infection*, in medical diagnosis. Although in theory it is possible to reason without these intermediary states, they provide an effective way of managing the complexity of Bayesian reasoning; furthermore, their use by human experts suggests that our programs might ben-

efit from this approach. These clusters offer a valuable structure for data collection and hypothesis generation. The most important result of these groupings, however, is that they define the dependences within the elements of the hypothesis/symptom set for the use of Bayes' theorem, rule-based inferencing, or other abductive scheme. In the next sections, we describe *belief networks* and *certainty theory*, further heuristic approaches that make the management of uncertainty more tractable.

7.1.2 Bayesian Belief Networks

Although Bayesian probability founds uncertain reasoning on the principles of probability theory, the complexity encountered in applying it to realistic problem domains can be prohibitive. Fortunately, we can often prune this complexity by focusing on a smaller set of more highly relevant events and evidence. *Bayesian belief networks* relax several constraints of the full Bayesian approach. Three insights support their use: The first is that the modularity of a problem domain may allow us to relax many of the dependence/independence constraints required for Bayes. In most reasoning situations, it is not necessary to build a large joint probability table in which the probabilities for all possible combinations of events and evidence are listed. Rather, we select the local phenomena that we know will interact and obtain probability measures that reflect only these clusters of events. We assume all other events are either conditionally independent or their correlations are so small that their interactions may be ignored. We saw one example of this approach in Figures 7.1 and 7.2.

The second assumption is that the links between the nodes of the belief network are represented by conditioned probabilities. Thus for nodes A and B of the network, the link between A and B, denoted $A \rightarrow B(c)$, reflects evidence A's support for the belief in B with some confidence c, sometimes referred to as a *causal influence measure*.

The third assumption implicit in the use of Bayesian belief networks is that coherent patterns of reasoning may be reflected as paths through cause/symptom relationships. The cause/symptom relationships of the problem domain will be reflected in a network. Paths within this network represent the use of different possible arguments.

In Section 7.1.1, we discussed the many relationships between diagnoses and sets of symptoms. We pointed out the dual relationship between the sets of events and the way they influence each other's likelihood. Specifically, causes can influence the likelihood of their symptoms and the presence of a symptom can affect the likelihood of all its possible causes. To create a belief network we must make a clear distinction between these two kinds of potential influence, and then select the path our reasoning will take through the network. No reasoning path can be circular, for example, a likelihood of fever cannot itself support a likelihood of fever.

We use a *directed acyclic graph* (see Section 3.1) to reflect the argument path through the cause/symptom network. The graph is *directed* to indicate how events influence the likelihood of each other. It is *acyclic* so that no reasoning can be circular. The presence or absence of data supporting nodes in the net both shapes and limits the argument path. Thus, the presence or absence of data both constrains and simplifies reasoning.

We will soon (Figure 7.4) present a cause/symptom influence network for automobile

lubrication problems and analyze several argument paths within that network. First, we formalize the intuition of how the evidence for a node in a belief network can affect an argument by defining the *d-separation* of symptom/cause relationships:

DEFINITION

d-SEPARATION

Two nodes (variables) *A* and *B* in a Bayesian belief or qualitative probabilistic network are *d-separated* if for all paths between *A* and *B*, there is an intermediate node (variable) *V* such that either:

- the connection is *serial* or *diverging* and the state of *V* is known, or
- the connection is *converging* and neither *V* nor any of *V*'s children have evidence.

We give examples of serial, diverging, and converging node relations and how they influence argument paths in Figure 7.3.

The causal influence relations of Figure 7.3 reflect the relationships between subgraphs of a Bayesian belief or qualitative probabilistic network. The directions of the arrows linking states indicate how states can (probabalistically) influence each other. Let us consider each influence relationship in more detail. In Figure 7.3(a) there is a possible serial relationship of *A* on *B* and *B* on *C*, with $A \rightarrow B$ (c_1) and $B \rightarrow C$ (c_2), where c_1 and c_2 are the causal influence measures. If there is no evidence supporting *B* then *A* and *C* are

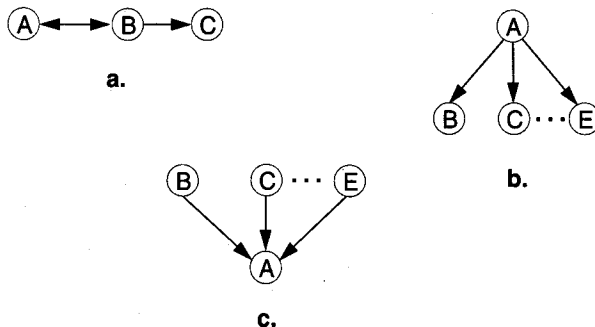

Figure 7.3 Figure 7.3a is the serial connection of nodes where influence runs between *A* and *C* unless *B* is instantiated. Figure 7.3b is the diverging connection, where influence runs between *A*'s children, unless *A* is instantiated. In Figure 7.3c, if nothing is known about *A* then its parents are independent, otherwise relations exist between its parents.

d-separated and independent. If there is evidence of B then C cannot support A, although evidence for B can support A.

In Figure 7.3(b), the diverging connections, B, C, ... E are not independent, because there exists a single event, namely A, that can make them all true. If we know that A does not occur, then B, C, ..., E are d-separated and independent. Finally, in the converging graph of Figure 7.3(c), if A is known to be true then B, C, ... E are not independent; if A is unknown then B, C, ..., E are d-separated and independent. We give examples of these situations in the following influence graph.

Our next example, adapted from Druzdzel (1996), shows how the reasoning paths change in a belief network as different pieces of evidence are discovered. Suppose we have a network of probabilities for the oil-loss problems in an automobile engine. Rather than depict mathematical correlation measures, as would be required for a Bayesian belief network, we will show how the information discovered in a problem domain affects the influence nodes have on each other. The influence relationships for the oil-loss problem are depicted in Figure 7.4, where the links between nodes indicate the primary direction of influence and the + or - indicate whether the influence is positive or negative. For instance, excessive oil consumption has a negative influence on clean exhaust. When only the affect of data on node paths in the graph is represented, that is, there are no quantitative causal influence measures, we have a *Qualitative Probabilistic Network* (Wellman 1990).

The influence variables in the network of Figure 7.4 are binary: worn piston rings can influence excessive oil consumption, which in turn causes not clean exhaust and a low oil level. Low oil can also be influenced by an oil leak, perhaps through a loose bolt or cracked gasket. Oil leak and/or oil spill in filling can cause a greasy engine block. Low oil level is indicated by an oil gauge working only if the car battery power is sufficient to power the oil gauge.

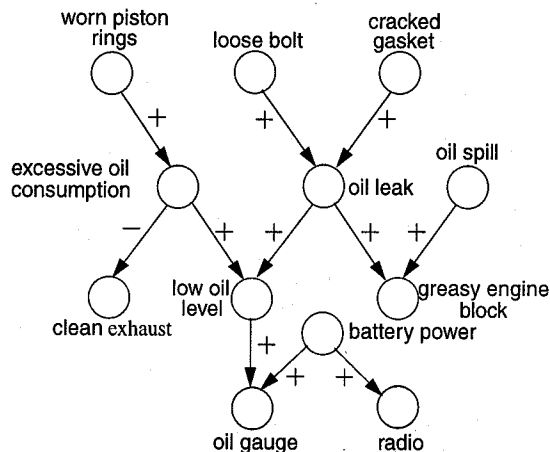

Figure 7.4 An example of a qualitative probabilistic network. Arrows represent the influence relation and + or - indicates whether the influence is positive or negative, from Druzdzel (1996).

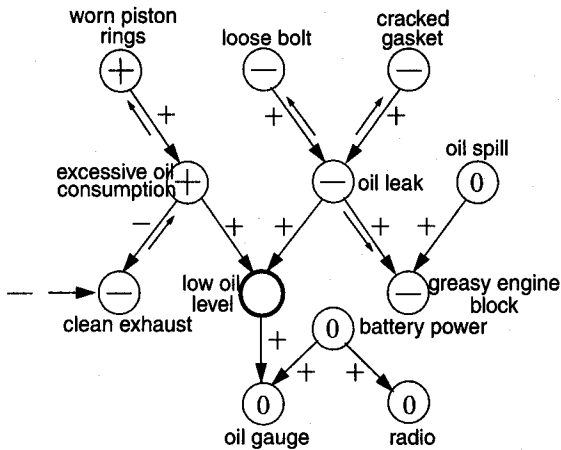

Figure 7.5 Example of qualitative belief propagation. Arrows next to links in network indicate direction of influence. The +, -, or 0 within a node indicates the affect of the new information on that node, adapted from Druzdzel (1996).

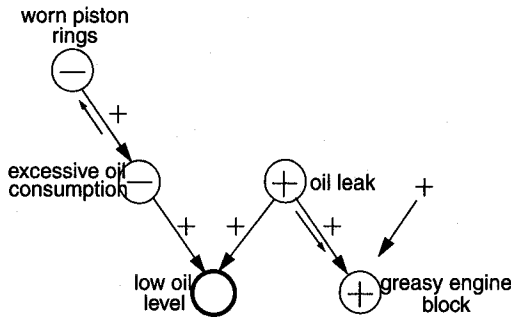

Figure 7.6 Qualitative influence explanation (Druzdzel 1996).

Given the causal influence network of Figure 7.4, Figure 7.5 demonstrates how discovery of new support for a node in the network caused influence patterns to change. The arrows in Figure 7.5 indicate the direction of influence, and the +, -, or 0 within a node indicate whether influence is positive, negative, or neutral. To see how influence changes with data acquisition, note that there is a negative interaction between the nodes for excessive oil consumption and oil leak with respect to low oil level. In the absence of any low oil level data we can assume oil consumption and oil leak are independent. This reflects the *converging* situation of Figure 7.3(c), where the parents of low oil level are d-separated and independent if there is no evidence for low oil level. Once we know that there is a low oil level, however, their independence vanishes. Suppose we obtain evidence for oil leak, perhaps by observing the greasy engine block. This new evidence

causes the likelihood of excessive oil consumption to decrease: the oil leak “explains away” excessive oil consumption. We describe this influence path next.

Figure 7.6 reflects influence propagation across the graph of Figure 7.5: Given a low oil level and observing a greasy engine block, supports an oil leak and diminishes support of excessive oil consumption and worn piston rings. Thus, a greasy engine block in the context of a low oil level is evidence against worn piston rings. It should also be noted with this example that the low oil level is pivotal in the influence graph: with no information on low oil level there is no relationship between the greasy engine block and worn piston rings. Thus, missing pieces of evidence can separate the graph into independent pieces, making search simpler and influence propagation much more tractable.

A further example of the d-separation of converging nodes is that although oil leak and oil spill are independent a priori, once greasy engine block is observed they become dependent. Similarly, using d-separation through serial influence, knowledge of excessive oil consumption relates *not* clean exhaust to low oil level. Finally, in an example of d-separation in a diverging graph, no excessive oil consumption makes clean exhaust and low oil level independent.

Our lubrication example is very small. In an actual application, it is not unusual for probabilistic models to have thousands of components. Each of the nodes will be relevant for some types of reasoning, but only rarely will more than a small percentage of the nodes be part of a single query. It is important, therefore, to identify that subset of the model that includes only those elements of the domain directly needed for particular problems.

As we have just witnessed in the greasy engine block example, an important method for reducing the size of the model is by instantiating evidence. Observed evidence may be sufficient to fix values for other yet unobserved nodes; for instance, no excessive oil consumption implies that the rings are okay. Similarly, observing evidence can imply other nodes that are causally necessary for that evidence; for instance, that the radio works supports belief that the battery power is okay and the oil gauge is giving a correct reading. Each piece of evidence instantiation reduces the number of uncertain variables, possibly de-couples parts of the search graph, and thus reduces the computational complexity of inference. Lack of evidence, for instance no low oil level information, can also screen off other variables, making them independent of the nodes of interest, again leading to graph reduction, search simplification, and lower computation cost.

A final comment: Bayesian belief and influence networks seem to reflect how humans reason in complex domains where some factors are known and related a priori. As reasoning proceeds by progressive instantiation of information, search is further restricted, and as a result, more efficient. This search efficiency stands in stark contrast to the naive notion, supported by a strict application of Bayes, that more information entails an exponentially larger need for statistical relations and a broader search.

There are a number of algorithms available for building belief and influence networks and propagating arguments as new evidence is acquired. We recommend especially Pearl's (1988) message passing approach and the clique triangulation method proposed by Lauritzen and Spiegelhalter (1988). Druzdzel and Henrion (1993) have proposed algorithms for propagating influence in a network. We also recommend the discussion of these algorithms in the *Encyclopedia of AI* (Shapiro 1992). Next, we make different assumptions on the constraints of Bayesian reasoning with the Dempster-Shafer theory of evidence.

7.1.3 The Dempster–Shafer Theory of Evidence

To this point in our discussion of reasoning under uncertainty, we described techniques which consider individual propositions and assign to each a causal influence or a numeric estimate of the degree of belief that we might have, given sets of evidence. One of the limitations of probabilistic approaches to uncertainty is their use of a single quantity to measure what may be a very complex situation. Often, uncertainty results from a combination of missing evidence, the inherent limitations of heuristic rules and the limitations of our own knowledge. An alternative approach, called the *Dempster–Shafer theory of evidence*, considers sets of propositions and assigns to each of them an interval [belief, plausibility] within which the degree of belief for each proposition must lie. This *belief measure*, denoted bl , ranges from zero, indicating no evidence of support for a set of propositions, to one, denoting certainty. The *plausibility* of a proposition p , $pl(p)$, is defined:

$$pl(p) = 1 - bl(\text{not } (p))$$

Thus, plausibility also ranges between zero and one and reflects how evidence of $\text{not } (p)$ relates to the possibility for belief in p . If we have certain evidence of $\text{not } (p)$ then $bl(\text{not}(p))$ will be one and $pl(p)$ will be zero. The only possible value for $bl(p)$ is also zero.

Suppose we have two competing hypotheses h_1 and h_2 . When we have no information supporting either hypothesis, they each have the belief/plausibility range $[0,1]$. As evidence is gathered, we expect these intervals to shrink, representing the increased confidence for the hypotheses. In a Bayesian domain, we would probably begin (with no evidence) by distributing the prior probabilities equally among the two hypotheses, giving each $P(h_i) = 0.5$. Dempster–Shafer makes it clear that we have no evidence when we start; the Bayesian approach, on the other hand, can result in the same probability measure no matter how much data we have. Thus, Dempster–Shafer can be very useful when it is important to make a decision based on the amount of evidence that has been collected.

To summarize, Dempster and Shafer address the problem of measuring certainty by asking for a fundamental distinction between lack of certainty and ignorance. In probability theory we are forced to express the extent of our knowledge about an hypothesis h in a single number, $P(h)$. The problem with this approach, say Dempster and Shafer, is that we simply cannot always know the values of prior probabilities, and therefore, any particular choice of $P(h)$ may not be justified.

The Dempster–Shafer belief functions satisfy axioms that are weaker than those of probability theory, that is, it reduces to probability theory when all probabilities are obtainable. Belief functions allow us to use our knowledge to bound the assignment of probabilities to events in the absence of exact probabilities.

The Dempster–Shafer theory is based on two ideas: first, the idea of obtaining degrees of belief for one question from subjective probabilities for related questions, and second, the use of a rule for combining these degrees of belief when they are based on independent items of evidence. This combination rule was originally proposed by Dempster (1968). Next we present an informal example of Dempster–Shafer reasoning, then present Dempster's rule, and finally, apply that rule to a more realistic situation.

Suppose I have subjective probabilities for the reliability of my friend Melissa. The probability that she is reliable is 0.9, and that she is unreliable, 0.1. Suppose Melissa tells me that my computer was broken into. This statement is true if Melissa is reliable, but it is not necessarily false if she is unreliable. So Melissa's testimony alone justifies a degree of belief of 0.9 that my computer was broken into and a 0.0 belief that it was not. Belief of 0.0 does not mean that I am sure that my computer was not broken into, as a probability of 0.0 would. It merely means that Melissa's testimony gives me no reason to believe that my computer was not broken into. The plausibility measure, pl , in this situation is:

$$pl(\text{computer_broken_into}) = 1 - bl(\text{not}(\text{computer_broken_into})) = 1 - 0.0$$

or 1.0, and my belief function for Melissa is [0.9 1.0]. Note that there is still no evidence that my computer was not broken into.

We next consider Dempster's rule for combining evidence. Suppose my friend Bill also tells me that my computer was broken into. Suppose the probability that Bill is reliable is 0.8 and that he is unreliable is 0.2. I also must suppose that Bill's and Melissa's testimonies about my computer are independent of each other, that is, they have separate reasons for telling me they think my computer was broken into. The event that Bill is reliable must also be independent of Melissa's reliability. The probability that both Bill and Melissa are reliable is the product of their reliabilities, or 0.72; the probability that they both are unreliable is the product 0.02. The probability that at least one of the two is reliable is $1 - 0.02$, or 0.98. Since they both said that my computer was broken into and there is a probability of 0.98 that at least one of them is reliable, I will assign to the event of my computer being broken into a [0.98 1.0] degree of belief.

Suppose that Bill and Melissa disagree on whether my computer was broken into: Melissa says that it was, and Bill says that it was not. In this case, they cannot both be correct and they cannot both be reliable. Either both are unreliable or only one is reliable. The prior probability that only Melissa is reliable is $0.9 \times (1 - 0.8) = 0.18$, that only Bill is reliable is $0.8 \times (1 - 0.9) = 0.08$, and that neither is reliable is $0.2 \times 0.1 = 0.02$. Given that at least one is not reliable, $(0.18 + 0.08 + 0.02) = 0.28$, we can also compute the posterior probabilities that only Melissa is reliable as $0.09/0.28 = 0.321$ and my computer was broken into, or the posterior probability that only Bill was right, $0.08/0.28 = 0.286$, and my computer was not broken into.

We have just used the Dempster rule to combine beliefs. When Melissa and Bill both reported the computer break-in, we summed the three hypothetical situations that supported the break-in: Bill and Melissa are both reliable; Bill is reliable and Melissa not; and Melissa is reliable and Bill not. The belief, 0.98, was the sum of these possible supporting hypothetical scenarios. In the second use of the Dempster rule, the witnesses disagreed. Again we summed all the possible scenarios. The only impossible situation was that they were both reliable; thus Melissa was reliable and Bill not, Bill was reliable and Melissa not, or neither was reliable. The sum of these three gives a belief of break-in of 0.28. The belief that it was not broken into (Bill's opinion) was 0.286, and since the plausibility of break-in is $1 - \text{belief}(\text{not}(\text{break in}))$ or 0.714, the belief measure is [0.28 0.714].

To use the Dempster rule, we obtain degrees of belief for one question (Was my computer broken into?) from probabilities for another question (Are the witnesses

reliable?). The rule begins with the assumption that the questions for which we have probabilities are independent, but that this independence is only a priori. It disappears when we have conflict between the different items of evidence.

Using the Dempster–Shafer approach in a specific situation involves solving two related problems. First, we sort the uncertainties of the situation into a priori independent pieces of evidence. Second, we carry out Dempster’s rule. These two tasks are related: Suppose, again, that Bill and Melissa told me, independently, that they believed my computer was broken into. Suppose also that I had called a repair person to check my computer, and that both Bill and Melissa had witnessed this. Because of this common event, I can no longer compare degrees of belief. However, if I consider explicitly the possibility of the repair person’s working on my computer, then I have three independent items of evidence: Melissa’s reliability, Bill’s reliability, and evidence for the presence of the repair person, which I can then combine with Dempster’s rule. Dempster’s rule states:

$$m_3(Z) = \frac{\sum_{X \cap Y = Z} m_1(X)m_2(Y)}{1 - \sum_{X \cap Y = \emptyset} m_1(X)m_2(Y)}$$

The belief in an hypothesis Z , or $m_3(Z)$, is the sum of the products of the hypothetical situations, $m_1(X)$ and $m_2(Y)$, whose co-occurrence supports Z , that is, $X \cap Y = Z$. The denominator of Dempster’s rule acknowledges that, as we see in the following example, there are times when X and Y have an empty intersection, and the sum of the confidences must be normalized by one minus the sum of these values.

We next apply Dempster’s rule to a situation of medical diagnosis. We let H represent the domain of our focus, containing four hypotheses: that a patient has a cold (C), flu (F), migraine headaches (H), or meningitis (M). Our task is to associate measures of belief with hypothesis sets within H . These are *hypothesis sets* since evidence need not support individual hypotheses exclusively. For example, having a fever could support $\{C,F,M\}$. Since the elements of H are treated as mutually exclusive hypotheses, evidence in favor of some may effect belief in others. In a true Bayesian model, we could handle this by listing all the combinations of conditional probabilities. Our goal is to avoid this complex and often impossible task. The Dempster–Shafer approach addresses interactions by handling the sets of hypotheses directly.

We next define a *probability density function*, m , for all subsets of the set H , where the quantity $m(h_i)$ represents the belief that is currently assigned to each h_i of H and the sum of all the $m(h_i)$ is one. If H contains n elements then there are 2^n subsets of H . Even though addressing 2^n values may appear daunting, it usually turns out that many of the subsets will never occur, and these values can be ignored, since they have no utility in the problem domain. Finally, the plausibility of H is $pl(H) = 1 - \sum m(h_i)$, where the h_i are the sets of hypotheses that have some supporting belief. If we have no information about any hypotheses, as is often the case when we start a diagnosis, then $pl(H) = 1.0$.

Suppose our first piece of evidence is that our patient has a fever, and that this supports $\{C,F,M\}$ at 0.6. We call this first belief m_1 , and if this is our only hypothesis, then $m_1\{C,F,M\} = 0.6$, where $m_1(H) = 0.4$ to account for the remaining distribution of belief. It

is crucial to note that 0.4 represents the remainder of our belief distribution, that is, all other possible beliefs across H and not our belief in the complement of $\{C,F,M\}$.

Suppose that we now acquire some new data for our diagnosis, say the patient has extreme nausea, which suggests $\{C,F,H\}$ with support level 0.7. For this belief, call it m_2 , we have $m_2\{C,F,H\} = 0.7$ and $m_2(H) = 0.3$. We use Dempster's rule to combine these two beliefs, m_1 and m_2 . Let X be the set of subsets of H to which m_1 assigns a nonzero value and Y be the set of subsets of H to which m_2 assigns a nonzero value. We create a combination belief, m_3 defined on subsets Z of H by using Dempster's rule.

In applying Dempster's rule to the diagnoses, first note that there are no sets $X \cap Y$ that are empty, so the denominator of the equation is 1. The belief distribution for m_3 is then as seen in Table 7.1.

m_1	m_2	m_3
$m_1\{C,F,M\} = 0.6$	$m_2\{C,F,H\} = 0.7$	$m_3\{C,F\} = 0.42$
$m_1(Q) = 0.4$	$m_2\{C,F,H\} = 0.7$	$m_3\{C,F,H\} = 0.28$
$m_1\{C,F,M\} = 0.6$	$m_2(Q) = 0.3$	$m_3\{C,F,M\} = 0.18$
$m_1(Q) = 0.4$	$m_2(Q) = 0.3$	$m_3(Q) = 0.12$

Table 7.1 Using Dempster's rule to obtain a belief distribution for m_3 .

Using Dempster's rule, the four sets Z , all possible ways of intersecting X and Y make up the rightmost column of Table 7.1. Their belief level is computed by multiplying the beliefs for the corresponding elements of X and Y under m_1 and m_2 respectively. Note also that, in this example, each set in Z is unique, which is often not the case.

We extend our example one final time to show how empty belief sets are factored into the analysis. Suppose we have a new fact, the results of a lab culture that is associated with meningitis. We now have $m_4\{M\} = 0.8$ and $m_4(H) = 0.2$. We may use Dempster's formula to combine m_3 , the results of our previous analysis, with m_4 to get m_5 , as can be seen in Table 7.2.

m_3	m_4	m_5 (without denominator)
$m_3\{C,F\} = 0.42$	$m_4\{M\} = 0.8$	$m_5\{ \} = 0.336$
$m_3(Q) = 0.12$	$m_4\{M\} = 0.8$	$m_5\{M\} = 0.096$
$m_3\{C,F\} = 0.42$	$m_4(Q) = 0.2$	$m_5\{C,F\} = 0.084$
$m_3(Q) = 0.12$	$m_4(Q) = 0.2$	$m_5(Q) = 0.024$
$m_3\{C,F,H\} = 0.28$	$m_4\{M\} = 0.8$	$m_5\{ \} = 0.224$
$m_3\{C,F,M\} = 0.18$	$m_4\{M\} = 0.8$	$m_5\{M\} = 0.144$
$m_3\{C,F,H\} = 0.28$	$m_4(Q) = 0.2$	$m_5\{C,F,H\} = 0.056$
$m_3\{C,F,M\} = 0.18$	$m_4(Q) = 0.2$	$m_5\{C,F,M\} = 0.036$

Table 7.2 Using Dempster's rule to combine m_3 and m_4 to get m_5 .

First, note that $m_s\{M\}$ is produced by the intersections of two different pairs of sets, so the total $m_s\{M\} = 0.240$. We also have the case where several set intersections produce the empty set, $\{\}$. Thus the denominator for Dempster's equation is $1 - (0.336 + 0.224) = 1 - 0.56 = 0.44$. The final combined belief function for m_s is:

$$\begin{array}{lll} m_s\{M\} = 0.545 & m_s\{C,F\} = 0.191 & m_s\{\} = 0.56 \\ m_s\{C,F,H\} = 0.127 & m_s\{C,F,M\} = 0.082 & m_s\{Q\} = 0.055 \end{array}$$

Three final comments. First, a large belief assigned to the empty set, as in this final $m_s\{\} = 0.56$, indicates that there is conflicting evidence within the belief sets m_j . In fact, we designed our example to show several features of Dempster-Shafer reasoning, and, as a consequence, sacrificed medical integrity. Second, when there are large hypothesis sets as well as complex sets of evidence, the calculations for belief sets can get cumbersome, even though, as pointed out earlier, the amount of computation is still considerably less than that for Bayesian reasoning. Finally, the Dempster Shafer approach is a very useful tool when the stronger Bayesian conclusions may not be justified.

Dempster-Shafer is an example of an algebra supporting the use of *subjective probabilities* in reasoning, as contrasted with the *objective probabilities* of Bayes. In subjective probability theory, we build a reasoning algebra, often by relaxing some of the constraints of Bayes. It is often felt that subjective probabilities better reflect human expert reasoning. In the next section we consider another use of subjective probabilities, the certainty factor algebra created at Stanford for use in the MYCIN expert system. The origins of this algebra grew out of the frustration of attempting to use traditional objective probabilities for medical diagnosis.

7.1.4 The Stanford Certainty Factor Algebra

Several early expert system projects (besides PROSPECTOR) attempted to adapt Bayesian techniques to their problem-solving needs. The independence assumptions, continuous updates of statistical data, and the calculations required to support statistical inference gradually stimulated the search for other measures of "confidence." The most important alternative approach was used at Stanford in developing the MYCIN program (Buchanan and Shortliffe 1984). Unlike Bayesian approaches, which attempt to measure the probability with which evidence supports a conclusion, certainty theory attempts to measure the confidence merited by a given heuristic. When reasoning with heuristic knowledge, human experts are able to give adequate, useful estimates of the confidence we are justified in having in their conclusions. They weight them with terms like "highly probable," "unlikely," "almost certainly," or "possible." These weights are clearly not based in careful analysis of probabilities. Instead, they are themselves heuristics derived from experience in reasoning about the problem domain. Certainty theory is an effort to formalize this heuristic approach to reasoning with uncertainty.

Stanford certainty theory is based on a number of observations. The first is that in traditional probability theory, the sum of confidence for a relationship and confidence against the same relationship must add to one. However, it is often the case that an expert might

have confidence 0.7 (say) that some relationship is true and have no feeling of it being not true. We saw in Section 7.1.3 how Dempster–Shafer handled with this one-sum constraint.

Another assumption that underpins certainty theory is that the knowledge content of the rules is much more important than the algebra of confidences that holds the system together. Confidence measures correspond to the informal evaluations that human experts attach to their conclusions, such as “it is probably true,” “it is almost certainly true” or “it is highly unlikely.”

The Stanford certainty theory makes some simple assumptions for creating confidence measures and has some equally simple rules for combining these confidences as the program moves toward its conclusion. The first assumption is to split “confidence for” from “confidence against” a relationship:

Call $MB(H|E)$ the measure of belief of a hypothesis H given evidence E .

Call $MD(H|E)$ the measure of disbelief of a hypothesis H given evidence E .

Now either:

$1 > MB(H|E) > 0$ while $MD(H|E) = 0$, or

$1 > MD(H|E) > 0$ while $MB(H|E) = 0$.

These two measures constrain each other in that a given piece of evidence is either for or against a particular hypothesis, an important difference between certainty theory and probability theory. Once the link between measures of belief and disbelief has been established, they may be tied together again, by:

$$CF(H|E) = MB(H|E) - MD(H|E).$$

As the certainty factor (CF) approaches 1, the evidence is stronger for a hypothesis; as CF approaches -1, the confidence against the hypothesis gets stronger; and a CF around 0 indicates that either little evidence exists for or against the hypothesis or that the evidence for and against the hypothesis is balanced.

When experts put together a rule base, they must agree on a CF to go with each rule. This CF reflects their confidence in the rule’s reliability. Certainty measures may be adjusted to tune the system’s performance, although slight variations in the confidence measure tend to have little effect on the overall running of the system. This second role of certainty measures confirms the belief that “the knowledge gives the power,” that is, the integrity of the knowledge itself best supports the production of correct diagnoses.

The premises for each rule are formed of ands and ors of a number of facts. When a production rule is used, the certainty factors associated with each condition of the premise are combined to produce a certainty measure for the overall premise as follows:

For $P1$ and $P2$, premises of the rule,

$$CF(P1 \text{ and } P2) = \text{MIN}(CF(P1), CF(P2)), \text{ and}$$

$$CF(P1 \text{ or } P2) = \text{MAX}(CF(P1), CF(P2)).$$

The combined CF of the premises, using the above rules, is then multiplied by the CF of the rule itself to get the CF for the conclusions of the rule.

For example, consider the rule in a knowledge base:

$$(P1 \text{ and } P2) \text{ or } P3 \rightarrow R1 (.7) \text{ and } R2 (.3)$$

where P1, P2, and P3 are premises and R1 and R2 are the conclusions of the rule, having CFs 0.7 and 0.3, respectively. These numbers are added to the rule when it is designed and represent the expert's confidence in the conclusion if all the premises are known with complete certainty. If the running program has produced P1, P2, and P3 with CFs of 0.6, 0.4, and 0.2, respectively, then R1 and R2 may be added to the collected case-specific results with CFs 0.28 and 0.12, respectively. Here are the calculations for this example:

$$CF(P1(0.6) \text{ and } P2(0.4)) = \text{MIN}(0.6, 0.4) = 0.4.$$

$$CF((0.4) \text{ or } P3(0.2)) = \text{MAX}(0.4, 0.2) = 0.4.$$

The CF for R1 is 0.7 in the rule, so R1 is added to the set of case specific knowledge with the associated CF of $(0.7) \times (0.4) = 0.28$.

The CF for R2 is 0.3 in the rule, so R2 is added to the set of case specific knowledge with the associated CF of $0.3 \times (0.4) = 0.12$.

One further measure is required: how to combine multiple CFs when two or more rules support the same result R. This rule reflects the certainty theory analog of the probability theory procedure of multiplying probability measures to combine independent evidence. By using this rule repeatedly one can combine the results of any number of rules that are used for determining a result R. Suppose CF(R1) is the present certainty factor associated with result R and a previously unused rule produces result R (again) with CF(R2); then the new CF of R is calculated by:

$$CF(R1) + CF(R2) - (CF(R1) \times CF(R2)) \text{ when } CF(R1) \text{ and } CF(R2) \text{ are positive,}$$

$$CF(R1) + CF(R2) + (CF(R1) \times CF(R2)) \text{ when } CF(R1) \text{ and } CF(R2) \text{ are negative,}$$

and

$$\frac{CF(R1) + CF(R2)}{1 - \text{MIN}(|CF(R1)|, |CF(R2)|)} \text{ otherwise,}$$

where $|X|$ is the absolute value of X.

Besides being easy to compute, these combination equations have other desirable properties. First, the CFs that result from applying this rule are always between 1 and -1. Second, the result of combining contradictory CFs is that they cancel each other, as is desired. Finally, the combined CF measure is a monotonically increasing (decreasing) function in the manner one would expect for combining evidence.

Finally, the confidence measures of the Stanford certainty factor tradition are a human (subjective) estimate of symptom/cause probability measures. As noted in Section 7.1.2, in

the Bayesian tradition if A, B, and C all influence D, we need to isolate and appropriately combine all the prior and posterior probabilities, including $P(D)$, $P(D|A)$, $P(D|B)$, $P(D|C)$, $P(A|D)$, when we want to reason about D. The Stanford Certainty Factor tradition allows the knowledge engineer to wrap all these relationships together into one confidence factor, CF, attached to the rule; that is, if A and B and C then D (CF). It is felt that this simple algebra better reflects how human experts combine and propagate beliefs.

Certainty theory may be criticized as being excessively *ad hoc*. Although it is defined in a formal algebra, the meaning of the certainty measures is not as rigorously founded as is formal probability theory. However, certainty theory does not attempt to produce an algebra for "correct" reasoning. Rather it is the "lubrication" that lets the expert system combine confidences as it moves along through the problem at hand. Its measures are *ad hoc* in the same sense that a human expert's confidence in his or her results is approximate, heuristic, and informal. When MYCIN is run, the CFs are used in the heuristic search to give a priority for goals to be attempted and a cutoff point when a goal need not be considered further. But even though the CF is used to keep the program running and collecting information, the power of the program remains invested in the quality of the rules.

7.1.5 Causal Networks

Causal models usually depict relationships as links between nodes in a graph or a network of nodes. These models are used quite extensively in a number of areas of reasoning, including diagnosis in medicine, the analysis of faults in electronic circuits, and to understand the discourse of simple stories. The approach in these applications is straightforward: map observations onto a network of nodes and then link the network nodes in a causally coherent pattern. There is little or no attempt to propagate probabilities of events across the network.

One of the first efforts to build an explicit model of causal relationships was for the diagnosis of various forms of the eye disease glaucoma. This program, CASNET (Weiss et al. 1977), was a kind of semantic network (Section 8.2.3) that represented a dynamic process occurring over time as a causal relationship among states. This network also related the nodes of the causal process to external manifestations; the observations, the evidence, and in this case medical classifications, that is, to diagnostic categories. More precisely, this representation has three connected levels: first, a level of pathophysiological states, second, a level of observations, and finally, a level of disease categories.

At the core of the model is the network of pathophysiological states connected by causal links. "Causal links" is interpreted loosely and not intended for exact Bayesian correlational analysis. The links connecting states are "weighted" with numerical confidence measures from 1, rarely causes, to 5, almost always causes, the pathophysiological states.

A complete causal pathway from a start node to a terminal node represents a complete disease process, while pathways that end in non-terminal nodes represent partial or incomplete evolution of a disease process. Confirmation of a state is derived either from

associated observations, where the links between observations and pathophysiological states also have weights, or indirectly through the causal link to another state for which there is some evidence. Activation of the network proceeds by a weight-propagation algorithm (Weiss et al. 1977). The network state then drives an investigation based on the selection of tests suggested by the linked states. The final diagnosis is reflected by the classification of the paths found through the causal network.

The CASNET model handles causality somewhat superficially, representing causal processes as linear associations between states. Furthermore, the topological structure of the network is built by the system designer before the analysis begins, and modeling the physiological process involves little more than weight propagation and node activation through this pre-assembled net. A more sophisticated use of causal representations for diagnosis appeared shortly after CASNET. ABEL (Patil et al. 1981) reasons about Acid Base and ELectrolyte imbalances in patients. ABEL's architecture is based on the observation that clinicians consider a case at several levels of detail that are eventually integrated into a higher level categorical understanding of the disease process, affording a detailed interpretation of the data collected.

Given patient data, ABEL develops a patient-specific model consisting of an interpretation of the data in an hierarchical casual network. ABEL uses initial patient data to generate a patient specific model. It then uses the same procedures to suggest clinical measurements and patient specific model revision. Unlike CASNET, where the causal network is constructed when the program was designed, ABEL dynamically instantiates its general medical knowledge in response to the data. ABEL's network has three levels, reflecting the different levels of detail at which human diagnosticians typically reason. These levels, as can be seen in Figure 7.7, are the clinical, the pathophysiological, and an intermediate transfer level.

Construction of the causal network is accomplished through five operators: *aggregation*, *elaboration*, *decomposition*, *summation*, and *projection*. *Aggregation* summarizes the description of the causal network at a given level into the next higher aggregate level. There are two types of aggregation, *focal aggregation*, which summarizes a node and its immediate causally connected neighborhood by a single node, and *causal aggregation*, which summarizes a chain of cause-effect relations by a single cause and effect relation. *Elaboration* is the inverse of aggregation, serving to expand the causal relationships represented at a given level into a more detailed set of relations at a lower level. There are two types of elaboration, the *focal* and the *causal*, the duals of the aggregation operators just mentioned.

The *decomposition* and *summation* operators relate components at the same level of detail, constraining a causally connected region of the network and enforcing the consistency of the summation of quantities distributed over causal links. *Projection*, perhaps the most interesting operator, is similar to *elaboration* in that it serves to expand a region of the network. It is essentially an abductive operator in that it is used to extrapolate the hypothetical causal relationships needed to account for otherwise unexplainable states or quantities in the network. *Projection* can serve to generate expectations and motivates the collection of diagnostic data.

A causal link in ABEL is a mapping relation that takes attributes of cause-instance pairs into attributes of an effect-instance. Causal links themselves have contextual

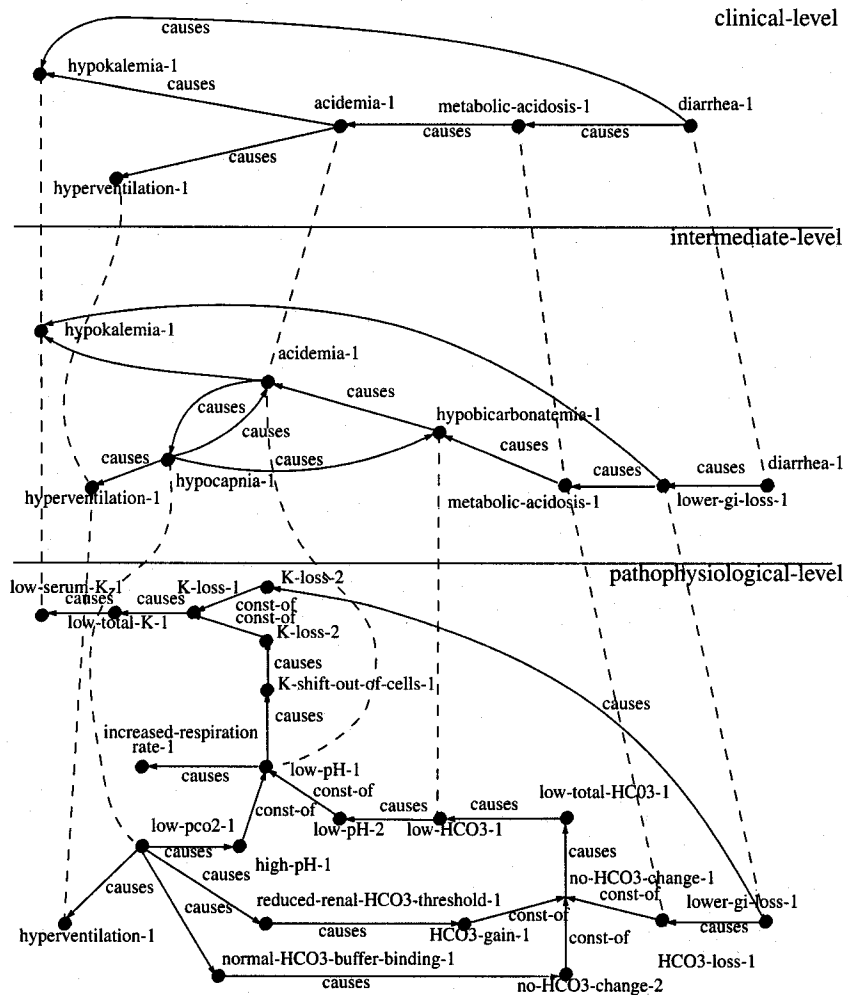

Figure 7.7 An example of a PSM in ABEL, from Clancy and Shortliffe (1984b, p. 388).

attributes which, when they differ from default information, can induce functional changes in the mapping relation. This mapping relation supports the numerical summation and decomposition operators, which allow the system to reason about quantitative information such as electrolyte levels and pH. ABEL represented the state-of-the-art in clinical reasoning for its time and still remains unsurpassed in its hierarchical integration of causal reasoning across multiple levels of detail.

Another approach to causal reasoning in well-understood contexts, *scripts*, will be described in Section 8.4.2. In scripts there are no certainty factors, simply a set of data structures that are intended to represent reasoning within well-understood situations, such as going to a restaurant or attending a child's birthday party.

7.2 Introduction to Nonmonotonic Systems

All of the methods examined in Section 7.1 can be criticized for using quantitative approximations of uncertainty. Many applications seem to require a more qualitative approach to the problem. For example, numeric measures do not provide adequate explanations of the causes of uncertainty. If we ask human experts why their conclusions are uncertain, they can usually answer in terms of the qualitative relationships between features of the problem instance. In the models of uncertainty of Section 7.1, qualitative information is “hidden” by numeric measures. Furthermore, numeric approaches do not address the problem of changing data. What should the system do if a piece of uncertain information is later determined to be true or false? A possible alternative to numeric measures is the use of predicate calculus. With logic, pieces of knowledge are explicitly used in reasoning, and, as we saw in Chapter 6, are part of the explanations of conclusions. But traditional logic also has its limitations, especially in areas where information is missing or uncertain, and as we saw in Section 7.1, in situations where sound inference procedures are not always usable.

In Section 7.2, we consider extensions to logic that let it describe a world of changing information and beliefs. Traditional mathematical logic is *monotonic*: It begins with a set of axioms, assumed to be true, and infers their consequences. If we add new information to this system, it may cause the set of true statements to increase. Adding knowledge will never make the set of true statements decrease. This monotonic property leads to problems when we attempt to model reasoning based on beliefs and assumptions. In reasoning with uncertainty, humans draw conclusions based on their current set of beliefs; however, unlike mathematical axioms, these beliefs, along with their consequences, may change as more information becomes available.

Nonmonotonic reasoning addresses the problem of changing beliefs. A nonmonotonic reasoning system handles uncertainty by making the most reasonable assumptions in light of uncertain information. It then proceeds with its reasoning as if these assumptions were true. At a later time, a belief may change, necessitating a reexamination of any conclusions derived from that belief.

7.2.1 Logics for Nonmonotonic Reasoning

Nonmonotonicity is an important feature of human problem solving and commonsense reasoning. In most planning, for example when we drive to work, we make numerous assumptions about the roads and traffic. If we find that one of these assumptions is violated, perhaps by construction or an accident on our usual route, we change our plans and find an alternative route.

Conventional reasoning using predicate logic is based on three important assumptions. First, the predicate descriptions must be sufficient with respect to our application domain. That is, all the information necessary to solve the problem must be represented. Second, the information base must be consistent; that is, pieces of knowledge cannot contradict each other. Finally, through the use of inference rules, the known

information grows monotonically. If any of these three assumptions is not satisfied, the conventional logic-based approach will not work.

Nonmonotonic systems address each of these three issues. First, reasoning systems are often faced with a lack of knowledge about a domain. There is an important issue here: suppose we have no knowledge about the predicate p ; does lack of knowledge mean that *we are not sure whether p is true* or *we are sure that not p is true*. This question can be answered in a number of ways. PROLOG, see Chapter 9, uses *the closed world assumption* to determine as false anything that its reasoning system cannot prove to be true. As humans, we often take the alternative approach of assuming something to be true unless it can be explicitly shown to be false.

Another approach to the lack of knowledge problem is to make explicit assumptions of truth. In human reasoning, we assume the innocence of people not directly connected to a crime. We would probably even go further and assume the innocence of those that could not benefit from the crime. The result of these limiting assumptions is to effectively fill in missing details of our knowledge and extend our reasoning to reach new conclusions based on these assumptions. We discuss the closed world assumption and its alternatives in Section 7.2.2.

We humans also reason based on *how the world usually works*: Most birds fly. Parents usually love and support their children. We often make inferences based on the consistency of reasoning with our assumptions about the world. In this section we discuss the addition of modal operators, such as *is consistent with* and *unless*, to perform assumption based reasoning.

The second assumption required of traditional logic-based systems is that the knowledge supporting reasoning must be consistent. For human reasoners this would be a very limiting assumption. In diagnosing a problem we often entertain multiple possible explanations for a situation, assuming something is true until an alternative assumption proves to be more fruitful. In analysis of an airline accident, for example, a crash expert will consider a number of alternative causes, only eliminating some as new information is discovered. We humans use knowledge of the world *as it usually is* to try to direct reasoning through possible alternative scenarios. This topic is also addressed in the present section.

Finally, if we wish to use logic we must address the problem of how a knowledge base is updated. There are two issues here: first, how can we possibly add knowledge that is based on assumption only, and secondly, what can we do when one of our assumptions is later shown to be incorrect. To address the first issue, we can allow the addition of new knowledge based on assumptions. This new knowledge is assumed to be correct and so it may, in turn, be used to infer more new knowledge. The cost of this practice is that we must keep track of all reasoning and proofs that are based on assumptions: We must be prepared to reconsider any knowledge based on these assumptions.

Nonmonotonic reasoning, because conclusions must sometimes be reconsidered, is called *defeasible*; that is, new information may sometimes invalidate previous results. Representations and search procedures that keep track of the reasoning steps of a logic system are called *truth maintenance systems* or TMS. In defeasible reasoning, the TMS preserves the consistency of the knowledge base, keeping track of conclusions that might later need to be questioned. We consider several approaches to truth maintenance in

Section 7.2.3. We now consider operators that can make traditional logic-based reasoning systems defeasible.

In implementing nonmonotonic reasoning, we may extend our logic with the operator **unless**. **unless** supports inferences based on the belief that its argument is not true. Suppose we have the following set of predicate logic sentences:

$$\begin{aligned} p(X) \text{ unless } q(X) &\Rightarrow r(X) \\ p(Z) & \\ r(W) &\Rightarrow s(W) \end{aligned}$$

The first rule means that we may infer $r(X)$ if $p(X)$ is true and we do not believe $q(X)$ to be true. When these conditions are met, we infer $r(X)$ and, using $r(X)$, can then infer $s(X)$. Subsequently, if we change our belief, or find that $q(X)$ is true, $r(X)$ and also $s(X)$ must be retracted. Note that **unless** deals with matters of belief rather than truth. Consequently, changing the value of its argument from “either unknown or believed false” to “believed or known to be true” can cause us to retract all inferences that depend upon these beliefs. By extending our logic to reason with beliefs that may later be retracted, we introduce non-monotonicity into the reasoner.

The reasoning scheme just described can also be used to encode default rules (Reiter 1980). If we replace $p(X) \text{ unless } q(X) \Rightarrow r(X)$ with $p(X) \text{ unless ab } p(X) \Rightarrow r(X)$, where **ab** $p(X)$ represents abnormal $p(X)$, we state that unless we have an abnormal instance of p , such as a bird with a broken wing, we can make the inference that if X is a bird then X can fly. Other representations for exception handling are presented in Chapter 8.

A second modal operator for extending logic systems is suggested by McDermott and Doyle (1980). They augment first-order predicate logic with the modal operator **M**, which placed before a predicate is read as *is consistent with*. For example:

$$\forall X \text{ good_student}(X) \wedge M \text{ study_hard}(X) \Rightarrow \text{graduates}(X)$$

This clause can be read: For all X where X is a good student, and if the fact that X studies hard is consistent with everything else we know, then X will graduate. Of course, the difficult part here is defining precisely what *is consistent with everything else we know* might mean.

We first note that *is consistent with everything else we know* may not be decidable. The reason is that a modal operator forms a superset of an already undecidable system, see Section 2.2.2, and will thus be undecidable. There are two ways to address undecidability. First, we can use a *negation as failure* proof to demonstrate *is consistent with*. In our example, we would attempt the proof of $\text{not}(\text{study_hard}(X))$ and if we couldn't prove that X doesn't study, then we assume that X does study. We often use this approach in a PROLOG-like approximation of predicate logic. Unfortunately, negation as failure may unduly restrict our domain of interpretation.

A second approach to the *is consistent with* problem is to make a heuristic-based and limited (time or memory limited) search for the truth of the predicate, in our example $\text{study_hard}(X)$, and then assume it is true with the understanding that we may have to later retract the **graduates** conclusion and all further conclusions based on it.

We can also produce potentially contradictory results using the *is consistent with* operator. Suppose a person, Peter, is a good student but also seriously enjoys parties. We might then have the following set of predicates that describe the situation:

$$\begin{aligned} &\forall X \text{ good_student}(X) \wedge M \text{ study_hard}(X) \Rightarrow \text{graduates}(X) \\ &\forall Y \text{ party_person}(Y) \wedge M \text{ not}(\text{study_hard}(Y)) \Rightarrow \text{not}(\text{graduates}(Y)) \\ &\text{good_student}(\text{peter}) \\ &\text{party_person}(\text{peter}) \end{aligned}$$

With this set of clauses, where we have no further information about Peter's study habits, whether he studies hard or not, we can infer both that Peter will graduate and also that he will not graduate.

One reasoning method that guards against such contradictory results is to keep track of the variable bindings used with the modal operator *is consistent with*. Thus, once Peter was bound to either the *study_hard* or the *not(study_hard)* predicate, the system would prevent the binding of Peter to the other predicate. Other nonmonotonic logic systems (McDermott and Doyle 1980) are even more conservative and prevent any conclusions from such potentially contradictory clause sets. We can create another anomaly:

$$\begin{aligned} &\forall Y \text{ very_smart}(Y) \wedge M \text{ not}(\text{study_hard}(Y)) \Rightarrow \text{not}(\text{study_hard}(Y)) \\ &\forall X \text{ not}(\text{very_smart}(X)) \wedge M \text{ not}(\text{study_hard}(X)) \Rightarrow \text{not}(\text{study_hard}(X)) \end{aligned}$$

From these clauses we can infer a new clause:

$$\forall Z M \text{ not}(\text{study_hard}(Z)) \Rightarrow \text{not}(\text{study_hard}(Z))$$

Further developments of the semantics of the *is consistent with* operator address such anomalous reasoning. One further extension is *autoepistemic logic* (Moore 1985).

Another nonmonotonic logic system is *default logic*, created by Reiter (1980). Default logic employs a new set of inference rules of the form:

$$A(Z) \wedge : B(Z) \Rightarrow C(Z)$$

which is read: If $A(Z)$ is provable *and it is consistent with what we know to assume* $B(Z)$ then conclude $C(Z)$.

To this point default logic sounds exactly like McDermott and Doyle's nonmonotonic logic just described. An important difference between the two is the method in which reasoning is performed. In default logic, these special inference rules are used to infer sets of plausible extensions of the original axiom/theorem set. Each extension, a "possible world," is created by using one, and only one, of the default logic inferencing rules on the knowledge represented by the original axiom/theorem set. Thus, it would be quite natural to have a number of plausible extensions to an original knowledge base. This can be seen with the *graduates* clauses:

$$\begin{aligned} &\forall X \text{ good_student}(X) \wedge : \text{study_hard}(X) \Rightarrow \text{graduates}(X) \\ &\forall Y \text{ party}(Y) \wedge : \text{not}(\text{study_hard}(Y)) \Rightarrow \text{not}(\text{graduates}(Y)) \end{aligned}$$

Each clause would be used to create a unique plausible extension, or possible world, based on the original set of knowledge

Default logic then allows any theorem inferred in a plausible extension to be admitted as an axiom for further reasoning. There must be some other decision-making guide when we must finally determine which extension is to be used for the problem solving. Default logic says nothing about how to choose among possible plausible extensions of a knowledge-base. Research by Reiter and Criscuolo (1981) and Touretzky (1986) continue to develop these issues.

Finally, there is a nonmonotonic reasoning situation created by inheritance search over representations where objects can inherit from more than one parent. Peter, the party-loving good student mentioned earlier, could inherit one set of properties from being a good student, i.e., that he would graduate. Peter could inherit other, and in this case partially conflicting, properties from being a party person, i.e., that he would not graduate. We present multiple inheritance systems in detail in Section 8.5.

7.2.2 Logics Based on Minimum Models

In the previous section, we extended logic by several different modal operators that were specifically designed to reason about the world *as it usually is*, relaxing the requirement that our knowledge of the world be somehow complete. These operators were born of the necessity of creating a more flexible and revisable view of the world. In this section we present logics designed specifically for two situations: first, to reason where a set of assertions specifies only those things that are true, and second, to reason where, because of the nature of a problem solving task, sets of conjectures are usually true. In the first situation we use the *closed world assumption* and in the second *circumscription*. Both of these approaches to logic are often referred to as *reasoning over minimal models*.

We saw in Section 2.3 that a *model* is an interpretation that satisfies S , a set of predicate expressions, for all variable assignments. There are a number of ways of defining what is meant by a *minimum model*. We define a minimum model as *a model such that there are no smaller models that can satisfy the set of expressions S for all variable assignments*.

The idea that makes minimum models important for describing reasoning is this: There are a (potentially) infinite number of predicates that can be used to describe situations in the world. We will consider, for example, the limitless predicates that can be used to describe the situation for the missionaries and cannibals problem (Section 9.10, Exercise 7): the boat is not slowly sinking, the river banks are close enough that rowing will get the boat across, the wind is not a relevant factor, etc. When we describe a problem we are usually quite parsimonious in our descriptions. We create only those predicates that are both relevant and needed to solve the problem.

The *closed world assumption* is based on this minimum model of the world. Exactly those predicates that are necessary for a solution are created. The closed world assumption effects the semantics of negation in reasoning. For example, if we wanted to determine whether a student is an enrolled member of a class, we could go to the enrollment database, and if the student is not explicitly listed in that database (the minimal model), he or

she would not be enrolled. Similarly, if we wanted to know if two cities were directly connected by a plane flight, we would go to the listing of all airline connections. We would infer, if the direct flight is not listed there (the minimal model), that it does not exist.

The closed world assumption is a statement that if our computational system cannot conclude that $p(X)$ is true, then $\text{not}(p(X))$ must be true. As we will see in Section 12.4, the closed world assumption supports PROLOG inferencing. In Section 12.4 we see the three assumptions (axioms) implicit in the use of minimal models. These axioms are the *unique name*, i.e., that all atoms with distinct names are distinct; *the closed world*, i.e., the only instances of a relation are those implied by the clauses present; and *domain closure*, i.e., the atoms of the domain are exactly those of the model. When these three are satisfied, a minimum model becomes a full logic-based specification. If the axioms are not satisfied, a truth maintenance algorithm is required.

If the closed world requires that all the predicates that make up a model be stated, *circumscription* (McCarthy 1980, Lifschitz 1984, McCarthy 1986) requires that *only* those predicates relevant to the problem solving are stated. In circumscription, axioms are added to a system that forces a minimal interpretation on the predicates of the knowledge base. These “meta-predicates” (predicates about the problem statement’s predicates) describe the manner in which particular predicates are to be interpreted. That is, they delimit, or circumscribe, the possible interpretations of predicates.

McCarthy (1980) introduced circumscription with a thought experiment on the missionaries and cannibals problem. The problem statement asks the solver to devise a series of moves in which six characters, under a set of constraints, can use a boat to cross a river. McCarthy brings up a large number of absurd situations that, quite legitimately, can be asked about the problem statement. A number of these, such as a slowly sinking boat or a wind factor, were presented earlier in this section. Although humans regard these situations as absurd, the reasoning we use to do so is not obvious. The circumscription axioms that McCarthy would add to the problem specification, would precisely delimit the predicates that describe the problem.

As another example of circumscription, consider a predicate expression from an object-oriented common sense reasoning specification, Section 8.5:

$$\forall X \text{ bird}(X) \wedge \text{not}(\text{abnormal}(X)) \Rightarrow \text{flies}(X)$$

This expression might occur in reasoning where one of the properties of *bird* is *flies*. But what could possibly limit the definition of the predicate *abnormal*? That the bird is not a penguin, that it does not have a broken wing, that it is not dead? The specification of the predicate *abnormal* is potentially undecidable.

Circumscription uses an axiom schema, or set of meta rules, within first-order predicate calculus to generate predicates for the problem domain. The schema rules cause certain formulae to have the smallest possible extensions. For example, if B is a belief system including world knowledge K and domain knowledge $A(p)$ about a predicate p , then we may consider p to be minimized, in that as few atoms a_i as possible satisfy $p(a_i)$ as is consistent with $A(p)$. The world knowledge K together with $A(p)$ and the circumscription schema are used to derive conclusions in standard first-order predicate calculus. These conclusions are then added to B , the belief system.

Suppose in the blocks world, Section 5.4, we have the expression:

$$\text{isblock}(A) \wedge \text{isblock}(B) \wedge \text{isblock}(C)$$

asserting that A, B, and C are blocks. Circumscribing the predicate *isblock* gives the expression:

$$\forall X (\text{isblock}(X) \Leftarrow (X=A \vee X=B \vee X=C))$$

This expression asserts that the only blocks are A, B, and C, i.e., just those objects that the *isblock* predicate requires to be blocks. In a similar fashion the predicate:

$$\text{isblock}(A) \vee \text{isblock}(B)$$

can be circumscribed to indicate that either block A or block B is the only block in the domain. For full details, including the schema axioms used to derive these results, see McCarthy (1980, Section 4).

Circumscription, when used with operators such as *abnormal*, is equivalent to the closed world assumption in that it produces exactly those variable bindings that *abnormal* can support. The circumscription algebra, however, allows us to extend this reasoning across predicate representations in that, as we just noted, if we have the predicate $p(X) \vee q(X)$, we may circumscribe either predicate *p* or *q* or both. Thus, unlike the closed world assumption, circumscription allows us to describe the instantiations possible across sets of predicate descriptions.

Further research in circumscriptive logics may be found in Genesereth and Nilsson (1987). Lifschitz (1986) has made an important contribution by proposing a point-wise circumscription in which the minimum model can be carried out for particular predicates and their possible instantiations, rather than for the full domain. Another research contribution is that of Perlis (1988) where reasoning can be about a particular agent's lack of knowledge.

Probably the most important problem facing nonmonotonic reasoning systems is in efficiently revising a set of conclusions in the light of changing beliefs. If, for example, we use the predicate *r* to infer *s*, then removing *r* removes also the support for *s*, as well as every other conclusion that used *s*. Unless there is an independent set of inferences supporting *s*, it must be retracted. Implementing this retraction process requires, in the worst case, that we recompute all the conclusions of the knowledge base each time a belief changes. *Truth maintenance systems*, presented next, offer mechanisms for maintaining the consistency of knowledge bases.

7.2.3 Truth Maintenance Systems

A *Truth maintenance system* (TMS) may be employed to protect the logical integrity of the conclusions of an inferencing system. As pointed out in the previous section, it is necessary to recompute support for items in a knowledge base whenever beliefs expressed by the clauses of the knowledge base are revised. Reason maintenance systems address

this issue by storing justifications for each inference and then reconsidering support for conclusions in the light of new beliefs.

One way of viewing this problem is to review the backtrack algorithm first presented in Section 3.2.2. Backtracking is a systematic method for exploring all the alternatives for decision points in search-based problem solving. An important shortcoming of the backtrack algorithm, however, is the way it systematically (and blindly) backs out of dead end states of the space and looks for alternatives from its most recent choices. This approach is sometimes called *chronological backtracking*. Granted that chronological backtracking will systematically check all alternatives in the space; however, the way it proceeds is time-consuming, inefficient, and in a very large space, useless.

What we really want in logic-based search is the ability to backtrack directly to the point in the space where the problem occurs, and to make adjustments to the solution at that state. This approach is called *dependency-directed backtracking*. Consider an example from nonmonotonic reasoning. We need to find out about p , which we cannot directly infer. There is, however, a plausible assumption q , which, if true, will support p . So we assume q and derive p . Our reasoning continues and based on p we conclude r and s . We continue on in our reasoning and conclude without the support of p , r , or s the results t and u . Finally, we prove that our earlier assumption of q is false. What are we to do?

Chronological backtracking would revisit our reasoning steps in the reverse order in which they were made. Dependency-directed backtrack would go immediately back to the source of the contradictory information, namely the first assumption of q . Then it would go forward retracting p , r , and s . We may, at this time check to see if r and s can be derived independently of p and q . Just because they were originally produced with an incorrect assumption, does not mean that they are not otherwise supported. Finally, because t and u were derived independent of p , r , and s , we would not need to reconsider them.

In order to use dependency directed backtracking in a reasoning system, we must:

1. Associate with the production of each conclusion its justification. This justification indicates the derivation process for that conclusion. The justification must contain all the facts, rules, and assumptions used to produce the conclusion.
2. Provide a mechanism that, when given a contradiction along with its justification, finds the false assumption within that justification that led to the contradiction.
3. Retract the false assumption.
4. Create a mechanism that follows up the retracted assumption and retracts any conclusion that uses within its justifications the retracted false assumption.

Of course, all retracted conclusions are not necessarily false, so they must be rechecked to see if they can be justified independent of the retracted clauses. We next present two methods for building dependency directed backtracking systems.

Jon Doyle (1979) created one of the earliest truth maintenance systems, called a *justification based truth maintenance system* or JTMS. Doyle was the first researcher to explicitly separate the truth maintenance system, a network of propositions and their justifications, from the reasoning system operating in some domain. The result of this split

is that the JTMS communicates with the problem solver, perhaps an automated theorem prover, receiving information about new propositions and justifications and in turn supplying the problem solver with information about which propositions should be believed based on the current existing justifications.

There are three main operations that are performed by the JTMS. First, the JTMS inspects the network of justifications. This inspection can be triggered by queries from the problem solver such as: Should I believe in proposition p ? Why should I believe proposition p ? What assumptions underlie proposition p ?

The second operation of the JTMS is to modify the dependency network, where modifications are driven by information supplied by the problem solver. Modifications include adding new propositions, adding or removing premises, adding contradictions, and justifying the belief in a proposition. The final operation of the JTMS is to update the network. This operation is executed whenever a change is made in the dependency network. The update operation recomputes the labels of all propositions in a manner that is consistent with existing justifications.

To make the JTMS more precise we construct a simple dependency network. Consider the modal operator M presented in Section 7.2.1, which placed before a predicate is read as *is consistent with*. For example:

$$\begin{aligned} &\forall X \text{ good_student}(X) \wedge M \text{ study_hard}(X) \Rightarrow \text{study_hard}(X) \\ &\forall Y \text{ party_person}(Y) \Rightarrow \text{not}(\text{study_hard}(Y)) \\ &\text{good_student}(\text{peter}) \\ &\text{party_person}(\text{peter}) \end{aligned}$$

We now make this set of propositions into a justification network.

In a JTMS, each predicate representing a belief is associated with two other sets of beliefs. The first set, labeled **IN** in Figure 7.8, is the set of propositions that should be believed for the proposition to hold. The second, labeled **OUT**, are propositions that should not be believed for the proposition to hold. Figure 7.8 represents the justification that supports $\text{study_hard}(\text{peter})$ derived from the predicates just listed. The notations of Figure 7.8 are adapted from Goodwin (1982) and explained in Figure 7.9. The premises of justifications are labeled as in Figure 7.9(a) and the combinations of propositions that support a conclusion are labeled as in Figure 7.9(b).

With the information of the network of Figure 7.8, the problem solver can reason that $\text{study_hard}(\text{peter})$ is supported, because the premise $\text{good_student}(\text{peter})$ is believed and it is consistent that good students study hard. There is also no evidence or other indication that Peter does not study hard.

Suppose we now add in the premise $\text{party_person}(\text{peter})$. This addition enables the derivation $\text{not}(\text{study_hard}(\text{peter}))$, and the belief $\text{study_hard}(\text{peter})$ is no longer supported. The justifications for this new situation are reflected in Figure 7.10. Note the relabeling of **IN** and **OUT**.

As Figures 7.8 and 7.10 demonstrate, the JTMS does not directly represent the predicate relationships as expressed in the original set of propositions. Rather the JTMS is a simple network that only considers the relations between atomic propositions and their negation and organizes these into support relationships for beliefs. The full set of predicate

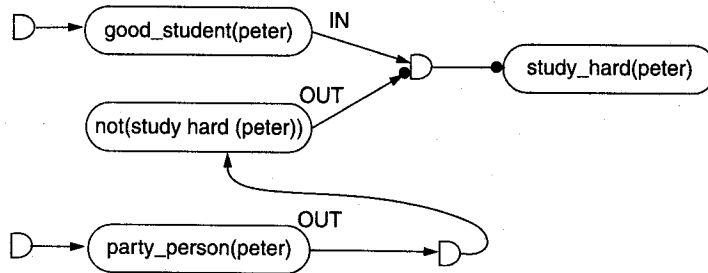

Figure 7.8 A justification network to believe that Pete studies hard.

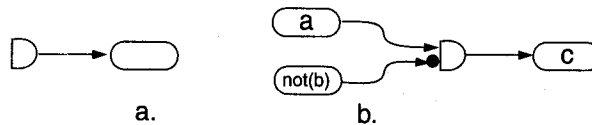

Figure 7.9 7.9(a) represents a premise justification, and 7.9(b) the ANDing of two beliefs, a and not b, to support c (Goodwin 1982).

connectives and inferencing schemes ($\forall X$, \wedge , \vee , \Rightarrow , etc.) are used within the problem solver itself. The more recent systems of McAllester (1978) and Martins and Shapiro (1988) merged the TMS and the problem solver into a single representation.

A JTMS is only concerned with the dependencies among beliefs and has no concern with the contents of these beliefs. Therefore, we can replace the beliefs by identifiers, often of the form n_1 , n_2 , ..., which are associated with objects in the network called nodes. Then the algebra of INs and OUTs that we saw implemented in the *study_hard* example allows the JTMS to reason about the support for beliefs.

To summarize, a JTMS works with sets of nodes and justifications. Nodes stand for beliefs, and justifications support belief in nodes. Associated with nodes are the labels IN and OUT, which indicate the belief status of the associated node. We can reason about the support for any node by relating it to the INs and OUTs of the other nodes that make up its justification(s). The primary operations of the JTMS algebra is to accomplish the inspection, modification, and updating operators noted above. Finally, since justification checking is enforced by backing over the links of the justification network itself, we have an example of dependency-based backtracking. For further information on the node algebra support for JTMS see Doyle (1983) or Reinfrank (1989).

A second type truth maintenance system is the *assumption-based truth maintenance system* (ATMS). The term *assumption-based* was first introduced by deKleer (1984), although similar ideas may be found in Martins and Shapiro (1983). In these systems, the labels for nodes in the network are no longer IN and OUT but rather the sets of premises

(assumptions) underlying their derivation. deKleer also makes a distinction between premise nodes that hold universally and nodes that can be assumptions made by the problem solver and that may later be retracted.

An advantage of ATMS over JTMS stems from the additional flexibility the ATMS provides in dealing with multiple possible states of belief. By labeling beliefs with the sets of premises under which they hold, there is no longer a single state of belief (in JTMS all the nodes labeled IN), but rather a number of possible states, the set of all subsets of the supporting premises. The creation of different belief sets, or possible worlds, allows a comparison of results from different choices of premises, the existence of different solutions for the problem, and the detection of and recovery from contradictions. The disadvantages of ATMS include the inability to represent premise sets that are themselves nonmonotonic and the control over the problem solver. However, see Dressler (1988) and Forbus and deKleer (1988) for alternatives.

The communication between the ATMS and the problem solver is similar to that between JTMS and its problem solver with operators for *inspection*, *modification*, and *updating*. The only difference is that with ATMS there is no longer a single state of belief but rather subsets of potential supporting premises. The goal of computation within the ATMS is to find minimal sets of premises sufficient for the support of each node. This computation is done by propagating and combining labels, beginning with the labels for the premises.

We next present a detailed example adapted from Martins (1991). Suppose we have the ATMS network of Figure 7.11. In this network, n_1 , n_2 , n_4 , and n_5 are premises and assumed true. The dependency network also reflects the relations that from premise n_1 and n_2 we support n_3 , with n_3 we support n_7 , with n_4 we support n_7 , with n_4 and n_5 we support n_6 , and finally, with n_6 we support n_7 .

Figure 7.12 presents the subset/superset lattice for the premise dependencies of Figure 7.11. This lattice of subsets of premises offers a useful way to visualize the space of combinations of premises. Thus, if some premise is found to be suspect, the ATMS will be able to determine how that premise relates to other premise support subsets. For example, node n_3 in Figure 7.11 will be supported by all sets of premises that are above $\{n_1, n_2\}$ in the lattice of Figure 7.12.

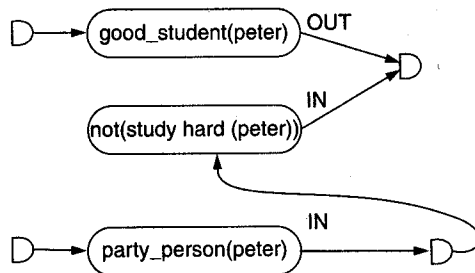

Figure 7.10 The new labeling of Figure 7.8 associated with the new premise `party_person(peter)`

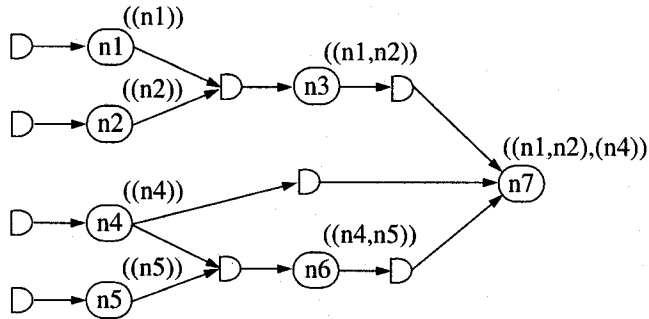

Figure 7.11 An ATMS labeling of nodes in a dependency network.

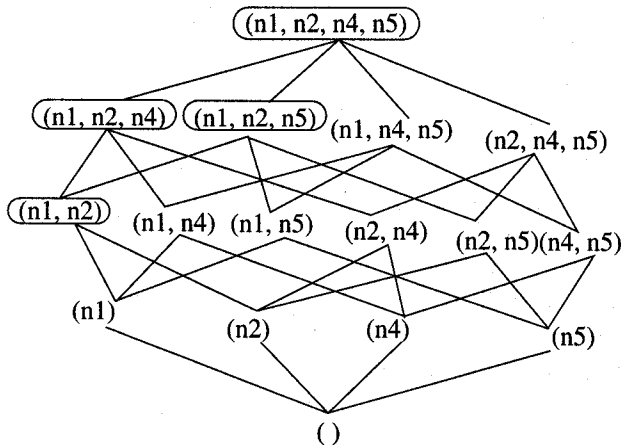

Figure 7.12 The lattice for the premises of the network of Figure 7.11. Circled sets indicate the hierarchy of inconsistencies (after Martins 1991).

The ATMS reasoner removes contradictions by removing from the nodes those sets of premises that are discovered to be inconsistent. Suppose, for example, we revise the support for the reasoning reflected by Figure 7.11 to make n_3 a contradiction node. Since the label for n_3 is $\{n_1, n_2\}$, this set of premises is determined to be inconsistent. When this inconsistency is discovered, all the sets of premises that are in the superset relation to $\{n_1, n_2\}$ in Figure 7.12 are marked as inconsistent and removed from the dependency network. In this situation, one of the possible labellings supporting n_7 will have to be removed. A full description of the contradiction-removal algorithm may be found in deKleer (1986).

There are several other important contributions to TMS reasoning. *Logic-based TMS* is based on the work of McAllester (1978). In LTMS, relationships between propositions are represented by clauses which can be used to deduce the truth values of any of the propositions they describe. Another approach, the *multiple belief reasoner* MBR is similar to the ATMS reasoner except that the problem solver and the truth maintenance system are merged into a single system. MBR is based on a logic language called SWM* which describes knowledge states. Each knowledge state is composed of a pair of descriptors, the first reflecting a knowledge base and the second a set of sets of known inconsistent premises within the knowledge base. Algorithms for checking inconsistencies during reasoning may be found in Martins (1991).

7.2.4 Set Cover and Logic-based Abduction (Stern 1996)

As noted in the introduction of Chapter 7, in abductive reasoning, we have rules of the form $p \Rightarrow q$, along with a reasonable belief in q . We wish then to make a case for the truth of predicate p . Abductive reasoning is not sound, but what is often called *reasoning to the best explanation* for the presence of the data q . In this section, we look more closely at the generation of explanations in domains of abductive inference.

Besides the accounts of abductive reasoning already presented in Chapter 7, AI researchers have also used set cover and logic analyses. The *set cover* approach to abduction attempts to explain the act of adopting a revocable belief in some explanatory hypothesis on the grounds that it explains an otherwise unexplainable set of facts. The *logic-based* approach to abduction describes inference rules for abduction along with a definition of their legitimate form(s) for use.

The *set cover* approach, defines an abductive explanation as a covering of predicates describing observations by predicates describing hypotheses. Reggia et al. (1983) describes a cover based on a binary causal relation R where R is a subset of {Hypotheses X Observations}. Thus, an abductive explanation of a set of facts $S2$ is another set of facts $S1$ sufficient to cause $S2$. An optimal explanation according to set cover approach, is the minimal set cover of $S2$. The weakness of this approach is that it reduces explanation to a simple list of causes. In situations where there are interrelated or interacting causes or where an understanding of the structure or sequencing of causal interactions is required, the set cover model is inadequate.

Logic-based approaches to abduction on the other hand, rest on a more sophisticated notion of explanation. Levesque (1989) defines an abductive explanation of some previously unexplained set of observations O as a minimal set of hypotheses H consistent with an agent's background knowledge K . The hypotheses H together with the background knowledge K must entail O . More formally:

$\text{abduce}(K, O) = H$, if and only if

1. K does not entail O
2. $H \cup K$ entails O
3. $H \cup K$ is consistent, and
4. No subset of H has properties 1, 2, and 3.

Note that in general many sets of hypotheses may exist; that is, there may be many potential abductive sets of explanations for a given set of observations O .

The logic-based definition of abductive explanation suggests a corresponding mechanism for explanation discovery in the context of a knowledge-based system. If the explanatory hypotheses must entail the observations O , then the way to construct a complete explanation is to reason backwards from O . As we saw in Sections 3.3 and 6.2, we may start from the conjunctive components of O and reason back from consequents to antecedents.

This backchaining approach also seems natural because the conditionals which support the backchaining can readily be thought of as causal laws, thus capturing the pivotal role which causal knowledge plays in the construction of explanations. The model is also convenient because it fits nicely with something which the AI community already has experience: backchaining and computational models for deduction.

There are also clever ways of finding the complete set of abductive explanations. Assumption-based truth-maintenance systems ATMS (deKleer 1986, Section 7.2.3), contain an algorithm for computing minimal support sets, the set of (non-axiom) propositions that logically entail a given proposition in a theory. To find all possible abductive explanations for a set of observations, we merely take the Cartesian product over the support sets.

As simple, precise, and convenient as the logic-based account of abduction is, there are two related shortcomings: high computational complexity and semantic weakness. Selman and Levesque (1990) found the complexity of abduction tasks similar to that involved in computing support sets for an ATMS. The standard proof that the ATMS problem is NP-hard depends on the existence of problem instances with an exponential number of solutions. Selman and Levesque avoid the number of potential solutions complexity issue by asking whether finding a smaller set of solutions is also NP-hard. Given a Horn clause knowledge base, see Section 12.2, Selman and Levesque produce an algorithm that finds a single explanation in order $O(k \times n)$ where k indicates the number of propositional variables and n the number of occurrences of literals. However, when restrictions are placed on the kinds of explanations sought, the problem again becomes NP-hard, even for Horn clauses.

One interesting result from the Selman and Levesque (1990) analysis is the fact that adding certain kinds of goals or restrictions to the abduction task actually makes computation significantly harder. From the naive viewpoint of the human problem solver, this added complexity is surprising: the human assumes that the addition of further constraints to the search for relevant explanations makes the task easier. The reason the abduction task is harder in the logic-based model is that it only contributes additional clauses to the problem, not additional structure to the problem solving.

Explanation discovery in the logic-based model is characterized as the task of finding a set of hypotheses with certain logical properties. These properties, including consistency with the background knowledge and entailment of what is to be explained, are meant to capture the *necessary* conditions of explanations: the minimal conditions which a set of explanatory hypotheses must satisfy in order to count as an abductive explanation. Proponents of this approach believe that by adding additional constraints, the approach can be extended to provide a characterization of good or reasonable explanations.

One simple strategy for producing quality explanations is to define a set of fact clauses that are abducible, that is, from which candidate hypotheses must be chosen. This clause set allows search to be restricted in advance to those factors that can potentially play a causal role in the chosen domain. Another strategy is to add selection criteria for evaluating and choosing between explanations. Various selection criteria have been proposed, including *set minimality*, which prefers one hypothesis set over another, where both are consistent and entail what is to be explained, if the first is contained in the second. A *simplicity* criterion gives preference to parsimonious hypothesis sets, those containing fewer unverified assumptions (Levesque 1989).

Both minimality and simplicity can be seen as applications of Occam's razor. Unfortunately, set minimality is of limited power as a search pruning tool; it only eliminates final explanations which are supersets of existing explanations. Simplicity alone is also of questionable validity as a search selection criterion. It is not difficult to construct examples in which an explanation requiring a larger hypothesis set is preferable to some simpler but shallower set of hypotheses. Indeed, complex causal mechanisms will usually require larger hypothesis sets; however, the abduction of such causal mechanisms may well be justified, particularly when the presence of certain key elements of that mechanism have already been verified by observation.

Two other mechanisms for explanation selection are also interesting because they take into account both properties of the hypothesis set as well as properties of the proof procedure. First, *cost-based abduction* places a cost on potential hypotheses as well as a cost on rules. The total cost of the explanation is computed on the basis of the total cost of the hypotheses plus the cost of the rules used to abduce the hypotheses. Competing hypothesis sets are then compared according to cost. One natural semantic that can be attached to this scheme is the probabilistic one (Charniak and Shimony 1990, Section 11.4). Higher costs for hypotheses represent less likely events; higher costs for rules represent less probable causal mechanisms. Cost-based metrics can be combined with least-cost search algorithms, such as best first search, see Chapter 4, considerably reducing the computational complexity of the task.

A second mechanism, *coherence-based selection*, is particularly appealing when what is to be explained is not a simple proposition but rather a set of propositions. Ng and Mooney (1990) have argued that a coherence metric is superior to a simplicity metric for choosing explanations in the analysis of natural language text. They define coherence as a property of a proof graph where explanations with more connections between any pair of observations and fewer disjoint partitions are more coherent. The coherence criterion is based on the heuristic assumption that what we are asked to explain is a single event or action with multiple aspects. The justification for a coherence metric in natural language understanding is based on Gricean felicity conditions, that is the speaker's obligation to be coherent and pertinent (Grice 1975). It is not difficult to extend their argument to a variety of other situations. For example in diagnosis, the observations which comprise the initial set of things to be explained are brought together because they are believed to be related to the same underlying fault or failure mechanism.

In Sections 7.1 and 7.2, we considered architectures for reasoning that supported the manipulation of clause-based descriptions of the world. In the next section, we describe an alternative logic that relaxes the classical notion of the meaning of words and references.

7.3 Reasoning with Fuzzy Sets

There are two assumptions that are essential for the use of traditional formal logic. The first is with respect to set membership: for any element and a set belonging to some universe, the element is either a member of the set or else it is a member of the complement of the set. The second assumption, referred to as *the law of excluded middle*, states that an element cannot belong to both a set and also to its complement. Both these assumptions are violated in Lotfi Zadeh's *fuzzy set theory*. In fact, the sets and reasoning laws of traditional logic are referred to as *crisp*, from the fuzzy set viewpoint.

Zadeh's main contention (Zadeh 1983) is that, although probability theory is appropriate for measuring randomness of information, it is inappropriate for measuring the *meaning* of information. Indeed, much of the confusion surrounding the use of English words and phrases is related to lack of clarity (vagueness) rather than randomness. This is a crucial point for analyzing language structures and can also be important in creating a measure of confidence in production rules. Zadeh proposes *possibility theory* as a measure of vagueness, just as probability theory measures randomness.

Zadeh's theory expresses lack of precision in a quantitative fashion by introducing a set membership function that can take on real values between 0 and 1. This notion of a *fuzzy set* can be described as follows: let S be a set and s a member of that set. A fuzzy subset F of S is defined by a membership function $mF(s)$ that measures the "degree" to which s belongs to F .

A standard example of a fuzzy set is for S to be the set of positive integers and F to be the fuzzy subset of S called "small integers." Now various integer values can have a "possibility" distribution defining their "fuzzy membership" in the set of small integers: $mF(1) = 1.0$, $mF(2) = 1.0$, $mF(3) = 0.9$, $mF(4) = 0.8$, ..., $mF(50) = 0.001$, etc. For the statement that positive integer X is a "small integer," mF creates a possibility distribution across all the positive integers (S), as is shown in Figure 7.13.

Fuzzy set theory is not concerned with how these possibility distributions are created, but rather with the rules for computing the combined possibilities over expressions that contain fuzzy variables. Thus, it includes rules for combining possibility measures for expressions containing fuzzy variables. The laws for the *or*, *and*, and *not* of these expressions are similar to those just presented for the Stanford certainty factor algebra; see Section 7.1.4.

Figure 7.13 is a representation of the set membership function for the set of small integers. Each integer belongs to this set with an associated confidence measure. In the

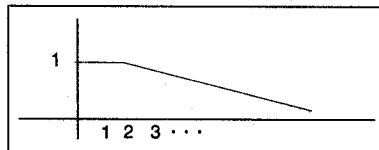

Figure 7.13 The fuzzy set representation for "small integers."

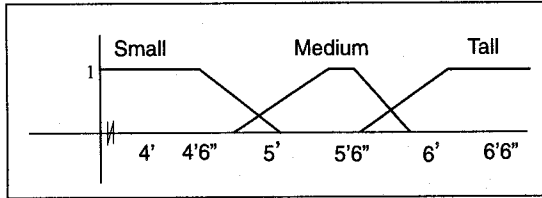

Figure 7.14 A fuzzy set representation for the sets small, median, and tall males.

traditional logic of crisp sets, the confidence of an element being in a set must be either 1 or 0. Figure 7.14 offers a set membership function for the concept of short, medium, and tall male humans. Note that any one person can belong to more than one set, for example, a 5' 10" male belongs to both the set of *medium* as well as to the set of *tall* males.

We next demonstrate (Figure 7.15) rules for combining and propagating fuzzy measures by presenting part of a problem, now classic in the fuzzy set literature, a control regime for an inverted pendulum. Figure 7.15 presents a pendulum, inverted, which we desire to keep in balance and pointing upward. We keep the pendulum in balance by moving the base of the system to offset the force of gravity acting on the pendulum. There are sets of differential equations that can deterministically keep the pendulum in equilibrium (Ross 1995). The advantage of the fuzzy approach to controlling this pendulum system, is that an algorithm may be established to control the system efficiently and in real time. We next show this control regime.

We simplify the pendulum problem by presenting it in two dimensions. There are two measurements we use as input values to the controller, as may be seen in Figure 7.15: First the angle θ , deviation of the pendulum from the vertical, and secondly the speed $d\theta/dt$ at which the pendulum is moving. Both these measures are positive in the quadrant to the

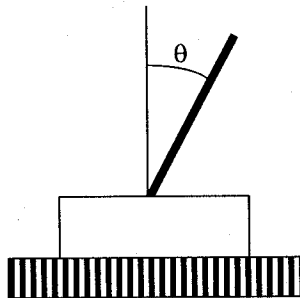

Figure 7.15 The inverted pendulum and the angle θ and $d\theta/dt$ input values.

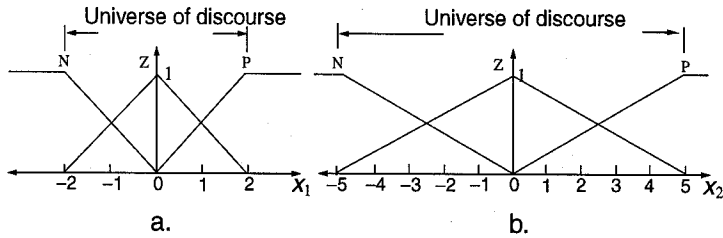

Figure 7.16 The fuzzy regions for the input values θ a. and $d\theta/dt$ b.

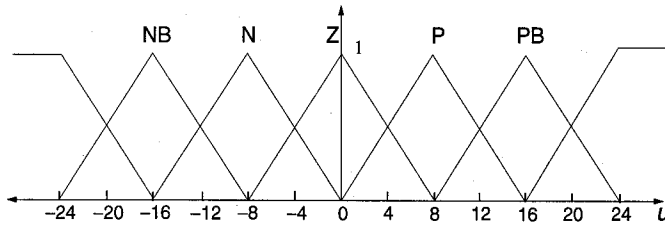

Figure 7.17 The fuzzy regions of the output value u , indicating the movement of the pendulum base.

right of vertical and negative to the left. These two values are given to the fuzzy controller at each iteration of the system. The output of the controller is a movement and a direction for the base of the system the movement and direction instructions are intended to keep the pendulum in balance

To clarify the actions of the fuzzy controller we describe the fuzzy set solution process. Data describing the state of the pendulum, θ and $d\theta/dt$, are interpreted as fuzzy measures and presented to a fuzzy rule set. This step is often made very efficient by use of a structure called a *fuzzy associative matrix* or FAM, where input/output relations are directly encoded. Rules are not chained together as in traditional rule-based problem solving. Rather, all matched rules fire and then their results are combined. This result, usually represented by an area of the fuzzy output parameter space, which is then defuzzified to return the control response. Note that both the original input and eventual output of the controller are crisp values. These are exact readings of some monitor, the inputs, and a precise instruction for control, the output.

We next describe the fuzzy regions for the input values, θ and $d\theta/dt$. This example simplifies the situation, for example, in the number of fuzzy regions of input values, but shows the full cycle of rule application and the response of the controller. The input value θ is partitioned into three regions, **Negative**, **Zero**, and **Positive**, where θ ranges between -2 and $+2$ radians, as may be seen in Figure 7.16a. Figure 7.16b represents the three regions into which the second input value, $d\theta/dt$, is partitioned, again **Negative**, **Zero**, and **Positive**, ranging between -5 and $+5$ degrees per second.

Figure 7.17 represents the partitioning of the output space, where we use the middle five regions, **Negative Big**, **Negative**, **Zero**, **Positive**, and **Positive Big**. The measure, between -24 and $+24$ represents the movement and direction of each response.

Suppose the simulation begins and the first values given to the controller are $\theta = 1$ and $d\theta/dt = -4$. Figure 7.18 reflects the fuzzification of these input measures. In each situation, the input value impacts two regions of the fuzzy input space. For θ , the values are **Zero**, with 0.5, and **Positive**, with 0.5 possibility measures. For $d\theta/dt$, they are **Negative** with 0.8, and **Zero** with 0.2 possibility measures.

Figure 7.19 presents a simplified form of the fuzzy associative matrix for this problem. The input values to the table for θ , or x_1 , are down the left side, and for $d\theta/dt$, or x_2 , are across the top of the matrix. The 3×3 table of the lower right corner of the FAM then gives the output values. For example, if the θ is **Positive**, and $d\theta/dt$ is **Negative**, the FAM returns the value of **Zero** movement of the pendulum system. Note that the response still must be defuzzified from the **Zero** output region of Figure 7.17.

In this case, because each input value touched on two regions of the input space, four rules must be applied. As noted above, the combination rules for fuzzy systems are similar to those of the Stanford certainty factor algebra. In fact, Zadeh (Buchanan and Shortliffe

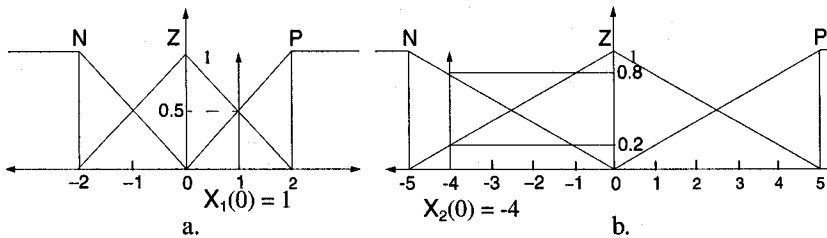
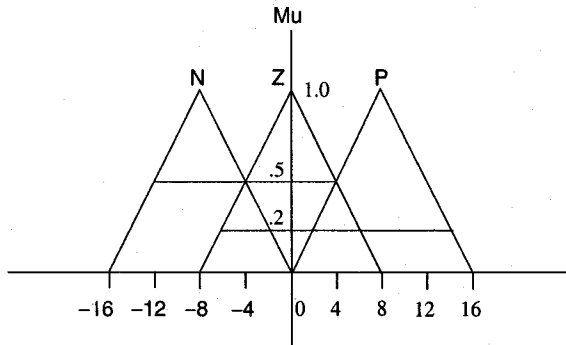

Figure 7.18 The fuzzification of the input measures $x_1=1$, $x_2 = -4$.

x_2	P	Z	N
P	PB	P	Z
Z	P	Z	N
N	Z	N	NB

Figure 7.19 The Fuzzy Associative Matrix (FAM) for the pendulum problem. The input values are on the left and top.



a.

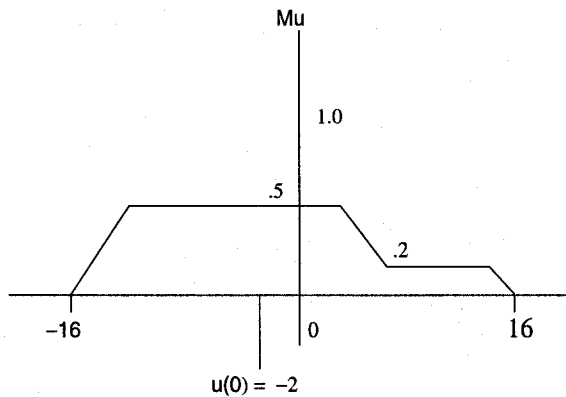

b.

Figure 7.20 The fuzzy consequents (a) and their union (b). The centroid of the union (-2) is the crisp output.

1984) was the first (historically) to propose these combination rules for the algebra of fuzzy reasoning. If the measures of two premises are **AND**ed together, the minimum of their measures is taken as the measure of the rule. If two premises are **OR**ed, the maximum of their measures is taken.

In our example, all the premise pairs are **AND**ed together, so the minimum of their measures is taken as the measure of the rule result:

$$\begin{aligned} \text{IF } x_1 = P \text{ AND } x_2 = Z \text{ THEN } u = P \\ \min(0.5, 0.2) = 0.2 P \end{aligned}$$

$$\begin{aligned} \text{IF } x_1 = P \text{ AND } x_2 = N \text{ THEN } u = Z \\ \min(0.5, 0.8) = 0.5 Z \end{aligned}$$

IF $x_1 = Z$ AND $x_2 = Z$ THEN $u = Z$
 $\min(0.5, 0.2) = 0.2 Z$

IF $x_1 = Z$ AND $x_2 = N$ THEN $u = N$
 $\min(0.5, 0.8) = 0.5 N$

Next the output results are combined. In our example, we union together the two areas of Figure 7.17, indicated by the results of the rules firing. There are a number of possible defuzzification techniques (Ross 1995). We choose one of the commonest, the *centroid method*. To use this method the centroid of the union of the areas of the output values is the final value the controller applies to the pendulum. The union, as well as the centroid for the union, are presented in Figure 7.20. After this output or result is applied to the system, q and dq/dt are sampled again and the control cycle is repeated.

There are a number of issues we have not addressed in describing fuzzy reasoning systems, including patterns of oscillations within the convergence process and optimum sampling rates. Fuzzy systems, especially in the area of control, offer engineers a powerful and efficient tool for dealing with imprecision in measurement.

7.4 Epilogue and References

We implement simple expert system shells in PROLOG and LISP in Chapters 9 and 10, respectively. These shells are able to create a goal-driven search much like MYCIN's. The shells include certainty measures and use abductive inference in a limited form. A number of references show how different expert system applications use forms of abductive reasoning; these include Durkin (1994), *Expert Systems: design and development*, Jackson (1986), *Introduction to Expert Systems*, Charniak and McDermott (1986), *An Introduction to Artificial Intelligence*, and Rich and Knight (1991), *Artificial Intelligence*. We especially recommended the collection of the original MYCIN publications from Stanford entitled *Rule-Based Expert Systems* by Buchanan and Shortliffe (1984). This work describes the early Stanford certainty factor algebra.

Because of the domain specificity of expert system solutions, case studies are an important source of knowledge in the area. Books in this category include *Expert Systems: Techniques, Tools and Applications* by Klahr and Waterman (1986), *Competent Expert Systems: A Case Study in Fault Diagnosis* by Keravnou and Johnson (1986), *The CRI Directory of Expert Systems* by Smart and Langeland-Knudsen (1986), *Developments in Expert Systems* by Coombs (1984), and *Development and Management of Expert Systems* by Prerau (1990).

For further algorithms to implement Bayesian belief networks we recommend Pearl's (1988) message passing approach and a clique triangulation method proposed by Lauritzen and Spiegelhalter (1988). We also recommend the discussion of these algorithms as found in the Encyclopedia of AI (Shapiro 1992). The spring 1996 issue of the *AISB Quarterly* contains an excellent introduction to Bayesian belief networks (van der Gaag 1996); we recommend the discussion of qualitative probabilistic networks by Druzdzel.

One of the first efforts to build an explicit model of causal relationships was for the

diagnosis of various forms of the eye disease glaucoma CASNET (Weiss et al. 1977). A more sophisticated use of causal representations was ABEL (Patil et al. 1981) reasons about Acid Base and Electrolyte imbalances.

There are several other important contributions to truth maintenance systems (TMS) reasoning. *Logic-based TMS* is based on the work of McAllester (1978). In LTMS relationships between propositions are represented by clauses which can be used to deduce the truth values of any of the propositions they describe. Another approach, the *multiple belief reasoner* MBR is like the ATMS reasoner (deKleer 1984) although similar ideas may be found in Martins and Shapiro (1983). MBR is based on a logic language called SWM* which describes knowledge states. Algorithms for inconsistency checking across reasoning in the knowledge base may be found in Martins (1991). For further information on the node algebra support for JTMS see Doyle (1983) or Reinfrank (1989).

Default logic will allow any theorem inferred in an extension of a system to be admitted as an axiom for further reasoning. Research by Reiter and Criscuolo (1981) and Touretzky (1986) continue to develop these issues.

There is now a rich literature on nonmonotonic reasoning, belief logics, and truth maintenance; besides the original papers in the area (Doyle 1979, Reiter 1985, deKleer 1986, McCarthy 1980), a useful introduction to this literature includes *Probabilistic Reasoning in Intelligent Systems* by Pearl (1988), *Readings in Uncertain Reasoning* by Shafer and Pearl (1990), *Representations of Common Sense Knowledge* by Davis (1990), and numerous articles in recent AAAI and IJCAI conference proceedings. We strongly recommend *The Encyclopedia of Artificial Intelligence*, edited by Stuart Shapiro (2nd edition 1992), for coverage of many of the reasoning models and techniques presented in this chapter. Josephson and Josephson (1994) have edited an important collection of papers in *Abductive Inference Computation, Philosophy, and Technology*. Also see *Formal Theories of the Commonsense World* (Hobs and Moore 1985).

Further research in circumscriptive logics may be found in Genesereth and Nilsson (1987), Lifschitz (1986), and McCarthy (1986). Another contribution to circumscriptive inference is Perlis' (1988) reasoning about a particular agent's lack of knowledge. Ginsburg (1987), has edited an important collection of papers on nonmonotonic systems, *Readings in Nonmonotonic Reasoning*.

For further reading on fuzzy systems we recommend the original paper by Lotfi Zadeh's (1983) and the more modern integrations of this technology found in *Fuzzy Sets, Neural Networks and Soft Computing* by Yager and Zadeh (1994) and *Fuzzy Logic with Engineering Applications* by Timothy Ross (1995). The control system for the inverted pendulum problem presented in Section 7.3 was adopted from Ross.

7.5 Exercises

1. Identify three application domains where reasoning under conditions of uncertainty is necessary. Pick one of these areas and design six inference rules reflecting reasoning in that domain.
2. Pick a problem domain and list a number of cause \rightarrow effect relationships. Structure the reasoning by identifying invariances as done in Figures 7.1 and 7.2.

3. Find, for the lubrication-oil example of Figure 7.4, two more examples of each of the three types of d-separation identified in Figure 7.3. Describe for each situation how the reasoning changes as new information is acquired.
4. Create an algorithm for Bayesian belief propagation and apply it to the lubrication-oil domain of Section 7.1.2. You might begin this task by reviewing Pearl's (1988) message passing approach or the clique triangulation method proposed by Lauritzen and Spiegelhalter (1988).
5. In the influence diagram of Figure 7.4, suppose that low oil level has been detected and now we observe not clean exhaust. Describe how the +, -, and 0 influences are propagated across the nodes of the graph.
6. Druzdzel and Henrion (1993) have proposed algorithms for influence propagation in belief networks. Either use the Druzdzel and Henrion approach or build your own algorithm to perform belief propagation in the lube-oil domain of Section 7.1.2.
7. Create a influence diagram for another application, for example medical diagnosis, geological discovery, or automobile fault analysis. Point out examples of d-separation and create several influence paths through this network.
8. Given the following rules in a "back-chaining" expert system application:
 - $A \wedge \text{not}(B) \Rightarrow C$ (.9)
 - $C \vee D \Rightarrow E$ (.75)
 - $F \Rightarrow A$ (.6)
 - $G \Rightarrow$ (.8)
 The system can conclude the following facts (with confidences):
 - F(.9)
 - B(-.8)
 - G(.7)
 Use the Stanford certainty Factor algebra to determine E and its confidence.
9. Consider the simple MYCIN-like rule if $A \wedge (B \vee C) \Rightarrow D$ (.9) \wedge E (.75). How many and which probability measure would be necessary to use this information in a Bayesian context? How might this rule be handled in Dempster-Shafer reasoning.
10. Create an example causal network in an area where you have some expertise. Recall that this network will have three "layers," an observable data layer connected to a causal layer by an intermediate level that organizes data relative to causes.
11. Use the schema axioms presented in McCarthy (1980, Section 4) to create the circumscription results presented in Section 7.2.3.
12. Create another reasoning network similar to that of Figure 7.11 and show the dependency lattice for its premises, as was done in Figure 7.12.
13. Reasoning by assumption of a minimum model is important in human everyday life. Work out two more examples that assume minimum models.

14. Continue the inverted pendulum example of Section 7.3. Make two more iterations of the fuzzy controller where the output of one iteration make up the input values for the next iteration.
15. Write a program that implements the fuzzy controller of Section 7.3.
16. Go to the literature, for example Ross (1995), and describe two other areas where fuzzy control might be appropriate. Construct a set of fuzzy rules for those domains.

KNOWLEDGE REPRESENTATION

8

*When you notice a cat in profound meditation,
The reason, I tell you, is always the same:
His Mind is engaged in a rapt contemplation of the
Thought, of the thought, of the thought of his name.*

—T. S. ELIOT, *Old Possum's Book of Practical Cats*

We have always two universes of discourse—call them “physical” and “phenomenal,” or what you will—one dealing with questions of quantitative and formal structure, the other with those qualities that constitute a “world.” All of us have our own distinctive mental worlds, our own inner journeyings and landscapes, and these, for most of us, require no clear neurological “correlate.”

—OLIVER SACKS, *The Man Who Mistook His Wife for a Hat*

8.0 Knowledge Representation Languages

In building a knowledge base, a programmer must select the significant objects and relations in the domain and map these into a formal language. The resulting program must contain sufficient knowledge to solve problems in the domain, it must make correct inferences from this knowledge, and it must do so efficiently.

We can think of a knowledge base in terms of a mapping between the objects and relations in a problem domain and the computational objects and relations in a program (Bobrow 1975). The results of inferences on the knowledge base should correspond to the results of actions or observations in the world. The computational objects, relations, and inferences available to programmers are determined by the knowledge representation language they select. The proper language can help the programmer acquire, organize, and debug the knowledge base.

There are general principles of knowledge organization that apply across a variety of domains and can be directly supported by a representation language. For example, class hierarchies are found in both scientific and common sense classification systems. How may we provide a general mechanism for representing them? How may we represent definitions? Exceptions? When should a knowledge-based system make default assumptions about missing information and how should it adjust its reasoning if these assumptions prove wrong? How may we best represent time? Causality? Uncertainty? Progress in knowledge-based systems depends on discovering the principles of knowledge organization and supporting them in higher-level representational tools.

It is useful to distinguish between a representational *scheme* and the *medium* of its implementation (Hayes 1974). This is similar to the distinction between data structures and programming languages. Programming languages are the *medium* of implementation; the data structure is the *scheme*. Generally, knowledge representation languages are more constrained than predicate calculus or programming languages such as LISP and PROLOG. The constraints take the form of explicit structures for representing categories of knowledge. The medium in which they are implemented might be PROLOG, LISP, or a conventional language such as C, C++, or Java.

Over the past 25 years, numerous representational schemes have been proposed and implemented, each of them having its own strengths and weaknesses. Mylopoulos and Levesque (1984) have classified these into four categories:

1. **Logical representation schemes.** This class of representations uses expressions in formal logic to represent a knowledge base. Inference rules and proof procedures apply this knowledge to problem instances. First-order predicate calculus is the most widely used logical representation scheme, but it is only one of a number of logical representations (Turner 1984). PROLOG is an ideal programming language for implementing logical representation schemes.
2. **Procedural representation schemes.** Procedural schemes represent knowledge as a set of instructions for solving a problem. This contrasts with the declarative representations provided by logic and semantic networks. In a rule-based system, for example, an *if . . . then . . .* rule may be interpreted as a procedure for solving a goal in a problem domain, by solving the premises in order. A production system may be seen as an example of a procedural representation scheme.
3. **Network representation schemes.** Network representations capture knowledge as a graph in which the nodes represent objects or concepts in the problem domain and the arcs represent relations or associations between them. Examples of network representations include *semantic networks*, *conceptual dependencies*, and *conceptual graphs*.
4. **Structured representation schemes.** Structured representation languages extend networks by allowing each node to be a complex data structure consisting of named slots with attached values. These values may be simple numeric or symbolic data, pointers to other frames, or even procedures for performing a particular task. Examples of structured representations include *scripts*, *frames*, and *objects* (Chapter 15).

Logical representations are discussed in Chapters 2 and 12; procedural approaches are discussed throughout the text, particularly in the discussion of production systems in Section 5.3. This chapter introduces network and structured representation schemes.

8.1 Issues in Knowledge Representation

A number of important issues have dominated research in knowledge representation. In this section we introduce these issues and the difficulties they present to designers and users of knowledge representation schemes. Much of this work is motivated by the effort to program a computer to understand human languages such as English. Because of the breadth and complexity of the knowledge required for understanding natural language, Chapter 11, this application has motivated much of the research in representation.

In a pivotal paper, Woods criticized the tendency to base representation languages on intuitive responses to specific domains (Woods 1985). Generally speaking, Woods argued that it was not sufficient to examine the semantics of *natural* language and implement structures that seemed to capture these features, but that more attention should be paid to the semantics of the representation formalism itself. This representation language is the basis for all inferences that will be made by the system and therefore determines what can be known and ultimately expressed. A number of questions must be asked in designing a representation language.

Exactly what “things” can be represented by the objects and relations in the language? For example, if a predicate relates an object to a value, such as `hascolor(car, red)`, how can that predicate be used to represent “John’s car is redder than Mary’s”? Here, the second argument is not a value at all but a comparison with the color of Mary’s car; how should we capture this in our notation?

A related question concerns the granularity of the representation. In predicate calculus and semantic networks we can denote objects in the domain only by using simple symbols. Other representations, such as frames and objects, let us define complex structures by encapsulating multiple features and attributes to indicate a single object in the domain. For example, a person is a single entity that requires many properties for its description. This has the advantage of placing all the information about an object in one place, making it easier to access, update, or delete.

How can representations distinguish between *intensional* and *extensional* knowledge? Briefly, the *extension* of a concept is the set of all things denoted by a given concept; for example, “ball” has as its extension the set of all balls. The *intension* determines what a concept means in the abstract, such as the definition of a ball in terms of its roundness, its ability to roll, bounce, and be thrown, or its use in games. Though these two different definitions characterize the same set of objects, their role in understanding is very different. This issue is important if we are linking an expert system and a database. The database enumerates objects and relations of a domain (its extension), whereas the expert system includes the intensional knowledge used to reason about these objects.

How can we best represent *meta-knowledge*, or knowledge about the objects and structures of the representation language itself? This is important if we wish to reason

about knowledge, as in describing the sentence "George believes that Tom knows that Mary's car is red." Knowledge base editors, such as Teiresias for MYCIN (Davis 1982), use meta-knowledge to reason about knowledge and proofs.

Another important feature of knowledge is its organization into class hierarchies. The ability to represent the relationship between an object and its class or between a class and its superclass has proved so useful that many representation languages include mechanisms that define these relationships. *Inheritance* is a relation by which an individual assumes the properties of its class and by which properties of a class are passed on to its subclass.

For example, if chimpanzee is a subclass of primate and Bonzo is a chimpanzee, we may assume that Bonzo has all the properties of chimpanzees and primates. Inheritance provides a natural tool for representing taxonomically structured knowledge, as well as an economical means of expressing properties common to a class of objects. It provides benefits such as guaranteeing that all members of a class inherit the appropriate properties, ensuring consistency with the class definition. It reduces the size of the knowledge base, as properties are defined once for the most general type that shares these properties rather than for all subclasses or individuals. For example, the property of having flexible hands would be defined for primates and inherited by chimps, gorillas, humans, etc. Properties such as being small and highly intelligent, which are not common to all primates, would be specified for the appropriate class, such as chimpanzee. The property of having a spine would be defined at a higher level of abstraction, the type vertebrate, and inherited by all subtypes, including primate and chimpanzee.

Inheritance is also used to implement *default values* and *exceptions*. For example, we may state that all chimpanzees live in the jungle, except Bonzo, who lives in the circus. Default values are simply inherited from the appropriate superclass. We can represent exceptions to these defaults by redefining the property at a lower level in the hierarchy, such as for Bonzo (Section 8.5).

Type hierarchies may assume a number of different forms, including trees, lattices, or arbitrary graphs. In a tree hierarchy, each type has only one supertype. This is a simple and well-behaved model, but it is not as expressive as hierarchies that allow multiple parent types. Most natural classification systems allow individuals to belong to multiple types and let types have multiple superclasses. For example, Bonzo belongs not only to the type chimpanzee but also to the type circus performer. Although multiple inheritance hierarchies can introduce difficulties in the definition of representation languages, their benefits are great enough to offset these disadvantages. The lattice is a common form for multiple inheritance.

Finally, it is often helpful to attach procedures to object descriptions. These procedures, sometimes referred to as *methods* or *demons*, are executed when an object is changed or created and provide a vehicle for implementing graphics, I/O, consistency checks, and interactions between objects.

Our discussion illustrates the subtlety and complexity of the knowledge representation problem. Outside of logic, network schemes make up the oldest representational device for AI. In the next section we show how many issues are addressed in the context of specific network association systems.

8.2 A Survey of Network Representations

8.2.1 Associationist Theories of Meaning

Logical representations grew out of the efforts of philosophers and mathematicians to characterize the principles of correct reasoning. The major concern of this work is the development of formal representation languages with sound and complete inference rules. Consequently, the semantics of predicate calculus emphasizes *truth-preserving* operations on well-formed expressions. An alternative line of research has grown out of the efforts of psychologists and linguists to characterize the nature of human understanding. This work is less concerned with establishing a science of correct reasoning than with describing the way in which humans actually acquire and use knowledge of their world. As a result, this work has proved particularly useful to the AI application areas of natural language understanding and commonsense reasoning.

The problems that arise in mapping commonsense reasoning into formal logic can be illustrated through an example. It is common to think of the operators \vee and \rightarrow as corresponding to the English “or” and “if ... then ...” However, these operators are concerned solely with truth values and ignore the fact that the English “if ... then ...” suggests a specific relationship (generally causal) between its premises and its conclusion. For example, the English sentence “If a bird is a cardinal then it is red” may be written in predicate calculus as:

$$\forall X (\text{cardinal}(X) \rightarrow \text{red}(X)).$$

This may be changed, through a series of truth-preserving operations, Chapter 2, into the logically equivalent expression

$$\forall X (\neg \text{red}(X) \rightarrow \neg \text{cardinal}(X)).$$

These two expressions are logically equivalent; that is, the second is true if and only if the first is true. However, truth value equivalence overlooks the more subtle connotations of the original English sentence. If we were to look for physical evidence of the truth of these statements, the fact that this sheet of paper is not red and also not a cardinal is evidence for the truth of the second expression. Because the two expressions are logically equivalent, it follows that it is also evidence for the truth of the first statement. This leads to the conclusion that the whiteness of the sheet of paper is evidence that cardinals are red.

Though logically sound, this line of reasoning strikes us as meaningless and rather silly. The reason for this incongruity is that logical implication only expresses a relationship between the truth values of its operands, while the original English sentence implies a causal relationship between membership in a class and the possession of properties of that class. The fact of being a cardinal causes a bird to be red. This relationship is lost in the second version of the expression. Although the fact that the paper is not red is consistent with the truth of both sentences, it is simply irrelevant to the color of birds.

To take another example, consider the logical expression

$$(2 + 2 = 5) \rightarrow \text{color}(\text{elephants}, \text{green}).$$

Because $2 + 2 = 5$ is false and elephants are not green we have an expression that evaluates to **false** \rightarrow **false**; this has, Chapter 2, a truth value of **true**. On the other hand, our commonsense response to this expression is that it is meaningless. Again, this anomaly is a result of predicate calculus's concern with truth value assignments rather than the semantic relationships between components of a world.

One answer to these problems is to be more careful in establishing conventions for mapping knowledge into predicate calculus or to extend the language with special operators that correspond to specific categories of knowledge.

The limitations of predicate calculus are largely a result of Tarskian semantics: the assignment of a truth value to logical expressions based on an interpretation in some possible world. It is not always enough to know that a statement such as "snow is white" is true; the meaning of the atomic symbols must also be addressed (Woods 1975). The representation should be able to answer questions about these objects such as: "What is snow made of?", "What temperature is Frosty the Snowman?", "If snow is white then what color is a snowman?". This requires that the representation not only preserve truth values when combining expressions but also have some means of making truth assignments based on knowledge of a *particular* world.

Associationist theories define the meaning of an object in terms of a network of associations with other objects in a mind or a knowledge base. Although symbols denote objects in a world, this denotation is mediated by our store of knowledge. When we perceive and reason about an object, that perception is first mapped into a concept in our minds. This concept is part of our entire knowledge of the world and is connected through appropriate relationships to other concepts. These relationships form an understanding of the properties and behavior of objects such as snow. For example, through experience we associate the concept **snow** with other concepts such as **cold**, **white**, **snowman**, **slippery**, and **ice**. Our understanding of snow and the truth of statements such as "snow is white" manifests itself out of this network of associations.

There is psychological evidence that in addition to their ability to associate concepts, humans also organize their knowledge hierarchically, with information kept at the highest appropriate levels of the taxonomy. Collins and Quillian (1969) modeled human information storage and management using a semantic network (Figure 8.1). The structure of this hierarchy was derived from laboratory testing of human subjects. The subjects were asked questions about different properties of birds, such as, "Is a canary a bird?" or "Can a canary sing?" or "Can a canary fly?".

As obvious as the answers to these questions may seem, reaction time studies indicated that it took longer for subjects to answer "Can a canary fly?" than it did to answer "Can a canary sing?" Collins and Quillian explain this difference in response time by arguing that people store information at its most abstract level. Instead of trying to recall that canaries fly, and robins fly, and swallows fly, all stored with the individual bird, humans remember that canaries are birds and that birds have (usually) the property of flying. Even more general properties such as eating, breathing, and moving are stored at

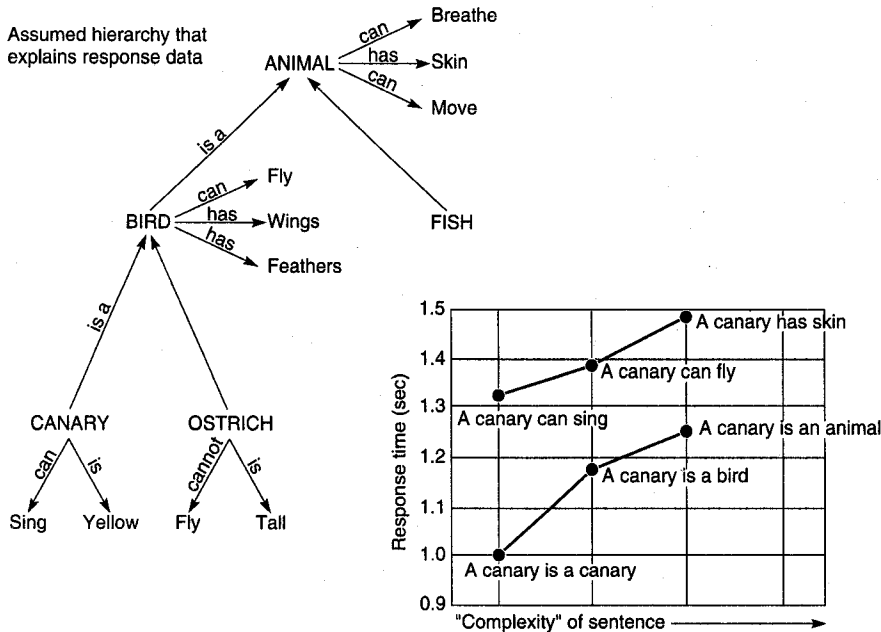

Figure 8.1 Semantic network developed by Collins and Quillian in their research on human information storage and response times (Harmon and King 1985).

the “animal” level, and so trying to recall whether a canary can breathe should take longer than recalling whether a canary can fly. This is, of course, because the human must travel further up the hierarchy of memory structures to get the answer.

The fastest recall was for the traits specific to the bird, say, that it can sing or is yellow. Exception handling also seemed to be done at the most specific level. When subjects were asked whether an ostrich could fly, the answer was produced faster than when they were asked whether an ostrich could breathe. Thus the hierarchy ostrich → bird → animal seems not to be traversed to get the exception information: it is stored directly with ostrich. This knowledge organization has been formalized in inheritance systems.

Inheritance systems allow us to store information at the highest level of abstraction, which reduces the size of knowledge bases and helps prevent update inconsistencies. For example, if we are building a knowledge base about birds, we can define the traits common to all birds, such as flying or having feathers, for the general class bird and allow a particular species of bird to inherit these properties. This reduces the size of the knowledge base by requiring us to define these essential traits only once, rather than requiring their assertion for every individual. Inheritance also helps us to maintain the consistency of the knowledge base when adding new classes and individuals. Assume that we are adding the species robin to an existing knowledge base of birds. When we assert that robin is a subclass of songbird; robin automatically inherits all of the common properties of both songbirds and birds. It is not up to the programmer to remember (or possibly forget) to add this information.

Graphs, by providing a means of explicitly representing relations using arcs and nodes, have proved to be an ideal vehicle for formalizing associationist theories of knowledge. A *semantic network* represents knowledge as a graph, with the nodes corresponding to facts or concepts and the arcs to relations or associations between concepts. Both nodes and links are generally labeled. For example, a semantic network that defines the properties of **snow** and **ice** appears in Figure 8.2. This network could be used (with appropriate inference rules) to answer a range of questions about snow, ice, and snowmen. These inferences are made by following the appropriate links to related concepts. Semantic networks also implement inheritance; for example, **frosty** inherits all the properties of **snowmen**.

The term “semantic network” encompasses a family of graph-based representations. These representations differ chiefly in the names that are allowed for nodes and links and the inferences that may be performed on these structures. However, a common set of assumptions and concerns is shared by all network representation languages; these are

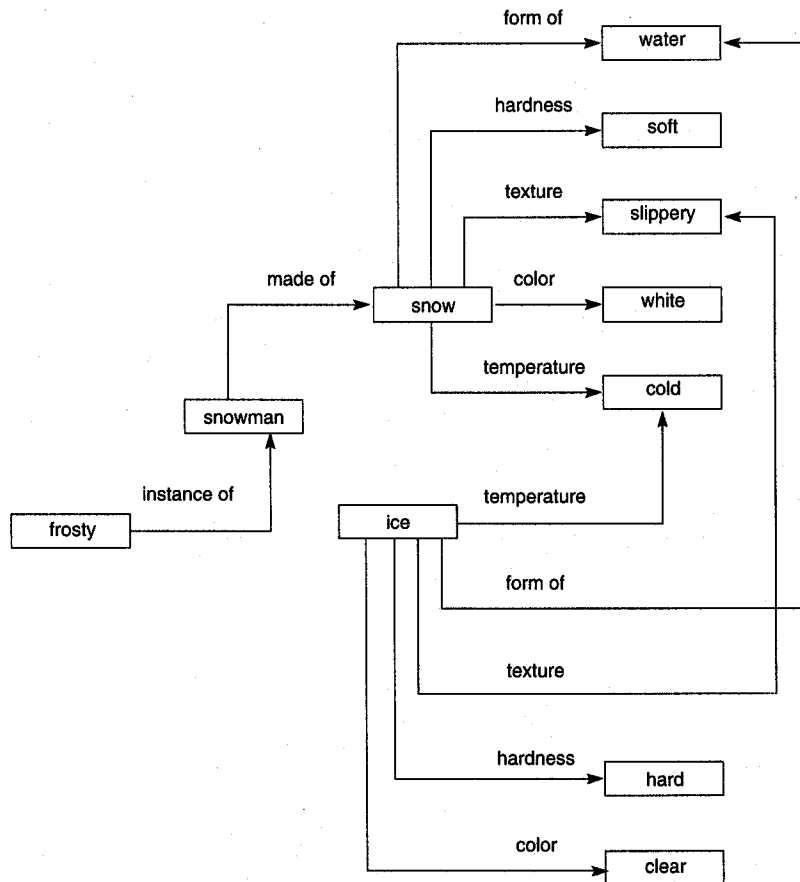

Figure 8.2 Network representation of properties of snow and ice.

illustrated by a discussion of the history of network representations. In Section 8.4 we examine *conceptual graphs* (Sowa 1984), a modern network representation language that integrates many of these ideas.

8.2.2 Early Work in Semantic Nets

Network representations have almost as long a history as logic; Frege, for example, developed a tree notation for logical expressions. Perhaps the earliest work to have a direct influence on contemporary semantic nets was Charles S. Peirce's system of existential graphs, developed in the nineteenth century (Roberts 1973). Peirce's theory had all the expressive power of first-order predicate calculus, with an axiomatic basis and formal rules of inference.

Graphs have long been used in psychology to represent structures of concepts and associations. Selz (1913, 1922) pioneered this work, using graphs to represent concept hierarchies and the inheritance of properties. He also developed a theory of schematic anticipation that influenced AI work in frames and schemata. Anderson, Norman, Rumelhart, and others have used networks to model human memory and intellectual performance (Anderson and Bower 1973, Norman et al. 1975).

Much of the research in network representations has been done in the arena of natural language understanding. In the general case, natural language understanding requires far more knowledge than the specialized domains of expert systems. It includes an understanding of commonsense, the ways in which physical objects behave, the interactions that occur between humans, and the way in which human institutions are organized. A natural language program must understand intentions, beliefs, hypothetical reasoning, plans, and goals. Because it requires such large amounts of broad-based knowledge, natural language understanding has always been a driving force for research in knowledge representation.

The first computer implementations of semantic networks were developed in the early 1960s for use in machine translation. Masterman (1961) defined a set of 100 primitive concept types and used them to define a dictionary of 15,000 concepts. Wilks (1972) continued to build on Masterman's work in semantic network-based natural language systems. Other early AI workers who explored network representations include Ceccato (1961), Raphael (1968), Reitman (1965), and Simmons (1966).

An influential program that illustrates many of the features of early semantic networks was written by Quillian in the late 1960s (Quillian 1967). This program defined English words in much the same way that a dictionary does: a word is defined in terms of other words, and the components of the definition are defined in the same fashion. Rather than formally defining words in terms of basic axioms, each definition simply leads to other definitions in an unstructured and possibly circular fashion. In looking up a word, we traverse this "network" until we are satisfied that we understand the original word.

Each node in Quillian's network corresponded to a *word concept*, with associative links to other word concepts that formed its definition. The knowledge base was organized into *planes*, where each plane was a graph that defined a single word. Figure 8.3, taken from a paper by Quillian (1967), illustrates three planes that capture three different

definitions of the word "plant:" a living organism (plant 1), a place where people work (plant 2), and the act of putting a seed in the ground (plant 3).

The program used this knowledge base to find relationships between pairs of English words. Given two words, it would search the graphs outward from each word in a breadth-first fashion, searching for a common concept or *intersection node*. The paths to this node represented a relationship between the word concepts. For example, Figure 8.4, from the same paper, shows the *intersection paths* between cry and comfort.

Using this intersection path, the program was able to conclude:

cry 2 is among other things to make a sad sound. To comfort 3 can be to make 2 something less sad (Quillian 1967).

The numbers in the response indicate that the program has selected from among different meanings of the words.

Quillian suggested that this approach to semantics might provide a natural language understanding system with the ability to:

- Plant:1) Living structure that is not an animal, frequently with leaves, getting its food from air, water, earth.
- 2) Apparatus used for any process in industry.
- 3) Put (seed, plant, etc.) in earth for growth.

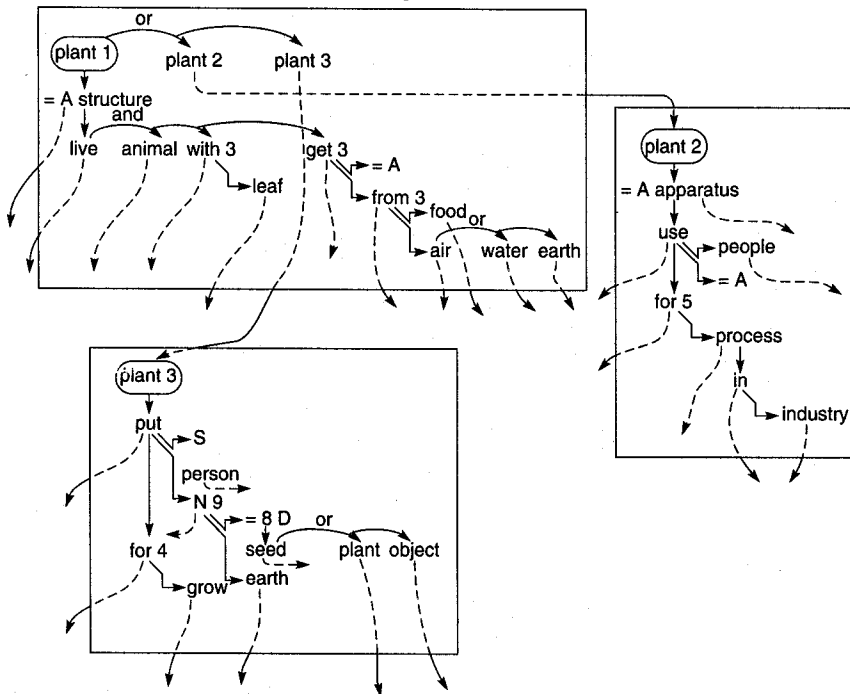

Figure 8.3 Three planes representing three definitions of the word "plant" (Quillian 1967).

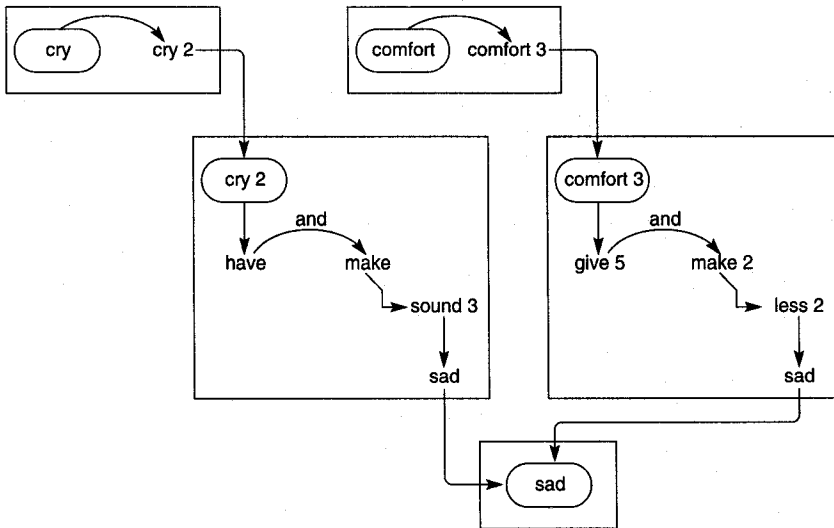

Figure 8.4 Intersection path between “cry” and “comfort” (Quillian 1967).

1. Determine the meaning of a body of English text by building up collections of these intersection nodes.
2. Choose between multiple meanings of words by finding the meanings with the shortest intersection path to other words in the sentence. For example, it could select a meaning for “plant” in “Tom went home to water his new plant” based on the intersection of the word concepts “water” and “plant.”
3. Answer a flexible range of queries based on associations between word concepts in the queries and concepts in the system.

Although this and other early work established the power of graphs to model associative meaning, it was limited by the extreme generality of the formalism. Knowledge is generally structured in terms of specific relationships such as object/property, class/sub-class, and agent/verb/object. Research in network representations has often focused on the specification of these relationships.

8.2.3 Standardization of Network Relationships

In itself, a graph notation of relationships has little advantage over predicate calculus; it is just another notation for relationships between objects. The power of network representations comes from the definition of links and associated inference rules that define a specific inference such as inheritance.

Though Quillian’s early work established most of the significant features of the semantic network formalism, such as labeled arcs and links, hierarchical inheritance, and

inferences along associational links, it proved limited in its ability to deal with the complexities of many domains. One of the main reasons for this failure was the poverty of relationships (links) that captured the deeper semantic aspects of knowledge. Most of the links represented extremely general associations between nodes and provided no real basis for the structuring of semantic relationships. The same problem is encountered in efforts to use pure predicate calculus to capture semantic meaning. Although the formalism is highly expressive and can represent literally any kind of knowledge, it is too unconstrained and places the full burden of constructing appropriate sets of facts and rules on the programmer.

Much of the work in network representations that followed Quillian's focused on defining a richer set of link labels (relationships) that would more fully model the semantics of natural language. By implementing the fundamental semantic relationships of natural language as part of the *formalism*, rather than as part of the *domain knowledge* added by the system builder, knowledge bases require less handcrafting and achieve greater generality and consistency.

Brachman (1979) has stated:

The key issue here is the isolation of the *primitives* for semantic network languages. The primitives of a network language are those things that the interpreter is programmed in advance to understand, and that are not usually represented in the network language itself.

Simmons (1973) addressed this need for standard relationships by focusing on the *case structure* of English verbs. In this verb-oriented approach, based on work by Fillmore (1968), links define the roles played by nouns and noun phrases in the action of the sentence. Case relationships include *agent*, *object*, *instrument*, *location*, and *time*. A sentence is represented as a verb node, with various case links to nodes representing other participants in the action. This structure is called a *case frame*. In parsing a sentence, the program finds the verb and retrieves the case frame for that verb from its knowledge base. It then binds the values of the agent, object, etc. to the appropriate nodes in the case frame. Using this approach, the sentence "Sarah fixed the chair with glue" might be represented by the network in Figure 8.5.

Thus, the representation language itself captures much of the deep structure of natural language, such as the relationship between a verb and its subject (the agent relation) or

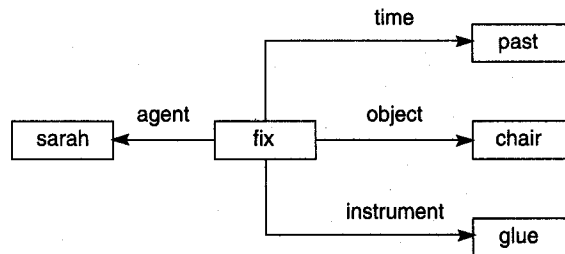

Figure 8.5 Case frame representation of the sentence "Sarah fixed the chair with glue."

that between a verb and its object. Knowledge of the case structure of the English language is part of the network formalism itself. When the individual sentence is parsed, these built-in relationships indicate that Sarah is the person doing the fixing and that glue is used to put the chair together. Note that *these linguistic relationships are stored in a fashion that is independent of the actual sentence or even the language in which the sentence was expressed*. A similar approach is also taken in network languages proposed by Norman (1972) and Rumelhart et al. (1972, 1973).

A number of major research endeavors attempted to standardize link names even further (Masterman 1961, Wilks 1972, Schank and Colby 1973, Schank and Nash-Webber 1975). Each effort worked to establish a complete set of primitives that could be used to represent the semantic structure of natural language expressions in a uniform fashion. These were intended to assist in reasoning with language constructs and to be independent of the idiosyncrasies of individual languages or phrasing.

Perhaps the most ambitious attempt to model formally the deep semantic structure of natural language is Roger Schank's *conceptual dependency* theory (Schank and Rieger 1974). Conceptual dependency theory offers a set of four primitive conceptualizations from which the world of meaning is built. These are equal and independent. They are:

ACTs	actions
PPs	objects (picture producers)
AAs	modifiers of actions (action aiders)
PAs	modifiers of objects (picture aiders)

For example, all actions are assumed to reduce to one or more of the primitive ACTs. These primitives, listed below, are taken as the basic components of action, with more specific verbs being formed through their modification and combination.

ATRANS	transfer a relationship (give)
PTRANS	transfer physical location of an object (go)
PROPEL	apply physical force to an object (push)
MOVE	move body part by owner (kick)
GRASP	grab an object by an actor (grasp)
INGEST	ingest an object by an animal (eat)
EXPEL	expel from an animal's body (cry)
MTRANS	transfer mental information (tell)
MBUILD	mentally make new information (decide)
CONC	conceptualize or think about an idea (think)
SPEAK	produce sound (say)
ATTEND	focus sense organ (listen)

These primitives are used to define *conceptual dependency relationships* that describe meaning structures such as case relations or the association of objects and values. Conceptual dependency relationships are *conceptual syntax rules* and constitute a grammar of meaningful semantic relationships. These relationships can be used to construct an internal representation of an English sentence. A list of basic conceptual

dependencies (Schank and Rieger 1974) appears in Figure 8.6. These capture the fundamental semantic structures of natural language. For example, the first conceptual dependency in Figure 8.6 describes the relationship between a subject and its verb, and the third describes the verb-object relation. These can be combined to represent a simple transitive sentence such as “John throws the ball” (see Figure 8.7).

Finally, tense and mode information must be added to the conceptualizations. Schank supplies a list of attachments or modifiers to the relationships. A partial list of these is:

p	past
f	future
t	transition
k	continuing
t _s	start transition
?	interrogative
t _f	finish transition
c	conditional
/	negative
nil	present
delta?	timeless

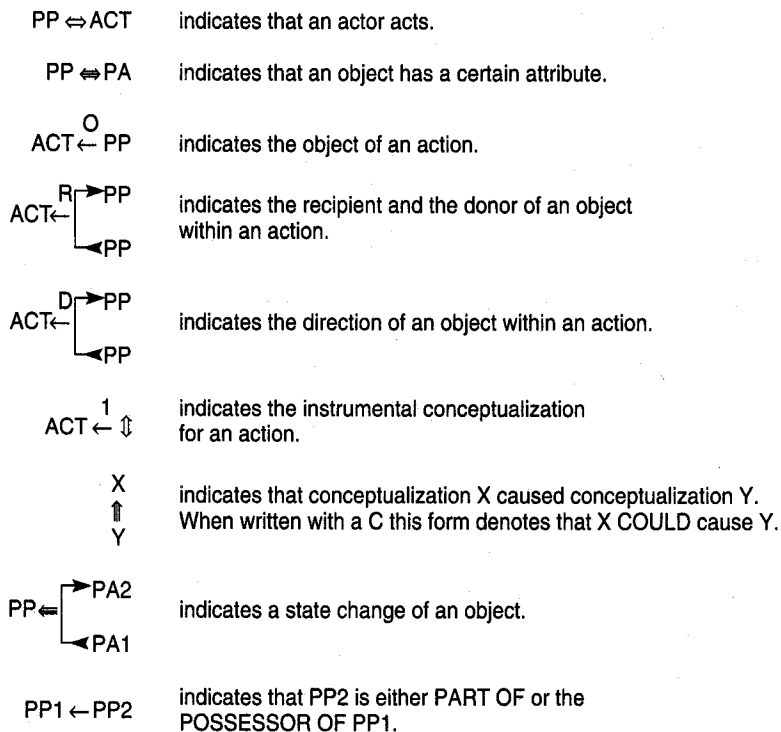

Figure 8.6 Conceptual dependencies (Schank and Rieger 1974).



Figure 8.7 Conceptual dependency representation of the sentence "John throws the ball."

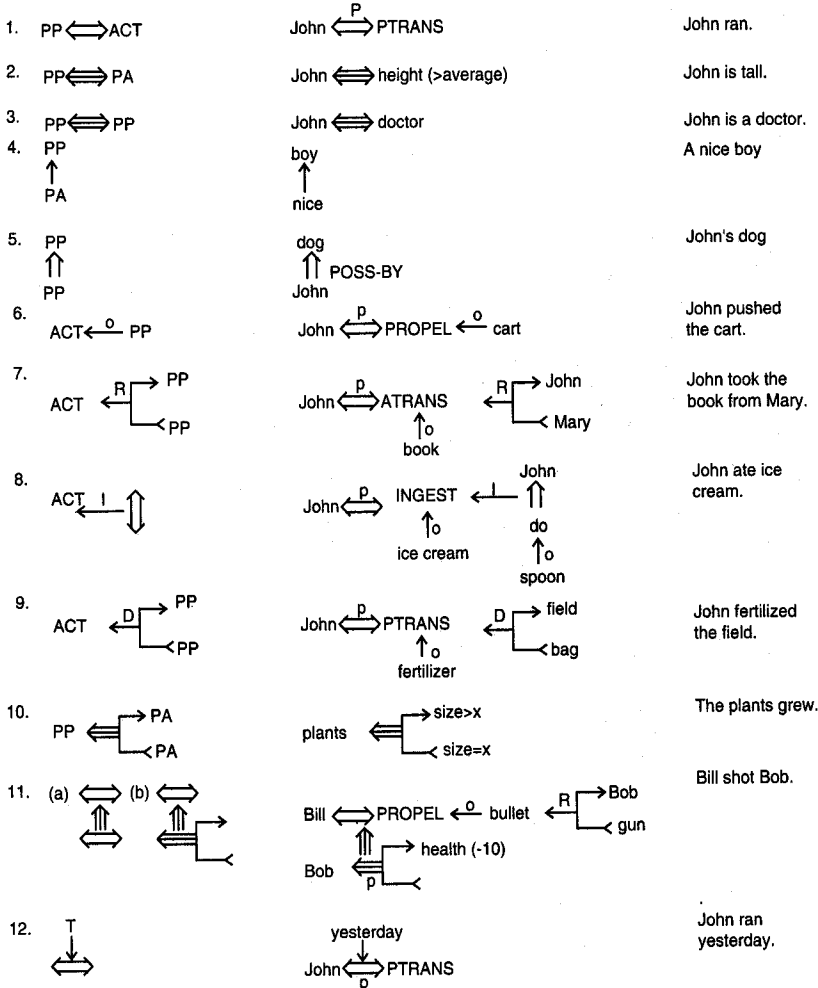

Figure 8.8 Some basic conceptual dependencies and their use in representing more complex English sentences, adapted from Rich and Knight (1991).

These relations are the first-level constructs of the theory, the simplest semantic relationships out of which more complex structures can be built. Further examples of how these basic conceptual dependencies can be composed to represent the meaning of simple English sentences appear in Figure 8.8.

Based on these primitives, the English sentence “John ate the egg” is represented as shown in Figure 8.9, where the symbols have the following meanings:

←	indicates the direction of dependency
⇒	indicates the agent–verb relationship
p	indicates past tense
INGEST	is a primitive act of the theory
O	object relation
D	indicates the direction of the object in the action

Another example of the structures that can be built using conceptual dependencies is the representation graph for “John prevented Mary from giving a book to Bill” (Figure 8.10). This particular example is interesting because it demonstrates how causality can be represented.

Conceptual dependency theory offers a number of important benefits. By providing a formal theory of natural language semantics, it reduces problems of ambiguity. Second, the representation itself directly captures much of natural language semantics, by attempting to provide a *canonical form* for the meaning of sentences. That is, all sentences that have the same meaning will be represented internally by *syntactically identical*, not just semantically equivalent, graphs. This canonical representation is an effort to simplify the inferences required for understanding. For example, we can demonstrate that two sentences mean the same thing with a simple match of conceptual dependency graphs; a representation that did not provide a canonical form might require extensive operations on differently structured graphs.

Unfortunately, it is questionable whether a program may be written to reliably reduce sentences to canonical form. As Woods (1985) and others have pointed out, reduction to a canonical form is provably uncomputable for monoids, a type of algebraic group that is far simpler than natural language. Furthermore, there is no evidence that humans store their knowledge in any sort of canonical form.

Other criticisms of this point of view object to the computational price paid in reducing everything to such low-level primitives. Besides this, the primitives themselves are not adequate to capture many of the more subtle concepts that are important in natural language use. For example, the representation of “tall” in the second sentence of Figure 8.8 does not address the ambiguity of this term as carefully as is done in systems such as fuzzy logic (Zadeh 1983 and Section 7.3).

However, no one can say that the conceptual dependency model has not been fully automated and tested. More than a decade of research guided by Schank has focused on refining and extending the model. Important extensions of conceptual dependencies include research in *scripts* and *memory organization packets*, or MOPs. The research in scripts examines the organization of knowledge in memory and the role this organization plays in reasoning, see Section 8.4.2. MOPs provided one of the supporting research areas for the design of case-based reasoners, Section 6.4. Conceptual dependency theory is a fully developed model of natural language semantics with consistency of purpose and wide applicability.

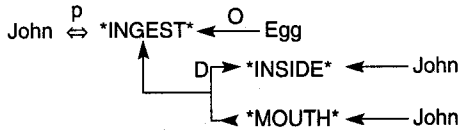

Figure 8.9 Conceptual dependency representing “John ate the egg” (Schank and Rieger 1974).

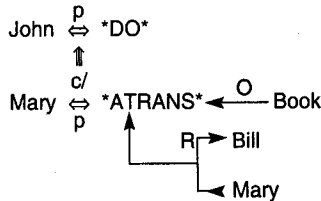

Figure 8.10 Conceptual dependency representation of the sentence “John prevented Mary from giving a book to Bill” (Schank and Rieger 1974).

8.3 Conceptual Graphs: A Network Representation Language

A number of network languages have been developed to model the semantics of natural language and other domains. In this section, we examine a particular language in detail, to show how the problems of representing meaning have been addressed. John Sowa’s *conceptual graphs* (Sowa 1984) is an example of a modern network representation language. We define the rules for forming and manipulating conceptual graphs and the conventions for representing classes, individuals, and relationships. In Chapter 11 we continue developing this formalism and show how it may be used to represent meaning in natural language understanding.

8.3.1 Introduction to Conceptual Graphs

A conceptual graph is a finite, connected, bipartite graph. The nodes of the graph are either *concepts* or *conceptual relations*. Conceptual graphs do not use labeled arcs; instead the conceptual relation nodes represent relations between concepts. Because conceptual graphs are bipartite, concepts can only have arcs to conceptual relations, and vice versa. In Figure 8.11 dog and brown are concept nodes and color is a conceptual relation. To distinguish these types of nodes, we represent concepts as boxes and conceptual relations as ellipses.

In conceptual graphs, concept nodes represent either concrete or abstract objects in the world of discourse. Concrete concepts, such as a cat, telephone, or restaurant, are characterized by our ability to form an image of them in our minds. Note that concrete concepts include generic concepts such as cat or restaurant along with concepts of specific cats and restaurants. We can still form an image of a generic cat. Abstract concepts include things such as love, beauty, and loyalty that do not correspond to images in our minds.

Conceptual relation nodes indicate a relation involving one or more concepts. One advantage of formulating conceptual graphs as bipartite graphs rather than using labeled arcs is that it simplifies the representation of relations of any arity. A relation of arity n is represented by a conceptual relation node having n arcs. Figure 8.11 illustrates conceptual relations of different arities.

Each conceptual graph represents a single proposition. A typical knowledge base will contain a number of such graphs. Graphs may be arbitrarily complex but must be finite.

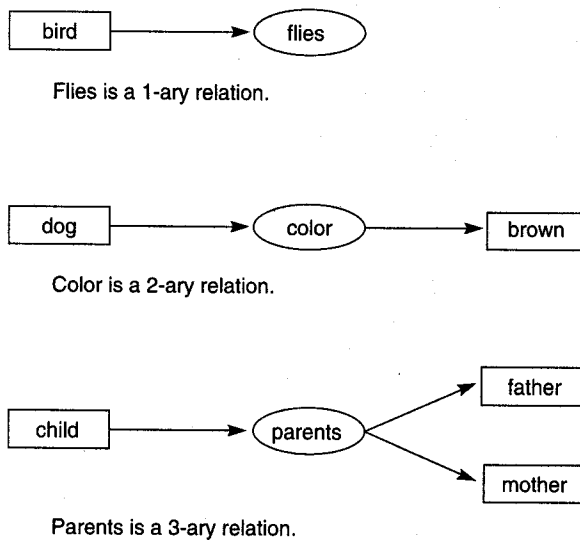

Figure 8.11 Conceptual relations of different arities.

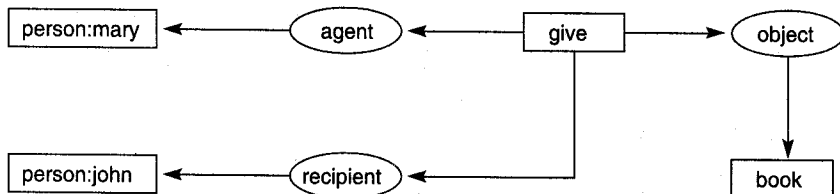

Figure 8.12 Conceptual graph of the sentence "Mary gave John the book."

For example, one graph in Figure 8.11 represents the proposition “A dog has a color of brown.” Figure 8.12 is a graph of somewhat greater complexity that represents the sentence “Mary gave John the book.” This graph uses conceptual relations to represent the cases of the verb “to give” and indicates the way in which conceptual graphs are used to model the semantics of natural language.

8.3.2 Types, Individuals, and Names

Many early designers of semantic networks were careless in defining class/member and class/subclass relationships, with resulting semantic confusion. For example, the relation between an individual and its class is different from the relation between a class (such as dog) and its superclass (carnivore). Similarly, certain properties belong to individuals, and others belong to the class itself; the representation should provide a vehicle for making this distinction. The properties of having fur and liking bones belong to individual dogs; the class “dog” does not have fur or eat anything. Properties that are appropriate to the class include its name and membership in a zoological taxonomy.

In conceptual graphs, every concept is a unique individual of a particular type. Each concept box is labeled with a *type* label, which indicates the class or type of individual represented by that node. Thus, a node labeled **dog** represents some individual of that type. Types are organized into a hierarchy. The type **dog** is a subtype of **carnivore**, which is a subtype of **mammal**, etc. Boxes with the same type label represent concepts of the same type; however, these boxes may or may not represent the same individual concept.

Each concept box is labeled with the names of the type and the individual. The type and individual labels are separated by a colon, “:”. The graph of Figure 8.13 indicates that the dog “Emma” is brown. The graph of Figure 8.11 asserts that some unspecified entity of type **dog** has a color of **brown**. If the individual is not indicated, the concept represents an unspecified individual of that type.

Conceptual graphs also let us indicate specific but unnamed individuals. A unique token called a *marker* indicates each individual in the world of discourse. This marker is written as a number preceded by a #. Markers are different from names in that they are unique: individuals may have one name, many names, or no name at all, but they have exactly one marker. Similarly, different individuals may have the same name but may not have the same marker. This distinction gives us a basis for dealing with the semantic ambiguities that arise when we give objects names. The graph of Figure 8.14 asserts that a particular **dog**, #1352, is **brown**.

Markers allow us to separate an individual from its name. If dog #1352 is named “Emma,” we can use a conceptual relation called **name** to add this to the graph. The result is the graph of Figure 8.15. The name is enclosed in double quotes to indicate that it is a string. Where there is no danger of ambiguity, we may simplify the graph and refer to the individual directly by name. Under this convention, the graph of Figure 8.15 is equivalent to the graph of Figure 8.13.

Although we frequently ignore it both in casual conversation and in formal representations, this distinction between an individual and its name is an important one that should be supported by a representation language. For example, if we say that “John”

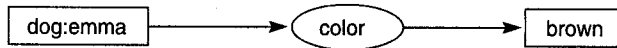

Figure 8.13 Conceptual graph indicating that the dog named **emma** is brown.

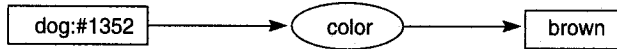

Figure 8.14 Conceptual graph indicating that a particular (but unnamed) dog is brown.

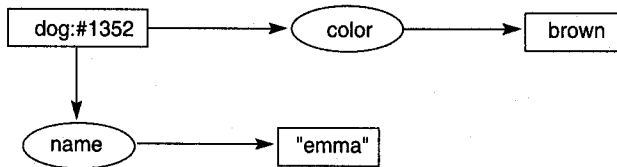

Figure 8.15 Conceptual graph indicating that a dog named **emma** is brown.

is a common name among males, we are asserting a property of the name itself rather than of any individual named “John.” This allows us to represent such English sentences as “‘Chimpanzee’ is the name of a species of primates.” Similarly, we may want to represent the fact that an individual has several different names. The graph of Figure 8.16 represents the situation described in the song lyric: “Her name was McGill and she called herself Lil, but everyone knew her as Nancy” (Lennon and McCartney 1968).

In addition to indicating an individual by its marker or name, we can use the generic marker * to indicate an unspecified individual. By convention, this is often omitted from concept labels; a node given just a type label, **dog**, is equivalent to a node labeled **dog:***. In addition to the generic marker, conceptual graphs allow the use of named variables. These are represented by an asterisk followed by the variable name (e.g., *X or *foo). This is useful if two separate nodes are to indicate the same, but unspecified, individual. The graph of Figure 8.17 represents the assertion “The dog scratches its ear with its paw.” Although we do not know which dog is scratching its ear, the variable *X indicates that the paw and the ear belong to the same dog that is doing the scratching.

To summarize, each concept node indicates an individual of a specified type. This individual is the *referent* of the concept and is indicated by either an individual marker or the generic marker. If it is an individual marker, the concept is an *individual concept*. If the referent is the generic marker, then the concept is a *generic concept*.

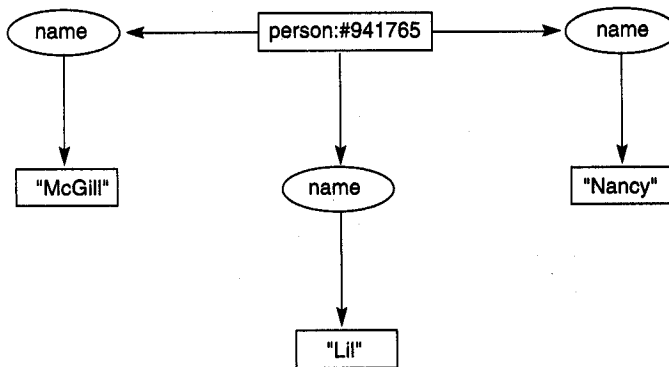

Figure 8.16 Conceptual graph of a person with three names.

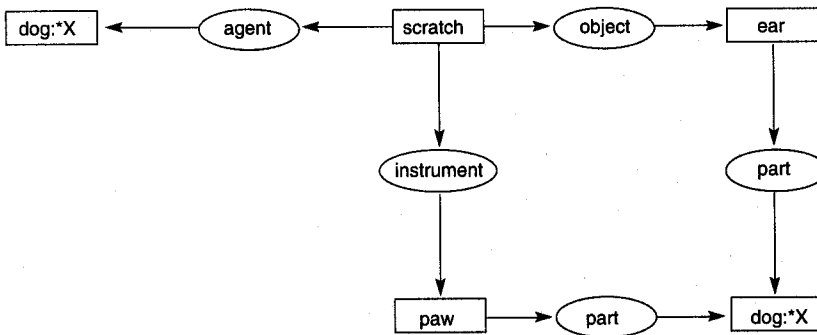

Figure 8.17 Conceptual graph of the sentence "The dog scratches its ear with its paw."

8.3.3 The Type Hierarchy

The type hierarchy, as illustrated by Figure 8.18, is a partial ordering on the set of types, indicated by the symbol \leq . If s and t are types and $t \leq s$, then t is said to be a *subtype* of s and s is said to be a *supertype* of t . Because it is a partial ordering, a type may have more than one supertype and more than one subtype. If s , t , and u are types, with $t \leq s$ and $t \leq u$, then t is said to be a *common subtype* of s and u . Similarly, if $s \leq v$ and $u \leq v$ then v is a *common supertype* of s and u .

The type hierarchy of conceptual graphs is a lattice, a common form of multiple inheritance system. In a lattice, types may have multiple parents and children. However, every pair of types must have a *minimal common supertype* and a *maximal common subtype*. For types s and u , v is a minimal common supertype if $s \leq v$, $u \leq v$, and for any w , a common supertype of s and u , $v \leq w$. Maximal common subtype has a corresponding

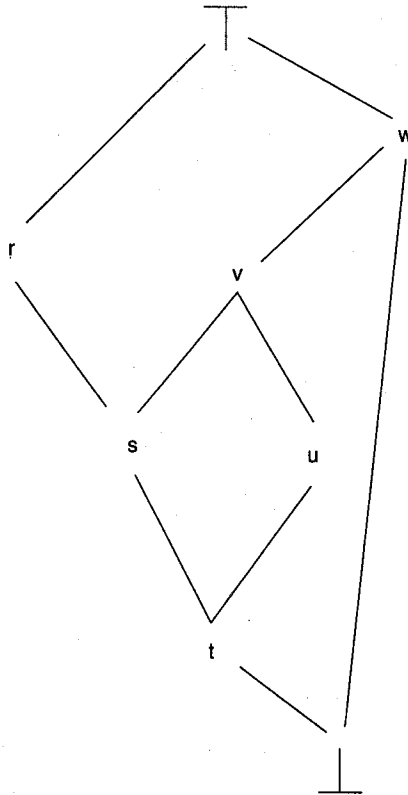

Figure 8.18 A type lattice illustrating subtypes, supertypes, the universal type, and the absurd type. Arcs represent the relationship.

definition. The minimal common supertype of a collection of types is the appropriate place to define properties common only to those types. Because many types, such as *emotion* and *rock*, have no obvious common supertypes or subtypes, it is necessary to add types that fill these roles. To make the type hierarchy a true lattice, conceptual graphs include two special types. The *universal type*, indicated by T , is a supertype of all types. The *absurd type*, indicated by \perp , is a subtype of all types.

8.3.4 Generalization and Specialization

The theory of conceptual graphs includes a number of operations that allow us to form new graphs from existing graphs. These allow for the creation of a new graph by either *specializing* or *generalizing* an existing graph. This is done through four operations called *copy*, *restrict*, *join*, and *simplify*, as seen in Figure 8.19. Assume that g_1 and g_2 are conceptual graphs. Then:

The *copy* rule allows us to form a new graph, g , that is the exact copy of g_1 .

Restriction allows concept nodes in a graph to be replaced by a node representing their specialization. There are two cases:

1. If a concept is labeled with a generic marker, the generic marker may be replaced by an individual marker.
2. A type label on a concept may be replaced by one of its subtypes, as long as this is consistent with the referent of the concept. In Figure 8.19 we can replace animal with dog because Emma is a dog.

The *join* rule lets us combine two graphs into a single graph. If there is a concept node C_1 in the graph S_1 that is identical to a concept node C_2 in S_2 , then we can form a new graph by deleting C_2 and linking all of the relations incident on C_2 to C_1 . Join is a restriction rule, because the resulting graph is less general than either of its components.

If a graph contains two duplicate relations, then one of them may be deleted, along with all its arcs. This is the *simplify* rule. Duplicate relations often occur as the result of a join operation, as in graph g_4 of Figure 8.19.

One use of restriction rules is to make two concepts match so that a join can be performed. Together, join and restrict allow the implementation of inheritance. For example, the replacement of a generic marker by an individual implements the inheritance of the properties of a type by an individual. The replacement of a type label by a subtype label defines inheritance between a class and a superclass. By joining one graph to another and restricting certain concept nodes, we can implement inheritance of a variety of properties. Figure 8.20 shows how chimpanzees inherit the property of having a hand from the class primates by replacing a type label with its subtype. It also shows how the individual, **BONZO**, inherits this property by instantiating a generic concept.

Similarly, we can use joins and restrictions to implement the plausible assumptions that play a role in common language understanding. If we are told that "Mary and Tom went out for pizza together," we automatically make a number of assumptions: they ate a round Italian bread covered with cheese and tomato sauce. They ate it in a restaurant and must have had some way of paying for it. This reasoning can be done using joins and restrictions. We form a conceptual graph of the sentence and join it with the conceptual graphs (from our knowledge base) for pizzas and restaurants. The resulting graph lets us assume that they ate tomato sauce and paid their bill.

Join and restrict are specialization rules. They define a partial ordering on the set of derivable graphs. If a graph g_1 is a specialization of g_2 , then we may say that g_2 is a generalization of g_1 . Generalization hierarchies are important in knowledge representation. Besides providing the basis for inheritance and other commonsense reasoning schemes, generalization hierarchies are used in many learning methods, allowing us, for instance, to construct a generalized assertion from a particular training instance.

These rules are not rules of inference. They do not guarantee that true graphs will be derived from true graphs. For example, in the restriction of the graph of Figure 8.19, the result may not be true; Emma may be a cat. Similarly, the join example of Figure 8.19 is

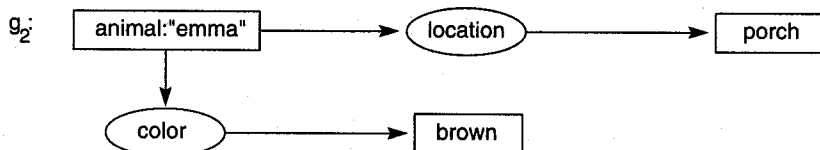
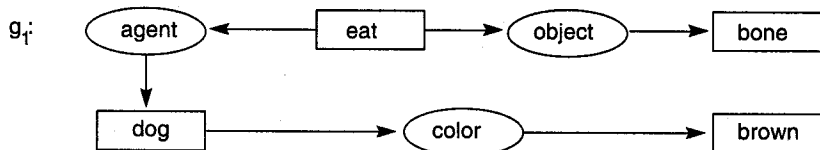

The restriction of g_2 :

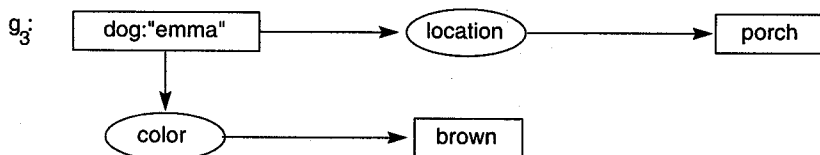

The join of g_1 and g_3 :

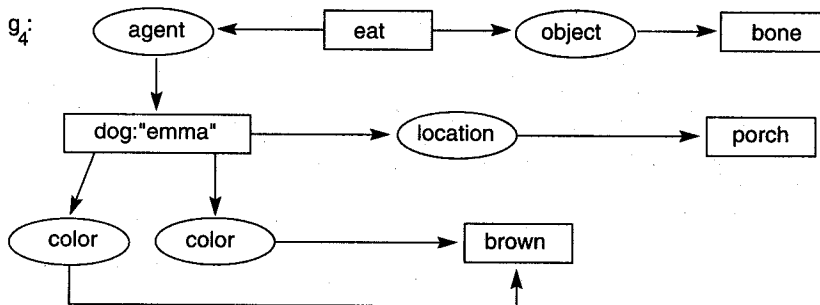

The simplify of g_4 :

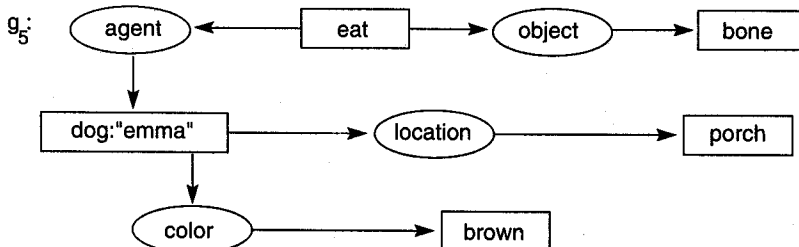

Figure 8.19 Examples of restrict, join, and simplify operations.

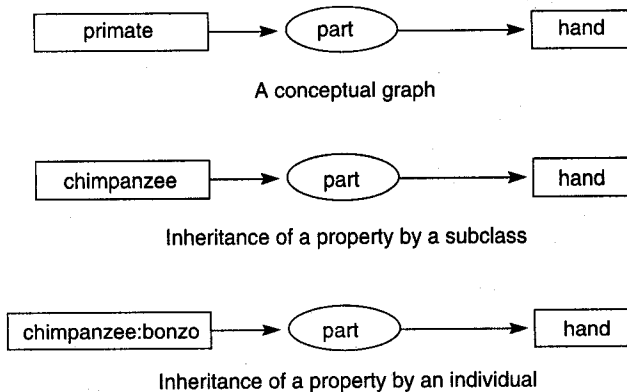

Figure 8.20 Inheritance in conceptual graphs.

not truth-preserving either: the dog on the porch and the dog that eats bones may be different animals. These operations are *canonical formation rules*, and although they do not preserve truth, they have the subtle but important property of preserving “meaningfulness.” This is an important guarantee when we use conceptual graphs to implement natural language understanding. Consider the three sentences:

Albert Einstein formulated the theory of relativity.

Albert Einstein plays center for the Los Angeles Lakers.

Conceptual graphs are yellow flying popsicles.

The first of these sentences is true and the second is false. The third sentence, however, is meaningless; though grammatically correct, it makes no sense. The second sentence, although false, is meaningful. I can imagine Albert Einstein on a basketball court. The canonical formation rules enforce constraints on meaningfulness; they do not allow us to form nonsensical graphs from meaningful ones. Although they are not sound inference rules, canonical formation rules form a basis for much of the plausible reasoning done in natural language understanding and common sense reasoning; see Chapter 11.

8.3.5 Propositional Nodes

In addition to using graphs to define relations between objects in the world, we may also want to define relations between propositions. Consider, for example, the statement “Tom believes that Jane likes pizza.” “Believes” is a relation that takes a proposition as its argument.

Conceptual graphs include a concept type, *proposition*, that takes a set of conceptual graphs as its referent and allows us to define relations involving propositions. Propositional concepts are indicated as a box that contains another conceptual graph. These proposition concepts may be used with appropriate relations to represent knowledge

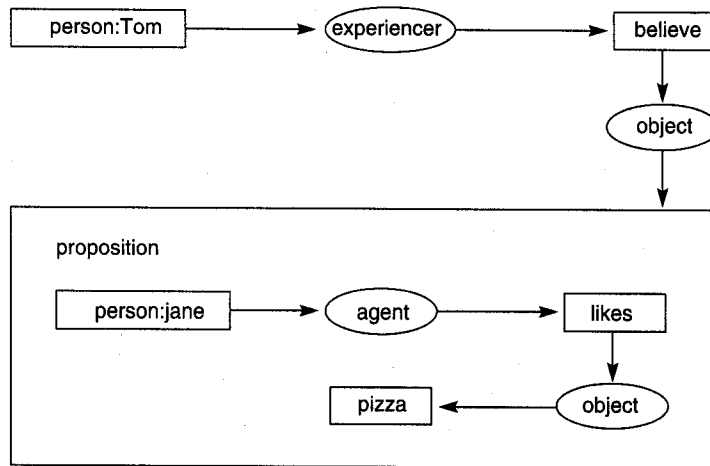

Figure 8.21 Conceptual graph of the statement “Tom believes that Jane likes pizza,” showing the use of a propositional concept.

about propositions. Figure 8.21 shows the conceptual graph for the above assertion about Jane, Tom, and pizza. The **experiencer** relation is loosely analogous to the **agent** relation in that it links a subject and the verb. The **experiencer** link is used with belief states based on the notion that they are something one experiences rather than does.

Figure 8.21 shows how conceptual graphs with propositional nodes may be used to express the *modal* concepts of knowledge and belief. *Modal logics* are concerned with the various ways propositions are entertained: believed, asserted as possible, probably or necessarily true, intended as a result of an action, or counterfactual (Turner 1984).

8.3.6 Conceptual Graphs and Logic

Using conceptual graphs, we can easily represent conjunctive concepts such as “The dog is big and hungry,” but we have not established any way of representing negation or disjunction. Nor have we addressed the issue of variable quantification.

We may implement negation using propositional concepts and a unary operation called **neg**. **neg** takes as argument a proposition concept and asserts that concept as false. The graph of Figure 8.22 uses **neg** to represent the statement “There are no pink dogs.”

Using negation and conjunction, we may form graphs that represent disjunctive assertions according to the rules of logic. To simplify this, we may also define a relation **or**, which takes two propositions and represents their disjunction.

In conceptual graphs, generic concepts are assumed to be existentially quantified. For example, the generic concept **dog** in the graph of Figure 8.11 actually represents an existentially quantified variable. This graph corresponds to the logical expression:

$$\exists X \exists Y (\text{dog}(X) \wedge \text{color}(X, Y) \wedge \text{brown}(Y)).$$

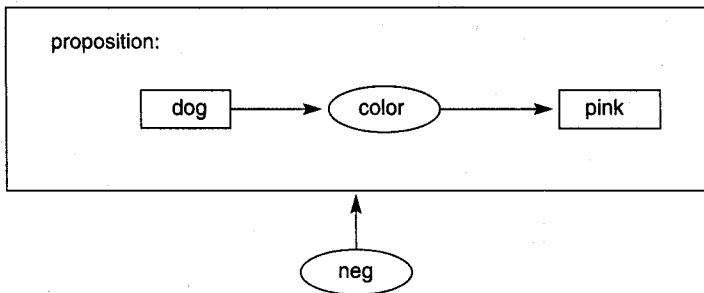

Figure 8.22 Conceptual graph of the proposition "There are no pink dogs."

Using negation and existential quantification, we can also represent universal quantification. For example, the graph of Figure 8.22 could be thought of as representing the logical assertion:

$$\forall X \forall Y (\neg (\text{dog}(X) \wedge \text{color}(X,Y) \wedge \text{pink}(Y))).$$

Conceptual graphs are equivalent to predicate calculus in their expressive power. As these examples suggest, there is a straightforward mapping from conceptual graphs into predicate calculus notation. The algorithm for changing a conceptual graph, g , into a predicate calculus expression is:

1. Assign a unique variable, x_1, x_2, \dots, x_n , to each of the n generic concepts in g .
2. Assign a unique constant to each individual concept in g . This constant may simply be the name or marker used to indicate the referent of the concept.
3. Represent each concept node by a unary predicate with the same name as the type of that node and whose argument is the variable or constant assigned to that node.
4. Represent each n -ary conceptual relation in g as an n -ary predicate whose name is the same as the relation. Let each argument of the predicate be the variable or constant assigned to the corresponding concept node linked to that relation.
5. Take the conjunction of all atomic sentences formed under 3 and 4. This is the body of the predicate calculus expression. All the variables in the expression are existentially quantified.

For example, the graph of Figure 8.13 is given by the predicate calculus expression

$$\exists X_1 (\text{dog}(\text{emma}) \wedge \text{color}(\text{emma}, X_1) \wedge \text{brown}(X_1))$$

Although we can reformulate conceptual graphs into predicate calculus syntax, conceptual graphs support a number of special-purpose inferencing mechanisms, such as join and restrict, not normally part of the predicate calculus.

We have presented the syntax of conceptual graphs and defined the *restriction* operation as a means of implementing inheritance. We have not yet examined the full range of operations and inferences that may be performed on these graphs, nor have we addressed the problem of defining the concepts and relations needed for domains such as natural language. We address these issues in Chapter 11 and use the resulting language to implement a knowledge base for a simple natural language understanding program.

8.4 Structured Representations

8.4.1 Frames

Using network representations, we view knowledge as organized using explicit links or associations between objects in the knowledge base. Alternatively, we can organize knowledge into more complex units that represent situations or objects in the domain. These units are called *frames* or *schemas*.

In a 1975 paper, Minsky describes a frame:

Here is the essence of the frame theory: When one encounters a new situation (or makes a substantial change in one's view of a problem) one selects from memory a structure called a "frame." This is a remembered framework to be adapted to fit reality by changing details as necessary (Minsky 1975).

According to Minsky, a frame may be viewed as a static data structure used to represent well-understood stereotyped situations. Framelike structures seem to organize our own knowledge of the world. We adjust to ever new situations by calling up information structured by past experiences. We then specially fashion or revise the details of these past experiences to represent the individual differences for the new situation.

Anyone who has stayed in one or two hotel rooms has no trouble with entirely new hotels and their rooms. One expects to see a bed, a bathroom, a place to open a suitcase, a telephone, price and emergency evacuation information on the back of the door, and so on. The details of each room can be supplied when needed: color of the curtains, location and use of light switches, etc. There is also default information supplied with the hotel room frame: no sheets; call housekeeping; need ice: look down the hall; and so on. We do not need to build up our understanding for each new hotel room we enter. All of the pieces of a generic hotel room are organized into a conceptual structure that we access when checking into a hotel; the particulars of an individual room are supplied as needed.

We could represent these higher-level structures directly in a semantic network by organizing it as a collection of separate networks, each of which represents some stereotypic situation. Frames, as well as *object-oriented systems*, provide us with a vehicle for this organization, representing knowledge as structured objects consisting of named slots with attached values. The notion of a frame or schema as a single complex entity is thus reinforced by the notation.

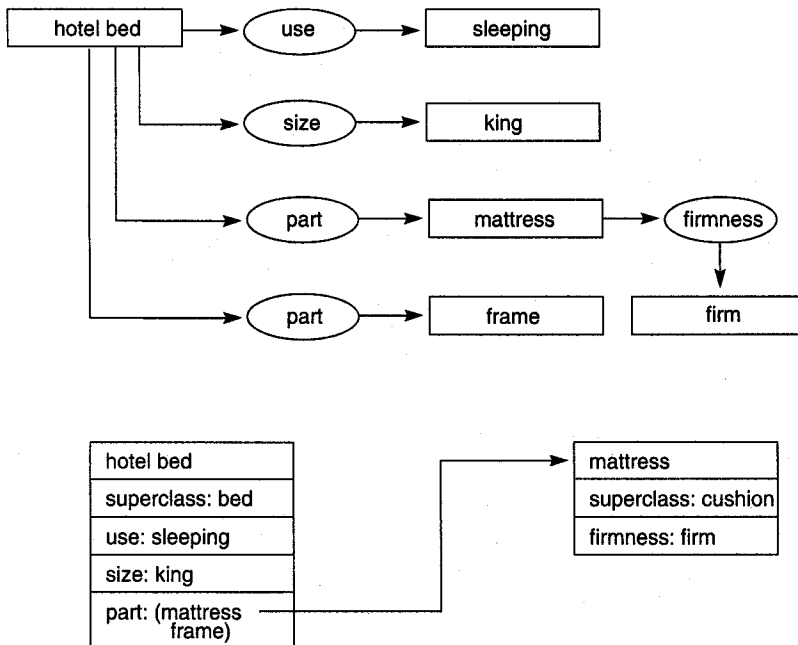

Figure 8.23 Conceptual graph and frame descriptions of a hotel bed.

Figure 8.23 shows how a hotel bed may be represented using both conceptual graph and frame approaches. A hotel bed is a specialization of the general bed object. Many of the values in both versions are default assumptions about hotel beds. These include the **size** and **firmness** relations. Specific instances of hotel beds may or may not inherit these values. See Section 8.5 for a more detailed discussion of the inheritance and default knowledge. The slot names in the frame loosely correspond to the relations in the conceptual graph. The slot values may be values; pointers to other frames, as in the case of the mattress, or even attached procedures for performing some function, such as getting the bed made.

The components of a hotel room can be described by a number of individual frames. In addition to the bed, a frame could represent a chair: expected height is 20 to 40 cm, number of legs is 4, a default value, is designed for sitting. A further frame represents the hotel telephone: this is a specialization of a regular phone except that billing is through the room, there is a special hotel operator (by default), and a person is able to use the hotel phone to get meals served in the room and other services. Figure 8.24 gives a frame representing the hotel room.

Each individual frame may be seen as a data structure, similar in many respects to the traditional “record,” that contains information relevant to stereotyped entities. The slots in the frame contain information such as:

1. *Frame identification information.*

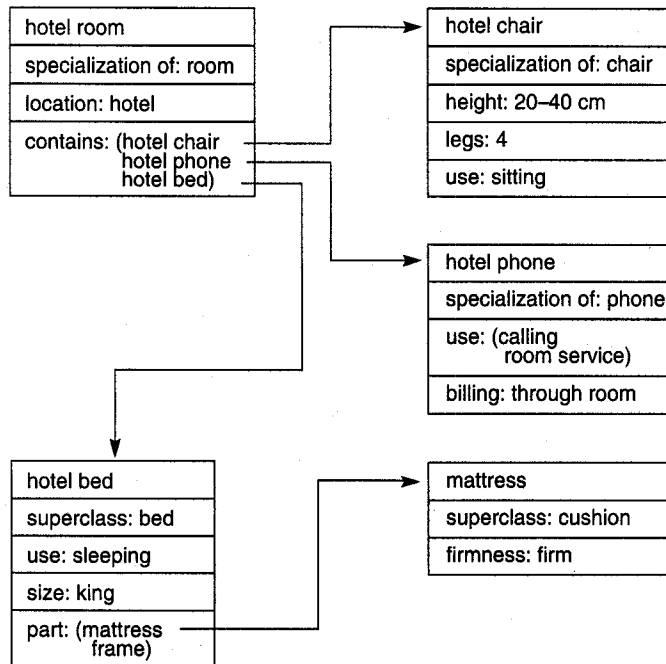

Figure 8.24 Portion of the frame description of a hotel room.

2. *Relationship of this frame to other frames.* The “hotel phone” might be a special instance of “phone,” which in turn might be an instance of a “communication device.”
3. *Descriptors of requirements for frame match.* A chair, for instance, has its seat between 20 and 40 cm from the floor, its back higher than 60 cm, etc. These requirements may be used to determine when new objects fit the stereotype defined by the frame.
4. *Procedural information on use of the structure described.* An important feature of frames is the ability to attach procedural code to a slot.
5. *Frame default information.* These are slot values that are taken to be true when no evidence to the contrary has been found. For instance, chairs have four legs, telephones are pushbutton, or hotel beds are made by the staff.
6. *New instance information.* Many frame slots may be left unspecified until given a value for a particular instance or when they are needed for some aspect of problem solving. For example, the color of the bedspread may be left unspecified in the definition of bed.

The presence, absence, or amount of detail in each of the six slots above depend on the particular problem-solving situation addressed.

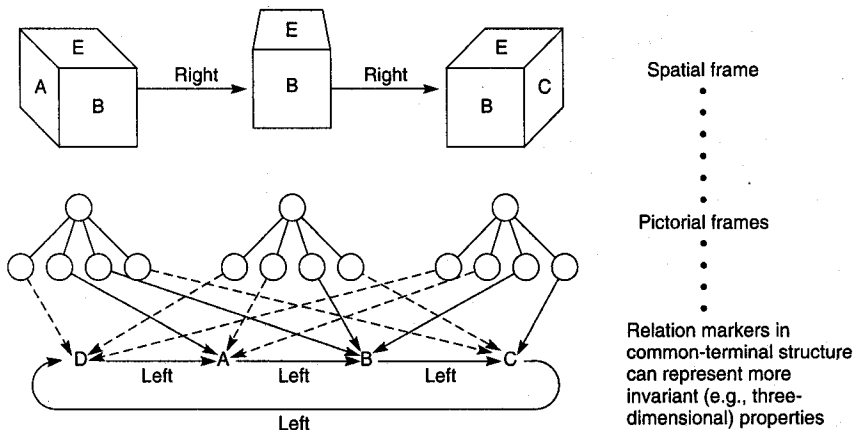

Figure 8.25 Spatial frame for viewing a cube (Minsky 1975).

Frames extend semantic networks in a number of important ways. Although the frame and network descriptions of hotel beds in Figure 8.23 are equivalent, the frame version makes it much clearer that we are describing a bed with its various attributes. In the network version, there is simply a collection of nodes and we depend more on our interpretation of the structure to see the hotel bed as the primary object being described. This ability to organize our knowledge into such structures is an important attribute of a knowledge base.

Frames make it easier to organize our knowledge hierarchically. In a network, every concept is represented by nodes and links at the same level of specification. Very often, however, we may like to think of an object as a single entity for some purposes and only consider details of its internal structure for other purposes. For example, we usually are not aware of the mechanical organization of a car until something breaks down; only then do we pull up our “car engine schema” and try to find the problem.

Procedural attachment is a particularly important feature of frames because certain knowledge does not adapt well to declarative representations. For example, we may want to include the ability to generate graphic images in a knowledge base. A graphics language is more appropriate for this than a network language. We use procedural attachment to create *demons*. A demon is a procedure that is invoked as a side effect of some other action in the knowledge base. For example, we may wish the system to perform type checks or to run consistency tests whenever a certain slot value is changed.

Frame systems support class inheritance. The slots and default values of a class frame are inherited across the class/subclass and class/member hierarchy. For instance, a hotel phone could be a subclass of a regular phone except that (1) all out-of-building dialing goes through the hotel switchboard (for billing) and (2) hotel services may be dialed directly. Default values are assigned to selected slots to be used only if other information is not available: assume that hotel rooms have beds and are, therefore, appropriate places to go if you want to sleep; if you don’t know how to dial the hotel front desk try “zero;” the phone may be assumed (no evidence to the contrary) to be pushbutton.

When an instance of the class frame is created, the system will attempt to fill its slots, either by querying the user, accepting the default value from the class frame, or executing some procedure or demon to obtain the instance value. As with semantic nets, slots and default values are inherited across a class/subclass hierarchy. Of course, default information can cause the data description of the problem to be nonmonotonic, letting us make assumptions about default values that may not always prove correct.

Minsky's own work on vision provides an example of frames and their use in default reasoning: the problem of recognizing that different views of an object actually represent the same object. For example, the three perspectives of the one cube of Figure 8.25 actually look quite different. Minsky (1975) proposed a frame system that recognizes these as views of a single object by inferring the hidden sides as default assumptions.

The frame system of Figure 8.25 represents four of the faces of a cube. The broken lines indicate that a particular face is out of view from that perspective. The links between the frames indicate the relations between the views represented by the frames. The nodes, of course, could be more complex if there were colors or patterns that the faces contained. Indeed, each slot in one frame could be a pointer to another entire frame. Also, because given information can fill a number of different slots (face E in Figure 8.25), there need be no redundancy in the information that is stored.

Frames add to the power of semantic nets by allowing complex objects to be represented as a single frame, rather than as a large network structure. This also provides a natural way to represent stereotypic entities, classes, inheritance, and default values. Although frames, like logical and network representations, are a powerful tool, many of the problems of acquiring and organizing a complicated knowledge base must still be solved by the programmer's skill and intuition (see Section 8.5). Nonetheless, because of their power and generality, frames have emerged as an important representation in AI.

8.4.2 Scripts

A natural language understanding program must use a large amount of background knowledge to understand even the simplest conversation (Section 11.0). There is evidence that humans organize this knowledge into structures corresponding to typical situations (Bartlett 1932). If we are reading a story about restaurants, baseball, or politics, we resolve any ambiguities in the text in a way consistent with restaurants, baseball, or politics. If the subject of a story changes abruptly, there is evidence that people pause briefly in their reading, presumably to change knowledge structures. It is hard to understand a poorly organized or structured story, possibly because we cannot easily fit it into any of our existing knowledge structures. There is also a tendency for errors in understanding when the subject of a conversation changes abruptly, presumably because we are confused over which context or schema to use in resolving pronoun references and other ambiguities in the conversation.

A *script* is a structured representation describing a stereotyped sequence of events in a particular context. The script was originally designed by Schank and his research group (Schank and Abelson 1977) as a means of organizing *conceptual dependency* structures into descriptions of typical situations. Scripts are used in natural language understanding

systems to organize a knowledge base in terms of the situations that the system is to understand.

Most adults are quite comfortable (i.e., they know what to expect and how to act) in a restaurant. They are met at the entrance or by a sign indicating that they should continue in and be directed to a seat. Either a menu is available at the table or presented by the waiter or the customer asks for it. We understand the routines for ordering food, eating, paying, and leaving.

In fact, the restaurant script is quite different from other eating scripts such as the “fast-food” model or the “formal family meal.” In the fast-food model the customer enters, gets in line to order, pays for the meal (before eating), waits about for a tray with the food, takes the tray and tries to find a clean table, and so on. These are two different stereotyped sequences of events, and each has a potential script.

The components of a script are:

Entry conditions or descriptors of the world that must be true for the script to be called. In a restaurant script, these include a restaurant that is open and a customer who is hungry.

Results or facts that are true once the script has terminated; for example, the customer is full and poorer, the restaurant owner has more money.

Props or the “things” that support the content of the script. These might include tables, waiters, and menus. This allows reasonable default assumptions about the situation: a restaurant is assumed to have tables and chairs unless stated otherwise.

Roles are the actions that the individual participants perform. The waiter takes orders, delivers food, and presents the bill. The customer orders, eats, and pays.

Scenes. Schank breaks the script into a sequence of scenes each of which presents a temporal aspect of the script. In the restaurant there is entering, ordering, eating, etc.

The elements of the script, the basic “pieces” of semantic meaning, are represented using conceptual dependency relationships. Placed together in a framelike structure, they represent a sequence of meanings, or an event sequence. The restaurant script taken from this research is presented in Figure 8.26.

The program reads a small story about restaurants and parses it into an internal conceptual dependency representation. Because the key concepts in this internal description match with the entry conditions of the script, the program binds the people and things mentioned in the story to the roles and props mentioned in the script. The result is an expanded representation of the story contents, using the script to fill in any missing information and default assumptions. The program then answers questions about the story by referring to the script. The script allows the reasonable default assumptions that are essential to natural language understanding. For example:

EXAMPLE 8.4.1

John went to a restaurant last night. He ordered steak. When he paid he noticed he was running out of money. He hurried home since it had started to rain.

Using the script, the system can correctly answer questions such as: Did John eat dinner last night (the story only implied this)? Did John use cash or a credit card? How could John get a menu? What did John buy?

EXAMPLE 8.4.2

Sue went out to lunch. She sat at a table and called a waitress, who brought her a menu. She ordered a sandwich.

Questions that might reasonably be asked of this story include: Why did the waitress bring Sue a menu? Was Sue in a restaurant? Who paid? Who was the “she” who ordered the sandwich? This last question is difficult. The most recently named female is the waitress, an incorrect conclusion. Script *roles* help to resolve pronoun references and other ambiguities.

Scripts can also be used to interpret unexpected results or breaks in the scripted activity. Thus, in scene 2 of Figure 8.26 there is the choice point of “food” or “no food” delivered to the customer. This allows the following example to be understood.

EXAMPLE 8.4.3

Kate went to a restaurant. She was shown to a table and ordered steak from the waitress. She sat there and waited for a long time. Finally, she got mad and left.

Questions that can be answered from this story using the restaurant script include: Who is the “she” who sat and waited? Why did she wait? Who was the “she” who got mad and left? Why did she get mad? Note that there are other questions that the script cannot answer, such as why do people get mad when the waiter does not come promptly? Like any knowledge-based system, scripts require the knowledge engineer to correctly anticipate the knowledge required.

Scripts, like frames and other structured representations, are subject to certain problems, including the script *match* problem and the *between-the-lines* problem. Consider Example 8.4.4, which could call either the *restaurant* or *concert* scripts. The choice is critical because “bill” can refer to either the restaurant check or the playbill of the concert.

EXAMPLE 8.4.4

John visited his favorite restaurant on the way to the concert. He was pleased by the bill because he liked Mozart.

It is often difficult to determine which of two or more potential scripts should be used. The script match problem is “deep” in the sense that no algorithm exists for guaranteeing correct choices. It requires heuristic knowledge about the organization of the world, and scripts assist only in the organization of that knowledge.

The between-the-lines problem is equally difficult: it is not possible to know ahead of time the possible occurrences that can break a script. For instance:

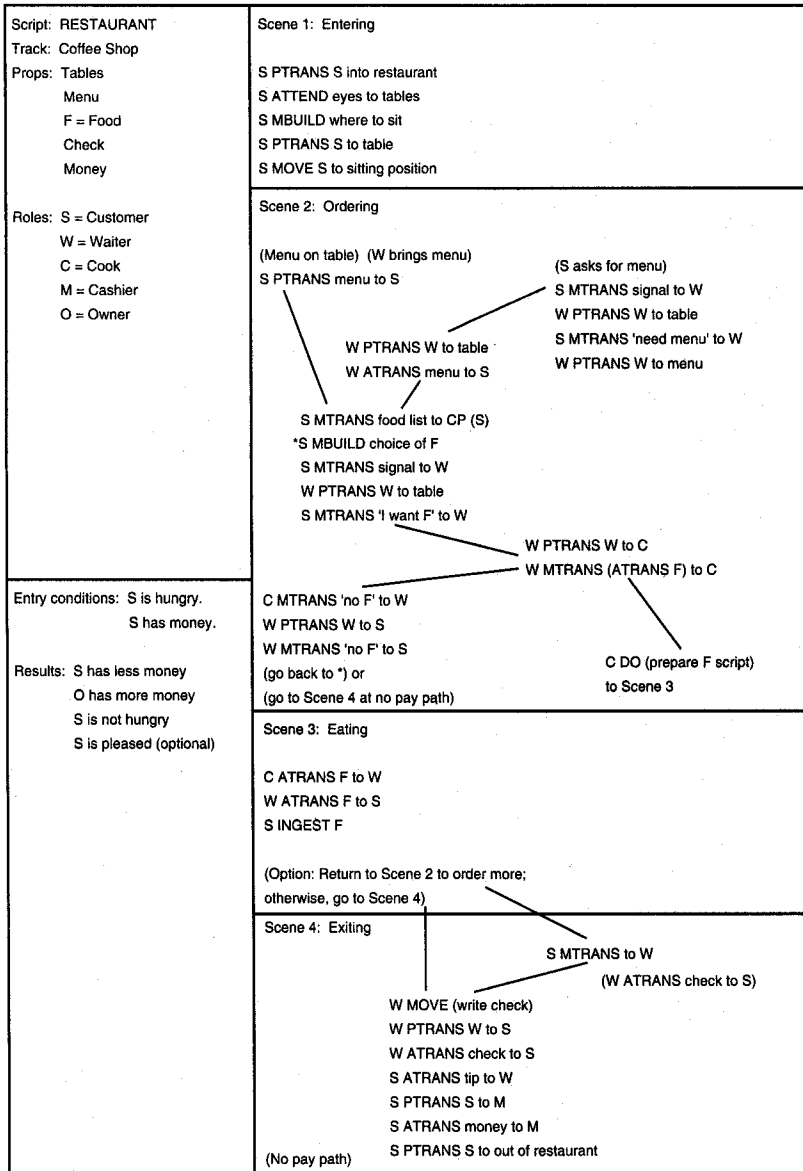

Figure 8.26 A restaurant script (Schank and Abelson 1977).

EXAMPLE 8.4.5

John was eating dinner at his favorite restaurant when a large piece of plaster fell from the ceiling and landed on his date. . . .

Questions: Was John eating a date salad? What did John do next? Was John's date plastered? As this example illustrates, structured representations can be inflexible. Reasoning can be locked into a single script, even though this may not be appropriate.

Memory organization packets (MOPs) address the problem of script inflexibility by representing knowledge as smaller components (MOPs) along with rules for dynamically combining them to form a schema that is appropriate to the current situation (Schank 1982). The organization of knowledge in memory is particularly important to implementations of case-based reasoning, in which the problem solver must efficiently retrieve a relevant prior problem solution from memory (Kolodner 1988a, Section 6.4).

The problems of organizing and retrieving knowledge are difficult and inherent to the modeling of semantic meaning. Eugene Charniak (1972) illustrated the amount of knowledge required to understand even simple children's stories. Consider a statement about a birthday party: "Mary was given two kites for her birthday so she took one back to the store." We must know about the tradition of giving gifts at a party; we must know what a kite is and why Mary might not want two of them; we must know about stores and their exchange policies. In spite of these problems, programs using scripts and other semantic representations can understand natural language in limited domains. An example of this work is a program that interprets messages coming over the news wire services. Using scripts for natural disasters, coups, or other stereotypic stories, programs have shown remarkable success in this limited but realistic domain (Schank and Riesbeck 1981).

8.5 Issues in Knowledge Representation

8.5.1 Hierarchies, Inheritance, and Exceptions

Inheritance across class or type hierarchies is an important feature of almost all network and structured representation languages. Inheritance is implemented through relations such as the type hierarchy of conceptual graphs, as well as through various links including ISA, AKO (A Kind Of), and SUPER (SUPER Class). Figure 8.27 shows a frame-based representation of knowledge about birds and their properties with directed arcs indicating the inheritance hierarchy.

A common, although controversial, use of inheritance is to implement default values and exceptions. In the birds example, we have established a class *flightless bird*, which does not fly. If we assume that the inheritance algorithm searches the hierarchy in bottom-up order, it would encounter the *flightless bird* frame before the *bird* frame and correctly infer that *opus* cannot fly. Here we have established flying as a default value for birds with the subclass *flightless bird* overriding that default value. Several authors (Brachman 1985, Touretzky 1986) have pointed out a number of anomalies that arise in

inheritance, particularly in multiple inheritance hierarchies and in the use of inheritance to implement defaults.

The network of Figure 8.27 illustrates *single* or *tree inheritance*. Each node has only a single parent. Tree hierarchies are well behaved, because an algorithm need only search straight up the hierarchy until it encounters the desired property. If it reaches the top node and still has not found the property, it fails. There is no need for decisions in the inheritance search. The situation is complicated, however, if we allow *multiple inheritance*, such as in a lattice. Multiple inheritance is supported in many knowledge representation languages, including LISP (Section 10.12), because natural entities often belong to more than one class. In the network of Figure 8.28, we have added the class *cartoon character* and made *opus* an instance of this class as well as a *penguin*. *Cartoon characters* have a *habitat* of *funny papers*. It is no longer clear whether *opus* lives at the South Pole or in the funnies.

This problem may be solved in several ways. Most inheritance systems allow the programmer to specify the order with which parent nodes are searched; here we could require that *opus* inherit the properties of *cartoon character* before those of *penguin*. This solution has the undesirable property of violating the declarative semantics of the representation. We must rely on knowledge of the order of search to resolve any ambiguities.

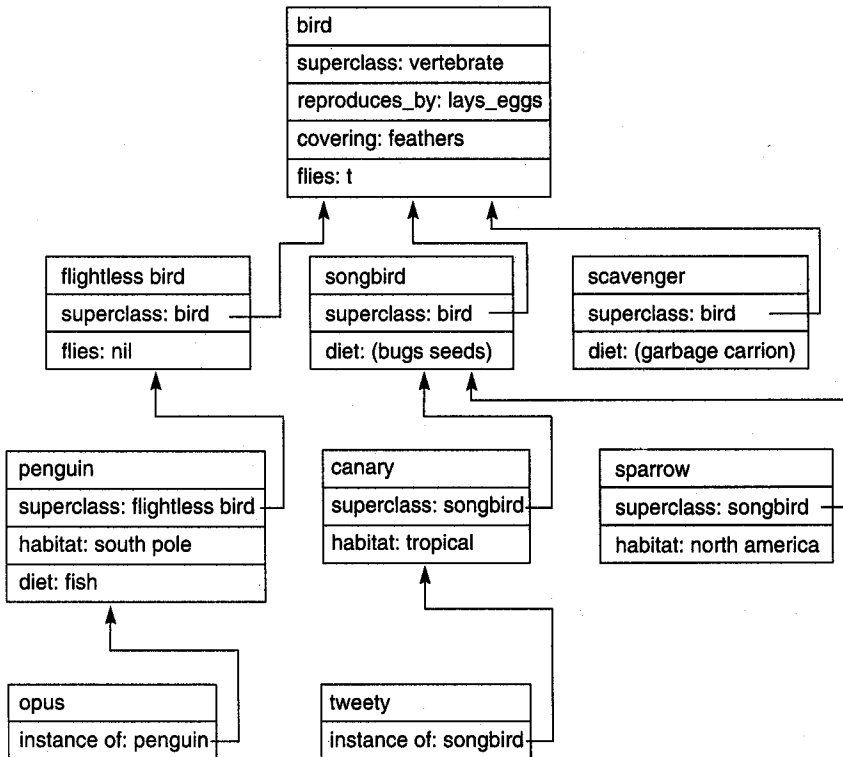

Figure 8.27 Inheritance system description of birds.

Furthermore, this would not help us if there were two conflicts and we wished to resolve one in favor of **penguin** and the other in favor of **cartoon character**. For example, we may state that penguins eat herring and cartoon characters eat hamburgers. How could we represent the fact that **opus** lives in the funnies and eats fish? We could do this by defining a new class for **opus**, called **cartoon penguin**, a subclass of both **penguin** and **cartoon character** and resolve these conflicts explicitly, as in Figure 8.29. This resolves the problem, although in many cases, introduction of new classes seems artificial and can lead to further problems and restructuring of the network on later updates.

In addition, multiple problems occur when inheritance is used to implement defaults and exceptions. In the network of Figure 8.27, the class **flightless bird** is introduced to handle exceptions to the rule that birds fly. It seems reasonable to treat class membership as a transitive relation; from the fact that **penguin** is a subclass of **flightless bird** and **flightless bird** is a subclass of **bird**, we should be able to infer that **penguin** is a subclass of **bird**. Unfortunately, if we allow this intuitively appealing inference and add this link to the graph, we confuse the inheritance of the **flies** property, as in Figure 8.30. We may prohibit these inferences, but that is no more appealing than the other remedies to multiple-inheritance anomalies.

There is a deeper problem in the use of inheritance to handle defaults and exceptions: it compromises the nature of definitions themselves (Brachman 1985a). It seems appropriate to view a frame as a definition of a class. However, if we define a penguin as a bird that does not fly, what is to prevent us from asserting that a block of wood is a bird that does not fly, does not have feathers, and does not lay eggs? This careless use of inheritance to implement exception handling illustrates the subtleties that arise in knowledge representation. One solution would be to restrict the representation to a form that does not allow these problems, such as tree inheritance without exception handling. This also eliminates much of the expressive power of inheritance. Another approach is to

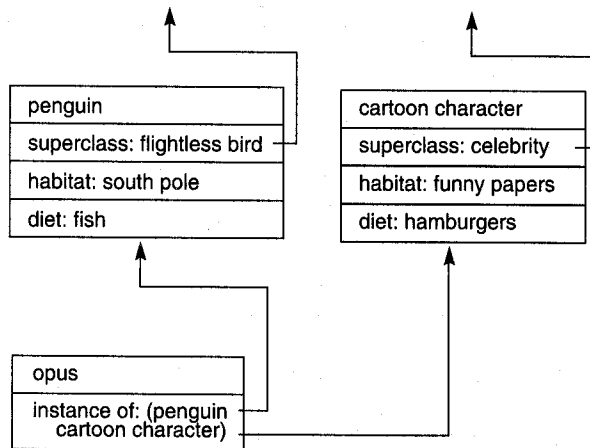

Figure 8.28 An ambiguous multiple inheritance situation.

examine carefully and refine the semantics of the representation. Touretzky (1986) has addressed many of these ambiguities.

Unfortunately, most commercially available inheritance software does not provide a clean enough implementation of inheritance to avoid these problems. This is because many of these issues have not yet been solved or the solutions that are available are either too new or too inefficient to affect the design of current programs. The most effective approach to these problems still requires the programmer to be careful in structuring the knowledge base.

8.5.2 Naturalness, Efficiency, and Plasticity

In this text, we examine the major alternatives for knowledge representation, including the use of logic, rules, semantic networks, and frames. The results of careful study include an increased understanding of the advantages and limitations of each of these representations. Nonetheless, debate continues over the relative naturalness, efficiency, and appropriateness of each approach. Regardless of the representation language selected, a number of important problems remain in the area of knowledge representation.

The first of these is the *selection and granularity of atomic symbols* for the knowledge base. Objects in the world constitute the domain of the mapping; computational objects in the knowledge base are the range. The nature of the atomic elements in the language

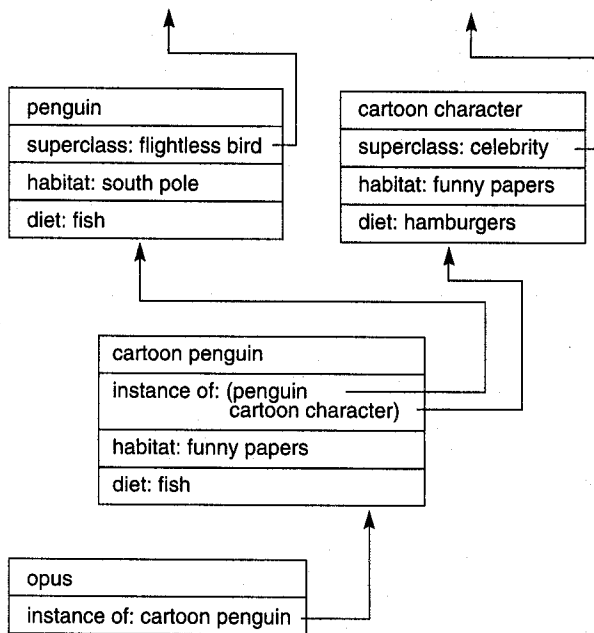

Figure 8.29 Introduction of a new class to resolve ambiguity.

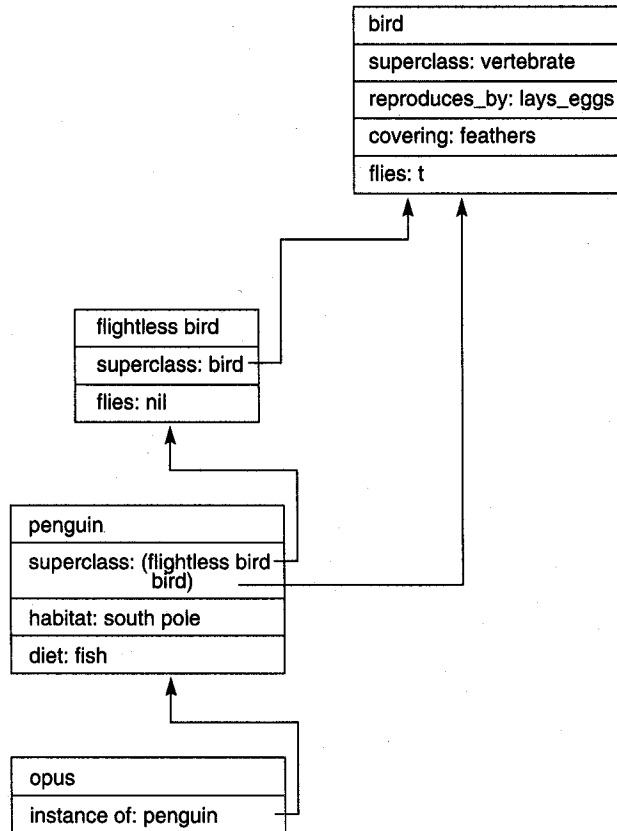

Figure 8.30 Introduction of an anomaly through the transitivity of the subclass relation.

largely determines what can be described about the world. For example, if a “car” is the smallest atom of the representation, then the system cannot reason about engines, wheels, or any of the component parts of a car. However, if the atoms correspond to these parts, then a larger structure may be required to represent “car” as a single concept. This introduces a cost in efficiency in manipulating this larger structure and expressiveness in that the larger structure may obscure the fact that a car is a single conceptual entity.

Another example of the trade-off in the choice of atomic symbols comes from work in natural language understanding. Programs that use single words as elements of meaning may have difficulty in representing complex concepts that do not have a one-word denotation. There is also difficulty in distinguishing between different meanings of the same word or different words with the same meaning. One approach to this problem is to use semantic primitives, language-independent conceptual units, as the basis for representing the meaning of natural language. Conceptual dependency theory takes this approach, and although it avoids the problems of using single words as units of meaning, it

involves other trade-offs: many words require complex structures for their definitions; also, by relying on a small set of primitives, many subtle distinctions, such as push vs. shove or yell vs. scream, are difficult to express.

Exhaustiveness is a property of a knowledge base that is assisted by an appropriate representation. A mapping is *exhaustive* with respect to a property or class of objects if all occurrences correspond to an explicit element of the representation. Geographic maps are assumed to be exhaustive to some level of detail; a map with a missing city or river would not be well regarded as a navigational tool. Exhaustiveness of the map would also allow it to serve as a minimum model for that domain, see Section 7.2.2. Although most knowledge bases are not exhaustive, exhaustiveness with respect to certain properties or objects is a desirable goal. For example, the ability to assume that a representation is exhaustive may allow a planner to ignore possible effects of the *frame* problem.

When we describe problems as a state of the world that is changed by a series of actions or events, these actions or events generally change only a few components of the description; the program must be able to infer side effects and implicit changes in the world description. The problem of representing the side effects of actions is called the *frame problem*. For example, a robot stacking heavy boxes on a truck must compensate for the lowering of the truck bed due to the weight of the boxes. If a representation is exhaustive, there will be no unspecified side effects, and the frame problem effectively disappears. The difficulty of the frame problem results from the fact that it is impossible to build a completely exhaustive knowledge base for most domains. A representation language should assist the programmer in deciding what knowledge may safely be omitted and help deal with the consequences of this omission. (Section 5.4 discusses the frame problem in planning.)

Related to exhaustiveness is the *plasticity* or modifiability of the representation: the addition of knowledge in response to deficiencies is the primary solution to a lack of exhaustiveness. Because most knowledge bases are not exhaustive, it should be easy to modify or update them. In addition to the syntactic ease of adding knowledge, a representation should help to guarantee the consistency of a knowledge base as information is added or deleted. Inheritance, by allowing properties of a class to be inherited by new instances, is an example of how a knowledge representational scheme may help ensure consistency.

Another useful property of representations concerns the extent to which the mapping between the world and the knowledge base is *homomorphic*. Here, homomorphic implies a one-to-one correspondence between objects and actions in the world and the computational objects and operations of the language. In a homomorphic mapping the knowledge base reflects the perceived organization of the domain and can be organized in a more natural and intuitive fashion.

In addition to naturalness, directness, and ease of use, representational schemes may also be evaluated by their *computational efficiency*. Levesque and Brachman (1985) discuss the trade-off between expressiveness and efficiency. Logic, when used as a representational scheme, is highly expressive as a result of its completeness; however, systems based on unconstrained logic pay a considerable price in efficiency. We address this issue again in Chapter 12.

8.6 Epilogue and References

Knowledge representation is a large and difficult domain that lies at the heart of modern artificial intelligence. In this chapter we introduced the major problems in representation and offered techniques for their solution. This chapter brings the reader through the early representational formalisms of AI. We continue our presentation of representational issues, including the connectionist or sub-symbolic, in the remaining chapters.

An important area that we have overlooked involves modifications and extensions to logic that enable it to address the problems of knowledge representation while retaining its well-defined semantics and inference strategies. Important alternatives to first-order predicate calculus include:

1. **Multiple-valued logics.** These extend logic by adding new truth values such as **unknown** to the standard values of **true** and **false**. This can, for example, provide a vehicle for distinguishing between assertions that are known to be false and those that are simply not known to be true.
2. **Modal logics.** Modal logic adds operators that enable it to deal with problems of knowledge and belief, necessity and possibility.
3. **Temporal logics.** Temporal logics enable us to quantify expressions with regard to time, indicating, for example, that an expression is *always* true or *will be true at some time in the future*.
4. **Higher-order logics.** Many categories of knowledge involve higher-order concepts, where predicates, and not just variables, may be quantified. Do we really need higher-order logics to deal with this knowledge, or can it all be done in first-order logic? If higher-order logics are needed, how may they best be formulated?
5. **Logical formulations of definitions, prototypes, and exceptions.** As we illustrated in the discussion of inheritance, exceptions are a necessary feature of a definitional system. However, careless use of exceptions undermines the semantics of a representation. Another issue is the difference between a definition and a prototype, or representation of a *typical* individual. What is the exact difference between the properties of a class and the properties of a typical member? How should prototypical individuals be represented? When is a prototype more appropriate than a definition?

Logical representation continues to be an important area of research (McCarthy 1968, Hayes 1979, Weyhrauch 1980, Moore 1982). *Logics for Artificial Intelligence* by Turner (1984) is an overview of work done in nonstandard logics.

Associationist theories have been studied as models of both computer and human memory and reasoning (Selz 1913, 1922, Anderson and Bower 1973, Sowa 1984, Collins and Quillian 1969).

Our overview of conceptual graphs owes a considerable debt to John Sowa's book *Conceptual Structures* (1984). The reader is referred to this book for details that we have omitted. In its full treatment, conceptual graphs combine the expressive power of predicate

calculus, as well as modal and higher-order logic, with a rich set of built-in concepts and relations derived from epistemology, psychology, and linguistics.

Schema-based reasoning, in many ways similar to frames, was pursued by researchers at the AI Department of the University of Edinburgh (Bundy et al. 1979, Luger 1981). Other important work in structured knowledge representation languages includes Bobrow and Winograd's representation language KRL (Bobrow and Winograd 1977) and Brachman's (1979) representation language KL-ONE, which pays particular attention to the semantic foundations of structured representations.

There are a number of other approaches of interest to the representation problem. For example, Brachman, Fikes, and Levesque have proposed a representation that emphasizes *functional* specifications; that is, what information can be asked of or told to a knowledge base (Brachman et al. 1985, Levesque 1984).

A number of books can help with an advanced study of these issues. *Readings in Knowledge Representation* by Brachman and Levesque (1985) is a compilation of important articles in this area. Many of the articles referred to in this chapter may be found there, although they were referenced in their original source. *Representation and Understanding* by Bobrow and Collins (1975), *Representations of Commonsense Knowledge* by Davis (1990), *Readings in Qualitative Reasoning about Physical Systems* by Weld and deKleer (1990), and the proceedings of any of the annual conferences on artificial intelligence in general or knowledge representation in particular, such as *Principles of Knowledge Representation and Reasoning* by Brachman et al. (1990), are helpful sources. Knowledge representation also lies in the middle ground between AI and Cognitive Science, for issues in this domain see *Cognitive Science: The Science of Intelligent Systems* (Luger 1994). *Computation and Intelligence* (Luger 1995) is a collection of classic papers that emphasizes the development of knowledge representation.

8.7 Exercises

1. Commonsense reasoning employs such notions as causality, analogy, and equivalence but uses them in a different way from formal languages. For example, if we say "Inflation caused Jane to ask for a raise," we are suggesting a more complicated causal relationship than that found in simple physical laws. If we say "Use a knife or chisel to trim the wood," we are suggesting an important notion of equivalence. Discuss the problems of translating these and other such concepts into a formal language.
2. In Section 8.2.1 we presented some of the arguments against the use of logic for representing commonsense knowledge. Make an argument for the use of logic in representing this knowledge.
3. Translate each of the following sentences into predicate calculus, conceptual dependencies, and conceptual graphs:
 - "Jane gave Tom an ice cream cone."
 - "Basketball players are tall."
 - "Paul cut down the tree with an axe."
 - "Place all the ingredients in a bowl and mix thoroughly."

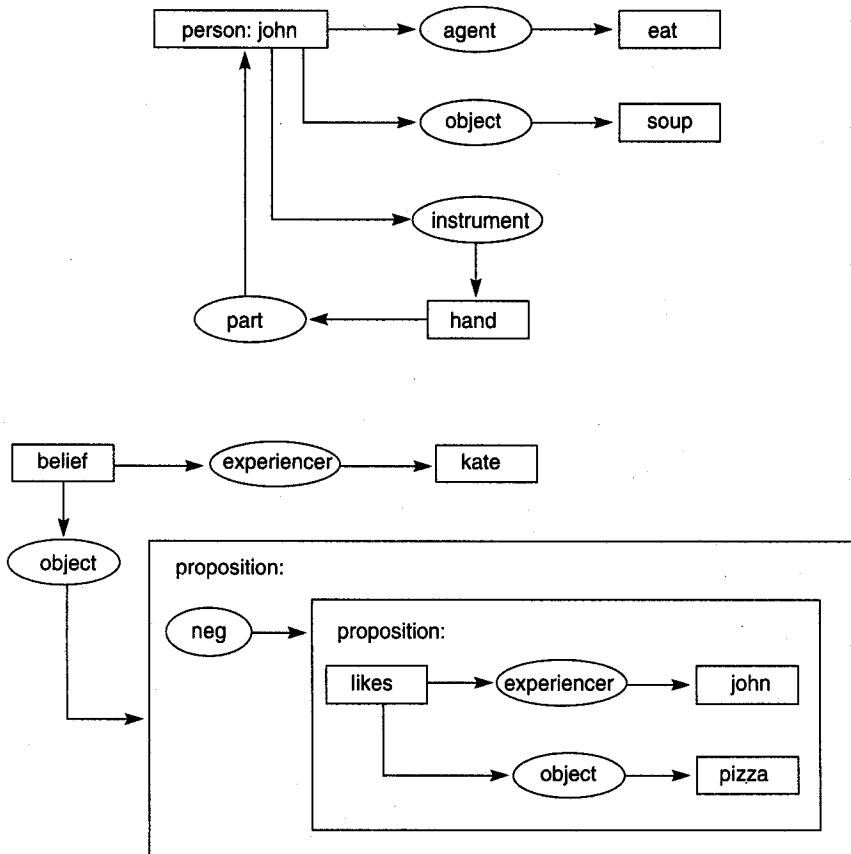

Figure 8.31 Two conceptual graphs to be translated into English.

4. Read "What's in a Link" by Woods (1985). Section IV of this article lists a number of problems in knowledge representation. Suggest a solution to each of these problems using logic, conceptual graphs, and frame notations.
5. Translate the conceptual graphs of Figure 8.31 into English sentences.
6. The operations join and restrict define a generalization ordering on conceptual graphs. Show that the generalization relation is transitive.
7. Specialization of conceptual graphs using join and restrict is not a truth-preserving operation. Give an example that demonstrates that the restriction of a true graph is not necessarily true. However, the generalization of a true graph is always true; prove this.
8. Define a specialized representation language to describe the activities of a public library. This language will be a set of concepts and relations using conceptual graphs. Do the same thing for a retail business. What concepts and relations would these two languages have in common? Which would exist in both languages but have a different meaning?

9. Translate the conceptual graphs of Figure 8.31 into predicate calculus.
10. Translate the financial advisor knowledge base, Section 2.4, into conceptual graph form.
11. Give evidence from your own experience that suggests a script-like or frame-like organization of human memory.
12. Using conceptual dependencies, define a script for:
 - a. A fast-food restaurant.
 - b. Interacting with a used-car salesperson.
 - c. Going to the opera.
13. Construct a hierarchy of subtypes for the concept **vehicle**; for example, subtypes of **vehicle** might be **land_vehicle** or **ocean-vehicle**. These would have further subtypes. Is this best represented as a tree, lattice, or general graph? Do the same for the concept **move**; for the concept **angry**.
14. Construct a type hierarchy in which some types do not have a common supertype. Add types to make this a lattice. Could this hierarchy be expressed using tree inheritance? What problems would arise in doing so?
15. Each of the following sequences of characters is generated according to some general rule. Describe a representation that could be used to represent the rules for:
 - a. 2,4,6,8,...
 - b. 1,2,4,8,16,...
 - c. 1,1,2,3,5,8,...
 - d. 1,a,2,c,3,f,4,...
 - e. o,t,t,f,f,s,s,...
16. Describe a representation that could be used in a program to solve analogy problems like that in Figure 8.32. This class of problems was addressed by T. G. Evans (1968). The representation must be capable of representing the essential features of size, shape, and relative position.

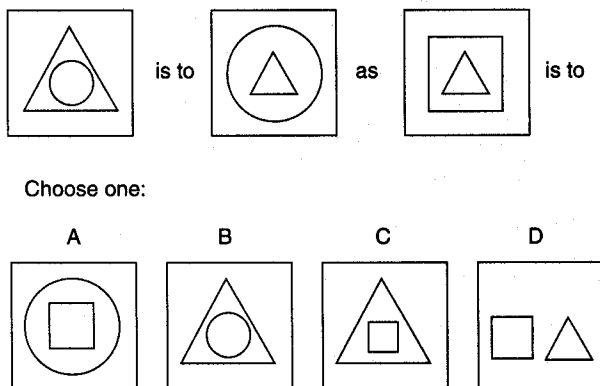
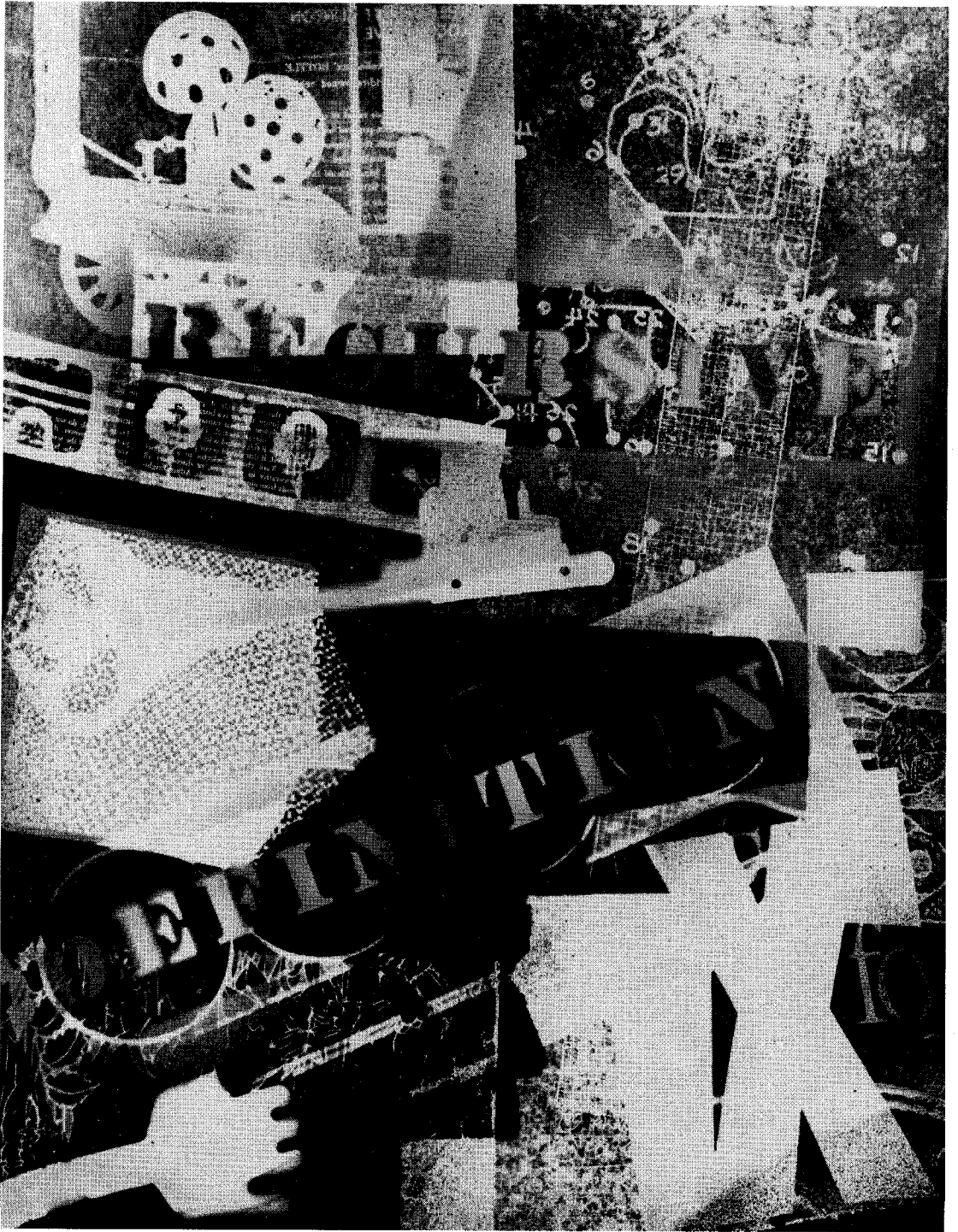

Figure 8.32 Example of an analogy test problem.



PART IV

LANGUAGES AND PROGRAMMING TECHNIQUES FOR ARTIFICIAL INTELLIGENCE

looking through a glass onion...

—LENNON AND MCCARTNEY

for now we see as through a glass darkly...

—PAUL TO THE CORINTHIANS

The map is not the territory; the name is not the thing named.

—ALFRED KORZYBSKI

What have I learned but the proper use of several tools?

—GARY SNYDER, "What Have I Learned"

In Part IV we discuss the issues involved in selecting a language for artificial intelligence programming, and introduce a number of the techniques used in building intelligent systems. The primary function of AI programming is to construct the representation and control structures needed for symbolic computing; the nature of these structures to a great extent determines the features that an implementation language should provide. In this introduction, we enumerate the language features desired for symbolic programming and introduce the LISP and PROLOG programming languages. Not only are these two of the most frequently used languages in artificial intelligence: their syntactic and semantic features also encourage powerful ways of thinking about problems and their solutions. The remarkable influence these languages have had on the development of AI is as much a product of their ability to function as "tools for thinking" as it is a reflection of their strengths as programming languages.

Languages, Understanding, and Levels of Abstraction

The ability to form higher-level abstractions from the particulars of experience is one of the most powerful and fundamental abilities of the human mind. Abstraction allows us to consolidate the details of a complicated domain into a general characterization of its organization and behavior; these abstractions allow us to understand the full range of particulars found in that domain. If we enter a strange house, for example, we will be able to find our way around: the organization of the living room, bedrooms, kitchen, and bathrooms generally conforms to a standard model of a house. The abstraction lets us make sense of the variations found in different houses. A picture may be worth a thousand words, but an abstraction can concisely represent the important features of an entire class of pictures.

When we form theories to describe classes of phenomena, the significant qualitative and quantitative features of the class are abstracted out from the details that characterize its individual members. This loss of detail is compensated by the descriptive and predictive power of a valid theory. Abstraction is an essential tool for understanding and managing the complexity of the world around us, as well as that of our own mental structures. Indeed, this process of abstraction occurs continuously and recursively in the act of knowing: knowledge is built in layers of abstraction, from the mechanisms that extract structure from the chaos of raw sensory stimuli all the way up to the most subtle of scientific theories. Ultimately, most of our ideas are about other ideas.

Hierarchical abstraction, the organization of experience into increasingly abstract classes and descriptions, is an essential tool for understanding the behavior and organization of complex systems, including computer programs. Just as the behavior of an animal may be studied without concern for the underlying physiology of its nervous system, an algorithm has a characterization of its own, quite separate from the program that implements it.

Consider, for example, two different implementations of binary search, one written in FORTRAN using arrays and calculations on array indices and the other written in C++ using pointers to implement binary search trees. In a deep sense, these programs are the same, even though the particulars of their implementations differ. This separation of an algorithm from the code used to implement it is only one example of hierarchical abstraction in computer science.

Allen Newell has distinguished between the *knowledge level* and the *symbol level* of describing an intelligent system (Newell 1982). The symbol level is concerned with the particular formalisms used to represent problem-solving knowledge; the discussion of predicate logic as a representation language in Chapter 2 is an example of such a symbol-level consideration. Above the symbol level is the knowledge level, which is concerned with the knowledge content of the program and the way in which that knowledge is used.

This distinction is reflected in the architecture of knowledge-based systems and the development style it supports. Because users understand programs in terms of their knowledge and capabilities, it is important that AI programs have a clear knowledge level characterization. The separation of the knowledge base from the underlying control

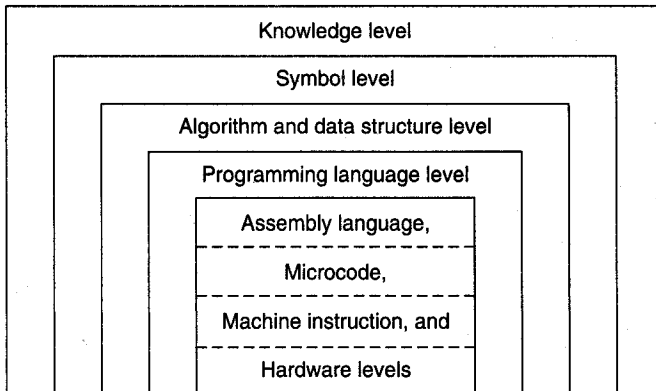

Figure IV.1 Levels of a knowledge-based system.

structure makes this point of view explicit and simplifies the development of coherent, knowledge-level behavior. Similarly, the symbol level defines a representation language, such as logic or production rules, for the knowledge base. Its separation from the knowledge level allows the programmer to address issues of expressiveness, efficiency and ease of programming that are not relevant to the program's higher level behavior. The implementation of the symbol-level representation constitutes a still lower level of program organization and defines an additional set of design considerations. (Figure IV.1)

The importance of the multi-level approach to system design cannot be overemphasized: It allows a programmer to ignore the complexity hidden at lower levels and focus on issues appropriate to the current level of abstraction. It allows the theoretical foundations of artificial intelligence to be kept free of the nuances of a particular implementation or programming language. It allows us to modify an implementation, improving its efficiency or porting it to another machine, without affecting its behavior at higher levels.

The knowledge level defines the capabilities of an intelligent system. The knowledge content is independent of the formalisms used to represent it, as long as the representation language is sufficiently expressive. Knowledge-level concerns include such questions as: What queries will be made of the system? What objects and relations are important in the domain? How is new knowledge added to the system? Will the facts change over time? How will the system need to reason about its knowledge? Does the domain of discourse have a well-understood taxonomy? Does the domain involve uncertain or missing information? Careful analysis at this level is an important step in designing the overall architecture of the program and in choosing the particular method of representation used at the symbol level.

At the symbol level, decisions are made about the structures used to represent and organize knowledge. The selection of a representation language is a primary symbol-level concern. As we have seen in Chapters 6, 7, and 8, logic is only one of many formalisms currently available for knowledge representation. Not only must a representation language

be able to express the knowledge required for an application, but it also must be concise, modifiable, computationally efficient and must assist the programmer in acquiring and organizing the knowledge base. These goals often conflict and necessitate trade-offs in the design of representation languages.

Just as we have distinguished between the knowledge and symbol levels of a program, we can also distinguish between the symbol level and the algorithms and data structures used to implement it. For example, with the exception of efficiency, the behavior of a logic-based problem solver should be unaffected by the choice between a hash table and a binary tree to implement a table of its symbols. These are implementation decisions and should be invisible at the symbol level. Many of the algorithms and data structures used in implementing representation languages for AI are common computer science techniques such as binary trees and tables; others are more specific to AI and are presented in pseudo-code throughout the text and in the chapters on LISP and PROLOG.

Below the algorithm/data structure level is the language level. It is here that the implementation language for the program becomes significant. Even though good programming style requires that we build barriers of abstraction between the particular features of a programming language and the layers above it, the unique needs of symbol-level programming exert a profound influence on the design and use of AI programming languages. In addition, language design must accommodate the constraints it inherits from still lower levels of computer architecture, including the operating system, the underlying hardware architecture and the limitations physical computers must place on resources such as memory and processor speed. The techniques LISP and PROLOG use to mediate the needs of the symbol level and the requirements of the underlying architecture are both a source of their utility; and also an intellectual achievement of great importance and elegance.

In the remainder of this section, we discuss the constraints this knowledge-level approach to programming places on an implementation language. We then introduce the major AI programming languages: LISP and PROLOG.

Desired Features of an AI Language

An important feature of hierarchical abstraction in program organization is the insensitivity of higher levels to the underlying implementation language. This observation has been verified in practice, with successful knowledge-based systems implemented in languages as diverse as LISP, PROLOG, Java, C++, C, Pascal, and even FORTRAN. Similarly, several programs have originally been implemented in LISP or PROLOG and then later ported to C to improve their efficiency and portability. In both cases, behavior at the symbol level was largely unaffected.

However, the abstraction barriers defined in a complex program are not perfect. Higher-level structures exert strong constraints on underlying layers, and the demands that AI programming places on the symbol level are repeated at the language level. For example, the data structures needed for symbolic computation do not lend themselves to such highly regular formalisms as arrays; lists, objects and logical predicates are much more flexible and natural implementation tools.

In addition, because of the difficulty inherent in many AI problems, we often must begin development before we have a full understanding of the final form the program will assume. AI development is necessarily experimental and exploratory in nature; this requirement also places demands on a language and the tools it must provide. A language not only should be adequate to implement higher-level structures; it should also be an effective tool for navigating the entire software life-cycle, from problem analysis through program maintenance.

In the next five subsections, we discuss in more detail the requirements that the symbol-level structures of AI programs place on an implementation language. These are:

Support of symbolic computation.

Flexibility of control.

Support of exploratory programming methodologies.

Dynamic binding and constraint propagation.

A clear and well-defined semantics.

Support of Symbolic Computation. Although there are numerous ways of organizing knowledge at the symbol level, all of them are ultimately implemented as actions on patterns of symbols. This methodological commitment is summarized in Newell and Simon's physical symbol system hypothesis, discussed in the introduction to Part II. The physical symbol system hypothesis underscores the need for a programming language that simplifies the implementation of a range of operations on symbolic rather than numeric data. Even neural networks and other forms of emergent computation must handle symbolic information in their inputs and outputs. The numeric data types and operations emphasized by traditional programming languages are not well suited for implementing search algorithms or AI representation languages. Instead, an AI language should simplify the creation of arbitrary symbol structures and operations on them. This is the most fundamental requirement for an AI programming language.

Predicate calculus, described in Chapter 2, is a powerful and general tool for constructing qualitative descriptions of a problem domain. The significant features of a domain may be represented as sets of logical assertions. Through the use of variables, it is possible to create general assertions about classes of entities; logical implications allow the representation of dependencies and other relationships between objects in a domain.

PROLOG is a general programming language based on the first-order predicate calculus. As an implementation of formal logic, PROLOG is sometimes used directly as a representation language at the symbol level. However, its real power is as a language for implementing more specialized and complex representations such as frames and networks in a concise and systematic fashion. Many symbol-level structures are easily built using the higher-level constructs of PROLOG. In Chapter 9, we show how PROLOG may be used to implement search algorithms, an expert system shell, and a semantic network.

Another important tool for building symbol structures is the list. A list is a sequence of elements in which each element may be either another list or an atomic symbol. Several examples of lists, using the syntax of the LISP programming language, are:

(this is a list)
((this is) (a list) (of lists))
(times (plus 1 3) (plus 2 3))
((1 2 3) (4 5 6) (7 8 9))

Note that several of these examples include lists nested within lists; this allows us to represent structural relations. The power of lists is largely a result of their ability to represent any symbol structure, regardless of its complexity or the operations it must support. This includes trees, arbitrary graphs, collections of logical predicates, arrays, data bases allowing keyword retrieval—in short, any conceivable structure may be captured in an appropriate arrangement of lists and operations on them. Lists are such important representational building blocks that both LISP and PROLOG provide the user with the data elements and operations for manipulating and composing them into more complicated structured types.

Whereas PROLOG is based directly in the predicate calculus and includes lists as an additional representational tool, LISP uses the list as the basis of both data types and programs. All LISP structures are built from lists, and the language provides a rich set of tools for manipulating these structures and defining new functions for creating, accessing, and changing them. LISP's syntactic uniformity and extensibility make it easy to construct interpreters for any representation language. By taking an abstract data type approach, the LISP programmer can define the symbol structures and operations needed for any higher-level formalism, including search controllers, logic theorem provers, and other high-level representations.

Flexibility of Control. One of the hallmarks of intelligent behavior is its flexibility. Indeed, it is difficult to imagine that intelligence could be achieved through the step-by-step execution of fixed instruction sequences exhibited by traditional computer programs. Fortunately, this is not the only way of organizing computation.

One of the oldest and most important paradigms for building an AI program is the production system, described in Chapter 5. In a production system, the program is a set of rules. In data-driven reasoning these rules are executed in an order determined by the pattern of the data in a given problem instance. Production rules can fire in virtually any order in response to a given situation. In this fashion, a production system can provide both the flexibility and the coherency required for intelligent behavior.

Though AI uses a number of different control structures, many of them are related to production systems, and virtually all of them involve pattern matching. Pattern-directed control allows knowledge to be applied opportunistically in response to the features of a particular problem instance. Pattern matching algorithms, such as unification, determine when the features of a problem instance match a particular chunk of program knowledge, selecting that knowledge for application to the problem. It is important that an AI language either provide this directly or simplify the development of pattern-directed control.

In PROLOG, unification (Chapter 2) and search algorithms are built into the language itself, forming the heart of the PROLOG interpreter. Using this built-in unification algorithm, it is simple to construct any pattern-driven control regime: depth-first search is

given as a default, and other regimes such as breadth-first or best-first search are constructed with just a few lines of code.

LISP does not provide pattern-matching directly, but the sophistication of its symbolic computing facilities and the easy extensibility of the language simplify construction of pattern matchers and interpreters of arbitrary complexity and organization. One advantage of this approach is that the pattern matcher and associated control structures may easily be tailored to fit the demands of a particular problem or representation.

More recent approaches to artificial intelligence, such as neural networks, collaborative agents and other forms of emergent computation may eschew operations on symbol structures, but they do not avoid the need for flexible control. Neural networks must be able to dynamically configure themselves. Agents rely on message passing between different modules, often on different machines. Genetic algorithms require the creation and destruction of numerous individuals as the population of candidate problem solutions evolves. The ability of AI languages to provide easy pointer manipulation, automatic memory management, simple data retrieval facilities, dynamic binding of variables and procedures, and strong forms of program encapsulation, such as object-oriented programming, has led to their widespread use in implementing these newer tools of AI.

Support of Exploratory Programming Methodologies. The problems that AI addresses do not always respond to such standard software engineering approaches as top-down design, successive refinement, and program development from detailed formal specifications. Because of the very nature of AI problems, it is seldom possible to give a correct and complete specification of the final form of an AI program before building at least a prototype. Often, our understanding of the problem the program is intended to solve evolves through the course of program development. Reasons for this include:

1. **Most AI problems are initially poorly specified.** Because of the extreme complexity needed to support rich knowledge-level behavior, it is seldom possible to examine a problem and determine conclusively the exact approach that should be taken to its solution. The best symbol-level structures to be used in a given program are seldom evident in its knowledge-level specification. This complexity and ambiguity do not lend themselves to traditional software engineering techniques where complete and accurate problem specifications are developed (and necessary) before coding starts.

A complex reasoning task is inherently more difficult to characterize formally than is a task such as sorting a list or maintaining a file system. Exactly what does it mean, for example, to design a circuit or diagnose an illness? How does a human expert perform these tasks? What is a satisfactory level of performance for a given problem domain? What knowledge is required? What difficulties will be caused by missing or unreliable information? Because the answers to these and other questions often require us to explore alternative solution strategies, most AI programs are initially specified in general terms and made more specific as code development illuminates the deeper structure of the problem to be solved.

2. **The approaches taken to solving problems tend to be domain specific.** Although there are general frameworks for AI problem solving, e.g., production systems, search, and representation languages, each problem domain tends to require unique strategies. Thus successful solutions to problems seldom generalize fully to new domains: each application is, to some extent, a new ball game.
3. **Heuristic methods are inherently empirical.** Even the techniques used by human experts have been developed through trial and error. This means that heuristic strategies, unlike algorithms, must be implemented and tested before their value can be fully known. In this sense, every AI program is an experiment whose outcome cannot be known in advance.
4. **The structures and formalisms for AI representations continue to be developed and refined.** The development of AI representations is an ongoing subject of research. The development of practical AI systems is, in many ways, an extension of this process. Although experience helps greatly in choosing and applying a representation, there is currently no substitute for trying an idea and seeing how it works.

For these reasons, AI programming is inherently exploratory; the program is often the vehicle through which we explore the problem domain and discover solution strategies; indeed the tool with which we come *to understand* the problem. The challenge for AI programming is to support exploratory programming. Among the features that an exploratory programming language should provide are:

1. Modularity.
2. Extensibility.
3. Useful high-level constructs.
4. Support of early prototyping.
5. Program "readability."
6. Interpreted and compiled modes.
7. Software support for exploratory programming.

We discuss these topics in the following paragraphs:

1. **Modularity and modifiability of code.** It is important that a language for exploratory programming support frequent modifications of its code. This implies that programs should consist of small, well-bounded chunks rather than large bodies of complex code. The interactions between program components should be limited and clearly defined. This includes avoiding side effects and global variables, and ensuring that the behavior of any single module in the program's execution is easily determined.

LISP programs are written as collections of individual functions; in a well-written LISP program, each function is small and performs a single, well-defined task. Thus, it is usually simple to locate and correct the cause of any deficiencies. The parameter passing

(a variation of “pass by value”) and variable scoping rules of LISP also serve to reduce function side effects. Global variables, although supported by the language, are avoided in good LISP code. In addition, LISP supports object-oriented encapsulation through the Common LISP Object System, CLOS.

In PROLOG the basic unit of the program is the rule. PROLOG rules, like LISP functions, tend to be small and specialized. Because the scope of variables in PROLOG is always restricted to a single rule and the language does not allow global variables, modifiability is simplified. Both LISP and PROLOG include trace facilities, which, when combined with a clear program structure, simplify debugging.

2. Extensibility and embedded languages. Exploratory programming usually proceeds in a bottom-up fashion, with the higher-level structures of the program emerging as the code is developed. An important technique for doing this in a systematic and well-structured fashion is the development of an *embedded language*.

Often it is not possible to specify the final form of an AI program, but it is possible to determine the higher-level structures useful for exploring the problem domain. These structures can include pattern matchers, search controllers, and functions for defining a representation language. Essentially, this approach says “if you can’t determine the final structure a program will take, attempt to define the language constructs that will help develop that structure.”

To support this methodology, a programming language should be easily extensible and should simplify the development of interpreters. By extensibility, we mean the ability to define new language constructs with maximum freedom and flexibility. LISP, PROLOG, and their object-oriented extensions, such as CLOS, all allow easy definition of new functions, predicates, and objects. Once defined, these user-created constructs behave exactly like the built-in components of the language. One programs these languages by extending their basic capabilities from the bottom up until a solution is achieved. In a sense, we say that traditional programs are “constructed” but AI programs are “grown.”

This contrasts with the sharp distinction that traditional languages make between built-in features and user-developed programs. In C++, for example, we may define new functions or procedures, but their syntax is more restricted than the syntax of the built-in constructs of the language; this limits the flexibility and utility of these extensions.

LISP and PROLOG also simplify the writing of interpreters to execute specialized variations of the underlying language. In LISP, both programs and data are syntactically represented as lists. This makes it easy to write programs that manipulate LISP code as if they were data, greatly simplifying the development of interpreters. Many historically and commercially important AI languages such as PLANNER, ROSIE, KEE, and OPS were built on these capabilities of LISP. (We design a meta-interpreter in LISP in Chapter 10.) PROLOG provides this capability through a number of “meta-predicates,” predicates for manipulating other PROLOG predicates, again simplifying the writing of arbitrary interpreters. As with LISP, a number of higher-level AI languages have been built on PROLOG using this methodology. (We present several meta-interpreters for PROLOG in Chapter 9.)

3. Existence of useful high-level constructs. Exploratory programming is aided by the existence of powerful high-level constructs in the language. These powerful but

general abstractive constructs allow the programmer to quickly develop specialized structures for knowledge representation and program control.

In LISP, these include the basic list data type, which allows the construction of arbitrarily complex data structures, as well as powerful functions for defining operations on them. Because LISP is extensible and has been used for several decades, the most general and powerful of these user-defined functions have become standard features of the language. The Common LISP specification includes literally hundreds of functions for creating data structures, building interfaces, tracing execution, and editing LISP structures.

PROLOG has remained a comparatively small language, partly because of its newness and partly out of a commitment to simplicity and compactness. However, PROLOG allows users to create their own library of specialized predicates, and the most useful of these have found their way into standard implementations.

4. Support for early prototyping. Another important exploratory programming methodology is early prototyping. Here, the programmer builds a "quick and dirty" solution to the problem and uses it to explore the problem space. Once we have explored the problem and outlined a viable solution strategy, we throw the prototype away and build a final program that emphasizes correctness and efficiency of implementation. Although it is generally difficult to throw away something that has required as much work to build as a computer program, doing so often saves time in the long run and improves the quality of the final program. The structures and methods provided by AI languages greatly speed up the development of prototypes.

5. Program readability and documentation. Because most AI programs are modified extensively through their lifetime, it is important that the code be readable and well documented. While there is no substitute for clear natural language comments in the code, AI languages, with modules composed of high-level constructs, simplifies this task.

6. Interpretation versus compilation. Most AI languages are interpreted rather than compiled during program development. This means the programmer does not have to wait for lengthy recompilations every time the code is changed. To address the performance problems of interpreted code, modern AI languages allow individual modules to be individually compiled to an intermediate form that can be interpreted more efficiently. Incremental compilation improves program speed while retaining the benefits of interpreted execution. In addition, many implementations allow programmers to compile the final versions of programs.

7. Powerful development environments. Modern AI languages include rich programming environments, providing tools for tracing the execution of either whole programs or sections of programs. Debuggers allow the programmer to step through program execution incrementally, to temporarily change the value of program variables or even the code itself, to insert break points that halt program execution at prespecified points, and to freeze the execution environment at the point where an error is detected so that the program state may be examined. In addition, many language implementations include intelligent editors that spot syntax errors as code is being written. Because of the complexity of AI programs and the difficulty of predicting the behavior of such flexible control regimes as production systems, the importance of these support facilities cannot be overestimated.

Dynamic Binding and Constraint Propagation. Traditional languages require that most of a program's bindings be determined at compile time. These include the binding of variables to memory locations and the binding of procedures to their names. However, many advanced programming techniques, such as object-oriented programming, require that these bindings be determined dynamically, while the program is being executed. Both LISP and PROLOG support dynamic binding.

From an AI standpoint, one of the most important benefits of dynamic binding is its support for constraint-based programming. Often, the problems addressed by an AI program require that the values of certain entities remain unknown until sufficient information has been gathered. This information may be seen as a series of constraints on the values that a variable may assume; as constraints are accumulated, the set of possible values is reduced, ultimately converging on a solution that satisfies all the constraints.

A simple example of this approach may be seen in a medical diagnostic system that gathers information about a patient's symptoms until the possible explanations have been reduced to a single diagnosis. The programming language analog of this methodology is late variable binding, or the ability to maintain a variable as explicitly unbound while manipulating it in the program code. Both LISP and PROLOG allow variables to be defined and manipulated as explicitly unbound, while defining the relationships and dependencies between those variables and other program units. This enables the easy and natural implementation of constraint propagation.

A Clear and Well-Defined Semantics. This is a need that AI languages share with any programming language intended for the development of large, complicated, yet reliable systems. Unfortunately, traditional programming languages such as FORTRAN and Pascal tend to have complex and difficult semantic definitions. This shortcoming can be traced to the fact that such languages are essentially higher-level characterizations of the architecture of the underlying von Neumann computer and inherit many of the complexities of that physical system. Because AI languages have often been based on mathematical formalisms such as logic (PROLOG) or recursive function theory (LISP), they tend to have simpler semantics, inheriting much of the notational power and elegance of the underlying mathematics. This makes these languages particularly useful for researchers in areas such as implementing knowledge representation tools, proving programs correct, and automating the generation of efficient code from formal specifications.

It should also be noted that although the *function* of most AI programs is highly complex, the code that *implements* that function should strive for simplicity and clarity. Large blocks of complex opaque code do not imply good AI. A well-defined language semantics is an important tool for achieving these ends.

An Overview of LISP and PROLOG

By meeting the needs outlined in the previous section, LISP and PROLOG have emerged both as rich and mature programming languages as well as the dominant languages for AI

research and development. When learning these languages, the student should keep these needs in mind and think about the ways in which they are supported by the specific features of each language.

PROLOG

PROLOG is the best-known example of a *logic programming language*. A logic program is a set of specifications in formal logic; PROLOG uses the first-order predicate calculus. Indeed, the name itself comes from PROgramming in LOGic. An interpreter executes the program by systematically making inferences from logic specifications. The idea of using the representational power of the first-order predicate calculus to express specifications for problem solving is one of the central contributions PROLOG has made to computer science in general and to artificial intelligence in particular. The benefits of using first-order predicate calculus for a programming language include a clean and elegant syntax and well-defined semantics.

The implementation of PROLOG has its roots in research on theorem proving by J.A. Robinson (1965), especially the creation of algorithms for resolution refutation. Robinson designed a proof procedure called *resolution*, which is the primary method for computing with PROLOG. The chapter on automated theorem proving demonstrates *resolution refutation systems*; see Sections 12.2 and 12.3.

Because of these features, PROLOG has proved to be a useful vehicle for investigating such experimental programming issues as automatic code generation, program verification, and design of high-level specification languages. PROLOG and other logic-based languages support a declarative programming style—that is, constructing a program in terms of high-level descriptions of a problem's constraints—rather than a procedural programming style—writing programs as a sequence of instructions for performing an algorithm. This mode of programming essentially tells the computer “what is true” and “what needs to be done” rather than “how to do it.” This allows programmers to focus on problem-solving as sets of specifications for a domain rather than the details of writing low-level algorithmic instructions for “what to do next.”

The first PROLOG program was written in Marseille, France, in the early 1970s as part of a project in natural language understanding (Colmerauer et al. 1973, Roussel 1975, Kowalski 1979a). The theoretical background for the language is discussed in the work of Kowalski, Hayes, and others (Kowalski 1979a, 1979b, Hayes 1977, Lloyd 1984). The major development of the PROLOG language was carried out from 1975 to 1979 at the department of artificial intelligence of the University of Edinburgh. The group in Edinburgh responsible for the implementation of PROLOG were David H.D. Warren and Fernando Pereira. They produced the first PROLOG interpreter robust enough for delivery to the general computing community. This product was built on the DEC-system 10 and could operate in both interpretive and compiled modes (Warren et al. 1979). Further descriptions of this early code and comparisons of PROLOG with LISP may be found in Warren et al. (1977). This “Warren and Pereira” PROLOG became the early standard, and the book *Programming in PROLOG* (Clocksin and Mellish 1984) was the chief vehicle for delivering PROLOG to the computing community. Our text uses this standard, which has come to be known as the Edinburgh syntax.

The advantages of the language have been demonstrated by research projects designed to evaluate and extend the expressive power of logic programming. Discussion of many such applications can be found in the Proceedings of the International Joint Conference on Artificial Intelligence and the Symposium on Logic Programming. See also the references at the end of Chapter 9.

LISP

LISP was first proposed by John McCarthy in the late 1950s. The language was originally intended as an alternative model of computation based on the theory of recursive functions. In an early paper, McCarthy (1960) outlined his goals: to create a language for symbolic rather than numeric computation, to implement a model of computation based on the theory of recursive functions (Church 1941), to provide a clear definition of the language's syntax and semantics, and to demonstrate formally the completeness of this computational model. Although LISP is one of the oldest computing languages still in existence (along with FORTRAN and COBOL), the careful thought given to its original design and the extensions made to the language through its history have kept it in the vanguard of programming languages. In fact, this programming model has proved so effective that a number of other languages have been based on functional programming, e.g., SCHEME, ML, FP.

The list is the basis of both programs and data structures in LISP: LISP is an acronym for LIST Processing. LISP provides a powerful set of list-handling functions implemented internally as linked pointer structures. LISP gives programmers the full power and generality of linked data structures while freeing them from the responsibility for explicitly managing pointers and pointer operations.

Originally, LISP was a compact language, consisting of functions for constructing and accessing lists, defining new functions, detecting equality, and evaluating expressions. The only means of program control were recursion and a single conditional. More complicated functions, when needed, were defined in terms of these primitives. Through time, the best of these new functions became part of the language itself. This process of extending the language by adding new functions led to the development of numerous dialects of LISP, often including hundreds of specialized functions for data structuring, program control, real and integer arithmetic, input/output (I/O), editing LISP functions, and tracing program execution. These dialects are the vehicle by which LISP has evolved from a simple and elegant theoretical model of computing into a rich, powerful, and practical environment for building large software systems. Because of the proliferation of early LISP dialects, the Defense Advanced Research Projects Agency in 1983 proposed a standard dialect of the language, known as Common LISP.

Although Common LISP has emerged as the lingua franca of LISP dialects, a number of simpler dialects continue to be widely used. One of the most important of these is SCHEME, an elegant rethinking of the language that has been used both for AI development and for teaching the fundamental concepts of computer science. The dialect we use throughout the remainder of our text is Common LISP.

Object-Oriented Programming

Object-oriented programming, unlike LISP and PROLOG, has its roots in software engineering and simulation rather than in abstract mathematics. Smalltalk, the first “object-oriented” language, was developed in the early 1970s at Xerox Palo Alto Research Center by Alan Kay. Building on ideas from Simula, the Norwegian simulation language developed in the 1960s, and Seymour Papert’s work in using LOGO to teach children programming, “Small” talk was intended to be simple enough for children to learn and to use to communicate. Smalltalk influenced work on the Dynabook, a portable computer the size of a loose-leaf binder, intended to be a general tool for the non-computer scientist.

Because of their target user, the operating system and applications software needed to be nontechnical and easily understood. Their solution to this problem was a graphics interface based on the “desktop” metaphor: multiple process windows, like papers scattered on a desk; use of menus, graphic icons, and pointing devices; a mouse or a touch screen for selecting options; and a rich set of programs for editing, graphics, and communications. The user interface design of the Dynabook has influenced the design of user interfaces for a range of computers, including personal computer operating systems such as the Apple Macintosh, Microsoft Windows, workstations hosting the X-windows system, and the numerous specialized environments available for AI program development.

In a Smalltalk program, everything is represented as an *object*, an active computational structure of arbitrary complexity. Objects include not only the data types needed to define a computational entity but also the *methods* (executable code) necessary to compute the object’s state. The values of an object are represented as *slots* as in frames. Objects may be class objects, describing all instances of a type, or instances, representing a single member. When instances of a data type are defined as objects, these instance objects inherit (Chapter 8) both the type definitions and the associated methods from their class. For example, the number 3 is a member of the class *integers* and inherits the integer operators (+, −, *, DIV, MOD) from the class. To perform an operation on an object, a message is sent to the object invoking the appropriate method. For example, to add 3 and 4, the message +4 is sent to the object 3; *integer 3* responds with the answer 7.

By providing a means for combining data types and the operations on them into a single entity, called the object, Smalltalk supports the development of modular code and applies strong typing to both data elements and the code for their manipulation. Because Smalltalk objects are organized into a network of classes, with more specialized objects inheriting part or all of the methods of the more general, it is simple to create new program structures that incorporate the functionality of existing program objects. Thus, a program can readily incorporate the full power of the underlying system, including graphics, editing, and communications. In addition, important software development techniques such as information hiding, operator overloading, code reuse through class inheritance, on-line documentation, and embedded languages are supported in a natural fashion.

Object-oriented programming languages incorporate many of the features found in frame-based knowledge representations, including class inheritance and the ability to represent structured knowledge. For these reasons, object-oriented languages are widely used in AI programming.

Most important, Smalltalk defined the methodology of object-oriented programming. Object-oriented programming techniques are being adopted in software engineering, data base design, and the teaching of programming and data structures. The methodology has emerged as an important AI programming technique, especially in development of hybrid AI environments. Object-oriented design in CLOS is presented in Section 10.12.

Hybrid Environments

The demands of knowledge-based programming have led to the development of a number of programming and representation techniques, including production systems, rules, and frame/object-based representations. A hybrid system combines multiple representation paradigms into a single integrated programming environment. Although hybrid environments differ, they generally include the following features:

1. **Frame or object-oriented representations of domain objects.** Such systems support inheritance of class properties and often include a message-passing mechanism for object interactions.
2. **Rules for representing heuristic knowledge.** Although frames and objects are the preferred means of describing taxonomies of objects, rules remain the most natural means of describing heuristic problem-solving knowledge. The *if... then...* syntax fits the way human experts describe their decision-making process. Rules are able to access information in objects, either through use of a language that directly reads and writes to slots in an object or by using message passing to query an object indirectly.
3. **Support for a variety of search strategies.** Most systems support both forward and backward search. Generally, presentation of a goal query initiates a backward-chaining search. Addition of a new fact to working memory may initiate forward reasoning from rules enabled by this new fact.
4. **Definition of demons to implement interactions and side effects.** A *demon* is a procedure that is invoked as a side effect of some other action. A conventional example of the use of demons is a controller in a time-sharing system that is invoked periodically to monitor a printer or other device. Demons are not called directly but are invoked by a clock. AI environments extend this idea, allowing the creation of demons that are called, for example, whenever an object or slot is created or modified. Such demons are used to update a display in response to a changed slot value, to perform consistency checks when the modification of one entity requires a change in a different object, or to implement the interactions between objects in a simulation. Typical demons include *if changed* demons that run whenever the value of a variable is changed, *read* demons that run whenever a variable value is read in, *when created* demons that run when an instance is created, *timed* demons that refresh the value of time-sensitive data, and *active values* or *active images* that link a graphic with the value of a variable.

5. **Rich graphics-based interfaces.** These include a range of trace facilities that allow both continuous and stepwise monitoring of executions. For example, graphic displays can describe the rule structure of a knowledge base as a tree structure. An important feature of hybrid environments is the ability to attach, using demons, a graphic display to a slot in an object. This allows a gauge, for example, or other graphic to display its value in real time. Similarly, most environments provide high-level support for graphics input devices such as buttons or sliders that may be set using a mouse or other pointing device.
6. **Escapes to an underlying language.** Methods are represented in a special language defined by the environment or, more often, in LISP, PROLOG, or even C, C++, or Pascal. This allow both a natural description of procedural knowledge, and also a knowledge-based program to call more conventional languages to perform arithmetic, array manipulation, sensor monitoring, or other actions that are better implemented using conventional algorithmic techniques.
7. **The ability to compile a knowledge base for faster execution or delivery on a smaller machine.** Once a knowledge-based program is completed, the rich interpreted development environment is often an overhead that slows down execution. Most modern AI environments allow applications to be compiled and run under a faster, simpler, often also smaller and cheaper delivery machine.

A Hybrid Example

A good many problems are naturally thought of in terms of objects, relationships, and the interactions between them. In Figure IV.2 we present a battery connected with a switch to

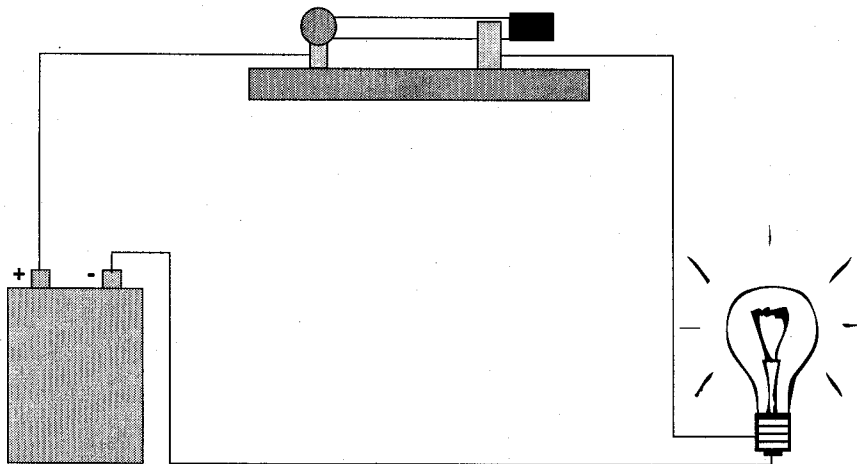

Figure IV.2 Many problems are naturally thought of in terms of objects and relations.

a light bulb. The bulb, battery, and switch may each be represented by classes that describe properties of batteries, switches, and bulbs in general. The electronic components of Figure IV.2 may then be represented as particular instances of these general classes. Note that instances take on particular *instance values* of their class object. The controls slot of each component is appropriately linked to simulate the system. For example, if the state of switch1 is changed to off, the controls slot indicates that light1 is affected. We show part of a class/instance hierarchy in Figure IV.3.

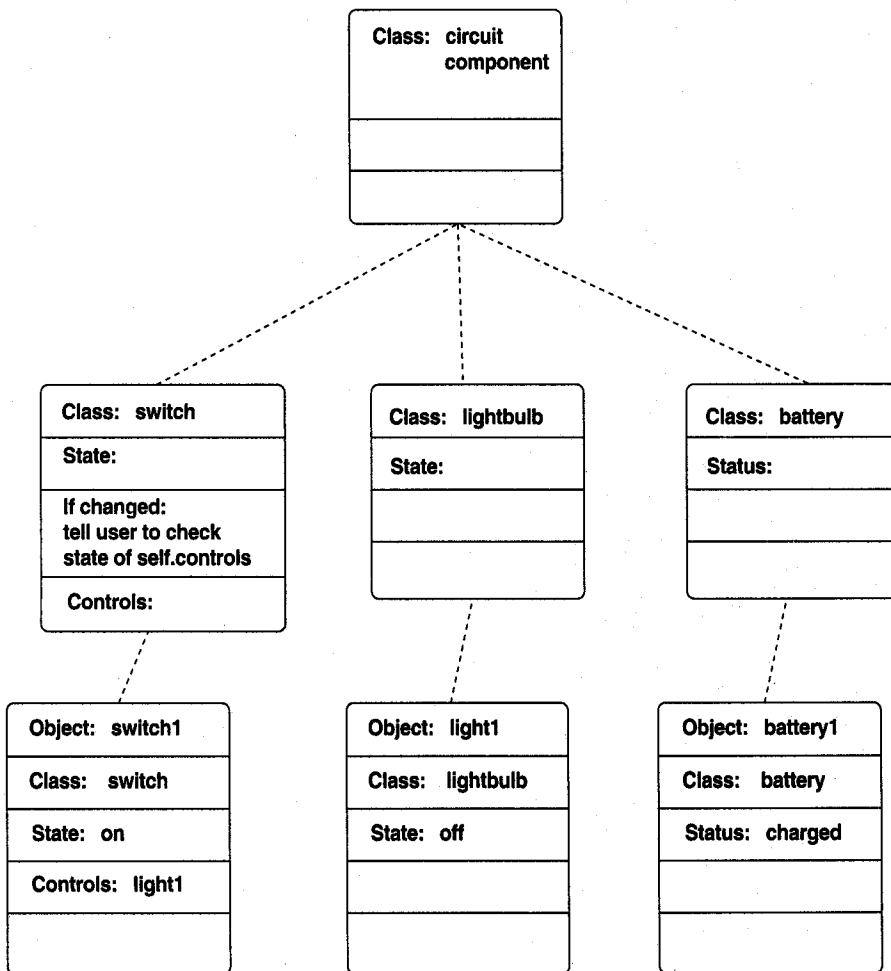

Figure IV.3 In a hybrid system, rules access the slots of classes and objects.

A rule may be created to reason about these components:

```
IF the light won't come on AND the switch is closed AND the battery is okay  
THEN look for a broken connection.
```

In the hybrid representation, the rules access properties, or more properly, the instance values of the classes and objects. As can be noted in Figure IV.3, the condition information for this rule is checked by accessing the appropriate slot values of the object instances in the domain. The rule may be seen as part of a back-chaining rule system attempting to debug this circuit, or it may be demon-driven, asking for a check of the state of a switch's control's state value whenever the state of the switch is changed.

Selecting an Implementation Language

As artificial intelligence has matured and demonstrated its applicability to a range of practical problems, its almost exclusive reliance on LISP and PROLOG has diminished. The circumstances of software development, such as the need to easily interface with legacy code, the use of AI in smaller modules of large, conventional programs, and the need to conform to development standards imposed by corporate or governmental customers has led to the development of AI systems in a variety of languages, including Smalltalk, C, C++, and Java. Nonetheless, LISP and PROLOG continue to dominate the development and prototyping of AI systems in industry and academia. A working knowledge of these languages is an important part of any AI programmer's skill set.

In addition, these languages have served as proving grounds for many of the features that continue to be incorporated into modern programming languages. Perhaps the best example of this is the Java language, which profits from its use of dynamic binding, automatic memory management, and other features that were pioneered in these earlier languages. It often seems as though the rest of the programming language world is still trying to catch up to the standards set by these languages. As this evolution continues, knowledge of LISP, PROLOG, or Smalltalk and the programming techniques they enable will only increase in value. We are confident that this will be true, whether you continue to use one of these classic AI languages, or find yourself programming in C++, Objective C, Java or one of their other competitors, descendants, or distant cousins.

AN INTRODUCTION TO PROLOG

9

All the objects of human reason or inquiry may naturally be divided into two kinds, to wit, "Relations of Ideas" and "Matters of Fact."

—DAVID HUME, "An Inquiry Concerning Human Understanding"

The only way to rectify our reasonings is to make them as tangible as those of the mathematicians, so that we can find our error at a glance, and when there are disputes among persons we can simply say, "Let us calculate... to see who is right."

—LEIBNIZ, *The Art of Discovery*

9.0 Introduction

As an implementation of logic as a programming language, PROLOG has made many interesting contributions to AI problem solving. These include its *declarative semantics*, a means of directly expressing problem relationships in AI, as well as, with built-in unification, some high-powered techniques for pattern matching and search. We address many of the important issues of *logic programming* in this chapter.

In Section 9.1 we present the basic PROLOG syntax and several simple programs. These programs demonstrate the use of the predicate calculus as a representation language. We show how to monitor the PROLOG environment and demonstrate the use of the cut with PROLOG's implicit depth-first control to improve efficiency.

In Section 9.2 we create *abstract data types* (ADTs) in PROLOG. These ADTs include *stacks*, *queues*, and *priority queues*, which are then used to build a production system in Section 9.3 and to design control structures for the search algorithms of Chapters 3, 4, and 6 in Section 9.4. In Section 9.5 we create a *planner*, after the material presented in Section 5.4. In Section 9.6 we introduce *meta-predicates*, predicates whose domains of interpretation are PROLOG expressions themselves. For example `atom(X)` succeeds if `X` is bound to an atom. Meta-predicates may be used for imposing type constraints on

PROLOG interpretations. In Section 9.7 meta-predicates are used for building *meta-interpreters* in PROLOG. Meta-interpreters are used to build a PROLOG interpreter in PROLOG, as well as to build interpreters for rule chaining and inheritance searches.

In Section 9.8 we examine PROLOG as a nonprocedural problem-solving representation and give several small examples, including the design of context-free and context-sensitive parsers, to emphasize this important concept. The chapter ends with the discussion of the general issues of programming in logic and procedural versus declarative problem solving.

9.1 Syntax for Predicate Calculus Programming

9.1.1 Representing Facts and Rules

Although there are numerous dialects of PROLOG, the syntax used throughout this text is the original Warren and Pereira C-PROLOG (Clocksin and Mellish 1984). To simplify our presentation of PROLOG, our version of predicate calculus syntax in Chapter 2 used many PROLOG conventions. There are, however, a number of differences between PROLOG and predicate calculus syntax. In C-PROLOG, for example, the symbol :- replaces the \leftarrow of first-order predicate calculus. Other symbols differ from those used in Chapter 2:

ENGLISH	PREDICATE CALCULUS	PROLOG
and	\wedge	,
or	\vee	;
only if	\leftarrow	:-
not	\neg	not

As in Chapter 2, predicate names and bound variables are expressed as a sequence of alphanumeric characters beginning with an alphabetic. Variables are represented as a string of alphanumeric characters beginning (at least) with an uppercase alphabetic. Thus:

likes(X, susie).

or, better,

likes(Everyone, susie).

could represent the fact that "everyone likes Susie." Or,

likes(george,Y), likes(susie,Y).

could represent the set of things (or people) that are liked by both George and Susie.

Similarly, suppose it was desired to represent in PROLOG the following relationships: "George likes Kate and George likes Susie." This could be stated as:

```
likes(george, kate), likes(george, susie).
```

Likewise, "George likes Kate or George likes Susie":

```
likes(george, kate); likes(george, susie).
```

"George likes Susie if George likes Kate":

```
likes(george, susie) :- likes(george, kate).
```

Finally, the negation of a predicate, "Kate does not like Susie":

```
not(likes(kate, susie)).
```

These examples show how the predicate calculus connectives \wedge , \vee , \neg , and \leftarrow are expressed in PROLOG. The predicate names (*likes*), the number or order of parameters, and even whether a given predicate always has the same number of parameters are determined by the design requirements (the implicit "semantics") of the problem. There are no expressive limitations other than the syntax of well-formed formulae in the language.

A PROLOG program is a set of specifications in the first-order predicate calculus describing the objects and relations in a problem domain. The set of specifications, or what is true about a particular problem situation, is referred to as the *database* for that problem. The PROLOG interpreter responds to questions about this set of specifications. Queries to the database are patterns in the same logical syntax as the database entries. The PROLOG interpreter uses pattern-directed search to find whether these queries logically follow from the contents of the database (see the abstract specification of PROLOG search in Section 9.7).

The interpreter processes queries, searching the database to find out whether the query is a logical consequence of the database of specifications. PROLOG is primarily an interpreted language. Some versions of PROLOG run in interpretive mode only, while others allow compilation of part or all of the set of database specifications for faster execution. PROLOG is an interactive language; the user enters queries in response to the PROLOG prompt: `?- .` This prompt appears in all PROLOG examples in this chapter.

Suppose that we wish to describe a "world" consisting of George's, Kate's, and Susie's likes and dislikes. The database might contain the following set of predicates:

```
likes(george, kate).
likes(george, susie).
likes(george, wine).
likes(susie, wine).
likes(kate, gin).
likes(kate, susie).
```

This set of specifications has the obvious interpretation, or mapping, into the world of George and his friends. This world is a model for the database (Section 2.3). The interpreter may then be asked questions:

```
?- likes(george, kate).
yes
?- likes(kate, susie).
yes
?- likes(george, X).
X = kate
;
X = susie
;
X = wine
;
no
?- likes(george, beer).
no
```

Note several things in these examples. First, in the request `likes(george, X)`, successive user prompts (`;`) cause the interpreter to return all the terms in the database specification that may be substituted for the `X` in the query. They are returned in the order in which they are found in the database: `kate` before `susie` before `wine`. Although it goes against the philosophy of nonprocedural specifications, a determined order of evaluation is a property of most interpreters implemented on sequential machines. The PROLOG programmer must be aware of the order in which PROLOG searches entries in the database.

Also note that further responses to queries are produced when the user prompts with the `;` (or). This forces a backtrack on the most recent result. Continued prompts force PROLOG to find all possible solutions to the query. When no further solutions exist, the interpreter responds `no`.

The above example also illustrates the *closed world assumption* or *negation as failure*. PROLOG assumes that “anything is false whose opposite is not provably true.” In the query `likes(george, beer)`, the interpreter looks for the predicate `likes(george, beer)` or some rule that could establish `likes(george, beer)`. Failing this, the request is false. Thus, PROLOG assumes that all knowledge of the world is present in the database.

The closed world assumption introduces a number of practical and philosophical difficulties in the language. For example, failure to include a fact in the database often means that its truth is unknown; the closed world assumption treats it as false. If a predicate were omitted or there were a misspelling, such as `likes(george, beeer)`, the response remains `no`. The negation-as-failure issue is a very important topic in AI research. Though negation as failure is a simple way to deal with the problem of unspecified knowledge, more sophisticated approaches, such as multivalued logics (true, false, unknown) and nonmonotonic reasoning (see Chapter 7), provide a richer interpretive context. Several of these issues are addressed again in the chapters on advanced representations.

The PROLOG expressions used in the database above are examples of *fact* specifications. PROLOG also lets us define *rules* to describe relationships between facts using the logical implication, :- . In creating a PROLOG rule, only one predicate is permitted on the left-hand side of the if symbol, :- ; this predicate must be a *positive literal*, which means it cannot be negated (Section 13.3). All predicate calculus expressions that contain implication or equivalence relationships (\leftarrow , \rightarrow , and \leftrightarrow) must be reduced to this form, referred to as *Horn clause logic*. In Horn clause form, the left-hand side (conclusion) of an implication must be a single positive literal. The *Horn clause calculus* is equivalent to the full first-order predicate calculus for proofs by refutation. (See Chapter 12.)

Suppose we add to the specifications of the previous database a rule for determining whether two people are friends. This may be defined:

```
friends(X, Y) :- likes(X, Z), likes(Y, Z).
```

This expression might be interpreted as "X and Y are friends if there exists a Z such that X likes Z and Y likes Z." Two issues are important here. First, because neither the predicate calculus nor PROLOG has global variables, the scope (extent of definition) of X, Y, and Z is limited to the friends rule. Second, values bound to, or unified with, X, Y, and Z are consistent across the entire expression. The treatment of the friends rule by the PROLOG interpreter is seen in the following example.

With the friends rule added to the set of specifications of the preceding example, we can query the interpreter:

```
?- friends(george, susie).  
yes
```

To solve the query, PROLOG searches the database using the backtrack algorithm presented in Chapters 3 and 5. The query friends(george, susie) is matched or unified with the conclusion of the rule friends(X, Y) :- likes(X, Z), likes(Y, Z), with X as george and Y as susie. The interpreter looks for a Z such that likes(george, Z) is true. This is first attempted using the first fact in the database, with Z as kate.

The interpreter then tries to determine whether likes(susie, kate) is true. When it is found to be false, using the closed world assumption, the value for Z (kate) is rejected. The interpreter then goes back to the database (backtracks) to find a second value for Z in likes(george, Z).

likes(george, Z) then matches the second clause in the database, with Z bound to susie. The interpreter then tries to match likes(susie, susie). When this also fails, the interpreter goes back to the database (backtracks) for yet another value for Z. This time wine is found in the third predicate, and the interpreter goes on to show that likes(susie, wine) is true. In this case wine is the binding that ties george and susie. Note that PROLOG tries to match goals with patterns in the order in which these patterns are entered in the database.

It is important to state the relationship between universal and existential quantification in the predicate calculus and the treatment of variables in a PROLOG program. When a

variable is placed in the specifications of a PROLOG database, the variable is assumed to be universally quantified. For example, `likes(susie, Y)` means, according to the semantics of the previous examples, "Susie likes everyone." In the course of interpreting some query, any term, or list or predicate, may be bound to Y. Similarly, in the rule `friends(X, Y) :- likes(X, Z), likes(Y, Z)`, any X, Y, and Z that meet the specifications of the expression are acceptable variable bindings.

To represent an existentially quantified variable in PROLOG, we may take two approaches. First, if the existential value of a variable is known, that value may be entered directly into the database. Thus, `likes(george, wine)` is an instance of `likes(george, Z)` and may be thus entered into the database, as it was in the previous examples.

Second, to find an instance of a variable that makes an expression true, we query the interpreter. For example, to find whether a Z exists such that `likes(george, Z)` is true, we put this query directly to the interpreter. It will find whether a value of Z exists under which the expression is true. Some PROLOG interpreters find all existentially quantified values; C-PROLOG requires repeated user prompts (;) to get all values.

9.1.2 Creating, Changing, and Monitoring the PROLOG Environment

In creating a PROLOG program the database of specifications must first be created. In the interactive PROLOG environment the PROLOG predicate `assert` is used to add a new predicate to the present set of specifications. Thus:

```
?- assert(likes(david, sarah)).
```

adds this predicate to the computing specifications. Now, with the query:

```
?- likes(david, X).  
X = sarah.
```

is returned. `assert` allows further control in adding new specifications to the database: `asserta(P)` asserts the predicate P at the beginning of all the predicates P, and `assertz(P)` adds P at the end of all the predicates named P. This is important for search priorities and building heuristics, as is discussed in Chapters 5, 6, 7, and 12. To remove a predicate P from the database of specifications `retract(P)` may be used.

It soon becomes tedious to create a set of specifications using the predicates `assert` and `retract`. Instead, the programmer takes her favorite editor and creates a file containing all the PROLOG specifications. Once this file is created (let's call it `myfile`) and PROLOG is called, then the file is placed in the database by the PROLOG command `consult`. Thus:

```
?- consult(myfile).  
yes
```

adds the predicates in `myfile` to the database. A short form of the `consult` predicate, and better for adding multiple files to the database, uses the list notation, to be seen shortly:

?- [myfile].
yes

The predicates `read` and `write` are important for user communication. `read(X)` takes the next term from the current input stream and binds it to `X`. Input expressions are terminated with a “.”. `write(X)` puts `X` in the output stream. If `X` is unbound then an integer preceded by an underline is printed (`_69`). This integer represents the internal bookkeeping on variables necessary in a theorem-proving environment (Chap. 12) and can be useful in debugging.

The PROLOG predicates `see` and `tell` are used to read information from and place information into files. `see(X)` opens the file `X` and defines the current input stream as originating in `X`. If `X` is not bound to an available file `see(X)` fails. Similarly, `tell(X)` opens a file for the output stream. If no file `X` exists, `tell(X)` creates a file named by the bound value of `X`. `seen(X)` and `told(X)` close the respective files.

A number of PROLOG predicates are important in helping us keep track of the state of the PROLOG database as well as the state of computing about the database; the most important of these are `listing`, `trace`, and `spy`. If we use `listing(predicate_name)` where `predicate_name` is the name of a predicate, such as `member` (Section 9.1.3), all the clauses with that predicate name in the database are returned by the interpreter. Note that the number of arguments of the predicate is not indicated; in fact, all uses of the predicate, regardless of the number of arguments, are returned.

`trace` allows the user to monitor the progress of the PROLOG interpreter. This monitoring is accomplished by printing to the output file every goal that PROLOG attempts, which is often more information than the user wants to have. The tracing facilities in many PROLOG environments are rather cryptic and take some study and experience to understand. The information available in a trace of a running PROLOG program usually includes the following:

1. The depth level of recursive calls (marked left to right on line).
2. When a goal is tried for the first time (sometimes `call` is used).
3. When a goal is successfully satisfied (with an `exit`).
4. When a goal has further matches possible (a `retry`).
5. When a goal fails because all attempts to satisfy it have failed (`fail` is often used).
6. The goal `notrace` stops the exhaustive tracing.

When a more selective trace is required the goal `spy` is useful. This predicate usually takes a predicate name as argument but sometimes is defined as a prefix operator where the predicate to be monitored is listed after the operator. Thus, `spy member` causes the interpreter to print to output all uses of the predicate `member`. `spy` can also take a list of predicates followed by their arities: `spy[member/2,append/3]` sets monitoring of the interpreter on all uses of the goals `member` with two arguments and `append` with three. `nospyspy` removes these `spy` points.

9.1.3 Recursion-Based Search in PROLOG

The previous subsections presented PROLOG syntax in several simple examples. These examples introduced PROLOG as an engine for computing with predicate calculus expressions (in Horn clause form). This is consistent with all the principles of predicate calculus inference presented in Chapter 2. PROLOG uses unification for pattern matching and returns the bindings that make an expression true. These values are unified with the variables in a particular expression and are not bound in the global environment.

Recursion is the primary control mechanism for PROLOG programming. We will demonstrate this with several examples. But first we consider some simple list-processing examples. The list is a data structure consisting of ordered sets of elements (or, indeed, lists). Recursion is the “natural” way to process the list structure. Unification and recursion come together in list processing in PROLOG. List elements are enclosed by brackets [] and are separated by commas. Examples of PROLOG lists are:

```
[1, 2, 3, 4]
[[george, kate], [allen, amy], [don, pat]]
[tom, dick, harry, fred]
[]
```

The first elements of a list may be separated from the tail of the list by the bar operator, |. The tail of a list is the list with its first element removed. For instance, when the list is [tom,dick,harry,fred], the first element is tom and the tail is the list [dick, harry, fred]. Using the vertical bar operator and unification, we can break a list into its components:

If [tom,dick,harry,fred] is matched to [X|Y], then X = tom and Y = [dick,harry,fred].

If [tom,dick,harry,fred] is matched to [X,Y|Z], then X = tom, Y = dick, and Z = [harry,fred].

If [tom,dick,harry,fred] is matched to [X,Y,Z|W], then X = tom, Y = dick, Z = harry, and W = [fred].

If [tom,dick,harry,fred] is matched to [W,X,Y,Z|V], then W = tom, X = dick, Y = harry, Z = fred, and V = [].

[tom,dick,harry,fred] will not match [V,W,X,Y,Z|U].

[tom,dick,harry,fred] will match [tom,X|[harry,fred]], to give X = dick.

Besides “tearing lists apart” to get at particular elements, unification can be used to “build” the list structure. For example, if X = tom, Y = [dick], and L unifies with [X|Y], then L will be bound to [tom,dick]. Thus terms separated by commas before the | are all elements of the list, and the structure after the | is always a list, the tail of the list.

Let’s take a simple example of recursive processing of lists: the member check. We define a predicate to determine whether an item, represented by X, is in a list. This predicate member takes two arguments, an element and a list, and is true if the element is a member of the list. For example:

```

?- member(a, [a, b, c, d, e]).
yes
?- member(a, [1, 2, 3, 4]).
no
?- member(X, [a, b, c]).
X = a
;
X = b
;
X = c
;
no

```

To define `member` recursively, we first test if `X` is the first item in the list:

```
member(X,[X | T]).
```

This tests whether `X` and the first element of the list are identical. If they are not, then it is natural to check whether `X` is an element of the rest (`T`) of the list. This is defined by:

```
member(X,[Y | T]) :- member(X,T).
```

The two lines of PROLOG for checking list membership are then:

```
member(X,[X | T]).
member(X,[Y | T]) :- member(X,T).
```

This example illustrates the importance of PROLOG's built-in order of search with the terminating condition placed before the recursive call. Thus termination is tested before the algorithm recurs. If the order of the predicates is reversed, the terminating condition may never be checked. We now trace `member(c,[a,b,c])`, with numbering:

```

1: member(X,[X | T]).
2: member(X,[Y | T]) :- member(X,T).

?- member(c,[a,b,c]).
  call 1. fail, since c ≠ a
  call 2. X = c, Y = a, T = [b,c], member(c,[b,c])?
    call 1. fail, since c ≠ b
    call 2. X = c, Y = b, T = [c], member(c,[c])?
      call 1. success, c = c
    yes (to second call 2.)
  yes (to first call 2.)
yes

```

Good PROLOG style suggests the use of *anonymous variables*. These serve as an indication to the programmer and interpreter that certain variables are used solely for

pattern-matching purposes, with the variable binding itself not part of the computation process. Thus, when we test whether the element X is the same as the first item in the list we usually say: `member(X,[X|_])`. The use of the `_` indicates that even though the tail of the list plays a crucial part in the unification of a query, the content of the tail of the list is unimportant. In the `member` check the anonymous variable should be used in the recursive statement as well, where the value of the head of the list is unimportant:

```
member(X,[X|_]).
member(X,[_|T]) :- member(X,T).
```

Of course, many programmers also prefer more specific variable names, such as `Item` rather than `X` and `Tail` rather than `T`.

Writing out a list one element to a line is a nice exercise for understanding both lists and recursive control. Suppose we wish to write out the list `[a,b,c,d]`. We could define the recursive command:

```
writelist([ ]).
writelist([H|T]) :- write(H), nl, writelist(T).
```

This predicate writes one element of the list on each line, as `nl` requires the output stream controller to begin a new line. If we wish to write out a list in reversed order the recursive predicate must come before the `write` command. This guarantees that the list is traversed to the end before any element is written. At that time the last element of the list is written followed by each preceding element as the recursive control comes back up to the top. A reverse write of a list would be:

```
reverse_writelist([ ]).
reverse_writelist([H|T]) :- reverse_writelist(T), write(H), nl.
```

The reader should run `writelist` and `reverse_writelist` with `trace` to observe the behavior of these predicates.

9.1.4 Recursive Search in PROLOG

In Section 5.2 we introduced the 3×3 knight's tour problem for the predicate calculus. We represented the board squares for the knight moves like this:

1	2	3
4	5	6
7	8	9

The legal moves are represented in PROLOG using a `move` predicate. The `path` predicate defines an algorithm for finding a path of zero or more moves between its arguments. Note that `path` is defined recursively:

```

move(1,6).      move(3,4).      move(6,7).      move(8,3).
move(1,8).      move(3,8).      move(6,1).      move(8,1).
move(2,7).      move(4,3).      move(7,6).      move(9,4).
move(2,9).      move(4,9).      move(7,2).      move(9,2).

```

```

path(Z,Z).
path(X,Y) :- move(X,W), not(been(W)), assert(been(W)), path(W,Y).

```

This definition of `path` is a PROLOG implementation of the algorithm defined in Chapter 5. As noted above, `assert` is a built-in PROLOG predicate that always succeeds and has the side effect of placing its argument in the database of specifications. The `been` predicate is used to record previously visited states and avoid loops.

This use of the `been` predicate violates the program designer's goal of creating predicate calculus specifications that do not use global variables. Thus `been(3)`, when asserted into the database, is indeed a fact available to any other procedure in the database and, as such, has global extension. Even more important, creating global structures to alter program control violates the basic tenet of the production system model, where the logic (of problem specifications) is kept separate from the control of the program. Here `been` structures were created as global specifications to modify the execution of the program itself.

As we proposed in Chapter 3, a list may be used to keep track of visited states and thus keep the `path` call from looping. The `member` predicate is used to detect duplicate states (loops). This approach remedies the problems of using global `been(W)` assertions. The PROLOG-based specification of the following clauses exactly implements the depth-first graph search with the backtracking algorithm of Chapters 3 and 5:

```

path(Z,Z,L).
path(X,Y,L) :- move(X,Z), not(member(Z,L)), path(Z,Y,[Z|L]).

```

where:

```

member(X,[X|_]).
member(X,[_|_]) :- member(X,_).

```

The third parameter of `path` is the local variable representing the list of states that have already been visited. When a new state is generated (using the `move` predicate) and this state is not already on the list of visited states, `not(member(Z,L))`, it is placed on the front of the state list `[Z|L]` for the next `path` call.

It should be noted that all the parameters of `path` are local and their current values depend on where they are called in the graph search. Each recursive call adds a state to this list. If all continuations from a certain state fail, then that particular `path` call fails. When the interpreter backs up to the parent call, the third parameter, representing the list of states

visited, has its previous value. Thus, states are added to and deleted from this list as the backtracking search moves through the graph.

When the `path` call finally succeeds, the first two parameters are identical. The third parameter is the list of states visited on the solution path, in reverse order. Thus we can print out the steps of the solution. The PROLOG specification for the knight's tour problem using lists and a depth-first search employing backtrack may be obtained by using this definition of `path` with the `move` specifications and `member` predicates just presented.

The call to the PROLOG interpreter `path(X,Y,[X])`, where `X` and `Y` are replaced by numbers between 1 and 9, finds a path from state `X` to state `Y`, if the path exists. The third parameter initializes the path list with the starting state `X`. Note that there is no typing distinction in PROLOG: the first two parameters are any representation of states in the problem space and the third is a list of states. Unification makes this generalization of pattern matching across data types possible. Thus, `path` is a general depth-first search algorithm that may be used with any graph. In Section 9.3 we use this to implement a production system solution to the farmer, wolf, goat, and cabbage problem, with state specifications replacing square numbers in the call to `path`.

We now present the trace of a solution for the 3×3 knight's tour. It is left as an exercise for the reader to design the set of specifications for the full 8×8 knight's tour problem in PROLOG. (See exercises in Chapters 5 and 6.)

For this example we refer to the two parts of the `path` algorithm by number:

1. is `path(Z,Z,L)`.
2. is `path(X,Y,L) :- move(X,Z), not(member(Z,L)), path(Z,Y,[Z|L])`.

?- `path(1,3,[1])`.

`path(1,3,[1])` attempts to match 1. fail $1 \neq 3$.

`path(1,3,[1])` matches 2. `X` is 1, `Y` is 3, `L` is [1]

`move(1,Z)` matches `Z` as 6, `not(member(6,[1]))` is true, call `path(6,3,[6,1])`

`path(6,3,[6,1])` attempts to match 1. fail $6 \neq 3$.

`path(6,3,[6,1])` matches 2. `X` is 6, `Y` is 3, `L` is [6,1].

`move(6,Z)` matches `Z` as 7, `not(member(7,[6,1]))` is true, `path(7,3,[7,6,1])`

`path(7,3,[7,6,1])` attempts to match 1. fail $7 \neq 3$.

`path(7,3,[7,6,1])` matches 2. `X` is 7, `Y` is 3, `L` is [7,6,1].

`move(7,Z)` is `Z = 6`, `not(member(6,[7,6,1]))` fails, backtrack!

`move(7,Z)` is `Z = 2`, `not(member(2,[7,6,1]))` true, `path(2,3,[2,7,6,1])`

`path` call attempts 1, fail, $2 \neq 3$.

`path` matches 2, `X` is 2, `Y` is 3, `L` is [2,7,6,1]

`move` matches `Z` as 7, `not(member(...))` fails, backtrack!

`move` matches `Z` as 9, `not(member(...))` true, `path(9,3,[9,2,7,6,1])`

`path` fails 1, $9 \neq 3$.

`path` matches 2, `X` is 9, `Y` is 3, `L` is [9,2,7,6,1]

```
move is Z = 4, not(member(...)) true, path(4,3,[4,9,2,7,6,1])
path fails 1, 4 ≠ 3.
path matches 2, X is 4, Y is 3, L is [4,9,2,7,6,1]
  move Z = 3, not(member(...)) true, path(3,3,[3,4,9,2,7,6,1])
```

```
    path attempts 1, true, 3 = 3, yes
```

```
yes
```

```
yes
```

```
yes
```

```
yes
```

```
yes
```

```
yes
```

In summary, the recursive path call is a *shell* or general control structure for search in a graph. All the checks are made for a graph search algorithm: in `path(X,Y,L)`, `X` is the present state; `Y` is the goal state. When `X` and `Y` are identical, the recursion terminates. `L` is the list of states on the current path to state `Y`, and as each new state `Z` is found with the call `move(X,Z)` it is placed on the list: `[Z|L]`. The state list is checked, using `not(member(Z,L))`, to be sure the path does not loop.

The difference between the state list `L` in the path call above and closed in Chapter 5 is that closed records all states visited, while the state list `L` keeps track of only the present path. It is straightforward to expand the record keeping in the path call to record all visited states and we do this in Section 9.4.

9.1.5 The Use of Cut to Control Search in PROLOG

The *cut* is represented by an exclamation point, `!`. The syntax for cut is that of a goal with no arguments. It has several side effects: first, when originally encountered it always succeeds and, second, if it is “failed back to” in the normal course of backtracking, it causes the entire goal in which it is contained to fail.

For a simple example of the effect of the cut, recall the two-move path call from the knight’s tour example of Section 4.2. There the predicate `path2` could be created:

```
path2(X,Y) :- move(X,Z), move(Z,Y).
```

(There is a two-move path between `X` and `Y` if there exists an intermediate stop `Z` between them.) For this example, assume part of the knight’s database:

```
move(1,6).
move(1,8).
```

```
move(6,7).
move(6,1).
move(8,3).
move(8,1).
```

The interpreter is asked to find all the two-move paths from 1; there are four answers:

```
?- path2(1,W).
W = 7
;
W = 1
;
W = 3
;
W = 1
;
no
```

When path2 is altered to contain the cut and the same goal is presented:

```
path2(X,Y) :- move(X,Z), !, move(Z,Y).
```

```
?- path2(1,W).
```

only two answers result:

```
W = 7
;
W = 1
;
no
```

This happens because variable **Z** takes on only one value (the first value it is bound to), namely 6. Once the first subgoal succeeds, **Z** is bound to 6 and the cut is encountered. This prohibits further backtracking to the first subgoal and no further bindings for **Z**.

There are several uses for the cut in programming. First, as this example demonstrated, it allows the programmer to control explicitly the shape of the search tree. When further (exhaustive) search is not required, the tree can be explicitly pruned at that point. This allows PROLOG code to have the flavor of function calling: when one set of values (bindings) is "returned" by a PROLOG predicate (or set of predicates) and the cut is encountered, the interpreter does not search for other unifications. If that set of values does not lead on to a solution then no further values are attempted.

A second use of cut controls recursion. For example in the path call:

```
path(Z,Z,L).
path(X,Z,L) :- move(X,Y), not(member(Y,L)), path(Y,Z,[Y|L]), !.
```

the addition of cut means that (at most) one solution to the graph search is produced. Only one solution is produced because further solutions occur after the clause `path(Z,Z,L)` is satisfied. If the user asks for more solutions, `path(Z,Z,L)` fails, and the second `path` call is reinvoked to continue the (exhaustive) search of the graph. When the cut is placed after the recursive `path` call, the call cannot be reentered (backed into) for further search.

Important side effects of the cut are to make the program run faster and to conserve memory locations. When cut is used within a predicate, the pointers in memory needed for backtracking to predicates to the left of the cut are not created. This is, of course, because they will never be needed. Thus, cut produces the desired solution, and only the desired solution, with more efficient use of memory.

The cut can also be used with recursion to reinitialize the `path` call for further search within the graph. When searching through a series of rules, PROLOG stores an activation record of each unification on an internal stack. This stack keeps track of the successive calls to a recursive predicate. Sometimes in a recursive predicate we need to retain only the most recent bindings of the parameters. The cut is then placed after the recursive call to keep the interpreter from recording all parent calls on the stack. This prevents the stack from getting too cumbersome and makes the program more efficient. We will use the cut in this fashion when we build the open and closed lists with breadth-first and best-first search algorithms in Section 9.4.

9.2 Abstract Data Types (ADTs) in PROLOG

Programming in any environment is enhanced by procedural abstractions and information hiding. Because the `set`, `stack`, `queue`, and `priority queue` data structures were the support constructs for the graph search algorithms of Chapters 3, 4, and 5, we build them in PROLOG in the present section and then use them in the design of the PROLOG search algorithms presented later in this chapter.

Recursion, lists, and pattern matching, as emphasized throughout this book, are the primary tools for building and searching graph structures. These are the pieces with which we build our ADTs. All list handling and recursive processing are “hidden” within the ADT abstraction.

9.2.1 The ADT Stack

A *stack* is a linear structure with access at one end only. Thus all elements must be added to, pushed, and removed, popped, from the structure at that end of access. The stack is sometimes referred to as a last-in-first-out (LIFO) data structure. We saw its use with depth-first search in Section 3.2.3. The operators defined for a stack are:

1. Test whether the stack is empty.
2. Push an element onto the stack.

3. Pop, or remove, an element from the stack.
4. Peek at the next element on the stack without popping it.

Stack operators are sometimes augmented by:

5. `Member_stack`, which checks whether an element is in the stack.
6. `Add_list`, which adds a list of elements to the stack.

Both 5 and 6 may be built from 1–4.

We now build these operators in PROLOG. As just noted, we use the list primitives:

1. `empty_stack([])`. This predicate can be used either to test a stack to see whether it is empty or to generate a new empty stack.
- 2–4. `stack(Top, Stack, [Top | Stack])`. This predicate performs the push, pop, and peek predicates depending on the variable bindings of its arguments. For instance, `push` produces a new stack as the third argument when the first two arguments are bound. Likewise, `pop` produces the top element of the stack when the third argument is bound to the stack. The second argument will then be bound to the new stack, once the top element is popped. Finally, if we keep the stack as the third argument, the first argument lets us peek at its top element.
5. `member_stack(Element, Stack) :- member(Element, Stack)`. This allows us to determine whether an element is a member of the stack. Of course, the same result could be produced by creating a recursive call that peeked at the next element of the stack and then, if this element did not match `Element`, popped the stack. This would continue until the empty stack predicate was true.
6. `add_list_to_stack(List, Stack, Result) :- append(List, Stack, Result)`. This adds `List` to `Stack` to produce `Result`, a new stack. Of course, the same result could be obtained by popping `List` and pushing each element onto a temporary stack until `empty_stack` is true of `List`. We then pop the temporary stack and push each element onto the `Stack` until `empty_stack` is true of the temporary stack. `append` is described in detail in Section 9.8.

A final predicate for printing a stack in reverse order is `reverse_print_stack`. This is very useful when a stack has, in reversed order, the current path from the start state to the present state of the graph search. We see several examples of this in the next subsections.

```
reverse_print_stack(S) :- empty_stack(S).
reverse_print_stack(S) :-
    stack(E, Rest, S),
    reverse_print_stack(Rest),
    write(E), nl.
```

9.2.2 The ADT Queue

A *queue* is a first-in-first-out (FIFO) data structure. It is often characterized as a list where elements are taken off (dequeued) from one end and added to (enqueued) at the other end. The queue was used for defining breadth-first search in Chapters 3 and 4. The queue operators are:

1. `empty_queue([])`. This predicate either tests whether a queue is empty or initializes a new empty queue.
2. `enqueue(E,[],[E])`.
`enqueue(E,[H|T],[H|Tnew]) :- enqueue(E,T,Tnew)`. This recursive predicate adds the element `E` to a queue, the second argument. The new augmented queue is the third argument.
3. `dequeue(E,[E|T],T)`. This predicate produces a new queue, the third argument, that is the result of taking the next element, the first argument, off the original queue, the second argument.
4. `dequeue(E,[E|T],_)`. This predicate lets us peek at the next element, `E`, of the queue.
5. `member_queue(Element,Queue) :- member(Element,Queue)`. This allows us to determine whether `Element` is a member of `Queue`.
6. `add_list_to_queue(List,Queue,Newqueue) :- append(Queue,List,Newqueue)`. This enqueues an entire list of elements.

Of course, 5 and 6 can be created using only 1–4; `append` is presented in Section 9.8.

9.2.3 The ADT Priority Queue

A *priority queue* orders the elements of a regular queue so that each new entrant to the priority queue is placed in its sorted order. The dequeue operator removes the “best” sorted element from the priority queue. We used the priority queue in the design of best-first search in Chapter 4.

Because the priority queue is a sorted queue, many of its operators are the same as the queue operators, in particular, `empty_queue`, `member_queue`, `dequeue` (the “best” of the sorted elements will be next for the `dequeue`), and `peek`. We will call `enqueue` in a priority queue the `insert_pq` operator, as each new item must be placed in its proper sorted order.

```
insert_pq(State,[ ],[State]).
insert_pq(State,[H|Tail],[State,H|Tail]) :-
    precedes(State,H).
insert_pq(State,[H|T],[H|Tnew]) :-
    insert_pq(State,T,Tnew).
```

The first argument of this predicate is the new element that is to be inserted. The second argument is the previous priority queue, and the third argument is the augmented priority queue. The `precedes` predicate that checks the order of elements is defined by the application.

Another priority queue operator is `insert_list_pq`. This predicate is used to merge an unsorted list or set of elements into the priority queue, as is necessary when adding the children of a state to the priority queue for best-first search (Chapter 4 and Section 9.4.3). `insert_list_pq` uses `insert_pq` to put each individual new item into the priority queue:

```
insert_list_pq([ ], L, L).
insert_list_pq([State | Tail], L, New_L) :-
    insert_pq(State, L, L2),
    insert_list_pq(Tail, L2, New_L).
```

9.2.4 The ADT Set

Finally, we describe the ADT set. A *set* is a collection of elements with no element repeated. Sets can be used for collecting all the children of a state or for maintaining closed in a search algorithm, as in Chapters 3 and 4. A set of elements, e.g., {a,b}, is represented as a list, [a,b], with order not important. The set operators include `empty_set`, `member_set`, `delete_if_in`, and `add_if_not_in`. We have operators for combining and comparing sets, including union, intersection, `set_difference`, `subset`, and `equal_set`.

```
empty_set([ ]).

member_set(E,S) :-
    member(E,S).
delete_if_in_set(E,[ ],[ ]).
delete_if_in_set(E,[E | T],T) :- !.
delete_if_in_set(E,[H | T],[H | T_new]) :-
    delete_if_in_set(E,T,T_new), !.

add_if_not_in_set(X,S,S) :-
    member(X,S), !.
add_if_not_in_set(X,S,[X | S]).

union([ ],S,S).
union([H | T],S,S_new) :-
    union(T,S,S2),
    add_if_not_in_set(H,S2,S_new),!.

subset([ ],_).
subset([H | T],S) :-
    member_set(H,S),
    subset(T,S).
```

```

intersection([ ],_,[ ]).
intersection([H|T],S,[H|S_new]) :-
    member_set(H,S),
    intersection(T,S,S_new), !.
intersection([_|T],S,S_new) :-
    intersection(T,S,S_new), !.

```

```

set_diff([ ],_,[ ]).
set_diff([H|T],S,T_new) :-
    member_set(H,S),
    set_diff(T,S,T_new), !.
set_diff([H|T],S,[H|T_new]) :-
    set_diff(T,S,T_new), !.

```

```

equal_set(S1,S2) :-
    subset(S1,S2),
    subset(S2,S1).

```

9.3 A Production System Example in PROLOG

In this section we write a production system solution to the farmer, wolf, goat, and cabbage problem. This problem is stated as follows:

A farmer with his wolf, goat, and cabbage come to the edge of a river they wish to cross. There is a boat at the river's edge, but, of course, only the farmer can row. The boat also can carry only two things (including the rower) at a time. If the wolf is ever left alone with the goat, the wolf will eat the goat; similarly, if the goat is left alone with the cabbage, the goat will eat the cabbage. Devise a sequence of crossings of the river so that all four characters arrive safely on the other side of the river.

In the next paragraphs we present a production system solution to this problem. First, we observe that the problem may be represented as a search through a graph. To do this we consider the possible moves that might be available at any time in the solution process. Some of these moves are eventually ruled out because they produce states that are unsafe (something will be eaten).

For the moment, suppose that all states are safe, and simply consider the graph of possible states. The boat can be used in four ways: to carry the farmer and wolf, the farmer and goat, the farmer and cabbage, and the farmer alone. A state of the world is some combination of the characters on the two banks. Several states of the search are represented in Figure 9.1. States of the world are represented using a predicate, `state(F, W, G, C)`, with the location of the farmer as first parameter, location of the wolf as second parameter, the goat as third, and the cabbage as fourth. We assume that the river runs "north to south" and that the characters are on either the east, `e`, or west, `w`, bank. Thus, `state(w, w, w, w)` has all characters on the west bank to start the problem.

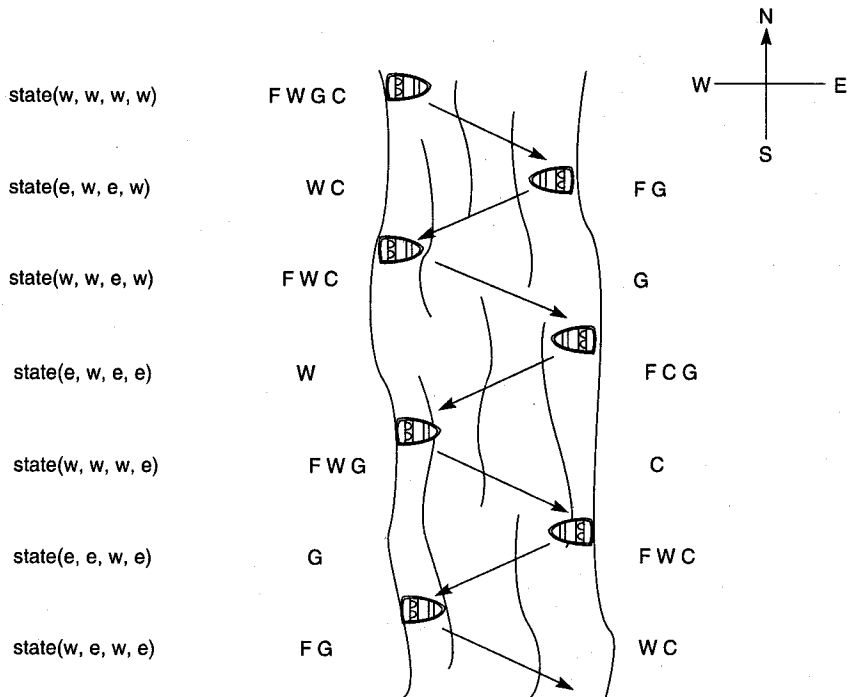

Figure 9.1 Sample crossings for the farmer, wolf, goat, and cabbage problem.

It must be pointed out that these choices are conventions that have been arbitrarily chosen by the authors. Indeed, as researchers in AI continually point out, the selection of an appropriate representation is often the most critical aspect of problem solving. These conventions are selected to fit the predicate calculus representation in PROLOG. Different states of the world are created by different crossings of the river, represented by changes in the values of the parameters of the `state` predicate as in Figure 9.1. Other representations are certainly possible.

We now describe a general graph for this river-crossing problem. For the time being, we ignore the fact that some states are unsafe. In Figure 9.2 we see the beginning of the graph of possible moves back and forth across the river. Note that in this graph it is not necessary to have a separate representation for the location of the boat (why?). Figure 9.2 represents part of the graph that is to be searched for a solution path.

The recursive `path` call previously described provides the control mechanism for the production system search. The production rules are the rules for changing state in the search. We define these as `move` rules in PROLOG form.

Because PROLOG uses Horn clauses, a production system designed in PROLOG must either represent production rules directly in Horn clause form or translate rules to

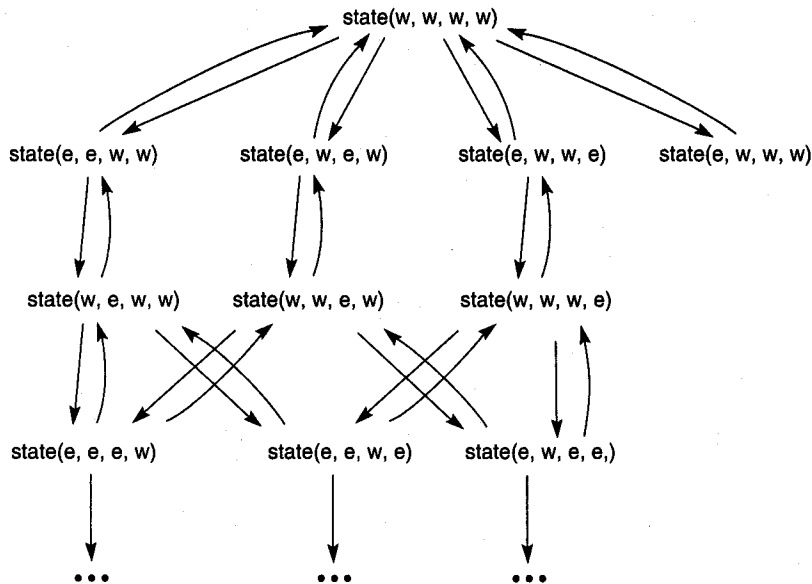

Figure 9.2 Portion of the state space graph of the farmer, wolf, goat, and cabbage problem (including unsafe states).

this format. We take the former option here and the latter in Section 12.2. Horn clauses require that the pattern for the present state and the pattern for the next state both be placed in the head of the Horn clause (or to the left of :-). These are the arguments to the `move` predicate. The conditions that the production rule requires to fire (and return the next state) are placed to the right of :- . As shown in the following example, these conditions are also expressed as unification constraints.

The first rule we define is for the farmer to take the wolf across the river. This rule must account for both the transfer from east to west and the transfer from west to east, and it must not be applicable when the farmer and wolf are on opposite sides of the river. Thus, it must transform `state(e,e,G,C)` to `state(w,w,G,C)` and `state(w,w,G,C)` to `state(e,e,G,C)`. It must also fail for `state(e,w,G,C)` and `state(w,e,G,C)`. The variables `G` and `C` represent the fact that the third and fourth parameters can be bound to either `e` or `w`. Whatever their values, they remain the same after the move of the farmer and wolf. Some of the states produced may indeed be “unsafe.”

The following `move` rule operates only when the farmer and wolf are in the same location and takes them to the opposite side of the river. Note that the goat and cabbage do not change their present location (whatever it might be).

```
move(state(X,X,G,C), state(Y,Y,G,C)) :- opp(X,Y).
```

```
opp(e,w).
opp(w,e).
```

This rule fires when a state (the present location in the graph) is presented to the first parameter of `move` in which the farmer and wolf are at the same location. When the rule fires, a new state, the second parameter of `move`, is produced with the value of `X` opposite, `opp`, the value of `Y`. Two conditions are satisfied to produce the new state: first, that the values of the first two parameters are the same and, second, that their new location is opposite the old.

The first condition was checked implicitly in the unification process, in that `move` is not even called unless the first two parameters are the same. This test may be done explicitly by using the following rule:

```
move(state(F,W,G,C), state(Z,Z,G,C)) :- F = W, opp(F,Z).
```

This equivalent `move` rule first tests whether `F` and `W` are the same and, only if they are, assigns the opposite value of `F` to `Z`. Note that `PROLOG` can do "assignment" by the binding of variable values in unification. Bindings are shared by all occurrences of a variable in a clause, and the scope of a variable is limited to the clause in which it occurs.

Pattern matching, a powerful tool in AI programming, is especially important in pruning search. States that do not fit the patterns in the rule are automatically pruned. In this sense, the first version of the `move` rule presented is a more efficient representation, because unification does not even consider the clause if the first two parameters are not identical.

Next, we create a predicate to test whether each new state is safe, so that nothing is eaten in the process of crossing the river. Again, unification plays an important role in this definition. Any state where the second and third parameters are the same and opposite the first parameter is unsafe; the wolf eats the goat. Alternatively, if the third and fourth parameters are the same and opposite the first parameter, the state is unsafe: the goat eats the cabbage. These `unsafe` situations may be represented with the following rules.

```
unsafe(state(X,Y,Y,C)) :- opp(X,Y).
unsafe(state(X,W,Y,Y)) :- opp(X,Y).
```

Several points should be mentioned here. First, if a state is to be `not unsafe` (i.e., safe), according to the definition of `not` in `PROLOG`, neither of these `unsafe` predicates can be true. Thus, neither of these predicates can unify with the current state or, if they do unify, their conditions must not be satisfied. Second, `not` in `PROLOG` is not exactly equivalent to the logical \neg of the first-order predicate calculus; `not` is rather "negation by failure of its opposite." The reader should test a number of states to verify that `unsafe` does what it is intended to do.

Now, a `not unsafe` test may be added to the previous production rule:

```
move(state(X,X,G,C), state(Y,Y,G,C))
:- opp(X,Y), not(unsafe(state(Y,Y,G,C))).
```

The `not unsafe` test calls `unsafe`, as mentioned above, to see whether the generated state is an acceptable new state in the search. When all criteria are met, including the check in the path algorithm that the new state is not a member of the visited-state list, `path` is

(recursively) called on this state to go deeper into the graph. When `path` is called, the new state is added to the visited-state list.

In a similar fashion, we can create the three other production rules to represent the farmer taking the goat, cabbage, and himself across the river. We have added a `writelist` command to each production rule to print a trace of the current rule.

The `reverse_print_stack` command is used in the terminating condition of `path` to print out the final solution path. Finally, we add a fifth “pseudorule” that always fires, because no conditions are placed on it, when all previous rules have failed; it indicates that the `path` call is backtracking from the current state, and then it itself fails. This pseudorule is added to assist the user in seeing what is going on as the production system is running.

We now present the full production system program in PROLOG to solve the farmer, wolf, goat, and cabbage problem. The PROLOG predicates `unsafe`, `writelist`, and the ADT stack predicates of Section 9.2.1, must also be included:

```
move(state(X,X,G,C), state(Y,Y,G,C)) :-
    opp(X,Y), not(unsafe(state(Y,Y,G,C))),
    writelist(['try farmer takes wolf',Y,Y,G,C]).

move(state(X,W,X,C), state(Y,W,Y,C)) :-
    opp(X,Y), not(unsafe(state(Y,W,Y,C))),
    writelist(['try farmer takes goat',Y,W,Y,C]).

move(state(X,W,G,X), state(Y,W,G,Y)) :-
    opp(X,Y), not(unsafe(state(Y,W,G,Y))),
    writelist(['try farmer takes cabbage',Y,W,G,Y]).

move(state(X,W,G,C), state(Y,W,G,C)) :-
    opp(X,Y), not(unsafe(state(Y,W,G,C))),
    writelist(['try farmer takes self',Y,W,G,C]).

move(state(F,W,G,C), state(F,W,G,C)) :-
    writelist([' BACKTRACK from:',F,W,G,C]), fail.

path(Goal, Goal, Been_stack) :-
    write('Solution Path is: '), nl,
    reverse_print_stack(Been_stack).

path(State, Goal, Been_stack) :-
    move(State,Next_state),
    not(member_stack(Next_state, Been_stack)),
    stack(Next_state, Been_stack, New_been_stack),
    path(Next_state, Goal, New_been_stack), !.

opp(e,w).
opp(w,e).
```

The code is called by requesting `go`, which initializes the recursive `path` call. To make running the program easier, we present a predicate, `test`, that simplifies the input:

```

go(Start, Goal) :-
    empty_stack(Empty_been_stack),
    stack(Start, Empty_been_stack, Been_stack),
    path(Start, Goal, Been_stack).

```

```

test :- go(state(w,w,w,w), state(e,e,e,e)).

```

The algorithm backtracks from states that allow no further progress. You may also use `trace` to monitor the various variable bindings local to each call of `path`. It may also be noted that this program is a general program for moving the four creatures from any (legal) position on the banks to any other (legal) position, including asking for a path from the goal back to the start state. Other interesting features of production systems, including the fact that different orderings of the rules can produce different searches through the graph, are presented in the exercises. A trace of the execution of the program is:

```

?- test.
try farmer takes goat e w e w
try farmer takes self w w e w
try farmer takes wolf e e e w
try farmer takes goat w e w w
try farmer takes cabbage e e w e
try farmer takes wolf w w w e
try farmer takes goat e w e e
    BACKTRACK from e,w,e,e
    BACKTRACK from w,w,w,e
try farmer takes self w e w e
try farmer takes goat e e e e
Solution Path Is:
state(w,w,w,w)
state(e,w,e,w)
state(w,w,e,w)
state(e,e,e,w)
state(w,e,w,w)
state(e,e,w,e)
state(w,e,w,e)
state(e,e,e,e)

```

In summary, this PROLOG program implements a production system solution to the farmer, wolf, goat, and cabbage problem. The `move` rules make up the content of the production memory. The working memory is represented by the arguments of the `path` call. The production system control mechanism is defined by the recursive `path` call. We show how this control may be altered in the next subsections. Finally, the ordering of rules for generation of children from each state (conflict resolution) is determined by the order in which the rules are placed in the production memory.

9.4 Designing Alternative Search Strategies

As the previous subsection demonstrated, and as is made more precise in Section 9.7, PROLOG itself uses depth-first search with backtracking. We now show how the alternative search strategies of Chapters 3, 4, and 5 can be implemented in PROLOG. Our implementations of depth-first, breadth-first, and best-first search use `open` and `closed` lists to record states in the search. When search fails at any point we do not go back to the preceding values of `open` and `closed`. Instead, `open` and `closed` are updated within the `path` call and the search continues with these new values. The `cut` is used to keep PROLOG from storing the old versions of `open` and `closed`.

9.4.1 Depth-First Search Using the Closed List

Because the values of variables are restored when recursion backtracks, the list of visited states in the depth-first path algorithm of Section 9.3 records states only on the current path to the goal. Although the test for membership in this list prevents loops, it still allows branches of the space to be reexamined if they are reached along paths generated earlier but abandoned at that time as unfruitful. A more efficient implementation keeps track of all the states that have ever been encountered. This more complete collection of states made up the list called `closed` in Chapter 3, and `Closed_set` in the following algorithm.

`Closed_set` holds all states on the current path plus the states that were rejected when we backtracked out of them; thus, it no longer represents the path from the start to the current state. To capture this path information, we create the ordered pair `[State, Parent]` to keep track of each state and its parent; the `Start` state is represented by `[Start, nil]`. These state-parent pairs will be used to re-create the solution path from the `Closed_set`.

We now present a shell structure for depth-first search in PROLOG, keeping track of both `open` and `closed` and checking each new state to be sure it was not previously visited. `path` has three arguments, the `Open_stack`, `Closed_set`, maintained as a set, and the `Goal` state. The current state, `State`, is the next state on the `Open_stack`. The `stack` and `set` operators are found in Section 9.2.

Search starts by a `go` predicate that initializes the path call. Note that `go` places the `Start` state with the `nil` parent, `[Start, nil]`, alone on `Open_stack`; `Closed_set` is empty:

```
go(Start, Goal) :-
    empty_stack(Empty_open),
    stack([Start, nil], Empty_open, Open_stack),
    empty_set(Closed_set),
    path(Open_stack, Closed_set, Goal).
```

The three-argument `path` call is:

```
path(Open_stack,_,_) :-
    empty_stack(Open_stack),
    write('No solution found with these rules').
```



```

path(Open_stack, Closed_set, Goal) :-
    stack([State, Parent],_, Open_stack), State = Goal,
    write('A Solution is Found!'), nl,
    printsolution([State, Parent], Closed_set),

path(Open_stack, Closed_set, Goal) :-
    stack([State, Parent], Rest_open_stack, Open_stack),
    get_children(State, Rest_open_stack, Closed_set, Children),
    add_list_to_stack(Children, Rest_open_stack, New_open_stack),
    union([[State, Parent]], Closed_set, New_closed_set),
    path(New_open_stack, New_closed_set, Goal), !.

get_children(State, Rest_open_stack, Closed_set, Children) :-
    bagof(Child, moves(State, Rest_open_stack,
        Closed_set, Child), Children).

moves(State, Rest_open_stack, Closed_set, [Next, State]) :-
    move(State, Next),
    not(unsafe(Next)), % test depends on problem
    not(member_stack([Next,_], Rest_open_stack)),
    not(member_set([Next,_], Closed_set)).

```

We assume a set of `move` rules, and, if necessary, an `unsafe` predicate:

```

move(Present_state, Next_state) :- ... % test first rule.
move(Present_state, Next_state) :- ... % test second rule.
....

```

These `move` rules and the `unsafe` predicate reflect the change of state operators of the particular problem situation.

The first `path` call terminates search when the `Open_stack` is empty, which means there are no more states on the open list to continue the search. This usually indicates that the graph has been exhaustively searched. The second `path` call terminates and prints out the solution path when the solution is found. Since the states of the graph search are maintained as `[State, Parent]` pairs, `printsolution` will go to the `Closed_set` and recursively rebuild the solution path. Note that the solution is printed from start to goal.

```

printsolution([State, nil], _) :-
    write(State), nl.

printsolution([State, Parent], Closed_set) :-
    member_set([Parent, Grandparent], Closed_set),
    printsolution([Parent, Grandparent], Closed_set),
    write(State), nl.

```

The third `path` call uses `bagof`, a PROLOG predicate standard to most interpreters. `bagof` lets us gather all the unifications of a pattern into a single list. The second

parameter to `bagof` is the pattern predicate to be matched in the database. The first parameter specifies the components of the second parameter that we wish to collect. For example, we may be interested in the values bound to a single variable of a predicate. All bindings of the first parameter resulting from these matches are collected in a list and bound to the third parameter.

In this program, `bagof` collects the states reached by firing *all* of the enabled production rules. Of course, this is necessary to gather all descendants of a particular state so that we can add them, in proper order, to `open`. The second argument of `bagof`, a new predicate named `moves`, calls the `move` predicates to generate all the states that may be reached using the production rules. The arguments to `moves` are the present state, the open list, the closed set, and a variable that is the state reached by a good move. Before returning this state, `moves` checks that the new state, `Next`, is not a member of either `rest_open_stack`, `open` once the present state is removed, or `closed_set`. `bagof` calls `moves` and collects all the states that meet these conditions. The third argument of `bagof` thus represents the new states that are to be placed on the `Open_stack`.

In some implementations, `bagof` fails when no matches exist for the second argument and thus the third argument is empty. This can be remedied by substituting `(bagof(X, moves(S,T,C,X), List); List = [])` for the current calls to `bagof` in the code.

Finally, because the states of the search are represented as state-parent pairs, the member check predicates must be revised to reflect the structure of the pattern matching. We test to see if the first element of a state-parent pair is identical to the first element of a list of state-parent pairs:

```
member([State,_], [[State,_]]).
member([State,_],[_T]) :- member([State,_], T).
```

9.4.2 Breadth-First Search in PROLOG

We now present the *shell* of an algorithm for breadth-first search using explicit open and closed lists. The shell can be used with the `move` rules and `unsafe` predicates for any search problem. This algorithm is called by:

```
go(Start, Goal) :-
    empty_queue(Empty_open_queue),
    enqueue([Start, nil], Empty_open_queue, Open_queue),
    empty_set(Closed_set),
    path(Open_queue, Closed_set, Goal).
```

`Start` and `Goal` have their obvious values. Again we create the ordered pair `[State, Parent]`, as we did with depth and breadth search, to keep track of each state and its parent; the `Start` state is represented by `[Start, nil]`. This will be used by `printsolution` to re-create the solution path from the `Closed_set`. The first parameter of `path` is the `Open_queue`, the second is the `Closed_set`, and the third is the `Goal`. *Don't care* variables, those whose values are not used in a clause, are written as `_`.

```

path(Open_queue, _, _) :-
    empty_queue(Open_queue),
    write('Graph searched, no solution found.').

path(Open_queue, Closed_set, Goal) :-
    dequeue([State, Parent], Open_queue, _), State = Goal,
    write('Solution path is: '), nl,
    printsolution([State, Parent], Closed_set).

path(Open_queue, Closed_set, Goal) :-
    dequeue([State, Parent], Open_queue, Rest_open_queue),
    get_children(State, Rest_open_queue, Closed_set, Children),
    add_list_to_queue(Children, Rest_open_queue, New_open_queue),
    union([[State, Parent]], Closed_set, New_closed_set),
    path(New_open_queue, New_closed_set, Goal), !.

get_children(State, Rest_open_queue, Closed_set, Children) :-
    bagof(Child, moves(State, Rest_open_queue,
        Closed_set, Child), Children).

moves(State, Rest_open_queue, Closed_set, [Next, State]) :-
    move(State, Next),
    not(unsafe(Next)), % test depends on problem
    not(member_queue([Next, _], Rest_open_queue)),
    not(member_set([Next, _], Closed_set)).

```

This algorithm is a shell in that no `move` rules are given. These must be supplied to fit the specific problem domain. The `queue` and `set` operators are found in Section 9.2.

The first path termination condition is defined for the case that `path` is called with its first argument, `Open_queue`, empty. This happens only when no more states in the graph remain to be searched and the solution has not been found. A solution is found in the second path predicate when the head of the `open_queue` and the `Goal` state are identical.

When `path` does not terminate, the algorithm uses the `bagof` and `moves` predicates to gather all the children of the current state and maintain the queue. The actions of these predicates were described in the previous section. Note also, in order to recreate the solution path, it was necessary to save each state as a state-parent pair, `[State, Parent]`. The start state has the parent `nil`. As noted in Section 9.4.1, the state-parent pair representation makes necessary a slightly more complex pattern matching in the `member`, `moves`, and `print_solution` predicates.

9.4.3 Best-First Search in PROLOG

Our shell for best-first search is a modification of the breadth-first algorithm in which the open queue is replaced by a priority queue, ordered by heuristic merit, for each new call to `path`. In our algorithm, we attach a heuristic measure permanently to each new state on `open` and use this measure for ordering states on `open`. We also retain the parent of each

state. This information is used by `printsolution`, as in breadth-first search, to build the solution path once the goal is found.

To keep track of all required search information, each state is represented as a list of five elements: the state description, the parent of the state, an integer giving the depth in the graph of its discovery, an integer giving the heuristic measure of the state, and the integer sum of the third and fourth elements. The first and second elements are found in the usual way; the third is determined by adding one to the depth of its parent; the fourth is determined by the heuristic measure of the particular problem. The fifth element, used for ordering the states on the `open_pq`, is $f(n) = g(n) + h(n)$, as presented in Chapter 4.

As before, the `move` rules are not specified; they are defined to fit the specific problem. The ADT operators for set and priority queue are presented in Section 9.2. `heuristic`, also specific to each problem, is a measure applied to each state to determine its heuristic weight, the value of the fourth parameter in its descriptive list.

This algorithm, as with breadth-first search above, has two termination conditions. The algorithm is called by:

```
go(Start, Goal) :-
    empty_set(Closed_set),
    empty_pq(Open),
    heuristic(Start, Goal, H),
    insert_pq([Start, nil, 0, H, H], Open, Open_pq),
    path(Open_pq, Closed_set, Goal).
```

`nil` is the parent of `Start` and `H` is the heuristic evaluation of `Start`. The code for best-first search is:

```
path(Open_pq,_) :-
    empty_pq(Open_pq),
    write('Graph searched, no solution found.')
```

```
path(Open_pq, Closed_set, Goal) :-
    dequeue_pq([State, Parent,_,_,_], Open_pq,_) ,
    State = Goal,
    write('The solution path is: '), nl,
    printsolution([State, Parent,_,_,_], Closed_set).
```

```
path(Open_pq, Closed_set, Goal) :-
    dequeue_pq([State, Parent, D, H, S], Open_pq, Rest_open_pq),
    get_children([State, Parent, D, H, S], Rest_open_pq, Closed_set, Children, Goal),
    insert_list_pq(Children, Rest_open_pq, New_open_pq),
    union([State, Parent, D, H, S], Closed_set, New_closed_set),
    path(New_open_pq, New_closed_set, Goal), !.
```

`get_children` is a predicate that generates all the children of `State`. It uses `bagof` and `moves` predicates as in the previous searches. Details are found in Section 9.4.1. Move rules, a safe check for legal moves, and a heuristic must be specifically defined for each application. The member check must be specifically designed for five element lists.

```

get_children([State,_,D,_,_], Rest_open_pq, Closed_set, Children, Goal) :-
    bagof(Child, moves([State,_,D,_,_], Rest_open_pq,
        Closed_set, Child, Goal), Children).

moves([State,_,Depth,_,_], Rest_open_pq, Closed_set,
    [Next, State, New_D, H, S], Goal) :-
    move(State, Next),
    not(unsafe(Next)), % determined by application
    not(member_pq([Next,_,_,_,_], Rest_open_pq)),
    not(member_set([Next,_,_,_,_], Closed_set)),
    New_D is Depth + 1,
    heuristic(Next, Goal, H), % determined by application
    S is New_D + H.

```

Finally, `printsolution` prints the solution path. It recursively finds State-Parent pairs by matching the first two elements in the state description with the first two elements of all the five element lists that make up the `Closed_set`. The start state has `nil` as its parent.

```

printsolution([State, nil,_,_,_,_],_) :-
    write(State), nl.
printsolution([State, Parent,_,_,_,_], Closed_set) :-
    member_set([Parent, Grandparent,_,_,_,_], Closed_set),
    printsolution([Parent, Grandparent,_,_,_,_], Closed_set),
    write(State), nl.

```

9.5 A PROLOG Planner

In Section 5.4 we described a predicate calculus-based planning algorithm. It was predicate calculus (PC) based in that the PC representation was chosen for both the state of the planning world descriptions as well as the change of state rules. In this section we create a PROLOG version of that algorithm.

We represent the states of the world, including the begin and goal states, as lists of predicates. Two states, the start and goal states for our example, are described:

```

start = [handempty, ontable(b), ontable(c), on(a,b), clear(c), clear(a)]
goal = [handempty, ontable(a), ontable(b), on(c,b), clear(a), clear(c)]

```

These states are seen, along with a portion of the search space, in Figures 9.3 and 9.4.

The moves in this world are described using add and delete lists, as in Section 5.4. Four of the moves within this world may be described:

```

move(pickup(X),[handempty, clear(X), on(X,Y)],
    [del(handempty), del(clear(X)), del(on(X,Y)),
    add(clear(Y)), add(holding(X))]).

```

```

move(pickup(X), [handempty, clear(X), ontable(X)],
      [del(handempty), del(clear(X)), del(ontable(X)),
       add(holding(X))]).

```

```

move(putdown(X), [holding(X)],
      [del(holding(X)), add(ontable(X)),
       add(clear(X)), add(handempty)]).

```

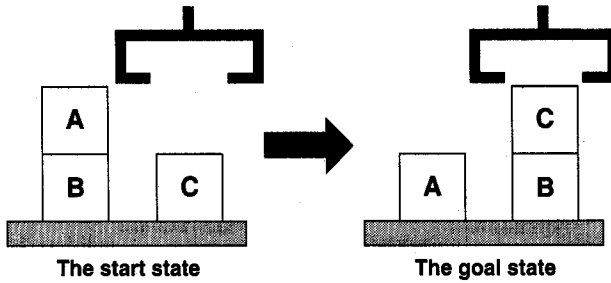

Figure 9.3 The start and goal states for the blocks world problem.

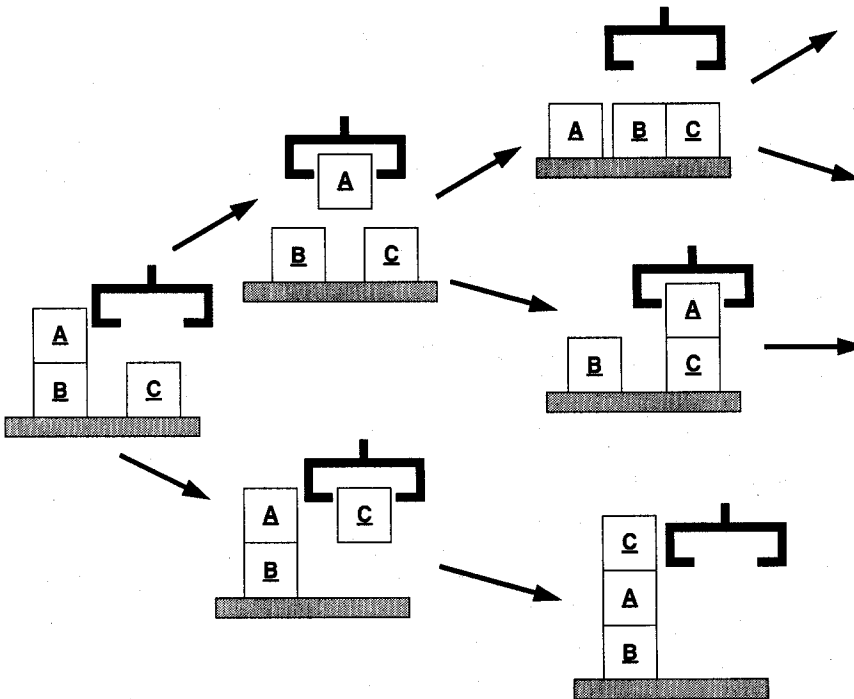

Figure 9.4 The initial levels of the blocks world state space.

```

move(stack(X,Y), [holding(X), clear(Y)],
      [del(holding(X)), del(clear(Y)), add(handempty),
       add(on(X,Y)), add(clear(X))]).

```

The `move` predicates have three arguments. First is the `move` predicate name with its arguments. The second argument is the list of preconditions: the predicates that must be true in the description of the state of the world for the move rule to be applied to that state. The third argument is the add and delete list: the predicates that are added to and deleted from the state of the world to create the new state of the world that results from applying the move rule. Notice how useful the ADT set operators of union, intersection, set difference, etc., will be in manipulating the preconditions and the add and delete lists.

Finally, we have the recursive controller for the plan generation. The first plan predicate gives the successful termination conditions for the plan, namely, when the goal is produced. The final plan predicate states that after exhaustive search, no plan is possible. The recursive plan generator:

1. Searches for a `move` relationship.
2. Checks, using the subset operator, whether the state's `Preconditions` are met.
3. The `change_state` predicate produces a new `Child_state` using the add and delete list.
4. `member_stack` makes sure the new state has not been visited before.
5. The `stack` operator pushes the new `Child_state` onto the `New_moves_stack`.
6. The `stack` operator pushes the original `Name` state onto the `New_been_stack`.
7. The recursive `plan` call searches for the next state using the `Child_state` and an updated `New_move_stack` and `Been_stack`.

A number of supporting utilities, built on the stack and set ADTs of Sections 9.2.1 and 9.2.4 are included. Of course, the search being stack-based, is depth-first with backtracking and terminates with the first path found to a goal. It is left as an exercise to build breadth-first and best-first planners.

```

plan(State, Goal,_, Move_stack) :-
    equal_set(State, Goal),
    write('moves are'), nl,
    reverse_print_stack(Move_stack).

```

```

plan(State, Goal, Been_stack, Move_stack) :-
    move(Name, Preconditions, Actions),
    conditions_met(Preconditions, State),
    change_state(State, Actions, Child_state),
    not(member_stack(Child_state, Been_stack)),
    stack(Name, Been_stack, New_been_stack),
    stack(Child_state, Move_stack, New_move_stack),
    plan(Child_state, Goal, New_been_stack, New_move_stack), !.

```

```
plan(____) :- write('No plan possible with these moves!').
```

```
conditions_met(P, S) :-  
    subset(P, S).
```

```
change_state(S, [], S).  
change_state(S, [add(P) | T], S_new) :-  
    change_state(S, T, S2),  
    add_if_not_in_set(P, S2, S_new), !.
```

```
change_state(S, [del(P) | T], S_new) :-  
    change_state(S, T, S2),  
    delete_if_in_set(P, S2, S_new), !.
```

```
reverse_print_stack(S) :-  
    empty_stack(S).  
reverse_print_stack(S) :-  
    stack(E, Rest, S),  
    reverse_print_stack(Rest),  
    write(E), nl.
```

Finally, we create a `go` predicate to initialize the arguments for `plan`, as well as a test predicate to demonstrate an easy method to save repeated creation of the same input string.

```
go(Start, Goal) :-  
    empty_stack(Move_stack),  
    empty_stack(Been_stack),  
    stack(Start, Been_stack, New_been_stack),  
    plan(Start, Goal, New_been_stack, Move_stack).
```

```
test :-  
    go([handempty, ontable(b), ontable(c), on(a,b), clear(c), clear(a)],  
       [handempty, ontable(a), ontable(b), on(c,b), clear(a), clear(c)]).
```

9.6 PROLOG: Meta-Predicates, Types, & Unification

9.6.1 Meta-Logical Predicates

Meta-logical constructs extend the expressive power of any programming environment. We refer to these predicates as *meta* because they are designed to match, query and manipulate other predicates that make up the specifications of the problem domain. That is, they can be used to reason about PROLOG predicates rather than the terms or objects these other predicates denote. We need meta-predicates in PROLOG for (at least) five reasons:

1. To determine the "type" of an expression.
2. To add "type" restrictions to logic programming.
3. To build, take apart, and evaluate PROLOG structures.
4. To compare values of expressions.
5. To convert predicates passed as data to executable code.

We have already described how global structures, which are those that can be accessed by the entire clause set, are entered into a PROLOG program. The command `assert(C)` adds the clause `C` to the current set of clauses.

There are dangers associated with programming with `assert` and `retract`. Because they create and remove global structures, these commands introduce side effects and may cause other problems associated with poorly structured programs. Yet, it is sometimes necessary to use global structures. We do this when creating *semantic nets* and *frames* in a PROLOG environment. We may also use global structures to describe new results as they are found with our rule-based shell. We want this information to be global so that other predicates (rules) may access it when appropriate.

Other meta-predicates that are useful for manipulating representations include:

`var(X)` succeeds only when `X` is an unbound variable.

`nonvar(X)` succeeds only when `X` is bound to a nonvariable term.

`..` creates a list from a predicate term.

For example, `foo(a,b,c) = .. Y` unifies `Y` with `[foo,a,b,c]`. The head of the list `Y` is the function name, and its tail is the function's arguments. `..` also can be used "backward," of course. Thus, if `X = .. [foo,a,b,c]` succeeds, then `X` has the value `foo(a,b,c)`.

`functor(A, B, C)` succeeds with `A` a term whose principal functor has name `B` and arity `C`.

For example, `functor(foo(a,b),X,Y)` will succeed with `X = foo` and `Y = 2`. `functor(A,B,C)` can also be used with any of its arguments bound in order to produce the others, such as all the terms with a certain name and/or arity.

`clause(A,B)` unifies `B` with the body of a clause whose head unifies with `A`.

If `p(X) :- q(X)` exists in the database, then `clause(p(a),Y)` will succeed with `Y = q(a)`. This is useful for controlling rule chaining in an interpreter.

`any_predicate(...,X,...) :- X` executes predicate `X`, the argument of any predicate.

Thus a predicate, here `X`, may be passed as a parameter and executed at any desired time in the computation.

call(X), where X is a clause, also succeeds with the execution of predicate X.

This short list of meta-logical predicates will be very important in building and interpreting the AI data structures of the preceding chapters. Because PROLOG can manipulate its own structures in a straightforward fashion, it is easy to implement interpreters that modify the PROLOG semantics. For example, in building a meta-interpreter for production rules (Section 13.2), it is important to be able to distinguish a rule (clause) from a fact (true) and to be able to create new predicates or relationships as needed.

9.6.2 Types in PROLOG

For a number of problem-solving applications, the unconstrained use of unification can introduce unintended error. PROLOG is an untyped language; unification simply matches patterns, without restricting them according to type. For example, `append(nil,6,6)` is deducible from the definition of `append`. Strongly typed languages such as Pascal have shown how type checking can help the programmer avoid these problems. A number of researchers have proposed the introduction of *types* to PROLOG (Neves et al. 1986, Mycroft and O'Keefe 1984).

Typed data are particularly appropriate in a relational data base (Neves et al. 1986, Malpas 1987). The rules of logic can be used as constraints on the data and the data can be typed to enforce consistent and meaningful interpretation of the queries.

Suppose that there is a department store database of inventory, suppliers, supplier_inventory, and other appropriate relations. We define the database as relations with named fields; these can be thought of as sets of data tuples. For example, inventory might consist of a set of 4-tuples, where:

< Pname, Pnumber, Supplier, Weight > \in inventory

only when Supplier is the supplier name of an inventory item numbered Pnumber that is called Pname and has weight Weight. Suppose also

< Supplier, Snumber, Status, Location > \in suppliers

only when Supplier is the name of a supplier numbered Snumber who has status Status and lives in city Location, and

< Supplier, Pnumber, Cost, Department > \in supplier_inventory

only if Supplier is the name of a supplier of part number Pnumber in the amount of Cost to department Department.

We may define PROLOG rules that implement various queries and perform type checking in these relations. For instance, the query "are there suppliers of part number 1 that live in London?" is given in PROLOG as:

?- getsuppliers (Supplier,1,london).

The rule:

```
getsuppliers (Supplier, Pnumber, City) :-  
    cktype (City, suppliers, city),  
    suppliers (Supplier,_,_,City),  
    cktype (Pnumber, inventory, number),  
    supplier_inventory (Supplier, Pnumber,_,_),  
    cktype (Supplier, inventory, name).
```

implements this query and also enforces the appropriate constraints across the tuples of the database. First the variables **Pnumber** and **City** are bound when the query unifies with the head of the rule; our predicate **cktype** tests that **Supplier** is an element of the set of **suppliers**, that **1** is a legitimate inventory number, and that **london** is a **suppliers** city.

We define **cktype** to take three arguments—a value, a relation name, and a field name—and to check that each value is of the appropriate type for that relation. For example, we may define lists of legal values for **Supplier**, **Pnumber**, and **City** and enforce data typing by requiring member checks of candidate values across these lists. Alternatively, we may define logical constraints on possible values of a type; for example, we may require that inventory numbers be less than 1000.

We should note the differences in type checking between standard languages such as Pascal and PROLOG. We might define a Pascal data type for **suppliers** as:

```
type supplier = record  
    sname: string;  
    snumber: integer;  
    status: boolean;  
    location: string  
end
```

The Pascal programmer defines new types, here **supplier**, in terms of already defined types, such as **boolean** or **integer**. When the programmer uses variables of this type, the compiler automatically enforces type constraints on their values.

In PROLOG, we could represent the **supplier** relation as instances of the form:

```
supplier(sname(Supplier),  
        snumber(Snumber),  
        status(Status),  
        location(Location)).
```

We would implement type checking on these instances using rules such as **getsuppliers** and **cktype**.

The distinction between Pascal and PROLOG type checking is clear and important: the Pascal type declaration tells the compiler the form for both the entire structure (**record**) and the individual components (**boolean**, **integer**, **string**) of the data type. In

Pascal we declare variables to be of a particular type (**record**) and then create procedures to access these typed structures.

```
procedure changestatus (X: supplier);
begin
    if X.status then. . .
```

Because it is nonprocedural, PROLOG does not separate the declaration from the use of data types, and any type checking must be done as the program is executing. Consider the rule:

```
supplier_name(supplier(sname(Supplier),
                        snumber(Snumber),
                        status(true),
                        location (london))) :-
    integer(Snumber), write(Supplier).
```

`supplier_name` takes as argument an instance of the `supplier` predicate and writes the name of the supplier. However, this rule will succeed only if the supplier's number is an integer, the status is active (`true`), and the supplier lives in London. An important part of the type check is handled by the unification algorithm (`true, london`) and the rest is the built-in system predicate `integer`. Further constraints could restrict values to be from a particular list; for example, `Snumber` could be constrained to be from a list of supplier numbers. We define constraints on database queries using rules such as `cktype` and `supplier_name` to implement type checking when the program is executed.

So far, we have seen three ways that data may be typed in PROLOG. First, and most powerful, is the use of unification to constrain variable assignment. Second, PROLOG itself provides predicates to do limited type checking. We saw this with meta-predicates such as `var(X)`, `clause(X,Y)`, and `integer(X)`. The third limited use of typing occurred in the inventory example where rules checked lists of legitimate suppliers, pnumbers, and cities to enforce type constraints.

A fourth, and more radical, approach is the complete predicate and data type check proposed by Mycroft and O'Keefe (1984). Here all predicate names are typed and given a fixed arity. Furthermore, all variable names are themselves typed. A strength of this approach is that the constraints on the constituent predicates and variables of the PROLOG program are themselves enforced by a (meta) PROLOG program. Even though the result may be slower program execution, the security gained through total type enforcement may justify this cost.

Rather than providing built-in type checking as a default, PROLOG allows run-time type checking under complete programmer control. This approach offers a number of benefits for AI programmers, including the following:

1. The programmer is not forced to adhere to strong type checking at all times. This allows us to write predicates that work across any type of object. For example, the member predicate performs general member checking, regardless of the type of elements in the list.

2. Flexibility in typing helps exploratory programming. Programmers can relax type checking in the early stages of program development and introduce it to detect errors as they come to better understand the problem.
3. AI representations seldom conform to the built-in data types of languages such as Pascal, C++, or Java. PROLOG allows types to be defined using the full power of predicate calculus. The database example showed the advantages of this flexibility.
4. Because type checking is done at run time rather than compile time, the programmer determines when the program should perform a check. This allows programmers to delay type checking until it is necessary or until certain variables have become bound.
5. Programmer control of type checking at run time also lets us write programs that create and enforce new types during execution. This could be of use in a learning program, for example.

9.6.3 Unification, the Engine for Predicate Matching and Evaluation

An important feature of PROLOG programming is the interpreter's behavior as a resolution-based theorem prover, presented in Section 12.3. As a theorem prover PROLOG performs a series of resolutions on database entries, rather than sequentially evaluating statements and expressions like a traditional language. This has an important result: variables are bound (assigned values, instantiated, ...) by unification and *not* by evaluation unless, of course, an evaluation is explicitly requested. This programming paradigm has several implications.

The first and perhaps most important result is the relaxation of the requirement to specify variables as input or output. We have already seen some of the power of this in the `append` predicate, which could either join lists together, test whether two lists are correctly appended, or break a list into parts consistent with the definition of `append`. We also see unification as a matcher and constraint handler for parsing and generating sentences in Section 9.8.

Unification is a powerful technique for rule-based and frame-based expert systems. All production systems require a form of this matching, and it is often necessary to write a unification algorithm in languages that don't provide it (see, for example, Section 10.6 for a LISP implementation of unification).

An important difference between unification-based computing and the use of more traditional languages is that unification performs syntactic matches (with appropriate parameter substitutions) on structures. It does *not* evaluate expressions. Suppose, for example, we wished to create a `SUCCESSOR` predicate that succeeds if its second argument is the arithmetic successor of its first. Not understanding unification, one might be tempted to define `SUCCESSOR`:

```
successor (X, Y) :- Y = X + 1.
```

This will fail because the = operator does not evaluate its arguments but only attempts to unify the expressions on either side. This predicate succeeds if Y unifies with the structure X + 1. Because 4 does not unify with 3 + 1, the call `successor(3, 4)` fails! On the other hand, = can test for equivalence, as defined by unification, of any two expressions.

To correctly define `successor` and other arithmetic predicates, we need to evaluate arithmetic expressions. PROLOG provides an operator, `is`, for this evaluation. `is` evaluates the expression on its right-hand side and attempts to unify the result with the object on its left. Thus,

`X is Y + Z`

unifies X with the value of Y added to Z. Because it performs arithmetic evaluation:

1. If Y and Z do not have values (are not bound at execution time) evaluation of the `is` causes a run-time error. Thus
2. `X is Y + Z` cannot (as one might think with a declarative programming language) give a value to Y when X and Z are bound.
3. Programs must use `is` to evaluate expressions containing arithmetic operators, +, -, *, /, and mod.

Finally, as in the predicate calculus, variables in PROLOG may have one and only one binding. Once given a value, through local assignment or unification, they can never take on a new value, except through a backtrack in the and/or search space of the current interpretation. Thus, `is` does not function like a traditional assignment operator; an expression such as `X is X + 1` will always fail.

Using `is`, we can now properly define `successor(X, Y)` as:

```
successor (X, Y) :- Y is X + 1.
```

This will have the correct behavior as long as X is bound to a numeric value. It can be used either to compute Y, given X, or to test values of X and Y:

```
?- successor (3,X).
X = 4
yes
?- successor (3,4).
yes
?- successor (4,2).
no
?- successor (Y,4).
failure, error in arithmetic expression
```

As this discussion illustrates, PROLOG does not evaluate expressions as a default as in traditional languages. The programmer must explicitly indicate evaluation using `is`.

Though this feature would be problematic in a language such as FORTRAN, which is used chiefly for arithmetic computing, it is extremely useful for symbolic computing. Explicit control of evaluation makes it easy to treat expressions as data, passing them as parameters and creating or modifying them in the program. We do not evaluate the expression until the appropriate time.

This feature, like the ability to manipulate predicate calculus expressions as data and execute them using `call`, greatly simplifies the development of different interpreters, such as the expert system shell of the next section.

We close this discussion of the power of unification-based computing with an example that does string catenation through the use of *difference lists*. As an alternative to the standard PROLOG list notation, we can represent a list as the difference of two lists. For example, `[a,b]` is equivalent to `[a,b | []] - []` or `[a,b,c] - [c]`. This representation has certain expressive advantages over the traditional list syntax. When the list `[a,b]` is represented as the difference `[a,b | Y] - Y`, it actually describes the potentially infinite class of all lists that have `a` and `b` as their first two elements. Now this representation has an interesting property, namely addition:

$$X - Z = X - Y + Y - Z$$

We can use this property to define the following single-clause logic program where `X - Y` is the first list, `Y - Z` is the second list, and `X - Z` is the result of catenating them:

```
catenate(X - Y, Y - Z, X - Z).
```

This operation joins two lists of any length in constant time by unification on the list structures, rather than by repeated assignment based on the length of the lists (as with `append`). Thus the call:

```
?- catenate ([a,b | Y] - Y, [1,2,3] - [], W).
```

gives:

```
Y = [1,2,3]
W = [a,b,1,2,3] - []
```

As noted in Figure 9.5, the (subtree) value of `Y` in the second parameter is unified with *both* occurrences of `Y` in the first parameter of `catenate`. This demonstrates the power of unification, not simply for substituting values for variables but also for matching general structures: all occurrences of `Y` take the value of the entire subtree. The example also illustrates the advantages of an appropriate representation. This algorithm is made possible by the ability of difference lists to represent a whole class of lists, including the desired catenation.

In this section we have discussed a number of idiosyncrasies and advantages of PROLOG's unification-based approach to computing. Unification is at the heart of PROLOG's declarative semantics.

Addition of difference lists:

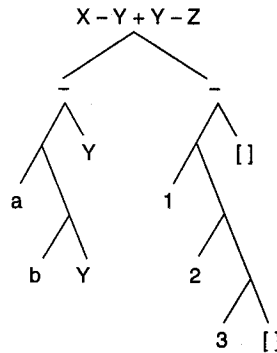

After binding Y to [1, 2, 3], binding Z to [], and performing the addition:

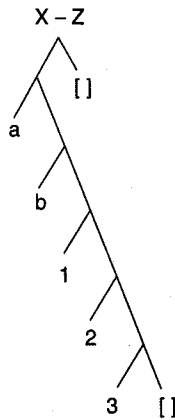

Figure 9.5 Tree diagrams of catenation using difference lists.

9.7 Meta-Interpreters in PROLOG

9.7.1 An Introduction to Meta-Interpreters: PROLOG in PROLOG

In both LISP and PROLOG, it is easy to write programs that manipulate expressions written in the language syntax. We call such programs *meta-interpreters*. For example, an expert system shell interprets a set of rules and facts that describe a particular problem.

Although the rules of a problem situation are written in the syntax of the underlying language, the meta-interpreter redefines their semantics.

As an example of a meta-interpreter, we define the semantics of pure PROLOG using PROLOG itself. `solve` takes as its argument a PROLOG goal and processes it according to the semantics of PROLOG:

```
solve(true) :-!.
solve(not A) :- not(solve(A)).
solve((A,B)) :-!, solve(A), solve(B).
solve(A) :- clause(A,B), solve(B).
```

If we assume the following simple set of assertions,

```
p(X,Y) :- q(X), r(Y).
q(X) :- s(X).
r(X) :- t(X).
s(a).
t(b).
t(c).
```

`solve` has the behavior we expect of PROLOG:

```
?- solve(p(a,b)).
yes
?- solve(p(X,Y)).
X = a, Y = b;
X = a, Y = c;
no
?- solve(p(f,g)).
no
```

`solve` implements the same left-to-right, depth-first, goal-directed search as the built-in PROLOG interpreter.

The ability to easily write meta-interpreters for a language has certain theoretical advantages. For example, McCarthy wrote a simple LISP meta-interpreter as part of a proof that the language is Turing complete (McCarthy 1960). From a more practical standpoint, we can use meta-interpreters to extend or modify the semantics of the underlying language to better fit our application. This is the programming methodology of *meta-linguistic abstraction*, the creation of a high-level language that is designed to help solve a specific problem.

For example, we may wish to modify the standard PROLOG semantics so that it will ask the user about the truth value of any goal that does not succeed in the knowledge base. We can do so by adding the following clause at the end of the previous definitions of `solve`:

```
solve(A) :- askuser(A).
```

We define `askuser` as:

```
askuser(A) :- write(A),
              write('? Enter true if the goal is true, false otherwise'),nl,
              read(true).
```

Because we add this definition to the end of the other `solve` rules, it is called only if all of these fail. `solve` invokes `askuser` to query the user for the truth value of the goal `A`. `askuser` prints the goal and instructions for answering. `read(true)` attempts to unify the user's input with the term `true`, failing if the user enters `false` (or anything that will not unify with `true`). In this way we have changed the semantics of `solve` and extended the behavior of `PROLOG`. An example, using the simple knowledge base defined above, illustrates the behavior of the augmented `solve` predicate:

```
?- solve(p(f,g)).
s(f)? Enter true if the goal is true, false otherwise
true.
t(g)? Enter true if the goal is true, false otherwise
true.
yes
```

Another extension to the meta-interpreter allows it to respond to "why" queries. When the interpreter asks the user a question, the user can respond with `why`; the appropriate response to this query is the current rule that the program is trying to solve. We implement this by storing the stack of rules in the current line of reasoning as the second parameter to `solve`. Whenever `solve` calls `clause` to backward chain on a goal, it places the selected rule on the stack. Thus, the rule stack records the chain of rules from the top-level goal to the current subgoal.

Because the user may now enter two valid responses to a query, `askuser` calls `respond`, which either succeeds if the user enters `true` (as before) or prints the top rule on the stack if the user enters `why`. `respond` and `askuser` are mutually recursive, so that after printing the answer to a `why` query, `respond` calls `askuser` to query the user about the goal again. Note, however, that it calls `askuser` with the tail of the rule stack. Thus, a series of `why` queries will simply chain back up the rule stack until the stack is exhausted, letting the user trace the entire line of reasoning.

```
solve(true,_) :-!.
solve(not(A),Rules) :- not(solve(A,Rules)).
solve((A,B),Rules) :- !, solve(A,Rules), solve(B,Rules).
solve(A,Rules) :- clause(A,B), solve(B,[(A :- B) | Rules]).
solve(A,Rules) :- askuser(A,Rules).
```

```
askuser(A,Rules) :- write(A),
                    write('? Enter true if goal is true, false otherwise'),nl,
                    read(Answer), respond(Answer,A,Rules).
```

```

respond(true,_,_).
respond(why,A,[Rule | Rules]) :- write(Rule),nl,
    askuser(A,Rules).
respond(why,A,[ ]) :- askuser(A,[ ]).

```

For example, we may run this version of `solve` on the simple database introduced earlier in the section. Note how successive `why` queries trace back up the line of reasoning.

```

?- solve(p(f,g), [ ]).
s(f)? Enter true if goal is true, false otherwise
why.
q(f) :- s(f)
s(f)? Enter true if goal is true, false otherwise
why.
p(f,g) :- (q(f),r(g))
s(f)? Enter true if goal is true, false otherwise
true.
t(g)? Enter true if goal is true, false otherwise
true.
yes

```

Another useful extension to the `solve` predicate constructs a proof tree for any successful goal. The ability to build proof trees provides expert system shells with the means of responding to “how” queries; it is also important to any algorithm, such as explanation-based learning (Section 13.5), that reasons about the results of a problem solver.

We may modify the pure PROLOG interpreter to recursively build a proof tree for a goal as it solves that goal. In the definition that follows, the proof is returned as the second parameter of the `solve` predicate. The proof of the atom `true` is that atom; this halts the recursion. In solving a goal `A` using a rule `A :- B`, we construct the proof of `B` and return the structure `(A :- ProofB)`. In solving a conjunction of goals, `A` and `B`, we simply conjoin the proof trees for each goal: `(ProofA,ProofB)`.

The definition of a meta-interpreter that constructs proof trees is:

```

solve(true, true) :-!.
solve(not(A), not ProofA) :- not (solve(A, ProofA)).
solve((A,B),_(ProofA,ProofB)) :- solve(A,ProofA), solve(B,ProofB).
solve(A,(A :- ProofB)) :- clause(A,B), solve(B,ProofB).
solve(A,(A:-given)) :- askuser(A).

askuser(A,Proof) :- write(A),
    write('enter true if goal is true, false otherwise'),
    read(true).

```

Running this on our simple database gives the results:

```

?- solve(p(a,b), Proof).

```

```

Proof = p(a,b) :-
    ((q(a) :-
      (s(a) :-
        true)),
     (r(b) :-
      (t(b) :-
        true)))

```

In the next section, we use these techniques to implement an expert system shell. `exshell` uses a knowledge base in the form of rules to solve problems. It asks the user for needed information, keeps a record of case-specific data, responds to how and why queries, and implements the certainty factor algebra of Chapter 8. Although this program, `exshell`, is much more complex than the PROLOG meta-interpreters discussed above, it is just an extension of this methodology. Its heart is a `solve` predicate that implements a back-chaining search of rules and facts.

9.7.2 Shell for a Rule-Based Expert System

In this section we present the key predicates used in the design of an interpreter for a goal-driven, rule-based expert system. At the end of this section, we demonstrate the performance of `exshell` using an automotive diagnostic knowledge base. If the reader would prefer to read through this trace before examining `exshell`'s key predicates, we encourage looking ahead.

An `exshell` knowledge base consists of rules and specifications of queries that can be made to the user. Rules are represented using a two-parameter `rule` predicate of the form `rule(R, CF)`. The first parameter is an assertion to the knowledge base, written using standard PROLOG syntax. Assertions may be PROLOG rules, of the form `(G :- P)`, where `G` is the head of the rule and `P` is the conjunctive pattern under which `G` is true. The first argument to the `rule` predicate may also be a PROLOG fact. `CF` is the confidence the designer has in the rule's conclusions. `exshell` implements the certainty algebra of MYCIN, presented in Chapter 8. `CFs` range from 100, a fact that is true, to -100, something that is known to be false. If the `CF` is around 0, the truth value is unknown. Typical rules from a knowledge base for diagnosing automotive failures are:

```

rule((bad_component(starter) :- (bad_system(starter_system),
  lights(come_on))), 50).
rule(fix(starter, 'replace starter'),100).

```

The first rule states that if the bad system is shown to be the starter system and the lights come on, then conclude that the bad component is the starter, with a certainty of 50. The second asserts the fact that we may fix a broken starter by replacing it, with a certainty of 100. `exshell` uses the `rule` predicate to retrieve those rules that conclude about a given goal, just as the simpler versions of `solve` used the built-in `clause` predicate to retrieve rules from the global PROLOG database.

`exshell` supports user queries for unknown data; however, because we do not want the interpreter to ask for every unsolved goal, we allow the programmer to specify exactly what information may be so obtained. We do this with the `askable` predicate; the argument to `askable` is the goal under consideration. For example:

```
askable(car_starts).
```

specifies that the interpreter may ask the user for the truth of the `car_starts` goal when nothing is known or can be concluded about that goal.

In addition to the programmer-defined knowledge base of rules and askables, `exshell` maintains its own record of case-specific data. Because the shell asks the user for information, it needs to remember what it has been told; this prevents the program from asking the same question twice during a consultation (decidedly non-expert behavior!).

The heart of the `exshell` meta-interpreter is a predicate of four arguments called, surprisingly, `solve`. The first of these arguments is the goal to be solved. On successfully solving the goal, `exshell` binds the second argument to the confidence in the goal as computed from the knowledge base. The third argument is the rule stack, used in responding to why queries, and the fourth is the cutoff threshold for the certainty factor algebra. This allows pruning of the search space if the confidence falls below the threshold.

In attempting to satisfy a goal, `G`, `solve/4` first tries to match `G` with any facts that it already has obtained from the user. We represent known facts using the two-parameter `known(A,CF)` predicate. For example, `known(car_starts, 85)` indicates that the user has already told us that the car starts, with a confidence of 85. If the goal is unknown, `solve/4` attempts to solve the goal using its knowledge base. It handles the negation of a goal by solving the goal and multiplying the confidence in that goal by -1 . It solves conjunctive goals in left-to-right order. If `G` is a positive literal, `solve/4` tries any rule whose head matches `G`. If this fails, `solve` queries the user. On obtaining the user's confidence in a goal, `solve/4` asserts this information to the database using a `known/2` predicate.

```
% Case 1: truth value of goal is already known
solve(Goal, CF_-, Threshold) :-
    known(Goal, CF),!,
    above_threshold(CF, Threshold).                                % Test confidence threshold

% Case 2: negated goal
solve(not(Goal), CF, Rules, Threshold) :-!,
    invert_threshold(Threshold, New_threshold),
    solve(Goal, CF_goal, Rules, New_threshold),
    negate_cf(CF_goal, CF).

% Case 3: conjunctive goals
solve((Goal_1,Goal_2), CF, Rules, Threshold) :- !,
    solve(Goal_1, CF_1, Rules, Threshold),
    above_threshold(CF_1, Threshold),
    solve(Goal_2, CF_2, Rules, Threshold),
    above_threshold(CF_2, Threshold),
    and_cf(CF_1, CF_2, CF).                                      % Compute CF for and
```

```

% Case 4: back chain on a rule in knowledge base
solve(Goal, CF, Rules, Threshold) :-
    rule((Goal :- (Premise)), CF_rule),
    solve(Premise, CF_premise, [rule((Goal :- Premise), CF_rule)|Rules], Threshold),
    rule_cf(CF_rule, CF_premise, CF),
    above_threshold(CF, Threshold).
% Case 5: fact assertion in knowledge base
solve(Goal, CF_., Threshold) :-
    rule(Goal, CF),
    above_threshold(CF, Threshold).
% Case 6: ask user
solve(Goal, CF, Rules, Threshold) :-
    askable(Goal),
    askuser(Goal, CF, Rules), !,
    assert(known(Goal, CF)),
    above_threshold(CF, Threshold).

```

We start a consultation using a two-argument version of `solve`. The first argument is the top-level goal in the knowledge base, and the second is a variable that will be bound to the confidence in the goal's truth as inferred from the knowledge base. `solve/2` prints a set of instructions to the user, calls `retractall(known(.,.))` to clean up any residual information saved in the previous use of `exshell`, and calls `solve/4` with appropriate values for its arguments.

```

solve(Goal, CF) :-
    print_instructions,
    retractall(known(.,.)),
    solve(Goal, CF,[],20),

```

% A threshold of 20

`print_instructions` tells the user the allowable responses to an `exshell` query:

```

print_instructions :-
    nl, write('Response must be either:'),
    nl, write(' A confidence in the truth of the query:'),
    nl, write(' This is a number between -100 and 100:'),
    nl, write(' why:'),
    nl, write(' how(X), where X is a goal'), nl.

```

The next set of predicates computes certainty factors. (`exshell` uses a form of the Stanford certainty factor algebra presented in Section 7.1.4.) The certainty factor of the `and` of two goals is the minimum of the certainty factors of the individual goals; the certainty factor of the negation of a fact is -1 times the certainty of that fact. Confidence in a fact concluded using a rule equals the certainty of the premise times the certainty factor in the rule. `above_threshold` determines whether the value of a certainty factor is too low given a particular threshold. `exshell` uses the threshold value to prune a goal if its certainty gets too low. Note that we define `above_threshold` separately for negative and positive values of the threshold. A positive threshold enables us to prune if the goal's confidence is

less than the threshold. However, a negative threshold indicates that we are trying to prove a goal false. Thus for negative goals we prune search if the value of the goal's confidence is greater than the threshold. `invert_threshold` is called to multiply the threshold by -1 .

```
and_cf(A,B,A) :-
    A = < B.
```

```
and_cf(A,B,B) :-
    B < A.
```

```
negate_cf(CF,Negated_CF) :-
    Negated_CF is -1 * CF.
```

```
rule_cf(CF_rule,CF_premise,CF) :-
    CF is (CF_rule * CF_premise/100).
```

```
above_threshold(CF,T) :-
    T >= 0, CF >= T.
```

```
above_threshold(CF,T) :-
    T < 0, CF =< T.
```

```
invert_threshold(Threshold,New_threshold) :-
    New_threshold is -1 * Threshold.
```

`askuser` writes out a query and reads the user's answer; the `respond` predicates take the appropriate action for each user input.

```
askuser(Goal,CF,Rules) :-                                % Ask user for answer to goal
    nl, write('User query:'),
    write(Goal), nl, write('?'),
    read(Answer),
    respond(Answer,Goal,CF,Rules).                       % Processes answer
```

The user can respond to the query with a `CF` between 100 and -100 , indicating his confidence in the goal's truth, `why` to ask why the question was asked, or `how(X)` to inquire how result `X` was established.

The response to a `why` query is the rule currently on top of the rule stack. As with our previous implementation, successive `why` queries will chain back up the rule stack, enabling the user to reconstruct the entire line of reasoning. If the user answer matches `how(X)`, `respond` calls `build_proof` to build a proof tree for `X` and `write_proof` to print that proof in a readable form. There is a "catchall" `respond` for unknown input values.

```
% Case 1: user enters a valid confidence factor
respond(CF, _, CF, _) :-
    number(CF),
    CF =< 100, CF >= -100.
```

```

% Case 2: user enters a why query
respond(why, Goal, CF, [Rule | Rules]) :-
    write_rule(Rule),
    askuser(Goal, CF, Rules).

respond(why, Goal, CF, [ ]) :-
    write('Back to top of rule stack. '),
    askuser(Goal, CF, [ ]).

% Case 3: user enters a how query. Build and print a proof
respond(how(X), Goal, CF, Rules) :-
    build_proof(X, CF_X, Proof),!,
    write(X), write(' was concluded with certainty '), write(CF_X), nl, nl,
    write('The proof is '), nl, nl,
    write_proof(Proof, 0), nl, nl,
    askuser(Goal, CF, Rules).

% User enters how query, could not build proof
respond(how(X), Goal, CF, Rules) :-
    write('The truth of '), write(X), nl,
    write('is not yet known. '), nl,
    askuser(Goal, CF, Rules).

% Case 4: unrecognized input
respond(_, Goal, CF, Rules) :-
    write('Unrecognized response. '), nl,
    askuser(Goal, CF, Rules).

```

The definition of `build_proof` is almost completely parallel to that of `solve/4`. However, `build_proof` does not ask the user for unknown facts, as these have already been saved as case-specific data. `build_proof` constructs a proof tree as it proves the goal.

```

build_proof(Goal,CF,(Goal,CF :- given)) :-
    known(Goal,CF), !.

build_proof(not Goal,CF,not Proof) :-
    !, build_proof(Goal,CF_goal,Proof), negate_cf(CF_goal,CF).

build_proof((Goal_1, Goal_2),CF, (Proof_1, Proof_2)) :-
    !, build_proof(Goal_1,CF_1,Proof_1),
    build_proof(Goal_2,CF_2,Proof_2), and_cf(CF_1,CF_2,CF).

build_proof(Goal,CF,(Goal,CF :- Proof)) :-
    rule((Goal :- Premise),CF_rule),
    build_proof(Premise,CF_premise,Proof),
    rule_cf(CF_rule,CF_premise,CF),

build_proof(Goal,CF,(Goal,CF :- fact)) :-
    rule(Goal,CF).

```

The final predicates create a simple user interface. As is so often true, the interface requires the bulk of the code! First, we define a predicate to write out a rule in a readable format:

```
write_rule(rule((Goal :- (Premise)), CF)) :-
    write(Goal), write(':-'), nl,
    write_premise(Premise), nl,
    write('CF = '), write(CF), nl.
write_rule(rule(Goal, CF)) :-
    write(Goal), nl,
    write('CF = '), write(CF), nl.
```

`write_premise` writes the conjuncts of a rule premise:

```
write_premise((Premise_1, Premise_2)) :-
    !, write_premise(Premise_1),
    write_premise(Premise_2).
write_premise(not Premise) :-
    !, write(' '), write(not), write(' '), write(Premise), nl.
write_premise(Premise) :-
    write(' '), write(Premise), nl.
```

`write_proof` prints out a proof, using indentation to show the structure of the tree:

```
write_proof((Goal, CF :- given), Level) :-
    indent(Level), write(Goal),
    write(' CF = '), write(CF),
    write(' was given by the user'), nl, !.
write_proof((Goal, CF :- fact), Level) :-
    indent(Level), write(Goal), write(' CF = '), write(CF),
    write(' was a fact in the knowledge base'), nl, !.
write_proof((Goal, CF :- Proof), Level) :-
    indent(Level), write(Goal), write(' CF = '), write(CF), write(' :-'),
    nl, New_level is Level + 1, write_proof(Proof, New_level), !.
write_proof(not Proof, Level) :-
    indent(Level), write((not)), nl,
    New_level is Level + 1, write_proof(Proof, New_level), !.
write_proof((Proof_1, Proof_2), Level) :-
    write_proof(Proof_1, Level), write_proof(Proof_2, Level), !.
indent(0).
indent(l) :-
    write(' '), l_new is l - 1, indent(l_new).
```

As an illustration of the behavior of `exshell`, consider the following sample knowledge base for diagnosing car problems. The top-level goal is `fix/1`. The knowledge base decomposes the problem solution into finding the bad system, finding the bad component within that system, and finally linking the diagnosis to the advice for its solution. Note that the knowledge base is incomplete; there are sets of symptoms that it cannot diagnose. In this case, `exshell` simply fails. Extending the knowledge base to some of these cases and adding a rule that succeeds if all others fail are interesting challenges and left as exercises.

```

rule((fix(Advice) :-                                     % Top-level query
      (bad_component(X), fix(X,Advice))), 100).

rule((bad_component(starter) :-
      (bad_system(starter_system), lights(come_on))), 50).
rule((bad_component(battery) :-
      (bad_system(starter_system), not lights(come_on))), 90).
rule((bad_component(timing) :-
      (bad_system(ignition_system), not tuned_recently)), 80).
rule((bad_component(plugs) :-
      (bad_system(ignition_system), plugs(dirty))), 90).
rule((bad_component(ignition_wires) :-
      (bad_system(ignition_system), not plugs(dirty), tuned_recently)), 80).

rule((bad_system(starter_system) :-
      (not car_starts, not turns_over)), 90).
rule((bad_system(ignition_system) :-
      (not car_starts, turns_over, gas_in_carb)), 80).
rule((bad_system(ignition_system) :-
      (runs(rough), gas_in_carb)), 80).
rule((bad_system(ignition_system) :-
      (car_starts, runs(dies), gas_in_carb)), 60).

rule(fix(starter,'replace starter'), 100).                %Advice for problems
rule(fix(battery,'replace or recharge battery'), 100).
rule(fix(timing,'get the timing adjusted'), 100).
rule(fix(plugs,'replace spark plugs'), 100).
rule(fix(ignition_wires,'check ignition wires'), 100).

askable(car_starts).                                     % May ask user about goal
askable(turns_over).
askable(lights(_)).
askable(runs(_)).
askable(gas_in_carb).
askable(tuned_recently).
askable(plugs(_)).

```

The following consultation shows a run of `exshell` using this knowledge base; there are no how or why queries. Figure 9.6 illustrates the space searched in the consultation. In

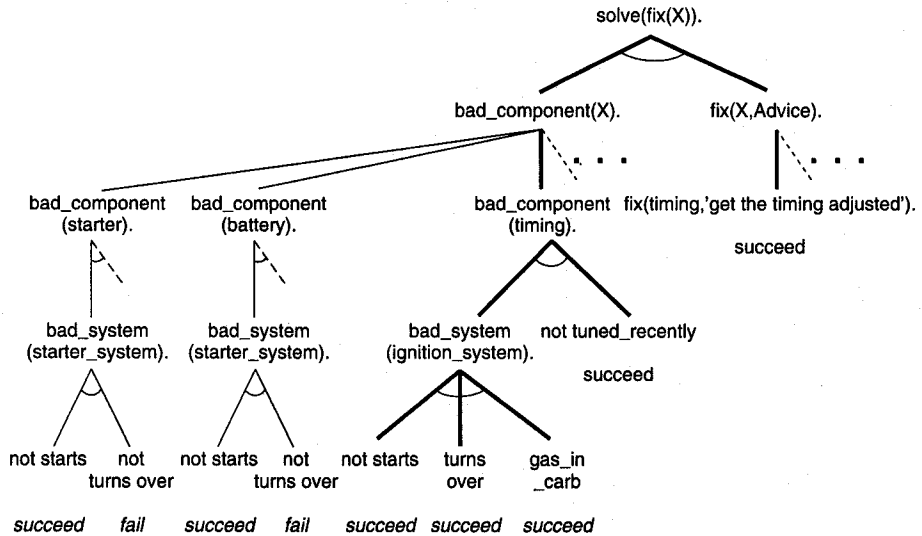

Figure 9.6 Graph searched in automotive diagnostic consultation. Dashed lines indicate branches pruned from consideration; bold lines indicate final solutions.

Figure 9.6, the solid lines indicate branches searched, bold lines indicate the successful solution, and dotted lines indicate branches not searched.

?- solve(fix(X), CF).

Response must be either:

A confidence in the truth of the query.

This is a number between -100 and 100.

why.

how(X), where X is a goal

User query:car_starts

? -100.

User query:turns_over

? 85.

User query:gas_in_carb

? 75.

User query:tuned_recently

? -90.

X = 'get the timing adjusted', CF = 48.0

We now run the same problem situation with how and why queries. Compare the responses with the corresponding subtrees and paths in Figure 9.6:

?- solve(fix(X), CF).

Response must be either:

A confidence in the truth of the query.

This is a number between -100 and 100.

why.

how(X), where X is a goal

User query:car_starts

? -100.

User query:turns_over

? why.

bad_system(starter_system):-

not car_starts

not turns_over

CF = 90

User query:turns_over

? why.

bad_component(starter):-

bad_system(starter_system)

lights(come_on)

CF = 50

User query:turns_over

? why.

fix(_0):-

bad_component(starter)

fix(starter,_0)

CF = 100

User query:turns_over

? why.

Back to top of rule stack.

User query:turns_over

? 85.

User query:gas_in_carb

? 75.

User query:tuned_recently

? why.

```
bad_component(timing):-
  bad_system(ignition_system)
  not tuned_recently
```

CF = 80

```
User query:tuned_recently
? how(bad_system(ignition_system)).
```

bad_system(ignition_system) was concluded with certainty 60.0

The proof is

```
bad_system(ignition_system) CF= 60.0 :-
  not
    car_starts CF= -100 was given by the user
    turns_over CF 85 was given by the user
    gas_in_carb CF= 75 was given by the user
```

```
User query:tuned_recently
? -90.
X = 'get the timing adjusted', CF = 48.0
```

9.7.3 Semantic Nets in PROLOG

In this section, we discuss the implementation of inheritance for a simple semantic network language (Chapter 8). Our language lacks the full power and generality of a language such as conceptual graphs; in particular, we ignore the important distinction between classes and instances (see also Chapter 8). This restricted language simplifies the implementation.

In the semantic net of Figure 9.7, nodes represent individuals such as the canary *tweety* and classes such as *ostrich*, *crow*, *robin*, *bird*, and *vertebrate*. *isa* links represent the class hierarchy relationship.

For representational clarity and consistency as well as for ease in building search procedures, we adopt canonical forms for the data relationships within the net. We use an *isa*(Type, Parent) predicate to indicate that Type is a member of Parent and a *hasprop*(Object, Property, Value) predicate to represent property relations. *hasprop* indicates that Object has Property with Value. Object and Value are nodes in the network, and Property is the name of the link that joins them.

A partial list of predicates describing the bird hierarchy of Figure 9.7 with a semantic network is:

```
isa (canary, bird).          isa (robin, bird).
isa (ostrich, bird).        isa (penguin, bird).
isa (bird, animal).         isa (fish, animal).
isa (opus, penguin).        isa (tweety, canary).
```

hasprop (tweety, color, white).
 hasprop (canary, color, yellow).
 hasprop (bird, travel, fly).
 hasprop (ostrich, travel, walk).
 hasprop (robin, sound, sing).
 hasprop (bird, cover, feathers).

hasprop (robin, color, red).
 hasprop (penguin, color, brown).
 hasprop (fish, travel, swim).
 hasprop (penguin, travel, walk).
 hasprop (canary, sound, sing).
 hasprop (animal, cover, skin).

We create a recursive search algorithm to find whether an object in our semantic net has a particular property. Properties are stored in the net at the most general level at which they are true. Through inheritance, an individual or subclass acquires the properties of its superclasses. Thus the property fly holds for bird and all its subclasses. Exceptions are located at the specific level of the exception. Thus, ostrich and penguin travel by

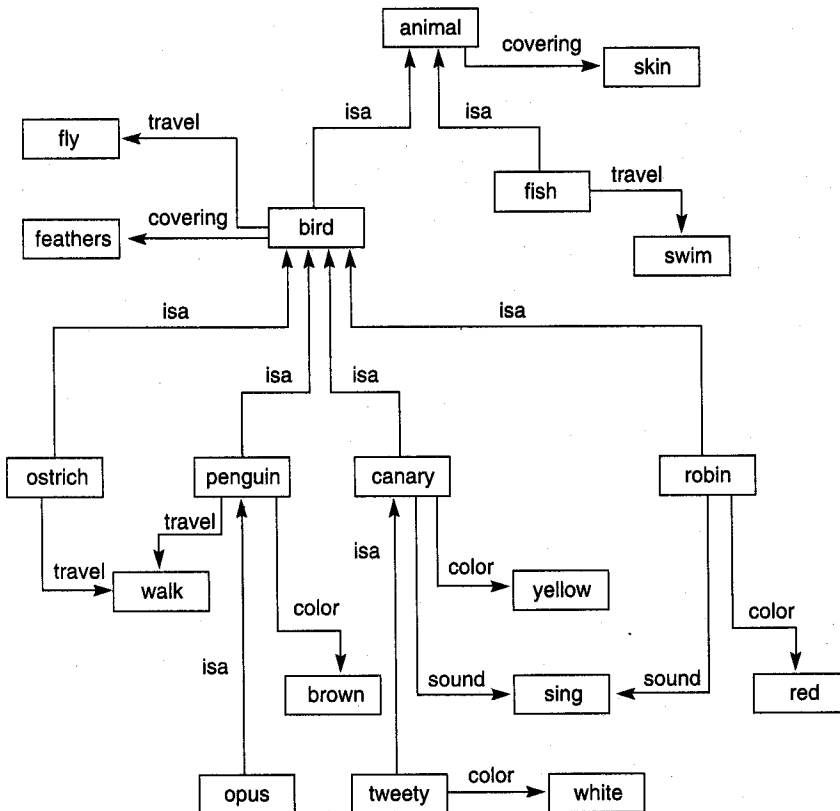

Figure 9.7 Portion of a semantic network describing birds and other animals.

walking instead of flying. The `hasproperty` predicate begins search at a particular object. If the information is not directly attached to that object, `hasproperty` follows `isa` links to superclasses. If no more superclasses exist and `hasproperty` has not located the property, it fails.

```
hasproperty(Object, Property, Value) :-
    hasprop(Object, Property, Value).
```

```
hasproperty(Object, Property, Value) :-
    isa(Object, Parent),
    hasproperty(Parent, Property, Value).
```

`hasproperty` searches the inheritance hierarchy in a depth-first fashion. In the next section, we show how inheritance can be applied to a frame-based representation and implement both tree and multiple-inheritance relations.

9.7.4 Frames and Schemata in PROLOG

Semantic nets can be partitioned, with additional information added to node descriptions, to give them a frame structure. We redefine the bird example of the previous subsection using frames, where each frame represents a collection of relationships of the semantic net and the `isa` slots of the frame define the frame hierarchy (Fig. 9.8).

The first slot of each frame names the node, such as `name(tweety)` or `name(vertebrate)`. The second slot gives the inheritance links between the node and its parents. Because our example has a tree structure, each node has only one link, the `isa`

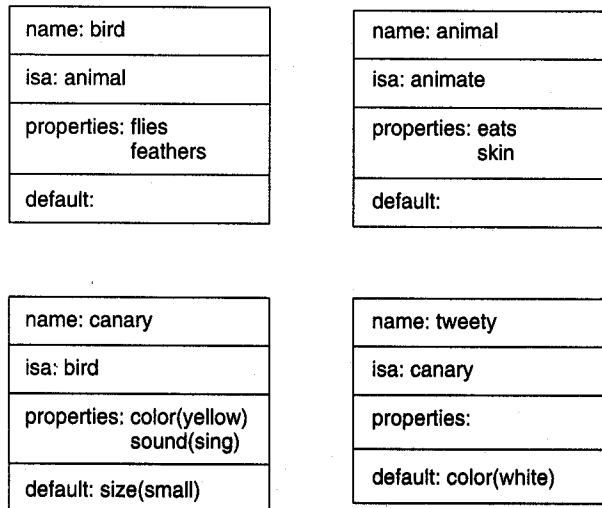

Figure 9.8 Frames from a knowledge base of birds.

predicate with one argument. The third slot in the node's frame is a list of features that describe that node. In this list we use any PROLOG predicate such as `flies`, `feathers`, or `color(brown)`. The final slot in the frame is the list of exceptions and default values for the node, again either a single word or predicate indicating a property.

In our frame language, each `frame` organizes its slot names into lists of properties and default values. This allows us to distinguish these different types of knowledge and give them different behaviors in the inheritance hierarchy. Although our implementation allows subclasses to inherit properties from both lists, other representations are possible and may be useful in certain applications. We may wish to specify that only default values are inherited. Or we may wish to build a third list containing the properties of the class itself rather than the members, sometimes called *class values*. For example, we may wish to state that the class `canary` names a species of songbird. This should not be inherited by subclasses or instances: `tweety` does not name a species of songbird. Readers are asked to define and build different frame representations and inheritance schemes in the exercises at the end of the chapter.

We now represent the relationships in Figure 9.8 with the PROLOG fact predicate `frame` with four arguments. We may use the methods suggested in Section 9.6.2 to check the parameters of the `frame` predicate for appropriate type, for instance, to ensure that the third frame slot is a list that contains only values from a fixed list of properties.

```
frame(name(bird),
      isa(animal),
      [travel(flies), feathers],
      []).
```

```
frame(name(penguin),
      isa(bird),
      [color(brown)],
      [travel(walks)]).
```

```
frame(name(canary),
      isa(bird),
      [color(yellow), call(sing)],
      [size(small)]).
```

```
frame(name(tweety),
      isa(canary),
      [],
      [color(white)]).
```

Once the full set of descriptions and inheritance relationships are defined for the frame of Figure 9.8, we create procedures to infer properties from this representation:

```
get(Prop, Object) :-
    frame(name(Object),_, List_of_properties,_),
    member(Prop, List_of_properties).
```



```
get(Prop, Object) :-  
    frame(name(Object),_,_ List_of_defaults),  
    member(Prop, List_of_defaults).
```

```
get(Prop, Object) :-  
    frame(name(Object), isa(Parent),_,_),  
    get(Prop, Parent).
```

If the frame structure allows multiple inheritance of properties (Section 8.5), we make this change both in our representation and in our search strategy. First, in the frame representation we make the argument of the `isa` predicate the list of superclasses of the `Object`. Thus, each superclass in the list is a parent of the entity named in the first argument of `frame`. If `opus` is a `penguin` and a `cartoon_char`, as in Figure 8.27, we represent this:

```
frame(name(opus),  
    isa([penguin, cartoon_char]),  
    [color(black)],  
    []).
```

Now, we test for properties of `opus` by recurring up the `isa` hierarchy for both `penguin` and `cartoon_char`. We add the additional solve definition between the third and fourth `get` predicates of the previous example.

```
get(Prop, Object) :-  
    frame(name(Object), isa(List),_,_),  
    get_multiple(Prop, List).
```

We define `get_multiple` by:

```
get_multiple(Prop, [Parent | _]) :-  
    get(Prop, Parent).
```

```
get_multiple(Prop, [_ | Rest]) :-  
    get_multiple(Prop, Rest).
```

With this inheritance preference, properties of `penguin` and its superclasses will be examined before those of `cartoon_char`.

Finally, any PROLOG procedure may be attached to a frame slot. As we have built the frame representation in our examples, this would entail adding a PROLOG rule, or list of PROLOG rules, as a parameter of `frame`. This is accomplished by enclosing the entire rule in parentheses, as we did for rules in `exshell`, and making this structure an argument of the `frame` predicate. For example, we could design a list of response rules for `opus`, giving him different responses for different questions.

This list of rules, each rule in parentheses, would then become a parameter of the frame and, depending on the value of `X` passed to the `opus` frame, would define the appropriate response. More complex examples could be rules describing the control of a

thermostat or creating a graphic image appropriate to a set of values. These examples are presented in Chapter 10, where attached procedures, often called *methods*, play an important role in object-oriented representations.

9.8 PROLOG: Towards Nonprocedural Computing

In traditional computer languages such as FORTRAN and C, the logic for the problem's specification and the control for executing the solution algorithm are inextricably mixed together. A program in these languages is simply a sequence of things to be done to get an answer. This is the accepted notion of a *procedural* language.

One of the goals of the designers of PROLOG has been to separate the logic or specification for a problem from the execution of that specification. There are several reasons for this separation, not the least of which is the ability to determine after the specifications are created what might be the best control for executing them.

Another goal of this separation of logic from control is that each aspect of the problem may be analyzed separately. The specifications may themselves be translated to other specifications before execution. Specifications may be checked for correctness or otherwise evaluated independently of their execution.

In the future, it might even be possible to send a logic specification to a number of processors, where the number of processors and the distribution of the specification predicates among the processors are seen as a deterministic aspect of the specifications themselves.

Needless to say, PROLOG has not yet achieved this state of computing nirvana! It is still possible, however, to show how logic programming, as represented by the PROLOG language, exhibits some benefits of a nonprocedural semantics. How the interpreter achieves these features can be clearly understood only after the subsection on Horn clause resolution in Chapter 12. We now present several examples of the declarative nature of PROLOG.

For the first example consider the predicate `append`. This predicate is defined:

```
append([ ], L, L).  
append([X | T], L, [X | NL]) :- append(T, L, NL)
```

`append` is nonprocedural in that it defines a relationship between lists rather than a series of operations for joining two lists. Consequently, different queries will cause it to compute different aspects of this relationship. We can understand `append` by tracing its execution in joining two lists together. If the following call is made, the response is:

```
?- append([a,b,c], [d,e], Y).  
Y = [a,b,c,d,e]
```

The execution of `append` is not tail recursive, in that the local variable values are accessed after the recursive call has succeeded. In this case, `X` is placed on the head of

the list ($[X \mid NL]$) after the recursive call has finished. This requires that a record of each call be kept on the PROLOG stack. For purposes of reference in the following trace:

1. is `append([], L, L)`.
2. is `append([X | T], L, [X | NL]) :- append(T, L, NL)`.

?- `append([a,b,c], [d,e], Y)`.

try match 1, fail `[a,b,c] ≠ []`
match 2, X is a, T is `[b,c]`, L is `[d,e]`, call `append([b,c], [d,e], NL)`

try match 1, fail `[b,c] ≠ []`
match 2, X is b, T is `[c]`, L is `[d,e]`, call `append([c], [d,e], NL)`

try match 1, fail `[c] ≠ []`
match 2, X is c, T is `[]`, L is `[d,e]`, call `append([], [d,e], NL)`

match 1, L is `[d,e]` (for BOTH parameters), yes

yes, N is `[d,e]`, $[X \mid NL]$ is `[c,d,e]`

yes, NL is `[c,d,e]`, $[X \mid NL]$ is `[b,c,d,e]`

yes, NL is `[b,c,d,e]`, $[X \mid NL]$ is `[a,b,c,d,e]`

Y = `[a,b,c,d,e]`, yes

In the PROLOG algorithms shown in this chapter, the parameters of the predicates seem to be intended as either “input” or “output”; most definitions assume that certain parameters would be bound in the call and others would be unbound. This need not be so. In fact, there is no commitment at all to parameters being input or output in PROLOG! PROLOG code is intended to be simply a set of specifications of what is true, a statement of the logic of the situation. Thus, `append` specifies the relationship between three lists, such that the third list is the catenation of the first onto the front of the second.

To demonstrate this fact we can give `append` a different set of goals:

?- `append([a,b], [c], [a,b,c])`.

yes

?- `append([a], [c], [a,b,c])`.

no

We can also use an unbound variable for different parameters of the call to `append`:

?- `append(X, [b,c], [a,b,c])`.

X = `[a]`

?- `append(X,Y, [a,b,c])`.

X = `[]`

Y = `[a,b,c]`

```

;
X = [a]
Y = [b,c]
;
X = [a,b]
Y = [c]
;
X = [a,b,c]
Y = [ ]
;
no

```

In the last query, PROLOG returns all the lists *X* and *Y* that, appended together, give *[a,b,c]*—four pairs of lists in all. As mentioned above, **append** is a statement of the logic of a relationship among three lists. What the interpreter produces depends on the specific query it is given.

Our second example of the nonprocedural nature of logic programming is a simple program that is both a parser and a generator of sentences. We selected this example both to demonstrate nonprocedurality and to show a common method of parsing and generating sentences using PROLOG. This is also a direct implementation of the “parser” in the applications section of Chapter 3 and a precursor of parsing and grammars in Chapter 11.

Consider the subset of English grammar rules below. These rules are nonprocedural in that they simply define relationships among parts of speech. With this subset of rules a large number of simple sentences can be judged as well formed or not.

```

Sentence ↔ NounPhrase VerbPhrase
NounPhrase ↔ Noun

```

```

NounPhrase ↔ Article Noun
VerbPhrase ↔ Verb
VerbPhrase ↔ Verb NounPhrase

```

Adding some vocabulary to the grammar rules:

```

Article(a)
Article(the)
Noun(man)
Noun(dog)
Verb(likes)
Verb(bites)

```

The parse tree of a simple sentence (“the man bites the dog”) is shown in Figure 9.9.

The specification rules of the grammar are transcribed into PROLOG rules in a natural fashion. For example, a **sentence** is a **nounphrase** and a **verbphrase**. This is represented as the PROLOG rule:

```

sentence(Start,End) :- nounphrase(Start,Rest), verbphrase(Rest,End).

```

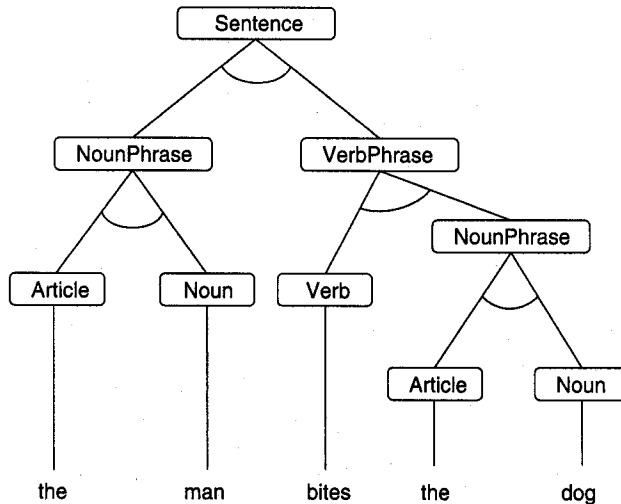

Figure 9.9 Parse tree for the sentence “The man bites the dog.”

Each PROLOG rule takes two parameters. The first is a sequence of words in list form. The rule attempts to determine whether some initial part of the list is a legal part of speech. Any remaining suffix of the list not parsed will match the second parameter. Thus, we are implementing a left-to-right parse of the sentence. If the sentence rule succeeds, the second parameter of **sentence** will have the value of what remains after the **nounphrase** and **verbphrase** parse; if the list is a correct sentence, this is []. The two alternative forms of noun phrases and verb phrases as similarly defined.

The sentence itself, for simplicity, is case as a list: [the,man,likes,the,dog]. The list is now broken up and passed to the various grammar rules to be examined for syntactic correctness. Note how the “pattern matching” works on the list in question: pulling off the head, or the head and second element; passing on what is left over; and so on.

The complete grammar is defined below. The **utterance** predicate takes the list to be parsed as its argument and calls the sentence rule. It initializes the second parameter of **sentence** to [], indicating that nothing should remain in the list after a successful parse.

```
utterance(X) :- sentence(X,[ ]).
```

```
sentence(Start,End) :- nounphrase(Start,Rest), verbphrase(Rest,End).
```

```
nounphrase([Noun | End], End) :- noun(Noun).
```

```
nounphrase([Article,Noun | End], End) :- article(Article), noun(Noun).
```

```
verbphrase([Verb | End], End) :- verb(Verb).
```

```
verbphrase([Verb | Rest], End) :- verb(Verb), nounphrase(Rest,End).
```

article(a).
article(the).
noun(man).
noun(dog).
verb(likes).
verb(bites).

Example sentences may be tested for well-formedness:

?- utterance([the,man,bites,the,dog]).
yes
?- utterance([the,man,bites,the]).
no

New, partial sentences may be proposed and the interpreter asked to fill in potential remaining words so that the sentence is syntactically correct:

?- utterance([the,man,likes,X]).
X = man
;
X = dog
;
no

PROLOG finds all legitimate ways in which the sentence may be concluded!

Finally, the same code may be used to generate the set of all well-formed sentences using this limited dictionary and set of grammar rules:

?- utterance(X).
[man,likes]
;
[man,bites]
;
[man,likes,man]
;
[man,likes,dog]
etc.

If the user continues asking for more solutions, eventually all possible well-formed sentences that can be generated from the grammar rules and our vocabulary are returned as values for X. Note that the PROLOG search is left to right and depth-first.

The grammar rules are the specification set for well-formedness of expressions in this subset of legitimate sentences of English. The PROLOG code represents this set of logic specifications. The interpreter is asked questions about this set of specifications. Thus, the answer is a function of the specifications and the question asked. This is a major advantage of computing with a language that is itself a theorem prover operating on specifications! Further details on PROLOG as a theorem prover are provided in Chapter 12.

The previous example can be extended in a straightforward fashion. Suppose we desire to have proper noun-verb agreement in sentences. In the dictionary entry for each word its singular or plural form can be noted as such. Then in the grammar specifications for nounphrase and verbphrase a further parameter can be entered to signify the number of each phrase. Thus, a singular noun has to be associated with a singular verb.

This modification increases the power of the grammar considerably. Whereas the first version implemented a context-free grammar, this version implements a context-sensitive grammar (Chapter 11). It retains the contextual information needed to check number agreement. These additions are made to the previous code:

```
utterance(X) :- sentence(X, []).

sentence(Start, End) :- nounphrase(Start, Rest, Number),
    verbphrase(Rest, End, Number).

nounphrase([Noun | End], End, Number) :- noun(Noun, Number).
nounphrase([Article, Noun | End], End, Number) :- noun(Noun, Number),
    article(Article, Number).

verbphrase([Verb | End], End, Number) :- verb(Verb, Number).
verbphrase([Verb | Rest], End, Number) :- verb(Verb, Number),
    nounphrase(Rest, End, _).

article(a, singular).
article(these, plural).
article(the, singular).
article(the, plural).
noun(man, singular).
noun(men, plural).
noun(dog, singular).
noun(dogs, plural).
verb(likes, singular).
verb(like, plural).
verb(bites, singular).
verb(bite, plural).
```

New sentences may now be tested:

```
?- utterance([the,men,like,the,dog]).
yes
?- utterance([the,men,likes,the,dog]).
no
```

The answer to the second query is no, because the subject (men) and the verb (likes) do not agree in number. If we enter the goal:

```
?- utterance([the,men | X]).
```

X returns all well-formed verb phrases for completing the sentence “the men. . .” with noun-verb number agreement! As before, we may request all legitimate sentences, according to the grammar and dictionary:

?- utterance(X).

The present example uses the parameters on dictionary entries to introduce more information on the meanings in the sentence. This approach may be generalized to a powerful parser for natural language. More and more information may be included in the dictionary about the items described in the sentences, implementing a knowledge base of the meaning of English words. For example, men are animate and human. Similarly, dogs may be described as animate and nonhuman. With these descriptions new rules may be added for parsing, such as “humans do not bite animate nonhumans” to eliminate sentences such as [the,man,bites,the,dog]. If the nonhuman is no longer animate, of course, it might be eaten in a restaurant! These ideas are developed further in Chapter 11.

Semantic networks and other representations of this sort have played an important role in artificial intelligence research. These topics are also seen in Chapters 8 and 10.

9.9 Epilogue and References

PROLOG is a general-purpose language, and we ignored a great number of its important concepts because of the space limitations of our book. We recommend that the interested reader pursue some of the many excellent texts available, such as *Programming in Prolog* (Clocksin and Mellish 1984), *Computing with Logic* (Maier and Warren 1988), *The Art of PROLOG* (Sterling and Shapiro 1986), *The Craft of PROLOG* (O’Keefe 1990), *Techniques of PROLOG Programming* (VanLe 1993), *Mastering PROLOG* (Lucas 1996), or *Advanced PROLOG: Techniques and Examples* (Ross 1989). *Knowledge Systems through PROLOG* (King 1991) and *Natural Language Processing in PROLOG* (Gazdar and Mellish 1989) examine the use of PROLOG in a number of important application areas.

The most important topic of this chapter, however, is the introduction of the language itself. The notion of solving a problem based on a set of specifications for correct relationships in a domain area coupled with the action of a theorem prover is exciting and important. It has proven its power in areas as diverse as natural language understanding, deductive databases, compiler writing, machine learning, and the generation of computer programs from high-level specifications.

Of course, PROLOG is not a pure “nonprocedural” language. Such a language probably will not be created using computing architectures as they are currently known. However, the move that PROLOG offers toward a fully declarative specification language is important. Indeed, a strength of PROLOG interpreters is that they are open to a procedural as well as a declarative conceptualization (Kowalski 1979*b*). Thus a clause such as:

A :- B, C, D.

might in one instance be a specification logic:

A is true if B and C and D are true.

and in another instance be a procedure for doing something:

To accomplish A go out and first do B and then do C and finally do D.

This procedural interpretation lends representational flexibility to the PROLOG language.

How the PROLOG interpreter works cannot be properly understood without the concepts of resolution theorem proving, especially the Horn clause refutation process. This is presented in detail in Chapter 12.

Most PROLOG texts (Sterling and Shapiro 1986, Walker et al. 1987) treat the meta-predicates, type constraints, and difference lists as presented in Section 13.1. A more complete discussion of types, as well as suggestions for building a type checker, is presented in *A Polymorphic Type System for Prolog* by Alan Mycroft and Richard O'Keefe (1984). The use of rule stacks and proof trees in the design of meta-interpreters for rule-based expert systems was suggested by Leon Sterling and Ehud Shapiro (1986).

Building AI representations such as semantic nets, frames, and objects is discussed in a number of books, especially *Knowledge Systems and Prolog* by Adrian Walker, Michael McCord, John Sowa, and Walter Wilson (1987) and *PROLOG: A Relational Language and Its Applications* by John Malpas (1987).

The PROLOG representation medium is so applicable for natural language understanding that many projects use PROLOG to model language. The first PROLOG interpreter was designed to analyze French using *metamorphosis grammars* (Colmerauer 1975). Fernando Pereira and David Warren (1980) created *definite clause grammars*. Veronica Dahl (1977), Dahl and McCord (1983), Michael McCord (1982, 1986), and John Sowa (Sowa 1984, Walker et al. 1987) have all contributed to this research.

The intellectual roots of PROLOG reside in the theoretical concepts of using logic for problem specification and solution. The main commentator on these issues is Robert Kowalski. Especially recommended are *Logic for Problem Solving* (Kowalski 1979b) and "Algorithm = logic + control" (Kowalski 1979a). Further references are found in the introduction to Part IV.

9.10 Exercises

1. Create a relational database in PROLOG. Represent the data tuples as facts and the constraints on the data tuples as rules. Suitable examples might be from stock in a department store or records in a personnel office.
2. Write a PROLOG program to answer Wirth's "I am my own grandfather" problem (Chapter 2, Exercise 12).
3. Write the "member check" program in PROLOG. What happens when an item is not in the list? Query to the "member" specification to break a list into its component elements.

4. Design a PROLOG program `unique(Bag,Set)` that takes a **Bag** (a list that may contain duplicate elements) and returns a **Set** (no elements are repeated).
5. Write a PROLOG program to count the elements in a list (a list within the list counts as one element). Write a program to count the atoms in a list (count the elements within any sublist). Hint: several meta-predicates such as `atom()` can be helpful.
6. Write the PROLOG code for the farmer, wolf, goat, and cabbage problem.
 - a. Execute this code and draw a graph of the search space.
 - b. Alter the rule ordering to produce alternative solution paths.
 - c. Use the shell in the text to produce a breadth-first problem.
 - d. Describe a heuristic that might be appropriate for this problem.
 - e. Build the heuristic search solution.
7. Do a to e as in Exercise 6 for the missionary and cannibal problem:

Three missionaries and three cannibals come to the bank of a river they wish to cross. There is a boat that will hold only two, and any of the group is able to row. If there are ever more missionaries than cannibals on any side of the river the cannibals will get converted. Devise a series of moves to get all the people across the river with no conversions.
8. Use your code to check alternative forms of the missionary and cannibal problem—for example, when there are four missionaries and four cannibals and the boat holds only two. What if the boat can hold three? Try to generalize solutions for the whole class of missionary and cannibal problems.
9. Write PROLOG code to solve the full 8×8 knight's tour problem. Use the production system architecture proposed in this chapter and Chapter 5. Do tasks a to e in Ex. 6.
10. Do a to e as in Exercise 6 for the water jugs problem:

There are two jugs, one holding 3 and the other 5 gallons of water. A number of things can be done with the jugs: they can be filled, emptied, and dumped one into the other either until the poured-into jug is full or until the poured-out-of jug is empty. Devise a sequence of actions that will produce 4 gallons of water in the larger jug. (Hint: use only integers.)
11. Take the path algorithm presented for the knight's tour problem in the text. Rewrite the path call in the recursive code to the following form:

```
path(X,Y) :- path(X,W), move(W,Y).
```

Examine the trace of this execution and describe what is happening.
12. Write the PROLOG code for a subset of English grammar rules, as in Section 6.6. Add:
 - a. Adjectives and adverbs that can modify verbs and nouns, respectively.
 - b. Prepositional phrases. (Can you do this with a recursive call?)
 - c. Compound sentences (two sentences joined by a conjunction).
13. The simple natural language parser presented in this chapter will accept grammatically correct sentences that may not have a commonsense meaning, such as "the man bites the dog." These sentences may be eliminated from the grammar by augmenting the parser to include some notion of what is semantically plausible. Design a small "semantic network" in PROLOG (see comments in text) to allow you to reason about some aspect of the possible interpretations of the English grammar rules, such as when it is reasonable for "the man to bite the dog."

14. Write a program to pass values up to the top level of a game tree or graph:
 - a. Using MIN-MAX.
 - b. Using alpha-beta pruning of the tree.
 - c. Using both of these on the game of tic-tac-toe.
15. Write a PROLOG program to build the search process for the financial advisor program that was used in Chapters 2-5. Use the production system architecture. Add several more advisory rules to make the program more interesting.
16. Finish the code for the planner of Section 6.5. Add code for a situation that requires a new set of moves, such as adding a pyramid or sphere that could not be stacked on.
17. Design a breadth-first search planner for the planner of Section 6.5. Add heuristics to the search of your planning algorithm. Can you specify a heuristic that is admissible?
18. Create a triangle table-like structure to use with your planner. Use it to save, and generalize, where possible, successful move sequences.
19. Create the full set of ADT predicates for the priority queue in Section 6.2.
20. Create a type check that prevents the `append(nil,6,6)` anomaly.
21. Is the difference list append really a linear time append (Section 9.6)? Explain.
22. Create the "inventory supply" database of Section 9.6.2. Build type checks for a set of six useful queries on these data tuples.
23. Extend the simple definition of PROLOG in PROLOG (Section 9.7) to include `or` and `to include cut`.
24. Fill out the rules used with the `exshell` cars example in the text. You might add new subsystems such as the transmission or brakes.
25. Create a knowledge base in a new domain for `exshell`.
26. Create another example semantic network and design a `hasproperty`-like inference mechanism to test whether entities in the net have properties.
27. Take the conceptual graphs used to describe the "dogs world" of Section 11.3. Translate each of the graphs used into PROLOG notation. Design PROLOG rules for the `restrict`, `join`, and `simplify` operations. Hint: create a list of the propositions whose conjunction make up a graph; then operations on the graphs become manipulations of the lists.
28. Implement a frame system with inheritance that allows us to define three kinds of slots: properties of a class that may be inherited by subclasses, properties that are inherited by instances of the class but not by subclasses, and properties of the class and its subclasses that are not inherited by instances (class properties). Discuss the benefits, uses, and problems with this distinction.
29. Build in PROLOG the ATN parser of Section 11.2.4. Add `who` and `what` questions.
30. Currently, if `exshell` cannot solve a goal using the rule base, it fails. Extend `exshell` so if it cannot prove a goal using the rules, and if it is not askable, it will call that goal as a PROLOG query. Adding this option requires changes to both `solve/4` and `build_proof/3`.
31. `exshell` allows the user to respond to queries by entering a confidence in the query's truth, a why query, or a how query. Extend `respond` to allow the user to answer with `y` if the query is true, `n` if it is false. This corresponds to certainty factors of 100 and -100.

AN INTRODUCTION TO LISP

"The name of the song is called 'Haddocks' Eyes.'"

"Oh, that's the name of the song, is it?" Alice said, trying to feel interested.

"No, you don't understand," the Knight said, looking a little vexed. "That's what the name is called. The name really is 'The Aged Aged Man.'"

"Then I ought to have said 'That's what the song is called'?" Alice corrected herself.

"No, you oughtn't: that's quite another thing! The song is called 'Ways and Means': but that's only what it's called you know!"

"Well, what is the song, then?" said Alice, who was by this time completely bewildered.

"I was coming to that," the Knight said.

—LEWIS CARROLL, *Through the Looking Glass*

See simplicity in the complicated.

—LAO TZU

10.0 Introduction

For the 35 years of its existence, LISP has been the dominant language for artificial intelligence programming. Originally designed for symbolic computing, LISP has been extended and refined over its lifetime in direct response to the needs of AI applications. Like most traditional programming languages, LISP is procedural: LISP programs describe *how* to perform an algorithm. This contrasts with *declarative* languages such as PROLOG, whose programs are assertions that define relationships and constraints in a problem domain. However, unlike traditional procedural languages (FORTRAN, Pascal, etc.), LISP is *functional*: its syntax and semantics are derived from the mathematical

theory of recursive functions. The power of functional programming, combined with a rich set of high-level tools for building symbolic data structures such as predicates, frames, networks, and objects, is responsible for LISP's popularity in the AI community. LISP is widely used as a language for implementing AI tools and models, particularly in the research community, where its high-level functionality and rich development environment make it an ideal language for building and testing prototype systems.

In this chapter we introduce the syntax and semantics of Common LISP, with particular emphasis on the features of the language that make it useful for AI programming: the use of lists to create symbolic data structures, and the implementation of interpreters and search algorithms to manipulate these structures. Examples of LISP programs that we develop in this chapter include search engines, pattern matchers, theorem provers, rule-based expert system shells, semantic networks, and object-oriented simulations. It is not our goal to provide a complete introduction to LISP; a number of excellent texts (see the epilogue to this chapter) do this in far greater detail than our space allows. Instead, we focus on using LISP to implement the representation languages and algorithms of artificial intelligence programming.

10.1 LISP: A Brief Overview

10.1.1 Symbolic Expressions, the Syntactic Basis of LISP

The syntactic elements of the LISP programming language are *symbolic expressions*, also known as *s-expressions*. Both programs and data are represented as s-expressions: an s-expression may be either an *atom* or a *list*. LISP atoms are the basic syntactic units of the language and include both numbers and symbols. Symbolic atoms are composed of letters, numbers, and the following non-alphanumeric characters:

* - + / @ \$ % ^ & _ < > ~ .

Examples of LISP atoms include:

3.1416
100
×
hyphenated-name
some-global
nil

A list is a sequence of either atoms or other lists separated by blanks and enclosed in parentheses. Examples of lists include:

(1 2 3 4)
(tom mary john joyce)

```
(a (b c) (d (e f)))  
( )
```

Note that lists may be elements of lists. This nesting may be arbitrarily deep and allows us to create symbol structures of any desired form and complexity. The empty list, “()”, plays a special role in the construction and manipulation of LISP data structures and is given the special name `nil`. `nil` is the only s-expression that is considered to be both an atom and a list.

Lists are extremely flexible tools for constructing representational structures. For example, we can use lists to represent expressions in the predicate calculus:

```
(on block-1 table)  
(likes bill X)  
(and (likes george kate) (likes bill merry))
```

We use this syntax to represent predicate calculus expressions in the unification algorithm of this chapter. The next two examples suggest ways in which lists may be used to implement the data structures needed in a database application. Section 10.1.5 describes the implementation of a simple data retrieval system using these representations.

```
((2467 (lovelace ada) programmer) (3592 (babbage charles) computer-designer))  
((key-1 value-1) (key-2 value-2) (key-3 value-3))
```

An important feature of LISP is its use of LISP syntax to represent programs as well as data. For example, the lists,

```
(* 7 9)  
(- (+ 3 4) 7)
```

may be interpreted as arithmetic expressions in a prefix notation. This is exactly how LISP treats these expressions, with `(* 7 9)` representing the product of 7 and 9. When LISP is invoked on the computer, the user enters an interactive dialogue with the LISP interpreter. The interpreter prints a prompt (in the examples in this text: `>`), reads the user input, attempts to evaluate that input, and, if successful, prints the result. For example:

```
> (* 7 9)  
63  
>
```

Here, the user enters `(* 7 9)` and the LISP interpreter responds with `63`, i.e., the *value* associated with that expression. LISP then prints another prompt and waits for more user input. This cycle is known as the *read-eval-print loop* and is the heart of the LISP interpreter.

When given a list, the LISP evaluator attempts to interpret the first element of the list as the name of a function and the remaining elements as its arguments. Thus, the s-expression `(f x y)` is equivalent to the more traditional mathematical function notation

$f(x,y)$. The value printed by LISP is the result of *applying* the function to its arguments. LISP expressions that may be meaningfully evaluated are called *forms*. If the user enters an expression that may not be correctly evaluated, LISP prints an error message and allows the user to trace and correct the problem. A sample LISP session appears below:

```
> (+ 14 5)
19
> (+ 1 2 3 4)
10
> (- (+ 3 4) 7)
0
> (* (+ 2 5) (- 7 (/ 21 7)))
28
> (= (+ 2 3) 5)
t
> (> (* 5 6) (+ 4 5))
t
> (a b c)
Error: invalid function: a
```

Several of the examples have arguments that are themselves lists, such as $(- (+ 3 4) 7)$. This indicates the composition of functions, in this case “subtract 7 from the *result* of adding 3 to 4.” The word “*result*” is emphasized here to indicate that the function $-$ is not passed the s-expression “ $(+ 3 4)$ ” as an argument but rather the result of *evaluating* that expression.

In evaluating a function, LISP first evaluates its arguments and then applies the function indicated by the first element of the expression to the results of these evaluations. If the arguments are themselves function expressions, LISP applies this rule recursively to their evaluation. Thus, LISP allows nested function calls of arbitrary depth. It is important to remember that, by default, LISP evaluates everything. LISP uses the convention that numbers always evaluate to themselves. If, for example, 5 is typed into the LISP interpreter, LISP will respond with 5. Symbols, such as x , may have a value *bound* to them. If a symbol is bound, the binding is returned when the symbol is evaluated (one way in which symbols become bound is in a function call; see Section 10.1.2). If a symbol is unbound, it is an error to evaluate that symbol.

For example, in evaluating the expression $(+ (* 2 3) (* 3 5))$, LISP first evaluates the arguments, $(* 2 3)$ and $(* 3 5)$. In evaluating $(* 2 3)$, LISP evaluates the arguments 2 and 3, which return their respective arithmetic values; these values are multiplied to yield 6. Similarly, $(* 3 5)$ evaluates to 15. These results are then passed to the top-level addition, which is evaluated, returning 21. A diagram of this evaluation appears in Figure 10.1.

In addition to arithmetic operations, LISP includes a large number of functions that operate on lists. These include functions to construct and combine lists, to access elements of lists, and to test various properties. For example, *list* takes any number of arguments and constructs a list of those elements. *nth* takes a number and a list as arguments and returns the indicated element of the list. By convention, *nth* begins counting with 0. Examples of these and other list manipulation functions include:

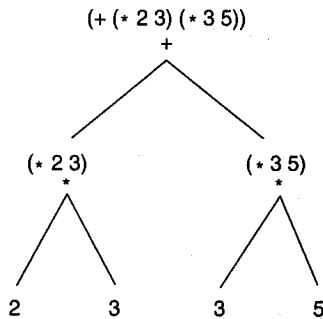

Figure 10.1 Tree diagram of the evaluation of a simple LISP function.

```

> (list 1 2 3 4 5)
(1 2 3 4 5)
> (nth 0 '(a b c d))
a
> (nth 2 (list 1 2 3 4 5))
3
> (nth 2 '((a 1) (b 2) (c 3) (d 4)))
(c 3)
> (length '(a b c d))
4
> (member 7 '(1 2 3 4 5))
nil
> (null ())
t
  
```

We discuss list-handling functions in greater detail in Section 10.1.5. The concepts of this section are summarized in the following definition.

DEFINITION

S-EXPRESSION

An s-expression is defined recursively:

1. An atom is an s-expression.
2. If s_1, s_2, \dots, s_n are s-expressions, then so is the list $(s_1 s_2 \dots s_n)$.

A list is a nonatomic s-expression.

A form is an s-expression that is intended to be evaluated. If it is a list, the first element is treated as the function name and the subsequent elements are evaluated to obtain the function arguments.

In evaluating an s-expression:

If the s-expression is a number, return the value of the number.

If the s-expression is an atomic symbol, return the value bound to that symbol; if it is not bound it is an error.

If the s-expression is a list, evaluate the second through the last arguments and apply the function indicated by the first argument to the results.

LISP represents both programs and data as s-expressions. Not only does this simplify the syntax of the language but also, when combined with the ability to control the evaluation of s-expressions, it makes it easy to write programs that treat other LISP programs as data. This simplifies the implementation of interpreters in LISP.

10.1.2 Control of LISP Evaluation: quote and eval

In the previous section, several of the examples included arguments that were lists preceded by a single quotation mark: '. The purpose of the quote, which can also be represented by the function `quote`, is to prevent evaluation of an s-expression that should be treated as data rather than an evaluable form.

When evaluating an s-expression, LISP will first try to evaluate all of its arguments. If the interpreter is given the expression `(nth 0 (a b c d))`, it will first try to evaluate the argument `(a b c d)`. This attempted evaluation will result in an error, because `a`, the first element of this s-expression, does not represent any known LISP function. To prevent this, LISP provides the user with the built-in function `quote`. `quote` takes one argument and returns that argument without evaluating it. For example:

```
> (quote (a b c))
(a b c)
> (quote (+ 1 3))
(+ 1 3)
```

Because `quote` is used so often, LISP allows it to be abbreviated by a single quotation mark. Thus, the preceding examples could be written:

```
> '(a b c)
(a b c)
> '(+ 1 3)
(+ 1 3)
```

In general, `quote` is used to prevent the evaluation of arguments to a function when these arguments are intended to be treated as data rather than evaluable forms. In the earlier examples of simple arithmetic, `quote` was not needed, because numbers always evaluate to themselves. Consider the effect of `quote` in the following calls to the `list` function:

```
> (list (+ 1 2) (+ 3 4))
(3 7)
> (list '(+ 1 2) '(+ 3 4))
((+ 1 2) (+ 3 4))
```

In the first example, the arguments are not quoted; they are therefore evaluated and passed to `list` according to the default evaluation scheme. In the second example, `quote` prevents this evaluation, with the s-expressions themselves being passed as arguments to `list`. Even though `(+ 1 2)` is a meaningful LISP form, `quote` prevents its evaluation. The ability to prevent evaluation of programs and manipulate them as data is an important feature of LISP.

As a complement to `quote`, LISP also provides a function, `eval`, that allows the programmer to evaluate an s-expression at will. `eval` takes one s-expression as an argument: this argument is evaluated as is usual for arguments to functions; however, the result is then evaluated *again* and this final result is returned as the value of the `eval` expression. Examples of the behavior of `eval` and `quote` include:

```
> (quote (+ 2 3))
(+ 2 3)
> (eval (quote (+ 2 3)))           ; eval undoes the effect of quote
5
> (list ** 2 5)                   ; this constructs an evaluable s-expression
(* 2 5)
> (eval (list ** 2 5))           : this constructs and evaluates it
10
```

The `eval` function is precisely what is used in the ordinary evaluation of s-expressions. By making `quote` and `eval` available to the programmer, LISP greatly simplifies the development of *meta-interpreters*: variations on the standard LISP interpreter that define alternative or extended behaviors for the LISP language. This important programming methodology is illustrated in the “infix-interpreter” of Section 10.7 and the design of an expert system shell in Section 10.10.

10.1.3 Programming in LISP: Creating New Functions

Common LISP includes a large number of built-in functions, including:

A full range of arithmetic functions, supporting integer, rational, real and complex arithmetic.

A variety of looping and program control functions.

List manipulation and other data structuring functions.

Input/output functions.

Forms for the control of function evaluation.

Functions for the control of the environment and operating system.

LISP includes too many functions to list in this chapter; for a more detailed discussion, consult a specialized LISP text or the manual for your particular implementation.

In LISP, we program by defining new functions, constructing programs from this already rich repertoire of built-in functions. These new functions are defined using `defun`, which is short for `define function`. Once a function is defined it may be used in the same fashion as functions that are built into the language.

Suppose, for example, the user would like to define a function called `square` that takes a single argument and returns the square of that argument. `square` may be created by having LISP evaluate the following expression:

```
(defun square (x)
  (* x x))
```

The first argument to `defun` is the name of the function being defined; the second is a list of the formal parameters for that function, which must all be symbolic atoms; the remaining arguments are zero or more s-expressions, which constitute the body of the new function, the LISP code that actually defines its behavior. Unlike most LISP functions, `defun` does not evaluate its arguments; instead, it uses them as specifications to create a new function. As with all LISP functions, however, `defun` returns a value, although the value returned is simply the name of the new function.

The important result of evaluating a `defun` is the side effect of creating a new function and adding it to the LISP environment. In the above example, `square` is defined as a function that takes one argument and returns the result of multiplying that argument by itself. Once a function is defined, it must be called with the same number of arguments, or "actual parameters," as there are formal parameters specified in the `defun`. When a function is called, the actual parameters are bound to the formal parameters. The body of the function is then evaluated with these bindings. For example, the call `(square 5)` causes 5 to be bound to the formal parameter `x` in the body of the definition. When the body `(* x x)` is evaluated, LISP first evaluates the arguments to the function. Because `x` is bound to 5 by the call, this leads to the evaluation of `(* 5 5)`.

More concisely, the syntax of a `defun` expression is:

```
(defun <function name> (<formal parameters>) <function body>)
```

In this definition, descriptions of the elements of a form are enclosed in angle brackets: `<>`. We use this notational convention throughout this text to define LISP forms. Note that the formal parameters in a `defun` are enclosed in a list.

A newly defined function may be used just like any built-in function. Suppose, for example, that we need a function to compute the length of the hypotenuse of a right triangle given the lengths of the other two sides. This function may be defined according to the Pythagorean theorem, using the previously defined `square` function along with the built-in function `sqrt`. We have added a number of comments to this sample code. LISP supports “end of line comments”: it ignores all text from the first “;” to the end of the same line.

```
(defun hypotenuse (x y)                ; the length of the hypotenuse is
  (sqrt (+ (square x)                 ; the square root of the sum of
           (square y))))             ; the squares of the other sides.
```

This example is typical in that most LISP programs are built up of relatively small functions, each performing a single well-defined task. Once defined, these functions are used to implement higher-level functions until the desired “top-level” behavior has been defined.

10.1.4 Program Control in LISP: Conditionals and Predicates

LISP branching is also based on function evaluation: control functions perform tests and, depending on the results, selectively evaluate alternative forms. Consider, for example, the following definition of the absolute value function (note that LISP has a built-in function, `abs`, that computes absolute value):

```
(defun absolute-value (x)
  (cond ((< x 0) (- x))                ; if x is less than 0, return -x
        ((>= x 0) x)))               ; otherwise, return x unchanged
```

This example uses the function, `cond`, to implement a conditional branch. `cond` takes as arguments a number of *condition-action pairs*:

```
(cond (< condition1 > < action1 >)
      (< condition2 > < action2 >)
      ...
      (< conditionn > < actionn >))
```

Conditions and actions may be arbitrary s-expressions, and each pair is enclosed in parentheses. Like `defun`, `cond` does not evaluate all of its arguments. Instead, it evaluates the conditions in order until one of them returns a non-nil value. When this occurs, it evaluates the associated action and returns this result as the value of the `cond` expression. None of the other actions and none of the subsequent conditions are evaluated. If all of the conditions evaluate to nil, `cond` returns nil.

An alternative definition of `absolute-value` is:

```
(defun absolute-value (x)
  (cond ((< x 0) (- x))
        (t x)))
```

; if x is less than 0, return -x
; otherwise, return x unchanged

This version notes that the second condition, ($\geq x 0$), is always true if the first is false. The “t” atom in the final condition of the `cond` statement is a LISP atom that roughly corresponds to “true.” By convention, `t` always evaluates to itself; this causes the last action to be evaluated if all preceding conditions return `nil`. This construct is extremely useful, as it provides a way of giving a `cond` statement a default action that is evaluated if and only if all preceding conditions fail.

Although any evaluable s-expressions may be used as the conditions of a `cond`, generally these are a particular kind of LISP function called a *predicate*. A predicate is simply a function that returns a value of either true or false depending on whether or not its arguments possess some property. The most obvious examples of predicates are the relational operators typically used in arithmetic such as `=`, `>`, and `>=`. Here are some examples of arithmetic predicates in LISP:

```
> (= 9 (+ 4 5))
t
> (>= 17 4)
t
> (< 8 (+ 4 2))
nil
> (oddp 3)
t ; oddp tests whether its argument is odd or not
> (minusp 6)
nil ; minusp tests whether its argument is less than 0
> (numberp 17)
t ; numberp tests whether its argument is numeric
> (numberp nil)
nil
> (zerop 0)
t ; zerop is true if its argument is 0, nil otherwise
> (plusp 10)
t ; plusp is true if its argument is strictly greater than 0
> (plusp -2)
nil
```

Note that the predicates in the above examples do not return “true” or “false” but rather `t` or `nil`. LISP is defined so that a predicate may return `nil` to indicate “false” and anything other than `nil` (not necessarily `t`) to indicate “true.” An example of a function that uses this feature is the `member` predicate. `member` takes two arguments, the second of which must be a list. If the first argument is a member of the second, `member` returns the suffix of the second argument, which contains the first argument as its initial element; if it is not, `member` returns `nil`. For example:

```
> (member 3 '(1 2 3 4 5))
(3 4 5)
```

One rationale for this convention is that it allows a predicate to return a value that, in the "true" case, may be of use in further processing. It also allows any LISP function to be used as a condition in a `cond` form.

As an alternative to `cond`, the `if` form takes three arguments. The first is a test. If it evaluates the test; if it returns a non-`nil` value, the `if` form evaluates its second argument and returns the result, otherwise it returns the result of evaluating the third argument. In cases involving a two-way branch, the `if` construct generally provides cleaner, more readable code than `cond`. For example, `absolute-value` could be defined using the `if` form:

```
(defun absolute-value (x)
  (if (< x 0) (- x) x))
```

In addition to `if` and `cond`, LISP offers a wide selection of alternative control constructs, including iterative constructs such as `do` and `while` loops. Although these functions provide LISP programmers with a wide range of control structures that fit almost any situation and programming style, we will not discuss them in this section; the reader is again referred to a more specialized LISP text for this information.

One of the more interesting program control techniques in LISP involves the use of the logical connectives `and`, `or`, and `not`. `not` takes one argument and returns `t` if its argument is `nil` and `nil` otherwise. Both `and` and `or` may take any number of arguments and behave as you would expect from the definitions of the corresponding logical operators. It is important to note, however, that `and` and `or` are based on *conditional evaluation*.

In evaluating an `and` form, LISP evaluates its arguments in left-to-right order, stopping when any one of the arguments evaluates to `nil` or the last argument has been evaluated. Upon completion, the `and` form returns the value of the last argument evaluated. It therefore returns non-`nil` only if all its arguments return non-`nil`. Similarly, the `or` form evaluates its arguments only until a non-`nil` value is encountered, returning this value as a result. Both functions may leave some of their arguments unevaluated, as may be seen by the behavior of the `print` statements in the following example. Note that in addition to printing its argument, `print` returns a value of `nil` on completion.

```
> (and (oddp 2) (print "second statement was evaluated"))
nil
> (and (oddp 3) (print "second statement was evaluated"))
second statement was evaluated
> (or (oddp 3) (print "second statement was evaluated"))
t
> (or (oddp 2) (print "second statement was evaluated"))
second statement was evaluated
```

Because `(oddp 2)` evaluates to `nil` in the first of the above expressions, the `and` simply returns `nil` without evaluating the `print` form. In the second expression, however, `(oddp 3)`

evaluates to `t` and the `and` form then evaluates the `print`. A similar analysis may be applied to the `or` examples. It is important to be aware of this behavior, particularly if some of the arguments are forms whose evaluations have side effects. (Sources of possible side effects, in addition to the `print` function, may include changes in a global variable, as discussed in Section 10.1.8.)

The conditional evaluation of logical connectives makes them useful in controlling the flow of execution of LISP programs. For example, an `or` form may be used to try alternative solutions to a problem, evaluating them in order until one of them returns a non-`nil` result. An example of this may be found in the implementation of the farmer, wolf, goat, and cabbage problem, see Section 10.2.

10.1.5 Functions, Lists, and Symbolic Computing

Although the preceding sections introduced LISP syntax and demonstrated a few useful LISP functions, they did so in the context of simple arithmetic examples. The real power of LISP, is in symbolic computing and is based on the use of lists to construct arbitrarily complex data structures of symbolic and numeric atoms, along with the forms needed for manipulating them. We illustrate the ease with which LISP handles symbolic data structures, as well as the naturalness of data abstraction techniques in LISP, with a simple database example. Our database application requires the manipulation of employee records containing name, salary, and employee number fields.

These records are represented as lists, with the name, salary, and number fields as the first, second, and third elements of a list. Using `nth`, it is possible to define access functions for the various fields of a data record. For example:

```
(defun name-field (record)
  (nth 0 record))
```

will have the behavior:

```
> (name-field '((Ada Lovelace) 45000.00 38519))
(Ada Lovelace)
```

Similarly, the functions `salary-field` and `number-field` may be defined to access the appropriate fields of a data record. Because a name is itself a list containing two elements, a first name and a last name, it is useful to define functions that take a `name` as argument and return either the first or last name as a result.

```
(defun first-name (name)
  (nth 0 name))
```

will have the behavior:

```
> (first-name (name-field '((Ada Lovelace) 45000.00 338519)))
Ada
```

In addition to accessing individual fields of a data record, it is also necessary to implement functions to create and modify data records. These are defined using the built-in LISP function: `list`. `list` takes any number of arguments, evaluates them, and returns a list containing those values as its elements. For example:

```
> (list 1 2 3 4)
(1 2 3 4)
> (list '(Ada Lovelace) 45000.00 338519)
((Ada Lovelace) 45000.00 338519)
```

As the second of these examples suggests, `list` may be used to define a constructor for records in the database:

```
(defun build-record (name salary emp-number)
  (list name salary emp-number))
```

will have the behavior:

```
> (build-record '(Alan Turing) 50000.00 135772)
((Alan Turing) 50000.00 135772)
```

Now, using `build-record` and the access functions, we may construct functions that return a modified copy of a record. For example:

```
(defun replace-salary-field (record new-salary)
  (build-record (name-field record)
                new-salary
                (number-field record)))
```

will behave:

```
> (replace-salary-field '((Ada Lovelace) 45000.00 338519) 50000.00)
((Ada Lovelace) 50000.00 338519)
```

Note that this function does not actually update the record itself but produces a modified copy of the record. This updated version may be saved by binding it to a global variable using `setf` (Section 10.1.8). Although LISP provides forms that allow a particular element in a list to be modified in the original structure (i.e. without making a copy), good LISP programming style generally avoids their use, and they are not covered in this text. For LISP applications involving all but extremely large structures, modifications are generally done by creating a new copy of the structure.

In the above examples, we created an abstract data type for employee records. The various access and update functions defined in this section implement a specialized language appropriate to the meaning of the records, freeing the programmer from concerns about the actual list structures being used to implement the records. This

simplifies development of higher-level code, as well as making that code much easier to maintain and understand.

Generally, AI programs manipulate large amounts of varied knowledge about problem domains. The data structures used to represent this knowledge, such as objects and semantic networks, are complex, and humans generally find it easier to relate to this knowledge in terms of its meaning rather than the particular syntax of its internal representation. Therefore, data abstraction techniques, always good computer science, are essential tools for the AI programmer. Because of the ease with which LISP supports the definition of new functions, it is an ideal language for data abstraction.

10.1.6 Lists as Recursive Structures

In the previous section, we used `nth` and `list` to implement access functions for records in a simple "employee" database. Because all employee records were of a determinate length (three elements), these two functions were sufficient to access the fields of records. However, these functions are not adequate for performing operations on lists of unknown length, such as searching through an unspecified number of employee records. To do this, we must be able to scan a list iteratively or recursively, terminating when certain conditions are met (e.g., the desired record is found) or the list is exhausted. In this section we introduce list operations, along with the use of recursion to create list-processing functions.

The basic functions for accessing the components of lists are `car` and `cdr`. `car` takes a single argument, which must be a list, and returns the first element of that list. `cdr` also takes a single argument, which must be a list, and returns that list with its first argument removed. For example:

```
> (car '(a b c))                ; note that the list is quoted
a
> (cdr '(a b c))
(b c)
> (car '((a b) (c d)))          ; the first element of a list may be a list
(a b)
> (cdr '((a b) (c d)))
((c d))
> (car (cdr '(a b c d)))
b
```

The way in which `car` and `cdr` operate suggests a recursive approach to manipulating list structures:

To perform an operation on each of the elements of a list:

1. If the list is empty, quit.
2. Perform the operation on the first element of the list and recur on the remainder of the list.

Using this scheme, we can define a number of useful list-handling functions. For example, Common LISP includes the predicates `member`, which determines whether one s-expression is a member of a list, and `length`, which determines the length of a list. We may define our own versions of these functions. `my-member` takes two arguments, an arbitrary s-expression and a list. It returns `nil` if the s-expression is not a member of the list; otherwise it returns the portion of the list containing the s-expression as its first element:

```
(defun my-member (element list)
  (cond ((null list) nil) ; element not in list
        ((equal element (car list)) list) ; element found
        (t (my-member element (cdr list)))) ; recursive step
```

`my-member` has the behavior:

```
> (my-member 4 '(1 2 3 4 5 6))
(4 5 6)
> (my-member 5 '(a b c d))
nil
```

Similarly, we may define our own versions of `length` and `nth`:

```
(defun my-length (list)
  (cond ((null list) 0)
        (t (+ (my-length (cdr list)) 1))))

(defun my-nth (n list)
  (cond ((zerop n) (car list)) ; zerop tests if its argument is zero
        (t (my-nth (- n 1) (cdr list)))))
```

It is interesting to note that these examples, though presented here to illustrate the use of `car` and `cdr`, reflect the historical development of LISP. Early versions of the language did not include as many built-in functions as Common LISP does; programmers defined their own functions for checking list membership, length, etc. Over time, the most generally useful of these functions have been incorporated into the language standard. As an easily extensible language, Common LISP makes it easy for programmers to create and use their own library of reusable functions.

In addition to the functions `car` and `cdr`, LISP provides a number of functions for constructing lists. One of these, `list`, which takes as arguments any number of s-expressions, evaluates them, and returns a list of the results, was introduced in Section 10.1.1. A more primitive list constructor is the function `cons`, that takes two s-expressions as arguments, evaluates them, and returns a list whose `car` is the value of the first argument and whose `cdr` is the value of the second:

```
> (cons 1 '(2 3 4))
(1 2 3 4)
```

```
> (cons '(a b) '(c d e))
((a b) c d e)
```

`cons` bears an inverse relationship to `car` and `cdr` in that the `car` of the value returned by a `cons` form is always the first argument to the `cons`, and the `cdr` of the value returned by a `cons` form is always the second argument to that form:

```
> (car (cons 1 '(2 3 4)))
1
> (cdr (cons 1 '(2 3 4)))
(2 3 4)
```

An example of the use of `cons` is seen in the definition of the function `filter-negatives`, which takes a list of numbers as an argument and returns that list with any negative numbers removed. `filter-negatives` recursively examines each element of the list; if the first element is negative, it is discarded and the function returns the result of filtering the negative numbers from the `cdr` of the list. If the first element of the list is positive, it is “consed” onto the result of filtering negatives from the rest of the list:

```
(defun filter-negatives (number-list)
  (cond ((null number-list) nil) ; termination condition
        ((plusp (car number-list)) (cons (car number-list)
                                          (filter-negatives (cdr number-list))))
        (t (filter-negatives (cdr number-list)))))
```

This function behaves:

```
> (filter-negatives '(1 -1 2 -2 3 -4))
(1 2 3)
```

This example is typical of the way `cons` is often used in recursive functions on lists. `car` and `cdr` tear lists apart and “drive” the recursion; `cons` selectively constructs the result as the recursion “unwinds.” Another example of this use of `cons` is in redefining the built-in function `append`:

```
(defun my-append (list1 list2)
  (cond ((null list1) list2)
        (t (cons (car list1) (my-append (cdr list1) list2)))))
```

which yields the behavior:

```
> (my-append '(1 2 3) '(4 5 6))
(1 2 3 4 5 6)
```

Note that the same recursive scheme is used in the definitions of `my-append`, `my-length`, and `my-member`. Each definition uses the `cdr` function to remove an element from the list, allowing a recursive call on the shortened list; the recursion “bottoms out” on

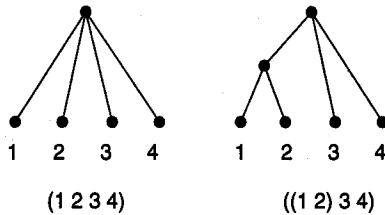

Figure 10.2 Mapping lists onto trees, showing structural differences.

the empty list. As the recursion unwinds, the `CONS` function reassembles the solution. This particular scheme is known as *cdr recursion*, because it uses the `cdr` function to linearly scan the elements of a list.

10.1.7 Nested Lists, Structure, and `car/cdr` Recursion

Although both `cons` and `append` may be used to combine smaller lists into a single list, it is important to note the difference between these two functions. If `cons` is called with two lists as arguments, it makes the first of these a new first element of the second list, whereas `append` returns a list whose elements are the elements of the two arguments:

```
> (cons '(1 2) '(3 4))
((1 2) 3 4)
> (append '(1 2) '(3 4))
(1 2 3 4)
```

The lists `(1 2 3 4)` and `((1 2) 3 4)` have fundamentally different structures. This difference may be noted graphically by exploiting the isomorphism between lists and trees. The simplest way to map lists onto trees is to create an unlabeled node for each list, with descendants equal to the elements of that list. This rule is applied recursively to the elements of the list that are themselves lists; elements that are atoms are mapped onto leaf nodes of the tree. Thus, the two lists mentioned above generate the different tree structures illustrated in Figure 10.2.

This example illustrates the representational power of lists, particularly as a means of representing any tree structure such as a search tree or a parse tree (Figure 10.1). In addition, nested lists provide a way of hierarchically structuring complex data. In the employee records example of Section 10.1.4, the name field was itself a list consisting of a first name and a last name. This list could be treated as a single entity or its individual components could be accessed.

The simple `cdr`-recursive scheme discussed in the previous section is not sufficient to implement all manipulations on nested lists, because it does not distinguish between items that are lists and those that are simple atoms. Suppose, for example, that the `length` function defined in Section 10.1.6 is applied to a nested list structure:

```
> (length '((1 2) 3 (1 (4 (5)))))
3
```

In the above example, `length` returns 3 because the list has 3 elements, (1 2), 3, and (1 (4 (5))). This is, of course, the correct and desired behavior for a length function.

On the other hand, if we want the function to count the number of *atoms* in the list, we need a different recursive scheme, one that, in addition to scanning along the elements of the list, “opens up” non-atomic list elements and recursively applies itself to the task of counting their atoms. This function, which will be called `count-atoms`, is defined:

```
(defun count-atoms (list)
  (cond ((null list) 0)
        ((atom list) 1)
        (t (+ (count-atoms (car list))           ; open up an element
              (count-atoms (cdr list))))))      ; scan down the list
```

which behaves:

```
> (count-atoms '((1 2) 3 (((4 5 (6)))))
6
```

The above definition is an example of `car-cdr` recursion. Instead of just recurring on the `cdr` of the list, `count-atoms` also recurs on the `car` of its argument, with the `+` function combining the two components into an answer. Recursion halts when it encounters an atom or empty list. One way of thinking of this scheme is that it adds a second dimension to simple `cdr` recursion, that of “going down into” each of the list elements. Compare the diagrams of calls to `length` and `count-atoms` in Figure 10.3. Note the similarity between the structure of `car-cdr` recursion and the recursive definition of s-expressions given in Section 10.1.1.

Another example of the use of `car-cdr` recursion is in the definition of the function `flatten`. `flatten` takes as argument a list of arbitrary structure and returns a list that consists of the same atoms in the same order but with all the atoms at the same level. Note the similarity between the definition of `flatten` and that of `count-atoms`: both use `car-cdr` recursion to tear apart lists and drive the recursion, both terminate when the argument is either null or atomic, and both use a second function (`append` or `+`) to construct an answer from the results of the recursive calls.

```
(defun flatten (lst)
  (cond ((null lst) nil)
        ((atom lst) (list lst))
        (t (append (flatten (car lst))(flatten (cdr lst))))))
```

Examples of the behavior of `flatten` include:

```
> (flatten '(a (b c) (((d) e f)))
(a b c d e f)
> (flatten '(a b c))
(a b c) ; this list is already flattened
```

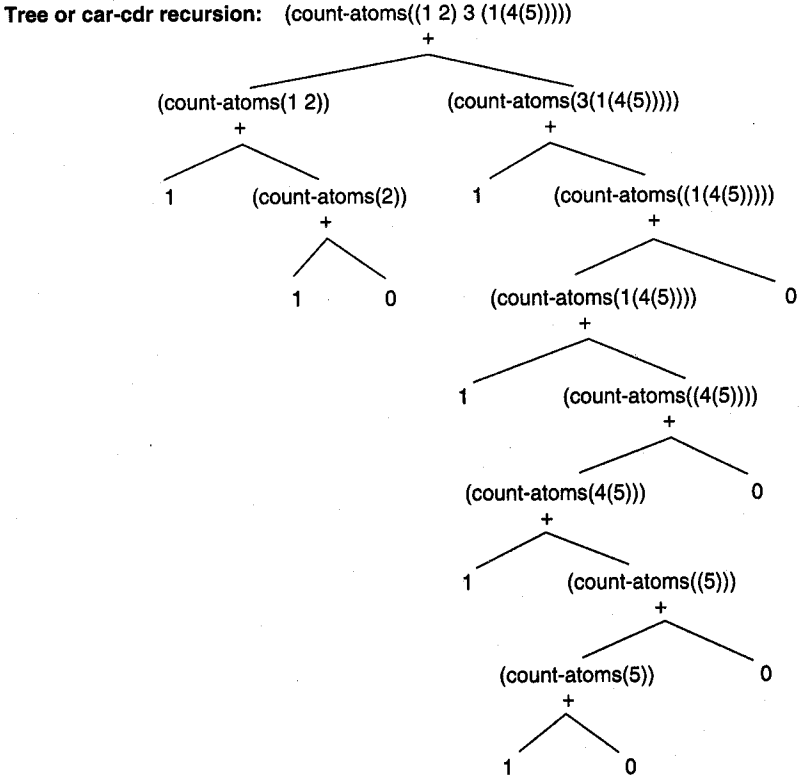
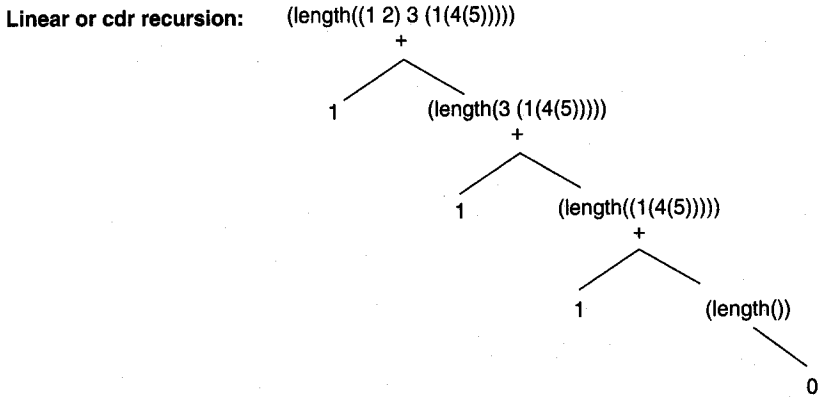

Figure 10.3 Diagrams of linear and tree recursive executions.

```

(a b c)
> (flatten '(1 (2 3) (4 (5 6) 7)))
(1 2 3 4 5 6 7)

```

car-cdr recursion is the basis of our implementation of unification in Section 10.6.

10.1.8 Binding Variables Using `set`

LISP is based on the theory of recursive functions; early LISP was the first example of a functional or *applicative* programming language. An important aspect of purely functional languages is the lack of any side effects as a result of function execution. This means that the value returned by a function call depends only on the function definition and the value of the parameters in the call. Although LISP is based on mathematical functions, it is possible to define LISP forms that violate this property. Consider the following LISP interaction:

```
> (f 4)
5
> (f 4)
6
> (f 4)
7
```

Note that `f` does not behave as a true function in that its output is not determined solely by its actual parameter: each time it is called with 4, it returns a different value. Execution of the function creates a side effect that influences the behavior of future calls. `f` is implemented using a LISP built-in function called `set`:

```
(defun f (x)
  (set 'inc (+ inc 1))
  (+ x inc))
```

`set` takes two arguments. The first must evaluate to a symbol; the second may be an arbitrary `s`-expression. `set` evaluates the second argument and binds this value to the symbol defined by the first argument. In the above example, if `inc` is first set to 0 (by the call `(set 'inc 0)`), each subsequent evaluation will increment its parameter by one more than the previous evaluation.

`set` requires that its first argument evaluate to a symbol. In many cases, the first argument is simply a quoted symbol. Because this is done so often, LISP provides an alternative form, `setq`, that does not evaluate its first argument. Instead, `setq` requires that the first argument be a symbol. For example, the following forms are equivalent:

```
> (set 'x 0)
0
> (setq x 0)
0
```

Although this use of `set` makes it possible to create LISP objects that are not pure functions in the mathematical sense, the ability to bind a value to a variable in the global environment is a useful feature. Many programming tasks are most naturally implemented using this ability to define objects whose state persists across function calls. The classic example of this is the “seed” in a random number generator: each call to the function

changes and saves the value of the seed. Similarly, it would be natural for a database program (such as was described in Section 10.1.3) to store the database by binding it to a variable in the global environment.

So far, we have seen two ways of binding a value to a symbol: explicitly, using `set` or `setq`, or implicitly, when a function call binds the calling parameters to the formal parameters in the definition. In the examples seen so far, all variables in a function body were either *bound* or *free*. A bound variable is one that appears as a formal parameter in the definition of the function, while a free variable is one that appears in the body of the function but is not a formal parameter. When a function is called, any bindings that a bound variable may have in the global environment are saved and the variable is rebound to the calling parameter. After the function has completed execution, the original bindings are restored. Thus, setting the value of a bound variable inside a function body has no effect on the global bindings of that variable, as illustrated by the following LISP interaction:

```
> (defun foo (x)
    (setq x (+ x 1))          ; increment bound variable x
  x)                          ; return its value
foo
> (setq y 1)
1
> (foo y)
2
> y                            ; note that value of y is unchanged
1
```

In the example that began this section, `x` was bound in the function `f`, whereas `inc` was free in that function. As we demonstrated in the example, free variables in a function definition are the primary source of side effects in functions.

An interesting alternative to `set` and `setq` is the generalized assignment function, `setf`. Instead of binding a value to a symbol, `setf` evaluates its first argument to obtain a memory location and places the value of the second argument in that location. When binding a value to a symbol, `setf` behaves like `setq`:

```
> (setq x 0)
0
> (setf x 0)
0
```

However, because we may call `setf` with any form that corresponds to a memory location, it allows a more general semantics. For example, if we make the first argument to `setf` a call to the `car` function, `setf` will replace the first element of that list. If the first argument to `setf` is a call to the `cdr` function, `setf` will replace the tail of that list. For example:

```
> (setf x '(a b c))          ; x is bound to a list
(a b c)
```



```

> x                                     ; the value of x is a list
(a b c)
> (setf (car x) 1)                       ; the car of x corresponds to a location in memory
1
> x                                     ; note that setf changed the value of the car of x
(1 b c)
> (setf (cdr x) '(2 3))
(2 3)
> x                                     ; note that x now has a new tail
(1 2 3)

```

We may call **setf** with most LISP forms that correspond to a memory location; these include symbols and functions such as **car**, **cdr**, and **nth**. Thus, **setf** allows us great flexibility in creating, manipulating, and even replacing components of LISP data structures.

10.1.9 Defining Local Variables Using **let**

let is another useful function for explicitly controlling the binding of variables. **let** allows the creation of local variables. As an example of the use of **let**, consider a function to compute the roots of a quadratic equation. This function takes as arguments the three parameters (a, b, and c) of the equation

$$ax^2 + bx + c = 0$$

and returns a list of the two roots of the equation. For example:

```

> (quad-roots 1 2 1)
(-1.0 -1.0)
> (quad-roots 1 6 8)
(-2.0 -4.0)

```

These roots would be calculated from the formula

$$x = \frac{-b \pm \sqrt{b^2 - 4ac}}{2a}$$

In computing the two roots, the value of

$$\sqrt{b^2 - 4ac}$$

is used twice. For reasons of efficiency, as well as elegance, we should compute this value only once, saving it in a variable for use in computing the two roots. Based on this idea, an initial implementation of **quad-roots** might be:

```
(defun quad-roots-1 (a b c)
```

```
(setq temp (sqrt (- (* b b) (* 4 a c))))
(list (/ (+ (- b) temp) (* 2 a))
      (/ (- (- b) temp) (* 2 a))))
```

Note that the above implementation assumes that the equation does not have imaginary roots, as attempting to take the square root of a negative number would cause the `sqrt` function to halt with an error condition. Modifying the code to handle this case is straightforward and not relevant to this discussion.

Although, with this exception, the code is correct, evaluation of the function body will have the side effect of setting the value of `temp` in the global environment:

```
> (quad-roots-1 1 2 1)
(-1.0 -1.0)
> temp
0.0
```

It is much more desirable to make `temp` local to the function `quad-roots`, thereby eliminating this side effect. This can be done through the use of a `let` block. A `let` expression has the syntax:

```
(let (<local-variables> <expressions>)
```

where the elements of `<local-variables>` are either symbolic atoms or pairs of the form:

```
(<symbol> <expression>)
```

When a `let` form (or block as it is usually called) is evaluated, it establishes a local environment consisting of all of the symbols in `<local-variables>`. If a symbol is the first element of a pair, the second element is evaluated and the symbol is bound to this result; symbols that are not included in pairs are bound to `nil`. If any of these symbols are already bound in the global environment, these global bindings are saved and restored when the `let` block terminates.

After these local bindings are established, the `<expressions>` are evaluated in order within this environment. When the `let` statement terminates, it returns the value of the last expression evaluated within the block.

The behavior of the `let` block is illustrated by the following example:

```
> (setq a 0)
0
> (let ((a 3) b)
      (setq b 4)
      (+ a b))
7
> a
0
> b
```

ERROR - b is not bound at top level.

In this example, before the `let` block is executed, `a` is bound to 0 and `b` is unbound at the top-level environment. When the `let` is evaluated, `a` is bound to 3 and `b` is bound to nil. The `setq` binds `b` to 4, and the sum of `a` and `b` is returned by the `let` statement. Upon termination of the `let`, `a` and `b` are restored to their previous values, including the unbound status of `b`.

Using the `let` statement, `quad-roots` can be implemented with no global side effects:

```
(defun quad-roots-2 (a b c)
  (let (temp)
    (setq temp (sqrt (- (* b b) (* 4 a c))))
    (list (/ (+ (- b) temp) (* 2 a))
          (/ (- (- b) temp) (* 2 a)))))
```

Alternatively, `temp` may be bound when it is declared in the `let` statement, giving a somewhat more concise implementation of `quad-roots`. In this final version, the denominator of the formula, `2a`, is also computed once and saved in a local variable, `denom`:

```
(defun quad-roots-3 (a b c)
  (let ((temp (sqrt (- (* b b) (* 4 a c))))
        (denom (* 2 a)))
    (list (/ (+ (- b) temp) denom)
          (/ (- (- b) temp) denom))))
```

In addition to avoiding side effects, `quad-roots-3` is the most efficient of the three versions, because it does not recompute values unnecessarily.

10.1.10 Data Types in Common LISP

LISP provides the user with a number of built-in data types. These include integers, floating-point numbers, strings, and characters. LISP also includes such structured types as arrays, hash tables, sets, and structures. All of these types include the appropriate operations on the type and predicates for testing whether an object is an instance of the type. For example, lists are supported by such functions as `listp`, which identifies an object as a list; `null`, which identifies the empty list, and constructors and accessors such as `list`, `nth`, `car`, and `cdr`.

However, unlike such strongly typed languages as C or Pascal, it is the data objects that are typed, rather than variables. Any LISP symbol may bind to any object. This provides the programmer with the power of strong typing but also with a great deal of flexibility in manipulating objects of different or even unknown types. For example, because we may bind any object to any variable at run time; this means that we may define data structures such as frames and not specify the type of the values stored in them.

To support this flexibility, LISP implements run-time type checking. Although we may bind any value to a symbol, if we attempt to use the value in an erroneous fashion, the LISP interpreter will detect an error. For example:

```
> (setq x 'a)
a
> (+ x 2)
>> Error: a is not a valid argument to +.
>> While executing: +
```

Users may implement their own type checking using either built-in or user-defined type predicates. This allows programmers to detect type errors and manage them as they see fit.

10.1.11 Conclusion

The preceding pages are not a complete description of LISP. Instead, they are intended to call the reader's attention to interesting features of the language that will be of use in implementing AI data structures and algorithms. These features include:

1. The naturalness with which LISP supports a data abstraction approach to programming.
2. The use of lists to create symbolic data structures.
3. The use of `cond` and recursion to control program flow.
4. The recursive nature of list structures and the recursive schemes involved in their manipulation.
5. The use of `quote` and `eval` to control function evaluation.
6. The use of `set` and `let` to control variable bindings and side effects.

The remainder of this chapter builds on these ideas to demonstrate the use of LISP for typical AI programming tasks such as pattern matchers and search algorithms.

10.2 Search in LISP: A Functional Approach to the Farmer, Wolf, Goat, and Cabbage Problem

As an introduction to AI programming in LISP, we solve the farmer, wolf, goat, and cabbage problem:

A farmer with his wolf, goat, and cabbage come to the edge of a river they wish to cross. There is a boat at the river's edge, but, of course, only the farmer can row it. The boat also can carry

only two things (including the rower) at a time. If the wolf is ever left alone with the goat, the wolf will eat the goat; similarly, if the goat is left alone with the cabbage, the goat will eat the cabbage. Devise a sequence of crossings of the river so that all four characters arrive safely on the other side of the river.

This problem was first presented and solved in PROLOG in Chapter 9. The LISP version searches the same space and has structural similarities to the PROLOG solution; however, it differs in ways that reflect LISP's procedural orientation. The LISP solution searches the state space in a depth-first fashion using a list of visited states to avoid loops.

The heart of the program is a set of functions that define states of the world as an abstract data type. These functions hide the internals of state representation from higher-level components of the program. Internally, states are represented as lists of four elements, where each element denotes the location of the farmer, wolf, goat, or cabbage, respectively. Thus, (e w e w) represents the problem state in which the farmer (the first element) and the goat (the third element) are on the east bank and the wolf and cabbage are on the west bank. The basic functions defining the state data type will be a constructor, **make-state**, which takes as arguments the locations of the farmer, wolf, goat, and cabbage and returns a state, and four access functions, **farmer-side**, **wolf-side**, **goat-side**, and **cabbage-side**, which take a state and return the location of an individual. These functions are defined:

```
(defun make-state (f w g c) (list f w g c))
(defun farmer-side (state)
  (nth 0 state))
(defun wolf-side (state)
  (nth 1 state))
(defun goat-side (state)
  (nth 2 state))
(defun cabbage-side (state)
  (nth 3 state))
```

The rest of the program is built on these state access and construction functions. In particular, they are used to implement the four possible actions the farmer may take: rowing across the river alone or with either the wolf, goat, or cabbage.

Each move uses the access functions to tear a state apart into its components. A function called **opposite** (to be defined shortly) determines the new location of the individuals that cross the river, and **make-state** reassembles these into the new state. For example, the function **farmer-takes-self** may be defined:

```
(defun farmer-takes-self (state)
  (make-state (opposite (farmer-side state))
              (wolf-side state)
              (goat-side state)
              (cabbage-side state)))
```

Note that this function returns the new state, regardless of whether it is safe or not. A state is unsafe if the farmer has left the goat alone with the cabbage or left the wolf alone with the goat. The program must find a solution path that does not contain any unsafe states. Although this “safe” check may be done at a number of different stages of the program, our approach is to perform it in the move functions. This is implemented by using a function called `safe`, which we also define shortly. `safe` has the following behavior:

```
> (safe '(w w w w))           ; safe state, return unchanged.
(w w w w)
> (safe '(e w w e))           ; wolf eats goat, return nil.
nil
> (safe '(w w e e))           ; goat eats cabbage, return nil.
nil
```

`safe` is used in each move function to filter out the unsafe states. Thus, any move that moves to an unsafe state will return `nil` instead of that state. The recursive path algorithm can check for this `nil` and use it to prune that state. In a sense, we are using `safe` to implement a production system style condition-check prior to determining if a move rule can be applied. Using `safe`, a final definition of `farmer-takes-self` is:

```
(defun farmer-takes-self (state)
  (safe (make-state (opposite (farmer-side state))
                  (wolf-side state)
                  (goat-side state)
                  (cabbage-side state))))
```

The remaining move functions are defined similarly but include a conditional test to determine whether the farmer and the prospective passenger are on the same side of the river. If a move cannot be made because the farmer and the passenger are not on the same bank, these functions return `nil`:

```
(defun farmer-takes-wolf (state)
  (cond ((equal (farmer-side state) (wolf-side state))
        (safe (make-state (opposite (farmer-side state))
                          (opposite (wolf-side state))
                          (goat-side state)
                          (cabbage-side state))))
        (t nil)))
```

```
(defun farmer-takes-goat (state)
  (cond ((equal (farmer-side state) (goat-side state))
        (safe (make-state (opposite (farmer-side state))
                          (wolf-side state)
                          (opposite (goat-side state))
                          (cabbage-side state))))
        (t nil)))
```

```
(defun farmer-takes-cabbage (state)
  (cond ((equal (farmer-side state) (cabbage-side state))
        (safe (make-state (opposite (farmer-side state))
                          (wolf-side state)
                          (goat-side state)
                          (opposite (cabbage-side state))))))
        (t nil)))
```

These definitions use the state manipulation functions from above and a function `opposite`, which returns the opposite of a given side:

```
(defun opposite (side)
  (cond ((equal side 'e) 'w)
        ((equal side 'w) 'e)))
```

It is worth noting the use of the predicate `equal` in the previous definitions. LISP provides a number of different predicates for testing equality. The most stringent, `eq`, is true only if its arguments evaluate to the same object, which means they point to the same memory location. `equal` is less strict: it requires that its arguments be syntactically identical. The following transcript illustrates the difference between these two different definitions of equality:

```
> (setq l1 '(1 2 3))
(1 2 3)
> (setq l2 '(1 2 3))
(1 2 3)
> (equal l1 l2)
t
> (eq l1 l2)
nil
> (setq l3 l1)
(1 2 3)
> (eq l1 l3)
t
```

We define `safe` using a `cond` to check for the two unsafe conditions: (1) the farmer on the opposite bank from the wolf and the goat and (2) the farmer on the opposite bank from the goat and the cabbage. If the state is `safe`, it is returned unchanged; otherwise, `safe` returns `nil`:

```
(defun safe (state)
  (cond ((and (equal (goat-side state) (wolf-side state)) ; wolf eats goat
             (not (equal (farmer-side state) (wolf-side state)))) nil)
        ((and (equal (goat-side state) (cabbage-side state)) ; goat eats cabbage
             (not (equal (farmer-side state) (goat-side state)))) nil)
        (t state)))
```

`path` implements the backtracking search of the state space. It takes as arguments a state and a goal and first checks to see whether they are equal, indicating a successful termination of the search. If they are not equal, `path` generates all four of the neighboring states in the state space graph, calling itself recursively on each of these neighboring states in turn to try to find a path from them to a goal. Translating this simple definition directly into LISP yields:

```
(defun path (state goal)
  (cond ((equal state goal) 'success)
        (t (or (path (farmer-takes-self state) goal)
                (path (farmer-takes-wolf state) goal)
                (path (farmer-takes-goat state) goal)
                (path (farmer-takes-cabbage state) goal))))))
```

This version of the `path` function is a simple translation of the recursive path algorithm from English into LISP and has several “bugs” that need to be corrected. It does, however, capture the essential structure of the algorithm and should be examined before continuing on to correct the bugs. The first test in the `COND` statement is necessary for a successful completion of the search algorithm. When the `equal state goal` pattern matches, the recursion stops and the atom `success` is returned. Otherwise, `path` generates the four descendant nodes of the search graph and then calls itself on each of the nodes in turn.

In particular, note the use of the `OR` form to control evaluation of its arguments. Recall that an `OR` evaluates its arguments in turn until one of them returns a non-`nil` value. When this occurs, the `OR` terminates without evaluating the other arguments and returns this non-`nil` value as a result. Thus, the `OR` not only is used as a logical operator but also provides a way of controlling branching within the space to be searched. The `OR` form is used here instead of a `COND` because the value that is being tested and the value that should be returned if the test is non-`nil` are the same.

One problem with this definition is that a move function may return a value of `nil` if the move may not be made or if it leads to an unsafe state. To prevent `path` from attempting to generate the children of a `nil` state, it must first check whether the current state is `nil`. If it is, `path` should return `nil`.

The other issue that needs to be addressed in the implementation of `path` is that of detecting potential loops in the search space. If the above implementation of `path` is run, the farmer will soon find himself going back and forth alone between the two banks of the river; that is, the algorithm will be stuck in an infinite loop between identical states, both of which it has already visited. To prevent this from happening, `path` is given a third parameter, `been-list`, a list of all the states that have already been visited. Each time that `path` is called recursively on a new state of the world, the parent state will be added to `been-list`. `path` uses the `member` predicate to make sure the current state is not a member of `been-list`, i.e., that it has not already been visited. This is accomplished by checking the current state for membership in `been-list` before generating its descendants. `path` is now defined:

```

(defun path (state goal been-list)
  (cond ((null state) nil)
        ((equal state goal) (reverse (cons state been-list)))
        ((not (member state been-list :test #'equal))
         (or (path (farmer-takes-self state) goal (cons state been-list))
              (path (farmer-takes-wolf state) goal (cons state been-list))
              (path (farmer-takes-goat state) goal (cons state been-list))
              (path (farmer-takes-goat state) goal (cons state been-list)))))

```

In the above implementation, `member` is a Common LISP built-in function that behaves in essentially the same way as the `my-member` function defined in this chapter. The only difference is the inclusion of `:test #'equal` in the argument list. Unlike our “home-grown” `member` function, the Common LISP built-in form allows the programmer to specify the function that is used in testing for membership. This wrinkle increases the flexibility of the function and should not cause too much concern in this discussion.

Rather than having the function return just the atom `success`, it is better to have it return the actual solution path. Because the series of states on the solution path is already contained in the `been-list`, this list is returned instead. Because the goal is not already on `been-list`, it is `consed` onto the list. Also, because the list is constructed in reverse order (with the start state as the last element), the list is reversed (constructed in reverse order using another LISP built-in function, `reverse`) prior to being returned.

Finally, because the `been-list` parameter should be kept “hidden” from the user, a top-level calling function may be written that takes as arguments a start and a goal state and calls `path` with a nil value of `been-list`:

```

(defun solve-fwgc (state goal) (path state goal nil))

```

Let us compare the LISP version of the farmer, wolf, goat, and cabbage problem with the PROLOG solution presented in Chapter 9. Not only does the LISP program solve the same problem, but it also searches exactly the same state space as the PROLOG version. This underscores the point that the state space conceptualization of a problem is independent of the implementation of a program for searching that space. Because both programs search the same space, the two implementations have strong similarities; the differences tend to be subtle but provide an interesting contrast between declarative and procedural programming styles.

States in the PROLOG version are represented using a predicate, `state(e,e,e,e)`, and the LISP implementation uses a list. These two representations are more than syntactic variations on one another. The LISP representation of state is defined not only by its list syntax but also by the `access` and `move` functions that constitute the abstract data type “state.” In the PROLOG version, states are patterns; their meaning is determined by the way in which they match other patterns in PROLOG rules, which indeed, could also be lists.

The LISP version of `path` is slightly longer than the PROLOG version. One reason for this is that the LISP version must implement a search strategy, whereas the PROLOG

version takes advantage of PROLOG's built-in search algorithm. The control algorithm is explicit in the LISP version but is implicit in the PROLOG version. Because PROLOG is built on declarative representation and theorem-proving techniques, the PROLOG program is more concise and has a flavor of describing the problem domain, without directly implementing the search algorithm. The price paid for this conciseness is that much of the program's behavior is hidden, determined by PROLOG's built-in inference strategies. Programmers may also feel more pressure to make the problem solution conform to PROLOG's representational formalism and search strategies. LISP, on the other hand, allows greater flexibility for the programmer. The price paid here is that the programmer cannot draw on a built-in representation or search strategy and must implement this explicitly in the algorithm.

10.3 Higher-Order Functions & Procedural Abstraction

One of the most powerful techniques that LISP and other functional programming languages provide is the ability to define functions that take other functions as parameters or return them as results. These are called *higher-order functions* and constitute an important tool for procedural abstraction.

10.3.1 Maps and Filters

A *filter* is a function that applies a test to the elements of a list, eliminating those that fail the test. *filter-negatives*, presented earlier in this chapter, was an example of a filter. *Maps* take a list of data objects and apply a function to each one, returning a list of the results. This idea may be further generalized through the development of general maps and filters that take as arguments both lists and the functions or tests that are to be applied to their elements.

To begin with an example, recall the function *filter-negatives* from Section 10.1.6. This function took as its argument a list of numbers and returned that list with all negative values deleted. Similarly, a function to filter out all the even numbers in a list may be defined:

```
(defun filter-evens (number-list) ; termination condition
  (cond ((null number-list) nil)
        ((oddp (car number-list))
         (cons (car number-list) (filter-evens (cdr number-list))))
        (t (filter-evens (cdr number-list)))))
```

Because these two functions differ *only* in the name of the predicate used to filter elements from the list, it is natural to think of generalizing them into a single function that takes the filtering predicate as a second parameter.

This may be defined using a LISP form called `funcall`, which takes as arguments a function and a series of arguments and applies that function to those arguments:

```
(defun filter (list-of-elements test)
  (cond ((null list-of-elements) nil)
        ((funcall test (car list-of-elements))
         (cons (car list-of-elements) (filter (cdr list-of-elements) test)))
        (t (filter (cdr list-of-elements) test))))
```

The function, `filter`, applies the `test` to the first element of the list. If the `test` returns non-nil, it `conses` the element onto the result of filtering the `cdr` of the list; otherwise, it just returns the filtered `cdr`. This function may be used with different predicates passed in as parameters to perform a variety of filtering tasks:

```
> (filter '(1 3 -9 5 -2 -7 6) #'plusp)           ; Filter out all negative numbers
(1 3 5 6)
> (filter '(1 2 3 4 5 6 7 8 9) #'evenp)         ; Filter out all odd numbers
(2 4 6 8)
> (filter '(1 a b 3 c 4 7 d) #'numberp)       ; Filter out all non-numbers
(1 3 4 7)
```

When a function is passed as a parameter, as in the above examples, it should be preceded by a `#'` instead of just `'`. The purpose of this convention is to flag arguments that are functions so that they may be given appropriate treatment by the LISP interpreter. In particular, when a function is passed as an argument in Common LISP, the bindings of its free variables (if any) must be retained. This combination of function definition and bindings of free variables is called a *lexical closure*; the `#'` informs LISP that the lexical closure must be constructed and passed with the function.

More formally, `funcall` is defined as having the syntax:

```
(funcall <function> <arg1> <arg2> ... <argn>)
```

In this definition, `<function>` is a LISP function and `<arg1> ... <argn>` are zero or more arguments to the function. The result of evaluating a `funcall` is the same as the result of evaluating `<function>` with the specified arguments as actual parameters.

`apply` is a similar function that performs the same task as `funcall` but requires that its arguments be in a list. Except for this syntactic difference, `apply` and `funcall` behave the same; the programmer can choose the function that seems more convenient for a given application. These two functions are similar to `eval` in that all three of them allow the user to specify that function evaluation should take place. The difference is that `eval` requires its argument to be an s-expression that is evaluated, while `funcall` and `apply` take a function and its arguments as separate parameters. Examples of the behavior of these functions are:

```
> (funcall #'plus 2 3)
5
```

```

> (apply #'plus '(2 3))
5
> (eval '(plus 2 3))
5
> (funcall #'car '(a b c))
a
> (apply #'car '((a b c)))
a

```

Another important class of higher-order functions consists of mapping functions, functions that will apply a given function to all the elements of a list. Using `funcall`, we define the simple mapping function `map-simple`, which returns a list of the results of applying a functional argument to all the elements of a list:

```

(defun map-simple (func list)
  (cond ((null list) nil)
        (t (cons (funcall func (car list))
                  (map-simple func (cdr list))))))

```

For example, `map-simple` has the behavior:

```

> (map-simple #'1+ '(1 2 3 4 5 6))
(2 3 4 5 6 7)
> (map-simple #'listp '(1 2 (3 4) 5 (6 7 8)))
(nil nil t nil t)

```

`map-simple` is actually a simplified version of a LISP built-in function called `mapcar`, that allows more than one argument list. This enables functions of more than one argument to be applied to corresponding elements of several lists:

```

> (mapcar #'1+ '(1 2 3 4 5 6))           ; this is the same as map-simple
(2 3 4 5 6 7)

> (mapcar #'+ '(1 2 3 4) '(5 6 7 8))
(6 8 10 12)

> (mapcar #'max '(3 9 1 7) '(2 5 6 8))
(3 9 6 8)

```

`mapcar` is only one of many mapping functions provided by LISP, as well as only one of many higher-order functions built into the language.

10.3.2 Functional Arguments and Lambda Expressions

In the preceding examples, function arguments were passed by their name and applied to a series of arguments. This requires that the functions be previously defined in the global

environment. Frequently, however, it is desirable to pass a function definition directly, without first defining the function globally. This is made possible through the `lambda` expression.

Essentially, the `lambda` expression allows us to separate a function definition from the function name. The origin of `lambda` expressions is in the *lambda calculus*, a mathematical model of computation that provides (among other things) a particularly thoughtful treatment of this distinction between an object and its name. The syntax of a `lambda` expression is similar to the function definition in a `defun`, except that the function name is replaced by the term `lambda`. That is:

```
(lambda (<formal-parameters>) <body>)
```

`Lambda` expressions may be used in place of a function name in a `funcall` or `apply`. The `funcall` will execute the body of the `lambda` expression with the arguments bound to the parameters of the `funcall`. As with named functions, the number of formal parameters and the number of actual parameters must be the same. For example:

```
> (funcall #'(lambda (x) (* x x)) 4)
16
```

Here, `x` is bound to `4` and the body of the `lambda` expression is then evaluated. The result, the square of `4`, is returned by `funcall`. Other examples of the use of `lambda` expressions with `funcall` and `apply` are:

```
> (apply #'(lambda (x y) (+ (* x x) y)) '(2 3))
7
> (funcall #'(lambda (x) (append x x)) '(a b c))
(a b c a b c)
> (funcall #'(lambda (x1 x2) (append (reverse x1) x2)) '(a b c) '(d e f))
(c b a d e f)
```

`Lambda` expressions may be used in a higher-order function such as `mapcar` in place of the names of globally defined functions. For example:

```
> (mapcar #'(lambda (x) (* x x)) '(1 2 3 4 5))
(1 4 9 16 25)
> (mapcar #'(lambda (x) (* x 2)) '(1 2 3 4 5))
(2 4 6 8 10)
> (mapcar #'(lambda (x) (and (> x 0) (< x 10))) '(1 24 5 -9 8 23))
(t nil t nil t nil)
```

Without `lambda` expressions the programmer must define every function in the global environment using a `defun`, even though that function may be used only once. `Lambda` expressions free the programmer from this necessity: if it is desired to square each element in a list, the `lambda` form is passed to `mapcar` as the first of the above examples illustrates. It is not necessary to define a squaring function first.

10.4 Search Strategies in LISP

The use of higher-order functions provides LISP with a powerful tool for procedural abstraction. In this section, we use this abstraction technique to implement general algorithms for breadth-first, depth-first, and best-first search. These algorithms implement the search algorithms from Chapters 3 and 4, using `open` and `closed` lists to manage search through the state space. The moves for a given problem are a parameter to the search algorithm; the algorithms apply moves to states using `funcall`.

10.4.1 Breadth-First and Depth-First Search

The LISP implementation of breadth-first search maintains the `open` list as a first-in-first-out (FIFO) structure. We define `open` and `closed` as global variables. This is done for reasons of efficiency, avoiding the overhead of passing large lists as parameters to each call to breadth-first search. Though this approach digresses from the purely functional style, efficiency often dictates such strategies. In this situation, because `open` and `closed` may be large and are of global importance to the algorithm, their use as global variables seems justified. In addition, since the code is using global variables, we will make the goal global. By convention, global variables in Common LISP are written to begin and end with `*`.

Breadth-first search is defined:

```
(defun breadth-first ( )
  (cond ((null *open*) nil)
        (t (let ((state (car *open*)))
              (cond ((equal state *goal*) 'success)
                    (t (setq *closed* (cons state *closed*))
                       (setq *open* (append (cdr *open*)
                                             (generate-descendants state *moves*)))
                          (breadth-first)))))))

(defun run-breadth (start goal)
  (setq *open* (list start))
  (setq *closed* nil)
  (setq *goal* goal)
  (breadth-first))
```

In this implementation, the `*open*` list is tested: if it is `nil`, the algorithm returns `nil`, indicating failure; otherwise it examines the first element of `*open*`. If this is equal to the goal, the algorithm halts and returns `success`; otherwise, it calls `generate-descendants` to produce the children of the current state, adds them to the `*open*` list, and recurs. `run-breadth` is an initialization function that sets the initial values of `*open*`, `*closed*`, and `*goal*`. `generate-descendants` is passed both the state and `*moves*` as parameters. `*moves*` is a list of the functions that generate moves. In the farmer, wolf, goat, and

cabbage problem, assuming the move definitions of Section 10.2, `*moves*` would be defined by:

```
(setq *moves*
      '(farmer-takes-self farmer-takes-wolf farmer-takes-goat farmer-takes-cabbage))
```

`generate-descendants` takes a state and returns a list of its children. In addition to generating child states, it disallows duplicates in the list of children and eliminates any children that are already in the open or closed list. In addition to the state, `generate-descendants` is given a list of moves; these may be the names of defined functions, or they may be lambda definitions. `generate-descendants` uses a `let` block to save the result of a move in the local variable `child`. We define `generate-descendants`:

```
(defun generate-descendants (state moves)
  (cond ((null moves) nil)
        (t (let ((child (funcall (car moves) state))
                  (rest (generate-descendants state (cdr moves))))
              (cond ((null child) rest)
                    ((member child rest :test #'equal) rest)
                    ((member child *open* :test #'equal) rest)
                    ((member child *closed* :test #'equal) rest)
                    (t (cons child rest)))))))
```

The calls to the `member` function use an additional parameter: `:test #'equal`. The `member` function allows the user to specify any test for membership. This allows us to use predicates of arbitrary complexity and semantics to test membership. Though LISP does not require that we specify the test, the default comparison is the predicate `eq`. `eq` requires that two objects be identical, which means they have the same location in memory; we are using a weaker comparison, `equal`, that only requires that the objects have the same value.

By binding the global variable `*moves*` to an appropriate set of move functions, the search algorithm just presented may be used to search any state space graph in a breadth-first fashion.

One difficulty that remains with this implementation is its inability to print the list of states along the path from a start to a goal. Although all the states that lead to the goal are present in the closed list when the algorithm halts, these are mixed with all other states from earlier levels of the search space. We can solve this problem by recording both the state and its parent, and reconstructing the solution path from this information. For example, if the state `(e e e e)` generates the state `(w e w e)`, a record of both states, `((w e w e) (e e e e))`, is placed on `*open*`. Later, after the children of the state have been generated, the same `(<state> <parent>)` pair is placed on `*closed*`.

When the current state is found to equal the goal, this ancestor information can be used to reconstruct the path from the goal back to the start state by tracing back along successive parents. This augmented version of breadth-first search begins by defining state records as an abstract data type:

```

(defun build-record (state parent) (list state parent))
(defun get-state (state-tuple) (nth 0 state-tuple))
(defun get-parent (state-tuple) (nth 1 state-tuple))
(defun retrieve-by-state (state list)
  (cond ((null list) nil)
        ((equal state (get-state (car list))) (car list))
        (t (retrieve-by-state state (cdr list)))))

```

build-record constructs a (<state> <parent>) pair. get-state and get-parent access the appropriate fields of a record. retrieve-by-state takes a state and a list of state records and returns the record whose state field matches that state.

build-solution uses retrieve-by-state to chain back from state to parent, constructing a list of successive states that led to a goal. When initializing *open*, we will give the starting state a parent of nil; build-solution stops when passed a null state.

```

(defun build-solution (state)
  (cond ((null state) nil)
        (t (cons state (build-solution (get-parent (retrieve-by-state state *closed*)))))

```

The remainder of the algorithm is a straightforward modification of the simple breadth-first search algorithm:

```

(defun run-breadth (start goal)
  (setq *open* (list (build-record start nil)))
  (setq *closed* nil)
  (setq *goal* goal)
  (breadth-first))

(defun breadth-first ( )
  (cond ((null *open*) nil)
        (t (let ((state (car *open*)))
              (setq *closed* (cons state *closed*))
              (cond ((equal (get-state state) *goal*) (build-solution *goal*))
                    (t (setq *open*
                              (append (cdr *open*
                                        (generate-descendants (get-state state) *moves*)))
                                      (breadth-first)))))))

(defun generate-descendants (state moves)
  (cond ((null moves) nil)
        (t (let ((child (funcall (car moves) state))
                  (rest (generate-descendants state (cdr moves))))
              (cond ((null child) rest)
                    ((retrieve-by-state child rest) rest)
                    ((retrieve-by-state child *open*) rest)
                    ((retrieve-by-state child *closed*) rest)
                    (t (cons (build-record child state) rest)))))))

```

Depth-first search may be implemented by modifying breadth-first search to maintain open as a stack. This simply involves reversing the order of the arguments to append and is left to the reader.

10.4.2 Best-First Search

Best-first search may be implemented through straightforward modifications to the breadth-first search algorithm. Specifically, the heuristic evaluation is saved along with each state. The tuples on *open* are then sorted according to this evaluation. The data type definitions for state records are a simple extension of those used in breadth-first search:

```
(defun build-record (state parent depth weight)
  (list state parent depth weight))

(defun get-state (state-tuple) (nth 0 state-tuple))

(defun get-parent (state-tuple) (nth 1 state-tuple))

(defun get-depth (state-tuple) (nth 2 state-tuple))

(defun get-weight (state-tuple) (nth 3 state-tuple))

(defun retrieve-by-state (state list)
  (con ((null list) nil)
    ((equal state (get-state (car list))) (car list))
    (t (retrieve-by-state state (cdr list)))))
```

best-first and generate-descendants are defined:

```
(defun best-first ( )
  (cond ((null *open*) nil)
    (t (let ((state (car *open*)))
      (setq *closed* (cons state *closed*))
      (cond ((equal (get-state state) *goal*) (build-solution *goal*))
        (t (setq *open*
          (insert-by-weight
            (generate-descendants (get-state state)
              (1 + (get-depth state)) *moves*) (cdr *open*)))
          (best-first)))))))

(defun generate-descendants (state depth moves)
  (cond ((null moves) nil)
    (t (let ((child (funcall (car moves) state))
      (rest (generate-descendants state depth (cdr moves))))
      (cond ((null child) rest)
        ((retrieve-by-state child rest) rest)
        ((retrieve-by-state child *open*) rest)
        ((retrieve-by-state child *closed*) rest)
        (t (cons (build-record child state depth (+ depth (heuristic child))) rest)))))))
```

The only differences between *best-first* and *breadth-first* search are the use of *insert-by-weight* to sort the records on **open** by heuristic weights and the computation of search depth and heuristic weights in *generate-descendants*.

Completion of *best-first* requires a definition of *insert-by-weight*. This function takes an unsorted list of state records and inserts them, one at a time, into their appropriate positions in **open**. It also requires a problem-specific definition of *heuristic*. This function takes a state and, using the global **goal**, computes a heuristic weight for that state. We leave the definition of these functions as an exercise for the reader.

10.5 Pattern Matching in LISP

Pattern matching is an important AI methodology that has already been discussed in the PROLOG chapters and the discussion of production systems. In this section we implement a recursive pattern matcher and use it to build a pattern-directed retrieval function for a simple database.

The heart of this retrieval system is a function called *match*, which takes as arguments two s-expressions and returns *t* if the expressions match. Matching requires that both expressions have the same *structure*, as well as having identical atoms in corresponding positions. In addition, *match* allows the inclusion of variables, denoted by *?*, in an s-expression. Variables are allowed to match with any s-expression, either a list or an atom, but do not save bindings, as with full unification. Examples of the desired behavior for *match* appear below. If the examples seem reminiscent of the PROLOG examples in Chapter 9, this is because *match* is actually a simplified version of the unification algorithm that forms the heart of PROLOG, as well as many other pattern-directed AI systems. In Section 10.6 we expand *match* into the full unification algorithm by allowing named variables and returning a list of bindings required for a match.

```
> (match '(likes bill wine) '(likes bill wine))
t
> (match '(likes bill wine) '(likes bill milk))
nil
> (match '(likes bill ?) '(likes bill wine))           ; example with a variable
t
> (match '(likes ? wine) '(likes bill ?))             ; note variables in both expressions
t
> (match '(likes bill ?) '(likes bill (prolog lisp smalltalk)))
t
> (match '(likes ?) '(likes bill wine))
nil
```

match is used to define a function called *get-matches*, which takes as arguments two s-expressions. The first argument is a pattern to be matched against elements of the second s-expression, which must be a list. *get-matches* returns a list of the elements of

the list that match the first argument. In the example below, `get-matches` is used to retrieve records from an employee database as described earlier in this chapter.

Because the database is a large and relatively complex s-expression, we have bound it to the global variable `*database*` and use that variable as an argument to `get-matches`. This was done to improve readability of the examples.

```
> (setq *database* '((lovelace ada) 50000.00 1234)
  ((turing alan) 45000.00 3927)
  ((shelley mary) 35000.00 2850)
  ((vonNeumann john) 40000.00 7955)
  ((simon herbert) 50000.00 1374)
  ((mccarthy john) 48000.00 2864)
  ((russell bertrand) 35000.00 2950))

*database*
> (get-matches '((turing alan) 45000.00 3927) *database*)
((turing alan) 45000.00 3927)
> (get-matches '(? 50000.00 ?) *database*)           ; all people who make 50000
(((lovelace ada) 50000.00 1234) ((simon herbert) 50000.00 1374))
> (get-matches '((? john) ? ?) *database*)         ; all people named john
(((vonNeumann john) 40000.00 7955) ((mccarthy john) 48000.00 2864))
```

We implement `get-matches` through a straightforward use of `cdr` recursion to look for elements that match with the first argument (the pattern). All elements of the database that match the pattern are `CONSED` together to form the answer for the pattern. `get-matches` is defined:

```
(defun get-matches (pattern database)
  (cond ((null data-base) ())
        ((match pattern (car data-base))           ; match found, add to result
         (cons (car data-base) (get-matches pattern (cdr data-base))))
        (t (get-matches pattern (cdr data-base)))))
```

The heart of the system is the `match` function, a predicate that determines whether or not two s-expressions containing variables actually match. `match` is based on the idea that two lists match if and only if their respective `cars` and `cdrs` match, suggesting a `car-cdr` recursive scheme for the algorithm. The recursion terminates when either of the arguments is atomic (this includes the empty list, `nil`, which is both an atom and a list). If both patterns are the same atom or if one of the patterns is a variable atom, `?`, which can match with anything, then termination is with a successful match; otherwise, the match will fail. Notice that if either of the patterns is a variable, the other pattern need not be atomic; variables may match with s-expressions of arbitrary complexity.

Because the handling of the terminating conditions is complex, the implementation of `match` uses a function called `match-atom` that takes two arguments, one or both of which is an atom, and checks to see whether the patterns match. By hiding this complexity in `match-atom` the `car-cdr` recursive structure of `match` is more apparent:

```
(defun match (pattern1 pattern2)
  (cond (or (atom pattern1) (atom pattern2))           ; one of the patterns is atomic
        (match-atom pattern1 pattern2))              ; call match-atom, otherwise
        (t (and (match (car pattern 1) (car pattern2)) ; match both car and cdr
                 (match (cdr pattern 1) (cdr pattern 2))))))
```

The implementation of `match-atom` makes use of the fact that when it is called, at least one of the arguments is an atom. Because of this assumption, a simple test for equality of patterns is all that is needed to test that both patterns are the same atom (including both being a variable); it will fail either if the two patterns are different atoms or if one of them is nonatomic. If the first test fails, the only way a match can succeed is if one of the patterns is a variable. This check constitutes the remainder of the function definition. Finally, a function `variable-p` is defined to test whether or not a pattern is a variable. Treating variables as an abstract data type now will simplify later extensions to the function (for example, the extension of the function to named variables as in `PROLOG`).

```
(defun match-atom (pattern1 pattern2)
  (or (equal pattern1 pattern2)                       ; both patterns are the same, or
      (variable-p pattern 1)                          ; one of them is a variable.
      (variable-p pattern 2)))

(defun variable-p (x) (equal x '?))
```

10.6 A Recursive Unification Function

In Section 10.5 we implemented a recursive pattern-matching algorithm that allowed the inclusion of unnamed variables in patterns. Now we extend this simple pattern matcher into the full unification algorithm presented in Chapter 2. The function, `unify`, allows named variables in both of the patterns to be matched, and returns a list of the variable bindings required for the match. This unification function is the basis of the inference systems developed later in this chapter.

10.6.1 Implementing the Unification Algorithm

As in Section 10.5, patterns are either constants, variables, or list structures. In a full unification algorithm, variables may be distinguished from one another by their names. Named variables are going to be represented as lists of the form `(var <name>)`, where `<name>` is usually an atomic symbol. `(var x)`, `(var y)`, and `(var newstate)` are all examples of legal variables.

The function `unify` takes as arguments two patterns to be matched and a set of variable substitutions (bindings) to be employed in the match. Generally, this set will be empty (`nil`) when the function is first called. On a successful match, `unify` returns a (possibly

empty) set of substitutions required for a successful match. If no match was possible, `unify` returns the symbol `failed`; `nil` is used to indicate an empty substitution set, i.e., a match in which no substitutions were required. An example of the behavior of `unify`, with comments, appears below.

```
> (unify '(p a (var x)) '(p a b) ()) ; returns substitution of b for (var x)
(((var x) . b))
> (unify '(p (var y) b) '(p a (var x)) ()) ; variables appear in both patterns
(((var x) . b) ((var y) . a))
> (unify '(p (var x)) '(p (q a (var y)))) () ; variable bound to more complex pattern
(((var x) q a (var y)))
> (unify '(p a) '(p a) ()) ; nil indicates no substitution required
nil
> (unify '(p a) '(q a) ()) ; returns the atom failed to indicate failure
failed
```

We explain the “.” notation, as in `((var x).6)`, in Section 10.6.2, where we describe the implementation of substitution sets. `unify`, like the pattern matcher of Section 10.5, uses a `car-cdr` recursive scheme and is defined by:

```
(defun unify (pattern1 pattern2 substitution-list)
  (cond ((equal substitution-list 'failed) 'failed)
        ((varp pattern1) (match-var pattern1 pattern2 substitution-list) ; varp tests
                          ((varp pattern2) (match-var pattern2 pattern1 substitution-list) ; if variable
                          ((is-constant-p pattern1)
                           (cond ((equal pattern1 pattern2) substitution-list)
                                 (t 'failed)))
                          ((is-constant-p pattern2) 'failed)
                          (t (unify (cdr pattern1) (cdr pattern2)
                                   (unify (car pattern1) (car pattern2) substitution-list)))))
```

On entering `unify`, the algorithm first checks whether the substitution list is equal to `failed`. This could occur if a prior attempt to unify the `cars` of two patterns had failed. If this condition is met, the function returns `failed`.

Next, if either pattern is a variable, the function `match-var` is called to perform further checking and possibly add a new binding to the substitution list. If neither pattern is a variable, `unify` tests whether either is a constant, returning the unchanged substitution list if they are the same constant, `failed` otherwise.

The last item in the `cond` statement implements the tree-recursive decomposition of the problem: first, the `cars` of the patterns are unified using the bindings in `substitution-list`. The result is passed as the third argument to the call of `unify` on the `cdrs` of both patterns. This allows the variable substitutions made in matching the `cars` to be applied to other occurrences of those variables in the `cdrs` of both patterns.

`match-var`, which handles the case of matching a variable and a pattern, is defined by:

```
(defun match-var (var pattern substitution-list)
  (cond ((equal var pattern) substitution-list)
        (t (let ((binding (get-binding var substitution-list)))
              (cond (binding (unify (get-binding-value binding) pattern substitution-list))
                    ((occursp var pattern) 'failed)
                    (t (add-substitution var pattern substitution-list)))))))
```

`match-var` first checks whether the variable and the pattern are the same; unifying a variable with itself requires no added substitutions, so `substitution-list` is returned unchanged.

If `var` and `pattern` are not the same, `match-var` checks whether the variable is already bound. If a binding exists, `unify` is called recursively to match the *value* of the binding with `pattern`. Note that this binding value may be a constant, a variable, or a pattern of arbitrary complexity; this requires a call to the full unification algorithm to complete the match.

If no binding currently exists for `var`, the function calls `occursp` to test whether `var` appears in `pattern`. The *occurs check* is needed to prevent attempts to unify a variable with a pattern containing that variable, leading to a circular structure. For example, if `(var x)` was bound to `(p (var x))`, any attempt to apply those substitutions to a pattern would result in an infinite loop. If `var` appears in `pattern`, `match-var` returns `failed`; otherwise, it adds the new substitution pair to `substitution-list` using `add-substitution`.

`unify` and `match-var` are the heart of the unification algorithm. `occursp` (which performs a tree walk on a pattern to find any occurrences of the variable in that pattern), `varp`, and `is-constant-p` (which test whether their argument is a variable or a constant, respectively) appear below. Functions for handling substitution sets are discussed in the next section.

```
(defun occursp (var pattern)
  (cond ((equal var pattern) t)
        ((or (varp pattern) (is-constant-p pattern)) nil)
        (t (or (occursp var (car pattern))
                (occursp var (cdr pattern))))))
```

```
(defun is-constant-p (item)
  (atom item))
```

```
(defun varp (item)
  (and (listp item)
       (equal (length item) 2)
       (equal (car item) 'var)))
```

10.6.2 Implementing Substitution Sets Using Association Lists

Sets of substitutions are represented using a built-in LISP data type called the *association list* or *a-list*. This is the basis for the functions `add-substitutions`, `get-binding`, and `binding-value`. An association list is a list of data records, or *key/data* pairs. The `car` of

each record is a *key* for its retrieval; the *cdr* of each record is called the *datum*. The datum may be a list of values or a single atom. Retrieval is implemented by the function `ASSOC`, which takes as arguments a key and an association list and returns the first member of the association list that has the key as its *car*. An optional third argument to `ASSOC` specifies the test to be used in comparing keys. The default test is the Common LISP function `EQL`, a form of equality test requiring two arguments be the same object (i.e., either the same memory location or the same numeric value). In implementing substitution sets, we will specify a less strict test, `EQUAL`, which requires only that the arguments match syntactically (i.e., are designated by identical names). An example of `ASSOC`'s behavior appears below:

```
> (assoc 3 '((1 a) (2 b) (3 c) (4 d)))
(3 c)
> (assoc 'd '((a b c) (b c d e) (d e f) (c d e)) :test #'equal)
(d e f)
> (assoc 'c '((a . 1) (b . 2) (c . 3) (d . 4)) :test #'equal)
(c . 3)
```

Note that `ASSOC` returns the entire record matched on the key; the datum may be retrieved from this list by the `CDR` function. Also, notice that in the last call the members of the *a*-list are not lists but a structure called *dotted pairs*, e.g., `(a . 1)`.

The dotted pair, or *cons pair*, is actually the fundamental constructor in LISP. It is the result of `CONS`ing one s-expression onto another; the list notation that we have used throughout the chapter is just a notational variant of dotted pairs. For example, the value returned by `(CONS 1 NIL)` is actually `(1 . NIL)`; this is equivalent to `(1)`. Similarly, the list `(1 2 3)` may be written in dotted pair notation as `(1 . (2 . (3 . NIL)))`. Although the actual effect of a `CONS` is to create a dotted pair, the list notation is cleaner and is generally preferred.

If two atoms are `CONSED` together, the result is always written using dotted pair notation. The `CDR` of a dotted pair is the second element in the pair, rather than a list containing the second atom. For example:

```
> (cons 'a 'b)
(a . b)
> (car '(a . b))
a
> (cdr '(a . b))
b
```

Dotted pairs occur naturally in association lists when one atom is used as a key for retrieving another atom, as well as in other applications that require the formation and manipulation of pairs of atomic symbols. Because unifications often substitute a single atom for a variable, dotted pairs appear often in the association list returned by the unification function.

Along with `ASSOC`, Common LISP defines the function `ACONS`, which takes as arguments a key, a datum and an association-list and returns a new association list whose first element is the result of `CONS`ing the key onto the datum. For example:

```
> (acons 'a 1 nil)
((a . 1))
```

Note that when `acons` is given two atoms, it adds their `CONS` to the association list:

```
> (acons 'pets '(emma jack clyde)
'((name . bill) (hobbies music skiing movies) (job . programmer)))
((pets emma jack clyde) (name . bill) (hobbies music skiing movies)
(job . programmer))
```

Members on an association list may be either dotted pairs or lists.

Association lists provide a convenient way to implement a variety of tables and other simple data retrieval schemes. In implementing the unification algorithm, we use association lists to represent sets of substitutions: the keys are the variables, and the data are the values of their bindings. The datum may be a simple variable or constant or a more complicated structure.

Using association lists, the substitution set functions are defined:

```
(defun get-binding (var substitution-list)
  (assoc var substitution-list :test #'equal))

(defun get-binding-value (binding) (cdr binding))

(defun add-substitution (var pattern substitution-list)
  (acons var pattern substitution-list))
```

This completes the implementation of the unification algorithm. We will use it in Section 10.8 to implement a simple PROLOG interpreter, and in Section 10.10 to build an expert system shell.

10.7 Interpreters and Embedded Languages

The top level of the LISP interpreter is known as the *read-eval-print* loop. This describes the interpreter's behavior in reading, evaluating, and printing the value of s-expressions entered by the user. The `eval` function, defined in Section 10.1.4, is the heart of the LISP interpreter; using `eval`, it is possible to write LISP's top-level *read-eval-print* loop in LISP itself. In the next example, we develop a simplified version of this loop. This version is simplified chiefly in that it does not have the error-handling abilities of the built-in loop, although LISP does provide the functionality needed to implement such capabilities.

To write the *read-eval-print* loop, we use two more LISP functions, `read` and `print`. `read` is a function that takes no parameters; when it is evaluated, it simply returns the next s-expression entered at the keyboard. `print` is a function that takes a single argument, evaluates it, and then prints that result to standard output. On completion, `print` returns a

value of nil. Another function that will prove useful is `terpri`, a function of no arguments that causes a `newline` character to be sent to standard output. `terpri` also returns a value of nil on completion.

Using these functions, the `read-eval-print` loop is based on a simple nested s-expression:

```
(print (eval (read)))
```

When this is evaluated, the innermost s-expression, `(read)`, is evaluated first. The value returned by the `read`, the next s-expression entered by the user, is passed to `eval`, where it is evaluated. The result of this evaluation is passed to `print`, where it is sent to the display screen. To complete the loop we add a `print` expression to output the prompt, a `terpri` to output a `newline` after the result has been printed, and a recursive call to repeat the cycle. Thus, the final `read-eval-print` loop is defined:

```
(defun my-read-eval-print () ; this function takes no arguments
  (print ':) ; output a prompt, ours is a ":"
  (print (eval (read))) ; read-eval-print
  (terpri) ; output a newline
  (my-read-eval-print)) ; do it all again
```

This may be used "on top of" the built-in interpreter:

```
> (my-read-eval-print)
:(+ 1 2) ; note the new prompt
3
: ; etc.
```

As this example illustrates, by making functions such as `quote` and `eval` available to the user, LISP gives the programmer a high degree of control over the handling of functions. Because LISP programs and data are both represented as s-expressions, we may write programs that perform any desired manipulations of LISP expressions prior to evaluating them. This underlies much of LISP's power as a procedural representation language, because it allows arbitrary LISP code to be stored, modified, and evaluated when needed. It also makes it simple to write specialized interpreters that may extend or modify the behavior of the built-in LISP interpreter in some desired fashion. This capability is at the heart of many LISP-based expert systems, that read user queries and respond to them according to the expertise contained in their knowledge base.

As an example of the way in which such a specialized interpreter may be implemented in LISP, we may modify `my-read-eval-print` so that it evaluates arithmetic expressions in an infix rather than a prefix notation, as in the following example (note the modified prompt, `infix->`):

```
infix-> (1 + 2)
3
```

```

infix-> (7 - 2)
5
infix-> ((5 + 2) * (3 - 1))           ; the loop should allow nesting of expressions
14

```

To simplify the example, the infix interpreter handles only arithmetic expressions. A further simplification restricts the interpreter to binary operations and requires that all expressions be fully parenthesized, eliminating the need for more sophisticated parsing techniques or worries about operator precedence. However, it does allow expressions to be nested to arbitrary depth and handles the binary arithmetic operators supported by LISP.

We modify the previously developed `read-eval-print` loop by adding a function that translates infix expressions into prefix expressions prior to passing them on to `eval`. A first attempt at writing this function might look like:

```

(defun simple-in-to-pre (exp)
  (list (nth 1 exp)           ; middle element (operator) becomes first element.
        (nth 0 exp)         ; first operand
        (nth 2 exp)        ; second operand)

```

`simple-in-to-pre` is effective in translating simple expressions; however, it is not able to correctly translate nested expressions, that is, expressions in which the operands are themselves infix expressions. To handle this situation properly, the operands must also be translated into prefix notation. Recursion is halted by testing the argument to determine whether it is a number, returning it unchanged if it is. The completed version of the infix-to-prefix translator is:

```

(defun in-to-pre (exp)
  (cond ((numberp exp) exp)
        (t (list (nth 1 exp)
                  (in-to-pre (nth 0 exp))
                  (in-to-pre (nth 2 exp))))))

```

Using this translator, the `read-eval-print` loop may be modified to interpret infix expressions, as defined below:

```

(defun in-eval ( )
  (print 'infix->)
  (print (eval (in-to-pre (read))))
  (terpri)
  (in-eval))

```

This allows the interpretation of binary expressions in infix form:

```

> (in-eval)
infix->(2 + 2)
4

```

```
infix->((3 * 4) - 5)
7
```

In the above example, we have implemented a new language, the language of infix arithmetic, in LISP. Because of the facilities LISP provides for symbolic computing (lists and functions for their manipulation) along with the ability to control evaluation, this was much easier to do than in many other programming languages. This example illustrates an important AI programming methodology, that of *meta-linguistic abstraction*. Very often in AI programming, a problem is not completely understood, or the program required to solve a problem is extremely complex. *Meta-linguistic abstraction* uses the underlying programming language, in this case, LISP, to implement a specialized, high-level language that may be more effective for solving a particular class of problems. The term "meta-linguistic abstraction" refers to our use of the base language to implement this other programming language, rather than to directly solve the problem. As we saw in Section 9.6, PROLOG also gives the programmer the power to create meta-level interpreters. The power of meta-interpreters to support programming in complex domains was also discussed in the introduction to Part IV.

10.8 Logic Programming in LISP

As an example of meta-linguistic abstraction, we develop a LISP-based logic programming interpreter, using the unification algorithm from Section 10.6. Like PROLOG, our logic programs consist of a database of facts and rules in the predicate calculus. The interpreter processes queries (or goals) by unifying them against entries in the logic database. If a goal unifies with a simple fact, it succeeds; the solution is the set of bindings generated in the match. If it matches the head of a rule, the interpreter recursively attempts to satisfy the rule premise in a depth-first fashion, using the bindings generated in matching the head. On success, the interpreter prints the original goal, with variables replaced by the solution bindings.

For simplicity's sake, this interpreter supports conjunctive goals and implications: `or` and `not` are not defined, nor are features such as arithmetic, I/O, or the usual PROLOG built-in predicates. Although we do not implement full PROLOG, and the exhaustive nature of the search and absence of the *cut* prevent the proper treatment of recursive predicates, the shell captures the basic behavior of the logic programming languages. The addition to the interpreter of the other features just mentioned is an interesting and valuable exercise.

10.8.1 A Simple Logic Programming Language

Our logic programming interpreter supports Horn clauses, a subset of full predicate calculus. Well-formed formulas consist of terms, conjunctive expressions, and rules written in a LISP-oriented syntax. A compound term is a list in which the first element is a

predicate name and the remaining elements are the arguments. Arguments may be either constants, variables, or other compound terms. As in the discussion of `unify`, we represent variables as lists of two elements, the word `var` followed by the name of the variable. Examples of terms include:

```
(likes bill music)
(on block (var x))
(friend bill (father robert))
```

A conjunctive expression is a list whose first element is `and` and whose subsequent arguments are either simple terms or conjunctive expressions:

```
(and (smaller david sarah) (smaller peter david))
(and (likes (var x) (var y)) (likes (var z) (var y)))
(and (hand-empty) (and (on block-1 block-2) (on block-2 table)))
```

Implications are expressed in a syntactically sweetened form that simplifies both their writing and recognition:

```
(rule if <premise> then <conclusion> )
```

where `<premise>` is either a simple or conjunctive proposition and `<conclusion>` is always a simple proposition. Examples of rules include:

```
(rule if (and (likes (var x) (var z))
              (likes (var y) (var z)))
         then (friend (var x) (var y)))

(rule if (and (size (var x) small)
              (color (var x) red)
              (smell (var x) fragrant))
         then (kind (var x) rose))
```

The logical database is a list of facts and rules bound to a global variable, `*assertions*`. We can define an example knowledge base of likes relationships by a call to `setq`:

```
(setq *assertions*
      '((likes george beer)
        (likes george kate)
        (likes george kids)
        (likes bill kids)
        (likes bill music)
        (likes bill pizza)
        (likes bill wine)))
```

```
(rule
  if (and (likes (var x) (var z))
          (likes (var y) (var z)))
  then (friend (var x) (var y))))
```

The top level of the interpreter is a function, **logic-shell**, that reads goals and attempts to satisfy them against the logic database bound to ***assertions***. Given the above database, **logic-shell** will have the following behavior (comments follow the ;):

```
> (logic-shell) ; logic-shell prompts with a ?
?(likes bill (var x)) ; successful queries are printed with substitutions
(likes bill kids)
(likes bill music)
(likes bill pizza)
(likes bill wine)

?(likes george kate)
(likes george kate)

?(likes george taxes) ; failed query returns nothing

?(friend bill george)
(friend bill george) ; from (and(likes bill kids)(likes george kids))

?(friend bill roy) ; roy does not exist in knowledge base, query fails

?(friend bill (var x))
(friend bill george) ; from (and(likes bill kids)(likes george kids))
(friend bill bill) ; from (and(likes bill kids)(likes bill kids))
(friend bill bill) ; from (and(likes bill music)(likes bill music))
(friend bill bill) ; from (and(likes bill pizza)(likes bill pizza))
(friend bill bill) ; from (and(likes bill wine)(likes bill wine))

?quit
bye
>
```

Before discussing the implementation of the logic programming interpreter, we introduce the *stream* data type.

10.8.2 Streams and Stream Processing

As the preceding example suggests, even a small knowledge base can produce complex behaviors. It is necessary not only to determine the truth or falsity of a goal but also to determine the variable substitutions that make that goal true in the knowledge base. A single goal can match with different facts, producing different substitution sets;

conjunctions of goals require that all conjuncts succeed and also that the variable bindings be consistent throughout. Similarly, rules require that the substitutions formed in matching a goal with a rule conclusion be made in the rule premise when it is solved. The management of these multiple substitution sets is the major source of complexity in the interpreter. Streams help us to address this complexity by focusing on the movement of a sequence of candidate variable substitutions through the constraints defined by the logic database.

A *stream* is a sequence of data objects. Perhaps the most common example of stream processing is a typical interactive program. The data from the keyboard are viewed as an endless sequence of characters, and the program is organized around reading and processing the *current* character from the input stream. Stream processing is a generalization of this idea: streams need not be produced by the user; they may also be generated and modified by functions. A *generator* is a function that produces a continuing stream of data objects. A *map function* applies some function to each of the elements of a stream. A *filter* eliminates selected elements of a stream according to the constraints of some predicate.

The solutions returned by an inference engine may be represented as a stream of different variable substitutions under which a goal follows from a knowledge base. The constraints defined by the knowledge base are used to modify and filter a stream of candidate substitutions, producing the result.

Consider the conjunctive goal

```
(and (likes bill (var z))
      (likes george (var z)))
```

using the logic database from the preceding section. The stream-oriented view regards each of the conjuncts in the expression as a *filter* for a stream of substitution sets. Each set of variable substitutions in the stream is applied to the conjunct and the result is matched against the knowledge base. If the match fails, that set of substitutions is eliminated from the stream; if it succeeds, the match may create new sets of substitutions by adding new bindings to the original substitution set.

Figure 10.4 illustrates the stream of substitutions passing through this conjunctive goal. It begins with a stream of candidate substitutions containing only the empty substitution set and grows after the first proposition matches against multiple entries in the database. It then shrinks to a single substitution set as the second conjunct eliminates substitutions that do not allow `(likes george (var z))` to succeed. The resulting stream, `((((var z) . kids)))`, contains the only variable substitution that allows both subgoals in the conjunction to succeed in the knowledge base.

As this example illustrates, a goal and a single set of substitutions may generate several new substitution sets, one for each match in the knowledge base. Alternatively, a goal will eliminate a substitution set from the stream if no match is found. The stream of substitution sets may grow and shrink as it passes through a series of conjuncts.

The basis of stream processing is a set of functions to create, augment, and access the elements of a stream. We can define a simple set of stream functions using lists and the

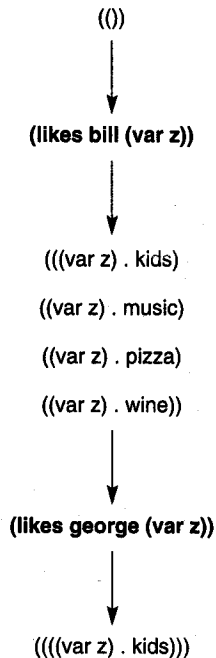

Figure 10.4 Stream of variable substitutions filtered through conjunctive subgoals.

standard list manipulators. The functions that constitute a list-based implementation of the stream data type are:

; Cons-stream adds a new first element to a stream
 (defun cons-stream (element stream) (cons element stream))

; head-stream returns the first element of the stream
 (defun head-stream (stream) (car stream))

; tail-stream returns the stream with its first element deleted.
 (defun tail-stream (stream) (cdr stream))

; empty-stream-p is true if the stream is empty
 (defun empty-stream-p (stream) (null stream))

; make-empty-stream creates an empty stream
 (defun make-empty-stream () nil)

```

; combine-stream appends two streams.
(defun combine-streams (stream1 stream2)
  (cond ((empty-stream-p stream1) stream2)
        (t (cons-stream (head-stream stream1)
                          (combine-streams
                           (tail-stream stream 1)
                           (stream2))))))

```

Although the implementation of streams as lists does not allow the full power of stream-based abstraction, the definition of a stream data type helps us to view the program from a data flow point of view. For many problems, such as the logic programming interpreter of Section 10.8.3, this provides the programmer with a powerful tool for organizing and simplifying the code. In Section 10.9 we discuss some limitations of this list-based implementation of streams and present an alternative approach using streams with delayed evaluation.

10.8.3 A Stream-Based Logic Programming Interpreter

We invoke the interpreter through a function called `logic-shell`, a straightforward variation of the `read-eval-print` loop discussed in Section 10.7. After printing a prompt, “?”, it reads the next `s`-expression entered by the user and binds it to the symbol `goal`. If `goal` is equal to `quit`, the function halts; otherwise, it calls `solve` to generate a stream of substitution sets that satisfy the goal. This stream is passed to `print-solutions`, which prints the goal with each of these different substitutions. The function then recurs. `logic-shell` is defined by:

```

(defun logic-shell ( )
  (print '? )
  (let ((goal (read)))
    (cond ((equal goal 'quit) 'bye)
          (t (print-solutions goal (solve goal nil))
              (terpri)
              (logic-shell))))))

```

`solve` is the heart of the interpreter. `solve` takes a goal and a set of substitutions and finds all solutions that are consistent with the knowledge base. These solutions are returned as a stream of substitution sets; if there are no matches, `solve` returns the empty stream. From the stream processing point of view, `solve` is a *source*, or *generator*, for a stream of solutions. `solve` is defined by:

```

(defun solve (goal substitutions)
  (declare (special *assertions*))
  (if (conjunctive-goal-p goal)
      (filter-through-conj-goals (body goal)
                                 (cons-stream substitutions (make-empty-stream)))
      (make-empty-stream)))

```

The declaration at the beginning of this definition tells the LISP compiler that **assertions** is a *special*, or global, variable and should be bound dynamically in the environment in which *solve* is called.

solve first tests whether the goal is a conjunction; if it is, *solve* calls *filter-through-conj-goals* to perform the filtering described in Section 10.8.2. If *goal* is not a conjunction, *solve* assumes it is a simple goal and calls *infer*, defined below, to solve it against the knowledge base.

solve calls *filter-through-conj-goals* with the body of the conjunction (i.e., the sequence of conjuncts with the *and* operator removed) and a stream that contains only the initial substitution set. The result is a stream of substitutions representing all of the solutions for this goal. We define *filter-through-conj-goals* by:

```
(defun filter-through-conj-goals (goals substitution-stream)
  (if (null goals)
      substitution-stream
      (filter-through-conj-goals (cdr goals)
                                (filter-through-goal (car goals) substitution-stream))))
```

If the list of goals is empty, the function halts, returning *substitution stream* unchanged. Otherwise, it calls *filter-through-goal* to filter *substitution-stream* through the first goal on the list. It passes this result on to a recursive call to *filter-through-conj-goals* with the remainder of the goal list. Thus, the stream is passed through the goals in left-to-right order, growing or shrinking as it passes through each goal.

filter-through-goal takes a single goal and uses it as a filter to the stream of substitutions. This filtering is done by calling *solve* with the goal and the first set of substitutions in the substitution stream. The result of this call to *solve* is a stream of substitutions resulting from matches of the goal against the knowledge base. This stream will be empty if the goal does not succeed under any of the substitutions contained in the stream, or it may contain multiple substitution sets representing alternative bindings. This stream is combined with the result of filtering the tail of the input stream through the same goal:

```
(defun filter-through-goal (goal substitution-stream)
  (if (empty-stream-p substitution-stream)
      (make-empty-stream)
      (combine-streams
        (solve goal (head-stream substitution-stream))
        (filter-through-goal goal (tail-stream substitution-stream)))))
```

To summarize, *filter-through-conj-goals* passes a stream of substitution sets through a sequence of goals, and *filter-through-goal* filters the substitution stream through a single goal. A recursive call to *solve* solves the goal under each substitution set.

Whereas *solve* handles conjunctive goals by calling *filter-through-conj-goals*, simple goals are handled by the function *infer*, defined next, which takes a goal and a substitution set and finds all solutions in the knowledge base. *infer*'s third parameter, *kb*, is a database of logical expressions. When *solve* first calls *infer*, it passes the knowledge base

contained in the global variable `*assertions*`. `infer` searches `kb` sequentially, trying the goal against each fact or rule conclusion.

The recursive implementation of `infer` builds the backward-chaining search typical of PROLOG and most expert system shells. It first checks whether `kb` is empty, returning an empty stream if it is. Otherwise, it binds the first item in `kb` to the symbol `assertion` using a `let*` block. `let*` is like `let` except it is guaranteed to evaluate the initializations of its local variables in order. It also defines the variable `match`: if `assertion` is a rule, `let` initializes `match` to the substitutions required to unify the goal with the conclusion of the rule; if `assertion` is a fact, `let` binds `match` to those substitutions required to unify `assertion` with the goal. After attempting to unify the goal with the first element of the knowledge base, `infer` tests whether the unification succeeded. If it failed to match, `infer` recurs, attempting to solve the goal using the remainder of the knowledge base. If the unification succeeded and `assertion` is a rule, `infer` calls `solve` on the premise of the rule using the augmented set of substitutions bound to `match`. `combine-stream` joins the resulting stream of solutions to that constructed by calling `infer` on the rest of the knowledge base. If `assertion` is not a rule, it is a fact; `infer` adds the solution bound to `match` to those provided by the rest of the knowledge base. Note that once the goal unifies with a fact, it is solved; this terminates the search. We define `infer`:

```
(defun infer (goal substitutions kb)
  (if (null kb)
      (make-empty-stream)
      (let* ((assertion (rename-variables (car kb)))
            (match (if (rulep assertion)
                       ((unify goal (conclusion assertion) substitutions)
                        (unify goal assertion substitutions))))
            (if (equal match 'failed)
                (infer goal substitutions (cdr kb))
                (if (rulep assertion)
                    (combine-streams
                     (solve (premise assertion) match)
                     (infer goal substitutions (cdr kb))))
                    (cons-stream match (infer goal substitutions (cdr kb))))))))))
```

Before the first element of `kb` is bound to `assertion`, it is passed to `rename-variables` to give each variable a unique name. This prevents name conflicts between the variables in the goal and those in the knowledge base entry; e.g., if `(var x)` appears in a goal, it must be treated as a different variable than a `(var x)` that appears in the rule or fact. The simplest way to handle this is by renaming all variables in the assertion with unique names. We define `rename-variables` at the end of this section.

This completes the implementation of the core of the logic programming interpreter. To summarize, `solve` is the top-level function and generates a stream of substitution sets that represent solutions to the goal using the knowledge base. `filter-through-conj-goals` solves conjunctive goals in a left-to-right order, using each goal as a filter on a stream of candidate solutions: if a goal cannot be proven true against the knowledge base using a substitution set in the stream, `filter-through-conj-goals` eliminates those substitutions

from the stream. If the goal is a simple literal, `solve` calls `infer` to generate a stream of all substitutions that make the goal succeed against the knowledge base. Like `PROLOG`, our logic programming interpreter takes a goal and finds all variable bindings that make it true against a given knowledge base.

All that remain are a number of straightforward functions for accessing components of knowledge base entries, managing variable substitutions, and printing solutions. `print-solutions` takes as arguments a goal and a stream of substitutions. For each set of substitutions in the stream, it prints the goal with variables replaced by their bindings in the substitution set.

```
(defun print-solutions (goal substitution-stream)
  (cond ((empty-stream-p substitution-stream) nil)
        (t (print (apply-substitutions goal (head-stream substitution-stream)))
            (terpri)
            (print-solutions goal (tail-stream substitution-stream))))))
```

The replacement of variables with their values under a substitution set is done by `apply-substitutions`, which does a `car-cdr` recursive tree walk on a pattern. If the pattern is a constant, it is returned unchanged. If it is a variable, `apply-substitutions` tests if it is bound. If it is unbound, the variable is returned; if it is bound, `apply-substitutions` calls itself recursively on the value of this binding. Note that the binding value may be either a constant, another variable, or a pattern of arbitrary complexity.

```
(defun apply-substitutions (pattern substitution-list)
  (cond ((is-constant-p pattern) pattern)
        ((varp pattern)
         (let ((binding (get-binding pattern substitution-list)))
           (cond (binding (apply-substitutions (binding-value binding)
                                               substitution-list))
                 (t pattern))))))
  (t (cons (apply-substitutions (car pattern) substitution-list)
           (apply-substitutions (cdr pattern) substitution-list))))))
```

`infer` renamed the variables in each knowledge base entry before matching it with a goal. This is necessary to prevent undesired name collisions in matches. For example, the goal `(p a (var x))` should match with the knowledge base entry `(p (var x) b)`, because the scope of each `(var x)` is restricted to a single expression. As unification is defined, however, this match will not occur. Name collisions are prevented by giving each variable in an expression a unique name. The basis of our renaming scheme is a Common LISP built-in function called `gensym` that takes no arguments; each time it is called, it returns a unique symbol consisting of a number preceded by `#:G`. For example:

```
> (gensym)
#:G4
> (gensym)
#:G5
```

```
> (gensym)
#:G6
>
```

Our renaming scheme replaces each variable name in an expression with the result of a call to `gensym`. `rename-variables` performs certain initializations (described below) and calls `rename-rec` to make substitutions recursively in the pattern. When a variable is encountered, the function `rename` is called to return a new name. To allow multiple occurrences of a variable in a pattern to be given consistent names, each time a variable is renamed, the new name is placed in an association list bound to the *special* variable `*name-list*`. The special declaration makes all references to the variable dynamic and shared among these functions. Thus, each access of `*name-list*` in `rename` will access the instance of `*name-list*` declared in `rename-variables`. `rename-variables` initializes `*name-list*` to `nil` when it is first called. These functions are defined:

```
(defun rename-variables (assertion)
  (declare (special *name-list*))
  (setq *name-list* nil)
  (rename-rec assertion))

(defun rename-rec (exp)
  (declare (special *name-list*))
  (cond ((is-constant-p exp) exp)
        ((varp exp) (rename exp))
        (t (cons (rename-rec (car exp))(rename-rec (cdr exp))))))

(defun rename (var)
  (declare (special *name-list*))
  (list 'var (or (cdr (assoc var *name-list* :test #'equal))
                (let ((name (gensym)))
                  (setq *name-list* (acons var name *name-list*))name))))
```

The final functions `access`, `components` of rules and goals and are self-explanatory:

```
(defun premise (rule) (nth 2 rule))

(defun conclusion (rule) (nth 4 rule))

(defun rulep (pattern)
  (and (listp pattern)
       (equal (nth 0 pattern) 'rule)))

(defun conjunctive-goal-p (goal)
  (and (listp goal)
       (equal (car goal) 'and)))

(defun body (goal) (cdr goal))
```

10.9 Streams and Delayed Evaluation

As we demonstrated in the implementation of *logic-shell*, a stream-oriented view can help with the organization of a complex program. However, our implementation of streams as lists did not provide the full benefit of stream processing. In particular, this implementation suffers from inefficiency and an inability to handle infinitely long data streams.

In the list implementation of streams, all of the elements must be computed before that stream (list) can be passed on to the next function. In *logic-shell* this leads to an exhaustive search of the knowledge base for each intermediate goal in the solution process. In order to produce the first solution to the top-level goal, the program must produce a list of all solutions. Even if we want only the first solution on this list, the program must still search the entire solution space. What we would really prefer is for the program to produce just the first solution by searching only that portion of the space needed to produce that solution and then to delay finding the rest of the goals until they are needed.

A second problem is the inability to process infinitely long streams. Although this problem does not arise in *logic-shell*, it occurs naturally in the stream-based solution to many problems. Assume, for example, that we would like to write a function that returns a stream of the first n odd Fibonacci numbers. A straightforward implementation would use a generator to produce a stream of Fibonacci numbers, a filter to eliminate even-valued numbers from the stream, and an accumulator to gather these into a solution list of n elements; see Figure 10.5. Unfortunately, the stream of Fibonacci numbers is infinite in length and we cannot decide in advance how long a list will be needed to produce the first n odd numbers.

Instead, we would like the generator to produce the stream of Fibonacci numbers one at a time and pass each number through the filter until the accumulator has gathered the n values required. This behavior more closely fits our intuitive notion of evaluating a stream than does the list-based implementation. We will accomplish this through the use of *delayed evaluation*.

Instead of letting the generator run to completion to produce the entire stream of results, we let the function produce the first element of the stream and then freeze or delay its execution until the next element is needed. When the program needs the next element of the stream, it causes the function to resume execution and produce only that element and again delay evaluation of the rest of the stream. Thus, instead of containing the entire list of numbers, the stream consists of just two components, its first element and the frozen computation of the rest of the stream; see Figure 10.6.

We use *function closures* to create the delayed portion of the stream illustrated in Figure 10.4. A closure consists of a function, along with all its variable bindings in the current environment; we may bind a closure to a variable, or pass it as a parameter, and evaluate it using *funcall*. Essentially, a closure “freezes” a function application until a later time. We can create closures using the LISP form *function*. For example, consider the following LISP transcript:

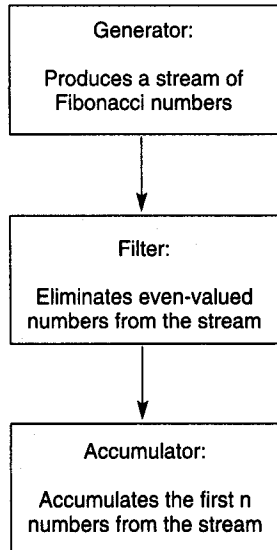

Figure 10.5 Stream implementation of a program to find the first n odd Fibonacci numbers.

A list-based stream containing an indeterminate number of elements:

$(e_1 e_2 e_3 e_4 \dots)$

A stream with delayed evaluation of its tail containing only two elements but capable of producing any number of elements:

$(e_1 . \text{<delayed evaluation of remainder of stream>})$

Figure 10.6 List-based versus delayed evaluation implementations of streams.

```

> (setq v 10)
10
> (let ((v 20)) (setq f_closure (function (lambda ( ) v))))
#<COMPILED-LEXICAL-CLOSURE #x28641E>
> (funcall f_closure)
20
> v
10
  
```

The initial `setq` binds `v` to `10` in the global environment. In the `let` block, we create a local binding of `v` to `20` and create a closure of a function that returns this value of `v`. It is interesting to note that this binding of `v` does not disappear when we exit the `let` block, because it is retained in the function closure that is bound to `f_closure`. It is a lexical binding, however, so it doesn't shadow the global binding of `v`. If we subsequently evaluate this closure, it returns `20`, the value of the local binding of `v`, even though the global `v` is still bound to `10`.

The heart of this implementation of streams is a pair of functions, `delay` and `force`. `delay` takes an expression as argument and does not evaluate it; instead it takes the unevaluated argument and returns a closure. `force` takes a function closure as argument and uses `funcall` to force its application. These functions are defined:

```
(defmacro delay (exp) '(function (lambda () ,exp)))
```

```
(defun force (function-closure)
  (funcall function-closure))
```

`delay` is an example of a LISP form called a *macro*. We cannot define `delay` using `defun` because all functions so defined evaluate their arguments before executing the body. Macros give us complete control over the evaluation of their arguments. We define macros using the `defmacro` form. When a macro is executed, it does not evaluate its arguments. Instead, it binds the unevaluated s-expressions in the call to the formal parameters and evaluates its body *twice*. The first evaluation is called a *macro-expansion*; the second evaluates the resulting form.

To define the `delay` macro, we introduce another LISP form, the *backquote*. Backquote prevents evaluation just like a `quote`, except that it allows us to evaluate selectively elements of the backquoted expression. Any element of a backquoted s-expression preceded by a comma is evaluated and its value inserted into the resulting expression.

For example, assume the call `(delay (+ 2 3))`. The expression `(+ 2 3)` is not evaluated; instead it is bound to the formal parameter, `exp`. When the body of the macro is evaluated the first time, it returns the backquoted expression with the formal parameter, `exp`, replaced by its value, the unevaluated s-expression `(+ 2 3)`. This produces the expression `(function (lambda () (+ 2 3)))`. This is evaluated again, returning a function closure.

If we later pass this closure to `force`, it will evaluate the expression `(lambda () (+ 2 3))`. This is a function that takes no arguments and whose body evaluates to `5`. Using `force` and `delay`, we can implement streams with delayed evaluation. We rewrite `cons-stream` as a macro that takes two arguments and `conses` the value of the first onto the delayed evaluation of the second. Thus, the second argument may be a function that will return a stream of any length; it is not evaluated. We define `tail-stream` so that it forces the evaluation of the tail of a stream. These are defined:

```
(defmacro cons-stream (exp stream) '(cons, exp (delay, stream)))
```

```
(defun tail-stream (stream) (force (cdr stream)))
```

We also redefine `combine-streams` as a macro that takes two streams but does not evaluate them. Instead, it uses `delay` to create a closure for the second stream and passes this and the first stream to the function `comb-f`. `comb-f` is similar to our earlier definition of `combine-streams`, except that in the event that the first stream is empty, it forces evaluation of the second stream. If the first stream is not empty, the recursive call to `comb-f` is done using our delayed version of `cons-stream`. This freezes the recursive call in a closure for later evaluation.

```
(defmacro combine-streams (stream1 stream2)
  '(comb-f, stream1 (delay, stream2)))

(defun comb-f (stream1 stream2)
  (if (empty-stream-p stream1)
      (force stream2)
      (cons-stream (head-stream stream1)
                   (comb-f (tail-stream stream1) stream2))))
```

If we add these definitions to the versions of `head-stream`, `make-empty-stream`, and `empty-stream-p` from Section 10.8.2, we have a complete stream implementation with delayed evaluation.

We can use these functions to solve our problem of producing the first *n* odd Fibonacci numbers. `fibonacci-stream` returns a stream of all the Fibonacci numbers; note that `fibonacci-stream` is a nonterminating recursive function. Delayed evaluation prevents it from looping forever; it produces the next element only when needed. `filter-odds` takes a stream of integers and eliminates the even elements of the stream. `accumulate` takes a stream and a number *n* and returns a *list* of the first *n* elements of the stream.

```
(defun fibonacci-stream (fibonacci-1 fibonacci-2)
  (cons-stream (+ fibonacci-1 fibonacci-2)
              (fibonacci-stream fibonacci-2 (+ fibonacci-1 fibonacci-2))))

(defun filter-odds (stream)
  (cond ((evenp (head-stream stream)) (filter-odds (tail-stream stream)))
        (t (cons-stream (head-stream stream) (filter-odds (tail-stream stream))))))

(defun accumulate-into-list (n stream)
  (cond ((zerop n) nil)
        (t (cons (head-stream stream) (accumulate-into-list
                                                         (- n 1)(tail-stream stream))))))
```

To obtain a list of the first 25 odd Fibonacci numbers, we simply evaluate the function `accumulate-into-list`:

```
(accumulate-into-list 25 (filter-odds (fibonacci-stream 0 1)))
```

We may use these stream functions in the definition of the logic programming interpreter of Section 10.8 to improve its efficiency under certain circumstances. Assume that we would like to modify `print-solutions` so that instead of printing all solutions to a goal, it prints the first and waits for the user to ask for the additional solutions. Using our implementation of lists as streams, the algorithm would still search for all solutions before it could print out the first. Using delayed evaluation, the first solution will be the head of a stream, and the function evaluations necessary to find the additional solutions will be frozen in the tail of the stream.

In the next section we modify this logic programming interpreter to implement a LISP-based expert system shell. Before presenting the expert system shell, however, we mention two additional stream functions that are used in its implementation. In Section 10.3, we presented a general mapping function and a general filter for lists. These functions, `map-simple` and `filter`, can be straightforwardly modified to function on streams. We use `filter-stream` and `map-stream` in the next section; their implementation is left as an exercise.

10.10 An Expert System Shell in LISP

The expert system shell developed in this section is an extension of the backward-chaining engine of Section 10.8. The major modifications include the use of certainty factors to manage uncertain reasoning, the ability to ask the user for unknown facts, and the use of a working memory to save user responses. This expert system shell is called `lisp-shell`.

10.10.1 Implementing Certainty Factors

The logic programming interpreter returned a stream of the substitution sets under which a goal logically followed from a database of logical assertions. Bindings that did not allow the goal to be satisfied using the knowledge base were either filtered from the stream or not generated in the first place. In implementing reasoning with certainty factors, however, simple truth values are replaced by a numeric value between -1 and 1 .

This requires that the stream of solutions to a goal not only contain the variable bindings that allow the goal to be satisfied; they must also include measures of the confidence under which each solution follows from the knowledge base. Consequently, instead of processing streams of substitution sets, `lisp-shell` processes streams of pairs: a set of substitutions and a number representing the confidence in the truth of the goal under those variable substitutions.

We implement stream elements as an abstract data type: the functions for manipulating the substitution and certainty factor pairs are `subst-record`, which constructs a pair from a set of substitutions and a certainty factor; `subst-list`, which returns the set of bindings from a pair; and `subst-cf`, which returns the certainty factor. Internally, records are represented as dotted pairs, of the form (`<substitution list> . <cf>`). The functions that handle these pairs are:

; Returns the list of variable bindings from a substitution/certainty factor pair.

```
(defun subst-list (substitutions)
  (car substitutions))
```

; Returns the certainty factor from a substitution/certainty factor pair.

```
(defun subst-cf (substitutions)
  (cdr substitutions))
```

; Forms a substitution set/certainty factor pair.

```
(defun subst-record (substitutions cf)
  (cons substitutions cf))
```

Similarly, rules and facts are stored in the knowledge base with an attached certainty factor. Facts are represented as dotted pairs, (*<assertion>*. *<cf>*), where *<assertion>* is a positive literal and *<cf>* is its certainty measure. Rules are in the format (rule if *<premise>* then *<conclusion>* *<cf>*), where *<cf>* is the certainty factor. A sample rule for the domain of recognizing flowers is:

```
(rule
  if (and (rose (var x)) (color (var x) red))
  then (kind (var x) american-beauty) 1)
```

The functions for handling rules and facts are:

; Returns the premise of a rule.

```
(defun premise (rule)
  (nth 2 rule))
```

; Returns the conclusion of a rule.

```
(defun conclusion (rule)
  (nth 4 rule))
```

; Returns the cf of a rule.

```
(defun rule-cf (rule)
  (nth 5 rule))
```

; Tests whether a given pattern is a rule.

```
(defun rulep (pattern)
  (and (listp pattern)
       (equal (nth 0 pattern) 'rule)))
```

; Returns the pattern part of a fact.

```
(defun fact-pattern (fact)
  (car fact))
```

; Returns the cf of a fact.

```
(defun fact-cf (fact)
  (cdr fact))
```

Using these functions, we implement the balance of the rule interpreter through a series of modifications to the logic programming interpreter (Section 10.8).

10.10.2 Architecture of lisp-shell

`solve` is the heart of `lisp-shell`. `solve` does not return a solution stream directly but first passes it through a filter that eliminates any substitutions whose certainty factor is less than 0.2. This prunes results that lack sufficient confidence.

```
(defun solve (goal substitutions)
  (filter-stream
   (if (conjunctive-goal-p goal)
       (filter-through-conj-goals
        (cdr (body goal))
        (solve (car (body goal)) substitutions))
       (solve-simple-goal goal substitutions))
   #'(lambda (x) (< 0.2 (subst-cf x)))))
```

This has changed only slightly from the definition of `solve` in `logic-shell`. It is still a conditional statement that distinguishes between conjunctive goals and simple goals. One difference is the use of the general filter `filter-stream` to prune all solutions whose certainty factor falls below a certain value. This test is passed as a lambda expression that checks whether or not the certainty factor of a substitution set/cf pair is less than 0.2. The other major difference is the use of `solve-simple-goal` in place of `infer`. The treatment of simple goals is complicated by the ability to ask the user for information. We define `solve-simple-goal` as:

```
(defun solve-simple-goal (goal substitutions)
  (declare (special *assertions*))
  (declare (special *case-specific-data*))
  (or (told goal substitutions *case-specific-data*)
      (infer goal substitutions *assertions*)
      (ask-for goal substitutions)))
```

`solve-simple-goal` uses an `or` form to try three different solution strategies in order. First it calls `told` to check whether the goal has already been solved by the user in response to a previous query. User responses are bound to the global variable `*case-specific-data*`; `told` searches this list to try to find a match for the goal. This keeps `lisp-shell` from asking for the same piece of information twice. If this fails, `solve-simple-goal` attempts to infer the goal using the rules in `*assertions*`. Finally, if these fail, it calls `ask-for` to query the user for the information. These functions are defined below.

The top-level `read-solve-print` loop has changed little, except for the inclusion of a statement initializing `*case-specific-data*` to `nil` before solving a new goal. Note that when `solve` is called initially, it is not just passed the empty substitution set, but a pair

consisting of the empty substitution set and a cf of 0. This certainty value has no real meaning: it is included for syntactic reasons until a meaningful substitution set and certainty factor pair is generated by user input or a fact in the knowledge base.

```
(defun lisp-shell ()
  (declare (special *case-specific-data*))
  (setq *case-specific-data* ())
  (prin1 'lisp-shell> ) ; prin1 does not output a new line
  (let ((goal (read)))
    (terpri)
    (cond ((equal goal 'quit) 'bye)
          (t (print-solutions goal (solve goal (subst-record nil 0)))
             (terpri)
             (lisp-shell))))))
```

`filter-through-conj-goals` is not changed, but `filter-through-goal` must compute the certainty factor for a conjunctive expression as the minimum of the certainties of the conjuncts. To do so, it binds the first element of `substitution-stream` to the symbol `subs` in a `let` block. It then calls `solve` on the `goal` and this substitution set; the result is passed through the general mapping function, `map-stream`, which takes the stream of substitution pairs returned by `solve` and recomputes their certainty factors as the minimum of the certainty factor of the result and the certainty factor of the initial substitution set, `subs`. These functions are defined:

```
(defun filter-through conj-goals (goals substitution-stream)
  (if (null goals)
      substitution-stream
      (filter-through-conj-goals
       (cdr goals)
       (filter-through-goal (car goals) substitution-stream))))

(defun filter-through-goal (goal substitution-stream)
  (if (empty-stream-p substitution-stream)
      (make-empty-stream)
      (let ((subs (head-stream substitution-stream)))
        (combine-streams
         (map-stream (solve goal subs)
                     #'(lambda (x) (subst-record (subst-list x)(min (subst-cf x)
                                                                    (subst-cf subs))))
                     (filter-through-goal goal (tail-stream substitution-stream))))))
```

The definition of `infer` has been changed to take certainty factors into account. Although its overall structure reflects the version of `infer` written for the logic programming interpreter, we must now compute the certainty factor for solutions to the goal from the certainty factors of the rule and the certainties of solutions to the rule premise. `solve-rule` calls `solve` to find all solutions to the premise and uses `map-stream` to compute the resulting certainties for the rule conclusion.

```

(defun infer (goal substitutions kb)
  (if (null kb)
      (make-empty-stream)
      (let* ((assertion (rename-variables (car kb)))
             (match (if (rulep assertion)
                        (unify goal conclusion assertion) (subst-list substitutions))
              (unify goal assertion (subst-list substitutions))))
        (if (equal match 'failed)
            (infer goal substitutions (cdr kb))
            (if (rulep assertion)
                (combine-streams
                 (solve-rule assertion (subst-record match (subst-cf substitutions)))
                 (infer goal substitutions (cdr kb)))
                (cons-stream (subst-record match (fact-cf assertion))
                             (infer goal substitutions (cdr kb))))))))))

((defun solve-rule (rule substitutions)
   (map-stream (solve (premise rule) substitutions)
               #'(lambda (x) (subst-record
                             (subst-list x)
                             (* (subst-cf x) (rule-cf rule))))))

```

Finally, `print-solutions` is modified to take certainty factors into account:

```

(defun print-solutions (goal substitution-stream)
  (cond ((empty-stream-p substitution-stream) nil)
        (t (print (apply-substitutions goal (subst-list (head-stream substitution-stream))))
           (write-string "cf =")
           (prin1 (subst-cf (head-stream substitution-stream)))
           (terpri)
           (print-solutions goal (tail-stream substitution-stream))))

```

The remaining functions, such as `apply-substitutions` and functions for accessing components of rules and goals, are unchanged from their definition in Section 10.8.

10.10.3 User Queries and Working Memory

The remainder of `lisp-shell` consists of the functions `ask-for` and `told`, which handle user interactions. These are straightforward, although the reader should note that we have made some simplifying assumptions. In particular, the only response allowed to queries is either “y” or “n.” This causes the binding set passed to `ask-for` to be returned with a `cf` of either 1 or -1, respectively; the user may not give an uncertain response directly to a query. `ask-rec` prints a query and reads the answer, repeating until the answer is either y or n. The reader may expand `ask-rec` to take on any uncertain value within the -1 to 1 range.

`askable` verifies whether the user may be asked for a particular goal. Any asked goal must exist as a pattern in the global list `*askables*`; the architect of an expert system may

in this way determine which goals may be asked and which may only be inferred from the knowledge base. `told` searches through the entries in the global `*case-specific-data*` to find whether the user has already answered a query. It is similar to `infer` except it assumes that everything in `*case-specific-data*` is stored as a fact. We define these functions:

```
(defun ask-for (goal substitutions)
  (declare (special *askables*))
  (declare (special *case-specific-data*))
  (if (askable goal *askables*)
      (let* ((query (apply-substitutions goal (subst-list substitutions)))
             (result (ask-rec query)))
        ((setq *case-specific-data* (cons (subst-record query result)
                                           *case-specific-data*))
         (cons-stream (subst-record (subst-list substitutions) result)
                       (make-empty-stream))))))

(defun ask-rec (query)
  (prin1 query)
  (write-string ">")
  (let ((answer (read)))
    (cond ((equal answer 'y) 1)
          ((equal answer 'n) - 1)
          (t (print "answer must be y or n")
              (terpri)
              (ask-rec query)))))

(defun askable (goal askables)
  (cond ((null askables) nil)
        ((not (equal (unify goal (car askables) ( )) 'failed)) t)
        (t (askable goal (cdr askables)))))

(defun told (goal substitutions case-specific-data)
  (cond ((null case-specific-data) (make-empty-stream))
        (t (combine-streams
             (use-fact goal (car case-specific-data) substitutions)
             (told goal substitutions (cdr case-specific-data))))))
```

This completes the implementation of our LISP-based expert system shell. In the next section we use `lisp-shell` to build a simple classification expert system.

10.10.4 Classification Using `lisp-shell`

We now present a small expert system for classifying trees and bushes. Although it is far from botanically complete, it illustrates the use and behavior of the tool. The knowledge base resides in two global variables: `*assertions*`, which contains the rules and facts of the knowledge base, and `*askables*`, which lists the goals that may be asked of the user. The knowledge base used in this example is constructed by two calls to `setq`:

```

(setq *assertions* '(
  (rule
    if (and (size (var x) tall) (woody (var x)))
    then (tree (var x)) .9)

  (rule
    if (and (size (var x) small) (woody (var x)))
    then (bush (var x)) .9)

  (rule
    if (and (tree (var x)) (evergreen (var x))(color (var x) blue))
    then (kind (var x) spruce) .8)

  (rule
    if (and (tree (var x)) (evergreen (var x))(color (var x) green))
    then (kind (var x) pine) .9)

  (rule
    if (and (tree (var x)) (deciduous (var x)) (bears (var x) fruit))
    then (fruit-tree (var x)) 1)

  (rule
    if (and (fruit-tree (var x)) (color fruit red) (taste fruit sweet))
    then (kind (var x) apple-tree) .9)

  (rule
    if (and (fruit-tree (var x)) (color fruit yellow) (taste fruit sour))
    then (kind (var x) lemon-tree) .8)

  (rule
    if (and (bush (var x)) (flowering (var x)) (thorny (var x)))
    then (rose (var x)) 1)

  (rule
    if (and (rose (var x)) (color (var x) red))
    then (kind (var x) american-beauty) 1)))

(setq *askables* '(
  (size (var x) (var y))
  (woody (var x))
  (soft (var x))
  (color (var x) (var y))
  (evergreen (var x))
  (thorny (var x))
  (deciduous (var x))
  (bears (var x) (var y))
  (taste (var x) (var y))
  (flowering (var x)))

```

A sample run of the trees knowledge base appears below. The reader is encouraged to trace through the rule base to observe the order in which rules are tried, the propagation of certainty factors, and the way in which possibilities are pruned when found to be false:

```
> (lisp-shell)
lisp-shell>(kind tree-1 (var x))
(size tree-1 tall) >y
(woody tree-1) >y
(evergreen tree-1) >y
(color tree-1 blue) >n
color tree-1 green) >y

(kind tree-1 pine) cf 0.81

(deciduous tree-1) >n
(size tree-1 small) >n

lisp-shell>(kind bush-2 (var x))
(size bush-2 tall) >n
(size bush-2 small) >y
(woody bush-2) >y
(flowering bush-2) >y
(thorny bush-2) >y
(color bush-2 red) >y

(kind bush-2 american-beauty) cf 0.9

lisp-shell>(kind tree-3 (var x))
(size tree-3 tall) >y
(woody tree-3) >y
(evergreen tree-3) > n
(deciduous tree-3) >y
(bears tree-3 fruit) >y
(color fruit red) >n
(color fruit yellow) >y
(taste fruit sour) >y

(kind tree-3 lemon-tree) cf 0.7200000000000001

(size tree-3 small) >n

lisp-shell>quit

bye
?
```

In this example, several anomalies may be noted. For example, the shell occasionally asks whether a tree is small even though it was told the tree is tall, or it asks whether the

tree is deciduous even though the tree is an evergreen. This is typical of the behavior of expert systems. The knowledge base does not know anything about the relationship between tall and small or evergreen and deciduous: they are just patterns to be matched. Because the search is exhaustive, all rules are tried. If a system is to exhibit deeper knowledge than this, the relationships must be coded in the knowledge base. For example, a rule may be written that states that small implies not tall. In this example, lisp-shell is not capable of representing these relationships because we have not implemented the not operator. This extension is left as an exercise.

10.11 Network Representations and Inheritance

This section introduces the implementation of semantic networks in LISP. As a family of representations, semantic networks provide a basis for a large variety of inferences; we do not discuss all of these, but focus on a basic approach to constructing network representations using *property lists*. After these are discussed and used to define a simple semantic network, we define a function for class inheritance. The ideas illustrated in this section are important precursors of the object-oriented programming techniques of Section 10.12.

10.11.1 Representing Semantic Nets in LISP

LISP is a convenient language for representing any graph structure, including semantic nets. Lists provide the ability to create computational objects of arbitrary complexity and these objects may be bound to names, allowing for easy reference and the definition of relationships between them. Indeed, all LISP data structures are based on an internal implementation as chains of pointers, a natural isomorph to graph structures.

For example, labeled graphs may be represented using association lists: each node is an entry in an association list with all the arcs out of that node stored in the datum of the node as a second association list. Arcs are described by an association list entry that has the arc name as its key and the arc destination as its datum. Using this representation, the built-in association list functions are used to find the destination of a particular arc from a given node. For example, the labeled, directed graph of Figure 10.7 is represented by the association list:

```
((a (1 . b))  
 (b (2 . c))  
 (c (2 . b) (3 . a)))
```

This approach is the basis of many network implementations. Another way to implement semantic networks is through the use of *property lists*.

Essentially, property lists are a built-in feature of LISP that allow named relationships to be attached to symbols. Rather than using `setq` to bind an association list to a symbol,

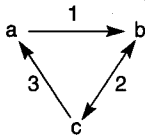

Figure 10.7 A simple labeled directed graph.

with property lists we can program the direct attachment of named attributes to objects in the global environment. These are bound to the symbol not as a **value** but as an additional component called the property list.

Functions for managing property lists are **get**, **setf**, **remprop**, and **symbol-plist**. **get**, which has the syntax

```
(get <symbol> <property-name>)
```

retrieves a property from <symbol> by its <property-name>. For example, if the symbol **rose** has a **color** property of **red** and a **smell** property of **sweet**, then **get** would have the behavior:

```
(get 'rose 'color)
red
(get 'rose 'smell)
sweet
(get 'rose 'party-affiliation)
nil
```

As the last of these calls to **get** illustrates, if an attempt is made to retrieve a nonexistent property, one that is not on the property list, **get** returns a value of **nil**.

Properties are attached to objects using the **setf** function, which has the syntax:

```
(setf <form> <value>)
```

setf is a generalization of **setq**. The first argument to **setf** is taken from a large but specific list of forms that evaluate to a memory location. This list includes such forms as **car** and **cdr**. **setf** places the value of its second argument in that location. For example, we may use **setf** along with list functions to modify lists in the global environment, as the following transcript shows:

```
? (setq x '(a b c d e))
(a b c d e)
? (setf (nth 2 x) 3)
3
```

```
? x  
(a b 3 d e)
```

We use `setf`, along with `get`, to change the value of properties. For instance, we may define the properties of a rose by:

```
> (setf (get 'rose 'color) 'red)  
red  
> (setf (get 'rose 'smell) 'sweet)  
sweet
```

`remprop` takes as arguments a symbol and a property name and causes a named property to be deleted. For example:

```
> (get 'rose 'color)  
red  
> (remprop 'rose 'color)  
color  
> (get 'rose 'color)  
nil
```

`symbol-plist` takes as argument a symbol and returns its property list. For example:

```
> (setf (get 'rose 'color) 'red)  
red  
> (setf (get 'rose 'smell) 'sweet)  
sweet  
> (plist 'rose)  
(smell sweet color red)
```

Using property lists, it is straightforward to implement a semantic network. For example, the following calls to `setf` implement the semantic network description of species of birds from Figure 9.7. The `isa` relations define inheritance links.

```
(setf (get 'animal 'covering) 'skin)  
(setf (get 'bird 'covering) 'feathers)  
(setf (get 'bird 'travel) 'flies)  
(setf (get 'bird 'isa) animal)  
(setf (get 'fish 'isa) animal)  
(setf (get 'fish 'travel) 'swim)  
(setf (get 'ostrich 'isa) 'bird)  
(setf (get 'ostrich 'travel) 'walk)  
(setf (get 'penguin 'isa) 'bird)  
(setf (get 'penguin 'travel) 'walk)  
(setf (get 'penguin 'color) 'brown)  
(setf (get 'opus 'isa) 'penguin)  
(setf (get 'canary 'isa) 'bird)
```

```
(setf (get 'canary 'color) 'yellow)
(setf (get 'canary 'sound) 'sing)
(setf (get 'tweety 'isa) 'canary)
(setf (get 'tweety 'color) 'white)
(setf (get 'robin 'isa) 'bird)
(setf (get 'robin 'sound) 'sings)
(setf (get 'robin 'color) 'red)
```

10.11.2 Implementing Inheritance

Using this representation of semantic nets, we now define hierarchical inheritance. This is simply a search along `isa` links until a parent is found with the desired property. The parents are searched in a depth-first fashion, and search stops when an instance of the property is found. This is typical of the inheritance algorithms provided by many commercial systems. Variations on this approach include the use of breadth-first search as a search strategy.

`inherit-get` is a variation of `get` that first tries to retrieve a property from a symbol; if this fails, `inherit-get` calls `get-from-parents` to implement the search. `get-from-parents` takes as its first argument either a single parent or a list of parents; the second argument is a property name. If the parameter `parents` is `nil`, the search halts with failure. If `parents` is an atom, it calls `inherit-get` on the parent to either retrieve the property from the parent itself or continue the search. If `parents` is a list, `get-from-parents` calls itself recursively on the `car` and `cdr` of the list of parents. These functions are defined:

```
(defun inherit-get (object property)
  (or (get object property)
      (get-from-parents (get object 'isa) property)))

(defun get-from-parents (parents property)
  (cond ((null parents) nil)
        ((atom parents) (inherit-get parents property))
        (t (or (get-from-parents (car parents) property)
                (get-from-parents (cdr parents) property)))))
```

10.12 Object-Oriented Programming Using CLOS

In spite of the many advantages of functional programming, some problems are best conceptualized in terms of objects that have a state that changes over time. Simulation programs are typical of this. Imagine trying to build a program that will predict the ability of a steam heating system to heat a large building: we can simplify the problem by thinking of it as a system of objects (rooms, thermostats, boilers, steam pipes, etc.) that interact to change the temperature and behavior of each other over time. Object-oriented languages support an approach to problem solving that lets us decompose a problem into

interacting objects. These objects have a state that can change over time, and a set of functions or methods that define the object's behaviors. Essentially, object-oriented programming lets us solve problems by constructing a model of the problem domain as we understand it. This model-based approach to problem solving is a natural fit for artificial intelligence, an effective programming methodology in its own right, and a powerful tool for thinking about complex problem domains.

There are a number of languages that support object-oriented programming. Some of the most important are Smalltalk, C++, Java and the Common LISP Object System (CLOS). At first glance, LISP, with its roots in functional programming, and object orientation, with its emphasis on creating objects that retain their state over time, may seem worlds apart. However, many features of the language, such as dynamic type checking and the ability to create and destroy objects dynamically, make it an ideal foundation for constructing an object-oriented language. Indeed, LISP was the basis for many of the early object-oriented languages, such as Flavors, KEE, and ART. As the Common LISP standard was developed, the LISP community has accepted CLOS as the preferred way to do object-oriented programming in LISP.

In order to fully support the needs of object-oriented programming, a programming language must provide three capabilities: 1) *encapsulation*, 2) *polymorphism*, and 3) *inheritance*. The remainder of this introduction defines these capabilities and gives an introduction to the way in which CLOS supports them.

1. Encapsulation. All modern programming languages allow us to create complex data structures that combine atomic data items into a single entity. Object-oriented encapsulation is unique in that it combines both data items and the procedures used for their manipulation into a single structure, called a *class*. In some object-oriented languages, such as Smalltalk, the encapsulation of procedures (or methods as they are called in the object-oriented community) in the object definition is explicit. CLOS takes a different approach, using LISP's type-checking to provide this same ability. CLOS implements methods as *generic functions*. These functions check the type their parameters to guarantee that they can only be applied to instances of a certain object class. This gives us a logical binding of methods to their objects.

2. Polymorphism. The word polymorphic comes from the roots "poly," meaning *many*, and "morph," meaning *form*. A function is polymorphic if it has many different behaviors, depending on the types of its arguments. Perhaps the most intuitive example of polymorphic functions and their importance is a simple drawing program. Assume that we define objects for each of the shapes (square, circle, line) that we would like to draw. A natural way to implement this is to define a method named **draw** for each object class. Although each individual method has a different definition, depending on the shape it is to draw, all of them have the same name. Every shape in our system has a **draw** behavior. This is much simpler and more natural, than to define a differently named function (draw-square, draw-circle, etc.) for every shape. CLOS supports polymorphism through generic functions. A generic function is one whose behavior is determined by the types of its arguments. In our drawing example, CLOS would enable us to define a generic function, **draw**, that would include code for drawing each of the shapes defined in the

program. On evaluation, it would check the type of its argument and automatically execute the appropriate code.

3. Inheritance. Inheritance is a mechanism for supporting class abstraction in a programming language. It lets us define general classes that specify the structure and behavior of their specializations, just as the class “tree” defines the essential attributes of pine trees, poplars, oaks, and other different species. In Section 10.11, we built an inheritance algorithm for semantic networks; this demonstrated the ease of implementing inheritance using LISP’s built-in data structuring techniques. CLOS provides us with a more robust, expressive, built-in inheritance algorithm.

10.12.1 Defining Classes and Instances in CLOS

The basic data structure in CLOS is the class. A class is a specification for a set of like object instances. We define classes using the `defclass` macro. `defclass` has the syntax:

```
(defclass <class-name> (<superclass-name>*)
  (<slot-specifier>*))
```

`<class-name>` is a symbol. Following the class name is a list of direct superclasses; these are the class’s immediate parents in the inheritance hierarchy. This list may be empty. Following the list of parent classes is a list of zero or more slot specifiers. A slot specifier is either the name of a slot or a list consisting of a slot name and zero or more slot options:

```
slot-specifier ::= slotname | (slot-name [slot-option])
```

For instance, we may define a class, `rectangle`, which has slots for `length` and `width`, by:

```
> (defclass rectangle()
  (length width))
```

```
#<standard-class rectangle>
```

`make-instance` allows us to create instances of a class, taking as its argument a class name and returning an instance of that class. It is the instances of a class that actually store data values. We may bind a symbol, `rect`, to an instance of `rectangle` using `make-instance` and `setq`:

```
> (setq rect (make-instance 'rectangle))
#<rectangle #x286AC1>
```

The slot options in a `defclass` define optional properties of slots. Slot options have the syntax (where “|” indicates alternative options):

```

slot-option ::= :reader <reader-function-name> |
               :writer <writer-function-name> |
               :accessor <reader-function-name> |
               :allocation <allocation-type> |
               :initarg <initarg-name> |
               :initform <form>

```

We declare slot options using keyword arguments. Keyword arguments are a form of optional parameter in a LISP function. The keyword, which always begins with a “:”, precedes the value for that argument. Available slot options include those that provide accessors to a slot. The `:reader` option defines a function called `reader-function-name` that returns the value of a slot for an instance. The `:writer` option defines a function named `writer-function-name` that will write to the slot. `:accessor` defines a function that may read a slot value or may be used with `self` to change its value. In the following transcript, we define `rectangle` to have slots for `length` and `width`, with slot accessors `get-length` and `get-width`, respectively. After binding `rect` to an instance of `rectangle` using `make-instance`, we use the accessor, `get-length`, with `self` to bind the `length` slot to a value of 10. Finally, we use the accessor to read this value.

```

> (defclass rectangle ()
  ((length :accessor get-length)
   (width :accessor get-width)))
#<standard-class rectangle>
> (setq rect (make-instance 'rectangle))
#<rectangle #x289159>
> (self (get-length rect) 10)
10
> (get-length rect)
10

```

In addition to defining accessors, we can access a slot using the primitive function `slot-value`. `slot-value` is defined for all slots; it takes as arguments an instance and a slot name and returns the value of that slot. We can use it with `self` to change the slot value. For example, we could use `slot-value` to access the `width` slot of `rect`:

```

> (self (slot-value rect 'width) 5)
5
> (slot-value rect 'width)
5

```

`:allocation` lets us specify the memory allocation for a slot. `allocation-type` may be either `:instance` or `:class`. If allocation type is `:instance`, then CLOS allocates a local slot for each instance of the type. If allocation type is `:class`, then all instances share a single location for this slot. In class allocation, all instances will share the same value of the slot; changes made to the slot by any instance will affect all other instances. If we omit the `:allocation` specifier, allocation defaults to `:instance`.

`:initarg` allows us to specify an argument that we can use with `make-instance` to specify an initial value for a slot. For example, we can modify our definition of `rectangle` to allow us to initialize the `length` and `width` slots of instances:

```
> (defclass rectangle ()
  ((length :accessor get-length :initarg init-length)
   (width :accessor get-width :initarg init-width)))
#<standard-class rectangle>
>(setq rect (make-instance 'rectangle 'init-length 100 'init-width 50))
#<rectangle #x28D081>
> (get-length rect)
100
> (get-width rect)
50
```

`:initform` lets us specify a form that CLOS evaluates on each call to `make-instance` to compute an initial value of the slot. For example, if we would like our program to ask the user for the values of each new instance of `rectangle`, we may define a function to do so and include it in an `initform`:

```
> (defun read-value (query) (print query)(read))
read-value
> (defclass rectangle ()
  ((length :accessor get-length :initform (read-value "enter length"))
   (width :accessor get-width :initform (read-value "enter width"))))
#<standard-class rectangle>
> (setq rect (make-instance 'rectangle))

"enter length" 100

"enter width" 50
#<rectangle #x290461>
> (get-length rect)
100
> (get-width rect)
50
```

10.12.2 Defining Generic Functions and Methods

A generic function is a function whose behavior depends upon the type of its arguments. In CLOS, generic functions contain a set of *methods*, indexed by the type of their arguments. We call generic functions with a syntax like that of regular functions; the generic function retrieves and executes the method associated with the type of its parameters.

CLOS uses the structure of the class hierarchy in selecting a method in a generic function; if there is no method defined directly for an argument of a given class, it uses the

method associated with the “closest” ancestor in the hierarchy. Generic functions provide most of the advantages of “purer” approaches of methods and message passing, including inheritance and overloading. However, they are much closer in spirit to the functional programming paradigm that forms the basis of LISP. For instance, we can use generic functions with `mapcar`, `funcall`, and other higher-order constructs in the LISP language.

We define generic functions using either `defgeneric` or `defmethod`. `defgeneric` lets us define a generic function and several methods using one form. `defmethod` enables us to define each method separately, although CLOS combines all of them into a single generic function.

`defgeneric` has the (simplified) syntax:

```
(defgeneric f-name lambda-list <method-description>*)
```

where

```
<method-description> ::= (:method specialized-lambda-list form)
```

`defgeneric` takes a name of the function, a lambda list of its arguments, and a series of zero or more method descriptions. In a method description, `specialized-lambda-list` is just like an ordinary lambda list in a function definition, except that a formal parameter may be replaced with a (symbol parameter-specializer) pair: `symbol` is the name of the parameter, and `parameter-specializer` is the class of the argument. If an argument in a method has no parameter specializer, its type defaults to `t`, which is the most general class in a CLOS hierarchy. Parameters of type `t` can bind to any object. The specialized lambda list of each method specifier must have the same number of arguments as the lambda list in the `defgeneric`. A `defgeneric` creates a generic function with the specified methods, replacing any existing generic functions.

As an example of a generic function, we may define classes for rectangles and circles and implement the appropriate methods for finding areas:

```
(defclass rectangle ()
  ((length :accessor get-length :initarg init-length)
   (width :accessor get-width :initarg init-width)))

(defclass circle ()
  ((radius :accessor get-radius :initarg init-radius)))

(defgeneric area (shape)
  (:method ((shape rectangle)
            (* (get-length shape)
              (get-width shape)))
   (:method ((shape circle)
            (* (get-radius shape) (get-radius shape) pi)))

(setq rect (make-instance 'rectangle 'init-length 10 'init-width 5))

(setq circ (make-instance 'circle 'init-radius 7))
```

We can use the `area` function to compute the area of either shape:

```
> (area rect)
50
> (area circ)
153.93804002589985
```

We can also define methods using `defmethod`. Syntactically, `defmethod` is similar to `defun`, except it uses a specialized lambda list to declare the class to which its arguments belong. When we define a method using `defmethod`, if there is no generic function with that name, `defmethod` creates one; if a generic function of that name already exists, `defmethod` adds a new method to it. For example, we could add the class `square` to the above definitions by:

```
(defclass square ()
  ((side :accessor get-side :initarg init-side)))

(defmethod area ((shape square))
  (* (get-side shape)
     (get-side shape)))

(setq sqr (make-instance 'square 'init-side 6))
```

`defmethod` does not change the previous definitions of the `area` function; it simply adds a new method to the generic function:

```
> (area sqr)
36
> (area rect)
50
> (area circ)
153.93804002589985
```

10.12.3 Inheritance in CLOS

CLOS is a multiple-inheritance language. As we have discussed in some detail (see Section 8.5), multiple inheritance introduces the potential for anomalies when inheriting slots and methods: if two or more ancestors have defined the same method, it is crucial to know which method any instance of those ancestors will inherit. CLOS resolves potential ambiguities by defining a *class precedence* list, which is a total ordering of all classes within a class hierarchy.

Each `defclass` lists the direct parents of a class in left-to-right order. Using the order of direct parents for each class, CLOS computes a partial ordering of all the ancestors in the inheritance hierarchy. From this partial ordering, it derives the total ordering of the class precedence list through a topological sort.

The class precedence list follows two simple rules:

1. Any direct parent class precedes any more distant ancestor.
2. In the list of immediate parents in `defclass`, each class precedes those to the right of it.

CLOS computes the class precedence list for an object by topologically sorting its ancestor classes according to the following algorithm. Let C be the class for which we are defining the precedence list:

1. Let S_c be the set of C and all its superclasses.
2. For each class, c , in S_c , define the set of ordered pairs:

$$R_c = \{(c, c_1), (c_1, c_2), (c_2, c_3) \dots (c_{n-1}, c_n)\}$$

where c_1 through c_n are the direct parents of c in the order they are listed in `defclass`. Note that each R_c defines a total order.

3. Let R be the union of the R_c s for all elements of S_c . R may or may not define a partial ordering. If it does not define a partial ordering, then the hierarchy is inconsistent and the algorithm will detect this.
4. Topologically sort the elements of R by:
 - 4.1 Begin with an empty precedence list, P .
 - 4.2 Find a class in R having no predecessors. Add it to the end of P and remove the class from S_c and all pairs containing it from R . If there are several classes in S_c with no predecessor, select the one that has a direct subclass nearest the end in the current version of P .
 - 4.3 Repeat steps 4.1 and 4.2 until no element can be found that has no predecessor in R .
5. If S_c is not empty, then the hierarchy is inconsistent; it may contain ambiguities that cannot be resolved using this technique.

Because the resulting precedence list is a total ordering, it resolves any ambiguous orderings that may have existed in the class hierarchy. CLOS uses the class precedence list in the inheritance of slots and the selection of methods.

In selecting a method to apply to a given call of a generic function, CLOS first selects all applicable methods. A method is applicable to a generic function call if each parameter specializer in the method is consistent with the corresponding argument in the generic function call. A parameter specializer is consistent with an argument if the specializer either matches the class of the argument or the class of one of its ancestors.

CLOS then sorts all applicable methods using the precedence lists of the arguments. CLOS determines which of two methods should come first in this ordering by comparing

their parameter specializers in a left-to-right fashion. If the first pair of corresponding parameter specializers are equal, CLOS compares the second, continuing in this fashion until it finds corresponding parameter specializers that are different. Of these two, it designates as more specific the method whose parameter specializer appears leftmost in the precedence list of the corresponding argument.

After ordering all applicable methods, the default method selection applies the most specific method to the arguments. For more details, see Steele (1990).

10.12.4 Advanced Features of CLOS

CLOS is an extremely complex language, and we have described only a few of its features. For instance, most of CLOS's functionality is defined in a set of objects called *meta-classes*. All classes belong to a meta-class. The behavior of classes, such as the inheritance algorithm described above, is defined in the meta-class. In CLOS, these meta-classes are open to the programmer, allowing bold individuals to modify the semantics of the language.

Another interesting feature of the language is the ability to combine methods. Whereas the default method inheritance simply uses the first method encountered in the precedence list, CLOS lets us specify method combinations. These allow us to select components of a method from different classes in the hierarchy and evaluate them in order. This technique augments the opportunities for abstraction provided by simple method inheritance; we can abstract out common portions of a method and place them high in the hierarchy, implementing more specialized aspects of a method lower in the hierarchy.

Though space limitations prevent us from discussing these and other features, we have presented the most important aspects of CLOS. These sections capture the heart of the language and are sufficient for most implementations.

10.12.5 Example: A Thermostat Simulation

The properties of object-oriented programming that make it a natural way to organize large and complex software implementations are equally applicable in the design of knowledge bases. In addition to the benefits of class inheritance for representing taxonomic knowledge, the message-passing aspect of object-oriented systems simplifies the representation of interacting components.

As a simple example, consider the task of modeling the behavior of a steam heater for a small office building. We may naturally view this problem in terms of interacting components. For example:

Each office has a thermostat that turns the heat in that office on and off; this functions independently of the thermostats in other offices.

The boiler for the heating plant turns itself on and off in response to the heat demands made by the offices.

When the demand on the boiler increases, there may be a time lag while more steam is generated.

Different offices place different demands on the system; for example, corner offices with large windows lose heat faster than inner offices. Inner offices may even gain heat from their neighbors.

The amount of steam that the system may route to a single office is affected by the total demand on the system.

These points are only a few of those that must be taken into account in modeling the behavior of such a system; the possible interactions are extremely complex. An object-oriented representation allows the programmer to focus on describing one class of objects at a time. We would represent thermostats, for example, by the temperature at which they call for heat, along with the speed with which they respond to changes in temperature.

The steam plant could be characterized in terms of the maximum amount of heat it can produce, the amount of fuel used as a function of heat produced, the amount of time it takes to respond to increased heat demand, and the rate at which it consumes water.

A room could be described in terms of its volume, the heat loss through its walls and windows, the heat gain from neighboring rooms, and the rate at which the radiator adds heat to the room.

The knowledge base is built up of classes such as `room` and `thermostat`, which define the properties of the class, and instances such as `room-322` and `thermostat-211`, which model individuals.

The interactions between components are described by messages between instances. For example, a change in room temperature would cause a message to be sent to an instance of the class `thermostat`. If this new temperature is low enough, the thermostat would switch after an appropriate delay. This would cause a message to be sent to the steam plant requesting more heat. This would cause the steam plant to consume more oil, or, if the plant is already operating at maximum capacity, to route some heat away from other rooms to respond to the new demand. This would cause other thermostats to trip, and so on.

Using this simulation, we can test the ability of the system to respond to external changes in temperature, measure the effect of heat loss, or determine whether the projected heating is adequate. We could use this simulation in a diagnostic program to verify that a hypothesized fault could indeed produce a particular set of symptoms. For example, if we have reason to believe that a heating problem is caused by a blocked steam pipe, we could introduce such a fault into the simulation and see whether it produces the observed symptoms.

The significant thing about this example is the way in which an object-oriented approach allows knowledge engineers to deal with the complexity of the simulation. It enables them to build the model a piece at a time, focusing only on the behaviors of simple classes of objects. The full complexity of the system behavior emerges when we execute the model.

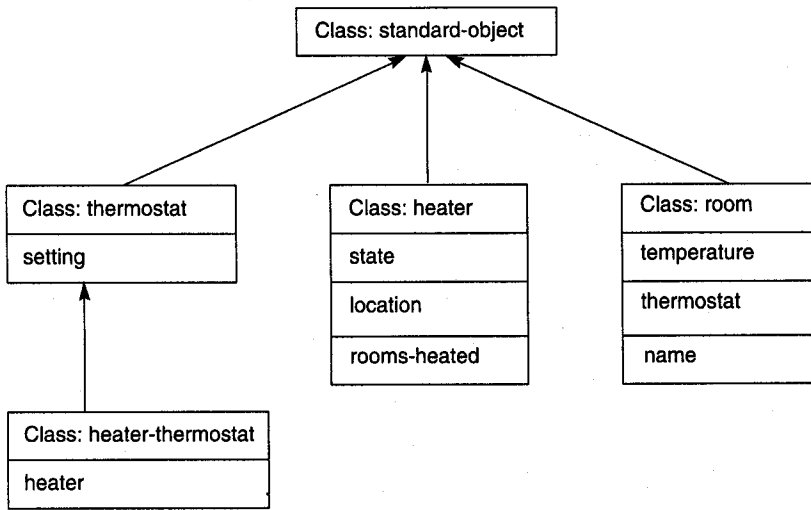

Figure 10.8 Class hierarchy for thermostat simulation.

The basis of our CLOS implementation of this model is a set of object definitions. Thermostats have a single slot called **setting**. The setting of each instance is initialized to 65 using `initform`. `heater-thermostats` are a subclass of `thermostat` for controlling heaters (as opposed to air conditioners); they have a single slot that will be bound to an instance of the `heater` class. Note that the heater slot has a class allocation; this captures the constraint that thermostats in different rooms of a building control the same heater.

```
(defclass thermostat ()
  ((setting :initform 65
            :accessor therm-setting)))
```

```
(defclass heater-thermostats (thermostat)
  ((heater :allocation :class
          :initarg heater-obj)))
```

A `heater` has a `state` (on or off) which is initialized to off, and a `location`. It also has a slot, `rooms-heated`, that will be bound to a list of objects of type `room`. Note that instances, like any other structure in LISP, may be elements of a list.

```
(defclass heater ()
  ((state :initform 'off
         :accessor heater-state)
   (location :initarg loc)
   (rooms-heated)))
```

`room` has slots for `temperature`, initialized to 65 degrees; `thermostat`, which will be bound to an instance of `thermostat`; and `name`, the name of the room.

```
(defclass room ()
  ((temperature :initform 65
                :accessor room-temp)
   (thermostat :initarg therm
                :accessor room-thermostat)
   (name :initarg name
         :accessor room-name)))
```

These class definitions define the hierarchy of Figure 10.8.

We represent our particular simulation as a set of instances of these classes. We will implement a simple system of one room, one heater, and one thermostat:

```
(setf office-heater (make-instance 'heater 'loc 'office))
(setf room-325 (make-instance 'room
                             'therm (make-instance 'heater-thermostats
                                                  'heater-obj office-heater)
                             'name 'room-325))
(setf (slot-value office-heater 'rooms-heated) (list room-325))
```

Figure 10.9 shows the definition of instances, the allocation of slots, and the bindings of slots to values.

We define the behavior of rooms through the methods `change-temp`, `check-temp`, and `change-setting`. `change-temp` sets the temperature of a room to a new value, prints a message to the user, and calls `check-temp` to determine whether the heater should come on. Similarly, `change-setting` changes the thermostat setting and calls `check-temp`. `check-temp` simulates the thermostat. If the temperature of the room is less than the setting of the thermostat, it sends the heater a message to turn on; otherwise it sends the heater an “off” message.

```
(defmethod change-temp ((place room) temp-change)
  (let ((new-temp (+ (room-temp place) temp-change)))
    (setf (room-temp place) new-temp)
    (terpri)
    (prin1 "the temperature in")
    (prin1 (room-name place))
    (prin1 " is now ")
    (prin1 new-temp)
    (terpri)
    (check-temp place)))
(defmethod change-setting ((room room) new-setting)
  (let ((therm (room-thermostat room)))
    (setf (therm-setting therm) new-setting)
    (prin1 "changing setting of thermostat in")
    (prin1 (room-name room))
    (prin1 " to ")
    (prin1 new-setting)
    (terpri)
    (check-temp room)))
```

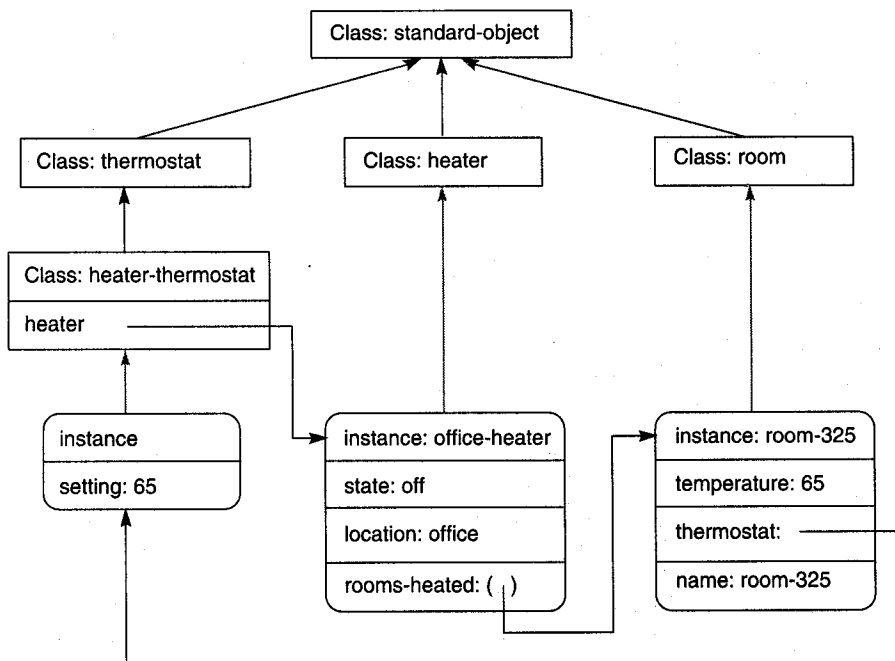

Figure 10.9 Thermostat simulation showing instances, initial values and slot allocation.

```

(defmethod check-temp ((room room))
  (let* ((therm (room-thermostat room))
        (heater (slot-value therm 'heater)))
    (cond ((> (therm-setting therm) (room-temp room))
          (send-heater heater 'on))
          (t (send-heater heater 'off)))))
  
```

The heater methods control the state of the heater and change the temperature of the rooms. `send-heater` takes as arguments an instance of heater and a message, `new-state`. If `new-state` is `on` it calls the `turn-on` method to start the heater; if `new-state` is `off` it shuts the heater down. After turning the heater on, `send-heater` calls `heat-rooms` to increase the temperature of each room by one degree.

```

(defmethod send-heater ((heater heater) new-state)
  (case new-state
    (on (if (equal (heater-state heater) 'off)
            (turn-on heater)
            (heat-rooms (slot-value heater 'rooms-heated) 1))
        (off (if (equal (heater-state heater) 'on)
                 (turn-off heater)))))
  
```



```
(defmethod turn-on ((heater heater))
  (setf (heater-state heater) 'on)
  (prin1 "turning on heater in")
  (prin1 (slot-value heater 'location))
  (terpri))
```

```
(defmethod turn-off ((heater heater))
  (setf (heater-state heater) 'off)
  (prin1 "turning off heater in")
  (prin1 (slot-value heater 'location))
  (terpri))
```

```
(defun heat-rooms (rooms amount)
  (cond ((null rooms) nil)
        (t (change-temp (car rooms) amount)
            (heat-rooms (cdr rooms) amount))))
```

The following transcript illustrates the behavior of the simulation.

```
> (change-temp room-325 -5)
```

```
"the temperature in "room-325" is now "60
"turning on heater in "office
```

```
"the temperature in "room-325" is now "61
```

```
"the temperature in "room-325" is now "62
```

```
"the temperature in "room-325" is now "63
```

```
"the temperature in "room-325" is now "64
```

```
"the temperature in "room-325" is now "65
"turning off heater in "office
nil
```

```
> (change-setting room-325 70)
```

```
"changing setting of thermostat in "room-325" to "70
"turning on heater in "office
```

```
"the temperature in "room-325" is now "66
```

```
"the temperature in "room-325" is now "67
```

```
"the temperature in "room-325" is now "68
```

```
"the temperature in "room-325" is now "69
```

```
"the temperature in "room-325" is now "70
"turning off heater in "office
nil
```

10.13 Epilogue and References

Both PROLOG and LISP are based on formal mathematical models of computation: PROLOG on logic and theorem proving, LISP on the theory of recursive functions. This sets these languages apart from more traditional languages whose architecture is just a refinement of the architecture of the underlying computing hardware. By deriving their syntax and semantics from mathematical notations, LISP and PROLOG inherit both expressive power and clarity.

Although PROLOG, the newer of the two languages, has remained close to its theoretical roots, LISP has been extended until it is no longer a purely functional programming language. LISP is, above all, a practical programming language that has grown to support the full range of modern techniques. These techniques include functional programming, data abstraction, stream processing, delayed evaluation, and object-oriented programming.

The strength of LISP, then, is that it has built up a range of modern programming techniques as extensions of its core model of functional programming. This set of techniques, combined with the power of lists to create a variety of symbolic data structures, forms the basis of modern LISP programming. We hope this chapter has helped to illustrate that style.

In designing the algorithms of this chapter, we have been influenced by Abelson and Sussman's book *The Structure and Interpretation of Computer Programs* (1985). Steele (1990) is an essential guide to using Common LISP. Valuable tutorials on LISP programming include *Common LISP: A Gentle Introduction to Symbolic Computation* (Touretzky 1990), *Common LISP Programming for Artificial Intelligence* (Hasemer and Domingue 1989), and *On LISP: Advanced Techniques for Common LISP* (Graham 1994).

A number of books explore the use of LISP in the design of AI problem solvers. *Building Problem Solvers* (Forbus and deKleer 1993) is an encyclopedic treatment of AI algorithms in LISP and an invaluable reference for AI practitioners. Also, see any of a number of general AI texts that take a more LISP-centered approach to the basic material, including *Artificial Intelligence with Common LISP* (Noyes 1992) and *The Elements of Artificial Intelligence Using Common LISP* by Steven Tanimoto (1990).

10.14 Exercises

1. Newton's method for solving roots takes an estimate of the value of the root and tests it for accuracy. If the guess does not meet the required tolerance, it computes a new estimate and repeats. Pseudo-code for using Newton's method to take the square root of a number is:

function root-by-newtons-method (x, tolerance)

```
begin
  guess := 1;
  repeat
    guess := 1/2(guess + x/guess)
  until absolute-value(x - guess*guess) < tolerance
```

Write a recursive LISP function to compute square roots by Newton's method.

2. a. Write a recursive LISP function that will reverse the elements of a list. (Do not use the built-in `reverse` function.) What is the complexity of your implementation? It is possible to reverse a list in linear time; can you do so?
- b. Write a LISP function that will take a list nested to any depth and print the mirror image of that list. For instance, the function should have the behavior:

```
> (mirror '((a b) (c (d e))))
(((e d) c) (b a))
```

3. Write a random number generator in LISP. This function must maintain a global variable, `seed`, and return a different random number each time the function is called. For a description of a reasonable random number algorithm, consult any basic algorithms text.
4. Write the functions `initialize`, `push`, `top`, `pop`, and `list-stack` to maintain a global stack. These functions should behave:

```
> (initialize)
nil
> (push 'foo)
foo
> (push 'bar)
bar
> (top)
bar
> (list-stack)
(bar foo)
> (pop)
bar
> (list-stack)
(foo)
```

5. Sets may be represented using lists. Note that these lists should not contain any duplicate elements. Write your own LISP implementations of the set operations of `union`, `intersection`, and `set difference`. (Do not use Common LISP's built-in versions of these functions.)
6. The towers of Hanoi problem is based on the following legend:

In a Far Eastern monastery, there is a puzzle consisting of three diamond needles and 64 gold disks. The disks are of graduated sizes. Initially, the disks are all stacked on a

single needle in decreasing order of size. The monks are attempting to move all the disks to another needle under the following rules:

- a. Only one disk may be moved at a time.
- b. No disk can ever rest on a smaller disk.

Legend has it that when the task has been completed, the universe will end.

Write a LISP program to solve this problem. For safety's sake (and to write a program that will finish in your lifetime) do not attempt the full 64-disk problem. Three or four disks is more reasonable.

7. Write a compiler for arithmetic expressions of the form:

(op operand1 operand2)

where op is either +, -, *, or / and the operands are either numbers or nested expressions. An example of a legal expression is (* (+ 3 6) (- 7 9)). Assume that the target machine has instructions:

(move value register)
(add register-1 register-2)
(subtract register-1 register-2)
(times register-1 register-2)
(divide register-1 register-2) ^^|

All the arithmetic operations will leave the result in the first register argument. To simplify, assume an unlimited number of registers. Your compiler should take an arithmetic expression and return a list of these machine operations.

8. Implement a depth-first backtracking solution (such as was used to solve the farmer, wolf, goat, and cabbage problem in Section 10.2) to the missionary and cannibal problem:

Three missionaries and three cannibals come to the bank of a river they wish to cross. There is a boat that will hold only two people, and any of the group is able to row it. If there are ever more missionaries than cannibals on any side of the river the cannibals will get converted. Devise a series of moves to get all the people across the river with no conversions.

9. Implement a depth-first solution to the water jugs problem:

There are two jugs, one holding 3 gallons and the other 5 gallons of water. A number of things that can be done with the jugs: they can be filled, emptied, and dumped one into the other either until the poured-into jug is full or until the poured-out-of jug is empty. Devise a sequence of actions that will produce 4 gallons of water in the larger jug. (Hint: only integer values of water are used.)

10. Implement build-solution and eliminate-duplicates for the breadth-first search algorithm of Section 10.3.
11. Use the breadth-first search algorithm of Exercise 10 to solve:
- a. The farmer, wolf, goat, and cabbage problem (see Section 10.2).
 - b. The missionary and cannibal problem (see Exercise 8).
 - c. The water jugs problem (see Exercise 9).

Compare the breadth-first results to the depth-first results. The differences will probably be the most telling for the water jugs problem. Why?

12. Finish implementing best-first search using the general path algorithm described in Section 10.3.3. Use this along with appropriate heuristics to solve each of the three problems mentioned in Exercise 11.
13. Write a LISP program to solve the 8-queens problem. (This problem is to find a way to place eight queens on a chessboard so that no queen may capture any other through a single move, i.e., no two queens are on the same row, column, or diagonal.)
14. Write a LISP program to solve the full 8×8 version of the knight's tour problem.
15. Although we have implemented breadth-first and best-first search using a recursive function, these algorithms are suited to an iterative implementation. Using the generalized looping function `do` (see a LISP manual for its definition), implement iterative versions of these functions.
16. The implementations of breadth-first, depth-first, and best-first search using `open` and `closed` lists are all very similar; they differ only in the way in which `open` is maintained. Write a general search function that can implement any of these three searches by defining the function for maintaining `open` as a parameter.
17. Rewrite `print-solutions` in the logic programming interpreter so that it prints the first solution and waits for a user response (such as a carriage return) before printing the second solution.
18. Modify the logic programming interpreter to handle `or` and `not`. Disjunctive expressions should succeed if at least one of the disjuncts succeeds; in processing a disjunctive expression, the interpreter should return the union of all the solutions returned by the disjuncts.

Negation is a bit more difficult, since a negated goal can succeed only if the goal itself fails. Thus, it is not possible to return any variable bindings for a negated goal. This is a result of the closed world assumption and the negation as failure rules described in Section 12.3.
19. Implement the general map and filter functions, `map-stream` and `filter-stream`, described in Section 10.8.
20. Rewrite the solution to the first n odd Fibonacci numbers problem so that it uses the general stream filter, `filter-stream`, instead of `filter-odds`. Modify this to return the first n even Fibonacci numbers and then modify it again to return the squares of the first n Fibonacci numbers.
21. Expand the logic programming interpreter to include LISP `write` statements. This will allow rules to print messages directly to the user. Hint: modify `solve` first to examine if a goal is a `write` statement. If it is, evaluate the `write` and return a stream containing the initial substitution set.
22. Expand the logic programming language to include arithmetic comparisons, `=`, `<`, and `>`.

Hint: as in Exercise 21, modify `solve` to detect these comparisons before calling `infer`. If an expression is a comparison, replace any variables with their values and evaluate it. If it returns `nil`, `solve` should return the empty stream; if it returns non-`nil`, `solve` should return a stream containing the initial substitution set. Assume that the expressions do not contain

unbound variables. For a more challenging exercise, define = so that it will function like the PROLOG is operator and assign a value to an unbound variable and simply do an equality test if all elements are bound.

23. Use the logic programming interpreter with arithmetic (Exercise 21) to solve the financial advisor problem of Chapter 2.
24. Select a problem such as automotive diagnosis or classifying different species of animals and solve it using lisp-shell.
25. Expand the expert system shell of Section 10.10 to allow the user responses other than y or n. For example, we may want the user to be able to provide bindings for a goal. This may be done by changing ask-for and the related functions to let the user also enter a pattern, which is matched against the goal. If the match succeeds, ask for a certainty factor.
26. Extend lisp-shell to include not. For an example of how to treat negation using uncertain reasoning, refer to Chapter 6 or the PROLOG-based expert system shell in Chapter 9.
27. Write an ATN parser (Section 11.3) for a subset of English.



PART V

ADVANCED TOPICS FOR AI PROBLEM SOLVING

Precision is not truth...

—HENRI MATISSE

*Time present and time past
are both perhaps present in time future
and time future is contained in time past...*

—T. S. ELIOT, “Burnt Norton”

...each larger pattern comes into being as the end product of a long sequence of tiny acts.

—CHRISTOPHER ALEXANDER

Natural Language, Automated Reasoning, and Learning

Part V examines three important artificial intelligence applications: natural language understanding, automated reasoning, and machine learning. Our solutions to these problems build on the tools and techniques introduced in the earlier sections of this text. Also, because of their importance, these problems have exerted a profound influence on the development of those tools and the overall direction of AI itself.

When asked what intellectual skills are most essentially human and most difficult to computerize, people usually mention artistic creativity, social interaction, ethical decision making and social responsibility. Language and learning are also included in most enumerations of uniquely human intellectual skills. Over the years, these problems have functioned as goals, challenges, and touchstones for the progress of AI. One of the reasons language and learning are difficult, yet important, research areas is that they encompass these other human capabilities. If we are ever to make claims of creating an artificial intelligence, we must address language, reasoning, and learning.

There are many reasons why language understanding has proven a difficult problem for AI. Among the most important are the amounts of knowledge, ability, and experience required to support language use. Successful language understanding requires an understanding of the natural world, human psychology, and social convention. It draws on skills as varied as logical reasoning and metaphor interpretation. Because of the complexity and ambiguity of human language, *natural language understanding* has motivated much of the research in knowledge representation. To date, these efforts have been partly successful: using a knowledge-based approach, researchers have successfully developed programs that understand natural language in specific domains. Whether these techniques will eventually solve the language understanding problem continues to be a subject of debate.

The representational techniques presented in Chapter 8, such as semantic networks, scripts, and frames have dominated work in natural language. More recently, the correlational analysis of language patterns has played a role in language understanding. Language utterances are not random creations of sounds or words, but happen in patterns. Bayesian techniques can model these language constructs. In Chapter 11 we examine syntactic, semantic, and stochastic techniques for natural language understanding.

In the introduction to Part III we discussed the pluses and minuses of weak method problem solvers. Problems of weak methods include the complexity of search spaces and the difficulties of representing knowledge of the world with general representations. In spite of the successes of expert systems and similar strong method solvers, many domains require general methods; in fact, the control strategies of expert systems themselves depend on good weak problem-solving methods. Much promising work on weak method problem solvers continues to be done by the automatic theorem proving community. These techniques have found application in a number of important areas including integrated circuit design and verification, proofs of program correctness, and indirectly, the creation of PROLOG. In Chapter 12 we address issues surrounding automated reasoning.

Chapters 13, 14, and 15 introduce machine learning, one of the central research problems of contemporary artificial intelligence. In Chapter 13, we consider symbol-based learning methods. Beginning with a set of symbols that represent the entities and relationships of a problem domain, symbolic learning algorithms attempt to infer novel, valid, and useful generalizations that can be expressed using these symbols. In contrast, the connectionist approaches discussed in Chapter 14 represent knowledge as patterns of activity in networks of small, individual processing units. Inspired by the architecture of animal brains, connectionist networks learn by modifying their structure in response to training data. Rather than searching the possible generalizations afforded by a symbolic representation language, connectionist models recognize invariant patterns in data and represent these patterns in their own structure.

Just as connectionist networks are inspired by the biological neural system, the emergent models of Chapter 15 are inspired by genetic and evolutionary analogues. Genetic algorithms begin with a population of candidate problem solutions. Candidate solutions are evaluated according to their ability to solve problem instances: only the fittest survive and combine with each other to produce the next generation of possible solutions. Thus, increasingly powerful solutions emerge in a Darwinian universe. It is oddly fitting that these approaches should seek the origins of intelligence in the same processes that gave rise to life itself.

UNDERSTANDING NATURAL LANGUAGE

Quid opus est verbis? (What need is there for words?)

—TERENCE

*I understand a fury in your words,
But not the words.*

—WILLIAM SHAKESPEARE, *Othello*

*They have been at a great feast of languages,
and stolen the scraps.*

—WILLIAM SHAKESPEARE, *Love's Labour's Lost*

I wish someone would tell me what "Ditty wah ditty" means.

—ARTHUR BLAKE

11.0 Role of Knowledge in Language Understanding

Communicating with natural language, whether as text or as speech, depends heavily on our knowledge and expectations of the domain of discourse. Understanding is not merely the transmission of words: it also requires inferences about the speaker's goals and assumptions, and about the context of the interaction. Implementing a natural language understanding program requires that we represent knowledge and expectations of the domain and reason effectively about them. We must consider such issues as nonmonotonicity, belief revision, metaphor, planning, learning, and the practical complexities of human interaction. These are the central problems of artificial intelligence.

Consider, for example, the following lines from Shakespeare's *Sonnet XVIII*:

Shall I compare thee to a summer's day?
Thou art more lovely and more temperate:
Rough winds do shake the darling buds of May,
And summer's lease hath all too short a date:

We cannot understand these lines through a simplistic, literal treatment of meaning. Instead, we must address such issues as:

1. What were Shakespeare's intentions in writing these lines? We must know a great deal about human love and the social conventions surrounding it to begin to understand his intentions.
2. Why did Shakespeare compare his beloved to a summer's day? Does he mean that she is 24 hours long and can cause sunburn or that she makes him feel the warmth and beauty of summer?
3. What inferences does the passage require? Shakespeare's intended meaning does not reside explicitly in the text; it must be inferred using metaphors, analogies, and background knowledge. For instance, how can we come to interpret the references to rough winds and the brevity of summer as lamenting the shortness of human life and love?
4. How does metaphor shape our understanding of these lines, as well as the semantics of human language in general? The words are not mere references to explicit objects such as blocks on a table; the heart of the poem's meaning is in the selective attribution of properties of a summer's day to the beloved. Which properties are attributed, and which are not, and above all, why are some properties important while others are ignored?
5. What is the relationship between the syntactic structure of the lines and the knowledge and inferences involved in understanding the meaning and purpose of the poem?

We cannot merely chain together the dictionary meanings of Shakespeare's words and call the result understanding. Instead, we must employ a complex process of parsing the sentence to determine the parts of speech, constructing a representation of the semantic meaning, and interpreting this meaning in light of our prior understanding of the problem domain. This chapter provides an introduction to the problems of natural language understanding and the computational techniques developed for their solution. Throughout the chapter, we focus on the problems of understanding written text. Speech understanding systems must also solve these problems, as well as the additional difficulties associated with the recognition and disambiguation of words spoken in context.

Because of the knowledge required to understand unconstrained natural language, much progress in the area has come by restricting our focus to *microworlds*, limited applications that require little domain knowledge. One of the earliest programs to take this approach was Terry Winograd's SHRDLU (Winograd 1972), which could converse about

a *blocks world* consisting of differently shaped and colored blocks and a hand for moving them about, as in Figure 11.1.

SHRDLU could respond to English-language queries and commands such as “What is sitting on the red block?” “What shape is the blue block on the table?” or “Place the green pyramid on the red brick.” It could handle pronoun references such as “Is there a red block? Pick it up.” It could even understand ellipses, such as “What color is the block on the blue brick? Shape?” Because of the simplicity of the blocks world, it was possible to provide the system with complete knowledge of the world. Because the blocks world did not involve the more difficult problems of commonsense reasoning such as understanding time, causality, possibilities, or beliefs, the techniques for representing this knowledge were relatively straightforward. In spite of its narrow subject matter, SHRDLU did provide a model for the integration of syntax and semantics and demonstrated that a program with sufficient knowledge of the domain of discourse could communicate meaningfully in natural language.

An alternative to the knowledge intensive approach to language understanding just described is to build a model of the patterns and expectations in the language expressions themselves. *Markov Chains* offer us a powerful tool for capturing these regularities. In language use, for example, articles generally precede nouns rather than follow them and certain nouns and verbs tend to occur together. Markov models can also capture the relationships between language patterns and the worlds they describe.

In Section 11.1 we introduce the knowledge intensive approach to the analysis of language. Section 11.2 presents a syntactic analysis; Section 11.3 combines syntax and semantics using augmented transition network parsing. Section 11.4 presents the stochastic approach to capturing regularities in language expressions. Finally, in Section 11.5 we consider two applications where natural language understanding programs are useful: question answering and accessing information in databases.

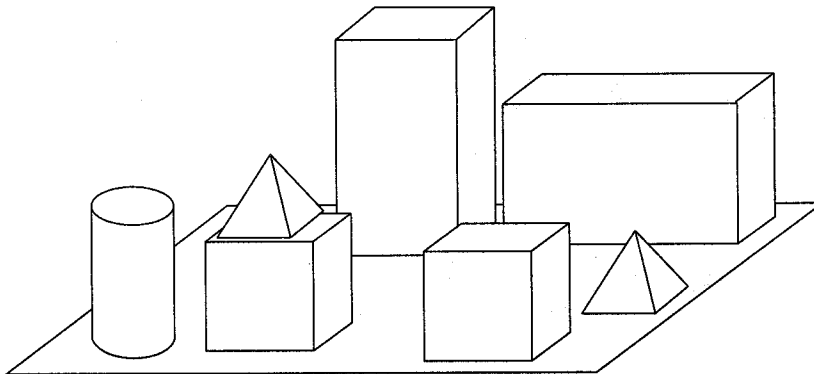

Figure 11.1 A blocks world.

11.1 Language Understanding: A Symbolic Approach

11.1.1 Introduction

Language is a complicated phenomenon, involving processes as varied as the recognition of sounds or printed letters, syntactic parsing, high-level semantic inferences, and even the communication of emotional content through rhythm and inflection. To manage this complexity, linguists have defined different levels of analysis for natural language:

1. *Prosody* deals with the rhythm and intonation of language. This level of analysis is difficult to formalize and often neglected; however, its importance is evident in the powerful effect of poetry or religious chants, as well as the role played by rhythm in children's wordplay and the babbling of infants.
2. *Phonology* examines the sounds that are combined to form language. This branch of linguistics is important to work in computerized speech recognition and generation.
3. *Morphology* is concerned with the components (morphemes) that make up words. These include the rules governing the formation of words, such as the effect of prefixes (un-, non-, anti-, etc.) and suffixes (-ing, -ly, etc.) that modify the meaning of root words. Morphological analysis is important in determining the role of a word in a sentence, including its tense, number, and part of speech.
4. *Syntax* studies the rules for combining words into legal phrases and sentences, and the use of those rules to parse and generate sentences. This has been the best formalized and consequently the most successfully automated level of linguistic analysis.
5. *Semantics* considers the meaning of words, phrases, and sentences and the ways in which meaning is conveyed in natural language.
6. *Pragmatics* is the study of the ways in which language is used and its effects on the listener. For example, pragmatics would address the reasons that "Yes" is usually an inappropriate answer to the question "Do you know what time it is?"
7. *World knowledge* includes knowledge of the physical world, the world of human social interaction, and the role of goals and intentions in communication. This general background knowledge is essential to understand the full meaning of a text or conversation.

Although these levels of analysis seem natural and are supported by psychological evidence, they are, to some extent, artificial divisions that have been imposed on language. All of these interact extensively, with even low-level intonations and rhythmic variations having an effect on the meaning of an utterance, e.g., sarcasm. This interaction is evident in the relationship between syntax and semantics, and although some division along these lines seems essential, the exact boundary is difficult to characterize. For example, sentences such as "They are eating apples" have multiple parsings that can be resolved

only by attention to meaning and context. Conversely, syntax affects semantics, as will be illustrated by the role of phrase structure in interpreting the meaning of a sentence.

Although the exact nature of the distinction between syntax and semantics is often debated, both the psychological evidence and its utility in managing the complexity of the problem argue for its retention. We address issues of language understanding and interpretation again in Chapter 16.

11.1.2 Stages of Language Analysis

Although the specific organization of natural language understanding programs varies with different philosophies and applications—e.g., a front end for a database, an automatic translation system, a story understanding program—all of them must translate the original sentence into an internal representation of its meaning. Generally, natural language understanding follows the stages of Figure 11.2.

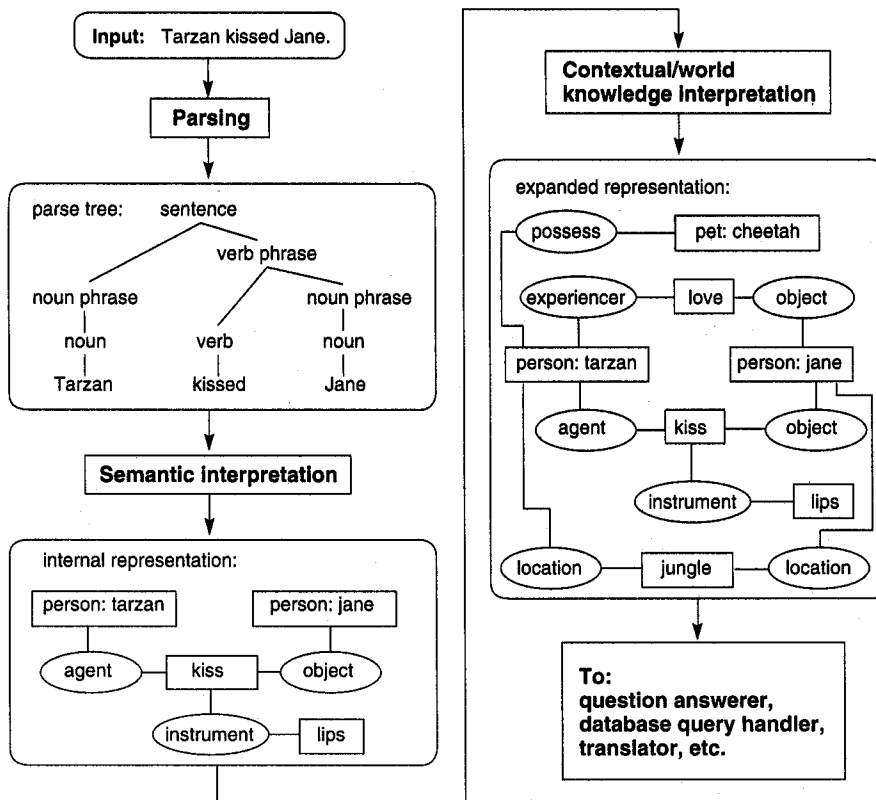

Figure 11.2 Stages in producing an internal representation of a sentence.

The first stage is *parsing*, which analyzes the syntactic structure of sentences. Parsing not only verifies that sentences are syntactically well formed but also determines their linguistic structure. By identifying the major linguistic relations such as subject-verb, verb-object, and noun-modifier, the parser provides a framework for semantic interpretation. This is often represented as a *parse tree*. The parser employs knowledge of language syntax, morphology, and some semantics.

The second stage is *semantic interpretation*, which produces a representation of the meaning of the text. In Figure 11.2 this is shown as a conceptual graph. Other representations commonly used include conceptual dependencies, frames, and logic-based representations. Semantic interpretation uses knowledge about the meaning of words and linguistic structure, such as case roles of nouns or the transitivity of verbs. In Figure 11.2, the program used knowledge of the meaning of *kiss* to add the default value of *lips* for the instrument of kissing. This stage also performs semantic consistency checks. For example, the definition of the verb *kiss* may include constraints that require the object to be a person if the agent is a person, that is, Tarzan kisses Jane and does not (normally) kiss Cheetah.

In the third stage, structures from the knowledge base are added to the internal representation of the sentence to produce an expanded representation of the sentence's meaning. This adds the necessary world knowledge required for complete understanding, such as the facts that Tarzan loves Jane, that Jane and Tarzan live in the jungle, and that Cheetah is Tarzan's pet. This resulting structure represents the meaning of the natural language text and is used by the system for further processing.

In a database front end, for example, the extended structure would combine the representation of the query's meaning with knowledge about the organization of the database. This could then be translated into an appropriate query in the database language. In a story understanding program, this extended structure would represent the meaning of the story and be used to answer questions about it (see the discussion of scripts in Chapter 8).

These stages exist in all systems, although they may or may not correspond to distinct software modules. For example, many programs do not produce an explicit parse tree but generate the internal semantic representation directly. Nevertheless, the tree is implicit in the parse of the sentence. *Incremental parsing* (Allen 1987) is a commonly used technique in which a fragment of the internal representation is produced as soon as a significant part of the sentence is parsed. These fragments are combined into a complete structure as the parse proceeds. They are also used to resolve ambiguities and guide the parser.

11.2 Syntax

11.2.1 Specification and Parsing Using Context-Free Grammars

Chapters 4 and 9 introduced the use of *rewrite rules* to specify a grammar. The rules listed below define a grammar for simple transitive sentences such as "The man likes the dog." The rules are numbered for reference.

1. sentence \leftrightarrow noun_phrase verb_phrase
2. noun_phrase \leftrightarrow noun
3. noun_phrase \leftrightarrow article noun
4. verb_phrase \leftrightarrow verb
5. verb_phrase \leftrightarrow verb noun_phrase
6. article \leftrightarrow a
7. article \leftrightarrow the
8. noun \leftrightarrow man
9. noun \leftrightarrow dog
10. verb \leftrightarrow likes
11. verb \leftrightarrow bites

Rules 6 through 11 have English words on the right-hand side; these rules form a dictionary of words that may appear in sentences of the grammar. These words are the *terminals* of the grammar. Terms that describe higher-level linguistic concepts (**sentence**, **noun_phrase**, etc.) are called *nonterminals*. Nonterminals appear in this typeface. Note that terminals do not appear in the left-hand side of any rule.

A legal sentence is any string of terminals that can be *derived* using these rules. A derivation begins with the nonterminal symbol **sentence** and produces a string of terminals through a series of substitutions defined by the rules of the grammar. A legal substitution replaces a symbol that matches the left-hand side of a rule with the symbols on the right-hand side of that rule. At intermediate stages of the derivation, the string may contain both terminals and nonterminals and is called a *sentential form*. A derivation of the sentence "The man bites the dog" is given by:

STRING	APPLY RULE #
sentence	1
noun_phrase verb_phrase	3
article noun verb_phrase	7
The noun verb_phrase	8
The man verb_phrase	5
The man verb noun_phrase	11
The man bites noun_phrase	3
The man bites article noun	7
The man bites the noun	9
The man bites the dog	

This is an example of a *top-down* derivation: it begins with the **sentence** symbol and works down to a string of terminals. A bottom-up derivation starts with a string of terminals and replaces right-hand-side patterns with those from the left-hand side, terminating when all that remains is the **sentence** symbol.

A derivation may be represented as a tree structure, known as a *parse tree*, in which each node is a symbol from the set of rules of the grammar. The interior nodes of the tree

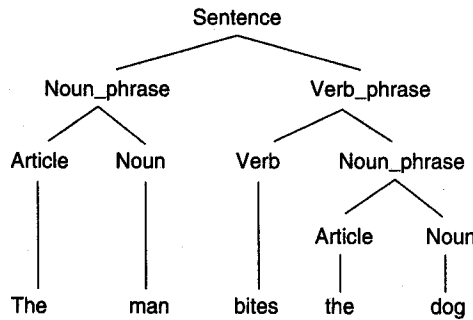

Figure 11.3 Parse tree for the sentence “The man bites the dog.”

are nonterminals; each node and its children correspond, respectively, to the left-hand side and right-hand side of a rule in the grammar. The leaf nodes are terminals and the **sen-
tence** symbol is the root of the tree. The parse tree for “The man bites the dog” appears in Figure 11.3.

Not only does the existence of a derivation or parse tree prove that a sentence is legal in the grammar, but it also determines the structure of the sentence. The *phrase structure* of the grammar defines the deeper linguistic organization of the language. For example, the breakdown of a **sentence** into a **noun_phrase** and a **verb_phrase** specifies the relation between an action and its agent. This phrase structure plays an essential role in semantic interpretation by defining intermediate stages in a derivation at which semantic processing may take place.

Parsing is the problem of constructing a derivation or a *parse tree* for an input string from a formal definition of a grammar. Parsing algorithms fall into two classes: *top-down parsers*, which begin with the top-level **sentence** symbol and attempt to build a tree whose leaves match the target sentence, and *bottom-up parsers*, which start with the words in the sentence (the terminals) and attempt to find a series of reductions that yield the **sentence** symbol.

In parsing, the difficulty is in determining which of several potentially applicable rules should be used at each step of the derivation. If the wrong choice is made, the parser may fail to recognize a legal sentence. For example, in attempting to parse the sentence “The dog bites” in a bottom-up fashion, rules 7, 9, and 11 produce the string **article noun verb**. At this point, an erroneous application of rule 2 would produce **article noun_phrase verb**; this could not be reduced to the **sentence** symbol. The parser should use rule 3 instead. Similar problems can occur in a top-down parse.

The problem of selecting the correct rule at any stage of the parse is handled either by allowing the parser to backtrack if an incorrect choice is made (as in *recursive descent parsers*) or by using look-ahead to check the input string for features that will determine the proper rule to apply. With either approach, we must take care to control the complexity of execution while guaranteeing a correct parse.

The inverse problem is that of *generation*, or producing legal sentences from an internal semantic representation. Generation starts with a representation of some meaningful content (such as a semantic network or conceptual dependency graph) and constructs a grammatically correct sentence that communicates this meaning. However, generation is not merely the reverse of understanding; it encounters unique difficulties and requires separate methodologies.

Because parsing is particularly important in the processing of programming languages as well as natural language, researchers have developed a number of different parsing algorithms. These include both top-down and bottom-up strategies. Though a complete survey of parsing algorithms is beyond the scope of this chapter, we do consider *transition network* parsers in some detail. Although transition network parsers themselves are not sufficiently powerful for the analysis of natural language, they form the basis for *augmented transition networks*, which have proved to be a powerful tool for natural language work.

11.2.2 Transition Network Parsers

A transition network parser represents a grammar as a set of finite-state machines or *transition networks*. Each network corresponds to a single nonterminal in the grammar. Arcs in the networks are labeled with either terminal or nonterminal symbols. Each path through the network, from the start state to the final state, corresponds to some rule for that nonterminal; the sequence of arc labels on the path is the sequence of symbols on the right-hand side of the rule. The grammar of Section 11.2.1 is represented by the transition networks of Figure 11.4. When there is more than one rule for a nonterminal, the corresponding network has multiple paths from the start to the goal. For example, the rules $\text{noun_phrase} \leftrightarrow \text{noun}$ and $\text{noun_phrase} \leftrightarrow \text{article noun}$ are captured by alternative paths through the *noun_phrase* network of Figure 11.4.

Finding a successful transition through the network for a nonterminal corresponds to the replacement of that nonterminal by the right-hand side of a grammar rule. For example, to parse a sentence, a transition network parser must find a transition through the sentence network. It begins in the start state (S_{initial}) and takes the *noun_phrase* transition and then the *verb_phrase* transition to reach the final state (S_{final}). This is equivalent to replacing the original *sentence* symbol with the pair of symbols *noun_phrase verb_phrase*.

In order to cross an arc, the parser examines its label. If the label is a terminal symbol, the parser checks the input stream to see whether the next word matches the arc label. If it does not match, the transition cannot be taken. If the arc is labeled with a nonterminal symbol, the parser retrieves the network for that nonterminal and recursively attempts to find a path through it. If the parser fails to find a path through this network, the top-level arc cannot be traversed. This causes the parser to backtrack and attempt another path through the network. Thus, the parser tries to find a path through the *sentence* network; if it succeeds, the input string is a legal sentence in the grammar.

Consider the simple sentence "Dog bites." The first steps in parsing this sentence are illustrated in Figure 11.5:

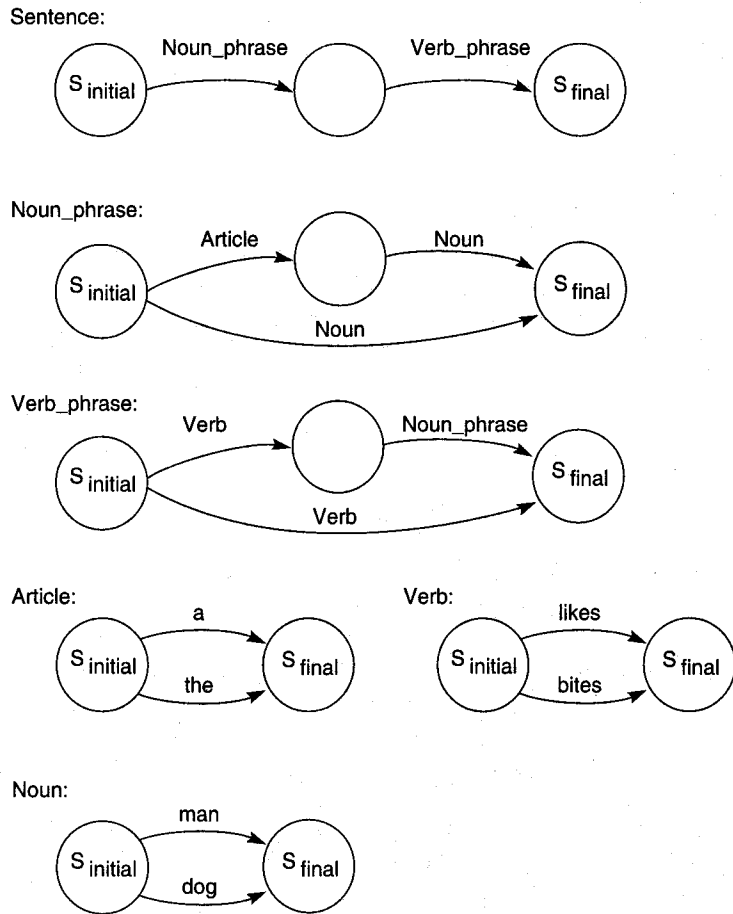

Figure 11.4 Transition network definition of a simple English grammar.

1. The parser begins with the **sentence** network and tries to move along the arc labeled **noun_phrase**. To do so, it retrieves the network for **noun_phrase**.
2. In the **noun_phrase** network, the parser first tries the transition marked **article**. This causes it to branch to the network for **article**.
3. It fails to find a path to the finish node of the **article** network because the first word of the sentence, "Dog," matches neither of the arc labels. The parser fails and backtracks to the **noun_phrase** network.
4. The parser attempts to follow the arc labeled **noun** in the **noun_phrase** network and branches to the network for **noun**.
5. The parser successfully crosses the arc labeled "dog," because this corresponds to the first word of the input stream.

6. The noun network returns success. This allows the arc labeled noun in the noun_phrase network to be crossed to the final state.
7. The noun_phrase network returns success to the top-level network, allowing the transition of the arc labeled noun_phrase.
8. A sequence of similar steps is followed to parse the verb_phrase portion of the sentence.

Pseudo-code for a transition network parser appears below. It is defined using two mutually recursive functions, **parse** and **transition**. **Parse** takes a grammar symbol as argument: if the symbol is a terminal, **parse** checks it against the next word in the input stream. If it is a nonterminal, **parse** retrieves the transition network associated with the symbol and calls **transition** to find a path through the network. **Transition** takes a state in a transition network as argument and tries to find a path through that network in a depth-first fashion. To parse a sentence, call **parse(sentence)**.

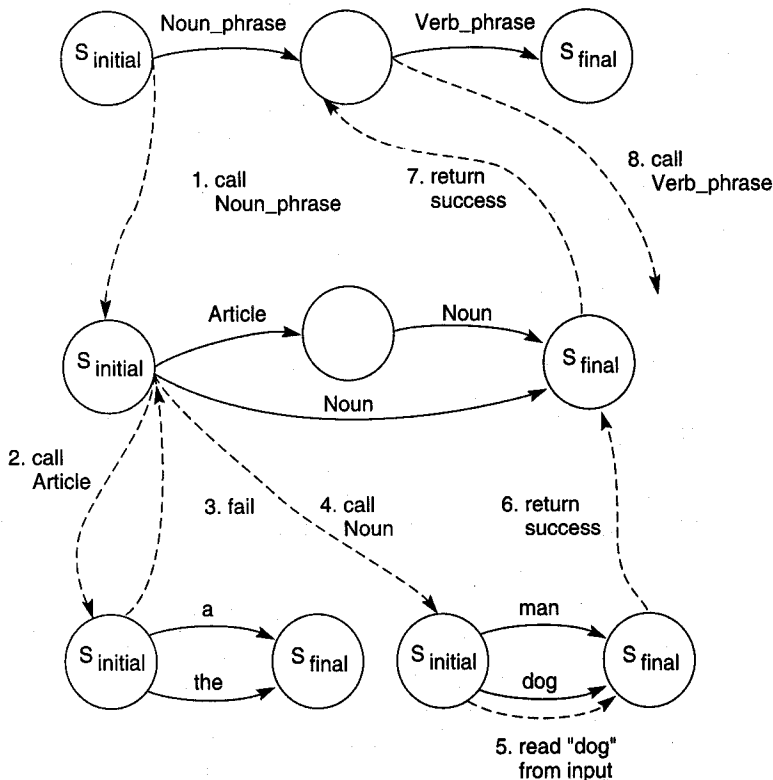

Figure 11.5 Trace of a transition network parse of the sentence "Dog bites."

```

function parse(grammar_symbol);
begin
  save pointer to current location in input stream;
  case

    grammar_symbol is a terminal:
      if grammar_symbol matches the next word in the input stream
      then return (success)
      else begin
          reset input stream;
          return (failure)
        end;

    grammar_symbol is a nonterminal:
      begin
        retrieve the transition network labeled by grammar symbol;
        state := start state of network;
        if transition(state) returns success
        then return (success)
        else begin
            reset input stream;
            return (failure)
          end
        end

      end
    end.

function transition (current_state);
begin
  case

    current_state is a final state:
      return (success)

    current_state is not a final state:
      while there are unexamined transitions out of current_state
      do begin
        grammar_symbol := the label on the next unexamined transition;
        if parse(grammar_symbol) returns (success)
        then begin
          next_state := state at end of the transition;
          if transition(next_state) returns success;
          then return (success)
        end
      end

      end case;
      return (failure)
    end.

```

Because the parser may make a mistake and have to backtrack, `parse` retains a pointer to the current location in the input stream. This allows the input stream to be reset to this location in the event the parser backtracks.

This transition network parser determines whether a sentence is grammatically correct, but it does not construct a parse tree. This may be accomplished by having the functions return a subtree of the parse tree instead of the symbol `success`. Modifications that would accomplish this are:

1. Each time the function `parse` is called with a terminal symbol as argument and that terminal matches the next symbol of input, it returns a tree consisting of a single leaf node labeled with that symbol.
2. When `parse` is called with a nonterminal, `grammar_symbol`, it calls `transition`. If `transition` succeeds, it returns an ordered set of subtrees (described below). `Parse` combines these into a tree whose root is `grammar_symbol` and whose children are the subtrees returned by `transition`.
3. In searching for a path through a network, `transition` calls `parse` on the label of each arc. On success, `parse` returns a tree representing a parse of that symbol. `Transition` saves these subtrees in an ordered set and, on finding a path through the network, returns the ordered set of parse trees corresponding to the sequence of arc labels on the path.

11.2.3 The Chomsky Hierarchy and Context-Sensitive Grammars

In Section 11.2.1, we defined a small subset of English using a *context-free grammar*. A context-free grammar allows rules to have only a single nonterminal on their left-hand side. Consequently, the rule may be applied to any occurrence of that symbol, regardless of its context. Though context-free grammars have proved to be a powerful tool for defining programming languages and other formalisms in computer science, there is reason to believe that they are not powerful enough, by themselves, to represent the rules of natural language syntax. For example, consider what happens if we add both singular and plural nouns and verbs to the grammar of Section 11.2.1:

noun ↔ men
noun ↔ dogs
verb ↔ bite
verb ↔ like

Although the resulting grammar will parse such sentences as “The dogs like the men,” it will also accept ungrammatical sentences such as “A men likes a dogs.” The parser will accept the erroneous sentence because the rules cannot use context to determine when the singular or plural forms must be used. For example, the rule defining a `sentence` as a `noun_phrase` followed by a `verb_phrase` cannot require that the subject and verb agree on number; the same problem occurs in trying to enforce article/noun agreement.

Languages defined by context-free grammars are only one in a hierarchy of classes of formal languages. This is the *Chomsky hierarchy* (Hopcroft and Ullman 1979, Chomsky 1965). At the bottom of the hierarchy is the class of *regular languages*. A regular language is one whose grammar may be defined using a finite-state machine. Although regular languages have many uses in computer science, they are not powerful enough to represent the syntax of most programming languages.

The *context-free languages* are above the regular languages in the Chomsky hierarchy. Context-free languages are defined using rewrite rules such as in Section 11.2.1; context-free rules may only have one nonterminal symbol on their left-hand side. Transition network parsers are able to parse the class of context-free languages. It is interesting to note that if we *do not* allow recursion in a transition network parser (i.e., arcs may be labeled only with terminal symbols, transitions may not “call” another network), then the class of languages that may be so defined corresponds to regular expressions. Thus, regular languages are a proper subset of the context-free languages.

The *context-sensitive languages* form a proper superset of the context-free languages. These are defined using *context-sensitive grammars* which allow more than one symbol on the left-hand side of a rule and make it possible to define a context in which that rule can be applied. This is used to ensure satisfaction of global constraints such as number agreement and other semantic checks. The only restriction on context-sensitive grammar rules is that the right-hand side be at least as long as the left-hand side of the rule (Hopcroft and Ullman 1979).

A fourth class, forming a superset of the context-sensitive languages, is the class of *recursively enumerable languages*. Recursively enumerable languages may be defined using unconstrained production rules; because these rules are less constrained than context-sensitive rules, the recursively enumerable languages are a proper superset of the context-sensitive languages. This class is not of interest in defining the syntax of natural language, although it is important in the theory of computer science. The remainder of this section focuses on English as a context-sensitive language.

A context-sensitive grammar for sentences of the form *article noun verb that* enforces number agreement both between article and noun and between subject and verb is given by:

```
sentence ↔ noun_phrase verb_phrase
noun_phrase ↔ article number noun
noun_phrase ↔ number noun
number ↔ singular
number ↔ plural
article singular ↔ a singular
article singular ↔ the singular
article plural ↔ some plural
article plural ↔ the plural
singular noun ↔ dog singular
singular noun ↔ man singular
plural noun ↔ men plural
plural noun ↔ dogs plural
```

singular verb_phrase ↔ singular verb
plural verb_phrase ↔ plural verb
singular verb ↔ bites
singular verb ↔ likes
plural verb ↔ bite
plural verb ↔ like

In this grammar, the nonterminals `singular` and `plural` provide a context to determine when different `article`, `noun`, and `verb_phrase` rules can be applied. This ensures number agreement. A derivation of the sentence “The dogs bite” using this grammar is given by:

sentence.
noun_phrase verb_phrase.
article plural noun verb_phrase.
The plural noun verb_phrase.
The dogs plural verb_phrase.
The dogs plural verb.
The dogs bite.

Similarly, we can use context-sensitive grammars to perform checks for semantic agreement. For example, we could disallow sentences such as “Man bites dog” by adding a nonterminal, `act_of_biting`, to the grammar. This nonterminal could be checked in the rules to prevent any sentence involving “bites” from having “man” as its subject.

Though context-sensitive grammars can define language structures that cannot be captured using context-free grammars, they have a number of disadvantages for the design of practical parsers:

1. Context-sensitive grammars increase drastically the number of rules and nonterminals in the grammar. Imagine the complexity of a context-sensitive grammar that would include number, person, and all the other forms of agreement required by English.
2. They obscure the phrase structure of the language that is so clearly represented in the context-free rules.
3. By attempting to handle more complicated checks for agreement and semantic consistency in the grammar itself, they lose many of the benefits of separating the syntactic and semantic components of language.
4. Context-sensitive grammars do not address the problem of building a semantic representation of the meaning of the text. A parser that simply accepts or rejects sentences is not sufficient; it must return a useful representation of the sentence’s semantic meaning.

In the next section we examine *augmented transition networks* (ATNs), an extension of transition networks that can define context-sensitive languages but has several advantages over context-sensitive grammars in the design of parsers.

11.3 Combining Syntax and Semantics in ATN Parsers

An alternative to context-sensitive grammars is to retain the simpler structure of context-free grammar rules but augment these rules with attached procedures that perform the necessary contextual tests. These procedures are executed when a rule is invoked in parsing. Rather than using the grammar to describe such notions as number, tense, and person, we represent these as *features* attached to terminals and nonterminals of the grammar. The procedures attached to the rules of the grammar access these features to assign values and perform the necessary tests. Grammars that use augmentations of context-free grammars to implement context sensitivity include *augmented phrase structure grammars* (Heidorn 1975, Sowa 1984), *augmentations of logic grammars* (Allen 1987), and the *augmented transition network* (ATN).

In this section we present ATN parsing and outline the design of a simple ATN parser for sentences about the “dogs world” introduced in Section 11.2.1. We address the first two steps of Figure 11.2: creation of a parse tree and its use to construct a representation of the sentence’s meaning. We use conceptual graphs in this example, although ATN parsers can also be used with script, frame, or logic representations.

11.3.1 Augmented Transition Network Parsers

Augmented transition networks extend transition networks by allowing procedures to be attached to the arcs of the networks. An ATN parser executes these attached procedures when it traverses the arcs. The procedures may assign values to grammatical features and perform tests, causing a transition to fail if certain conditions (such as number agreement) are not met. These procedures also construct a parse tree, which is used to generate an internal semantic representation of the sentence’s meaning.

We represent both terminals and nonterminals as identifiers (e.g., `verb`, `noun_phrase`) with attached features. For example, a word is described using its morphological root, along with features for its part of speech, number, person, etc. Nonterminals in the grammar are similarly described. A noun phrase is described by its article, noun, number, and person. Both terminals and nonterminals can be represented using framelike structures with named slots and values. The values of these slots specify

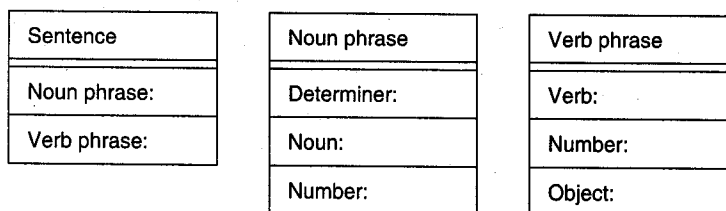

Figure 11.6 Structures representing the sentence, noun phrase, and verb phrase nonterminals of the grammar.

grammatical features or pointers to other structures. For example, the first slot of a sentence frame contains a pointer to a noun phrase definition. Figure 11.6 shows the frames for the sentence, noun_phrase, and verb_phrase nonterminals in our simple grammar.

Individual words are represented using similar structures. Each word in the dictionary is defined by a frame that specifies its part of speech (article, noun, etc.), its morphological root, and its significant grammatical features. In our example, we are only checking for number agreement and only record this feature. More sophisticated grammars indicate person and other features. These dictionary entries may also indicate the conceptual graph definition of the word's meaning for use in semantic interpretation. The complete dictionary for our grammar appears in Figure 11.7.

Word	Definition	Word	Definition						
a	<table border="1"> <tr><td>PART_OF_SPEECH: article</td></tr> <tr><td>ROOT: a</td></tr> <tr><td>NUMBER: singular</td></tr> </table>	PART_OF_SPEECH: article	ROOT: a	NUMBER: singular	like	<table border="1"> <tr><td>PART_OF_SPEECH: verb</td></tr> <tr><td>ROOT: like</td></tr> <tr><td>NUMBER: plural</td></tr> </table>	PART_OF_SPEECH: verb	ROOT: like	NUMBER: plural
PART_OF_SPEECH: article									
ROOT: a									
NUMBER: singular									
PART_OF_SPEECH: verb									
ROOT: like									
NUMBER: plural									
bite	<table border="1"> <tr><td>PART_OF_SPEECH: verb</td></tr> <tr><td>ROOT: bite</td></tr> <tr><td>NUMBER: plural</td></tr> </table>	PART_OF_SPEECH: verb	ROOT: bite	NUMBER: plural	likes	<table border="1"> <tr><td>PART_OF_SPEECH: verb</td></tr> <tr><td>ROOT: like</td></tr> <tr><td>NUMBER: singular</td></tr> </table>	PART_OF_SPEECH: verb	ROOT: like	NUMBER: singular
PART_OF_SPEECH: verb									
ROOT: bite									
NUMBER: plural									
PART_OF_SPEECH: verb									
ROOT: like									
NUMBER: singular									
bites	<table border="1"> <tr><td>PART_OF_SPEECH: verb</td></tr> <tr><td>ROOT: bite</td></tr> <tr><td>NUMBER: singular</td></tr> </table>	PART_OF_SPEECH: verb	ROOT: bite	NUMBER: singular	man	<table border="1"> <tr><td>PART_OF_SPEECH: noun</td></tr> <tr><td>ROOT: man</td></tr> <tr><td>NUMBER: singular</td></tr> </table>	PART_OF_SPEECH: noun	ROOT: man	NUMBER: singular
PART_OF_SPEECH: verb									
ROOT: bite									
NUMBER: singular									
PART_OF_SPEECH: noun									
ROOT: man									
NUMBER: singular									
dog	<table border="1"> <tr><td>PART_OF_SPEECH: noun</td></tr> <tr><td>ROOT: dog</td></tr> <tr><td>NUMBER: singular</td></tr> </table>	PART_OF_SPEECH: noun	ROOT: dog	NUMBER: singular	men	<table border="1"> <tr><td>PART_OF_SPEECH: noun</td></tr> <tr><td>ROOT: man</td></tr> <tr><td>NUMBER: plural</td></tr> </table>	PART_OF_SPEECH: noun	ROOT: man	NUMBER: plural
PART_OF_SPEECH: noun									
ROOT: dog									
NUMBER: singular									
PART_OF_SPEECH: noun									
ROOT: man									
NUMBER: plural									
dogs	<table border="1"> <tr><td>PART_OF_SPEECH: noun</td></tr> <tr><td>ROOT: dog</td></tr> <tr><td>NUMBER: plural</td></tr> </table>	PART_OF_SPEECH: noun	ROOT: dog	NUMBER: plural	the	<table border="1"> <tr><td>PART_OF_SPEECH: article</td></tr> <tr><td>ROOT: the</td></tr> <tr><td>NUMBER: plural or singular</td></tr> </table>	PART_OF_SPEECH: article	ROOT: the	NUMBER: plural or singular
PART_OF_SPEECH: noun									
ROOT: dog									
NUMBER: plural									
PART_OF_SPEECH: article									
ROOT: the									
NUMBER: plural or singular									

Figure 11.7 Dictionary entries for a simple ATN.

Figure 11.8 defines an ATN for our grammar, with pseudo-code descriptions of the tests performed at each arc. Arcs are labeled with both nonterminals of the grammar (as in Figure 11.4) and numbers; these numbers are used to indicate the procedure attached to each arc. The procedure must run successfully in order to traverse the arc.

When the parser calls a network for a nonterminal, it creates a new frame for that non-terminal. For example, on entering the `noun_phrase` network it creates a new `noun_phrase` frame. The slots of the frame are filled by the procedures for that network.

sentence:

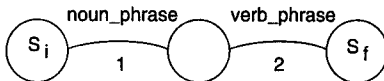

procedure sentence-1;

```
begin
  NOUN_PHRASE := structure returned by
    noun_phrase network;
  SENTENCE.SUBJECT := NOUN_PHRASE;
end.
```

procedure sentence-2;

```
begin
  VERB_PHRASE := structure returned by
    verb_phrase network;
  if NOUN_PHRASE.NUMBER =
    VERB_PHRASE.NUMBER
  then begin
    SENTENCE.VERB_PHRASE := VERB_PHRASE;
    return SENTENCE
  end
  else fail
end.
```

noun_phrase:

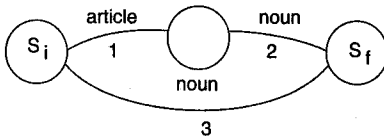

procedure noun_phrase-1;

```
begin
  ARTICLE := definition frame for next word of input;
  if ARTICLE.PART_OF_SPEECH=article
  then NOUN_PHRASE.DETERMINER := ARTICLE
  else fail
end.
```

procedure noun_phrase-2;

```
begin
  NOUN := definition frame for next word of input;
  if NOUN.PART_OF_SPEECH=verb and
    NOUN.NUMBER agrees with
    NOUN_PHRASE.DETERMINER.NUMBER
  then begin
    NOUN_PHRASE.NOUN := NOUN;
    NOUN_PHRASE.NUMBER := NOUN.NUMBER
    return NOUN_PHRASE
  end
  else fail
end.
```

Figure 11.8 An ATN grammar that checks number agreement and builds a parse tree.

These slots may be assigned values of grammatical features or pointers to components of the syntactic structure (e.g., a `verb_phrase` consists of a verb and a noun phrase). When the final state is reached, the network returns this structure.

When the network traverses arcs labeled `noun`, `article`, and `verb`, it reads the next word from the input stream and retrieves that word's definition from the dictionary. If the word is not the expected part of speech, the rule fails; otherwise the definition frame is returned.

```

procedure noun_phrase-3
begin
  NOUN := definition frame for next word of input;

  if NOUN.PART_OF_SPEECH=noun
  then begin
    NOUN_PHRASE.DETERMINER := unspecified;
    NOUN_PHRASE.NOUN := NOUN
    NOUN_PHRASE.NUMBER := NOUN.NUMBER
  end
  else fail
end.

```

verb_phrase:

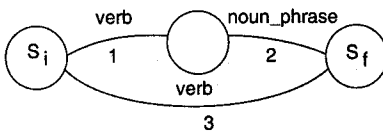

```

procedure verb_phrase-1
begin
  VERB := definition frame for next word of input;

  if VERB.PART_OF_SPEECH=verb
  then begin
    VERB_PHRASE.VERB := VERB;
    VERB_PHRASE.NUMBER := VERB.NUMBER;
  end;
end.

```

```

procedure verb_phrase-2
begin
  NOUN_PHRASE := structure returned by
    noun_phrase network;

  VERB_PHRASE.OBJECT := NOUN_PHRASE;
  return VERB_PHRASE
end.

```

```

procedure verb_phrase-3
begin
  VERB := definition frame for next word of input;

  if VERB.PART_OF_SPEECH=verb
  then begin
    VERB_PHRASE.VERB := VERB;
    VERB_PHRASE.NUMBER := VERB.NUMBER;
    VERB_PHRASE.OBJECT := unspecified;
    return VERB_PHRASE;
  end;
end.

```

Figure 11.8 (cont'd) An ATN grammar that checks number agreement and builds a parse tree.

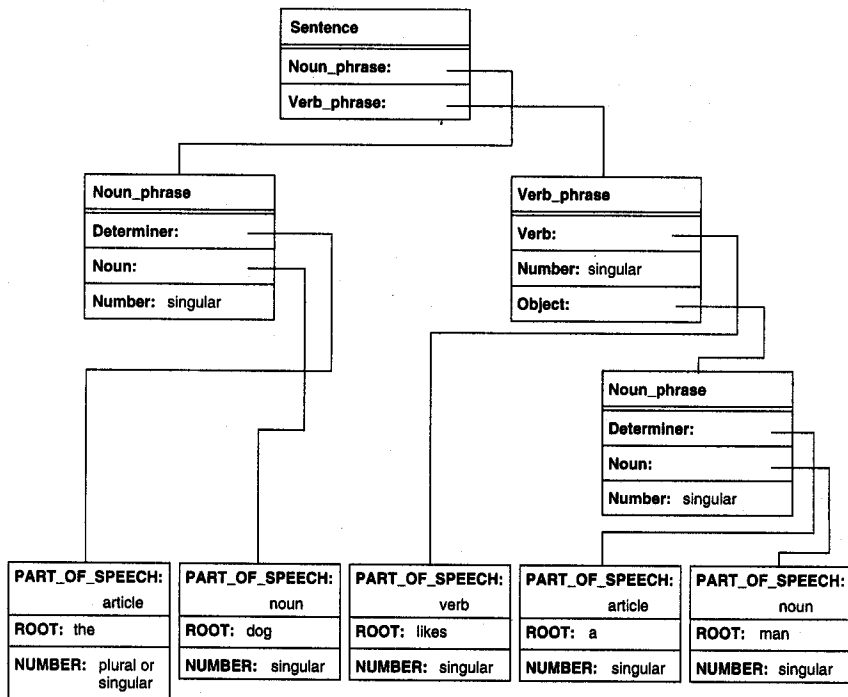

Figure 11.9 Parse tree for the sentence “The dog likes a man” returned by an ATN parser.

In Figure 11.8 frames and slots are indicated using a `Frame.Slot` notation; e.g., the number slot of the verb frame is indicated by `VERB.NUMBER`.

As the parse proceeds, each procedure builds and returns a frame describing the associated syntactic structure. This structure includes pointers to structures returned by lower-level networks. The top-level sentence procedure returns a `sentence` structure representing the parse tree for the input. This structure is passed to the semantic interpreter. Figure 11.9 shows the parse tree that is returned for the sentence “The dog likes a man.”

The next phase of natural language processing takes the parse tree (such as in Figure 11.9) and builds a semantic representation of the meaning.

11.3.2 Combining Syntax and Semantics

The semantic interpreter constructs a representation of the input string’s meaning by beginning at the root, or `sentence` node, and traversing the parse tree. At each node, it recursively interprets the children of that node and combines the results into a single conceptual graph; this graph is passed up the tree. For example, the semantic interpreter

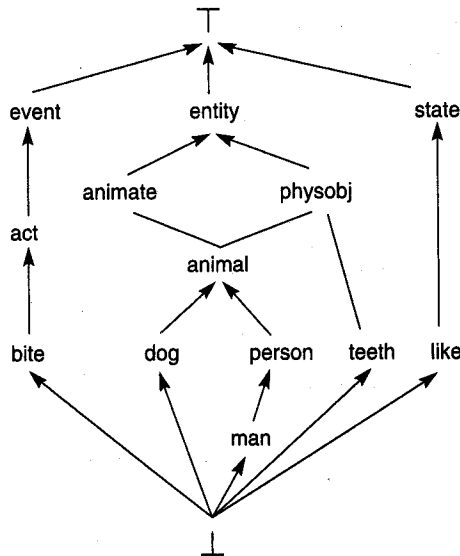

Figure 11.10 Type hierarchy used in “dogs world” example.

builds a representation of the **verb_phrase** by recursively building representations of the node’s children, **verb** and **noun_phrase**, and joining these to form an interpretation of the verb phrase. This is passed to the **sentence** node and combined with the representation of the **subject**.

Recursion stops at the terminals of the parse tree. Some of these, such as nouns, verbs, and adjectives, cause concepts to be retrieved from the knowledge base. Others, such as articles, do not directly correspond to concepts in the knowledge base but qualify other concepts in the graph.

The semantic interpreter in our example uses a knowledge base for the “dogs world.” Concepts in the knowledge base include the objects **dog** and **man** and the actions **like** and **bite**. These concepts are described by the type hierarchy of Figure 11.10.

In addition to concepts, we must define the relations that will be used in our conceptual graphs. For this example, we use the following concepts:

agent links an **act** with a concept of type **animate**. **agent** defines the relation between an action and the animate object causing the action.

experiencer links a **state** with a concept of type **animate**. It defines the relation between a mental state and its experiencer.

instrument links an **act** with an **entity** and defines the instrument used to perform an action.

object links an **event** or **state** with an **entity** and represents the verb–object relation.

part links concepts of type **physobj** and defines the relation between whole and part.

The verb plays a particularly important role in building an interpretation, as it defines the relationships between the subject, object, and other components of the sentence. We represent each verb using a *case frame* that specifies:

1. The linguistic relationships (agent, object, instrument, and so on) appropriate to that particular verb. Transitive verbs, for example, have an object; intransitive verbs do not.
2. Constraints on the values that may be assigned to any component of the case frame. For example, in the case frame for the verb "bites," we have asserted that the **agent** must be of the type **dog**. This causes "Man bites dog" to be rejected as semantically incorrect.
3. Default values on components of the case frame. In the "bites" frame, we have a default value of **teeth** for the concept linked to the **instrument** relation.

The case frames for the verbs *like* and *bite* appear in Figure 11.11.

We define the actions that build a semantic representation with rules or procedures for each potential node in the parse tree. Rules for our example are described as pseudo-code procedures. In each procedure, if a specified join or other test fails, that interpretation is rejected as semantically incorrect:

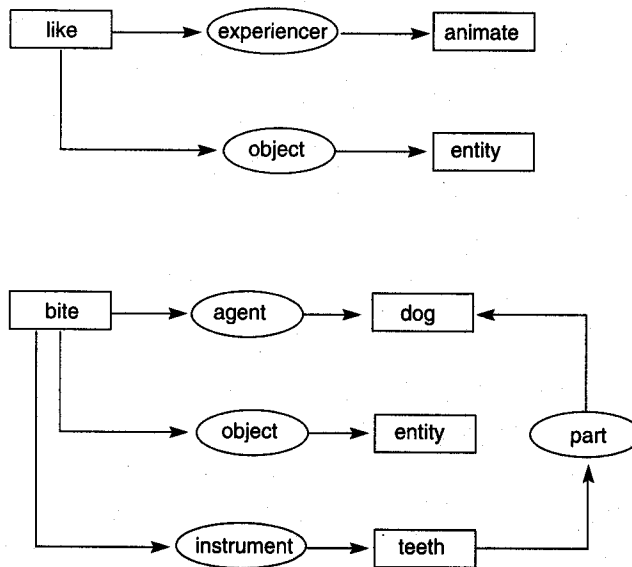

Figure 11.11 Case frames for the verbs "like" and "bite."

procedure sentence;

begin

call noun_phrase to get a representation of the subject;
call verb_phrase to get a representation of the verb_phrase;
using join and restrict, bind the noun concept returned for the subject to
the agent of the graph for the verb_phrase

end.

procedure noun_phrase;

begin

call noun to get a representation of the noun;

case

the article is indefinite and number singular: the noun concept is generic;

the article is definite and number singular: bind marker to noun concept;

number is plural: indicate that the noun concept is plural

end case

end.

procedure verb_phrase;

begin

call verb to get a representation of the verb;

if the verb has an object

then begin

call noun_phrase to get a representation of the object;

using join and restrict, bind concept for object to object of the verb

end

end.

procedure verb;

begin

retrieve the case frame for the verb

end.

procedure noun;

begin

retrieve the concept for the noun

end.

Articles do not correspond to concepts in the knowledge base but determine whether their noun concept is generic or specific. We have not discussed the representation of plural concepts; refer to Sowa (1984) for their treatment in conceptual graphs.

Using these procedures, along with the concept hierarchy of Figure 11.10 and the case frames of Figure 11.11, we trace the actions of the semantic interpreter in building a

semantic representation of the sentence "The dog likes a man" from the parse tree of Figure 11.9. This trace appears in Figure 11.12.

The actions taken in the trace are (numbers refer to Figure 11.12):

Beginning at the sentence node, call **sentence**.

sentence calls **noun_phrase**.

noun_phrase calls **noun**.

noun returns a concept for the noun **dog** (1 in Figure 11.12).

Because the article is definite, **noun_phrase** binds an individual marker to the concept (2) and returns this concept to **sentence**.

sentence calls **verb_phrase**.

verb_phrase calls **verb**, which retrieves the case frame for **like** (3).

verb_phrase calls **noun_phrase**, calls **noun** to retrieve the concept for **man** (4).

Because the article is indefinite, **noun_phrase** leaves this concept generic (5).

The **verb_phrase** procedure restricts the **entity** concept in the case frame and joins it with the concept for **man** (6). This structure is returned to **sentence**.

sentence joins the concept **dog: #1** to the **experiencer** node of the case frame (7). This conceptual graph represents the meaning of the sentence.

Language generation is a related problem addressed by natural language understanding programs. The generation of English sentences requires the construction of a semantically correct output from an internal representation of meaning. For example, the **agent** relation indicates a subject-verb relationship between two concepts. Simple approaches allow the appropriate words to be plugged into stored sentence *templates*. These templates are patterns for sentences and fragments, such as noun phrases and prepositional phrases. The output is constructed by walking the conceptual graph and combining these fragments. More sophisticated approaches to language generation use transformational grammars to map meaning into a range of possible sentences (Winograd 1972, Allen 1987).

In Section 11.5 we will show how a program can build an internal representation of natural language text. This representation is used by the program in a number of ways, depending on the particular application. Two applications are presented. But first, in Section 11.4, we present stochastic approaches for capturing the patterns and regularities of language.

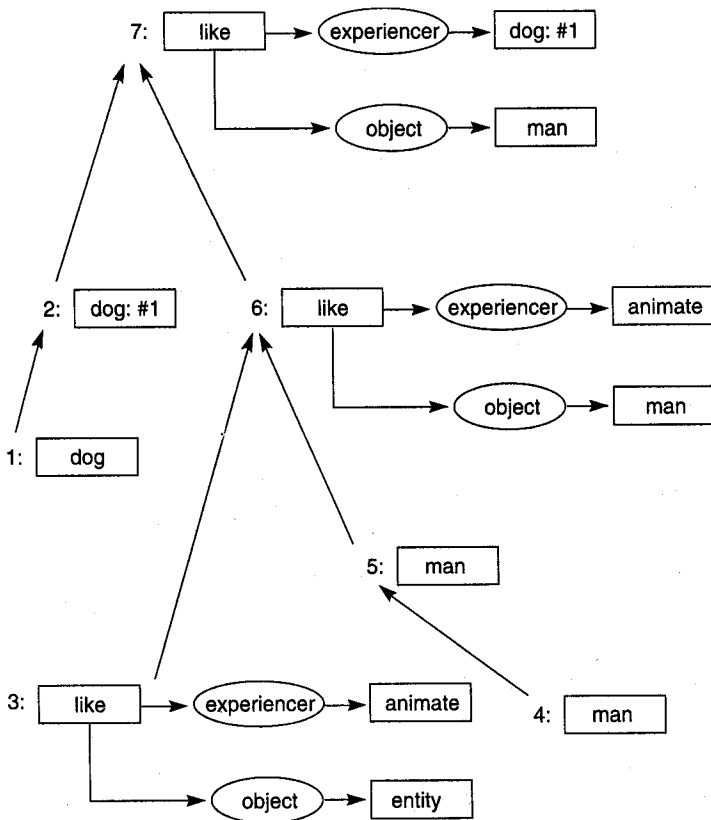

Figure 11.12 Construction of a semantic representation from the parse tree of Figure 11.9.

11.4 Stochastic Tools for Language Analysis

11.4.1 Introduction

Statistical natural language techniques are methods which arise when we view natural language as a random process. In everyday parlance, randomness suggests lack of structure, definition or understanding. However, viewing natural language as a random process *generalizes* the deterministic viewpoint. That is, statistical (or stochastic) techniques can accurately model both those parts of language which are well defined as well as those parts which indeed do have some degree of randomness.

Viewing natural language as a random process allows us to redefine the basic problems within natural language understanding in a rigorous, mathematical manner. To

show these redefinitions and the techniques we can use to solve the new problems, we consider first the problem of part of speech tagging.

Most people are familiar with this problem from grammar class. We want to label each word in a sentence as a noun, verb, preposition, adjective, etc. In addition, if the word is a verb, we may want to know if it is active, passive, transitive, etc. If the word is a noun, whether it is singular or plural and so on. Difficulty arises with words like "swing." If we say, "front porch swing," swing is a noun but if we say "swing at the ball" then swing is a verb. Following is a quote from Picasso with its correct part of speech labels:

Art is a lie that lets us see the truth.
 Noun Verb Article Noun Pronoun Verb Pronoun Verb Article Noun

To begin our analysis, we first define the problem formally. We have a set of words in our language $S_w = \{w_1, \dots, w_n\}$, for example $\{a, \text{aardvark}, \dots, \text{zygote}\}$, and a set of parts of speech or tags $S_t = \{t_1, \dots, t_m\}$. A sentence with n words is a sequence of n random variables $W_1 W_2 \dots W_n$. These are called *random* variables because they can take on any of the values in S_w with some probability. The tags, T_1, T_2, \dots, T_n , are also a sequence of random variables. The value that T_i takes on will be denoted t_i and the value of W_i is w_i . We want to find the sequence of values for these tags which is most likely, given the words in the sentence. Formally, we want to pick t_1, \dots, t_n to maximize:

$$P(T_1 = t_1, \dots, T_n = t_n \mid W_1 = w_1, \dots, W_n = w_n)$$

Recall from Chapter 7, that $P(X|Y)$ stands for *the probability of X given that Y has occurred*. It is customary to drop reference to the random variables and just write:

$$P(t_1, \dots, t_n \mid w_1, \dots, w_n) \quad \text{equation 1}$$

Note that if we knew this probability distribution exactly and if we had enough time to maximize over all possible tag sets, we would always get the best possible set of tags for the words considered. In addition, if there really is only one correct sequence of tags for each sentence, an idea your grammar teacher may have espoused, this probabilistic technique will always find that correct sequence; thus the probability for the correct sequence would be 1 and that for all other sequences 0. This is what we meant above when we said that the statistical viewpoint can generalize the deterministic one.

In reality, because of limited storage space, data, and time, we can not use the above technique and must come up with some type of approximation. The rest of this section deals with better and better ways to approximate equation 1.

First note that we can rewrite equation 1 in a more useful manner:

$$P(t_1, \dots, t_n \mid w_1, \dots, w_n) = P(t_1, \dots, t_n, w_1, \dots, w_n) / P(w_1, \dots, w_n)$$

and since we maximize this by choosing t_1, \dots, t_n , we can simplify equation 1 to:

$$P(t_1, \dots, t_n, w_1, \dots, w_n) =$$

$$P(t_1)P(w_1 | t_1)P(t_2 | t_1, w_1) \dots P(t_n | w_1, \dots, w_n, t_1, \dots, t_{n-1}) = \prod_{i=1}^n P(t_i | t_1, \dots, t_{i-1}, w_1, \dots, w_{i-1}) P(w_i | t_1, \dots, t_{i-1}, w_1, \dots, w_{i-1}) \quad \text{equation 2}$$

Notice that equation 2 is equivalent to equation 1.

11.4.2 A Markov Model Approach

In practice, it is usually a complex task to maximize equations with probabilities conditioned on many other random variables, such as we find in equation 2. There are three reasons for this: first, it is difficult to store the probability of a random variable conditioned on many other random variables because the number of possible probabilities increases exponentially with the number of conditioning variables. Secondly, even if we could store all of the probability values, it is often difficult to estimate their values. Estimation is usually done empirically by counting the number of occurrences of an event in a hand-tagged training set and thus, if an event occurs only a few times in the training set, we will not get a good estimate of its probability. That is, it is easier to estimate $P(\text{cat} | \text{the})$ than $P(\text{cat} | \text{The dog chased the})$ since there will be fewer occurrences of the latter in the training set. Finally, finding the chain of tags that maximizes structures like equation 2 would take too long, as will be shown next.

First, we need to make some useful approximations of equation 2. The first rough attempt is:

$$P(t_i | t_1, \dots, t_{i-1}, w_1, \dots, w_{i-1}) \text{ approaches } P(t_i | t_{i-1})$$

and

$$P(w_i | t_1, \dots, t_{i-1}, w_1, \dots, w_{i-1}) \text{ approaches } P(w_i | t_i).$$

These are called *Markov assumptions* because they assume that the present thing under consideration is independent of things in the far past.

Plugging these approximations back into equation 2, we get

$$\prod_{i=1}^n P(t_i | t_{i-1}) P(w_i | t_i) \quad \text{equation 3}$$

Equation 3 is straightforward to work with because its probabilities can be easily estimated and stored. Recall that equation 3 is just an estimate of $P(t_1, \dots, t_n | w_1, \dots, w_n)$ and we still need to maximize it by choosing the tags (i.e., t_1, \dots, t_n). Fortunately, there is a dynamic programming algorithm called the Viterbi algorithm (Forney 1973) which will allow us to do this. The Viterbi algorithm calculates the probability of t^2 tag sequences for each word in the sentence where t is the number of possible tags. For a particular step, the tag sequences under consideration are of the following form:

article	article	{best tail}
article	verb	{best tail}
...		
article	noun	{best tail}
...		
...		
noun	article	{best tail}
...		
noun	noun	{best tail}

Where {best tail} is the most likely sequence of tags found dynamically for the last $n - 2$ words for the given $n - 1$ tag.

There is an entry in the table for every possible value for tag number $n - 1$ and tag number n (hence we have the t^2 tag sequences). At each step, the algorithm finds the maximal probabilities and adds one tag to each best tail sequence. This algorithm is guaranteed to find the tag sequence which maximizes equation 3 and it runs in $O(t^2 s)$, where t is the number of tags and s is the number of words in the sentence. If $P(t)$ is conditioned on the last n tags rather than the last two, the Viterbi Algorithm will take $O(t^n s)$. Thus we see why conditioning on too many past variables increases the time taken to find a maximizing value.

Fortunately, the approximations used in equation 3 work well. With about 200 possible tags and a large training set to estimate probabilities, a tagger using these methods is about 97% accurate, which approaches human accuracy. The surprising accuracy of the Markov approximation along with its simplicity makes it useful in many applications. For example, most speech recognition systems use what is called the *trigram* model to provide some “grammatical knowledge” to the system for predicting words the user has spoken. The trigram model is a simple Markov model which estimates the probability of the current word conditioned on the last two words used. It uses the Viterbi algorithm and other techniques just described.

11.4.3 A CART Tree Approach

An obvious problem with the Markov approach is that it considers only local context. If instead of tagging words with simple parts of speech, we wish to do things like identify an agent, identify an object, or decide whether verbs are active or passive, then a richer context is required. The following sentence illustrates this problem:

The policy announced in December by the President guarantees lower taxes.

In fact, the *President* is the agent but a program using a Markov model would likely identify the *policy* as agent and *announced* as an active verb. We can imagine that a program would get better at probabilistically choosing the agent of this type of sentence if it could ask questions like, “Is the current noun inanimate?” or “Does the word *by* appear a few words before the noun under consideration?”

Recall that the tagging problem is equivalent to maximizing equation 2, i.e.,

$$\prod_{i=1}^n P(t_i | t_1, \dots, t_{i-1}, w_1, \dots, w_{i-1}) P(w_i | t_1, \dots, t_{i-1}, w_1, \dots, w_{i-1}).$$

Theoretically, considering a larger context involves simply finding better estimates for these probabilities. This suggests that we might want to use answers to the grammatical questions above to refine the probabilities.

There are several ways we can address this issue. First, we can combine the Markov approach with the parsing techniques presented in the first three sections of this chapter. A second method allows us to find probabilities conditioned on *yes* or *no* questions with the ID3 algorithm (presented in detail in Section 13.3). ID3 trees have the added bonus that out of a large set of possible questions, they will choose only those which are good at refining probability estimates. For more complicated natural language processing tasks such as parsing, ID3 based trees are often preferred over Markov models. The next section describes the use of ID3 to construct a decision tree for use in parsing.

11.4.4 Mutual Information Clustering

Recall that in the above section we asked the question "Is the current noun inanimate?". We can ask questions like this only if we know which words are animate and which words aren't. In fact there is an automated technique which can assign words to these types of classes for us. The technique is called *mutual information clustering*. The Mutual Information between two random variables X and Y is defined as

$$I(X;Y) = \sum_{x \in X} \sum_{y \in Y} P(x, y) \log_2 \frac{P(x, y)}{P(x)P(y)}$$

To do mutual information clustering over a vocabulary of words, we start by putting each word in the vocabulary into a distinct set. At each step, we compute the average mutual information between sets using a bigram, that is a next word model, and a merge of two word sets is chosen which minimizes the loss in average mutual information for all classes.

For example, if initially we have the words *cat*, *kitten*, *run*, and *green*, at the first step of the algorithm, we have the sets:

{cat} {kitten} {run} {green}.

It is likely that the probability of the next word, given that the previous word was *cat*, is about equal to the probability of the next word, given that the previous word was *kitten*. In other words:

P(eats | cat) is about the same as P(eats | kitten)
P(meows | cat) is about the same as P(meows | kitten)

Thus, if we let X_1 , X_2 , Y_1 , and Y_2 be random variables such that:

$X_1 = \{\{\text{cat}\}, \{\text{kitten}\}, \{\text{run}\}, \{\text{green}\}\}$
 $Y_1 = \text{word following } X_1$
 $X_2 = \{\{\text{cat, kitten}\}, \{\text{run}\}, \{\text{green}\}\}$
 $Y_2 = \text{word following } X_2,$

then the mutual information between X_2 and Y_2 is not much less than the mutual information between X_1 and Y_1 , thus *cat* and *kitten* will likely be combined. If we continue this procedure until we have combined all possible classes, we get a binary tree. Then, we assign *bit codes* can be assigned to words based on the branches taken within the tree that reaches the leaf node that has that word in it. This reflects the semantic meaning of the word. For example:

cat = 01100011
kitten = 01100010

We might also find that “noun-like” words will be all those that have a 1 in the leftmost bit and that words which likely represent inanimate objects may be those whose 3rd bit is a 1.

This new encoding of dictionary words allows the parser to more effectively ask questions. Note that the clustering does not take context into account so that even though “book” may be clustered as a “noun-like” word, we will want our model to tag it as a verb when it is found in the phrase “book a flight.”

11.4.5 Parsing

The use of statistical methods in parsing was first motivated by the problem of ambiguity. Ambiguity arises from the fact that there are often several possible parses for a given sentence and we need to choose which parse might be the correct one. For example, the sentence *Print the file on the printer* can be parsed using either of the two trees presented in Figure 11.13.

In situations such as this, grammar rules alone are not sufficient for choosing the correct parse. In the *Print the file on the printer* case we need to consider some information about context and semantics. In fact, the primary use of stochastic techniques in the parsing domain is to help resolve ambiguities. In the current example, we can use the same tool used in part of speech tagging, the ID3 algorithm, see Section 13.3. ID3 assists us in predicting the probability that a parse is correct based on semantic questions about the sentence. In the case when there is some syntactic ambiguity in the sentence, we can then choose that parse which has the highest probability of being correct. As usual, this technique requires a large *training corpus* of sentences with their correct parses.

Recently, people in the statistical natural language modeling community have become more ambitious and have tried to use statistical techniques without a grammar to do parsing. Although the details of grammarless parsing are beyond the scope of this book,

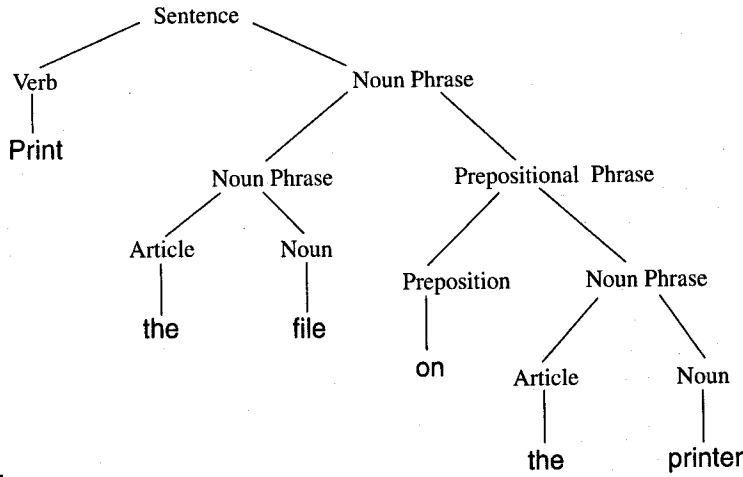

a.

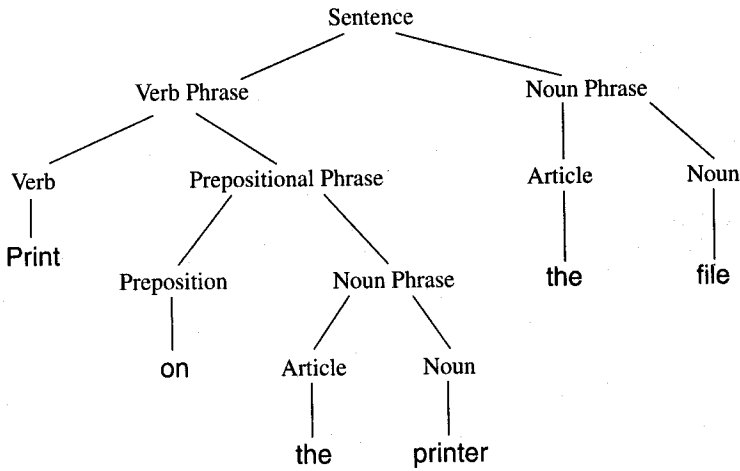

b.

Figure 11.13. Two different parses of "Print the file on the printer."

suffice it to say that it is related more to pattern recognition than to the traditional parsing techniques covered earlier in this chapter.

Grammarless parsing has been quite successful. In a recent experiment comparing a traditional grammar-based parser with a grammarless one on the task of parsing the same set of sentences, the grammar-based parser achieved a score (using a popular metric, the "crossing-brackets" measure) of 69% and the grammarless parser 78% (Magerman 1994).

The grammar in the traditional parser was developed meticulously by a trained linguist over the course of about ten years, while the grammarless parser used essentially no hard-coded linguistic information, only sophisticated mathematical models which could infer the needed information from the training data.

11.4.6 Other Language Applications for Stochastic Techniques

Stochastic techniques have already been used in many domains of computational linguistics and there is still a great deal of opportunity to apply them to areas which have resisted traditional, symbolic approaches.

Speech understanding and handwriting recognition are two areas which have a long history of using stochastic methods for modeling language. The most commonly used statistical method in these areas is the trigram model for next word prediction. The strength of this model is in its simplicity: it simply predicts the next word based on the last two words. Recently, there has been work in the statistical language community to maintain the simplicity and ease of use of this model while incorporating grammatical constraints and longer distance dependencies. This new approach uses what are called *grammatical trigrams*. The grammatical trigrams are informed by basic associations between pairs of words (i.e., subject-verb, article-noun and verb-object). Collectively, these associations are called a *link grammar*. The link grammar is much simpler and easier to construct than the traditional grammars used by linguists and works well with probabilistic methods.

Berger et al. (1994) describe a statistical program, *Candide*, which translates French text to English text. *Candide* uses both statistics and information theory to develop a probability model of the translation process. It trains only on a large corpus of French and English sentence pairs and gets results comparable to and in some cases better than *Systran* (Berger et al. 1994), a commercial translation program. Of particular interest is the fact that the *Candide* system does no traditional parsing in the translation process. Instead it uses the grammatical trigrams and link grammars just mentioned.

There are several other areas where rigorous stochastic language modeling techniques have not yet been tried but where they may yield useful results. Information extraction, or the problem of obtaining a certain amount of concrete information from a written text along with WWW searching are two of these potential areas.

11.5 Natural Language Applications

11.5.1 Story Understanding and Question Answering

An interesting test for natural language understanding technology is to write a program that can read a story or other piece of natural language text and answer questions about it. In Chapter 8 we discussed some of the representational issues involved in story understanding, including the importance of combining background knowledge with the

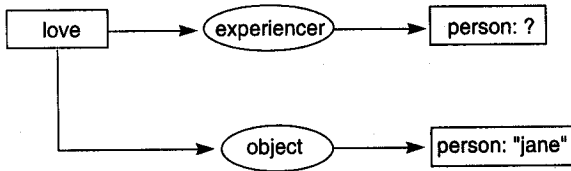

Figure 11.14 Conceptual graph for the question "Who loves Jane?"

explicit content of the text. As illustrated in Figure 11.2, a program can accomplish this by performing network joins between the semantic interpretation of the input and conceptual graph structures in a knowledge base. More sophisticated representations, such as scripts, can help to model more complex situations involving events occurring over time.

Once the program has built an expanded representation of the text, it can intelligently answer questions about what it has read. The program parses the question into an internal representation and matches that query against the expanded representation of the story. Consider the example of Figure 11.2. The program has read the sentence "Tarzan kissed Jane" and built an expanded representation.

Assume that we ask the program "Who loves Jane?" In parsing the question, the interrogative, *who*, *what*, *why*, etc., indicates the intention of the question. *Who* questions ask for the agent of the action; *what* questions ask for the object of the action; *how* questions ask for the means by which the action was performed, and so on. The question "Who loves Jane?" produces the graph of Figure 11.14. The *agent* node of the graph is marked with a ? to indicate that it is the goal of the question. This structure is then joined with the expanded representation of the original text. The concept that becomes bound to the *person: ?* concept in the query graph is the answer to the question: "Tarzan loves Jane."

11.5.2 A Database Front End

The major bottleneck in designing natural language understanding programs is the acquisition of sufficient knowledge about the domain of discourse. Current technology is limited to narrow domains with well-defined semantics. An application area that meets these criteria is the development of natural language front ends for databases. Although databases store enormous amounts of information, that information is highly regular and narrow in scope; furthermore, database semantics are well defined. These features, along with the utility of a database that can accept natural language queries, make database front ends an important application of natural language understanding technology.

The task of a database front end is to translate a question in natural language into a well-formed query in the database language. For example, using the SQL database language as a target (Ullman 1982), the natural language front end would translate the question "Who hired John Smith?" into the query:

```

SELECT MANAGER
FROM MANAGER_OF_HIRE
WHERE EMPLOYEE = 'John Smith'

```

In performing this translation, the program must do more than translate the original query; it must also decide where to look in the database (the `MANAGER_OF_HIRE` relation), the name of the field to access (`MANAGER`), and the constraints on the query (`EMPLOYEE = 'John Smith'`). None of this information was in the original question; it was found in a knowledge base that knew about the organization of the database and the meaning of potential questions.

A *relational database* organizes data in relations across domains of entities. For example, suppose we are constructing a database of employees and would like to access the salary of each employee and the manager who hired her. This database would consist of three *domains*, or sets of entities: the set of managers, the set of employees, and the set of salaries. We could organize these data into two relations, `employee_salary`, which relates an employee and her salary, and `manager_of_hire`, which relates an employee and her manager. In a relational database, relations are usually displayed as tables that enumerate the instances of the relation. The columns of the tables are often named; these names are called *attributes* of the relation. Figure 11.15 shows the tables for the `employee_salary` and the `manager_of_hire` relations. `Manager_of_hire` has two attributes, the `employee` and the `manager`. The values of the relation are the pairs of employees and managers.

If we assume that employees have a unique name, manager, and salary, then the employee name can be used as a *key* for both the salary and the manager attributes. An attribute is a key for another attribute if it uniquely determines the value of elements for the other attribute. A valid query indicates a target attribute and specifies a value or set of constraints; the database returns the specified values of the target attribute. We can indicate the relationship between keys and other attributes graphically in a number of ways, including *entity-relationship diagrams* (Ullman 1982) and *data flow diagrams* (Sowa 1984). Both of these approaches display the mapping of keys onto attributes using directed graphs.

manager_of_hire:		employee_salary:	
employee	manager	employee	salary
John Smith	Jane Martinez	John Smith	\$35,000.00
Alex Barrero	Ed Angel	Alex Barrero	\$42,000.00
Don Morrison	Jane Martinez	Don Morrison	\$50,000.00
Jan Claus	Ed Angel	Jan Claus	\$40,000.00
Anne Cable	Bob Veroff	Anne Cable	\$45,000.00

Figure 11.15 Two relations in an employee database.

We can extend conceptual graphs to include diagrams of these relationships (Sowa 1984). The database relation that defines the mapping is indicated by a rhombus, which is labeled with the name of the relation. The attributes of the relation are expressed as concepts in a conceptual graph and the direction of the arrows indicates the mapping of keys onto other attributes. The entity-relation graphs for the `employee_salary` and `manager_of_hire` relations may be seen in Figure 11.16.

In translating from English to a formal query, we must determine the record that contains the answer, the field of that record that must be returned, and the values of the keys that determine that field. Rather than translating directly from English into the database language, we first translate into a more expressive language such as conceptual graphs. This is necessary because many English queries are ambiguous or require additional interpretation to produce a well-formed database query. The use of a more expressive representation language helps this process.

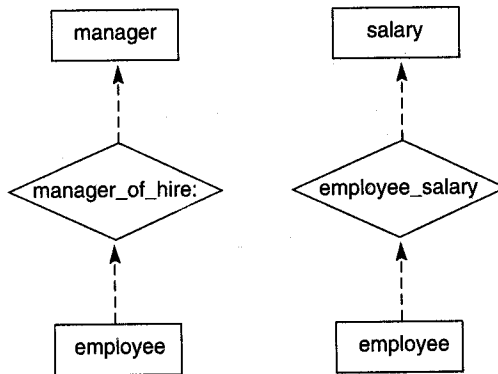

Figure 11.16 Entity-relationship diagrams of the `manager_of_hire` and `employee_salary` relations.

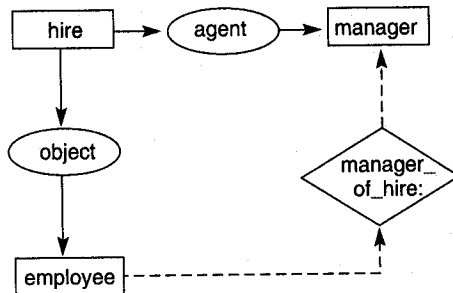
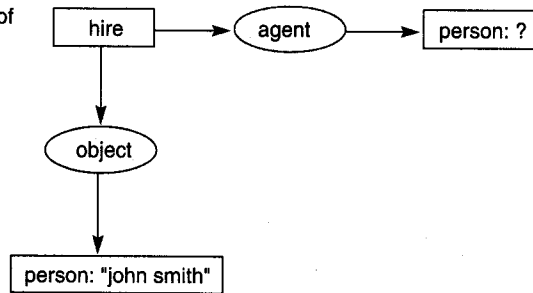
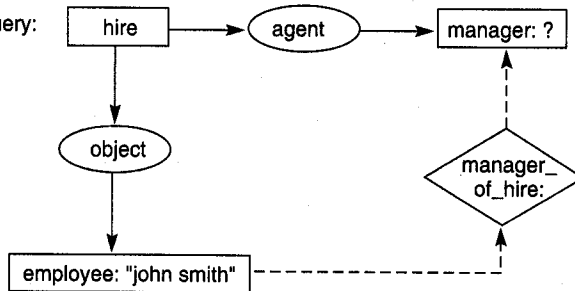

Figure 11.17 Knowledge base entry for "hire" queries.

Semantic interpretation of natural language query:



Expanded graph for query:



Query in SQL database language:

```
SELECT MANAGER
FROM MANAGER_OF_HIRE
WHERE EMPLOYEE = "john smith"
```

Figure 11.18 Development of a database query from the graph of a natural language input.

The natural language front end parses and interprets the query into a conceptual graph, as described earlier in this chapter. It then combines this graph with information in the knowledge base using join and restrict operations. In this example, we want to handle queries such as “Who hired John Smith?” or “How much does John Smith earn?” For each potential query, we store a graph that defines its verb, the case roles for that verb, and any relevant entity-relationship diagrams for the question. Figure 11.17 shows the knowledge base entry for the verb “hire.”

The semantic interpreter produces a graph of the user’s query and joins this graph with the appropriate knowledge base entry. If there is an attached entity relation graph that maps keys into the goal of the question, the program can use this entity relation graph to form a database query. Figure 11.18 shows the query graph for the question “Who hired John Smith?” and the result of joining this with the knowledge base entry from Figure 11.17. It also shows the SQL query that is formed from this graph. Note that the name of the appropriate record, the target field, and the key for the query were not specified in the natural language query. These were inferred by the knowledge base.

In Figure 11.18 the **agent** and **object** of the original query were known only to be of type **person**. To join these with the knowledge base entry for **hire**, they were first restricted to types **manager** and **employee**, respectively. The type hierarchy could thus be used to perform type checking on the original query. If **john smith** were not of type **employee**, the question would be invalid and the program could detect this.

Once the expanded query graph is built, the program examines the target concept, flagged with a **?**, and determines that the **manager_of_hire** relation mapped a key onto this concept. Because the key is bound to a value of **john smith**, the question was valid and the program could form the proper database query. Translation of the entity relationship graph into SQL or some other language is straightforward.

Although this example is simplified, it illustrates the use of a knowledge-based approach to building a natural language database front end. The ideas in our example are expressed in conceptual graphs but could be mapped into other representations such as frames or logic-based languages.

11.6 Epilogue and References

As this chapter suggests, there are a number of approaches to defining grammars and parsing sentences in natural language. We have presented ATN parsers and Markov models as a typical examples of these approaches, although the serious student should be aware of other possibilities. These include *transformational grammars*, *semantic grammars*, *case grammars*, and *feature and function grammars* (Winograd 1983, Allen 1995).

Transformational grammars use context-free rules to represent the *deep structure*, or meaning, of the sentence. This deep structure may be represented as a parse tree that not only consists of terminals and nonterminals but also includes a set of symbols called *grammatical markers*. These grammatical markers represent such features as number, tense, and other context-sensitive aspects of linguistic structure. Next, a higher-level set of rules called transformational rules transform between this deep structure and a *surface structure*, which is closer to the actual form the sentence will have. For example, "Tom likes Jane" and "Jane is liked by Tom" will have the same deep structure but different surface structures.

Transformational rules act on parse trees themselves, performing the checks that require global context and produce a suitable surface structure. For example, a transformational rule may check that the number feature of the node representing the subject of a sentence is the same as the number feature of the verb node. Transformational rules may also map a single deep structure into alternative surface structures, such as changing active to passive voice or forming an assertion into a question. Although transformational grammars are not discussed in this text, they are an important alternative to augmented phrase structure grammars.

The various grammars presented here are not intended as models of the way in which human beings process natural language. This misconception was at the root of many of the criticisms aimed at Chomsky and other early workers in natural language by people who felt that the extreme formality of these approaches was not plausibly implemented in the

human mind. Instead, as these linguists have emphasized, these models should be seen as mathematical abstractions that capture the knowledge of syntax that is used by people in the act of producing or understanding language. People may not have automated transition networks in their heads, but they do use equivalent knowledge of syntax and semantics in their everyday understanding. ATNs are a computationally feasible way of capturing this knowledge. Pinker's *The Language Instinct* (1994), discusses language as a biologically based social skill with many common aspects across situations and populations.

A comprehensive treatment of grammars and parsing for natural language is Terry Winograd's *Language as a Cognitive Process* (1983). This book offers a particularly thorough treatment of transformational grammars. *Natural Language Understanding* by James Allen (1987) provides an overview of the design and implementation of natural language understanding programs. *Introduction to Natural Language Processing* by Mary Dee Harris (1985) is another general text on natural language expanding the issues raised in this chapter. We also recommend Gerald Gazdar and Chris Mellish (1989): *Natural Language Processing in LISP*. Eugene Charniak (1993), *Statistical Language Learning*, presents further material supporting the statistical analysis of language structure and use.

The semantic analysis of natural language involves a number of difficult issues that are addressed in the literature on knowledge representation (Chapter 9). In *Computational Semantics*, Charniak and Wilks (1976) have collected articles that address these issues in the context of natural language understanding.

Because of the difficulty in modeling the knowledge and social context required for natural language interaction, many authors have questioned the possibility of moving this technology beyond constrained domains. *Understanding Computers and Cognition* by Winograd and Flores (1986), *Minds, Brains, and Programs* by John Searle (1980) and *On the Origin of Objects* (Smith 1996) address these issues.

Inside Computer Understanding by Schank and Riesbeck (1981) discusses natural language understanding using conceptual dependency technology. *Scripts, Plans, Goals and Understanding* by Schank and Abelson (1977) discusses the role of higher-level knowledge organization structures in natural language programs.

Speech Acts by John Searle (1969) discusses the role of pragmatics and contextual knowledge in modeling discourse. Fass and Wilks (1983) have proposed *semantic preference theory* as a vehicle for modeling natural language semantics. Semantic preference is a generalization of case grammars that allows transformations on case frames. This provides greater flexibility in representing semantics and allows the representation of such concepts as metaphor and analogy.

For a full discussion of the Chomsky hierarchy the reader may refer to any text on formal language theory (Hopcroft and Ullman 1979). We are indebted to John Sowa's *Conceptual Structures* (1984) for our treatment of conceptual graphs, including the discussion of modeling data base semantics.

Excellent references for keeping up with the research trends in natural language understanding, both from the traditional as well as from the stochastic viewpoints, are the annual proceedings of the AI conferences: AAAI and IJCAI, published by AAAI Press through MIT Press as well as the *Journal of the Association for Computational Linguistics*.

11.7 Exercises

1. Classify each of the following sentences as either syntactically incorrect, syntactically correct but meaningless, meaningful but untrue, or true. Where in the understanding process is each of these problems detected?

Colorless green ideas sleep furiously.

Fruit flies like a banana.

Dogs the bite man a.

George Washington was the fifth president of the USA.

This exercise is easy.

I want to be under the sea in an octopus's garden in the shade.

2. Discuss the representational structures and knowledge necessary to understand the following sentences.

The brown dog ate the bone.

Attach the large wheel to the axle with the hex nut.

Mary watered the plants.

The spirit is willing but the flesh is weak.

My kingdom for a horse!

3. Parse each of these sentences using the "dogs world" grammar of Section 10.2.1. Which of these are illegal sentences? Why?

The dog bites the dog.

The big dog bites the man.

Emma likes the boy.

The man likes.

Bite the man.

4. Extend the dogs world grammar so it will include the illegal sentences in Exercise 3.
5. Parse each of these sentences using the context-sensitive grammar of Section 10.2.3.

The men like the dog.

The dog bites the man.

6. Produce a parse tree for each of the following sentences. You will have to extend our simple grammars with more complex linguistic constructs such as adverbs, adjectives, and prepositional phrases. If a sentence has more than one parsing, diagram all of them and explain the semantic information that would be used to choose a parsing.

Time flies like an arrow but fruit flies like a banana.

Tom gave the big, red book to Mary on Tuesday.

Reasoning is an art and not a science.

To err is human, to forgive divine.

7. Extend the dogs world grammar to include adjectives in noun phrases. Be sure to allow an indeterminate number of adjectives. Hint: use a recursive rule, **adjective_list**, that either is empty or contains an adjective followed by an adjective list. Map this grammar into transition networks.

8. Add the following context-free grammar rules to the dogs world grammar of Section 10.2.1. Map the resulting grammar into transition networks.

sentence \leftrightarrow noun_phrase verb_phrase prepositional_phrase
prepositional_phrase \leftrightarrow preposition noun_phrase
preposition \leftrightarrow with
preposition \leftrightarrow to
preposition \leftrightarrow on

9. Define an ATN parser for the dogs world grammar with adjectives (Exercise 7) and prepositional phrases (Exercise 8).
10. Define concepts and relations in conceptual graphs needed to represent the meaning of the grammar of Exercise 9. Define the procedures for building a semantic representation from the parse tree.
11. Extend the context-sensitive grammar of Section 11.2.3 to test for semantic agreement between the subject and verb. Specifically, men should not bite dogs, although dogs can either like or bite men. Perform a similar modification to the ATN grammar.
12. Expand the ATN grammar of Section 11.2.4 to include *who* and *what* questions.
13. Describe how the Markov models of Section 11.4 might be combined with the more symbolic approach to understanding language of Section 11.1 – 11.3.
14. Extend the database front end example of Section 11.6.2 so that it will answer questions of the form “How much does Don Morrison earn?” You will need to extend the grammar, the representation language, and the knowledge base.
15. Assume that managers are listed in the `employee_salary` relation with other employees in the example of 11.6.2. Extend the example so that it will handle queries such as “Find any employee that earns more than his or her manager.”
16. How might the stochastic approaches of Section 11.4 be combined with the techniques for data base analysis found in Section 11.5.
17. Use of the stochastic approach for discovering patterns in a relational database is an important area of current research, sometime referred to as *data mining* (see Section 13.3). How might this work be used to answer queries, such as those posed in Section 11.5 about relational databases?

AUTOMATED REASONING

12

For how is it possible, says that acute man, that when a concept is given me, I can go beyond it and connect with it another which is not contained in it, in such a manner as if the latter necessarily belonged to the former?

—IMMANUEL KANT, “Prolegomena to a Future Metaphysics”

Any rational decision may be viewed as a conclusion reached from certain premises. . . . The behavior of a rational person can be controlled, therefore, if the value and factual premises upon which he bases his decisions are specified for him.

—SIMON, *Decision-Making and Administrative Organization*, 1944

Reasoning is an art and not a science. . . .

—WOS ET AL., *Automated Reasoning*, 1984

12.0 Introduction to Weak Methods in Theorem Proving

Wos et al. (1984) describe an *automated reasoning* program as one that “employs an unambiguous and exacting notation for representing information, precise inference rules for drawing conclusions, and carefully delineated strategies to control those inference rules.” They add that applying strategies to inference rules to deduce new information is an art: “A good choice for representation includes a notation that increases the chance for solving a problem and includes information that, though not necessary, is helpful. A good choice of inference rules is one that meshes well with the chosen representation. A good choice for strategies is one that controls the inference rules in a manner that sharply increases the effectiveness of the reasoning program.”

Automated reasoning, as just described, uses weak problem-solving methods. It uses a uniform representation such as the first-order predicate calculus (Chapter 2), the Horn clause calculus (Chapter 9), or the clause form used for resolution (Section 12.2). Its inference rules are sound and, whenever possible, complete. It uses general strategies such as breadth-first, depth-first, or best-first search and, as we see in this chapter, heuristics such as *set of support* and *unit preference* to combat the combinatorics of exhaustive search. The design of search strategies, and especially heuristic search strategies, is very much an art; we cannot guarantee that they will find a useful solution to a problem using reasonable amounts of time and memory.

Weak method problem solving is an important tool in its own right as well as an essential basis for strong method problem solving. Production systems and rule-based expert system shells are both examples of weak method problem solvers. Even though the rules of the production system or rule-based expert system encode strong problem-solving heuristics, their application is supported by general (weak method) inference strategies.

Techniques for weak method problem solving have been the focus of AI research from its beginning. Often these techniques come under the heading of *theorem proving*, although we prefer the more generic title *automated reasoning*. We begin this chapter (Section 12.1) with an early example of automated reasoning, the *General Problem Solver*, and its use of *means-ends analysis* and *difference tables* to control search.

In Section 12.2 we present an important product of research in automated reasoning, the *resolution theorem prover*. We discuss the representation language, the resolution inference rule, the search strategies, and the answer extraction processes used in resolution theorem proving. As an example of Horn clause reasoning, in Section 12.3 we describe the inference engine for PROLOG, and show how that language contributes to a philosophy of declarative programming with an interpreter based on a resolution theorem prover. We conclude this chapter (Section 12.4) with some brief comments on *natural deduction*, equality handling, and more sophisticated inference rules.

12.1 The General Problem Solver and Difference Tables

The *General Problem Solver (GPS)* (Newell and Simon 1963b; Ernst and Newell 1969) came out of research by Allen Newell and Herbert Simon at Carnegie Mellon University, then Carnegie Institute of Technology. Its roots are in an earlier computer program called the *Logic Theorist (LT)* of Newell, Shaw, and Simon (Newell and Simon 1963a). The LT program proved many of the theorems in Russell and Whitehead's *Principia Mathematica* (Whitehead and Russell 1950).

As with all weak method problem solvers, the Logic Theorist employed a uniform representation medium and sound inference rules and adopted several strategies or heuristic methods to guide the solution process. The Logic Theorist used the propositional calculus (Section 2.1) as its representation medium. The inference rules were *substitution*, *replacement*, and *detachment*.

Substitution allows any expression to be substituted for every occurrence of a symbol in a proposition that is an axiom or theorem already known to be true. For instance, $(B \vee B) \rightarrow B$ may have the expression $\neg A$ substituted for B to produce $(\neg A \vee \neg A) \rightarrow \neg A$.

Replacement allows a connective to be replaced by its definition or an equivalent form. For example, the logical equivalence of $\neg A \vee B$ and $A \rightarrow B$ can lead to the replacement of $(\neg A \vee \neg A)$ with $(A \rightarrow \neg A)$.

Detachment is the inference rule we called modus ponens (Chapter 2).

The LT applies these inference rules in a breadth-first, goal-driven fashion to the theorem to be proved, attempting to find a series of operations that lead to axioms or theorems known to be true. The strategy of LT consists of four methods organized in an *executive routine*:

First, the substitution method is directly applied to the current goal, attempting to match it against all known axioms and theorems.

Second, if this fails to lead to a proof, all possible detachments and replacements are applied to the goal and each of these results is tested for success using substitution. If substitution fails to match any of these with the goal, then they are added to a *subproblem list*.

Third, the chaining method, employing the transitivity of implication, is used to find a new subproblem that, if solved, would provide a proof. Thus, if $a \rightarrow c$ is the problem and $b \rightarrow c$ is found, then $a \rightarrow b$ is set up as a new subproblem.

Fourth, if the first three methods fail on the original problem, go to the subproblem list and select the next untried subproblem.

The executive routine continues to apply these four methods until either the solution is found, no more problems remain on the subproblem list, or the memory and time allotted to finding the proof are exhausted. In this fashion, the logic theorist executes a goal-driven, breadth-first search of the problem space.

Part of the executive routine that enables the substitution, replacement, and detachment inference rules is the *matching process*. Suppose we wish to prove $p \rightarrow (q \rightarrow p)$. The matching process first identifies one of the axioms, $p \rightarrow (q \vee p)$, as more appropriate than the others—i.e., more nearly matching in terms of a domain-defined difference—because the main connective, here \rightarrow , is the same in both expressions. Second, the matching process confirms that the expressions to the left of the main connective are identical. Finally, matching identifies the difference between expressions to the right of the main connective. This final difference, between \rightarrow and \vee , suggests the obvious replacement for proving the theorem. The matching process helps control the (exhaustive) search that would be necessary for applying all substitutions, replacements, and detachments. In fact, the matching eliminated enough of the trial and error to make the LT into a successful problem solver.

A sample LT proof shows the power of the matching process. Theorem 2.02 of *Principia Mathematica* is $p \rightarrow (q \rightarrow p)$. Matching finds the axiom $p \rightarrow (q \vee p)$ as appropriate for replacement. Substitution of $\neg q$ for q proves the theorem. Matching,

controlling substitution, and replacement rules proved this theorem directly without any search through other axioms or theorems.

In another example, suppose we wish LT to prove:

$$(p \rightarrow \neg p) \rightarrow \neg p.$$

- | | |
|--|--|
| 1. $(A \vee A) \rightarrow A$ | Matching identifies "best" axiom of five available. |
| 2. $(\neg A \vee \neg A) \rightarrow \neg A$ | Substitution of $\neg A$ for A in order to apply |
| 3. $(A \rightarrow \neg A) \rightarrow \neg A$ | replacement of \rightarrow for \vee and \neg , |
| 4. $(p \rightarrow \neg p) \rightarrow \neg p$ | substitution of p for A . |

QED

The original LT proved this theorem in about 10 seconds using five axioms. The actual proof took two steps and required no search. Matching selected the appropriate axiom for the first step because its form was much like the conclusion it was trying to establish: (expression) \rightarrow proposition. Then $\neg A$ was substituted for A . This allowed the replacement of the second and final step, which was itself motivated by the goal requiring a \rightarrow rather than a \vee .

The Logic Theorist not only was the first example of an automated reasoning system but also demonstrated the importance of search strategies and heuristics in a reasoning program. In many instances LT found solutions in a few steps that exhaustive search might never find. Some theorems were not solvable by the LT, and Newell et al. pointed out improvements that might make their solution possible.

At about this time, researchers at Carnegie and others at Yale (Moore and Anderson 1954) began to examine think-aloud protocols of human subjects solving logic problems. Although their primary goal was to identify human processes that could solve this class of problem, researchers began to compare human problem solving with computer programs, such as the Logic Theorist. This was to become the first instance of what is now referred to as *information processing psychology*, where an explanation of the observed behavior of an organism is provided by a program of primitive information processes that generates that behavior (Newell et al. 1958). This research was also some of the first work that founded the modern discipline of *Cognitive Science* (see Section 16.2, Luger 1994).

Closer scrutiny of these first protocols showed many ways that LT's solutions differed from those of the human subjects. The human behavior showed strong evidence of a matching and difference reduction mechanism referred to as a *means-ends analysis*. In means-ends analysis the difference reduction methods (the *means*) were strongly linked to the specific differences to be reduced (the *ends*): the operators for difference reduction were indexed by the differences they could reduce.

In a very simple example, if the start statement was $p \rightarrow q$ and the goal was $\neg p \vee q$, the differences would include the \rightarrow symbol in the start and \vee in the goal (as well as the difference of p in the start and $\neg p$ in the goal). The difference table would contain the different ways that a \rightarrow could be replaced by a \vee and that \neg could be removed. These transformations would be attempted one at a time until the differences were removed and the theorem was proven.

In most interesting problems the differences between start and goal could not be directly reduced. In this case an operator (from the table) was sought to partially reduce the difference. The entire procedure was applied recursively to these results until no differences existed. This might also require following different search paths, represented by different applications of reductions.

R 1.	$A \cdot B \rightarrow B \cdot A$ $A \vee B \rightarrow B \vee A$	Applies to main expression only.
R 2.	$A \supset B \rightarrow \neg B \supset \neg A$	Applies to main expression only.
R 3.	$A \cdot A \leftrightarrow A$ $A \vee A \leftrightarrow A$	A and B are two main expressions.
R 4.	$A \cdot (B \cdot C) \leftrightarrow (A \cdot B) \cdot C$ $A \vee (B \vee C) \leftrightarrow (A \vee B) \vee C$	A and $A \supset B$ are two main expressions.
R 5.	$A \vee B \leftrightarrow \neg(\neg A \cdot \neg B)$	$A \supset B$ and $B \supset C$ are two main expressions.
R 6.	$A \supset B \leftrightarrow \neg A \vee B$	
R 7.	$A \cdot (B \vee C) \leftrightarrow (A \cdot B) \vee (A \cdot C)$ $A \vee (B \cdot C) \leftrightarrow (A \vee B) \cdot (A \vee C)$	
R 8.	$A \cdot B \rightarrow A$ $A \cdot B \rightarrow B$	Applies to main expression only.
R 9.	$A \rightarrow A \vee X$	Applies to main expression only.
R 10.	$\left. \begin{matrix} A \\ B \end{matrix} \right\} \rightarrow A \cdot B$	A and B are two main expressions.
R 11.	$\left. \begin{matrix} A \\ A \supset B \end{matrix} \right\} \rightarrow B$	A and $A \supset B$ are two main expressions.
R 12.	$\left. \begin{matrix} A \supset B \\ B \supset C \end{matrix} \right\} \rightarrow A \supset C$	$A \supset B$ and $B \supset C$ are two main expressions.

Figure 12.1a Transformation rules for a logic problems, from Newell and Simon (1963).

1.	$(R \supset \sim P) \cdot (\sim R \supset Q)$	$\sim (\sim Q \cdot P)$
2.	$(\sim R \vee \sim P) \cdot (R \vee Q)$	Rule 6 applied to left and right of 1.
3.	$(\sim R \vee \sim P) \cdot (\sim R \supset Q)$	Rule 6 applied to left of 1.
4.	$R \supset \sim P$	Rule 8 applied to 1.
5.	$\sim R \vee \sim P$	Rule 6 applied to 4.
6.	$\sim R \supset Q$	Rule 8 applied to 1.
7.	$R \vee Q$	Rule 6 applied to 6.
8.	$(\sim R \vee \sim P) \cdot (R \vee Q)$	Rule 10 applied to 5. and 7.
9.	$P \supset \sim R$	Rule 2 applied to 4.
10.	$\sim Q \supset R$	Rule 2 applied to 6.
11.	$P \supset Q$	Rule 12 applied to 6. and 9.
12.	$\sim P \vee Q$	Rule 6 applied to 11.
13.	$\sim (P \cdot \sim Q)$	Rule 5 applied to 12.
14.	$\sim (\sim Q \cdot P)$	Rule 1 applied to 13. QED.

Figure 12.1b A proof of a theorem in propositional calculus, from Newell and Simon (1963).

Figure 12.1 presents one of the proofs, from Newell and Simon (1963a), generated by a human subject. Before the proof, 12 rules are given for “reducing” expressions. The human subject, without experience in formal logic, is asked to change the expression $(R \supset \sim P) \cdot (\sim R \supset Q)$ to $\sim (\sim Q \cdot P)$. In the notation of this text \sim is \neg , \cdot is \wedge , and \supset is \rightarrow . The \rightarrow or \leftrightarrow of Figure 12.1 indicates a legal replacement. The difference reduction table (called the table of connections) for this problem is included as part of Figure 12.2.

Newell and Simon called the algorithm for applying means–ends analysis using difference reduction the *General Problem Solver*. The “methods” for GPS were described by Newell and Simon (1963b) using the flow diagram of Figure 12.2.

In Figure 12.2 the goal is to transform expression A into expression B. The first step is to locate a difference D between A and B. The subgoal, reduce D, is identified in the second box of the first line, and the reduction method is described in the second line of the diagram, where the operator Q is identified for reducing difference D. Actually, a list of potential operators is identified from the table of connections. This list provides ordered alternatives for difference reduction should the chosen operator not be acceptable, for example, by not passing the *feasibility test*. In the third line of Figure 12.2 the operator is applied and D is reduced.

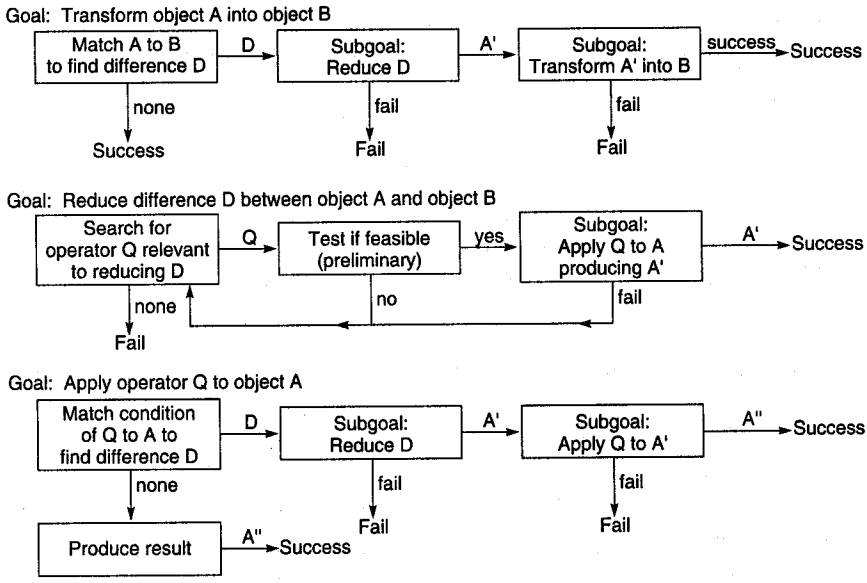

For the logic task of the text:
 Feasibility test (preliminary)
 Is the mean connective the same (e.g., $A \cdot B \rightarrow B$ fails against $P \vee Q$)?
 Is the operator too big (e.g., $(A \vee B) \cdot (A \vee C) \rightarrow A \vee (B \cdot C)$ fails against $P \cdot Q$)?
 Is the operator too easy (e.g., $A \rightarrow A \cdot A$ applies to anything)?
 Are the side conditions satisfied (e.g., R8 applies only to main expressions)?

Table of connections

	R1	R2	R3	R4	R5	R6	R7	R8	R9	R10	R11	R12
Add terms			X				X		X	X	X	X
Delete terms			X				X	X			X	X
Change connective					X	X	X					
Change sign				X								
Change lower sign		X			X	X						
Change grouping				X			X					
Change position	X	X										

X means some variant of the rule is relevant. GPS will pick the appropriate variant.

Figure 12.2 Flow chart and difference reduction table for the General Problem Solver.

The GPS model of problem solving requires two components. The first is a general procedure for comparing state descriptions and recognizing differences in them. This is similar to the matching process of the LT. The second component of the GPS model is the set of differences or *table of connections* appropriate to a particular application area. One table, like that in Figure 12.2, represents differences in propositional calculus expressions. Another could be for reducing differences between algebraic forms, and further tables could list the moves for tasks such as towers of Hanoi or more complex games such as chess. A number of the different application areas of the GPS technique are described by Ernst and Newell (1969).

The structuring of the difference reductions of a problem domain helps organize the search for that domain. A heuristic or priority order for reduction of different difference classes is implicit in the order of the transformations within the difference reduction table. This priority order might put the more generally applicable transformations before the specialized ones or give whatever order some domain expert might deem most appropriate.

A number of research directions evolved from work in the General Problem Solver. One of these is the use of AI techniques to analyze human problem-solving behavior. In particular, the production system replaced the means–ends methods of GPS as the preferred form for modeling human information processing (Chapter 16). The production rules in modern rule-based expert systems replaced the specific entries in GPS's table of differences.

In another interesting evolution of GPS, the difference table itself evolved in a further fashion, becoming the *operator table* for *planning* such as STRIPS and ABSTRIPS. Planning is important in robot problem solving. To accomplish a task, such as to go to the next room and bring back an object, the computer must develop a *plan*. This plan orchestrates the actions of the robot: put down anything it is now holding, go to the door of the present room, go through the door, find the required room, go through the door, go over to the object, and so on. Plan formation for STRIPS, the Stanford Research Institute Problem Solver (Fikes and Nilsson 1971, 1972, Sacerdotti 1974) uses an operator table not unlike the GPS table of differences. Each operator (primitive act of the robot) in this table has an attached set of *preconditions* that are much like the feasibility tests of Figure 12.2. The operator table also contains *add* and *delete lists*, which update the model of the “world” once the operator is applied. We presented a STRIPS-like planner in Chapters 5 and 9.

To summarize, the first models of automated reasoning in AI are found in the Logic Theorist and General Problem Solver developed at Carnegie Institute. Already these programs offered the full prerequisites for weak method problem solving: a uniform representation medium, a set of sound inference rules, and a set of methods or strategies for applying these rules. The same components make up the *resolution proof procedures*, a modern and more powerful basis for automated reasoning.

12.2 Resolution Theorem Proving

12.2.1 Introduction

Resolution is a technique for proving theorems in the propositional or predicate calculus that has been a part of AI problem-solving research from the mid-1960s (Bledsoe 1977, Robinson 1965, Kowalski 1979*b*). Resolution is a sound inference rule that, when used to produce a *refutation* (Section 12.2.3), is also complete. In an important practical application, resolution theorem proving, particularly the resolution refutation system, has made the current generation of PROLOG interpreters possible (Section 12.3).

The resolution principle, introduced in an important paper by Robinson (1965), describes a way of finding contradictions in a database of clauses with minimum use of substitution. Resolution refutation proves a theorem by negating the statement to be proved and adding this negated goal to the set of axioms that are known (have been assumed) to be true. It then uses the resolution rule of inference to show that this leads to a contradiction. Once the theorem prover shows that the negated goal is inconsistent with the given set of axioms, it follows that the original goal must be consistent. This proves the theorem.

Resolution refutation proofs involve the following steps:

1. Put the premises or axioms into *clause form* (12.2.2).
2. Add the negation of what is to be proved, in clause form, to the set of axioms.
3. *Resolve* these clauses together, producing new clauses that logically follow from them (12.2.3).
4. Produce a contradiction by generating the empty clause.
5. The substitutions used to produce the empty clause are those under which the opposite of the negated goal is true (12.2.4).

Resolution is a sound inference rule in the sense of Chapter 2. However, it is not complete. Resolution is *refutation complete*; that is, the empty or null clause can always be generated whenever a contradiction in the set of clauses exists. More is said on this topic when we present strategies for refutation in Section 12.2.4.

Resolution refutation proofs require that the axioms and the negation of the goal be placed in a normal form called *clause form*. Clause form represents the logical database as a set of disjunctions of *literals*. A literal is an atomic expression or the negation of an atomic expression.

The most common form of resolution, called *binary resolution*, is applied to two clauses when one contains a literal and the other its negation. If these literals contain variables, the literals must be unified to make them equivalent. A new clause is then produced consisting of the disjuncts of all the predicates in the two clauses minus the literal and its negative instance, which are said to have been “resolved away.” The resulting clause receives the unification substitution under which the predicate and its negation are found as “equivalent.”

Before this is made more precise in the subsequent subsections, we take a simple example. Resolution produces a proof similar to one produced already with modus ponens. This is not intended to show that these inference rules are equivalent (resolution is actually more general than modus ponens) but to give the reader a feel for the process.

We wish to prove that “Fido will die” from the statements that “Fido is a dog” and “all dogs are animals” and “all animals will die.” Changing these three premises to predicates and applying modus ponens gives:

1. All dogs are animals: $\forall(X) (\text{dog}(X) \rightarrow \text{animal}(X))$.
2. Fido is a dog: $\text{dog}(\text{fido})$.

3. Modus ponens and {fido/X} gives: animal (fido).
4. All animals will die: $\forall(Y) (\text{animal}(Y) \rightarrow \text{die}(Y))$.
5. Modus ponens and {fido/Y} gives: die (fido).

Equivalent reasoning by resolution converts these predicates to clause form:

PREDICATE FORM	CLAUSE FORM
1. $\forall(X) (\text{dog}(X) \rightarrow \text{animal}(X))$	$\neg \text{dog}(X) \vee \text{animal}(X)$
2. $\text{dog}(\text{fido})$	$\text{dog}(\text{fido})$
3. $\forall(Y) (\text{animal}(Y) \rightarrow \text{die}(Y))$	$\neg \text{animal}(Y) \vee \text{die}(Y)$

Negate the conclusion that Fido will die:

- | | |
|-----------------------------------|--------------------------------|
| 4. $\neg \text{die}(\text{fido})$ | $\neg \text{die}(\text{fido})$ |
|-----------------------------------|--------------------------------|

Resolve clauses having opposite literals, producing new clauses by resolution as in Figure 12.3. This process is often called *clashing*.

The symbol \square in Figure 12.3 indicates that the empty clause is produced and the contradiction found. The \square symbolizes the clashing of a predicate and its negation: the situation where two mutually contradictory statements are present in the clause space. These are clashed to produce the empty clause. The sequence of substitutions (unifications) used to make predicates equivalent also gives us the value of variables under which a goal is true. For example, had we asked whether something would die, our negated goal would have been $\neg (\exists (Z) \text{die}(Z))$, rather than $\neg \text{die}(\text{fido})$. The substitution {fido/Z} in Figure 12.3 would determine that **fido** is an instance of an animal that will die. The issues implicit in this example are made clear in the remainder of Section 12.2.

12.2.2 Producing the Clause Form for Resolution Refutations

The resolution proof procedure requires all statements in the database describing a situation to be converted to a standard form called *clause* form. This is motivated by the fact that resolution is an operator on pairs of disjuncts to produce new disjuncts. The form the database takes is referred to as a *conjunction of disjuncts*. It is a *conjunction* because all the clauses that make up the database are assumed to be true at the same time. It is a *disjunction* in that each of the individual clauses is expressed with disjunction (or \vee) as the connective. Thus the entire database of Figure 12.3 may be represented in clause form as:

$$(\neg \text{dog}(X) \vee \text{animal}(X)) \wedge (\text{animal}(Y) \vee \text{die}(Y)) \wedge (\text{dog}(\text{fido})).$$

To this expression we add (by conjunction) the negation of what we wish to prove, in this case $\neg \text{die}(\text{fido})$. Generally, the database is written as a set of disjunctions and the \wedge operators are omitted.

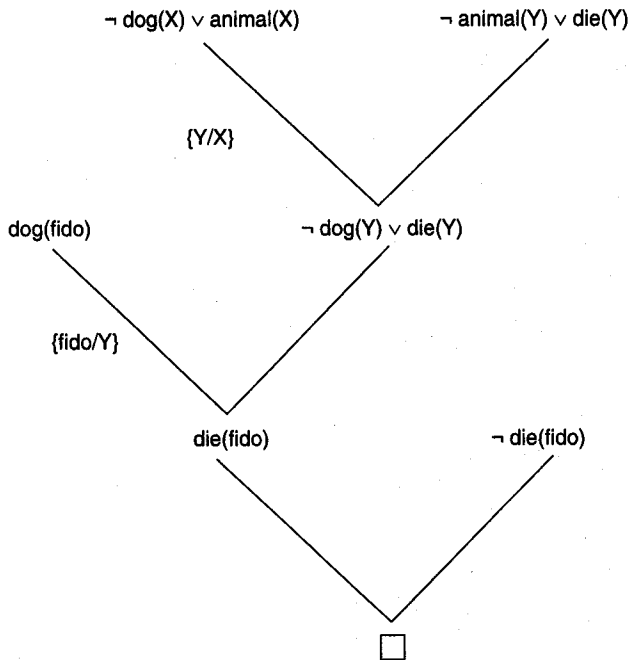

Figure 12.3 Resolution proof for the “dead dog” problem.

We now present an algorithm, consisting of a sequence of transformations, for reducing any set of predicate calculus statements to clause form. It has been shown (Chang and Lee 1973) that these transformations may be used to reduce any set of predicate calculus expressions to a set of clauses that are inconsistent if and only if the original set of expressions is inconsistent. The clause form will not be strictly equivalent to the original set of predicate calculus expressions in that certain interpretations may be lost. This occurs because skolemization restricts the possible substitutions for existentially quantified variables (Chang and Lee 1973). It will, however, preserve unsatisfiability. That is, if there was a contradiction (a refutation) within the original set of predicate calculus expressions, a contradiction exists in the clause form. The transformations do not sacrifice completeness for refutation proofs.

We demonstrate this process of conjunctive normal form reduction through an example and give a brief description rationalizing each step. These are not intended to be proofs of the equivalence of these transformations across all predicate calculus expressions.

In the following expression, according to the conventions of Chapter 2, uppercase letters indicate variables (W, X, Y, and Z); lowercase letters in the middle of the alphabet indicate constants or bound variables (l, m, and n); and early alphabetic lowercase letters indicate the predicate names (a, b, c, d, and e). To improve readability of the expressions,

we use two types of brackets: () and []. Where possible in the derivation, we remove redundant brackets: The expression we will reduce to clause form is:

$$(i) (\forall X)([a(X) \wedge b(X)] \rightarrow [c(X,l) \wedge (\exists Y)((\exists Z)[c(Y,Z)] \rightarrow d(X,Y))]) \vee (\forall X)(e(X))$$

1. First we eliminate the \rightarrow by using the equivalent form proved in Chapter 2: $a \rightarrow b \equiv \neg a \vee b$. This transformation reduces the expression in (i) above:

$$(ii) (\forall X)(\neg [a(X) \wedge b(X)] \vee [c(X,l) \wedge (\exists Y)(\neg (\exists Z)[c(Y,Z)] \vee d(X,Y))]) \vee (\forall X)(e(X))$$

2. Next we reduce the scope of negation. This may be accomplished using a number of the transformations of Chapter 2. These include:

$$\begin{aligned} \neg(\neg a) &\equiv a \\ \neg(\exists X) a(X) &\equiv (\forall X) \neg a(X) \\ \neg(\forall X) b(X) &\equiv (\exists X) \neg b(X) \\ \neg(a \wedge b) &\equiv \neg a \vee \neg b \\ \neg(a \vee b) &\equiv \neg a \wedge \neg b \end{aligned}$$

Using the second and fourth equivalences (ii) becomes:

$$(iii) (\forall X)([\neg a(X) \vee \neg b(X)] \vee [c(X,l) \wedge (\exists Y)((\forall Z)[\neg c(Y,Z)] \vee d(X,Y))]) \vee (\forall X)(e(X))$$

3. Next we standardize by renaming all variables so that variables bound by different quantifiers have unique names. As indicated in Chapter 2, because variable names are "dummies" or "place holders," the particular name chosen for a variable does not affect either the truth value or the generality of the clause. Transformations used at this step are of the form:

$$((\forall X)a(X) \vee (\forall X)b(X)) \equiv (\forall X)a(X) \vee (\forall Y)b(Y)$$

Because (iii) has two instances of the variable X, we rename:

$$(iv) (\forall X)([\neg a(X) \vee \neg b(X)] \vee [c(X,l) \wedge (\exists Y)((\forall Z)[\neg c(Y,Z)] \vee d(X,Y))]) \vee (\forall W)(e(W))$$

4. Move all quantifiers to the left without changing their order. This is possible because step 3 has removed the possibility of any conflict between variable names. (iv) now becomes:

$$(v) (\forall X)(\exists Y)(\forall Z)(\forall W)([\neg a(X) \vee \neg b(X)] \vee [c(X,l) \wedge (\neg c(Y,Z) \vee d(X,Y))] \vee e(W))$$

After step 4 the clause is said to be in *prenex normal* form, because all the quantifiers are in front as a *prefix* and the expression or *matrix* follows after.

5. At this point all existential quantifiers are eliminated by a process called *skolemization*. Expression (v) has an existential quantifier for Y. When an expression contains an existentially quantified variable, for example, $(\exists Z)(\text{foo}(\dots, Z, \dots))$, it may be concluded that there is an assignment to Z under which foo is true. Skolemization identifies such a value. Skolemization does not necessarily show *how* to produce such a value; it is only a method for giving a name to an assignment that *must* exist. If k represents that assignment, then we have $\text{foo}(\dots, k, \dots)$. Thus:

$(\exists X)(\text{dog}(X))$ may be replaced by $\text{dog}(\text{fido})$

where the name *fido* is picked from the domain of definition of X to represent that individual X. *fido* is called a *skolem constant*. If the predicate has more than one argument and the existentially quantified variable is within the scope of universally quantified variables, the existential variable must be a function of those other variables. This is represented in the skolemization process:

$(\forall X)(\exists Y)(\text{mother}(X, Y))$

This expression indicates that every person has a mother. Every person is an X and the existing mother will be a function of the particular person X that is picked. Thus skolemization gives:

$(\forall X)\text{mother}(X, m(X))$

which indicates that each X has a mother (the m of that X). In another example:

$(\forall X)(\forall Y)(\exists Z)(\forall W)(\text{foo}(X, Y, Z, W))$

is skolemized to:

$(\forall X)(\forall Y)(\forall W)(\text{foo}(X, Y, f(X, Y), W))$.

We note that the existentially quantified Z was within the scope (to the right of) universally quantified X and Y. Thus the skolem assignment is a function of X and Y but not of W. With skolemization (v) becomes:

(vi) $(\forall X)(\forall Z)(\forall W)([\neg a(X) \vee \neg b(X)] \vee [c(X, l) \wedge (\neg c(f(X), Z) \vee d(X, f(X)))] \vee e(W))$

where f is the skolem function of X that replaces the existential Y. Once the skolemization has occurred, step 6 can take place, which simply drops the prefix.

6. Drop all universal quantification. By this point only universally quantified variables exist (step 5) with no variable conflicts (step 3). Thus all quantifiers can be dropped, and any proof procedure employed assumes all variables are universally quantified. Formula (vi) now becomes:

$$(vii) [\neg a(X) \vee \neg b(X)] \vee [c(X,I) \wedge (\neg c(f(X),Z) \vee d(X,f(X)))] \vee e(W)$$

7. Next we convert the expression to the conjunct of disjuncts form. This requires using the associative and distributive properties of \wedge and \vee . Recall from Chapter 2 that

$$a \vee (b \vee c) = (a \vee b) \vee c$$

$$a \wedge (b \wedge c) = (a \wedge b) \wedge c$$

which indicates that \wedge or \vee may be grouped in any desired fashion. The distributive property of Chapter 2 is also used, when necessary. Because

$$a \wedge (b \vee c)$$

is already in clause form, \wedge is not distributed. However, \vee must be distributed across \wedge using:

$$a \vee (b \wedge c) = (a \vee b) \wedge (a \vee c)$$

The final form of (vii) is:

$$(viii) [\neg a(X) \vee \neg b(X) \vee c(X,I) \vee e(W)] \wedge [\neg a(X) \vee \neg b(X) \vee \neg c(f(X),Z) \vee d(X,f(X)) \vee e(W)]$$

8. Now call each conjunct a separate clause. In the example (viii) above there are two clauses:

$$(ixa) \neg a(X) \vee \neg b(X) \vee c(X,I) \vee e(W)$$

$$(ixb) \neg a(X) \vee \neg b(X) \vee \neg c(f(X),Z) \vee d(X,f(X)) \vee e(W)$$

9. The final step is to *standardize the variables apart* again. This requires giving the variable in each clause generated by step 8 different names. This procedure arises from the equivalence established in Chapter 2 that

$$(\forall X) (a(X) \wedge b(X)) \equiv (\forall X) a(X) \wedge (\forall Y) b(Y)$$

which follows from the nature of variable names as place holders. (ixa) and (ixb) now become, using new variable names U and V:

$$(xa) \neg a(X) \vee \neg b(X) \vee c(X,I) \vee e(W)$$

$$(xb) \neg a(U) \vee \neg b(U) \vee \neg c(f(U),Z) \vee d(U,f(U)) \vee e(W)$$

The importance of this final standardization becomes apparent only as we present the unification steps of resolution. We find the most general unification to make two predicates within two clauses equivalent, and then this substitution is made across all the variables of the same name within each clause. Thus, if some variables (needlessly) share names with

others, these may be renamed by the unification process with a subsequent (possible) loss of generality in the solution.

This nine-step process is used to change any set of predicate calculus expressions to clause form. The completeness property of resolution refutations is not lost. Next we demonstrate the resolution procedure for generating proofs from these clauses.

12.2.3 The Binary Resolution Proof Procedure

The *resolution refutation* proof procedure answers a query or deduces a new result by reducing the set of clauses to a contradiction, represented by the null clause (\square). The contradiction is produced by resolving pairs of clauses from the database. If a resolution does not produce a contradiction directly, then the clause produced by the resolution, the *resolvent*, is added to the database of clauses and the process continues.

Before we show how the resolution process works in the predicate calculus, we give an example from the propositional or variable-free calculus. Consider two *parent* clauses p1 and p2 from the propositional calculus:

$$p1: a_1 \vee a_2 \vee \dots \vee a_n$$

$$p2: b_1 \vee b_2 \vee \dots \vee b_m$$

having two literals a_i and b_j , where $1 < i \leq n$ and $1 \leq j \leq m$, such that $\neg a_i = b_j$. Binary resolution produces the clause:

$$a_1 \vee \dots \vee a_{i-1} \vee a_{i+1} \vee \dots \vee a_n \vee b_1 \vee \dots \vee b_{j-1} \vee b_{j+1} \vee \dots \vee b_m.$$

The notation above indicates that the resolvent is made up of the disjunction of all the literals of the two parent clauses except the literals a_i and b_j .

A simple argument can give the intuition behind the resolution principle. Suppose

$$a \vee \neg b \text{ and } b \vee c$$

are both true statements. Observe that one of b and $\neg b$ must always be true and one always false ($b \vee \neg b$ is a tautology). Therefore, one of

$$a \vee c$$

must always be true. $a \vee c$ is the resolvent of the two parent clauses $a \vee \neg b$ and $b \vee c$.

Consider now an example from the propositional calculus, where we want to prove a from the following axioms:

$$a \leftarrow b \wedge c$$

$$b$$

$$c \leftarrow d \wedge e$$

$$e \vee f$$

$$d \wedge \neg f$$

We reduce the first axiom to clause form:

$$a \leftarrow b \wedge c$$

$$a \vee \neg (b \wedge c) \quad \text{by } l \rightarrow m \equiv \neg l \vee m$$

$$a \vee \neg b \vee \neg c \quad \text{by de Morgan's law}$$

The remaining axioms are reduced, and we have the following clauses:

$$a \vee \neg b \vee \neg c$$

$$b$$

$$c \vee \neg d \vee \neg e$$

$$e \vee f$$

$$d$$

$$\neg f$$

The resolution proof is found in Figure 12.4. First, the goal to be proved, a , is negated and added to the clause set. The derivation of \square indicates that the database of clauses is inconsistent.

To use binary resolution in the predicate calculus, where each literal may contain variables, there must be a process under which two literals with different variable names, or one with a constant value, can be seen as equivalent. Unification was defined in Chapter 2 as the process for determining consistent and most general substitutions for making two predicates equivalent.

The algorithm for resolution on the predicate calculus is very much like that on the propositional calculus except that:

1. A literal and its negation in parent clauses produce a resolvent only if they unify under some substitution σ . σ is then applied to the resolvent before adding it to the clause set.
2. The unification substitutions used to find the contradiction offer variable bindings under which the original query is true. We explain this process, called *answer extraction*, shortly.

Occasionally, two or more literals in one clause have a unifying substitution. When this occurs there may not exist a refutation for a set of clauses containing that clause, even though the set may be contradictory. For instance, consider the clauses:

$$p(X) \vee p(f(Y))$$

$$\neg p(W) \vee \neg p(f(Z))$$

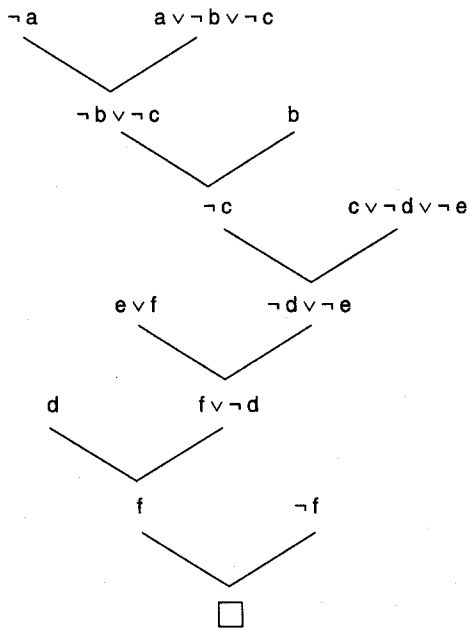

Figure 12.4 One *r*-resolution proof for an example from the propositional calculus.

The reader should note that with simple resolution these clauses can be reduced only to a tautological form and not to a contradiction.

This situation may be handled by *factoring* such clauses. If a subset of the literals in a clause has a most general unifier (Section 2.3.2), then the clause is replaced by a new clause, called a *factor* of that clause. The factor is the original clause with the most general unifier substitution applied and then redundant literals removed. For example, the two literals of the clause $p(X) \vee p(f(Y))$ will unify under the substitution $\{X/f(Y)\}$. We make the substitution in both literals to obtain the clause $p(X) \vee p(X)$ and then replace this clause with its factor: $p(X)$. Any resolution refutation system that includes factoring is refutation complete. Standardizing variables apart, Section 12.2.2 step 3, can be interpreted as a trivial application of factoring. Factoring may also be handled as part of the inference process in *hyperresolution* described in Section 12.4.2.

We now present an example of a resolution refutation for the predicate calculus. Consider the following story of the “lucky student”:

Anyone passing his history exams and winning the lottery is happy. But anyone who studies or is lucky can pass all his exams. John did not study but he is lucky. Anyone who is lucky wins the lottery. Is John happy?

First change the sentences to predicate form:

Anyone passing his history exams and winning the lottery is happy.

$$\forall X (\text{pass}(X, \text{history}) \wedge \text{win}(X, \text{lottery}) \rightarrow \text{happy}(X))$$

Anyone who studies or is lucky can pass all his exams.

$$\forall X \forall Y (\text{study}(X) \vee \text{lucky}(X) \rightarrow \text{pass}(X, Y))$$

John did not study but he is lucky.

$$\neg \text{study}(\text{john}) \wedge \text{lucky}(\text{john})$$

Anyone who is lucky wins the lottery.

$$\forall X (\text{lucky}(X) \rightarrow \text{win}(X, \text{lottery}))$$

These four predicate statements are now changed to clause form (Section 12.2.2):

1. $\neg \text{pass}(X, \text{history}) \vee \neg \text{win}(X, \text{lottery}) \vee \text{happy}(X)$
2. $\neg \text{study}(Y) \vee \text{pass}(Y, Z)$
3. $\neg \text{lucky}(W) \vee \text{pass}(W, V)$
4. $\neg \text{study}(\text{john})$
5. $\text{lucky}(\text{john})$
6. $\neg \text{lucky}(U) \vee \text{win}(U, \text{lottery})$

Into these clauses is entered, in clause form, the negation of the conclusion:

7. $\neg \text{happy}(\text{john})$

The resolution refutation graph of Figure 12.5 shows a derivation of the contradiction and, consequently, proves that John is happy.

As a final example for this subsection, suppose:

All people who are not poor and are smart are happy. Those people who read are not stupid. John can read and is wealthy. Happy people have exciting lives. Can anyone be found with an exciting life?

We assume $\forall X (\text{smart}(X) \equiv \neg \text{stupid}(X))$ and $\forall Y (\text{wealthy}(Y) \equiv \neg \text{poor}(Y))$, and get:

$$\forall X (\neg \text{poor}(X) \wedge \text{smart}(X) \rightarrow \text{happy}(X))$$

$$\forall Y (\text{read}(Y) \rightarrow \text{smart}(Y))$$

$$\text{read}(\text{john}) \wedge \neg \text{poor}(\text{john})$$

$$\forall Z (\text{happy}(Z) \rightarrow \text{exciting}(Z))$$

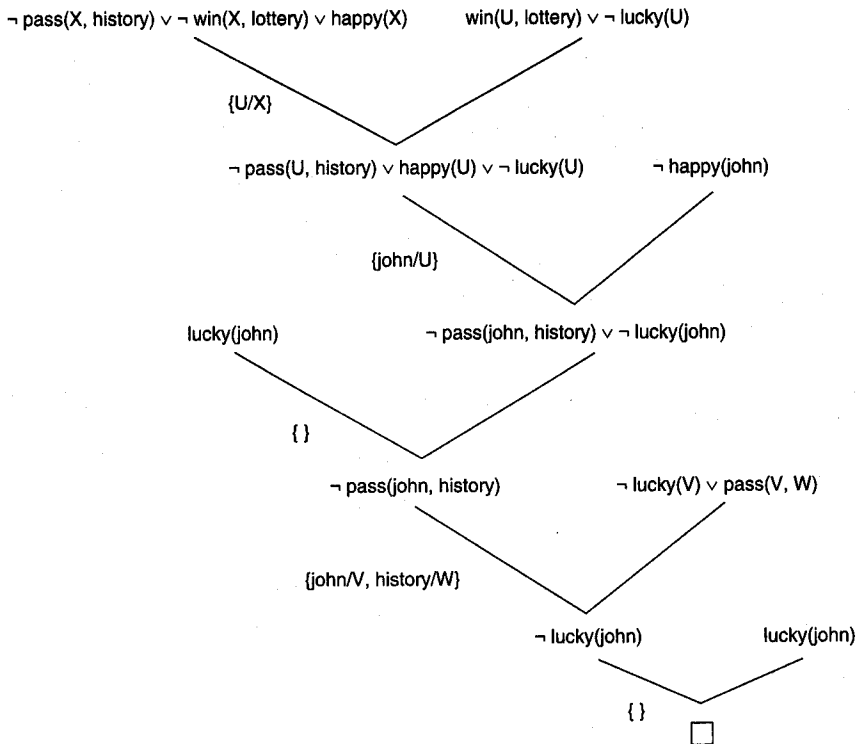

Figure 12.5 One resolution refutation for the "happy student" problem.

The negation of the conclusion is:

$$\neg \exists W (\text{exciting}(W))$$

These predicate calculus expressions for the happy life problem are transformed into the following clauses:

$$\text{poor}(X) \vee \neg \text{smart}(X) \vee \text{happy}(X)$$

$$\neg \text{read}(Y) \vee \text{smart}(Y)$$

$$\text{read}(\text{john})$$

$$\neg \text{poor}(\text{john})$$

$$\neg \text{happy}(Z) \vee \text{exciting}(Z)$$

$$\neg \text{exciting}(W)$$

The resolution refutation for this example is found in Figure 12.6.

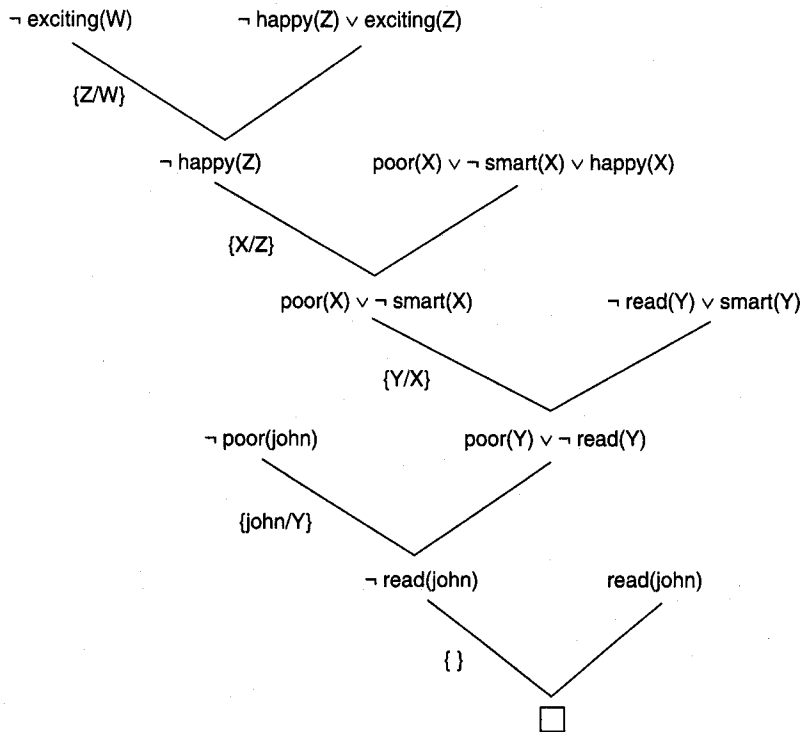

Figure 12.6 Resolution proof for the "exciting life" problem.

12.2.4 Strategies and Simplification Techniques for Resolution

A different proof tree within the search space for the problem of Figure 12.6 appears in Figure 12.7. There are some similarities in these proofs; for example, they both took five resolution steps. Also, the associative application of the unification substitutions found that John was the instance of the person with the exciting life in both proofs.

However, even these two similarities need not have occurred. When the resolution proof system was defined (Section 12.2.3) no order of clause combinations was implied. This is a critical issue: when there are N clauses in the clause space, there are N^2 ways of combining them or checking to see whether they can be combined at just the first level! The resulting set of clauses from this comparison is also large; if even 20% of them produce new clauses, the next round of possible resolutions will contain even more combinations than the first round. In a large problem this exponential growth will quickly get out of hand.

For this reason search heuristics are very important in resolution proof procedures, as they are in all weak method problem solving. As with the heuristics we considered in

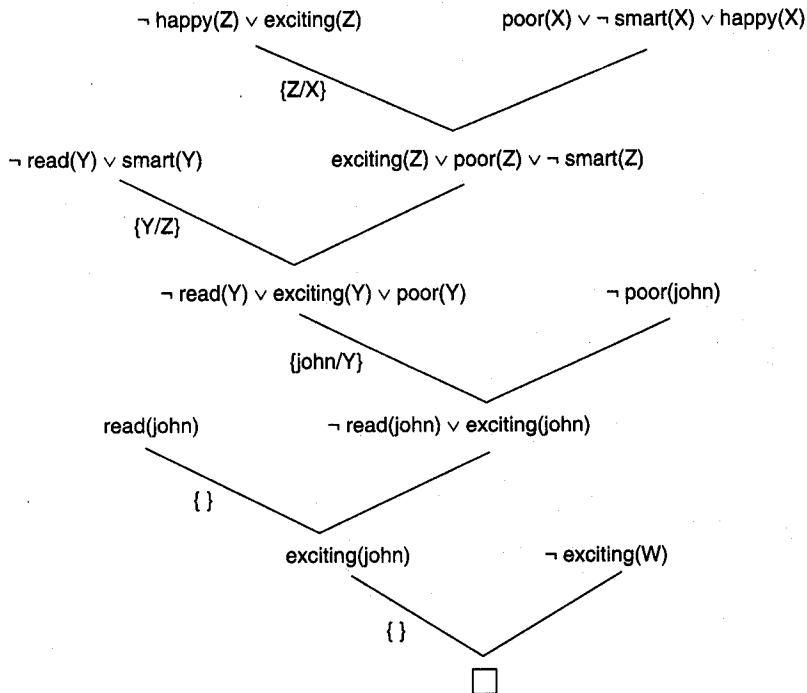

Figure 12.7 Another resolution refutation for the example of Figure 12.6.

Chapter 4, there is no science that can determine the best strategy for any particular problem. Nonetheless, some general strategies can address the exponential combinatorics.

Before we describe our strategies, we need to make several clarifications. First, based on the definition of unsatisfiability of an expression in Chapter 2, a *set of clauses is unsatisfiable* if no interpretation exists that establishes the set as satisfiable. Second, an inference rule is *refutation complete* if, given an unsatisfiable set of clauses, the unsatisfiability can be established by use of this inference rule alone. Resolution with factoring has this property (Chang and Lee 1973). Finally, a *strategy is complete* if by its use with a refutation-complete inference rule we can guarantee finding a refutation whenever a set of clauses is unsatisfiable. *Breadth-first* is an example of a complete strategy.

The Breadth-First Strategy The complexity analysis of exhaustive clause comparison just described was based on breadth-first search. Each clause in the clause space is compared for resolution with every clause in the clause space on the first round. The clauses at the second level of the search space are generated by resolving the clauses produced at the first level with all the original clauses. We generate the clauses at the n th level by resolving all clauses at level $n - 1$ against the elements of the original clause set and all clauses previously produced.

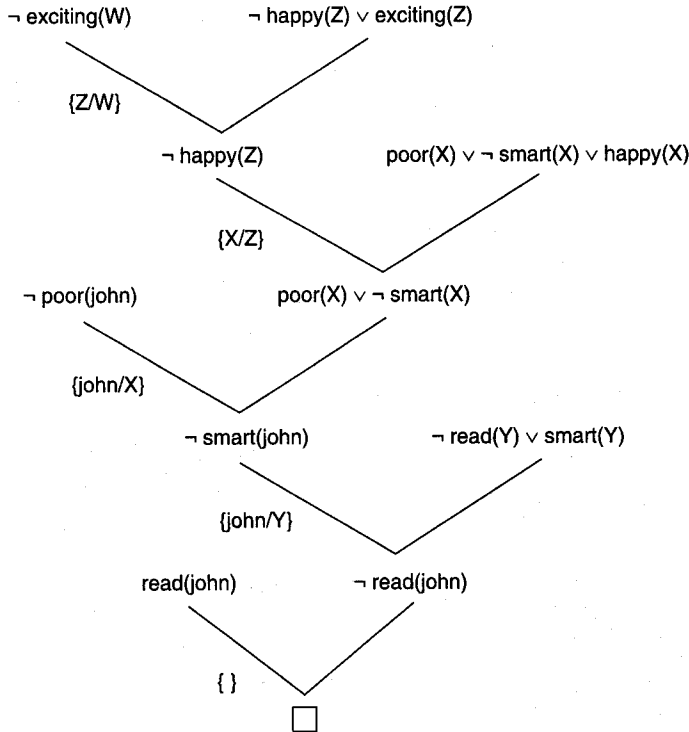

Figure 12.9 Using the unit preference strategy on the "exciting life" problem.

we produce a resultant clause that has fewer literals than the clauses that are resolved to create it, we are closer to producing the clause of no literals. In particular, resolving with a clause of one literal, called a *unit* clause, will guarantee that the resolvent is smaller than the largest parent clause. The unit preference strategy uses units for resolving whenever they are available. Figure 12.9 uses the unit preference strategy on the exciting life problem. The unit preference strategy along with the set of support can produce a more efficient complete strategy.

Unit resolution is a related strategy that requires that one of the resolvents always be a unit clause. This is a stronger requirement than the unit preference strategy. We can show that unit resolution is not complete using the same example that shows the incompleteness of linear input form.

The Linear Input Form Strategy The linear input form strategy is a direct use of the negated goal and the original axioms: take the negated goal and resolve it with one of the axioms to get a new clause. This result is then resolved with one of the axioms to get another new clause, which is again resolved with one of the axioms. This process continues until the empty clause is produced.

At each stage we resolve the clause most recently obtained with an axiom derived from the original problem statement. We never use a previously derived clause, nor do we resolve two of the axioms together. The linear input form is not a complete strategy, as can be seen by applying it to the following set of four clauses (which are obviously unsatisfiable). Regardless of which clause is taken as the negation of the goal, the linear input strategy cannot produce a contradiction:

$$\neg a \vee \neg b$$

$$a \vee \neg b$$

$$\neg a \vee b$$

$$a \vee b$$

Other Strategies and Simplification Techniques We have not attempted to present an exhaustive set of strategies or even the most sophisticated techniques for proving theorems using resolution inference. These are available in the literature, such as Wos et al. (1984) and Wos (1988). Our goal is rather to introduce the basic tools for this research area and to describe how these tools may be used in problem solving. The resolution proof procedure is but another weak method problem-solving technique.

In this sense, resolution may serve as an inference engine for the predicate calculus, but an engine that requires much analysis and careful application of strategies before success. In a problem large enough to be interesting, randomly clashing expressions together with resolution is as hopeless as striking random terminal keys and hoping a quality paper will result. The number of combinations is that large!

The examples used in this chapter are trivially small and have all the clauses necessary (and only those necessary) for their solution. This is seldom true of interesting problems. We have given several simple strategies for combating these combinatorial complexities, and we will conclude this subsection by describing a few more important considerations in designing a resolution-based problem solver. Later we show (in Section 12.3) how a resolution refutation system, with an interesting combination of search strategies, provides a “semantics” for *logic programming*, especially for the design of PROLOG interpreters.

A combination of strategies can be quite effective in controlling search—for instance, the use of set of support plus unit preference. Search heuristics may also be built into the design of rules (by creating a left-to-right ordering of literals for resolving). This order can be most effective for pruning the search space. This implicit use of strategy is important in PROLOG programming (Section 12.3).

The generality of conclusions can be a criterion for designing a solution strategy. On one side it might be important to keep intermediate solutions as general as possible, as this allows them to be used more freely in resolution. Thus the introduction of any resolution with clauses that require specialization by binding variables, such as {john/X}, should be put off as long as possible. If, on the other side, a solution requires specific variable bindings, such as in the analysis of whether John has a staph infection, the {john/Person} and {staph/Infection} substitutions may restrict the search space and increase the probability and speed of finding a solution.

An important issue in selecting a strategy is the notion of completeness. It might be very important in some applications to know that a solution will be found (if one exists). This can be guaranteed by using only complete strategies.

We can also increase efficiency by speeding up the matching process. We can eliminate needless (and costly) unifications between clauses that cannot possibly produce new resolvents by indexing each clause with the literals it contains and whether they are positive or negative. This allows us directly to find potential resolvents for any clause. Also, we should eliminate certain clauses as soon as they are produced. First, any tautological clause need never be considered; these can never be falsified and so are of no use in a solution attempt.

Another type of clause that gives no new information is one that can be *subsumed*, that is, when a new clause has a more general instance already in the clause space. For example, if $p(\text{john})$ is deduced for a space that already contains $\forall X(p(X))$, then $p(\text{john})$ may be dropped with no loss; in fact, there is a saving because there are fewer clauses in the clause space. Similarly, $p(X)$ subsumes the clause $p(X) \vee q(X)$. Less general information does not add anything to more general information when both are in the clause space.

Finally, *procedural attachment* evaluates or otherwise processes without further search any clause that can yield new information. It does arithmetic, makes comparisons between atoms or clauses, or “runs” any other deterministic procedure that can add concrete information to the problem solving or in any manner constrain the solution process. For example, we may use a procedure to compute a binding for a variable when enough information is present to do so. This variable binding then restricts possible resolutions and prunes the search space.

In the next section we show how answers may be extracted from the resolution refutation process.

12.2.5 Answer Extraction from Resolution Refutations

The instances under which an hypothesis is true are exactly the substitutions with which the refutation is found. Therefore, retaining information on the unification substitutions made in the resolution refutation gives information for the correct answer. In this subsection we give three examples of this and introduce a bookkeeping method for extracting answers from a resolution refutation.

The answer recording method is simple: retain the original conclusion that was to be proved and, into that conclusion, introduce each unification that is made in the resolution process. Thus the original conclusion is the “bookkeeper” of all unifications that are made as part of the refutation. In the computational search for resolution refutations, this might require extra pointers, such as when more than one possible choice exists in the search for a refutation. A control mechanism such as backtracking may be necessary to produce alternative solution paths. But still, with a bit of care, this added information may be retained.

Let us see some examples of this process. In Figure 12.6, where a proof was found for the existence of a person with an exciting life, the unifications of Figure 12.10 were made.

If we retain the original goal and apply all the substitutions of the refutation to this clause, we find the answer of which person it is who has an exciting life.

Figure 12.10 shows how a resolution refutation not only can show that “no one leads an exciting life” is false but also, in the process of that demonstration, can produce a happy person, John. This is a general result, where the unifications that produce a refutation are the same ones that produce the instances under which the original query is true.

A second example is the simple story:

Fido the dog goes wherever John, his master, goes. John is at the library. Where is Fido?

First we represent this story in predicate calculus expressions and then reduce these expressions to clause form. The predicates:

$at(john, X) \rightarrow at(fido, X)$

$at(john, library)$

The clauses:

$\neg at(john, Y) \vee at(fido, Y)$

$at(john, library)$

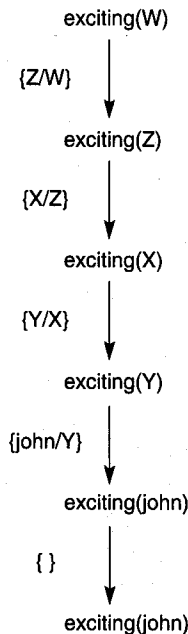

Figure 12.10 Unification substitutions of Figure 12.6 applied to the original query.

The conclusion negated:

$\neg \text{at}(\text{fido}, Z)$, Fido is nowhere!

Figure 12.11 gives the answer extraction process. The literal keeping track of unifications is the original question (where is Fido?):

$\text{at}(\text{fido}, Z)$

Once again, the unifications under which the contradiction is found tell how the original query is true: Fido is at the library.

The final example shows how the skolemization process can give the instance under which the answer may be extracted. Consider the following situation:

Everyone has a parent. The parent of a parent is a grandparent. Given the person John, prove that John has a grandparent.

The following sentences represent the facts and relationships in the situation above. First, Everyone has a parent:

$(\forall X)(\exists Y) p(X, Y)$

A parent of a parent is a grandparent.

$(\forall X)(\forall Y)(\forall Z) p(X, Y) \wedge p(Y, Z) \rightarrow gp(X, Z)$

The goal is to find a W such that $gp(\text{john}, W)$ or $\exists (W)(gp(\text{john}, W))$. The negation of the goal is $\neg \exists (W)(gp(\text{john}, W))$ or:

$\neg gp(\text{john}, W)$

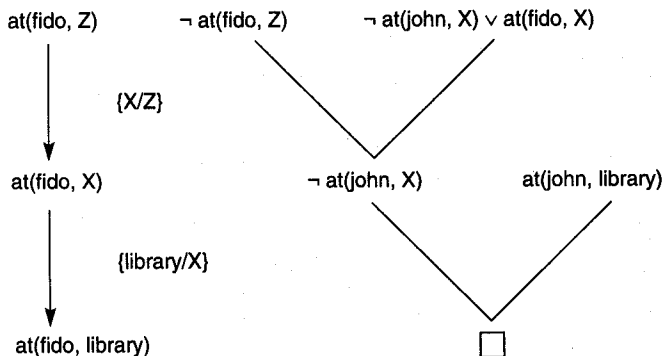

Figure 12.11 Answer extraction process on the “finding fido” problem.

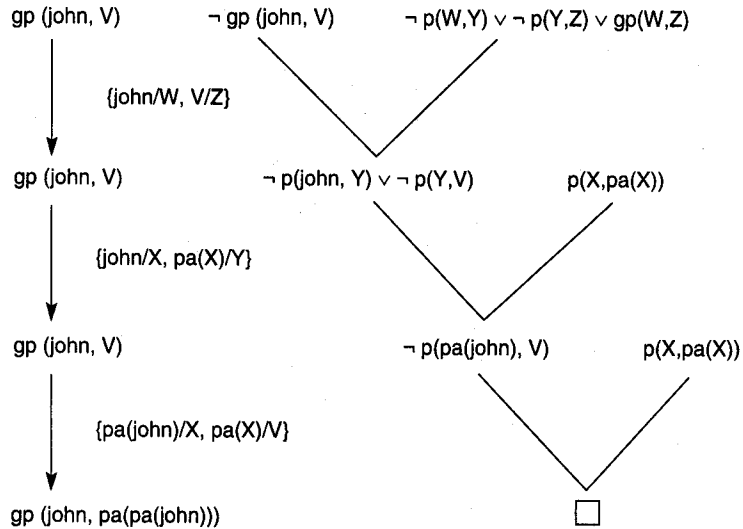

Figure 12.12 Skolemization as part of the answer extraction process.

In the process of putting the predicates above in clause form for the resolution refutation, the existential quantifier in the first predicate (everyone has a parent) requires a skolem function. This skolem function would be the obvious function: take the given X and find the parent of X . Let's call this the $pa(X)$ for "find a parental ancestor for X ." For John this would be either his father or his mother. The clause form for the predicates of this problem is:

$$\begin{aligned}
 &p(X, pa(X)) \\
 &\neg p(W, Y) \vee \neg p(Y, Z) \vee gp(W, Z) \\
 &\neg gp(john, V)
 \end{aligned}$$

The resolution refutation and answer extraction process for this problem are presented in Figure 12.12. Note that the unification substitutions in the answer are

$$gp(john, pa(pa(john)))$$

The answer to the question of whether John has a grandparent is to "find the parental ancestor of John's parental ancestor." The skolemized function allows us to compute this result.

The general process for answer extraction just described may be used in all resolution refutations, whether they be with the general unifications as in Figures 12.10 and 12.11 or from evaluating the skolem function as in Figure 12.12. The process will yield an answer. The method is really quite simple: the instances (unifications) under which the contradic-

tion is found are exactly those under which the opposite of the negated conclusion (the original query) is true. Although this subsection has not demonstrated how this is true in every instance, it has shown several examples of how the process works; further discussion can be found in the literature (Nilsson 1980, Wos et al.1984).

12.3 PROLOG and Automated Reasoning

12.3.1 Introduction

Only by understanding the implementation of a computer language can we properly guide its use, control its side effects, and have confidence in its results. In this section we describe the semantics of PROLOG, and relate it to the issues in automated reasoning presented in the previous section.

A serious criticism of the resolution proof procedure, Section 12.2, is that it requires a totally homogeneous database to represent the problem. When predicate calculus descriptors are reduced or transformed to clause form, important problem-solving information is left out. The omitted information is not the truth or fallacy of any part of the problem but rather the control hints or procedural descriptions on how to *use* the information. For example, a negated goal clause in a resolution format might be of the form:

$$a \vee \neg b \vee c \vee \neg d$$

where *a*, *b*, *c*, and *d* are literals. The resolution inference mechanism applies a search strategy to deduce the empty clause. All literals are open to the strategy and the one used depends on the particular strategy selected. The strategies used to guide resolution theorem proving are weak heuristics; they do not incorporate deep knowledge of a specific problem domain.

For example, the negated goal clause in the resolution example above might be a transformation of the predicate calculus statement:

$$a \leftarrow b \wedge \neg c \wedge d$$

This can be understood as “to see whether *a* is true go out and see whether *b* is true and *c* is false and *d* is true.” The rule was intended as a procedure for solving *a* and implements heuristic information specific to this use. Indeed, the subgoal *b* might offer the easiest way to falsify the entire predicate, so the order “try *b* then see whether *c* is false then test *d*” could save much problem-solving time. The implicit heuristic says “test the easiest way to falsify the problem first, then if this is passed go ahead and generate the remaining (perhaps much more difficult) part of the solution.” Human experts design procedures and relationships that not only are true but also contain information critical for *using* this truth. In most interesting problem-solving situations we cannot afford to ignore these heuristics (Kowalski 1979*b*).

In the next section we introduce Horn clauses and use their procedural interpretation as an explicit strategy that preserves this heuristic information.

12.3.2 Logic Programming and PROLOG

To understand the mathematical foundations of PROLOG, we first define *logic programming*. Once we have made this definition, we will add an explicit search strategy to logic programming to approximate the search strategy, sometimes referred to as the *procedural semantics*, of PROLOG. To get full PROLOG, we also discuss the use of *not* and the *closed world assumption*.

Consider the database of clauses prepared for resolution refutation, as in Section 12.2. If we restrict this set to clauses that have at most one positive literal (zero or more negative literals), we have a clause space with some interesting properties. First, problems describable with this set of clauses preserve unsatisfiability for resolution refutations, or are refutation complete, Section 12.2. Second, an important benefit of restricting our representation to this subclass of all clauses is a very efficient search strategy for refutations: a linear input form, unit preference based, left-to-right and depth-first goal reduction. With well-founded recursion (recursive calls that eventually terminate) and occurs checking, this strategy guarantees finding refutations if the clause space is unsatisfiable (van Emden and Kowalski 1976). A Horn clause contains at most one positive literal, which means it is of the form

$$a \vee \neg b_1 \vee \neg b_2 \vee \dots \vee \neg b_n$$

where a and all the b_i s are positive literals. To emphasize the key role of the one positive literal in resolutions, we generally write Horn clauses as implications with the positive literal as the conclusion:

$$a \leftarrow b_1 \wedge b_2 \wedge \dots \wedge b_n$$

Before we discuss further the search strategy, we formally define this subset of clauses, called *Horn clauses*. These, together with a *nondeterministic* goal reduction strategy, are said to constitute a *logic program*.

DEFINITION

LOGIC PROGRAM

A *logic program* is a set of universally quantified expressions in first-order predicate calculus of the form:

$$a \leftarrow b_1 \wedge b_2 \wedge b_3 \wedge \dots \wedge b_n$$

The a and b_i are all positive literals, sometimes referred to as atomic goals. The a is the clause *head*, the conjunction of b_i , the *body*.

These expressions are the *Horn clauses* of the first-order predicate calculus. They come in three forms: first, when the original clause has no positive literals; second, when it has no negative literals; and third, when it has one positive and one or more negative literals. These cases are 1, 2, and 3, respectively:

1. $\leftarrow b_1 \wedge b_2 \wedge \cdots \wedge b_n$
called a *headless* clause or *goals* to be tried: b_1 and b_2 and . . . and b_n .
2. $a_1 \leftarrow$
 $a_2 \leftarrow$
.
.
 $a_n \leftarrow$
called the *facts*.
3. $a \leftarrow b_1 \wedge \cdots \wedge b_n$
called a *rule* relation.

Horn clause calculus allows only the forms just presented; there may be only one literal to the left of \leftarrow and this literal must be positive. All literals to the right of \leftarrow are also positive.

The reduction of clauses that have at most one positive literal into Horn form requires three steps. First, select the positive literal in the clause, if there is a positive literal, and move this literal to the very left (using the commutative property of \vee). This single positive literal becomes the *head* of the Horn clause, as just defined. Second, change the entire clause to Horn form by the rule:

$$a \vee \neg b_1 \vee \neg b_2 \vee \cdots \vee \neg b_n \equiv a \leftarrow \neg (\neg b_1 \vee \neg b_2 \vee \cdots \vee \neg b_n)$$

Finally, use de Morgan's law to change this specification to:

$$a \leftarrow b_1 \wedge b_2 \cdots \wedge b_n$$

where the commutative property of \wedge can be used to order the b_i subgoals.

It should be noted that it may not be possible to transform clauses from an arbitrary clause space to Horn form. Some clauses, such as $\neg p \vee \neg q$, have no Horn form. To create a Horn clause, there can be at most one positive literal in the original clause. If this criterion is not met it may be necessary to rethink the original predicate calculus specification for the problem. The payoff for Horn form representation is an efficient refutation strategy, as we see shortly.

The computation algorithm for logic programs proceeds by nondeterministic goal reduction. At each step of the computation where there is a goal of the form:

$$\leftarrow a_1 \wedge a_2 \wedge \cdots \wedge a_n$$

the interpreter *arbitrarily* chooses some a_i for $1 \leq i \leq n$. It then *nondeterministically* chooses a clause:

$$a^1 \leftarrow b_1 \wedge b_2 \wedge \dots \wedge b_n$$

such that the a^1 unifies with a_i with substitution ζ and uses this clause to reduce the goal. The new goal then becomes:

$$(a_1 \wedge \dots \wedge a_{i-1} \wedge b_1 \wedge b_2 \wedge \dots \wedge b_n \wedge a_{i+1} \wedge \dots \wedge a_n)\zeta$$

This process of nondeterministic goal reduction continues until the computation terminates with the goal set empty.

If we eliminate the nondeterminism by imposing an order on the reduction of subgoals, we do not change the result of the computation. All results that can be found nondeterministically can be found through an exhaustive ordered search. However, by reducing the amount of nondeterminism, we can define strategies that prune unnecessary branches from the space. Thus, a major concern of practical logic programming languages is to provide the programmer with facilities to control and, when possible, reduce the amount of nondeterminism. These facilities allow the programmer to influence both the order in which the goals are reduced and the set of clauses that are used to reduce each goal.

The abstract specification of a logic program has a very clean semantics, that of the resolution refutation system. It can be shown (van Emden and Kowalski 1976) that the smallest interpretation on which a logic program is true is *the* interpretation of the program. The price paid by practical programming languages (such as PROLOG) for control is that programs executed by these interpreters may compute only a subset of their associated interpretations (Shapiro 1987).

Sequential PROLOG is an approximation to an interpreter for the logic programming model, designed for efficient execution on von Neumann computers. This is the interpreter that we have used so far in this text. Sequential PROLOG uses both the order of goals in a clause and the order of clauses in the program to control the search for a proof. When a number of goals are available, PROLOG always pursues them left to right. In the search for a unifiable clause on a goal, the possible clauses are checked in the order they are presented by the programmer. When each selection is made, a backtracking pointer is placed with the recorded unification that allows other clauses to be used (again, in the programmer's order) should the original selection of a unifiable clause fail. If this attempt fails across all possible clauses in the clause space, then the computation fails. When cut is used the interpreter may not, in fact, visit all clause combinations in the search space.

More formally, given a goal:

$$\leftarrow a_1 \wedge a_2 \wedge a_3 \dots \wedge a_n$$

and a program P , the PROLOG interpreter sequentially searches for the first clause in P whose head unifies with a_1 . This clause is then used to reduce the goals. If:

$$a^1 \leftarrow b_1 \wedge b_2 \wedge \dots \wedge b_n$$

is the reducing clause with ξ the unification, the goal clause then becomes:

$$(b_1 \wedge b_2 \wedge \cdots \wedge b_n \wedge a_2 \wedge a_3 \wedge \cdots \wedge a_n)\xi$$

The PROLOG interpreter then continues by trying to reduce the leftmost goal, b_1 in this example, using the first clause in the program P that unifies with b_1 . Suppose it is:

$$b_1 \leftarrow c_1 \wedge c_2 \wedge \cdots \wedge c_p$$

under unification ϕ . The goal then becomes:

$$(c_1 \wedge c_2 \wedge \cdots \wedge c_p \wedge b_2 \wedge \cdots \wedge b_n \wedge a_2 \wedge a_3 \wedge \cdots \wedge a_n)\xi \phi$$

Note that the goal list is treated as a **stack** enforcing depth-first search. If the PROLOG interpreter ever fails to find a unification that solves a goal it then backtracks to its most recent unification choice point, restores all bindings made since that choice point, and chooses the next clause that will unify (by the order in P). In this way, PROLOG implements its left-to-right, depth-first search of the clause space.

If the goal is reduced to the null clause (\square) then the composition of unifications that made the reductions:

$$(\square)\xi \phi \cdots \omega$$

(here $\xi \phi \cdots \omega$), provides an interpretation under which the original goal clause was true.

Besides backtracking on the order of clauses in a program, sequential PROLOG allows the *cut* or “!”. As described in Chapter 9, a cut may be placed in a clause as a goal itself. The interpreter, when encountering the cut, is committed to the current execution path and in particular to that subset of unifications made since the choice of the clause containing the cut. It also commits the interpreter to the choice of that clause itself as the only method for reducing the goal. Should failure be encountered within the clause after the cut, the entire clause fails.

Procedurally, the cut makes it unnecessary to retain backtrack pointers for the reducing clause and all its components *before* the cut. Thus, cut can mean that only some of the possible interpretations of the model are ever computed.

We summarize our discussion of sequential PROLOG by comparing it to the resolution refutation model of Section 12.2.

1. The resolution clause space is a superset of Horn clause expressions in logic programming. Each clause must have at most one positive literal to be in Horn form.
2. The following structures represent the problem in Horn form:
 - a. The goals,

$$\leftarrow b_1 \wedge b_2 \wedge \cdots \wedge b_n$$

are a list of clause statements that make up the goals to be tested by resolution refutation. Each a_i is in turn negated, unified with, and reduced until the empty clause is found (if this is possible).

b. The facts,

$$\begin{aligned} a_1 &\leftarrow \\ a_2 &\leftarrow \\ &\vdots \\ &\vdots \\ a_n &\leftarrow \end{aligned}$$

are each separate clauses for resolution. Finally,

c. The Horn clause rules or axioms,

$$a \leftarrow b_1 \wedge b_2 \wedge \cdots \wedge b_n$$

allow us to reduce matching subgoals.

3. With a unit preference, *linear input form* strategy (always preferring fact clauses and using the negated goal and its descendant resolvents; see Section 12.2.4) and applying a left-to-right, depth-first (with backtracking) order for selecting clauses for resolutions, the resolution theorem prover is acting as a PROLOG interpreter. Because this strategy is refutation complete, its use guarantees that the solution will be found (provided that part of the set of interpretations is not pruned away by using cut).
4. Finally, the composition of unifications in the proof provides the answer (interpretation) for which the goal is true. This is exactly equivalent to the answer extraction process of Section 12.2.5. Recording the composition of unifications in the goal literal produces each answer interpretation.

An important issue with current PROLOG interpreters is the *closed world* assumption implicit in their implementation. In predicate calculus, the proof of $\neg p(X)$ is exactly the proof that $p(X)$ is logically false. That is, $p(X)$ is false under every interpretation that makes the axiom set true. The PROLOG interpreter, based on the unification algorithm of Chapter 2, offers a more restricted result than the general resolution refutation of Section 12.2. Rather than trying all interpretations, it examines only those explicit in the database. We now axiomatize these constraints to see exactly the restrictions implicit in PROLOG.

For every predicate p , and every variable X belonging to p , suppose a_1, a_2, \dots, a_n make up the domain of X . The PROLOG interpreter, using unification, enforces:

1. The *unique name* axiom. For all atoms of the domain $a_i \neq a_j$ unless they are identical. This implies that atoms with distinct names are distinct.
2. The *closed world* axiom.

$$p(X) \rightarrow p(a_1) \vee p(a_2) \vee \cdots \vee p(a_n).$$

This means the only possible instances of a relation are those implied by the clauses present in the problem specification.

3. The *domain closure* axiom.

$$(X = a_1) \vee (X = a_2) \vee \cdots \vee (X = a_n).$$

This guarantees that the atoms occurring in the problem specification constitute all and the only atoms.

These three axioms are implicit in the action of the PROLOG interpreter. They may be seen as added to the set of Horn clauses making up a problem description and thus as constraining the set of possible interpretations to a PROLOG query.

Intuitively, this means that PROLOG assumes as false all goals that it cannot prove to be true. This can introduce anomalies: if a goal's truth value is actually unknown to the current database, PROLOG will assume it to be false.

Other limitations are implicit in PROLOG, as they seem to be in all computing languages. The most important of these, besides the problem of negation as failure, represent violations of the semantic model for logic programming. In particular, there are the lack of an occurs check (see Chapters 2 and 9; this allows a clause to unify with a subset of itself) and the use of cut. The current generation of PROLOG interpreters should be looked at pragmatically. Some problems arise because "no efficient way is currently known" to get around the issue (the occurs check); others arise from attempts to optimize use of the depth-first with backtrack search (the cut). Many of the anomalies of PROLOG are a result of trying to implement the nondeterministic semantics of pure logic programming on a sequential computer. This includes the problems introduced by the cut.

In the final section of Chapter 12 we introduce alternative inferencing schemes for automated reasoning.

12.4 Further Issues in Automated Reasoning

We described weak method problem solvers as using (a) a *uniform representation medium* for (b) *sound inference rules* that focus on syntactic features of the representation and are guided by (c) *methods or strategies* for combating the combinatorics of exhaustive search. We conclude this chapter with further comments on each of these aspects of the weak method solution process.

12.4.1 Uniform Representations for Weak Method Solutions

The resolution proof procedure requires us to place all our axioms in clause form. This uniform representation then allows us to resolve clauses and simplifies the design of problem-solving heuristics. One major disadvantage of this approach is that much valuable heuristic information can be lost in this uniform encoding.

The if . . . then format of a rule often conveys more information for use of modus ponens or production system search than one of its syntactic variants. It also offers us an efficient way to use the rule. For instance, If the engine does not turn over and the

lights do not come on then the battery may be dead tells us exactly how to check the battery.

The disjunctive form of the same rule obscures this heuristic information about how the rule should be applied. If we express this rule in predicate calculus $\neg \text{turns_over} \wedge \neg \text{lights} \rightarrow \text{battery}$, the clause form of this rule is this: $\text{turns_over} \vee \text{lights} \vee \text{battery}$. This clause can have a number of equivalent forms, and each of these represents a different implication.

$(\neg \text{turns_over} \wedge \neg \text{lights}) \rightarrow \text{battery}$
 $(\neg \text{turns_over} \rightarrow (\text{battery} \vee \text{lights}))$
 $(\neg \text{battery} \wedge \neg \text{lights}) \rightarrow \text{turns_over}$
 $(\neg \text{battery} \rightarrow (\text{turns_over} \vee \text{lights}))$

and so on.

To retain heuristic information in the automated reasoning process several researchers, including Nilsson (1980), advocate reasoning methods that encode heuristics by forming rules according to the way in which the human expert might design the rule relationships. We have proposed this approach already in our and/or graph reasoning in Section 3.3. and the PROLOG form of automated reasoning of Section 12.3. Rule-based expert systems also allow the programmer to control search through the structure of rules. We develop the idea further with the next two examples, one data-driven and the second goal-driven. Both of these retain the form of implications and use this information to guide search through an and/or graph.

Consider, for use in data-driven reasoning, the following facts, rules (axioms), and goal:

Fact:

$(a \vee (b \wedge c))$

Rules (or axioms):

$(a \rightarrow (d \wedge e))$

$(b \rightarrow f)$

$(c \rightarrow (g \vee h))$

Goal:

$e \vee f$

The proof of $e \vee f$ is found in the and/or graph of Figure 12.13. Note the use of and connectors on \vee relations and the or connectors on \wedge relations in the data-driven search space. If we are given that either a or $b \wedge c$ is true, then we must reason with both disjuncts to guarantee that our argument is truth preserving; hence these two paths are conjoined. When b and c are true, on the other hand, we can continue to explore either of

these conjuncts. Rule matching takes any intermediate state, such as c , and replaces it with the conclusion of a rule, such as $(g \vee h)$, whose premise matches that state. The discovery of both states e and f in Figure 12.13 indicates that the goal $(e \vee f)$ is established.

In a similar fashion we can use matching of rules on **and/or** graphs for goal-driven reasoning. When a goal description includes a \vee , as in the example of Figure 12.14, then either alternative can be explored independently to establish the goal. If the goal is a conjunction, then, of course, both conjuncts must be established.

Goal:

$$(a \vee (b \wedge c))$$

Rules (or axioms):

$$(f \wedge d) \rightarrow a$$

$$(e \rightarrow (b \wedge c))$$

$$(g \rightarrow d)$$

Fact:

$$f \wedge g$$

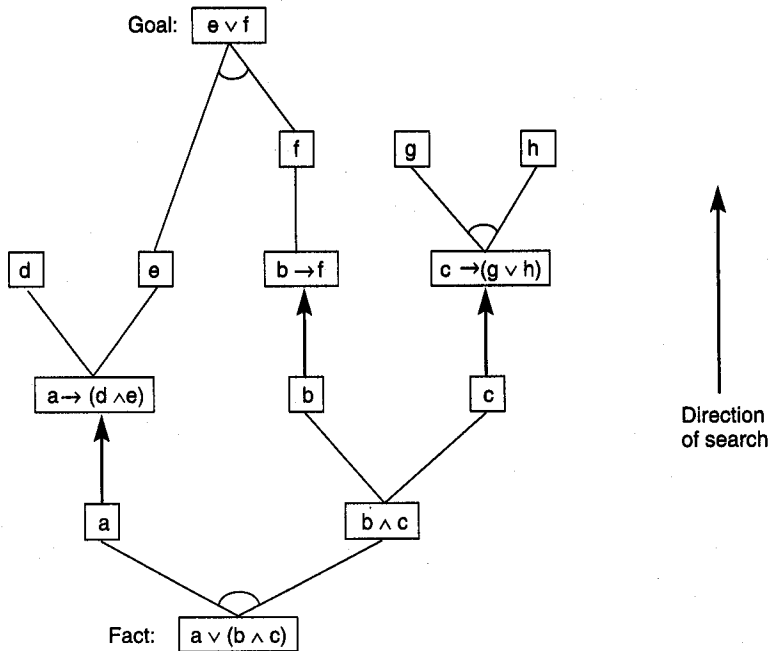

Figure 12.13 Data-driven reasoning with an **and/or** graph in the propositional calculus.

Although these examples are taken from the propositional calculus, a similar search is generated using predicate calculus facts and rules. Unification makes literals compatible for applying inference rules across different branches of the search space. Of course, unifications must be consistent (that is, unifiable) across different and branches of the search space.

This subsection has suggested solution methods to help preserve heuristic information within the representational medium for weak method problem solving. This is essentially the way the inference engines of expert systems allow the programmer to specify control and heuristic information in a rule. Expert systems rely on the rule form, such as the ordering of rules or the ordering of the premises within a rule, for control of search rather than depending totally on general weak problem-solving methods. What is lost in this approach is the ability to apply uniform proof procedures, such as resolution, across the full set of rules. As can be noted in the examples of Figures 12.13 and 12.14, modus ponens may still be used, however. Production system control using either depth-first, breadth-first, or best-first search offers one weak method reasoning architecture for implementing rule systems (see examples in Chapters 4, 5, 9, and 10).

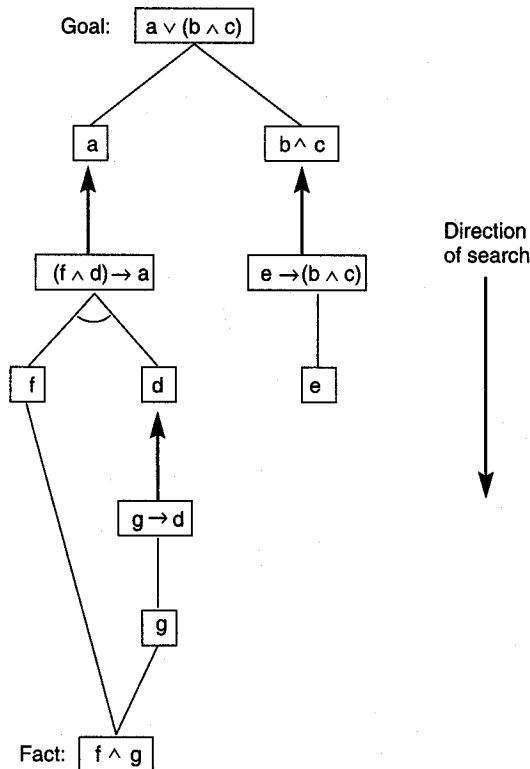

Figure 12.14 Goal-driven reasoning with an and/or graph in the propositional calculus.

12.4.2 Alternative Inference Rules

Resolution is the most general sound inference rule we have presented so far. Several more sophisticated inference rules have been created in an attempt to make resolution more efficient. We briefly consider two of these: *hyperresolution* and *paramodulation*.

Resolution, as we have presented it, is actually a special variant called *binary resolution*: exactly two parent clauses are clashed. A successful application of hyperresolution replaces a sequence of binary resolutions to produce one clause. Hyperresolution clashes, in a single step, a clause with some negative literals, referred to as the *nucleus*, and a number of clauses with all positive literals, called the *satellites*. These satellites must have one positive literal that will match with a negative literal of the nucleus. There must also be one satellite for each negative literal of the nucleus. Thus the result of an application of hyperresolution is a clause with all positive literals.

An advantage of hyperresolution is that a clause of all positive literals is produced from each hyperresolution inference, and the clause space itself is kept smaller because no intermediate results are produced. Unifications across all clauses in the inference step must be consistent.

As an example of hyperresolution, consider the following clause set:

$\neg \text{married}(X,Y) \vee \neg \text{mother}(X,Z) \vee \text{father}(Y,Z)$
 $\text{married}(\text{kate},\text{george}) \vee \text{likes}(\text{george},\text{kate})$
 $\text{mother}(\text{kate},\text{sarah})$

We draw a conclusion in one step using hyperresolution:

$\text{father}(\text{george},\text{sarah}) \vee \text{likes}(\text{george},\text{kate})$

The first clause in the example is the nucleus; the second two are satellites. The satellites are all positive, and there is one for each negative literal in the nucleus. Note how the nucleus is just the clause form for the implication:

$\text{likes}(X,Y) \wedge \text{mother}(X,Z) \rightarrow \text{father}(Y,Z)$

The conclusion of this rule is part of the final result. Note that there are no intermediate results, such as:

$\neg \text{mother}(\text{kate},Z) \vee \text{father}(\text{george},Z) \vee \text{married}(\text{george},\text{kate})$

which we would find in any binary resolution proof applied to the same clause space.

Hyperresolution is sound and complete when used by itself. When combined with other strategies, such as set of support, completeness may be compromised (Wos et al. 1984). It does require special search strategies to organize the satellite and nucleus clauses, although in most environments where hyperresolution is used, the clauses are often indexed by the name and positive or negative property of each literal. This makes it efficient to prepare the nucleus and satellite clauses for the hyperresolution inference.

Perhaps the most difficult issue in the design of theorem-proving mechanisms is the control of equality. Especially difficult are application areas, such as mathematics, where most facts and relationships have multiple representations, such as can be obtained by applying the associative and commutative properties to expressions. To convince yourself of this with a very simple example, consider the multiple ways the arithmetic expression $3 + (4 + 5)$ can be represented, including $3 + ((4 + 0) + 5)$. This is a difficult issue in that expressions need to be substituted for, unified with, and checked for equality with other expressions within automated mathematical problem solving.

Demodulation is the process of rephrasing or rewriting expressions so they automatically take on a chosen canonical form. The unit clauses used to produce this canonical form are *demodulators*. Demodulators specify the equality of different expressions, allowing us to replace an expression with its canonical form. With proper use of demodulators all newly produced information is reduced to a specified form before it is placed in the clause space. For example, we might have a demodulator:

`equal(father(father(X)),grandfather(X))`

and the new clause:

`age(father(father(sarah)),86).`

Before adding this new clause to the clause space, we apply the demodulator and add instead:

`age(grandfather(sarah),86).`

The equality problem here is one of naming. Do we wish to classify a person as `father(father(X))` or `grandfather(X)`? Similarly, we can pick out canonical names for all family relations: a `brother(father(Y))` is `uncle(Y)`, etc. Once we pick the canonical names to store information under, we then design demodulators such as the `equal` clause to reduce all new information to this determined form. Note that demodulators are always unit clauses.

Paramodulation is a generalization of equality substitution at the term level. For example, given the expression:

`older(mother(Y),Y)`

and the equality relationship:

`equal(mother(sarah),kate)`

we can conclude with paramodulation:

`older(kate,sarah)`

Note the term-level matching and replacement of {sarah/Y} and mother(sarah) for kate. A vital difference between demodulation and paramodulation is that the latter allows a nontrivial replacement of variables in both the arguments of the equality predicate and the predicate into which the substitution is made. Demodulation does replacement based on the demodulator. Multiple demodulators may be used to get an expression into its final form; paramodulation is usually used only once in any situation.

We have given simple examples of these powerful inference mechanisms. They should be seen as more general techniques for use in a resolution clause space. Like all the other inference rules we have seen, these are tightly linked to the chosen representation and must be controlled by appropriate strategies.

12.4.3 Search Strategies and Their Use

Sometimes the domain of application puts special demands on the inference rules and heuristics for guiding their use. We have already seen the use of demodulators for assistance in equality substitution. Bledsoe, in his *natural deduction system*, identifies two important strategies for preparing theorems for resolution proof. He calls these strategies *split* and *reduce* (Bledsoe 1971).

Bledsoe designed his strategies for use in mathematics and, in particular, for application to *set theory*. The effect of these strategies is to break a theorem into parts to make it easier to prove by conventional methods such as resolution. Split takes various mathematical forms and splits them to appropriate pieces. The proof of $A \wedge B$ is equivalent to the proof of A and the proof of B . Similarly, the proof of $A \leftrightarrow B$ is the proof of $A \rightarrow B$ and the proof of $A \leftarrow B$.

The heuristic reduce also attempts to break down large proofs to their components. For example, the proof of $s \in A \cap B$ may be decomposed into the proofs of $s \in A$ and $s \in B$. Another example might be to prove some property true of $\neg(A \cup B)$ by proving the property for $\neg A$ and for $\neg B$. By breaking up larger proofs into smaller pieces, Bledsoe hopes to contain the search space. His heuristics also include a limited use of equality substitution.

As mentioned throughout this book, the appropriate use of heuristics is very much an art that takes into account the application area as well as the representation and inference rules used. We close this chapter by citing some general proverbs, all of which are sometimes false but which can, with careful use, be very effective. These proverbs sum up thoughts taken from researchers in the area (Bledsoe 1971, Nilsson 1980, Wos et al. 1984, Wos 1988) as well as our own reflections on weak method problem solvers. We state them without further comment.

Use, whenever possible, clauses with fewer literals.

Break the task into subtasks before employing general inferencing.

Use equality predicates whenever this is appropriate.

Use demodulators to create canonical forms.

Use paramodulation when inferencing with equality predicates.

Use strategies that preserve “completeness.”

Use set of support strategies, for these contain the potential contradiction.

Use units within resolution, as these shorten the resulting clause.

Perform subsumption checks with new clauses.

Use an ordering mechanism on clauses and literals within the clauses that reflect your intuitions and problem-solving expertise.

12.5 Epilogue and References

Automated reasoning programs and other weak method problem solvers are very important in artificial intelligence. They are used both to design general search strategies in game playing and theorem proving and to support much of our knowledge-based reasoning. Thus we see them in the design of “shells” for expert systems and inference mechanisms for network representations.

Weak method solvers require choosing a representational medium, inference mechanisms, and search strategies. These three choices are intricately interwoven and cannot be made in isolation from each other. The application domain also affects the choice of representation, inference rules, and strategies. The “proverbs” at the end of the previous section should be considered in making these choices.

Resolution is the process of constraining possible interpretations until it is seen that the clause space with the inclusion of the negated goal is inconsistent. This text does not go into the soundness of resolution or the completeness of resolution refutations. The arguments for these important issues are based on Herbrand’s theorem (Chang and Lee 1973) and the notion of possible interpretations of the clause set. The interested reader is encouraged to go to the references for these proofs.

A number of other references are appropriate: Chang and Lee (1973) is a very readable introductory text. *Automated Theorem Proving: A Logical Basis* offers a formal approach (Loveland 1978). A number of classic early papers in the field are collected in a series *The Automation of Reasoning: Collected Papers, 1957 to 1970* (Siekman and Wrightson 1983a, b). Nilsson (1980), Genesereth and Nilsson (1987), Kowalski (1979b), Lloyd (1984) Wos et al. (1984), and Wos (1988) offer valuable summaries of important concepts in automated reasoning. Robinson (1965) and Bledsoe (1977) have made fundamental contributions to the field. An important theorem-proving research contribution is made by Boyer and Moore (1979). The early theorem-proving work by Newell and Simon and their colleagues at Carnegie Institute of Technology is reported in *Computers and Thought* (Feigenbaum and Feldman 1963) and *Human Problem Solving* (Newell and Simon 1972).

12.6 Exercises

1. Take the logic-based financial advisor of Section 2.4, put the predicates describing the problem into clause form, and use resolution refutations to answer queries such as whether a particular investor should make an investment(combination).
2. Use resolution to prove Wirth's statement in Exercise 12, Chapter 2.
3. Use resolution to answer the query in Example 3.3.4.
4. In Chapter 5 we presented a simplified form of the knight's tour. Take the path3 rule, put it in clause form, and use resolution to answer queries such as path3(3,6). Next, use the recursive path call, in clause form, to answer queries.
5. How might you use resolution to implement a "production system" search?
6. How would you do data-driven reasoning with resolution? Use this to address the search space of Exercise 1. What problems might arise in a large problem space?
7. Use resolution for queries in the farmer, wolf, goat, and cabbage problem of Section 9.3.
8. Use resolution to solve the following puzzle problem from Wos et al. (1984). There are four people: Roberta, Thelma, Steve, and Pete. The four hold eight different jobs. Each person has exactly two jobs. The jobs are, without sex bias, chef, guard, nurse, telephonist, police officer, teacher, actor, and boxer. The nurse is a male. The husband of the chef is the telephonist. Roberta is not a boxer. Pete has no education past the ninth grade. Roberta, the chef, and the police officer went golfing together. Who holds which jobs? Show how the addition of a sex bias changes the problem.
9. Work out two examples for hyperresolution where the nucleus has at least four literals.
10. Write a demodulator for sum that would cause clauses of the form equal(ans, sum(5, sum(6, minus(6)))) to be reduced to equal(ans, sum(5, 0)). Write a further demodulator to reduce this last result to equal(ans, 5).
11. Pick a "canonical set" of six family relations. Write demodulators to reduce alternative forms of relations to the set. For example, your "mother's brother" is "uncle."
12. Take the happy student problem of Figure 12.5 and apply three of the refutation strategies of Section 12.2.4 to its solution.
13. Put the following predicate calculus expression in clause form:
$$\forall (X)(p(X) \rightarrow \{\forall (Y)[p(Y) \rightarrow p(f(X,Y))] \wedge \neg \forall (Y)[q(X,Y) \rightarrow p(Y)]\})$$
14. Create the and/or graph for the following data-driven predicate calculus deduction.
Fact: $\neg d(f) \vee [b(f) \wedge c(f)]$.
Rules: $\neg d(X) \rightarrow \neg a(X)$ and $b(Y) \rightarrow e(Y)$ and $g(W) \leftarrow c(W)$.
Prove: $\neg a(Z) \vee e(Z)$.

15. Prove the linear input form strategy is not refutation complete.
16. Create the and/or graph for the following problem. Why is it impossible to conclude the goal:
 $r(Z) \vee s(Z)$?
Fact: $p(X) \vee q(X)$.
Rules: $p(a) \rightarrow r(a)$ and $q(b) \rightarrow s(b)$.
17. Use factoring and resolution to produce a refutation for the following clauses:
 $p(X) \vee p(f(Y))$ and $\neg p(W) \vee \neg p(f(Z))$. Try to produce a refutation without factoring.
18. Derive a resolution proof of the theorem of Figure 12.1.
19. An alternative semantic model for logic programming is that of *Flat Concurrent PROLOG*. Compare the semantics of PROLOG seen in Section 12.3 with that of Flat Concurrent PROLOG (Shapiro 1987).

MACHINE LEARNING: SYMBOL-BASED

The mind being, as I have declared, furnished with a great number of the simple ideas conveyed in by the senses, as they are found in exterior things, or by reflection on its own operations, takes notice, also, that a certain number of these simple ideas go constantly together . . . which, by inadvertency, we are apt afterward to talk of and consider as one simple idea.

—JOHN LOCKE, *Essay Concerning Human Understanding*

The mere observing of a thing is no use whatever. Observing turns into beholding, beholding into thinking, thinking into establishing connections, so that one may say that every attentive glance we cast on the world is an act of theorizing. However, this ought to be done consciously, with self criticism, with freedom, and to use a daring word, with irony.

—GOETHE

13.0 Introduction

The ability to learn must be part of any system that would claim to possess general intelligence. Indeed, in our world of symbols and interpretation, the very notion of an unchanging intellect is a contradiction in terms. Intelligent agents must be able to change through the course of their interactions with the world, as well as through the experience of their own internal states and processes. We present three chapters on machine learning, reflecting three approaches to the problem, first from the symbol-based view, second, from the connectionist view, and finally, from the genetic or evolutionary perspective

Learning is important for practical applications of artificial intelligence. Feigenbaum and McCorduck (1983) have called the “knowledge engineering bottleneck” the major obstacle to the widespread use of expert systems. This “bottleneck” is the cost and difficulty of building expert systems using traditional knowledge acquisition techniques. One solution to this problem would be for programs to begin with a minimal amount of

knowledge and learn from examples, high-level advice, or their own explorations of the domain.

Herbert Simon defines learning as:

any change in a system that allows it to perform better the second time on repetition of the same task or on another task drawn from the same population (Simon, 1983).

This definition, although brief, suggests many of the issues involved in developing programs that learn. One important issue is the underconstrained nature of empirical learning. Learning involves generalization from experience: performance should improve not only on the “repetition of the same task,” but also on similar tasks in the domain. Because interesting domains tend to be large, a learner may only examine a fraction of all possible examples; from this limited experience, the learner must acquire knowledge that will generalize correctly to unseen instances of the domain. This is the problem of *induction*, and it is central to learning. In most learning problems, the available training data are not sufficient to guarantee optimal generalization, no matter what algorithm the learner uses. Learning algorithms must generalize heuristically: they must select those aspects of their experience that are most likely to prove effective in the future. Such selection criteria are known as *inductive biases*.

Simon’s definition describes learning as allowing the system to “perform better the second time.” As the previous paragraph indicates, selecting the possible changes to a system that will allow it to improve is a difficult task. Learning research must address the possibility that changes may actually degrade performance. Preventing and detecting such problems is another problem for a learning algorithm.

Learning involves changes in the learner; this is obvious. However, the exact nature of those changes and the best way to represent them are far from obvious. One approach models learning as the acquisition of explicitly represented domain knowledge. Based on its experience, the learner constructs or modifies expressions in a formal language, such as logic, and retains this knowledge for future use. Symbolic approaches, characterized by the algorithms of Sections 13.2 through 13.6, build on the assumptions of knowledge-based systems: the primary influence on the program’s behavior is its base of explicitly represented domain knowledge.

Neural or connectionist networks, in contrast, do not learn by acquiring sentences in a symbolic language. Like an animal brain, which consists of a large number of interconnected nerve cells, neural networks are systems of interconnected, artificial neurons. The program’s knowledge is implicit in the organization and interaction of these neurons. Rather than constructing an explicit model of the world, they are shaped by it. Neural nets do not learn by adding representations to their knowledge base, instead, they learn by modifying their overall structure in order to adapt to the contingencies of the world they inhabit. In Chapter 14, we examine the neural or connectionist approach.

In Chapter 15, we consider *genetic* and *evolutionary learning*. Certainly one of the strongest models of learning we have may be seen in the human and animal systems that have evolved towards equilibration with the world. This approach to learning through adaptation is reflected in genetic algorithms, genetic programming, and artificial life research.

Machine learning has proven to be a fruitful area of research, spawning a number of different problems and algorithms for their solution. These algorithms vary in their goals, in the available training data, and in the learning strategies and knowledge representation languages they employ. However, all of these algorithms learn by searching through a space of possible concepts to find an acceptable generalization. In Section 13.1, we outline a framework for symbol-based machine learning that emphasizes the common assumptions behind all of this work.

Although Section 13.1 outlines a variety of learning tasks, this chapter focuses primarily on *inductive learning*. Induction, which is learning a generalization from a set of examples, is one of the most fundamental learning tasks. *Concept learning* is a typical inductive learning problem: given examples of some concept, such as “cat,” “soybean disease,” or “good stock investment,” we attempt to infer a definition that will allow the learner to correctly recognize future instances of that concept. Sections 13.2 and 13.3 examine two algorithms used for concept induction, *version space search* and *ID3*.

Section 13.4 considers the role of *inductive bias* in learning. The search spaces encountered in learning tend to be extremely large, even by the standards of search-based problem solving. These complexity problems are exacerbated by the problem of choosing among the different generalizations supported by the training data. Inductive bias refers to any method a learning program uses to constrain the space of possible generalizations.

The algorithms of Sections 13.2 and 13.3 are data-driven. They use no prior knowledge of the learning domain but rely on large numbers of examples to define the essential properties of a general concept. Algorithms that generalize on the basis of patterns in training data are referred to as *similarity-based*. In contrast to similarity-based methods, a learner may use prior knowledge of the domain to guide generalization. For example, humans, particularly as they move out of infancy, do not require large numbers of examples to learn effectively. Often, a single example, analogy, or high-level bit of advice is sufficient to communicate a general concept. Humans are able to learn in this fashion because we draw on our existing knowledge of the domain. The effective use of such knowledge can help an agent to learn more efficiently, and with less likelihood of error. Section 13.5 examines *explanation-based learning*, learning by analogy and other techniques that utilize prior knowledge to learn from a limited amount of training data.

The algorithms presented in Sections 13.2 through 13.5, though they differ in search strategies, representation languages, and the amount of prior knowledge used, all assume that the training data are classified by a teacher or some other means. The learner is told whether an instance is a positive or negative example of a target concept. This reliance on training instances of known classification defines the task of *supervised learning*.

Section 13.6 continues the study of induction by examining *unsupervised learning*, which addresses how an intelligent agent can acquire useful knowledge in the absence of correctly classified training data. This important area of investigation underlies tasks as diverse as scientific discovery, learning in autonomous robots, and modeling human cognition. *Category formation*, or *conceptual clustering*, is a fundamental problem in unsupervised learning. Given a set of objects exhibiting various properties, how may an agent divide the objects into useful categories? How do we know whether a category is useful? What is the best way to represent those categories? In this section, we examine CLUSTER/2 and COBWEB, two category formation algorithms. All of the approaches in

this chapter have one thing in common: they model learning as a variety of state space search. In the next section, we outline a general, search-based framework for research in machine learning.

13.1 A Framework for Symbol-Based Learning

Learning algorithms may be characterized along several dimensions, as in Figure 13.1:

1. *The data and goals of the learning task.* One of the primary ways in which we characterize learning problems is according to the goals of the learner and the data it is given. The concept learning algorithms of Sections 13.2 and 13.3, for example, begin with a collection of positive (and usually negative) examples of a target class; the goal is to infer a general definition that will allow the learner to recognize future instances of the class. In contrast to the data-intensive approach taken by these algorithms, *explanation-based learning* (Section 13.5), attempts to infer a general concept from a single training example and a prior base of domain-specific knowledge. The conceptual clustering algorithms discussed in Section 13.6 illustrate another variation on the induction problem: instead of a set of training instances of known categorization, these algorithms begin with a set of unclassified instances. Their task is to discover categorizations that may have some utility to the learner.

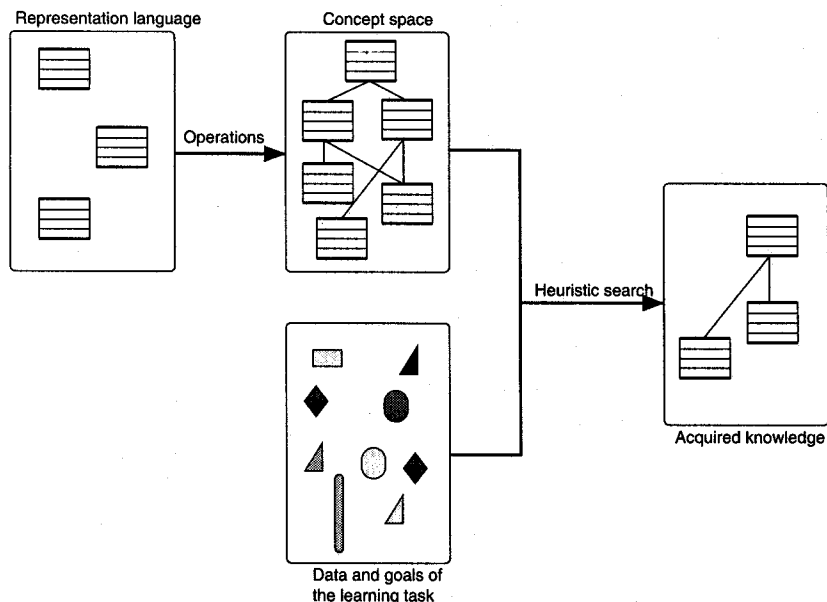

Figure 13.1 A general model of the learning process.

Examples are not the only source of training data. Humans, for instance, often learn from high-level advice. In teaching programming, professors generally tell their students that all loops must achieve a terminating condition. This advice, though correct, is not directly useful: it must be translated into specific rules for manipulating loop counters or logical conditions in a programming language. Analogies (Section 13.5.4) are another type of training data that must be correctly interpreted before they can be of use. If a teacher tells a student that electricity is like water, the student must infer the correct intent of the analogy: as water flows through a pipe, electricity flows through a wire. As with flowing water, we may measure the amount of electricity (amperage) and the pressure behind the flow (voltage). Unlike water, however, electricity does not make things wet or help us wash our hands. The interpretation of analogies involves finding the meaningful similarities and avoiding false or meaningless inferences.

We may also characterize a learning algorithm by the goal, or *target*, of the learner. The goal of many learning algorithms is a *concept*, or a general description of a class of objects. Learning algorithms may also acquire plans, problem-solving heuristics, or other forms of procedural knowledge.

The properties and quality of the training data itself are another dimension along which we classify learning tasks. The data may come from a teacher from the outside environment, or it may be generated by the program itself. Data may be reliable or may contain noise. It can be presented in a well-structured fashion or consist of unorganized data. It may include both positive and negative examples or only positive examples. Data may be readily available, the program may have to construct experiments, or perform some other form of data acquisition.

2. *The representation of learned knowledge.* Machine learning programs have made use of all the representation languages discussed in this text. For example, programs that learn to classify objects may represent these concepts as expressions in predicate calculus or they may use a structured representation such as frames or objects. Plans may be described as a sequence of operations or a triangle table. Heuristics may be represented as problem-solving rules.

A simple formulation of the concept learning problem represents instances of a concept as conjunctive sentences containing variables. For example, instances of the concept "ball" may be represented by:

$$\begin{aligned} &\text{size}(\text{obj1}, \text{small}) \wedge \text{color}(\text{obj1}, \text{red}) \wedge \text{shape}(\text{obj1}, \text{round}) \\ &\text{size}(\text{obj2}, \text{large}) \wedge \text{color}(\text{obj2}, \text{red}) \wedge \text{shape}(\text{obj2}, \text{round}) \end{aligned}$$

and the general concept "ball" would be defined by:

$$\text{size}(X, Y) \wedge \text{color}(X, Z) \wedge \text{shape}(X, \text{round})$$

Any sentence that unifies with this general definition represents a ball.

3. *A set of operations.* Given a set of training instances, the learner must construct a generalization, heuristic rule, or plan that satisfies its goals. This requires the ability to manipulate representations. Typical operations include generalizing or

specializing symbolic expressions, adjusting the weights in a neural network, or otherwise modifying the program's representations.

In the concept learning example just introduced, a learner may generalize a definition by replacing constants with variables. If we begin with the concept:

$$\text{size}(\text{obj1}, \text{small}) \wedge \text{color}(\text{obj1}, \text{red}) \wedge \text{shape}(\text{obj1}, \text{round})$$

replacing a single constant with a variable produces the generalizations:

$$\begin{aligned} &\text{size}(\text{obj1}, X) \wedge \text{color}(\text{obj1}, \text{red}) \wedge \text{shape}(\text{obj1}, \text{round}) \\ &\text{size}(\text{obj1}, \text{small}) \wedge \text{color}(\text{obj1}, X) \wedge \text{shape}(\text{obj1}, \text{round}) \\ &\text{size}(\text{obj1}, \text{small}) \wedge \text{color}(\text{obj1}, \text{red}) \wedge \text{shape}(\text{obj1}, X) \\ &\text{size}(X, \text{small}) \wedge \text{color}(X, \text{red}) \wedge \text{shape}(X, \text{round}) \end{aligned}$$

4. *The concept space.* The representation language, together with the operations described above, defines a space of potential concept definitions. The learner must search this space to find the desired concept. The complexity of this concept space is a primary measure of the difficulty of a learning problem.
5. *Heuristic search.* Learning programs must commit to a direction and order of search, as well as to the use of available training data and heuristics to search efficiently. In our example of learning the concept "ball," a plausible algorithm may take the first example as a *candidate concept* and generalize it to include subsequent examples. For instance, on being given the single training example

$$\text{size}(\text{obj1}, \text{small}) \wedge \text{color}(\text{obj1}, \text{red}) \wedge \text{shape}(\text{obj1}, \text{round})$$

the learner will make that example a candidate concept; this concept correctly classifies the only positive instance seen.

If the algorithm is given a second positive instance

$$\text{size}(\text{obj2}, \text{large}) \wedge \text{color}(\text{obj2}, \text{red}) \wedge \text{shape}(\text{obj2}, \text{round})$$

the learner may generalize the candidate concept by replacing constants with variables as needed to form a concept that matches both instances. The result is a more general candidate concept that is closer to our target concept of "ball."

$$\text{size}(X, Y) \wedge \text{color}(X, \text{red}) \wedge \text{shape}(X, \text{round})$$

Patrick Winston's work (1975a) on learning concepts from positive and negative examples illustrates these components. His program learns general definitions of structural concepts, such as "arch," in a blocks world. The training data is a series of positive and negative examples of the concept: examples of blocks world structures that fit in the category, along with *near misses*. The latter are instances that almost belong to the category but fail on one property or relation. The near misses enable the program to single out features that can be used to exclude negative instances from the target concept. Figure 13.2 shows positive examples and near misses for the concept "arch."

The program represents concepts as semantic networks, as in Figure 13.3. It learns by refining a candidate description of the target concept as training instances are presented. Winston's program refines candidate descriptions through generalization and specialization. Generalization changes the graph to let it accommodate new examples of the concept. Figure 13.3a shows an arch built of three bricks and a graph that describes it. The next training example, Figure 13.3b is an arch with a pyramid rather than a brick on top. This example does not match the candidate description. The program matches these graphs, attempting to find a partial isomorphism between them. The graph matcher uses the node names to guide the matching process. Once the program matches the graphs, it may detect differences between them. In Figure 13.3, the graphs match on all components except that the top element in the first graph is brick and the corresponding node of the second example is pyramid. Part of the program's background knowledge is a generalization hierarchy of these concepts, Figure 13.3c. The program generalizes the graph by replacing this node with the least common supertype of brick and pyramid; in this example, it is polygon. The result is the concept of Figure 13.3d.

When presented with a near miss, an example that differs from the target concept in a single property, the program specializes the candidate description to exclude the example. Figure 13.4a is a candidate description. It differs from the near miss of Figure 13.4b in the

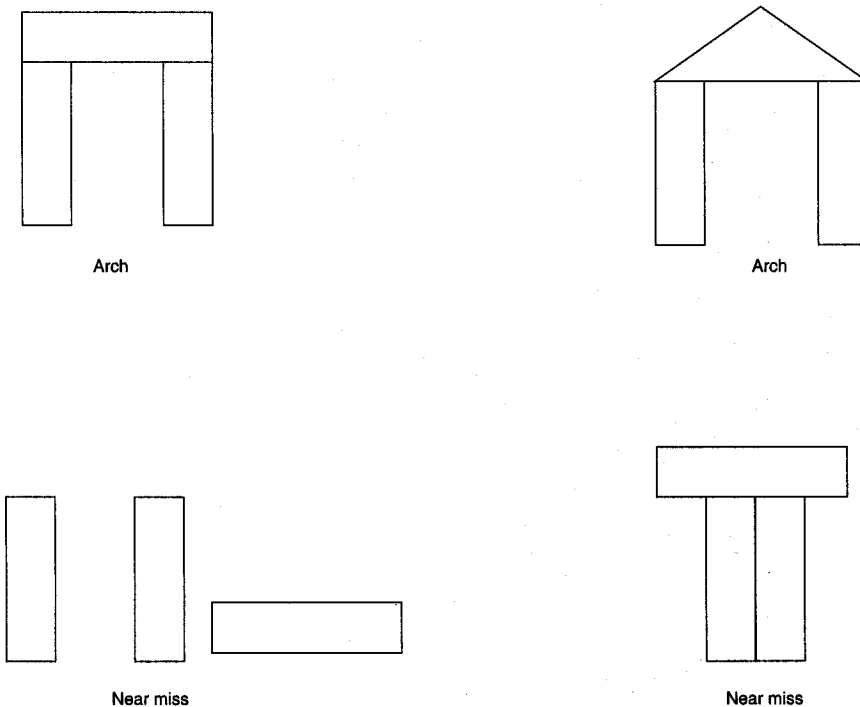
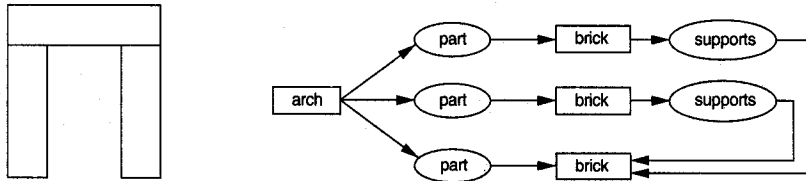

Figure 13.2 Examples and near misses for the concept "arch."

touch relations of the near-miss example. The program specializes the graph by adding **must-not-touch** links to exclude the near miss, Figure 13.4c. Note that the algorithm depends heavily upon the closeness of the negative examples to the target concept. By differing from the goal in only a single property, a near miss helps the algorithm to determine exactly how to specialize the candidate concept.

a. An example of an arch and its network description.



b. An example of another arch and its network description.

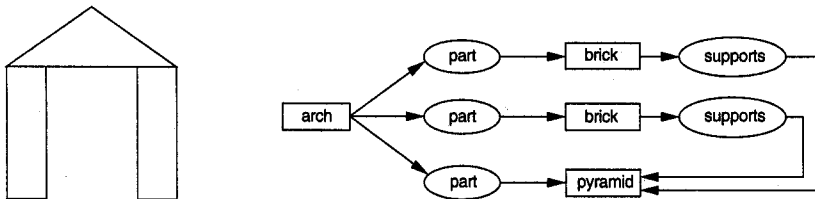

c. Given background knowledge that bricks and pyramids are both types of polygons.

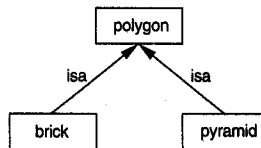

d. Generalization that includes both examples.

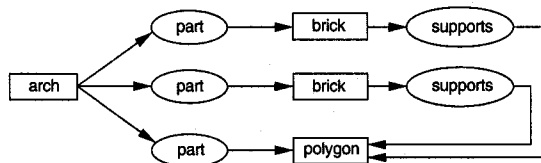
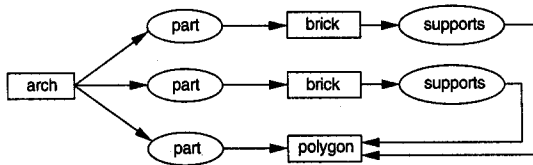

Figure 13.3 Generalization of descriptions to include multiple examples.

These operations—specializing a network by adding links and generalizing it by replacing node or link names with a more general concept—define a space of possible concept definitions. Winston’s program performs a hill climbing search on the concept space guided by the training data. Because the program does not backtrack, its performance is highly sensitive to the order of the training examples; a bad ordering can lead the program to dead ends in the search space. Training instances must be presented to the program in an order that assists learning of the desired concept, much as a teacher organizes lessons to help a student learn. The quality and order of the training examples are also important to the program’s graph matching algorithm; efficient matching requires that the graphs not be too dissimilar.

a. Candidate description of an arch.



b. A near miss and its description.

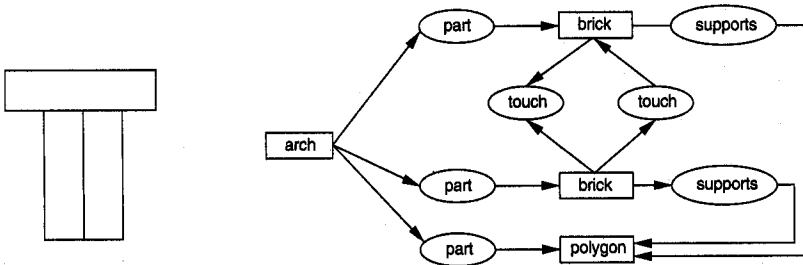

c. Arch description specialized to exclude the near miss.

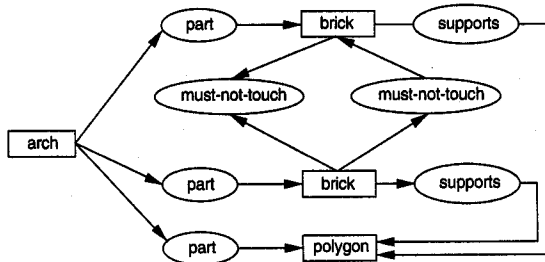

Figure 13.4 Specialization of a description to exclude a near miss.

Although an early example of inductive learning, Winston's program illustrates the features and problems shared by the majority of machine learning techniques: the use of generalization and specialization operations to define a concept space, the use of data to guide search through that space, and the sensitivity of the learning algorithm to the quality of the training data. The next sections examine these problems and the techniques that machine learning has developed for their solution.

13.2 Version Space Search

Version space search (Mitchell 1982) illustrates the implementation of inductive learning as search through a concept space. Version space search takes advantage of the fact that generalization operations impose an ordering on the concepts in a space, and then uses this ordering to guide the search.

13.2.1 Generalization Operators and the Concept Space

Generalization and specialization are the most common types of operations for defining a concept space. The primary generalization operations used in machine learning are:

1. Replacing constants with variables. For example,

color(ball, red)

generalizes to

color(X, red)

2. Dropping conditions from a conjunctive expression.

shape(X, round) \wedge size(X, small) \wedge color(X, red)

generalizes to

shape(X, round) \wedge color(X, red)

3. Adding a disjunct to an expression.

shape(X, round) \wedge size(X, small) \wedge color(X, red)

generalizes to

shape(X, round) \wedge size(X, small) \wedge (color(X, red) \vee color(X, blue))

4. Replacing a property with its parent in a class hierarchy. If we know that `primary_color` is a superclass of `red`, then

color(X, red)

generalizes to

color(X, primary_color)

We may think of generalization in set theoretic terms: let P and Q be the sets of sentences matching the predicate calculus expressions p and q , respectively. Expression p is more general than q iff $P \supseteq Q$. In the above examples, the set of sentences that match `color(X, red)` contains the set of elements that match `color(ball, red)`. Similarly, in example 2, we may think of the set of round, red things as a superset of the set of small, red, round things. Note that the “more general than” relationship defines a partial ordering on the space of logical sentences. We express this using the “ \geq ” symbol, where $p \geq q$ means that p is more general than q . This ordering is a powerful source of constraints on the search performed by a learning algorithm.

We formalize this relationship through the notion of *covering*. If concept p is more general than concept q , we say that p covers q . We define the covers relation: let $p(x)$ and $q(x)$ be descriptions that classify objects as being positive examples of a concept. In other words, for an object x , $p(x) \rightarrow \text{positive}(x)$ and $q(x) \rightarrow \text{positive}(x)$. p covers q iff $q(x) \rightarrow \text{positive}(x)$ is a logical consequence of $p(x) \rightarrow \text{positive}(x)$.

For example, `color(X, Y)` covers `color(ball, Z)`, which in turn covers `color(ball, red)`. As a simple example, consider a domain of objects that have properties and values:

```
size = {large, small}
colors = {red, white, blue}
shape = {ball, brick, cube}
```

These objects can be represented using the predicate `obj(Size, Color, Shape)`. The generalization operation of replacing constants with variables defines the space of Figure 13.5. We may view inductive learning as searching this space for a concept that is consistent with all the training examples.

13.2.2 The Candidate Elimination Algorithm

This section presents three algorithms (Mitchell 1982) for searching the concept space. These algorithms rely upon the notion of a *version space*, which is the set of all concept descriptions consistent with the training examples. These algorithms work by reducing the size of the version space as more examples become available. The first two algorithms reduce the version space in a specific to general direction and a general to specific direction, respectively. The third algorithm, called *candidate elimination*, combines these approaches into a bi-directional search. We next describe and evaluate these algorithms.

These algorithms are data driven; they generalize based on regularities found in the training data. Also, in using training data of known classification, these algorithms perform a variety of *supervised learning*.

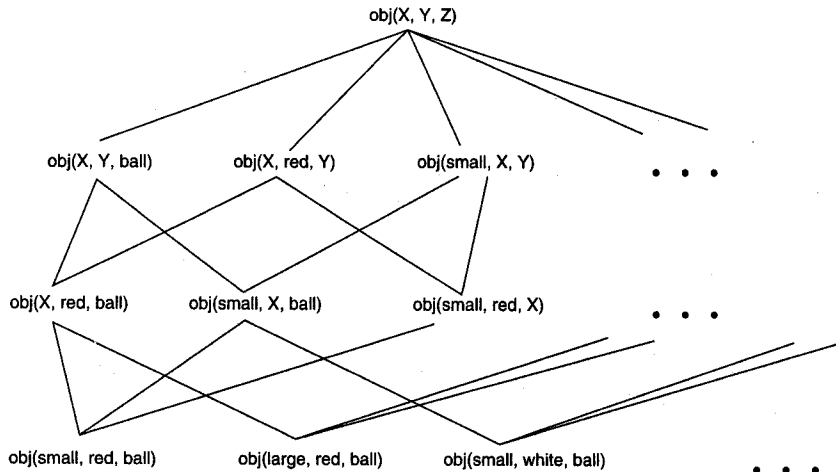

Figure 13.5 A concept space.

As with Winston's program for learning structural descriptions, version space search uses both positive and negative examples of the target concept. Although it is possible to generalize from positive examples only, negative examples are important in preventing the algorithm from overgeneralizing. Not only must the learned concept be general enough to cover all positive examples; it also must be specific enough to exclude all negative examples. In the space of Figure 13.5, one concept that would cover all sets of exclusively positive instances would simply be $\text{obj}(X, Y, Z)$. However, this concept is probably too general, because it implies that all instances belong to the target concept. One way to avoid overgeneralization is to generalize as little as possible to cover positive examples; another is to use negative instances to eliminate overly general concepts. As Figure 13.6 illustrates, negative instances prevent overgeneralization by forcing the learner to specialize concepts in order to exclude negative instances. The algorithms of this section use both of these techniques. We define *specific to general* search, for hypothesis set S , as:

```

Begin
  Initialize  $S$  to the first positive training instance;
   $N$  is the set of all negative instances seen so far;

  For each positive instance  $p$ 
    Begin
      For every  $s \in S$ , if  $s$  does not match  $p$ , replace  $s$  with its most specific
        generalizations that match  $p$ ;
      Delete from  $S$  all hypotheses more general than some other hypothesis in  $S$ ;
      Delete from  $S$  all hypotheses that match a previously observed negative
        instance in  $N$ ;
    End;
  
```

```

For every negative instance n
  Begin
  Delete all members of S that match n;
  Add n to N to check future hypotheses for overgeneralization;
  End;
End

```

Specific to general search maintains a set, S , of *hypotheses*, or candidate concept definitions. To avoid overgeneralization, these candidate definitions are the *maximally specific generalizations* from the training data. A concept, c , is maximally specific if it covers all positive examples, none of the negative examples, and for any other concept, c' , that covers the positive examples, $c \leq c'$. Figure 13.7 shows an example of applying this algorithm to the version space of Figure 13.5.

We may also search in a general to specific direction. This algorithm maintains a set, G , of *maximally general concepts* that cover all of the positive and none of the negative instances. A concept, c , is maximally general if it covers none of the negative training instances, and for any other concept, c' , that covers no negative training instance, $c \geq c'$. In this algorithm, negative instances lead to the specialization of candidate concepts; the algorithm uses positive instances to eliminate overly specialized concepts.

```

Begin
Initialize G to contain the most general concept in the space;
P contains all positive examples seen so far;

For each negative instance n
  Begin
  For each  $g \in G$  that matches n, replace g with its most general specializations
  that do not match n;
  Delete from G all hypotheses more specific than some other hypothesis in G;
  Delete from G all hypotheses that fail to match some positive example in P;
  End;

For each positive instance p
  Begin
  Delete from G all hypotheses that fail to match p;
  Add p to P;
  End;
End

```

Figure 13.8 shows an example of applying this algorithm to the version space of Figure 13.5. In this example, the algorithm uses background knowledge that *size* may have values {large, small}, *color* may have values {red, white, blue}, and *shape* may have values {ball, brick, cube}. This knowledge is essential if the algorithm is to specialize concepts by substituting constants for variables.

The *candidate elimination algorithm* combines these approaches into a bi-directional search of the version space. As we shall see, this bi-directional approach has a number of benefits for the learner. The algorithm maintains two sets of candidate concepts: G is the

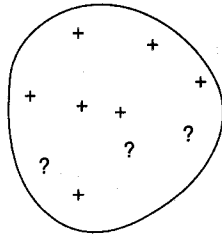

Concept induced from positive examples only

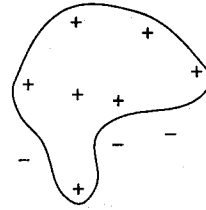

Concept induced from positive and negative examples

Figure 13.6 The role of negative examples in preventing overgeneralization.

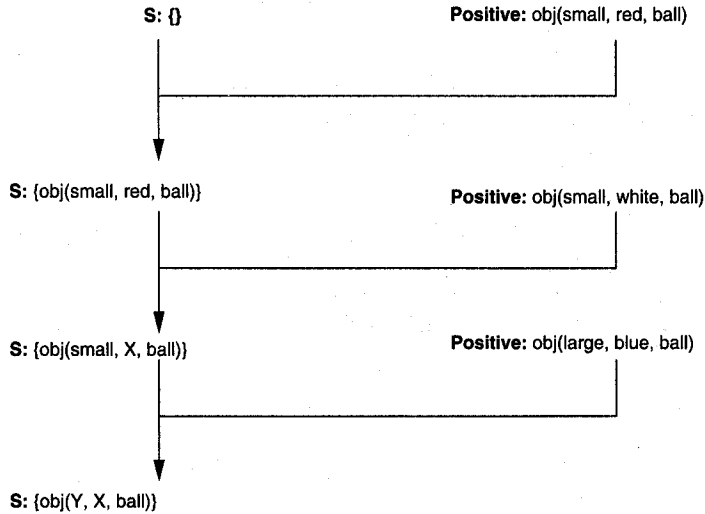

Figure 13.7 Specific to general search of the version space learning the concept "ball."

set of maximally general candidate concepts, and S is the set of maximally specific candidates. The algorithm specializes G and generalizes S until they converge on the target concept. The algorithm is defined:

Begin
 Initialize G to be the most general concept in the space;
 Initialize S to the first positive training instance;

For each new positive instance p

 Begin

 Delete all members of G that fail to match p;

 For every $s \in S$, if s does not match p, replace s with its most specific generalizations that match p;

 Delete from S any hypothesis more general than some other hypothesis in S;

 Delete from S any hypothesis not more specific than some hypothesis in G;

 End;

For each new negative instance n

 Begin

 Delete all members of S that match n;

 For each $g \in G$ that matches n, replace g with its most general specializations that do not match n;

 Delete from G any hypothesis more specific than some other hypothesis in G;

 Delete from G any hypothesis more specific than some hypothesis in S;

 End;

If $G = S$ and both are singletons, then the algorithm has found a single concept that is consistent with all the data and the algorithm halts;

If G and S become empty, then there is no concept that covers all positive instances and none of the negative instances;

End

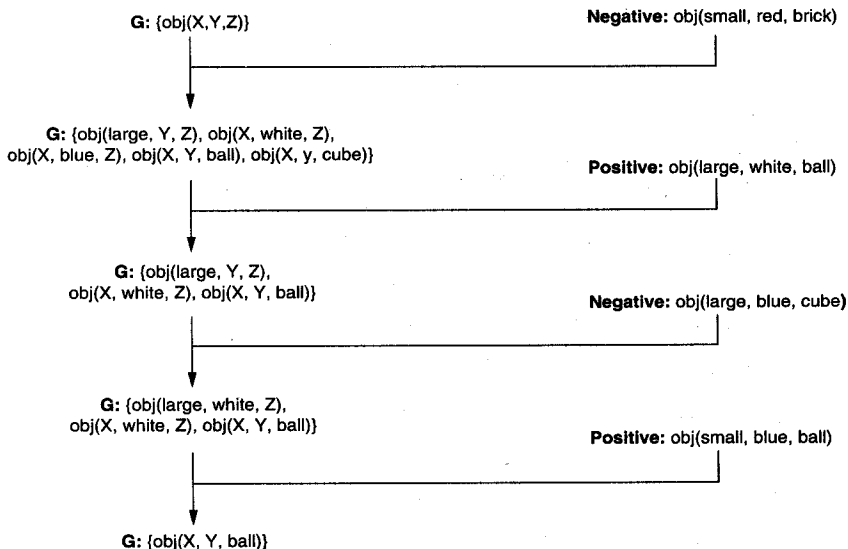

Figure 13.8 General to specific search of the version space learning the concept "ball."

Figure 13.9 illustrates the behavior of the candidate elimination algorithm in searching the version space of Figure 13.5. Note that the figure does not show those concepts that were produced through generalization or specialization but eliminated as overly general or specific. We leave the elaboration of this part of the algorithm as an exercise.

Combining the two directions of search into a single algorithm has several benefits. The G and S sets summarize the information in the negative and positive training instances respectively, eliminating the need to save these instances. For example, after generalizing S to cover a positive instance, the algorithm uses G to eliminate concepts in S that do not cover any negative instances. Because G is the set of *maximally general* concepts that do not match any negative training instances, any member of S that is more general than any member of G must match some negative instance. Similarly, because S is the set of *maximally specific* generalizations that cover all positive instances, any new member of G that is more specific than a member of S must fail to cover some positive instance and may also be eliminated.

Figure 13.10 gives an abstract description of the candidate elimination algorithm. The “+” signs represent positive training instances; “-” signs indicate negative instances. The

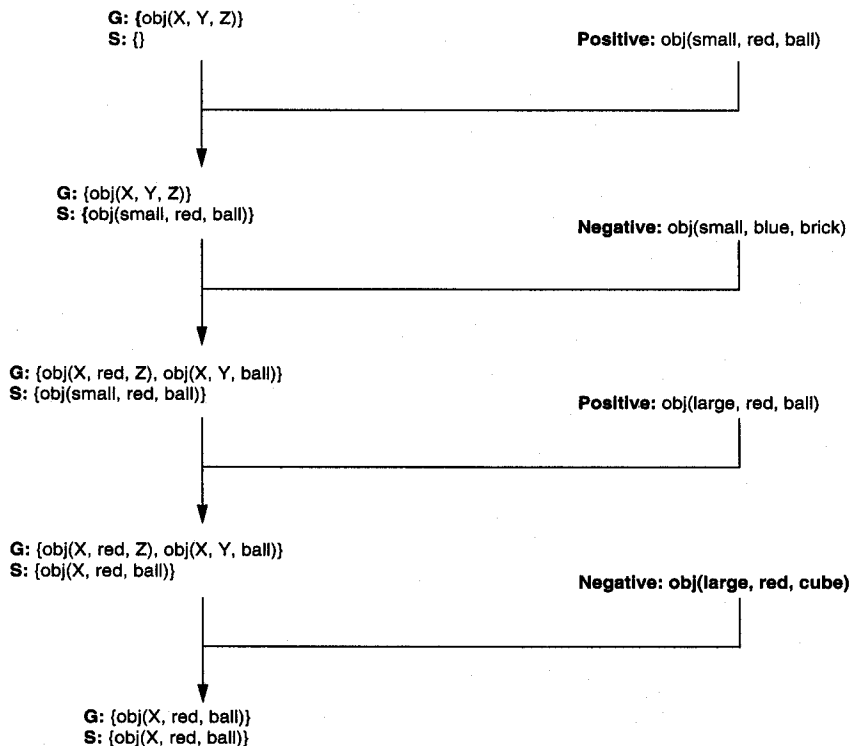

Figure 13.9 The candidate elimination algorithm learning the concept “red ball.”

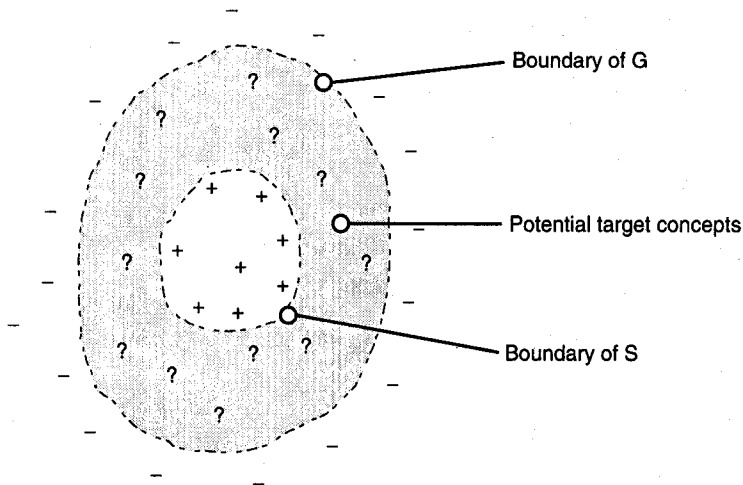

Figure 13.10 Converging boundaries of the G and S sets in the candidate elimination algorithm.

innermost circle encloses the set of known positive instances covered by the concepts in S . The outermost circle encloses the instances covered by G ; any instance outside this circle is negative. The shaded portion of the graphic contains the target concept, along with concepts that may be overly general or specific (the ?s). The search “shrinks” the outermost concept as necessary to exclude negative instances; it “expands” the innermost concept to include new positive instances. Eventually, the two sets converge on the target concept. In this fashion, candidate elimination can detect when it has found a single, consistent target concept. When both G and S converge to the same concept the algorithm may halt. If G and S become empty, then there is no concept that will cover all positive instances and none of the negative instances. This may occur if the training data is inconsistent or if the goal concept may not be expressed in the representation language (Section 13.2.4).

An interesting aspect of candidate elimination is its incremental nature. An incremental learning algorithm accepts training instances one at a time, forming a usable, although possibly incomplete, generalization after each example. This contrasts with batch algorithms (see for example ID3, Section 13.3), which require all training examples to be present before they may begin learning. Even before the candidate elimination algorithm converges on a single concept, the G and S sets provide usable constraints on that concept: if c is the goal concept, then for all $g \in G$ and $s \in S$, $s \leq c \leq g$. Any concept that is more general than some concept in G will cover negative instances; any concept that is more specific than some concept in S will fail to cover some positive instances. This suggests that instances that have a “good fit” with the concepts bounded by G and S are at least plausible instances of the concept.

In the next section, we clarify this intuition with an example of a program that uses candidate elimination to learn search heuristics. LEX (Mitchell et al. 1983) learns

heuristics for solving symbolic integration problems. Not only does this work demonstrate the use of **G** and **S** to define partial concepts; it also illustrates such additional issues as the complexities of learning multistep tasks, credit/blame assignment, and the relationship between the learning and problem-solving components of a complex system.

13.2.3 LEX: Inducing Search Heuristics

LEX learns heuristics for solving symbolic integration problems. LEX integrates algebraic expressions through heuristic search, beginning with the expression to be integrated and searching for its goal: an expression that contains no integral signs. The learning component of the system uses data from the problem solver to induce heuristics that improve the problem solver's performance.

LEX searches a space defined by operations on algebraic expressions. Its operators are the typical transformations used in performing integration. They include:

- OP1: $\int r f(x) dx \rightarrow r \int f(x) dx$
- OP2: $\int u dv \rightarrow uv - \int v du$
- PO3: $1 * f(x) \rightarrow f(x)$
- OP4: $\int (f_1(x) + f_2(x)) dx \rightarrow \int f_1(x) dx + \int f_2(x) dx$

Operators are rules, whose left-hand side defines when they may be applied. Although the left-hand side defines the circumstances under which the operator may be used, it does not include heuristics for when the operator *should* be used. LEX must learn usable heuristics through its own experience. Heuristics are expressions of the form:

If the current problem state matches P then apply operator O with bindings B.

For example, a typical heuristic that LEX might learn is:

If a problem state matches $\int x \text{transcendental}(x) dx$,
then apply op2 with bindings
 $u = x$
 $dv = \text{transcendental}(x) dx$

Here, the heuristic suggests applying integration by parts to solve the integral of x times some transcendental function (e.g., a trigonometric function) in x .

LEX's language for representing concepts consists of the symbols described in Figure 13.11. Note that the symbols exist in a generalization hierarchy, with any symbol matching any of its descendants in the hierarchy. LEX generalizes expressions by replacing a symbol with its ancestor in this hierarchy.

For example, given the expression:

$\int 3x \cos(x) dx$

LEX may replace **cos** with **trig**. This yields the expression:

$$\int 3x \operatorname{trig}(x) dx$$

Alternatively, it may replace 3 with the symbol k , which represents any integer:

$$\int kx \cos(x) dx$$

Figure 13.12 shows a version space for OP2 as defined by these generalizations. The overall architecture of LEX consists of four components:

1. a *generalizer* that uses candidate elimination to find heuristics
2. a *problem solver* that produces traces of problem solutions
3. a *critic* that produces positive and negative instances from a problem trace
4. a *problem generator* that produces new candidate problems

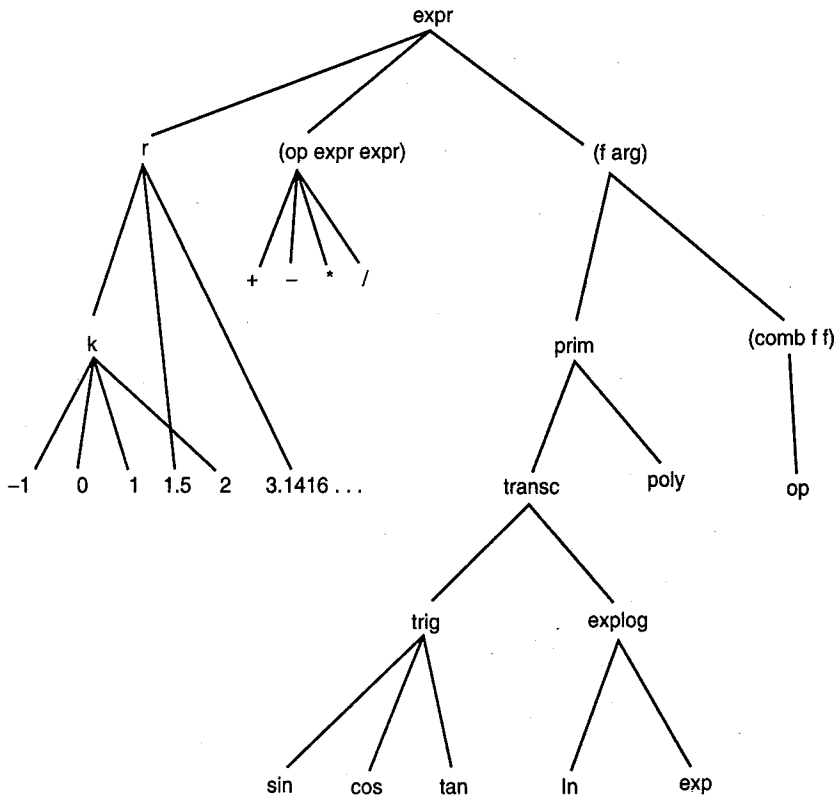

Figure 13.11 A portion of LEX's hierarchy of symbols.

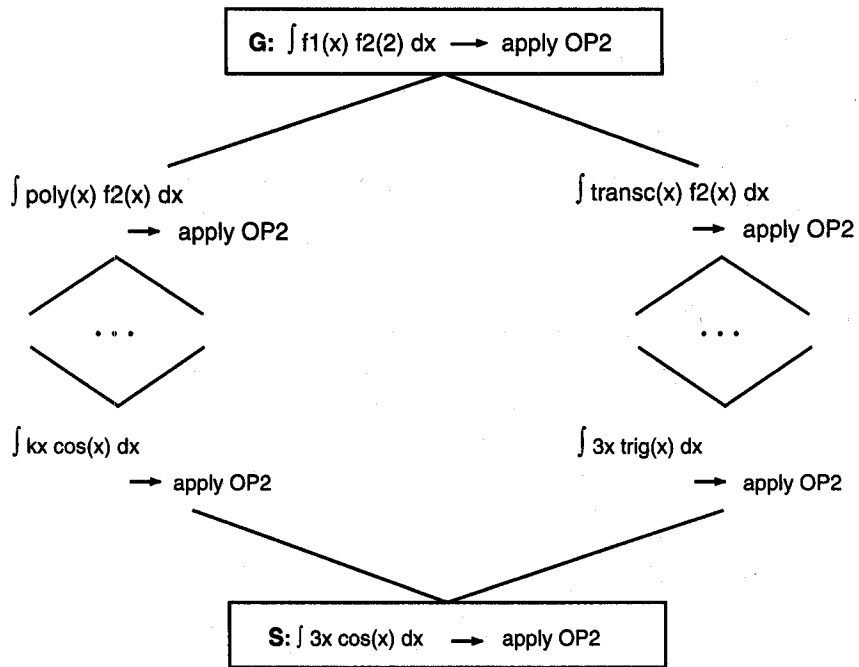

Figure 13.12 A version space for OP2 (Mitchell et al. 1983).

LEX maintains a set of version spaces. Each version space is associated with an operator and represents a partially learned heuristic for that operator. The generalizer updates these version spaces using positive and negative examples of the operator's application, as generated by the critic. On receiving a positive instance, LEX determines whether a version space associated with that operator includes the instance. A version space includes a positive instance if the instance is covered by some of the concepts in G . LEX then uses the positive instance to update that heuristic. If no existing heuristic matches the instance, LEX creates a new version space, using that instance as the first positive example. This can lead to creating multiple version spaces, for different heuristics, and one operator.

LEX's problem solver builds a tree of the space searched in solving an integration problem. It limits the CPU time the problem solver may use to solve a problem. LEX performs best-first search, using its own developing heuristics. An interesting aspect of LEX's performance is its use of G and S as partial definitions of a heuristic. If more than one operator may apply to a given state, LEX chooses the one that exhibits the highest degree of partial match to the problem state. Degree of partial match is defined as the percentage of all the concepts included between G and S that match the current state. Because the computational expense of testing the state against all such candidate concepts would be prohibitive, LEX estimates the degree of match as the percentage of entries actually in G and S that match the state. Note that performance should improve steadily as LEX improves its heuristics. Empirical results have confirmed this conjecture.

LEX obtains positive and negative examples of operator applications from the solution trace generated by the problem solver. In the absence of a teacher, LEX must classify operator applications as positive or negative; this is an example of the *credit assignment* problem. When learning is undertaken in the context of multistep problem solving, it is often unclear which action in a sequence should be given responsibility for the result. If a problem solver arrives at a wrong answer, how do we know which of several steps actually caused the error? LEX's critic approaches this problem by assuming that the solution trace returned by the problem solver represents a shortest path to a goal. LEX classifies applications of operators along this (assumed) shortest path as positive instances; operator applications that diverge from this path are treated as negative instances.

However, in treating the problem solver's trace as a shortest path solution, the critic must address the fact that LEX's evolving heuristics are not guaranteed to be admissible (Chapter 4). The solution path found by the problem solver may not actually be a shortest path solution. To ensure that it has not erroneously classified an operator application as negative, LEX first extends the paths begun by such operators to make sure they do not lead to a better solution. Usually, a problem solution produces 2 to 20 training instances. LEX passes these positive and negative instances on to the generalizer, which uses them to update the version spaces for the associated operators.

The problem generator is the least developed part of the program. Although various strategies were used to automate problem selection, most examples involved hand-chosen instances. However, a problem generator was constructed that explored a variety of strategies. One approach generates instances that were covered by the partial heuristics for two different operators, in order to make LEX learn to discriminate between them.

Empirical tests show that LEX is effective in learning useful heuristics. In one test, LEX was given 5 test problems and 12 training problems. Before training, it solved the 5 test problems in an average of 200 steps; these solutions used no heuristics to guide the search. After developing heuristics from the 12 training problems, it solved these same test problems in an average of 20 steps.

LEX addresses a number of issues in learning, including such problems as credit assignment, the selection of training instances, and the relationship between the problem solving and generalization components of a learning algorithm. LEX also underscores the importance of an appropriate representation for concepts. Much of LEX's effectiveness stems from the hierarchical organization of concepts. This hierarchy is small enough to constrain the space of potential heuristics and to allow efficient search, while being rich enough to represent effective heuristics.

13.2.4 Evaluating Candidate Elimination

The candidate elimination algorithm demonstrates the way in which knowledge representation and state space search can be applied to the problem of machine learning. However, as with most important research, the algorithm should not be evaluated in terms of its successes alone. It raises problems that continue to form a sizeable portion of machine learning's research agenda.

Search-based learning, like all search problems, must deal with the combinatorics of problem spaces. Because the candidate elimination algorithm performs breadth-first search, it can be inefficient. If an application is such that G and S grow excessively, it may be useful to develop heuristics for pruning states from G and S , implementing a *beam search* (see Chapter 4) of the space.

Another approach to this problem, discussed in Section 13.4, involves using an *inductive bias* to reduce the size of the concept space. Such biases constrain the language used to represent concepts. LEX imposed a bias through the choice of concepts in its generalization hierarchy. Though not complete, LEX's concept language was strong enough to capture many effective heuristics; of equal importance, it reduced the size of the concept space to manageable proportions. Biased languages are essential in reducing the complexity of the concept space, but they may leave the learner incapable of representing the concept it is trying to learn. In this case, candidate elimination would fail to converge on the target concept, leaving G and S empty. This trade-off between expressiveness and efficiency is an essential issue in learning.

Failure of the algorithm to converge may also be due to some noise or inconsistency in the training data. The problem of learning from noisy data is particularly important in realistic applications, where data cannot be guaranteed to be complete or consistent. Candidate elimination is not particularly noise resistant. Even a single misclassified training instance can prevent the algorithm from converging on a consistent concept. One solution to this problem maintains multiple G and S sets. In addition to the version space derived from all training instances, it maintains additional spaces based on all but 1 of the training instances, all but 2 of the training instances, etc. If G and S fail to converge, the algorithm can examine these alternatives to find those that remain consistent. Unfortunately, this approach leads to a proliferation of candidate sets and is too inefficient to be practical in most cases.

Another issue raised by this research is the role of prior knowledge in learning. LEX's concept hierarchy summarized a great deal of knowledge about algebra; this knowledge was essential to the algorithm's performance. Can greater amounts of domain knowledge make learning even more effective? Section 13.5 examines this problem.

An important contribution of this work is its explication of the relationship between knowledge representation, generalization, and search in inductive learning. Although candidate elimination is only one of many learning algorithms, it raises general questions concerning complexity, expressiveness, and the use of knowledge and data to guide generalization. These problems are central to all machine learning algorithms; we continue to address them throughout this chapter.

13.3 The ID3 Decision Tree Induction Algorithm

ID3 (Quinlan 1986a), like candidate elimination, induces concepts from examples. It is particularly interesting for its representation of learned knowledge, its approach to the management of complexity, its heuristic for selecting candidate concepts, and its potential for handling noisy data. ID3 represents concepts as *decision trees*, a representation that

allows us to determine the classification of an object by testing its values for certain properties.

For example, consider the problem of estimating an individual's credit risk on the basis of such properties as credit history, current debt, collateral, and income. Table 13.1 lists a sample of individuals with known credit risks. The decision tree of Figure 13.13 represents the classifications in Table 13.1, in that this tree can correctly classify all the objects in the table. In a decision tree, each internal node represents a test on some property, such as credit history or debt; each possible value of that property corresponds to a branch of the tree. Leaf nodes represent classifications, such as low or moderate risk. An individual of unknown type may be classified by traversing this tree: at each internal node, test the individual's value for that property and take the appropriate branch. This continues until reaching a leaf node and the object's classification.

Note that in classifying any given instance, this tree does not use all the properties present in Table 13.1. For instance, if a person has a good credit history and low debt, we may, according to the tree, ignore her collateral and income and classify her as a low risk. In spite of omitting certain tests, this tree correctly classifies all the examples.

Table 13.1 Data from Credit History of Loan Application

NO.	RISK	CREDIT HISTORY	DEBT	COLLATERAL	INCOME
1.	high	bad	high	none	\$0 to \$15k
2.	high	unknown	high	none	\$15 to \$35k
3.	moderate	unknown	low	none	\$15 to \$35k
4.	high	unknown	low	none	\$0 to \$15k
5.	low	unknown	low	none	over \$35k
6.	low	unknown	low	adequate	over \$35k
7.	high	bad	low	none	\$0 to \$15k
8.	moderate	bad	low	adequate	over \$35k
9.	low	good	low	none	over \$35k
10.	low	good	high	adequate	over \$35k
11.	high	good	high	none	\$0 to \$15k
12.	moderate	good	high	none	\$15 to \$35k
13.	low	good	high	none	over \$35k
14.	high	bad	high	none	\$15 to \$35k

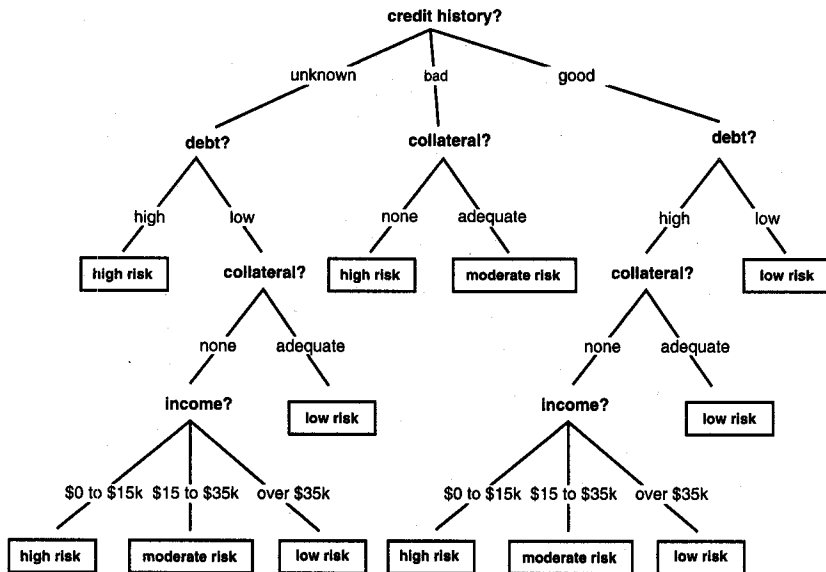

Figure 13.13 A decision tree for credit risk assessment.

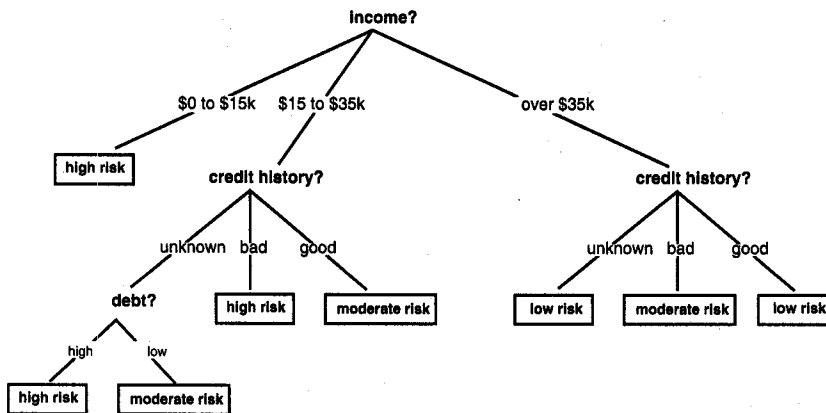

Figure 13.14 A simplified decision tree for credit risk assessment.

In general, the size of the tree necessary to classify a given set of examples varies according to the order with which properties are tested. Figure 13.14 shows a tree that is considerably simpler than that of Figure 13.13 but that also classifies the examples in Table 13.1.

Given a set of training instances and a number of different decision trees that correctly classify them, we may ask which tree has the greatest likelihood of correctly classifying unseen instances of the population. The ID3 algorithm assumes that this is the simplest decision tree that covers all the training examples. The rationale for this assumption is the time-honored heuristic of preferring simplicity and avoiding unnecessary assumptions. This principle, known as *Occam's Razor*, was first articulated by the medieval logician William of Occam in 1324:

It is vain to do with more what can be done with less. . . . Entities should not be multiplied beyond necessity.

A more contemporary version of Occam's Razor argues that we should always accept the simplest answer that correctly fits our data. In this case, it is the smallest decision tree that correctly classifies all given examples.

Although Occam's Razor has proven itself as a general heuristic for all manner of intellectual activity, its use here has a more specific justification. If we assume that the given examples are sufficient to construct a valid generalization, then our problem becomes one of distinguishing the necessary properties from the extraneous ones. The simplest decision tree that covers all the examples should be the least likely to include unnecessary constraints. Although this idea is intuitively appealing, it is an assumption that must be empirically tested; Section 12.3.3 presents some of these empirical results. Before examining these results, however, we present the ID3 algorithm for inducing decision trees from examples.

13.3.1 Top-Down Decision Tree Induction

ID3 constructs decision trees in a top-down fashion. Note that for any property, we may partition the set of training examples into disjoint subsets, where all the examples in a partition have a common value for that property. ID3 selects a property to test at the current node of the tree and uses this test to partition the set of examples; the algorithm then recursively constructs a subtree for each partition. This continues until all members of the partition are in the same class; that class becomes a leaf node of the tree. Because the order of tests is critical to constructing a simple decision tree, ID3 relies heavily on its criteria for selecting the test at the root of each subtree. To simplify our discussion, this section describes the algorithm for constructing decision trees, assuming an appropriate test selection function. In Section 13.3.2, we present the selection heuristic of the ID3 algorithm.

For example, consider the way in which ID3 constructs the tree of Figure 13.14 from Table 13.1. Beginning with the full table of examples, ID3 selects *income* as the root property using the selection function described in Section 13.3.2. This partitions the example set as shown in Figure 13.15, with the elements of each partition being listed by their number in the table.

The induction algorithm begins with a sample of correctly classified members of the target categories. ID3 constructs a decision tree according to the algorithm:

```

function induce_tree (example_set, Properties)
begin
if all entries in example_set are in the same class
then return a leaf node labeled with that class
else if Properties is empty
then return leaf node labeled with disjunction of all classes in example_set
else begin
select a property, P, and make it the root of the current tree;
delete P from Properties;
for each value, V, of P,
begin
create a branch of the tree labeled with V;
let partitionv be elements of example_set with values V for property P;
call induce_tree(partitionv, Properties), attach result to branch V
end
end
end
end

```

ID3 applies the `induce_tree` function recursively to each partition. For example, the partition {1, 4, 7, 11} consists entirely of high-risk individuals; ID3 creates a leaf node accordingly. ID3 selects the **credit history** property as the root of the subtree for the partition {2, 3, 12, 14}. In Figure 13.16, **credit history** further divides this partition into {2,3}, {14}, and {12}. Continuing to select tests and construct subtrees in this fashion, ID3 eventually produces the tree of Figure 13.14. We let the reader work through the remaining stages of this construction.

Before presenting ID3's test selection heuristic, it is worth examining the relationship between the tree construction algorithm and our view of learning as search through a concept space. We may think of the set of all possible decision trees as defining a version space. Our operations for moving through this space consist of adding tests to a tree. ID3 implements a form of hill climbing in the space of all possible trees: it adds a subtree to the current tree and continues its search; it does not backtrack. This makes the algorithm highly efficient; it also makes it dependent upon the criteria for selecting properties to test.

13.3.2 Information Theoretic Test Selection

We may think of each property of an instance as contributing a certain amount of information to its classification. For example, if our goal is to determine the species of an animal, the discovery that it lays eggs contributes a certain amount of information to that goal. ID3 measures the information gained by making each property the root of the current subtree. It then picks the property that provides the greatest information gain.

Information theory (Shannon 1948) provides a mathematical basis for measuring the information content of a message. We may think of a message as an instance in a universe of possible messages; the act of transmitting a message is the same as selecting one of these possible messages. From this point of view, it is reasonable to define the information

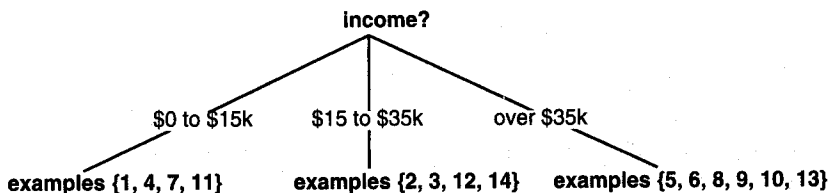

Figure 13.15 A partially constructed decision tree.

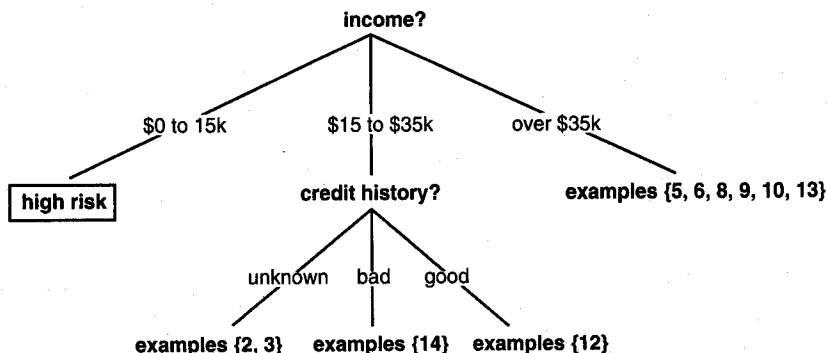

Figure 13.16 Another partially constructed decision tree.

content of a message as depending upon both the size of this universe and the frequency with which each possible message occurs.

The importance of the number of possible messages is evident in an example from gambling: compare a message correctly predicting the outcome of a spin of the roulette wheel with one predicting the outcome of a toss of an honest coin. Because roulette can have more outcomes than a coin toss, a message concerning its outcome is of more value to us: winning at roulette also pays better than winning at a coin toss. Consequently, we should regard this message as conveying more information.

The influence of the probability of each message on the amount of information is evident in another gambling example. Assume that I have rigged a coin so that it will come up heads $3/4$ of the time. Because I already know enough about the coin to wager correctly $3/4$ of the time, a message telling me the outcome of a given toss is worth less to me than it would be for an honest coin.

Shannon formalized these intuitions by defining the amount of information in a message as a function of the probability of occurrence of each possible message. Given a universe of messages, $M = \{m_1, m_2, \dots, m_n\}$ and a probability, $p(m_i)$, for the occurrence of each message, the information content of a message in M is given by:

$$I(M) = \sum_{i=1}^n -p(m_i) \log_2(p(m_i))$$

The information in a message is measured in bits. For example, the information content of a message telling the outcome of the flip of an honest coin is:

$$\begin{aligned} I(\text{Coin toss}) &= -p(\text{heads})\log_2(p(\text{heads})) - p(\text{tails})\log_2(p(\text{tails})) \\ &= -\frac{1}{2} \log_2\left(\frac{1}{2}\right) - \frac{1}{2} \log_2\left(\frac{1}{2}\right) \\ &= 1 \text{ bit} \end{aligned}$$

However, if the coin has been rigged to come up heads 75% of the time, then the information content of a message is:

$$\begin{aligned} I(\text{Coin toss}) &= -\frac{3}{4} \log_2\left(\frac{3}{4}\right) - \frac{1}{4} \log_2\left(\frac{1}{4}\right) \\ &= -\frac{3}{4}*(-0.415) - \frac{1}{4}*(-2) \\ &= 0.811 \text{ bits} \end{aligned}$$

This definition formalizes many of our intuitions about the information content of messages. Information theory is widely used in computer science and telecommunications, including such applications as determining the information-carrying capacity of communications channels, developing data compression algorithms, and developing noise resistant communication strategies. ID3 uses information theory to select the test that gives the greatest information gain in classifying the training examples.

We may think of a decision tree as conveying information about the classification of examples in the decision table; the information content of the tree is computed from the probabilities of the different classifications. For example, if we assume that all the examples in Table 13.1 occur with equal probability, then:

$$p(\text{risk is high}) = \frac{6}{14}, \quad p(\text{risk is moderate}) = \frac{3}{14}, \quad p(\text{risk is low}) = \frac{5}{14}$$

It follows that the information in the table, and, consequently, any tree that covers those examples, is:

$$\begin{aligned} I(\text{Table 13.1}) &= -\frac{6}{14} \log_2\left(\frac{6}{14}\right) - \frac{3}{14} \log_2\left(\frac{3}{14}\right) - \frac{5}{14} \log_2\left(\frac{5}{14}\right) \\ &= -\frac{6}{14}*(-1.222) - \frac{3}{14}*(-2.222) - \frac{5}{14}*(-1.485) \\ &= 1.531 \text{ bits} \end{aligned}$$

The information gain provided by making a test at the root of the current tree is equal to the total information in the tree minus the amount of information needed to complete the classification after performing the test. The amount of information needed to complete the tree is defined as the weighted average of the information in all its subtrees. We compute the weighted average by multiplying the information content of each subtree by the percentage of the examples present in that subtree and summing these products.

Assume a set of training instances, C . If we make property P , with n values, the root of the current tree, this will partition C into subsets, $\{C_1, C_2, \dots, C_n\}$. The expected information needed to complete the tree after making P the root is:

$$E(P) = \sum_{i=1}^n \frac{|C_i|}{|C|} I(C_i)$$

The gain from property P is computed by subtracting the expected information to complete the tree from the total information content of the tree:

$$\text{gain}(P) = I(C) - E(P)$$

In the example of Table 13.1, if we make **income** the property tested at the root of the tree, this partitions the table of examples into the partitions $C_1 = \{1,4,7,11\}$, $C_2 = \{2,3,12,14\}$, and $C_3 = \{5,6,8,9,10,13\}$. The expected information needed to complete the tree is:

$$\begin{aligned} E(\text{income}) &= \frac{4}{14} * I(C_1) + \frac{4}{14} * I(C_2) + \frac{6}{14} * I(C_3) \\ &= \frac{4}{14} * 0.0 + \frac{4}{14} * 1.0 + \frac{6}{14} * 0.650 \\ &= 0.564 \text{ bits} \end{aligned}$$

The information gain is:

$$\begin{aligned} \text{gain}(\text{income}) &= I(\text{table 12.1}) - E(\text{income}) \\ &= 1.531 - 0.564 \\ &= 0.967 \text{ bits} \end{aligned}$$

Similarly, we may show that

$$\begin{aligned} \text{gain}(\text{credit history}) &= 0.266 \\ \text{gain}(\text{debt}) &= 0.581 \\ \text{gain}(\text{collateral}) &= 0.756 \end{aligned}$$

Because **income** provides the greatest information gain, ID3 will select it as the root of the tree. The algorithm continues to apply this analysis recursively to each subtree until it has completed the tree.

13.3.3 Evaluating ID3

Although the ID3 algorithm produces simple decision trees, it is not obvious that such trees will be effective in predicting the classification of unknown examples. ID3 has been evaluated in both controlled tests and applications and has proven to work well in practice.

Quinlan, for example, has evaluated ID3's performance on the problem of learning to classify boards in a chess endgame (Quinlan 1983). The endgame involved white, playing with a king and a rook, against black, playing with a king and a knight. ID3's goal was to learn to recognize boards that led to a loss for black within 3 moves. The attributes were different high-level properties of boards, such as "an inability to move the king safely." The test used 23 such attributes.

Once board symmetries were taken into account, the entire problem domain consisted of 1.4 million different boards, of which 474,000 were a loss for black in 3 moves. ID3 was tested by giving it a randomly selected training set and then testing it on 10,000 different boards, also randomly selected. Quinlan's tests gave the results found in Table 13.2. The predicted maximum errors were derived from a statistical model of ID3's behavior in the domain. For details see Quinlan (1983).

These impressive results are supported by further empirical studies and by anecdotal results from further applications. Variations of ID3 have been developed to deal with such problems as noise and excessively large training sets. For more details, see Quinlan (1986a, b).

Table 13.2 The Evaluation of ID3

Size of Training Set	Percentage of Whole Universe	Errors in 10,000 Trials	Predicted Maximum Errors
200	0.01	199	728
1,000	0.07	33	146
5,000	0.36	8	29
25,000	1.79	6	7
125,000	8.93	2	1

13.3.4 Decision Tree Data Issues: Bagging, Boosting

Quinlan (1983) was the first to suggest the use of information theory to produce subtrees in decision tree learning and his work was the basis for our presentation. Our examples were clean, however, and their use straightforward. There are a number of issues that we did not address, each of which often occurs in a large data set:

1. The data is bad. This can happen when two (or more) identical attribute sets give different results. What can we do if we have no a priori reason to get rid of data?

2. Data from some attribute sets is missing, perhaps because it is too expensive to obtain. Do we extrapolate? Can we create a new value “unknown?” How can we smooth over this irregularity?
3. Some of the attribute sets are continuous. We handled this by breaking the continuous value “income” into convenient subsets of values, and then used these groupings. Are there better approaches?
4. The data set may be too large for the learning algorithm. How do you handle this?

Addressing these issues produced new generations of decision tree learning algorithms after ID3. The most notable of these is C4.5 (Quinlan 1996). These issues also led to techniques such as bagging and boosting. Since the data for classifier learning systems are attribute-value vectors or instances, it is tempting to manipulate the data to see if different classifiers are produced.

Bagging produces replicate training sets by sampling with replacement from the training instances. *Boosting* uses all instances at each replication, but maintains a weight for each instance in the training set. This weight is intended to reflect that vector’s importance. When the weights are adjusted, different classifiers are produced, since the weights cause the learner to focus on different instances. In either case, the multiple classifiers produced are combined by voting to form a composite classifier. In bagging, each component classifier has the same vote, while boosting assigns different voting strengths to component classifiers on the basis of their accuracy.

In working with very large sets of data, it is common to divide the data into subsets, build the decision tree on one subset, and then test its accuracy on other subsets. The literature on decision tree learning is now quite extensive, with a number of data sets on-line, and a number of empirical results published showing the results of using various versions of decision tree algorithms on this data.

Finally, it is straight forward to convert a decision tree into a comparable rule set. What we do is make each possible path through the decision tree into a single rule. The pattern for the rule, its left-hand side (Chapter 5), consists of the decisions leading to the leaf node. The action or right-hand side is the leaf node or outcome of the tree. This rule set may be further customized to capture subtrees within the decision tree. This rule set may then be run to classify new data.

13.4 Inductive Bias and Learnability

So far, our discussion has emphasized the use of empirical data to guide generalization. However, successful induction also depends upon prior knowledge and assumptions about the nature of the concepts being learned. *Inductive bias* refers to any criteria a learner uses to constrain the concept space or to select concepts within that space. In the next section, we examine the need for bias and the types of biases that learning programs typically

employ. Section 13.4.2 introduces theoretical results in quantifying the effectiveness of inductive biases.

13.4.1 Inductive Bias

Learning spaces tend to be large; without some way of pruning them, search-based learning would be a practical impossibility. For example, consider the problem of learning a classification of bit strings (strings of 0s and 1s) from positive and negative examples. Because a classification is simply a subset of the set of all possible strings, the total number of possible classifications is equal to the power set, or set of all subsets, of the entire population. If there are m instances, then there are 2^m possible classifications. But for strings of n bits, there are 2^n different strings. Thus, there are 2 to the power 2^n different classifications of bit strings of length n ! Without some heuristic constraints, it would be impossible for a learner to effectively search such spaces in all but the most trivial domains.

Another reason for the necessity of bias is the nature of inductive generalization itself. Generalization is not truth preserving. For example, if we encounter an honest politician, are we justified in assuming that all politicians are honest? How many honest politicians must we encounter before we are justified in making this assumption? Hume discussed this problem, known as the problem of induction, several hundred years ago:

You say that the one proposition is an inference from the other; but you must confess that the inference is not intuitive, neither is it demonstrative. Of what nature is it then? To say it is experimental is begging the question. For all inferences from experience suppose, as their foundation, that the future will resemble the past and that similar powers will be conjoined with similar sensible qualities (Hume 1748).

In induction, the training data are only a subset of all instances in the domain; consequently, any training set may support many different generalizations. In our example of a bit string classifier, assume that the learner has been given the strings {1100, 1010} as positive examples of some class of strings. Many generalizations are consistent with these examples: the set of all strings beginning with "1" and ending with "0," the set of all strings beginning with "1," the set of all strings of even parity, or any other subset of the entire population that includes {1100, 1010}. What criteria can the learner use to choose one of these generalizations? The data alone are not sufficient; all of these choices are consistent with those data. The learner must make additional assumptions about the nature of likely concepts.

In learning, these assumptions often take the form of heuristics for choosing a branch of the search space. The information theoretic test selection function used by ID3 (Section 13.3.2) is an example of such a heuristic. ID3 performs a hill-climbing search through the space of possible decision trees. At each stage of the search, it examines all the tests that could be used to extend the tree and chooses the test that gains the most information. This is a "greedy" heuristic: it favors branches of the search space that seem to move the greatest distance toward a goal state.

This heuristic allows ID3 to efficiently search the space of decision trees, and it also addresses the problem of choosing plausible generalizations from limited data. ID3 assumes that the smallest tree that correctly classifies all the given examples will be the most likely to classify future training instances correctly. The rationale for this assumption is that small trees are less likely to make assumptions not supported by the data. If the training set is large enough and truly representative of the population, such trees should include all and only the essential tests for determining class membership. As discussed in Section 13.3.3, empirical evaluations have shown this assumption to be quite justified. This preference for simple concept definitions is used in a number of learning algorithms, such as the CLUSTER/2 algorithm of Section 13.6.2.

Another form of inductive bias consists of syntactic constraints on the representation of learned concepts. Such biases are not heuristics for selecting a branch of the concept space. Instead, they limit the size of the space itself by requiring that learned concepts be expressed in a constrained representation language. Decision trees, for example, are a much more constrained language than full predicate calculus. The corresponding reduction in the size of the concept space is essential to ID3's efficiency.

An example of a syntactic bias that might prove effective in classifying bit strings would limit concept descriptions to patterns of symbols from the set {0, 1, #}. A pattern defines the class of all matching strings, where matching is determined according to the following rules:

If the pattern has a "0" in a certain position, then the target string must have a "0" in the corresponding position.

If the pattern has a "1" in a certain position, then the target string must have a "1" in the corresponding position.

A "#" in a given position can match either a "1" or a "0".

For example, the pattern, "1##0" defines the set of strings {1110, 1100, 1010, 1000}. Holland (1986) uses such a definition for patterns of bit strings, the *schema*, in genetic algorithms; see Section 15.1.

Considering only those classes that could be represented as a single such pattern reduces the size of the concept space considerably. For strings of length n , we may define 3^n different patterns. This is considerably smaller than the 2 to the power 2^n possible concepts in the unconstrained space. This bias also allows straightforward implementation of version space search, where generalization involves replacing a 1 or a 0 in a candidate pattern with a #. However, the cost we incur for this bias is the inability to represent (and consequently learn) certain concepts. For example, a single pattern of this type cannot represent the class of all strings of even parity.

This trade-off between expressiveness and efficiency is typical. LEX, for example, does not distinguish between odd or even integers in its taxonomy of symbols. Consequently, it cannot learn any heuristic that depends upon this distinction. Although work has been done in programs that can change their bias in response to data (Utgoff 1986), most learning programs assume a fixed inductive bias.

Machine learning has explored a number of representational biases:

Conjunctive biases restrict learned knowledge to conjunctions of literals. This is particularly common because the use of disjunction in concept descriptions creates problems for generalization. For example, assume that we allow arbitrary use of disjuncts in the representation of concepts in the candidate elimination algorithm. Because the maximally specific generalization of a set of positive instances is simply the disjunction of all the instances, the learner will not generalize at all. It will add disjuncts *ad infinitum*, implementing a form of rote learning (Mitchell 1980).

Limitations on the number of disjuncts. Purely conjunctive biases are too limited for many applications. One approach that increases the expressiveness of a representation while addressing the problems of disjunction is to allow a small, bounded number of disjuncts.

Feature vectors are a representation that describes objects as a set of features whose values differ from object to object. The objects in Table 13.1 are represented as sets of features.

Decision trees are a concept representation that has proven effective in the ID3 algorithm.

Horn clauses (Section 12.2) require a restriction on the form of implications that has been used in automated reasoning as well as by a number of programs for learning rules from examples.

In addition to the syntactic biases discussed in this section, a number of programs use domain-specific knowledge to consider the known or assumed semantics of the domain. Such knowledge can provide an extremely effective bias. Section 13.5 examines these knowledge-based approaches. However, before considering the role of knowledge in learning, we briefly examine theoretical results quantifying inductive bias. We also present a summary discussion of inductive bias in learning systems in Section 16.3.

13.4.2 The Theory of Learnability

The goal of inductive bias is to restrict the set of target concepts in such a way that we may both search the set efficiently and find high-quality concept definitions. An interesting body of theoretical work addresses the problem of quantifying the effectiveness of an inductive bias.

We define the quality of concepts in terms of their ability to correctly classify objects that were not included in the set of training instances. It is not hard to write a learning algorithm that produces concepts that will correctly classify all the examples that it has seen; rote learning would suffice for this. However, due to the large number of instances in most domains, algorithms can only afford to examine a portion of the possible examples.

Thus, the performance of a learned concept on new instances is critically important. In testing learning algorithms, we generally divide the set of all instances into nonintersecting sets of training instances and test instances. After training a program on the training set, we test it on the test set.

It is useful to think of efficiency and correctness as properties of the language for expressing concepts (i.e., the inductive bias) rather than a particular learning algorithm. Learning algorithms search a space of concepts; if this space is of manageable complexity and contains high-quality concept definitions, any reasonable learning algorithm should find these definitions; if the space is not, no algorithm will succeed. An extreme example may clarify this point.

The concept of "ball" is obviously learnable, given a suitable language for describing the properties of objects. After seeing a relatively small number of balls, a person will be able to define them concisely: balls are round. Contrast this with a concept that is obviously not learnable: suppose a team of people runs around the planet and selects a set of several million objects entirely at random, calling the resulting class "bunch_of_stuff." Not only would a concept induced from any sample of bunch_of_stuff require an extremely complex representation, but it also is highly unlikely that this concept would correctly classify unseen members of the set.

These observations make no assumption about the learning algorithms used, other than that they search in a reasonable fashion. "Ball" is learnable because we can define it in terms of a few features: the concept can be expressed in a biased language. Attempting to describe the concept "bunch_of_stuff" would require a concept definition at least as long as a list of all the properties of all the objects in the class. The space of all expressions in such a language would not allow efficient learning, regardless of the algorithm used.

Thus, rather than defining learnability in terms of specific algorithms, we define it in terms of the language used to represent concepts. Also, to achieve generality, we do not define learnability over specific problem domains, such as learning "bunch_of_stuff." Instead we define it in terms of the syntactic properties of the concept definition language.

In defining learnability, we must not only take efficiency into account; we must also deal with the fact that induction is not sound. No learning algorithm is guaranteed to produce a correct concept from an incomplete sample of training instances. Consequently, the correctness of a concept is the probability, over the entire population of instances, that it will correctly classify an instance.

We still have not solved all our problems. In addition to the correctness of learned concepts, we must also consider the likelihood with which an algorithm may find such concepts. We may think of a concept as defining a distribution of instances (the positive instances) in the entire population of instances. A set of training examples is a sample of this population. A particular distribution of positive instances, or a particular training set selected from these instances, may or may not be sufficient to select a high-quality concept. We must therefore be concerned with the probability that the algorithm will find a quality concept.

To summarize, learnability is a property of concept spaces and is determined by the language required to represent concepts. In evaluating these spaces, we must take into account both the probability that an algorithm will find a quality concept and the probability with which the resulting concept will correctly classify instances. Valiant has

formalized these intuitions in the theory of Probably Approximately Correct (PAC) learning (1984).

A class of concepts is *learnable* if an algorithm exists that executes efficiently and has a high probability of finding an “approximately correct” concept. By approximately correct, we mean that the concept correctly classifies a high percentage of possible instances.

Formally, Valiant defines learnability as follows. Let \mathbf{C} be a set of concepts and I a set of instances. The concepts may be algorithms, patterns, or some other means of dividing I into positive and negative instances. Assume that an algorithm may query the set of instances, obtaining as many positive examples of a concept as it needs; the only restriction is that the algorithm must run in polynomial time. Note that this prevents exhaustive search of the example set, as doing so would require exponential time.

\mathbf{C} is learnable if there exists an algorithm with the following properties:

1. The execution time for the algorithm is polynomial in the size of the concept learned, the number of properties examined, and adjustable parameters, ϵ and σ .
2. For all distributions of positive examples, the program will, with probability of at least $(1-\sigma)$, produce a concept $c \in \mathbf{C}$ such that c fails to correctly classify instances in I with probability of less than ϵ .

Note that we do not expect the algorithm to find an optimal concept definition; this is not possible given the inherent limitations of induction. We only expect it to find, with a high probability, a concept that is very likely to be correct. An interesting aspect of this definition is that it does not depend upon the distribution of positive examples in the instance space. It only depends upon the nature of the concept language (i.e., the bias) and the desired degree of correctness.

Using this definition of PAC learnability, researchers have shown the tractability of several inductive biases. For example, Valiant (1984) proves that the class of k -CNF expressions is learnable. k -CNF expressions are sentences in conjunctive normal form with a bound on the number of disjuncts; expressions are formed of the conjunction of clauses, $C_1 \wedge C_2 \wedge \dots \wedge C_n$, where each C_i is the disjunction of no more than k literals. This theoretical result supports the common restriction of concepts to conjunctive form used in many learning algorithms. We do not duplicate the proof here but refer the reader to Valiant’s paper, where he proves this result, along with the learnability of other biases. For additional results in learnability and inductive bias, see Haussler (1988).

13.5 Knowledge and Learning

ID3 and the candidate elimination algorithm generalize on the basis of regularities in training data. Such algorithms are often referred to as *similarity based*, in that generalization is primarily a function of similarities across training examples. The biases employed by these algorithms are limited to syntactic constraints on the form of learned

knowledge; they make no strong assumptions about the semantics of the domains. In this section, we examine algorithms, such as *explanation-based learning*, that use prior domain knowledge to guide generalization.

Initially, the idea that prior knowledge is necessary for learning seems contradictory. However, both machine learning and cognitive scientist researchers have made a case for exactly that notion, arguing that the most effective learning occurs when the learner already has considerable knowledge of the domain. One argument for the importance of knowledge in learning is the reliance of similarity-based learning techniques on relatively large amounts of training data. Humans, in contrast, can form reliable generalizations from as few as a single training instance, and many practical applications require that a learning program do the same.

Another argument for the importance of prior knowledge recognizes that any set of training examples can support an unlimited number of generalizations, most of which are either irrelevant or nonsensical. Inductive bias is one means of making this distinction. In this section, we examine algorithms that go beyond purely syntactic biases to consider the role of strong domain knowledge in learning.

13.5.1 Meta-DENDRAL

Meta-DENDRAL (Buchanan and Mitchell 1978) is one of the earliest and still one of the best examples of the use of knowledge in inductive learning. Meta-DENDRAL acquires rules to be used by the DENDRAL program for analyzing mass spectrographic data. DENDRAL infers the structure of organic molecules from their chemical formula and mass spectrographic data.

A mass spectrograph bombards molecules with electrons, causing some of the chemical bonds to break. Chemists measure the weight of the resulting pieces and interpret these results to gain insight into the structure of the compound. DENDRAL employs knowledge in the form of rules for interpreting mass spectrographic data. The premise of a DENDRAL rule is a graph of some portion of a molecular structure. The conclusion of the rule is that graph with the location of the cleavage indicated.

Meta-DENDRAL infers these rules from spectrographic results on molecules of known structure. Meta-DENDRAL is given the structure of a known compound, along with the mass and relative abundance of the fragments produced by spectrography. It interprets these, constructing an account of where the breaks occurred. These explanations of breaks in specific molecules are used as examples for constructing general rules.

In determining the site of a cleavage in a training run, DENDRAL uses a "half-order theory" of organic chemistry. This theory, though not powerful enough to support the direct construction of DENDRAL rules, does support the interpretation of cleavages within known molecules. The half-order theory consists of rules, constraints, and heuristics such as:

Double and triple bonds do not break.

Only fragments larger than two carbon atoms show up in the data.

Using the half-order theory, meta-DENDRAL constructs explanations of the cleavage. These explanations indicate the likely sites of cleavages along with possible migrations of atoms across the break.

These explanations become the set of positive instances for a rule induction program. This component induces the constraints in the premises of DENDRAL rules through a general to specific search. It begins with a totally general description of a cleavage: $X_1 * X_2$. This pattern means that a cleavage, indicated by the asterisk, can occur between any two atoms. It specializes the pattern by:

adding atoms: $X_1 * X_2 \rightarrow X_3 - X_1 * X_2$

where the “-” operator indicates a chemical bond, or

instantiating atoms or attributes of atoms: $X_1 * X_2 \rightarrow C * X_2$

Meta-DENDRAL learns from positive examples only and performs a hill-climbing search of the concept space. It prevents overgeneralization by limiting candidate rules to cover only about half of the training instances. Subsequent components of the program evaluate and refine these rules, looking for redundant rules or modifying rules that may be overly general or specific.

The strength of meta-DENDRAL is in its use of domain knowledge to change raw data into a more usable form. This gives the program noise resistance, through the use of its theory to eliminate extraneous or potentially erroneous data, and the ability to learn from relatively few training instances. The insight that training data must be so interpreted to be fully useful is the basis of explanation-based learning.

13.5.2 Explanation-Based Learning

Explanation-based learning uses an explicitly represented domain theory to construct an explanation of a training example, usually a proof that the example logically follows from the theory. By generalizing from the explanation of the instance, rather than from the instance itself, explanation-based learning filters noise, selects relevant aspects of experience, and organizes training data into a systematic and coherent structure.

There are several alternative formulations of this idea. For example, the STRIPS program for representing general operators for planning (see Sections 5.4 and 9.5) has exerted a powerful influence on this research (Fikes et al. 1972). Meta-DENDRAL, as we have just discussed, established the power of theory-based interpretation of training instances. More recently, a number of authors (DeJong and Mooney 1986, Minton 1988) have proposed alternative formulations of this idea. The *Explanation-Based Generalization* algorithm of Mitchell et al. (1986) is also typical of the genre. In this section, we examine a variation of the explanation-based learning (EBL) algorithm developed by DeJong and Mooney (1986).

EBL begins with:

1. A *target concept*. The learner's task is to determine an effective definition of this concept. Depending upon the specific application, the target concept may be a classification, a theorem to be proven, a plan for achieving a goal, or a heuristic for a problem solver.
2. A *training example*, an instance of the target.
3. A *domain theory*, a set of rules and facts that are used to explain how the training example is an instance of the goal concept.
4. *Operationality criteria*, some means of describing the form that concept definitions may take.

To illustrate EBL, we present an example of learning about when an object is a cup. This is a variation of a problem explored by Winston et al. (1983) and adapted to explanation-based learning by Mitchell et al. (1986). The target concept is a rule that may be used to infer whether an object is a cup:

premise(X) \rightarrow cup(X)

where *premise* is a conjunctive expression containing the variable X.

Assume a domain theory that includes the following rules about cups:

liftable(X) \wedge holds_liquid(X) \rightarrow cup(X)
 part(Z, W) \wedge concave(W) \wedge points_up(W) \rightarrow holds_liquid(Z)
 light(Y) \wedge part(Y, handle) \rightarrow liftable(Y)
 small(A) \rightarrow light(A)
 made_of(A, feathers) \rightarrow light(A)

The training example is an instance of the goal concept. That is, we are given:

cup(obj1)
 small(obj1)
 part(obj1, handle)
 owns(bob, obj1)
 part(obj1, bottom)
 part(obj1, bowl)
 points_up(bowl)
 concave(bowl)
 color(obj1, red)

Finally, assume the operationality criteria require that target concepts be defined in terms of observable, structural properties of objects, such as *part* and *points_up*. We may provide domain rules that enable the learner to infer whether a description is operational, or we may simply list operational predicates.

Using this theory, a theorem prover may construct an explanation of why the example is indeed an instance of the training concept: a proof that the target concept logically follows from the example, as in the first tree in Figure 13.17. Note that this explanation

eliminates such irrelevant concepts as `color(obj1, red)` from the training data and captures those aspects of the example known to be relevant to the goal.

The next stage of explanation-based learning generalizes the explanation to produce a concept definition that may be used to recognize other cups. EBL accomplishes this by substituting variables for those constants in the proof tree that depend solely on the particular training instance, as in Figure 13.17. Based on the generalized tree, EBL defines a new rule whose conclusion is the root of the tree and whose premise is the conjunction of the leaves:

$$\text{small}(X) \wedge \text{part}(X, \text{handle}) \wedge \text{part}(X, W) \wedge \text{concave}(W) \wedge \text{points_up}(W) \rightarrow \text{cup}(X).$$

In constructing a generalized proof tree, our goal is to substitute variables for those constants that are part of the training instance while retaining those constants and constraints that are part of the domain theory. In this example, the constant `handle`

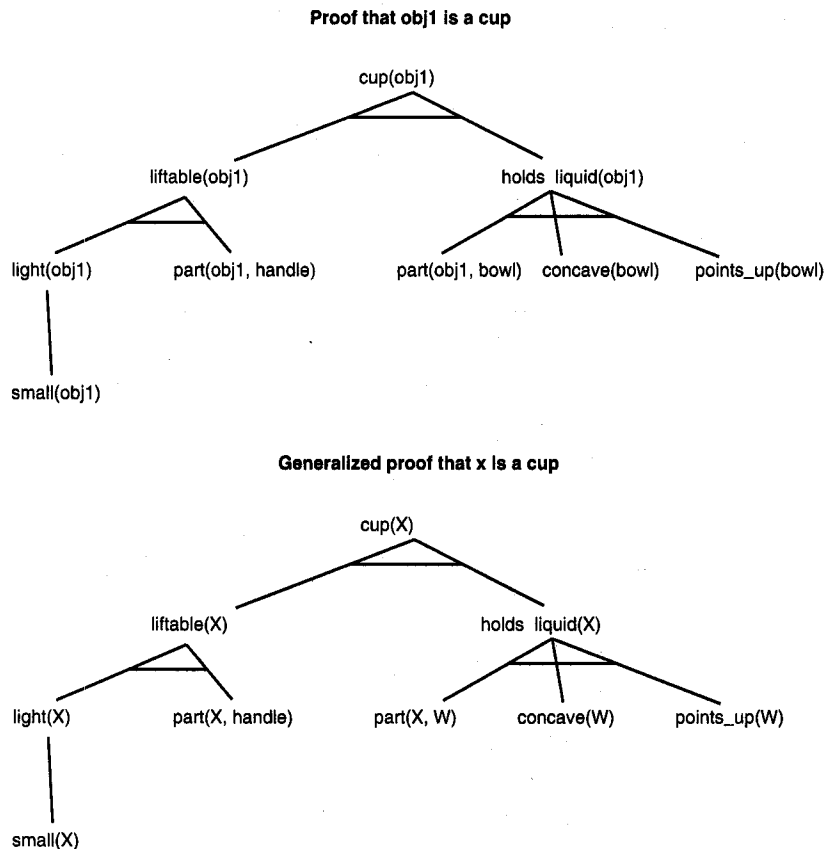

Figure 13.17 Specific and generalized proof that an object, X, is a cup.

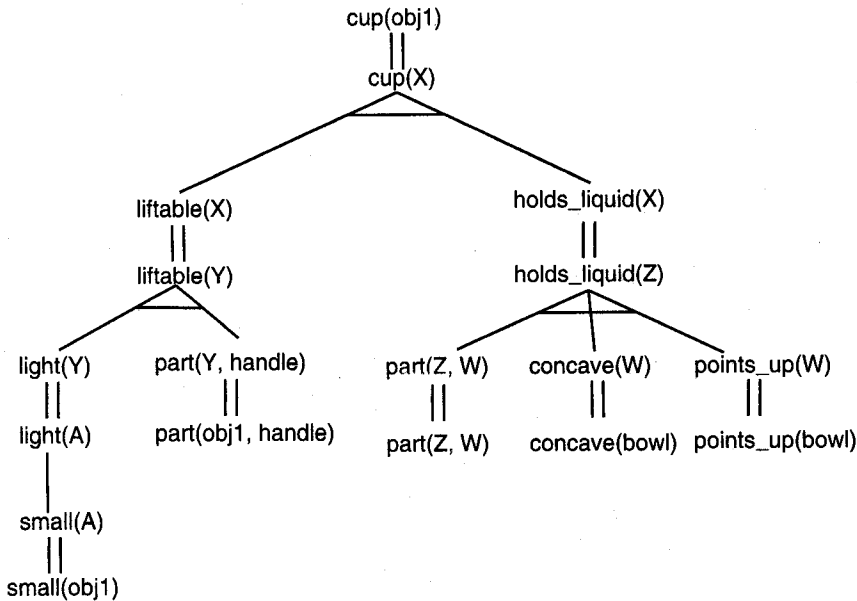

Figure 13.18 An explanation structure of the cup example.

originated in the domain theory rather than the training instance. We have retained it as an essential constraint in the acquired rule.

We may construct a generalized proof tree in a number of ways using a training instance as a guide. Mitchell et al. (1986) accomplish this by first constructing a proof tree that is specific to the training example and subsequently generalizing the proof through a process called *goal regression*. Goal regression matches the generalized goal (in our example, $\text{cup}(X)$) with the root of the proof tree, replacing constants with variables as required for the match. The algorithm applies these substitutions recursively through the tree until all appropriate constants have been generalized. See Mitchell et al. (1986) for a detailed description of this process.

DeJong and Mooney (1986) propose an alternative approach that essentially builds the generalized and the specific trees in parallel. This is accomplished by maintaining a variation of the proof tree consisting of the rules used in proving the goal distinct from the variable substitutions used in the actual proof. This is called an *explanation structure*, as in Figure 13.18, and represents the abstract structure of the proof. The learner maintains two distinct substitution lists for the explanation structure: a list of the specific substitutions required to explain the training example and a list of general substitutions required to explain the generalized goal. It constructs these substitution lists as it builds the explanation structure.

We construct the lists of general and specific substitutions as follows: let s_s and s_g be the lists of specific and general substitutions, respectively. For every match between

expressions e_1 and e_2 in the explanation structure, update s_s and s_g according to the following rule:

```

if  $e_1$  is in the premise of a domain rule and  $e_2$  is the conclusion of a domain rule
then begin
   $T_s$  = the most general unifier of  $e_1s_s$  and  $e_2s_s$            % unify  $e_1$  and  $e_2$  under  $s_s$ 
   $s_s$  =  $s_sT_s$                                            % update  $s_s$  by composing it with  $T_s$ 
   $T_g$  = the most general unifier of  $e_1s_g$  and  $e_2s_g$        % unify  $e_1$  and  $e_2$  under  $s_g$ 
   $s_g$  =  $s_gT_g$                                            % update  $s_g$  by composing it with  $T_g$ 
end

if  $e_1$  is in the premise of a domain rule and  $e_2$  is a fact in the training instance
then begin                                           % only update  $s_s$ 
   $T_s$  = the most general unifier of  $e_1s_s$  and  $e_2s_s$        % unify  $e_1$  and  $e_2$  under  $s_s$ 
   $s_s$  =  $s_sT_s$                                            % update  $s_s$  by composing it with  $T_s$ 
end

```

In the example of Figure 13.18:

$$s_s = \{\text{obj1}/X, \text{obj1}/Y, \text{obj1}/A, \text{obj1}/Z, \text{bowl}/W\}$$

$$s_g = \{X/Y, X/A, X/Z\}$$

Applying these substitutions to the explanation structure of Figure 13.18 gives the specific and general proof trees of Figure 13.17.

Explanation-based learning offers a number of benefits:

1. Training examples often contain irrelevant information, such as the color of the cup in the preceding example. The domain theory allows the learner to select the relevant aspects of the training instance.
2. A given example may allow numerous possible generalizations, most of which are either useless, meaningless, or wrong. EBL forms generalizations that are known to be relevant to specific goals and that are guaranteed to be logically consistent with the domain theory.
3. By using domain knowledge EBL allows learning from a single training instance.
4. Construction of an explanation allows the learner to hypothesize unstated relationships between its goals and its experience, such as deducing a definition of a cup based on its structural properties.

EBL has been applied to a number of learning problems. For instance, Mitchell et al. (1983) discuss the addition of EBL to the LEX algorithm. Suppose that the first positive example of the use of OP1 is in solving the instance $\int 7x^2 dx$. LEX will make this instance a member of S , the set of maximally specific generalizations. However, a human would

immediately recognize that the techniques used in solving this instance do not depend upon the specific values of the coefficient and exponent but will work for any real values, so long as the exponent is not equal to -1 . The learner is justified in inferring that OP1 should be applied to any instance of the form $\int r_1 x^{(r_2-1)} dx$, where r_1 and r_2 are any real numbers. LEX has been extended to use its knowledge of algebra with explanation-based learning to make this type of generalization.

13.5.3 EBL and Knowledge-Level Learning

Although it is an elegant formulation of the role of knowledge in learning, EBL raises a number of important questions. One of the more obvious ones concerns the issue of what an explanation-based learner actually learns. Pure EBL can only learn rules that are within the *deductive closure* of its existing theory. This means the learned rules could have been inferred from the knowledge base without using the training instance at all. The sole function of the training instance is to focus the theorem prover on relevant aspects of the problem domain. Consequently, EBL is often viewed as a form of *speed up learning* or knowledge base reformulation; EBL can make a learner work faster, because it does not have to reconstruct the proof tree underlying the new rule. However, because it could always have reconstructed the proof, EBL cannot make the learner do anything new. This distinction has been formalized by Dietterich in his discussion of *knowledge-level learning* (1986).

There are three responses to this objection. The first is to question its importance. For example, consider the game of chess: a minimal knowledge of the rules of chess, when coupled with an ability to perform unlimited look-ahead on board states, would allow a computer to play extremely well. Unfortunately, chess is too complex for this approach. An explanation-based learner that could master chess strategies would indeed learn something that was, for all practical purposes, new.

A second approach is to abandon the requirement that the learner have a complete and correct theory of the domain and focus on techniques for refining incomplete theories within the context of EBL. Here, the learner constructs a partial solution tree. Those branches of the proof that cannot be completed indicate deficiencies in the theory. A number of interesting questions remain to be examined in this area. These include the development of heuristics for reasoning with imperfect theories, credit assignment methodologies, and choosing which of several failed proofs should be repaired.

The third approach to this problem is to focus on integrating explanation-based learning and similarity-based approaches. Again, a number of basic schemes suggest themselves, such as using EBL to refine training data where the theory applies and then passing this partially generalized data on to a similarity-based learner for further generalization. Alternatively, we could use failed explanations as a means of targeting deficiencies in a theory, thereby guiding data collection for a similarity-based learner.

Other issues in EBL research include techniques for reasoning with unsound theories, alternatives to theorem proving as a means of constructing explanations, methods of dealing with noisy or missing training data, and methods of determining which generated rules to save.

13.5.4 Analogical Reasoning

Whereas “pure” EBL is limited to deductive learning, analogies offer a more flexible method of using existing knowledge. Analogical reasoning assumes that if two situations are known to be similar in some respects, it is likely that they will be similar in others. For example, if two houses have similar locations, construction, and condition, then they probably have the same sales value. Unlike the proofs used in EBL, analogy is not logically sound. In this sense it is like induction. As Russell (1989) and others have observed, analogy is a species of single instance induction: in our house example, we are inducing properties of one house from what is known about another.

Analogy allows great flexibility in applying existing knowledge to new situations. For example, assume that a student is trying to learn about the behavior of electricity, and assume that the teacher tells her that electricity is analogous to water, with voltage corresponding to pressure, amperage to the amount of flow, and resistance to the capacity of a pipe. Using analogical reasoning, the student may more easily grasp such concepts as Ohm’s law.

The standard computational model of analogy defines the *source* of an analogy to be a problem solution, example, or theory that is relatively well understood. The *target* is not completely understood. Analogy constructs a *mapping* between corresponding elements of the target and source. Analogical inferences extend this mapping to new elements of the target domain. Continuing with the “electricity is like water” analogy, if we know that this analogy maps switches onto valves, amperage onto quantity of flow, and voltage onto water pressure, we may reasonably infer that there should be some analog to the capacity (i.e., the cross-sectional area) of a water pipe; this could lead to an understanding of electrical resistance.

A number of authors have proposed a unifying framework for computational models of analogical reasoning (Hall 1989, Kedar-Cabelli 1988, Wolstencroft 1989). A typical framework consists of the following stages:

1. *Retrieval.* Given a target problem, it is necessary to select a potential source analog. Problems in analogical retrieval include selecting those features of the target and source that increase the likelihood of retrieving a useful source analog and indexing knowledge according to those features. Generally, retrieval establishes the initial elements of an analogical mapping.
2. *Elaboration.* Once the source has been retrieved, it is often necessary to derive additional features and relations of the source. For example, it may be necessary to develop a specific problem-solving trace (or explanation) in the source domain as a basis for analogy with the target.
3. *Mapping and inference.* This stage involves developing the mapping of source attributes into the target domain. This involves both known similarities and analogical inferences.
4. *Justification.* Here we determine that the mapping is indeed valid. This stage may require modification of the mapping.

5. *Learning*. In this stage the acquired knowledge is stored in a form that will be useful in the future.

These stages have been developed in a number of computational models of analogical reasoning. For example, *structure mapping theory* (Falkenhainer 1990, Falkenhainer et al. 1989, Gentner 1983) not only addresses the problem of constructing useful analogies but also provides a plausible model of how humans understand analogies. A central question in the use of analogy is how we may distinguish expressive, deep analogies from more superficial comparisons. Gentner argues that true analogies should emphasize systematic, structural features of a domain over more superficial similarities. For example, the analogy, “the atom is like the solar system” is deeper than “the sunflower is like the sun,” because the former captures a whole system of causal relations between orbiting bodies whereas the latter describes superficial similarities such as the fact that both sunflowers and the sun are round and yellow. This property of analogical mapping is called *systematicity*.

Structure mapping formalizes this intuition. Consider the example of the atom/solar system analogy, as in Figure 13.19 as explicated by Gentner (1983). The source domain includes the predicates:

yellow(sun)
blue(earth)
hotter-than(sun, earth)
causes(more-massive(sun, earth), attract(sun, earth))
causes(attract(sun, earth), revolves-around(earth, sun))

The target domain that the analogy is intended to explain includes

more-massive(nucleus, electron)
revolves-around(electron, nucleus)

Structure mapping attempts to transfer the causal structure of the source to the target. The mapping is constrained by the following rules:

1. Properties are dropped from the source. Because analogy favors systems of relations, the first stage is to eliminate those predicates that describe superficial properties of the source. Structure mapping formalizes this by eliminating predicates of a single argument (unary predicates) from the source. The rationale for this is that predicates of higher arity, by virtue of describing a relationship between two or more entities, are more likely to capture the systematic relations intended by the analogy. In our example, this eliminates such assertions as yellow(sun) and blue(earth). Note that the source may still contain assertions, such as hotter-than(sun, earth), that are not relevant to the analogy.
2. Relations map unchanged from the source to the target; the arguments to the relations may differ. In our example, such relations as revolves-around and more-massive are the same in both the source and the target. This constraint is

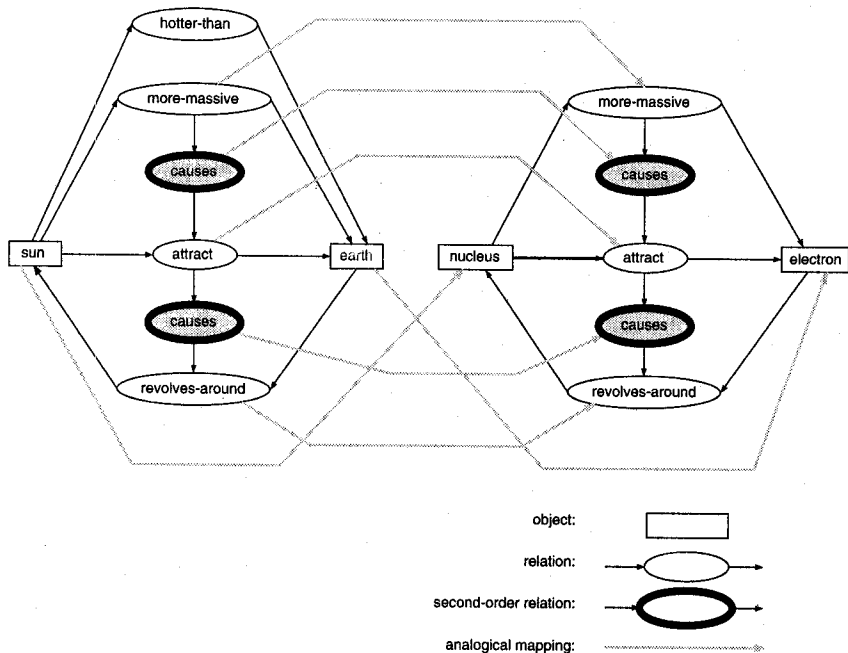

Figure 13.19 An analogical mapping.

used by many theories of analogy and greatly reduces the number of possible mappings. It is also consistent with the heuristic of giving relations preference in the mapping.

3. In constructing the mapping, higher-order relations are preferred as a focus of the mapping. In our example, **causes** is a higher-order relation, because it takes other relations as its arguments. This is called the *systematicity principle*.

These constraints lead to the mapping:

sun → nucleus
 earth → electron

Extending the mapping leads to the inference:

causes(more-massive(nucleus, electron), attract(nucleus, electron))
 causes(attract(nucleus, electron), revolves-around(electron, nucleus))

Structure mapping theory has been implemented and tested in a number of domains. Though it remains far from a complete theory of analogy, failing to address such problems as source analog retrieval, it has proven both computationally practical and able to explain

many aspects of human analogical reasoning. Finally, we noted in our presentation of *case-based reasoning*, see Section 6.3, the essential role of analogy in creating and applying a useful case base.

13.6 Unsupervised Learning

The learning algorithms discussed so far implement forms of *supervised learning*. They assume the existence of a teacher, fitness function, or some other external method of classifying training instances. *Unsupervised learning* eliminates the teacher and requires that the learner form and evaluate concepts on its own. Science is perhaps the best example of unsupervised learning in humans. Scientists do not have the benefit of a teacher. Instead, they propose hypotheses to explain observations; evaluate their hypotheses using such criteria as simplicity, generality, and elegance; and test hypotheses through experiments of their own design.

13.6.1 Discovery and Unsupervised Learning

AM (Davis and Lenat 1982, Lenat and Brown 1984) is one of the earliest and most successful discovery programs, deriving a number of interesting, even if not original, concepts in mathematics. AM began with the concepts of set theory, operations for creating new knowledge by modifying and combining existing concepts, and a set of heuristics for detecting “interesting” concepts. By searching this space of mathematical concepts, AM discovered the natural numbers along with several important concepts of number theory, such as the existence of prime numbers.

For example, AM discovered the natural numbers by modifying its notion of “bags.” A bag is a generalization of a set that allows multiple occurrences of the same element. For example, $\{a, a, b, c, c\}$ is a bag. By specializing the definition of bag to allow only a single type of element, AM discovered an analogy of the natural numbers. For example, the bag $\{1, 1, 1, 1\}$ corresponds to the number 4. Union of bags led to the notion of addition: $\{1,1\} \cup \{1,1\} = \{1,1,1,1\}$, or $2 + 2 = 4$. Exploring further modifications of these concepts, AM discovered multiplication as a series of additions. Using a heuristic that defines new operators by inverting existing operators, AM discovered integer division. It found the concept of prime numbers by noting that certain numbers had exactly two divisors (themselves and 1).

On creating a new concept, AM evaluates it according to a number of heuristics, keeping those concepts that prove “interesting.” AM determined that prime numbers were interesting based on the frequency with which they occur. In evaluating concepts using this heuristic, AM generates instances of the concept, testing each to see whether the concept holds. If a concept is true of all instances it is a tautology, and AM gives it a low evaluation. Similarly, AM rejects concepts that are true of no instances. If a concept is true of a significant portion of the examples (as is the case with prime numbers), AM evaluates it as interesting and selects it for further modification.

Although AM discovered prime numbers and several other interesting concepts, it failed to progress much beyond elementary number theory. In a later analysis of this work, Lenat and Brown (1984) examine the reasons for the program's success and its limitations. Although Lenat originally believed that AM's heuristics were the prime source of its power, this later evaluation attributed much of the program's success to the language used to represent mathematical concepts. AM represented concepts as recursive structures in a variation of the LISP programming language. Because of its basis in a well-designed programming language, this representation defined a space that contained a high density of interesting concepts. This was particularly true in the early stages of the search. As exploration continued, the space grew combinatorially, and the percentage of interesting concepts "thinned out." This observation further underscores the relationship between representation and search.

Another reason AM failed to continue the impressive pace of its early discoveries is its inability to "learn to learn." It did not acquire new heuristics as it gained mathematical knowledge; consequently, the quality of its search degraded as its mathematics grew more complex. In this sense, AM never developed a deep understanding of mathematics. Lenat has addressed this problem in later work on a program called EURISKO, which attempts to learn new heuristics (Lenat 1983).

A number of other programs have continued to explore the problems of automatic discovery. IL (Sims 1987) applies a variety of learning techniques to mathematical discovery, including analytical methods such as theorem proving and explanation-based learning (Section 13.5).

BACON (Langley et al. 1987) has developed computational models of the formation of quantitative scientific laws. For example, using data that related the distances of the planets from the sun and the period of the planets' orbits, BACON "re-discovered" Kepler's laws of planetary motion. By providing a plausible computational model of how humans may have achieved discovery in a variety of domains, BACON has provided a useful tool and methodology for examining the process of human scientific discovery. SCAVENGER (Stubblefield 1995, 1996) used a variation of the ID3 algorithm to improve its ability to form useful analogies. Shrager and Langley (1990) describe a number of other discovery systems.

Although scientific discovery is an important research area, progress to date has been slight. A more basic, and perhaps more fruitful problem in unsupervised learning, concerns the discovery of categories. Lakoff (1987) suggests that categorization is fundamental to human cognition: higher-level theoretical knowledge depends upon the ability to organize the particulars of our experience into coherent taxonomies. Most of our useful knowledge is about categories of objects, such as cows, rather than about specific individual cows, such as Blossom or Ferdinand. Nordhausen and Langley have emphasized the formation of categories as the basis for a unified theory of scientific discovery (Nordhausen and Langley 1990). In developing explanations of why chemicals react in the ways they do, chemistry built on prior work in classifying compounds into categories such as "acid" and "alkaline."

In the next section, we examine *conceptual clustering*, which is the problem of discovering useful categories in unclassified data.

13.6.2 Conceptual Clustering

The *clustering problem* begins with a collection of unclassified objects and some means of measuring the similarity of objects. Its goal is organizing the objects into a hierarchy of classes that meet some standard of quality, such as maximizing the similarity of objects in the same class.

Numeric taxonomy is one of the oldest approaches to the clustering problem. Numeric methods rely upon the representation of objects as a collection of features, each of which may have some numeric value. A reasonable similarity metric treats each object (a vector of n feature values) as a point in n -dimensional space. The similarity of two objects is the euclidean distance between them in this space.

Using this similarity metric, a common clustering algorithm builds clusters in a bottom-up fashion. This approach, often called an *agglomerative clustering* strategy, forms categories by:

1. Examining all pairs of objects, selecting the pair with the highest degree of similarity, and making that pair a cluster.
2. Defining the features of the cluster as some function, such as average, of the features of the component members and then replacing the component objects with this cluster definition.
3. Repeating this process on the collection of objects until all objects have been reduced to a single cluster.

The result of this algorithm is a binary tree whose leaf nodes are instances and whose internal nodes are clusters of increasing size.

We may extend this algorithm to objects represented as sets of symbolic, rather than numeric, features. The only problem is in measuring the similarity of objects defined using symbolic rather than numeric values. A reasonable approach defines the similarity of two objects as the proportion of features that they have in common. Given the objects

object1 = {small, red, rubber, ball}
object2 = {small, blue, rubber, ball}
object3 = {large, black, wooden, ball}

this metric would compute the similarity values:

similarity(object1, object2) = $3/4$
similarity(object1, object3) = similarity(object2, object3) = $1/4$

However, similarity-based clustering algorithms do not adequately capture the underlying role of semantic knowledge in cluster formation. For example, humans did not define constellations of stars on the basis of their closeness in the sky. Instead, these definitions were formed on the basis of existing human concepts, such as "the big dipper." In defining categories, we cannot give all features equal weight. In any given context,

certain of an object's features are more important than others; simple similarity metrics treat all features equally. Human categories depend upon the goals of the categorization and prior knowledge of the domain much more than on surface similarity. Consider, for example, the classification of whales as mammals instead of fish. Surface similarities cannot account for this classification, which depends upon the wider goals of biological classification and extensive physiological and evolutionary evidence.

Traditional clustering algorithms not only fail to take goals and background knowledge into account, but they also fail to produce meaningful semantic explanations of the resulting categories. These algorithms represent clusters *extensionally*, which means by enumerating all of their members. The algorithms produce no *intensional* definition, or no general rule that defines the semantics of the category and that may be used to classify both known and future members of the category. For example, an extensional definition of the set of people who have served as secretary-general of the United Nations would simply list those individuals. An intensional definition, such as:

{X | X has been elected secretary-general of the United Nations}

would have the added benefits of defining the class semantically and allowing us to recognize future members of the category.

Conceptual clustering addresses these problems by using machine learning techniques to produce general concept definitions and apply background knowledge to the formation of categories. CLUSTER/2 (Michalski and Stepp 1983) is a good example of this approach. It uses background knowledge in the form of biases on the language used to represent categories.

CLUSTER/2 forms k categories by constructing individuals around k *seed* objects. k is a parameter that may be adjusted by the user. CLUSTER/2 evaluates the resulting clusters, selecting new seeds and repeating the process until its quality criteria are met. The algorithm is defined:

1. Select k seeds from the set of observed objects. This may be done randomly or according to some selection function.
2. For each seed, using that seed as a positive instance and all other seeds as negative instances, produce a maximally general definition that covers all of the positive and none of the negative instances. Note that this may lead to multiple classifications of other, nonseed, objects.
3. Classify all objects in the sample according to these descriptions. Replace each maximally general description with a maximally specific description that covers all objects in the category. This decreases likelihood that classes overlap on unseen objects.
4. Classes may still overlap on given objects. CLUSTER/2 includes an algorithm for adjusting overlapping definitions.
5. Using a distance metric, select an element closest to the center of each class. The distance metric could be similar to the similarity metric discussed above.

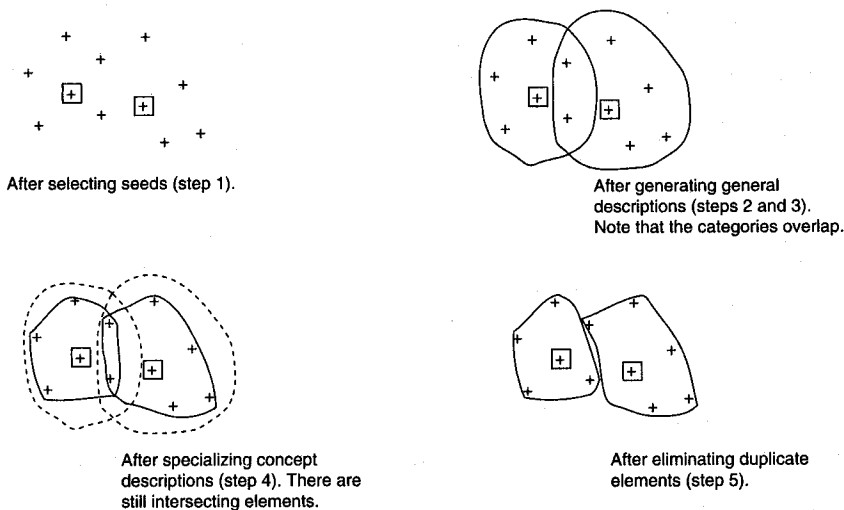

Figure 13.20 The steps of a CLUSTER/2 run.

6. Using these central elements as new seeds, repeat steps 1–5. Stop when clusters are satisfactory. A typical quality metric is the complexity of the general descriptions of classes. For instance, a variation of Occam’s Razor might prefer clusters that yield syntactically simple definitions, such as those with a small number of conjuncts.
7. If clusters are unsatisfactory and no improvement occurs over several iterations, select the new seeds closest to the edge of the cluster, rather than those at the center.

Figure 13.20 shows the stages of a CLUSTER/2 execution.

13.6.3 COBWEB and the Structure of Taxonomic Knowledge

Many clustering algorithms, as well as many supervised learning algorithms such as ID3, define categories in terms of necessary and sufficient conditions for membership. These conditions are a set of properties possessed by all members of a category and only by members of the category. Though many categories, such as the set of all United Nations delegates, may be so defined, human categories do not always fit this model. Indeed, human categorization is characterized by greater flexibility and a much richer structure than we have so far examined.

For example, if human categories were indeed defined by necessary and sufficient conditions for membership, we could not distinguish degrees of category membership. However, psychologists have noted a strong sense of prototypicality in human categorization (Rosch 1978). For instance, we generally think of a robin as a better

example of a bird than a chicken; an oak is a more typical example of a tree than a palm (at least in northern latitudes).

Family resemblance theory (Wittgenstein 1953) supports these notions of prototypicality by arguing that categories are defined by complex systems of similarities between members, rather than by necessary and sufficient conditions for membership. Such categories may not have any properties shared by all of their members. Wittgenstein cites the example of games: not all games require two or more players, such as solitaire; not all games are fun for the players, such as pro football; not all games have well-articulated rules, such as children's games of make believe; and not all games involve competition, such as jumping rope. Nonetheless, we consider the category to be well-defined and unambiguous.

Human categories also differ from most formal inheritance hierarchies (Chapter 8) in that not all levels of human taxonomies are equally important. Psychologists (Rosch 1978) have demonstrated the existence of *base-level* categories. The base-level category is the classification most commonly used in describing objects, the terminology first learned by children, and the level that in some sense captures the most fundamental classification of an object. For example, the category "chair" is more basic than either its generalizations, such as "furniture," or its specializations, such as "office chair." "Car" is more basic than either "sedan" or "vehicle."

Common methods of representing class membership and hierarchies, such as logic, inheritance systems, feature vectors, or decision trees, do not account for these effects. Yet doing so is not only important to cognitive scientists, whose goal is the understanding of human intelligence; it is also valuable to the engineering of useful AI applications. Users evaluate a program in terms of its flexibility, its robustness, and its ability to behave in ways that seem reasonable by human standards. Although we do not require that AI algorithms parallel the architecture of the human mind, any algorithm that proposes to discover categories must meet user expectations as to the structure and behavior of those categories.

COBWEB (Fisher 1987) addresses these issues. Although it is not intended as a model of human cognition, it does account for base-level categorization and degrees of category membership. In addition, COBWEB learns incrementally: it does not require that all instances be present before it begins learning. In many applications, the learner acquires data over time. In these situations, it must construct usable concept descriptions from an initial collection of data and update those descriptions as more data become available. COBWEB also addresses the problem of determining the correct number of clusters. CLUSTER/2 produced a prespecified number of categories. Although the user could vary this number or the algorithm could try different values in an effort to improve categorization, such approaches are not particularly flexible. COBWEB uses global quality metrics to determine the number of clusters, the depth of the hierarchy, and the category membership of new instances.

Unlike the algorithms we have seen so far, COBWEB represents categories probabilistically. Instead of defining category membership as a set of values that must be present for each feature of an object, COBWEB represents the probability with which each feature value is present. $p(f_i = v_{ij} | C_k)$ is the conditional probability with which feature f_i will have value v_{ij} , given that an object is in category C_k .

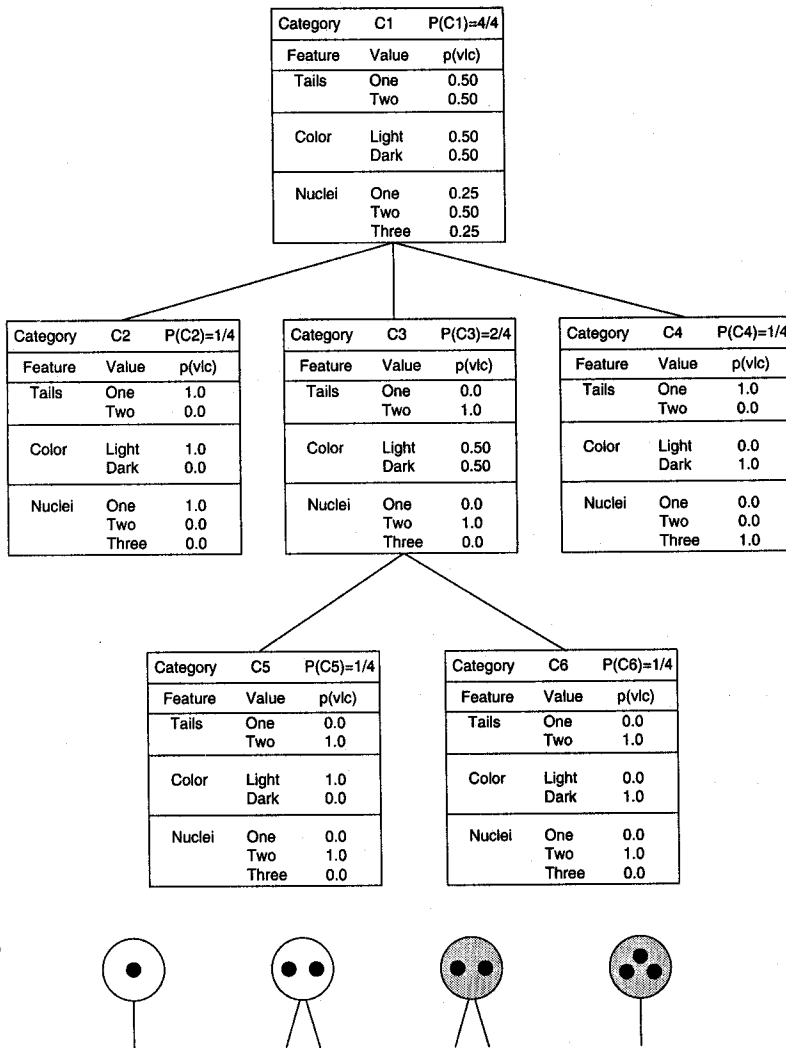

Figure 13.21 A COBWEB clustering for four one-celled organisms (Gennari et al.1989).

Figure 13.21 illustrates a COBWEB taxonomy taken from Gennari et al. (1989). In this example, the algorithm has formed a categorization of the four single-cell animals at the bottom of the figure. Each animal is defined by its value for the features: number of tails, color, and number of nuclei. The members of category C3, for example, have a 1.0 probability of having 2 tails, a 0.5 probability of having light color, and a 1.0 probability of having 2 nuclei.

As the figure illustrates, each category in the hierarchy includes probabilities of occurrence for all values of all features. This is essential to both categorizing new

instances and modifying the category structure to better fit new instances. Indeed, as an incremental algorithm, COBWEB does not separate these actions. When given a new instance, COBWEB considers the overall quality of either placing the instance in an existing category or modifying the hierarchy to accommodate the instance. The criterion COBWEB uses for evaluating the quality of a classification is called *category utility* (Gluck and Corter 1985). Category utility was developed in research on human categorization. It accounts for base-level effects and other aspects of human category structure.

Category utility attempts to maximize both the probability that two objects in the same category have values in common and the probability that objects in different categories will have different property values. Category utility is defined:

$$\sum_k \sum_i \sum_j p(f_i = v_{ij}) p(f_i = v_{ij} | c_k) p(c_k | f_i = v_{ij})$$

This sum is taken across all categories, c_k , all features, f_i , and all feature values, v_{ij} . $p(f_i = v_{ij} | c_k)$, called *predictability*, is the probability that an object has value v_{ij} for feature f_i given that the object belongs to category c_k . The higher this probability, the more likely two objects in a category share the same feature values. $p(c_k | f_i = v_{ij})$, called *predictiveness*, is the probability with which an object belongs to category c_k given that it has value v_{ij} for feature f_i . The greater this probability, the less likely objects not in the category will have those feature values. $p(f_i = v_{ij})$ serves as a weight, assuring that frequently occurring feature values will exert a stronger influence on the evaluation. By combining these values, high category utility measures indicate a high likelihood that objects in the same category will share properties, while decreasing the likelihood of objects in different categories having properties in common.

The COBWEB algorithm is defined:

```

cobweb(Node, Instance)
begin
  if Node is a leaf
    then begin
      create two children of Node, L1 and L2;
      set the probabilities of L1 to those of Node;
      initialize the probabilities for L2 to those of Instance;
      add Instance to Node, updating Node's probabilities;
    end
  else begin
    add Instance to Node, updating Node's probabilities;
    for each child, C, of Node, compute the category utility of the clustering
      achieved by placing Instance in C;
    let S1 be the score for the best categorization, C1;
    let S2 be the score for the second best categorization, C2;
    let S3 be the score for placing instance in a new category;
    let S4 be the score for merging C1 and C2 into one category;
    let S5 be the score for splitting C1 (replacing it with its child categories)
  end
end

```

```

If  $S_1$  is the best score
then cobweb( $C_1$ , Instance)           % place the instance in  $C_1$ 
else if  $S_3$  is the best score
  then initialize the new category's probabilities to those of Instance
else if  $S_4$  is the best score
  then begin
    let  $C_m$  be the result of merging  $C_1$  and  $C_2$ ;
    cobweb( $C_m$ , Instance)
  end
else if  $S_5$  is the best score
  then begin
    split  $C_1$ ;
    cobweb(Node, Instance)
  end;
end;
end

```

COBWEB performs a hill-climbing search of the space of possible taxonomies using category utility to evaluate and select possible categorizations. It initializes the taxonomy to a single category whose features are those of the first instance. For each subsequent instance, the algorithm begins with the root category and moves through the tree. At each level it uses category utility to evaluate the taxonomies resulting from:

1. Placing the instance in the best existing category.
2. Adding a new category containing only the instance.
3. Merging two existing categories into one and adding the instance to that category.
4. Splitting an existing category and placing the instance in the best category in the resulting taxonomy.

Figure 13.22 illustrates the processes of merging and splitting nodes. To merge two nodes, the algorithm creates a new node and makes the existing nodes children of that node. It computes the probabilities for the new node by combining the probabilities for the children. Splitting replaces a node with its children.

This algorithm is efficient and produces taxonomies with a reasonable number of classes. Because it allows probabilistic membership, its categories are flexible and robust. In addition, it has demonstrated base-level category effects and, through its notion of partial category matching, supports notions of prototypicality and degree of membership.

Instead of relying on two-valued logic to achieve soundness and completeness in reasoning, COBWEB, like fuzzy logic, views the often frustrating vagueness of human cognition as a necessary component for learning and reasoning in a flexible and intelligent fashion. This point of view is partly motivated by the brittleness that plagues symbolic approaches to AI. Systems including COBWEB, fuzzy reasoning, and certainty theory (Chapter 7) attempt to solve these problems in a symbolic context. The following chapter examines *subsymbolic* or *connectionist* models of intelligence and their success in solving such problems.

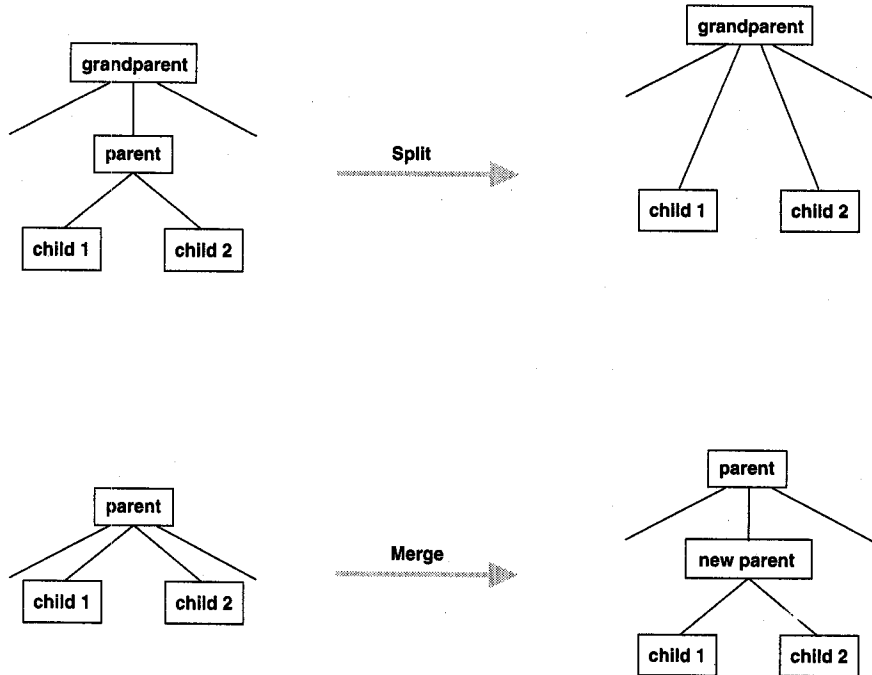

Figure 13.22 Merging and splitting of nodes.

13.7 Epilogue and References

Machine learning is one of the most exciting subfields in artificial intelligence, addressing a problem that is central to intelligent behavior and raising a number of important questions about knowledge representation, search, and even the basic assumptions of AI itself. In particular, it has focused attention on some of the weaknesses of purely symbolic approaches and led to the development of alternative metaphors for intelligent architectures, as we see in subsequent chapters.

One of the best surveys of work in the field is found in *Machine Learning: An Artificial Intelligence Approach* (Kodratoff and Michalski 1990, Michalski et al. 1983, Michalski et al. 1986). This series consists of three volumes (to date) and includes both introductory material, surveys, and papers on specific research. *Readings in Machine Learning* (Shavlik and Dietterich 1990) collects a number of important papers in the field, going back as far as 1958. By placing all this research in a single volume, the editors have provided a valuable service to both researchers and those seeking an introduction to the field. *Production System Models of Learning and Development* (Klahr et al. 1987) collects a number of papers in machine learning, including work that reflects a cognitive approach.

Computer Systems That Learn (Weiss and Kulikowski 1991) is an introductory survey of the whole field, including treatments of neural networks, statistical methods, and machine learning techniques. Readers interested in a deeper discussion of analogical reasoning should examine Carbonell (1983, 1986), Holyoak (1985), Kedar-Cabelli (1988), and Thagard (1988). For those interested in discovery and theory formation, see *Scientific Discovery: Computational Explorations of the Creative Processes* (Langley et al. 1987) and *Computational Models of Scientific Discovery and Theory Formation* (Shrager and Langley 1990). *Concept Formation: Knowledge and Experience in Unsupervised Learning* (Fisher et al. 1991) presents a number of papers on clustering, concept formation, and other forms of unsupervised learning.

ID3 has a long history within the machine learning community. *EPAM*, the *Elementary Perceiver And Memorizer* (Feigenbaum and Feldman 1963), used a type of decision tree, called a *discrimination net*, to organize sequences of nonsense syllables. Quinlan was the first to use information theory to generate children in the decision tree. In recent years Quinlan (1993) and others have extended ID3 to C4.5, and continue to address issues such as noise and the use of continuous attributes in the data (Quinlan 1996, Auer et al. 1995). Stubblefield and Luger have applied ID3 to the problem of improving the retrieval of sources in an analogical reasoner (1996).

Machine Learning is the primary journal of the field. Other sources of current research include the yearly proceedings of the International Conference on Machine Learning and the European Conference on Machine Learning as well as the proceedings of the American Association of Artificial Intelligence Conference and the International Joint Conference on Artificial Intelligence.

We present connectionist models of learning in Chapter 14, and social and emergent learning in Chapter 15. We discuss the role of inductive bias in learning in Section 16.3.

13.8 Exercises

1. Consider the behavior of Winston's concept learning program when learning the concept "step," where a step consists of a short box and a tall box placed in contact with each other, as in Figure 13.23. Create semantic net representations of three or four examples and near misses and show the development of the concept.



Figure 13.23 A step.

2. The run of the candidate elimination algorithm shown in Figure 13.9 does not show candidate concepts that were produced but eliminated because they were either overly general, overly specific, or subsumed by some other concept. Re-do the execution trace, showing these concepts and the reasons each was eliminated.

3. Build the version space search algorithms in PROLOG (or the language of your choice).
4. Using the information theoretic selection function of Section 13.4.3, show in detail how ID3 constructs the tree of Figure 13.14 from examples in Table 13.1. Be sure to show the calculations used in computing the information gain for each test and the resulting test selections.
5. Using Shannon's formula, show that a message about the outcome of a spin of a roulette wheel has more information than one about the outcome of a coin toss.
6. Develop a simple table of examples in some domain, such as classifying animals by species, and trace the construction of a decision tree by the ID3 algorithm.
7. Implement ID3 in a language of your choice and run it on the credit history example from the text.
8. Discuss problems that can arise from using continuous attributes in data, such as cost or height. Suggest some method for addressing this problem.
9. Other problems using the ID3 are bad and missing data. Data is bad if one set of attributes has two different outcomes. Data is missing if part of the attribute is not present, perhaps because in some instances it was too expensive to obtain. How might these issues be dealt with?
10. From Quinlan (1993) obtain the C4.5 decision tree algorithm and test it on a data set.
11. Develop a domain theory in some problem area of your choice. Trace the behavior of an explanation-based learner in applying this theory to several training instances.

MACHINE LEARNING: CONNECTIONIST

A cat that once sat on a hot stove will never again sit on a hot stove or on a cold one either...

—MARK TWAIN

Everything is vague to a degree you do not realize till you have tried to make it precise...

—BERTRAND RUSSELL

... as if a magic lantern threw the nerves in patterns on a screen...

—T. S. ELIOT, *The Love Song of J. Alfred Prufrock*

14.0 Introduction

In Chapter 13 we emphasized a symbol-based approach to learning. A central aspect of this hypothesis is the use of symbols to refer to objects and relations in a domain. In the present chapter, we introduce *neurally* or *biology* inspired approaches to learning.

Neurally inspired models, also known as *parallel distributed processing (PDP)* or *connectionist* systems, de-emphasize the explicit use of symbols in problem solving. Instead, they hold that intelligence arises in systems of simple, interacting components (biological or artificial neurons) through a process of learning or adaptation by which the connections between components are adjusted. Processing in these systems is distributed across collections or layers of neurons. Problem solving is parallel in the sense that all the neurons within the collection or layer process their inputs simultaneously and independently. These systems also tend to degrade gracefully because information and processing are distributed across the network's nodes and layers.

In connectionist models there is, however, a strong representational character both in the creation of input parameters as well as in the interpretation of output values. To build a

neural network, for example, the designer must create a scheme for encoding patterns in the world into numerical quantities in the net. The choice of an encoding scheme can play a crucial role in the eventual success or failure of the network to learn.

In connectionist systems, processing is parallel and distributed with no manipulation of symbols as symbols. Patterns in a domain are encoded as numerical vectors. The connections *between* components, or neurons, are also represented by numerical values. Finally, the transformation of patterns is the result of a numerical operations, usually, matrix multiplications. These “designer’s choices” for a connectionist architecture constitute the *inductive bias* of the system.

The algorithms and architectures that implement these techniques are usually trained or conditioned rather than explicitly programmed. Indeed, this is a major strength of the approach: an appropriately designed network architecture and learning algorithm can often capture invariances in the world, even in the form of strange attractors, without being explicitly programmed to recognize them. How this happens makes up the material of Chapter 14.

The tasks for which the connectionist approach is well suited include:

- classification*, deciding the category or grouping to which an input value belongs;
- pattern recognition*, identifying structure in sometimes noisy data;
- memory recall*, including the problem of content addressable memory;
- prediction*, such as identifying disease from symptoms, causes from effects;
- optimization*, finding the “best” organization of constraints; and
- noise filtering*, or separating signal from background, factoring out the irrelevant components of a signal

The methods of this chapter work best on those tasks that symbolic models seem to handle poorly. This typically includes tasks in which the problem domain requires perception based skills, or lacks a clearly defined syntax.

In Section 14.1 we introduce neurally inspired learning models from an historical viewpoint. We present the basic components of neural network learning, including the “mechanical” neuron, and describe some historically important early work, including the McCulloch–Pitts (1943) neuron. The evolution of the network training paradigms over the past 40 years offers important insights into the present state of the discipline.

In Section 14.2, we continue the historical presentation with the introduction of *perceptron* learning, and the *delta* rule. We present an example of the perceptron used as a classifier. In Section 14.3 we introduce nets with hidden layers, and the *backpropagation* learning rule. These innovations were introduced in the evolution of artificial neural networks to overcome problems the early systems had in generalizing across data points that were not linearly separable. Backpropagation is an algorithm for apportioning “blame” for incorrect responses to the nodes of a multilayered system with continuous thresholding.

In Section 14.4 we present models for *competitive learning* developed by Kohonen (1984) and Hecht-Nielsen (1987). In these models, network weight vectors are used to represent patterns rather than connection strengths. The *winner-take-all* learning algorithm selects the node whose pattern of weights is most like the input vector and adjusts it to make it more like the input vector. It is unsupervised in that *winning* is simply identifying

the node whose current weight vector most closely resembles the input vector. The combination of Kohonen and Grossberg (1982) layers in a single network offers an interesting model for stimulus–response learning called *counter-propagation* learning.

In Section 14.5 we present Hebb's (1949) model of reinforcement learning. Hebb conjectured that each time one neuron contributes to the firing of another neuron, the strength of the pathway between the neurons is increased. Hebbian learning is modeled by a simple algorithm for adjusting connection weights. We present both unsupervised and supervised versions of Hebbian learning. We also introduce the linear associator, a Hebbian based model for pattern retrieval from memory.

Section 14.6 introduces a very important family of networks called *attractor networks*. These networks employ feedback connections to repeatedly cycle a signal within the network. The network output is considered to be the network state upon reaching equilibrium. Network weights are constructed so that a set of *attractors* is created. Input patterns within an attractor *basin* reach equilibrium at that attractor. The attractors can therefore be used to store patterns in a memory. Given an input pattern, we retrieve either the closest stored pattern in the network or a pattern associated with the closest stored pattern. The first type of memory is called *autoassociative*, the second type *heteroassociative*. John Hopfield (1982), a theoretical physicist, defined a class of attractor networks whose convergence can be represented in terms of energy minimization. Hopfield networks can be used to solve constraint problems, such as the traveling salesperson problem, by mapping the optimization function into an energy function.

After introducing evolutionary models of learning in Chapter 15, including genetic algorithms and artificial life, we discuss the representational issues and bias involved in learning as well as the strengths of each learning paradigm in Section 16.3.

14.1 Foundations for Connectionist Networks

14.1.1 Early History

Connectionist architectures are often thought of as a recent development, however we can trace their origins to early work in computer science, psychology, and philosophy. John von Neumann, for example, was fascinated by both cellular automata and neurally inspired approaches to computation. Early work in neural learning was influenced by psychological theories of animal learning, especially that of Hebb (1949). In this section, we outline the basic components of neural network learning, and present historically important early work in the field.

The basis of neural networks is the artificial neuron, as in Figure 14.1. An artificial neuron consists of:

Input signals, x_i . These data may come from the environment, or the activation of other neurons. Different models vary in the allowable range of the input values; typically inputs are discrete, from the set $\{0, 1\}$ or $\{-1, 1\}$, or real numbers.

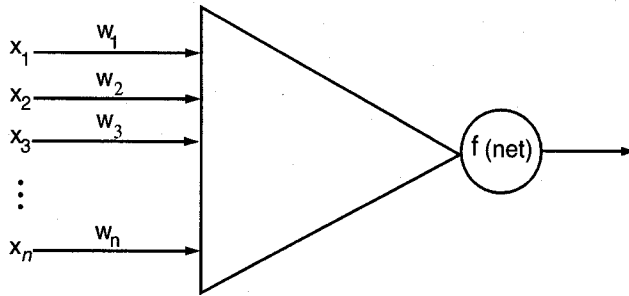

Figure 14.1 An artificial neuron, input vector x_i , weights on each input line, and a thresholding function f that determines the neuron's output value.

A set of real valued weights, w_i . The weights are used to describe connection strengths, and as we see shortly, the strengths of bias links.

An activation level $\sum w_i x_i$. The neuron's activation level is determined by the cumulative strength of its input signals where each input signal is scaled by the connection weight w_i along that input line. The activation level is thus computed by taking the sum of the scaled inputs, that is, $\sum w_i x_i$.

A threshold function, f . This function computes the neuron's final or output state by determining how far the neuron's activation level is below or above some threshold value. The threshold function is intended to produce the on/off state of actual neurons.

In addition to these properties of individual neurons, a neural network is also characterized by global properties such as:

The network topology. The topology of the network is the pattern of connections between the individual neurons. This topology is a primary source of the nets inductive bias.

The learning algorithm used. A number of algorithms for learning are presented in this chapter.

The encoding scheme. This includes the interpretation placed on the data to the network and the results of its processing.

The earliest example of neural computing is the McCulloch–Pitts neuron (McCulloch and Pitts 1943). The inputs to a McCulloch–Pitts neuron are either excitatory (+1) or inhibitory (−1). The activation function multiplies each input by its corresponding weight and sums the results; if the sum is greater than or equal to zero, the neuron returns 1, otherwise, −1. McCulloch and Pitts showed how these neurons could be constructed to compute any logical function, demonstrating that systems of these neurons provide a complete computational model.

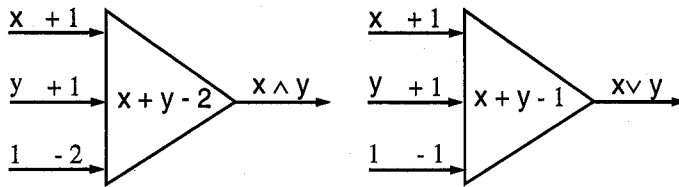

Figure 14.2 McCulloch–Pitts neurons to calculate the logic functions and and or.

Figure 14.2 shows the McCulloch-Pitts neurons for computing logical functions. The and neuron has three inputs: x and y are the values to be conjoined; the third, sometimes called a *bias*, has a constant value of $+1$. The input data and bias have weights of $+1$, $+1$, and -2 , respectively. Thus, for any values of x and y , the neuron computes the value of $x + y - 2$: if this value is less than 0, it returns -1 , otherwise a 1. Table 14.1 illustrates the neuron computing x and y . In a similar fashion, the weighted sum of input data for the or neuron, see Figure 14.2, is greater than or equal to 0 unless both x and y equal -1 .

x	y	$x + y - 2$	Output
1	1	0	1
1	0	-1	-1
0	1	-1	-1
0	0	-2	-1

Table 14.1 The McCulloch–Pitts model for logical *and*.

Although McCulloch and Pitts demonstrated the power of neural computation, interest in the approach only began to flourish with the development of practical learning algorithms. Early learning models drew heavily on the work of the psychologist D. O. Hebb (1949), who speculated that learning occurred in brains through the modification of synapses. Hebb theorized that repeated firings across a synapse increased its sensitivity and the future likelihood of its firing. If a particular stimulus repeatedly caused activity in a group of cells, those cells come to be strongly associated. In the future, similar stimuli would tend to excite the same neural pathways, resulting in the recognition of the stimuli. Hebb's model of learning worked purely on reinforcement of used paths and ignored inhibition, punishment for error, or attrition. Modern psychologists attempted to recreate Hebb's model but failed to produce general results without addition of an inhibitory mechanism (Rochester et al. 1988, Quinlan 1991). We consider the Hebbian model of learning in Section 14.5.

In the next section we extend the McCulloch–Pitts neural model by adding layers of connected neural mechanisms and algorithms for their interactions. The first version of this was called the *perceptron*.

14.2 Perceptron Learning

14.2.1 The Perceptron Training Algorithm

In the late 1950s, Frank Rosenblatt devised a learning algorithm for a type of single layer network called a *perceptron* (Rosenblatt 1958). In its signal propagation the perceptron was similar to the McCulloch–Pitts neuron, see, for example, Figure 14.6. The input values and activation levels of the perceptron are either -1 or 1; weights are real valued. The activation level of the perceptron is given by summing the weighted input values, $\sum x_i w_i$. Perceptrons use a simple hard-limiting threshold function, where an activation above a threshold results in an output value of 1, and -1 otherwise. Given input values x_i , weights w_i , and a threshold, t , the perceptron computes its output value as:

$$\begin{aligned} & 1 \text{ if } \sum x_i w_i > t \\ & -1 \text{ if } \sum x_i w_i < t \end{aligned}$$

The perceptron uses a simple form of supervised learning. After attempting to solve a problem instance, a teacher gives it the correct result. The perceptron then changes its weights in order to reduce the error. The following rule is used. Let c be a constant whose size determines the learning rate and d be the desired output value. The adjustment for the weight on the i th component of the input vector, Δw_i , is given by:

$$\Delta w_i = c(d - \text{sign}(\sum x_i w_i)) x_i$$

The $\text{sign}(\sum x_i w_i)$ is the perceptron output value. It is +1 or -1. The difference between the desired output and the actual output values will thus be 0, 2, or -2. Therefore for each component of the input vector:

If the desired output and actual output values are equal, do nothing.

If the actual output value is -1 and should be 1, increment the weights on the i th line by $2cx_i$.

If the actual output value is 1 and should be -1, decrement weights on the i th line by $-2cx_i$.

This procedure has the effect of producing a set of weights which minimize the average error over the entire training set. If there exists a set of weights which give the correct output for every member of the training set, the perceptron learning procedure will learn it (Minsky and Papert 1969).

Perceptrons were initially greeted with enthusiasm. However, Nils Nilsson (1965) and others analyzed the limitations of the perceptron model. They demonstrated that perceptrons could not solve a certain difficult class of problems, namely problems in which the data points are not linearly separable. Although various enhancements of the perceptron

model, including multilayered perceptrons, were envisioned at the time, Marvin Minsky and Seymour Papert, in their book *Perceptrons* (1969), argued that the linear separability problem could not be overcome by any form of the perceptron network.

An example of a nonlinearly separable classification is *exclusive-or*. Exclusive-or may be represented by the truth table:

x_1	x_2	Output
1	1	0
1	0	1
0	1	1
0	0	0

Table 14.2 The truth table for *exclusive-or*.

Consider a perceptron with two inputs, x_1 , x_2 , two weights, w_1 , w_2 , and threshold t . In order to learn this function, a network must find a weight assignment that satisfies the following inequalities:

$$w_1 * 1 + w_2 * 1 < t, \text{ from line 1 of the truth table.}$$

$$w_1 * 1 + 0 > t, \text{ from line 2 of the truth table.}$$

$$0 + w_2 * 1 > t, \text{ from line 3 of the truth table.}$$

$$0 + 0 < t, \text{ or } t \text{ must be positive, from the last line of the table.}$$

This series of equations on w_1 , w_2 , and t has no solution, proving that a perceptron that solves *exclusive-or* is impossible. Although multilayer networks would eventually be built that could solve the exclusive-or problem, see Section 14.3.3, the perceptron learning algorithm only worked for single layer networks.

What makes exclusive-or impossible for the perceptron is that the two classes to be distinguished are not *linearly separable*. This can be seen in Figure 14.3. It is impossible to draw a straight line in two dimensions that separates the data points $\{(0,0), (1,1)\}$ from $\{(0,1), (1,0)\}$.

We may think of the set of data values for a network as defining a space. Each parameter of the input data corresponds to one dimension, with each input value defining a point in the space. In the exclusive-or example, the four input values, indexed by the x_1 , x_2 coordinates, make up the data points of Figure 14.3. The problem of learning a binary classification of the training instances reduces to that of separating these points into two groups. For a space of n dimensions, a classification is linearly separable if its classes can be separated by an $n - 1$ dimensional hyperplane. (In two dimensions an n -dimensional hyperplane is a line; in three dimension it is a plane, etc.).

As a result of the linear separability limitation, research shifted toward work in symbol-based architectures, slowing progress in the connectionist methodology. Subsequent work in the 1970s and 1980s has shown these problems to be solvable, however.

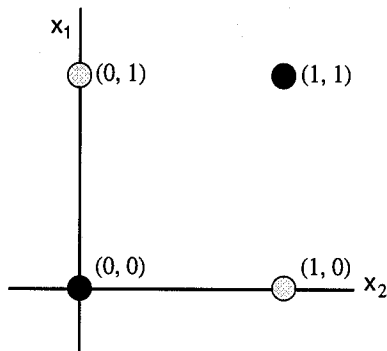

Figure 14.3 The exclusive-or problem. No straight line in 2-dimensions can separate the (0, 1) and (1, 0) data points from (0, 0) and (1, 1).

In Section 14.3 we discuss *backpropagation*, an extension of perceptron learning that works for multilayered networks. Before examining backpropagation, we offer an example of a perceptron network that performs classifications. We end Section 14.2 by defining the *delta rule*, a generalization of the perceptron learning algorithm that is used in many neural network architectures, including backpropagation.

14.2.2 An Example: Using a Perceptron Network to Classify

Figure 14.4 offers an overview of the classification problem. Raw data from a space of possible points are selected and transduced to a new data/pattern space. In this new pattern space features are identified, and finally, the entity these features represent is classified. An example would be sound waves recorded on a digital recording device. From there the acoustic signals are translated to a set of amplitude and frequency parameters. Finally, a classifier system might recognize these feature patterns as the voiced speech of a particular person. Another example would be the capture of information by medical test equipment. The features found in this pattern space would then be used to classify symptom sets into different disease categories.

In our classification example, the transducer and feature extractor of Figure 14.4 translates the problem information into parameters of a two-dimensional Cartesian space. Figure 14.5 presents the two-feature perceptron analysis of the information in Table 14.3. The first two columns of the table present the data points on which the network was trained. The third column represents the classification, +1 or -1, used as feedback in network training. Figure 14.5 is a graph of the training data of the problem, showing the linear separation of data classes created when the trained network was run on each data point.

We discuss first the general theory of classification. Each data grouping that a classifier identifies is represented by a region in multidimensional space. Each class R_i has a discriminant function g_i measuring membership in that region. Within the region R_i , the i th discriminant function has the largest value:

$$g_i(\mathbf{x}) > g_j(\mathbf{x}) \text{ for all } j, 1 < j < n.$$

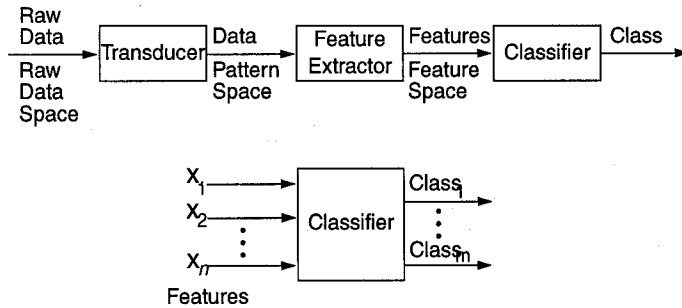

Figure 14.4 A full classification system.

In the simple example of Table 14.3, the two input parameters produce two obvious regions or classes in the space, one represented by 1, the other by -1.

x_1	x_2	Output
1.0	1.0	1
9.4	6.4	-1
2.5	2.1	1
8.0	7.7	-1
0.5	2.2	1
7.9	8.4	-1
7.0	7.0	-1
2.8	0.8	1
1.2	3.0	1
7.8	6.1	-1

Table 14.3 A data set for perceptron classification.

An important special case of discriminant functions is one which evaluates class membership based on the distance from some central point in the region. Classification based on this discriminant function is called *minimum distance classification*. A simple argument shows that if the classes are linearly separable there is a minimum distance classification.

If the regions of R_i and R_j are adjacent, as are the two regions in Figure 14.5, there is a boundary region where the discriminant functions are equal:

$$g_i(x) = g_j(x) \text{ or } g_i(x) - g_j(x) = 0.$$

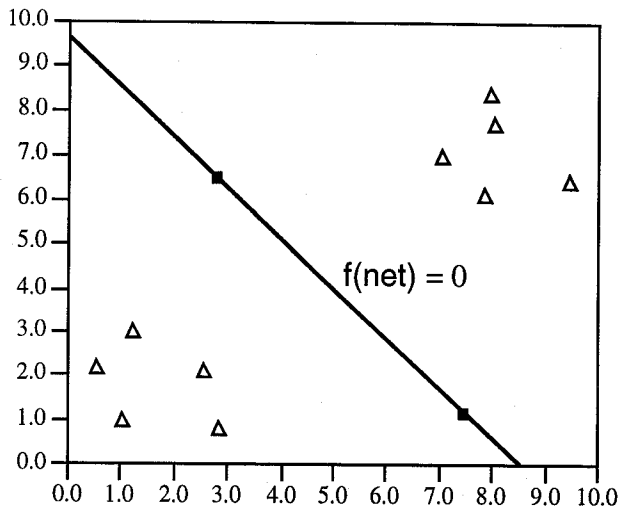

Figure 14.5 A two-dimensional plot of the data points in Table 14.3. The perceptron of Section 14.2.1 provides a linear separation of the data sets.

If the classes are linearly separable, as in Figure 14.5, the discriminant function separating the regions is a straight line, or $g_i(x) - g_j(x)$ is linear. Since a line is the locus of points equally distant from two fixed points, the discriminant functions, $g_i(x)$ and $g_j(x)$, are minimum distance functions, measured from the Cartesian center of each of the regions.

The perceptron of Figure 14.6 computes precisely this linear function. We need two input parameters and will have a bias with a constant value of 1. The perceptron computes:

$$f(\text{net}) = f(w_1 \cdot x_1 + w_2 \cdot x_2 + w_3 \cdot 1), \text{ where } f(x) \text{ is the sign of } x.$$

When $f(x)$ is +1, x is interpreted as being in one class, when it is -1, x is in the other class. This thresholding to +1 or -1 is called linear bipolar thresholding (see Figure 14.7a). The bias serves to shift the thresholding function on the horizontal axis. The extent of this shift is learned by adjusting the weight w_3 during training.

We now use the data points of Table 14.3 to train the perceptron of Figure 14.6. We assume random initialization of the weights to $[\cdot75, \cdot5, \cdot6]$ and use the perceptron training algorithm of Section 14.2.1. The superscripts represent the iteration of the algorithm. We start by taking the first data point in the table:

$$f(\text{net})^1 = f(\cdot75 \cdot 1 + \cdot5 \cdot 1 - \cdot6 \cdot 1) = f(\cdot65) = 1$$

Since $f(\text{net})^1 = 1$, the correct output value, we do not adjust the weights. Thus $W^2 = W^1$. For our second data point:

$$f(\text{net})^2 = f(\cdot75 \cdot 9.4 + \cdot5 \cdot 6.4 - \cdot6 \cdot 1) = f(9.65) = 1$$

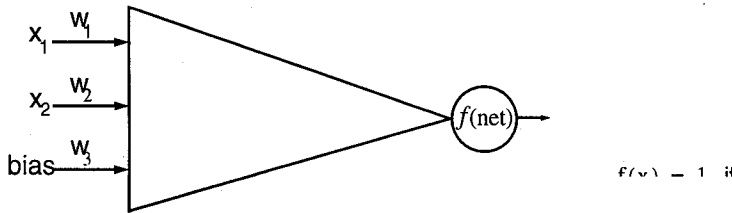

Figure 14.6 The perceptron net for the example data of Table 14.3. The thresholding function is linear and bipolar (see Figure 14.7a).

This time our result should have been -1 so we have to apply the learning rule, described in Section 14.1.1:

$$W^t = W^{t-1} + c(d^{t-1} - \text{sign}(W^{t-1} * X^{t-1})) X^{t-1}$$

where c is the learning constant, X and W are the input and weight vectors, and t the iteration of the net. d^{t-1} is the desired result at time $t - 1$, or in our situation, at $t = 2$. The net output at $t = 2$ is 1. Thus the difference between the desired and actual net output, $d^2 - \text{sign}(W^2 * X^2)$, is -2. In fact, in a hard limited bipolar perceptron, the learning increment will always be either $+2c$ or else $-2c$ times the training vector. We let the learning constant be a small positive real number, 0.2. We update the weight vector:

$$W^3 = W^2 + 0.2(-1 - 1)X^2 = \begin{bmatrix} 0.75 \\ 0.50 \\ -0.60 \end{bmatrix} - 0.4 \begin{bmatrix} 9.4 \\ 6.4 \\ 1.0 \end{bmatrix} = \begin{bmatrix} -3.01 \\ -2.06 \\ -1.00 \end{bmatrix}$$

We now consider the third data point with the newly adjusted weights:

$$f(\text{net})^3 = f(-3.01 * 2.5 - 2.06 * 2.1 - 1.0 * 1) = f(-12.84) = -1$$

Again, the net result is not the desired output. We show the W^4 adjustment:

$$W^4 = W^3 + 0.2(1 - (-1))X^3 = \begin{bmatrix} -3.01 \\ -2.06 \\ -1.00 \end{bmatrix} + 0.4 \begin{bmatrix} 2.5 \\ 2.1 \\ 1.0 \end{bmatrix} = \begin{bmatrix} -2.01 \\ -1.22 \\ -0.60 \end{bmatrix}$$

After 10 iterations of the perceptron net, the linear separation of Figure 14.5 is produced. After repeated training on the data set, about 500 iterations in total, the weight vector converges to $[-1.3, -1.1, 10.9]$. We are interested in the line separating the two classes. In terms of the discriminant functions g_i and g_j , the line is defined as the locus of points at which $g_i(x) = g_j(x)$ or $g_i(x) - g_j(x) = 0$, that is, where the net output is 0. The equation for the net output is given in terms of the weights. It is:

$$\text{output} = w_1x_1 + w_2x_2 + w_3.$$

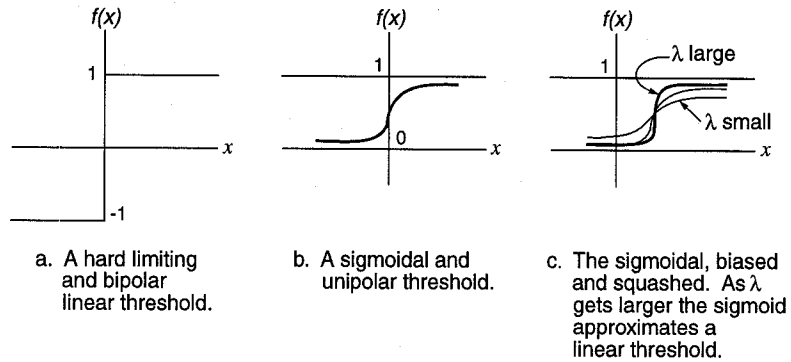

Figure 14.7 Thresholding functions.

Consequently, the line separating the two classes is defined by the linear equation:

$$-1.3*x_1 + -1.1*x_2 + 10.9 = 0.$$

14.2.3 The Delta Rule

A straightforward way to generalize the perceptron network is to replace its hard limiting thresholding function with other types of activation functions. For example, continuous activation functions offer the possibility of more sophisticated learning algorithms by allowing for a finer granularity in error measurement.

Figure 14.7 shows the graph of some thresholding functions: a linear bipolar threshold function, Figure 14.7a, similar to that used by the perceptron, and a number of *sigmoidal* functions. Sigmoidal functions are so called because their graph is an “S”-shaped curve, as in Figure 14.7b. A common sigmoidal activation function, called the *logistic* function, is given by the equation:

$$f(\text{net}) = 1/(1 + e^{-\lambda*\text{net}}), \text{ where } \text{net} = \sum x_i w_i$$

As with previously defined functions, x_i is the input on line i , w_i is the weight on line i , and λ a “squashing parameter” used to fine-tune the sigmoidal curve. As λ gets large, the sigmoid approaches a linear threshold function over $\{0,1\}$; as it gets closer to 1 it approaches a straight line.

These threshold graphs plot the input values, the activation level of the neuron, against the scaled activation or output of the neuron. The sigmoidal activation function is continuous, which allows a more precise measure of error. Like the hard limiting thresholding function, the sigmoidal activation function maps most values in its domain into regions close to 0 or 1. However, there is a region of rapid but continuous transition between 0 and 1. In a sense, it approximates a thresholding behavior while providing a continuous output function. The use of λ in the exponent adjusts the slope of the sigmoid shape in the transition region. A weighted *bias* shifts the threshold along the x -axis.

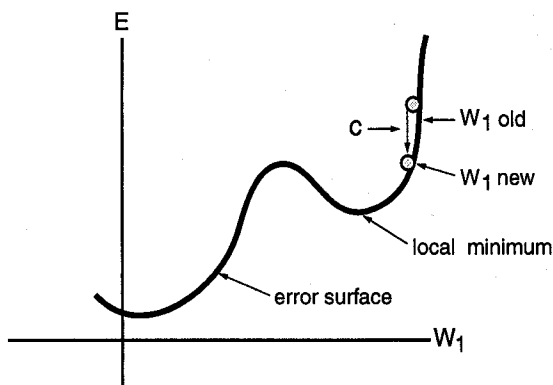

Figure 14.8 An error surface in two dimensions. Constant c dictates the size of the learning step.

The historical emergence of networks with continuous activation functions suggested new approaches to error reduction learning. The Widrow–Hoff (1960) learning rule is independent of the activation function, minimizing the squared error between the desired output value and the network activation, $net_i = WX_i$. Perhaps the most important learning rule for continuous activation functions is the *delta rule* (Rumelhart et al. 1986).

Intuitively, the delta rule is based on the idea of an error surface, as illustrated in Figure 14.8. This error surface represents cumulative error over a data set as a function of network weights. Each possible network weight configuration is represented by a point on this error surface. Given a weight configuration, we want our learning algorithm to find the direction on this surface which most rapidly reduces the error. This approach is called *gradient descent learning* because the gradient is a measure of slope, as a function of direction, from a point on a surface.

To use the delta rule, the network must use an activation function which is continuous and therefore differentiable. The logistic formula just presented has this property. The delta rule learning formula for weight adjustment on the j th input to the i th node is:

$$c (d_i - O_i) f' (net_i) x_j,$$

where c is the constant controlling the learning rate, d_i and O_i are the desired and actual output values of the i th node. The derivative of the activation function for the i th node is f' , and x_j is the j th input to node i . We now show the derivation of this formula.

The mean squared network error is found by summing the squared error for each node:

$$\text{Error} = (1/2) \sum_i (d_i - O_i)^2$$

where d_i is the desired value for each output node and O_i is the actual output of the node. We square each error so that the individual errors, some possibly with negative and others with positive values, will not, in summation, cancel each other out.

We consider here the case where the node is in the output layer; we describe the general case when we present networks with hidden layers in Section 14.3. We want first to measure the rate of change of network error with respect to output of each node. To do this we use the notion of a *partial derivative*, which gives us the rate of change of a multivariable function with respect to a particular variable. The partial derivative of the total error with respect to each output unit i is:

$$\frac{\delta \text{Error}}{\delta O_i} = \frac{\delta(1/2) * \Sigma(d_i - O_i)^2}{\delta O_i} = \frac{\delta(1/2) * (d_i - O_i)^2}{\delta O_i}$$

The second simplification is possible because we are considering a node on the output layer, where its error will not affect any other node. Taking the derivative of this quantity, we get:

$$\frac{\delta(1/2) * (d_i - O_i)^2}{\delta O_i} = -(d_i - O_i)$$

What we want is the rate of change of network error as a function of change in the weights at node i . To get the change in a particular weight, w_k , we rely on the use of the partial derivative, this time taking the partial derivative of the error at each node with respect to the weight, w_k , at that node. The expansion on the right side of the equal sign is given us by the chain rule for partial derivatives:

$$\frac{\delta \text{Error}}{\delta w_k} = \frac{\delta \text{Error}}{\delta O_i} * \frac{\delta O_i}{\delta w_k}$$

This gives us the pieces we need to solve the equation. Using our earlier result, we obtain:

$$\frac{\delta \text{Error}}{\delta w_k} = -(d_i - O_i) * \frac{\delta O_i}{\delta w_k}$$

We continue by considering the right most factor, the partial derivative of the actual output at the i th node taken with respect to each weight at that node. The formula for the output of node i as a function of its weights is:

$$O_i = f(W_i X_i), \text{ where } W_i X_i = \text{net}_i.$$

Since f is a continuous function, taking the derivative we get:

$$\frac{\delta O_i}{\delta w_k} = x_k * f'(W_i X_i) = f'(\text{net}_i) * x_k$$

Substituting in the previous equation:

$$\frac{\delta \text{Error}}{\delta w_k} = -(d_i - O_i) f'(\text{net}_i) * x_k$$

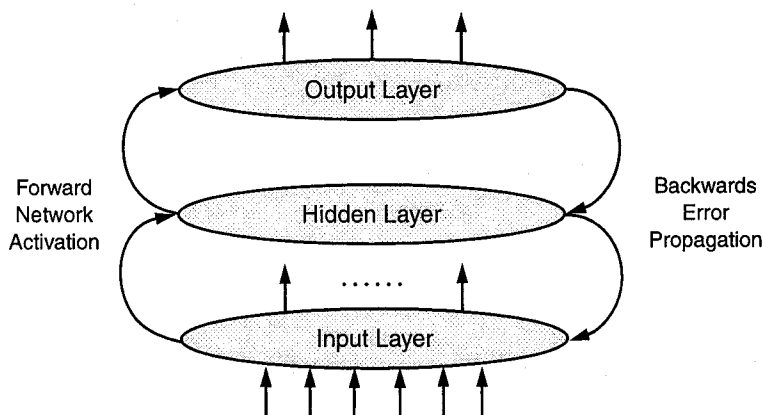

Figure 14.9 Backpropagation in a connectionist network having a hidden layer.

The minimization of the error requires that the weight changes be in the direction of the negative gradient component. Therefore:

$$\Delta w_k = -c \frac{\delta \text{Error}}{\delta w_k} = -c[-(d_i - O_i) * f'(\text{net}_i) * x_k] = c(d_i - O_i) f'(\text{net}_i) * x_k$$

We observe that the delta rule is like *hillclimbing*, Section 4.1, in that at every step, it attempts to minimize the local error measure by using the derivative to find the slope of the error space in the region local to a particular point. This makes delta learning vulnerable to the problem of distinguishing local from global minima in the error space.

The learning constant, c , exerts an important influence on the performance of the delta rule, as further analysis of Figure 14.8 illustrates. The value of c determines how much the weight values move in a single learning episode. The larger the value of c , the more quickly the weights move toward an optimal value. However, if c is too large, the algorithm may overshoot the minimum or oscillate around the optimal weights. Smaller values of c are less prone to this problem, but do not allow the system to learn as quickly. The optimal value of the learning rate, sometimes enhanced with a momentum factor (Zurada 1992), is a parameter adjusted for a particular application through experiment.

Although the delta rule does not by itself overcome the limitations of single layer networks, its generalized form is central to the functioning of backpropagation, an algorithm for learning in a multilayer network. This algorithm is presented in the next section.

14.3 Backpropagation Learning

14.3.1 Deriving the Backpropagation Algorithm

As we have seen, single layer perceptron networks are limited as to the classifications that they can perform. We show in Sections 14.3 and 14.4 that the addition of multiple layers

can overcome many of these limitations. In Section 16.3 we observe that multilayered networks are computationally complete, that is, equivalent to the class of Turing machines. Early researchers, however, were not able to design a learning algorithm for their use. We present in this section the generalized delta rule, which offers one solution to this problem.

The neurons in a multilayer network (see Figure 14.9) are connected in layers, with units in layer k passing their activations only to neurons in layer $k+1$. Multilayer signal processing means that errors deep in the network can spread and evolve in complex, unanticipated ways through successive layers. Thus, the analysis of the source of error at the output layer is complex. Backpropagation provides an algorithm for apportioning blame and adjusting weights accordingly.

The approach taken by the backpropagation algorithm is to start at the output layer and *propagate* error backwards through the hidden layers. When we analyzed learning with the delta rule, we saw that all the information needed to update the weights on a neuron was local to that neuron, except for the amount of error. For output nodes, this is easily computed as the difference between the desired and actual output values. For nodes in hidden layers, it is considerably more difficult to determine the error for which a node is responsible. The activation function for backpropagation is usually the logistic function:

$$f(\text{net}) = 1/(1 + e^{-\lambda \cdot \text{net}}), \text{ where } \text{net} = \sum x_i w_i.$$

This function is used for three reasons. First, it has the sigmoid shape. Second, as a continuous function, it has a derivative everywhere. Third, the value of the derivative is greatest where the sigmoidal function is changing most rapidly, causing assignment of the most error responsibility to those nodes whose activation was least certain. Finally, the derivative is easily computed by a subtraction and multiplication:

$$f'(\text{net}) = f'(1/(1 + e^{-\lambda \cdot \text{net}})) = f(\text{net}) * (1 - f(\text{net})).$$

Backpropagation training uses the generalized delta rule. This uses the same gradient descent approach presented in Section 14.2. The difference is that for nodes in the hidden layer we look at their contribution to the error at the output layer. The formulas for computing the adjustment of the k th weight of the i th node in backpropagation training are:

- 1) $\Delta w_{ik} = -c(d_i - O_i) * O_i (1 - O_i) x_{ik}$, for nodes on the output layer, and
- 2) $\Delta w_{ik} = -c * O_i (1 - O_i) \sum (-\text{delta}_j * w_{ij}) x_{ik}$, for nodes on hidden layers.

In 2), j is the index of the nodes in the next layer to which i 's signals fan out and:

$$\text{delta}_j = \frac{\delta \text{Error}}{\delta \text{net}_j} = (d_i - O_i) * O_i (1 - O_i).$$

We now show the derivation of these formulae. First we derive 1), the formula for weight adjustment on nodes in the output layer. As before, what we want is the rate of change of network error as a function of change in the k th weight, w_k , of node i . We treated this situation in the derivation of the delta rule, Section 14.2.3, and showed that:

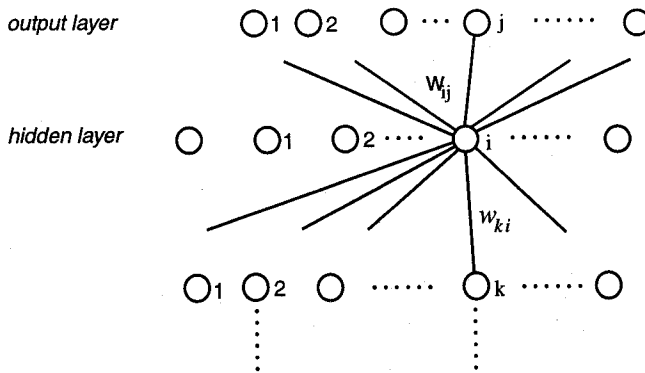

Figure 14.10 $\sum_j -\delta_j w_{ij}$ is the total contribution of node i to the error at the output. Our derivation gives the adjustment for w_{ki} .

$$\frac{\delta \text{Error}}{\delta w_k} = -(d_j - O_j) * f'(\text{net}_j) * x_k$$

Since f is now the logistic activation function, we have:

$$f'(\text{net}) = f'(1/(1 + e^{-\lambda * \text{net}})) = f(\text{net}) * (1 - f(\text{net})).$$

Recall that $f(\text{net}_j)$ is simply O_j . Substituting in the previous equation, we get:

$$\frac{\delta \text{Error}}{\delta w_k} = -(d_j - O_j) * O_j * (1 - O_j) * x_k$$

Since the minimization of the error requires that the weight changes be in the direction of the negative gradient component, we multiply by $-c$ to get the weight adjustment for the i th node of the output layer:

$$\Delta w_k = -c(d_j - O_j) * O_j * (1 - O_j) * x_k$$

We next derive the weight adjustment for hidden nodes. For the sake of clarity we initially assume a single hidden layer. We take a single node i on the hidden layer and analyze its contribution to the total network error. We do this by initially considering node i 's contribution to the error at a node j on the output layer. We then sum these contributions across all nodes on the output layer. Finally, we describe the contribution of the k th input weight on node i to the network error. Figure 14.10 illustrates this situation.

We first look at the partial derivative of the network error with respect to the output of node i on the hidden layer. We get this by applying the chain rule:

$$\frac{\delta \text{Error}}{\delta O_i} = \frac{\delta \text{Error}}{\delta \text{net}_j} * \frac{\delta \text{net}_j}{\delta O_i}$$

The negative of the first term on the right-hand side, $(\delta \text{Error}) / (\delta \text{net}_j)$, is called delta_j . Therefore, we can rewrite the equation as:

$$\frac{\delta \text{Error}}{\delta O_i} = -\text{delta}_j * \frac{\delta \text{net}_j}{\delta O_i}$$

Recall that the activation of node j , net_j , on the output layer is given by the sum of the product of its weights and the output values of the nodes on the hidden layer:

$$\text{net}_j = \sum_i w_{ij} O_i$$

Since we are taking the partial derivative with respect to only one component of the sum, namely the connection between node i and node j , we get:

$$\frac{\delta \text{net}_j}{\delta O_i} = w_{ij}$$

where w_{ij} is the weight on the connection from node i in the hidden layer to node j in the output layer. Substituting this result:

$$\frac{\delta \text{Error}}{\delta O_i} = -\text{delta}_j * w_{ij}$$

Now we sum over all the connections of node i to the output layer:

$$\frac{\delta \text{Error}}{\delta O_i} = \sum_j -\text{delta}_j * w_{ij}$$

This gives us the sensitivity of network error to the output of node i on the hidden layer. We next determine the value of delta_i , the sensitivity of network error to the net activation at hidden node i . This gives the sensitivity of network error to the incoming weights of node i . Using the chain rule again:

$$-\text{delta}_i = \frac{\delta \text{Error}}{\delta \text{net}_i} = \frac{\delta \text{Error}}{\delta O_i} * \frac{\delta O_i}{\delta \text{net}_i}$$

Since we are using the logistic activation function,

$$\frac{\delta O_i}{\delta \text{net}_i} = O_i * (1 - O_i)$$

We now substitute this value in the equation for delta_i to get:

$$-\text{delta}_i = O_i * (1 - O_i) * \sum_j -\text{delta}_j * w_{ij}$$

Finally, we can evaluate the sensitivity of the network error on the output layer to the incoming weights on hidden node i . We examine the k th weight on node i , w_k . By the

chain rule:

$$\frac{\delta \text{Error}}{\delta w_{ki}} = \frac{\delta \text{Error}}{\delta \text{net}_i} * \frac{\delta \text{net}_i}{\delta w_{ki}} = -\text{delta}_i * \frac{\delta \text{net}_i}{\delta w_{ki}} = -\text{delta}_i * x_k$$

where x_k is the k th input to node i .

We substitute into the equation the value of $-\text{delta}_i$:

$$\frac{\delta \text{Error}}{\delta w_{ki}} = O_i(1 - O_i) \sum_j (-\text{delta}_j * w_{ij}) x_k$$

Since the minimization of the error requires that the weight changes be in the direction of the negative gradient component, we get the weight adjustment for the k th weight of i by multiplying by the negative of the learning constant:

$$\Delta w_{ki} = -c \frac{\delta \text{Error}}{\delta w_{ki}} = -c * O_i(1 - O_i) \sum_j (-\text{delta}_j * w_{ij}) x_k$$

For networks with more than one hidden layer, the same procedure is applied recursively to propagate the error from hidden layer n to hidden layer $n - 1$.

Although it provides a solution to the problem of learning in multilayer networks, backpropagation is not without its own difficulties. As with hillclimbing, it may converge to local minima, as in Figure 14.8. Finally, backpropagation can be expensive to compute, especially when the network converges slowly.

14.3.2 Backpropagation Example 1: NETtalk

NETtalk is an interesting example of a neural net solution to a difficult learning problem (Sejnowski and Rosenberg 1987). NETtalk learned to pronounce English text. This is a difficult task for an explicit symbol-based approach, since English pronunciation is highly irregular. Although rule-based programs have been written for this task, they are complex and do not perform perfectly.

NETtalk learned to read a string of text and return a phoneme and an associated stress for each letter in the string. A phoneme is the basic unit of sound in a language; the stress is the relative loudness of that sound. Because the pronunciation of a single letter depends upon the letters around it, NETtalk was given a seven character window. As the text moves through this window, NETtalk returns a phoneme/stress pair for each letter.

Figure 14.11 shows the architecture of NETtalk. The network consists of three layers of units. The input units correspond to the seven character window on the text. Each position in the window is represented by 29 input units, one for each letter of the alphabet, and 3 for punctuation and spaces. The letter in each position activates the corresponding unit. The output units encode phonemes using 21 different features of human articulation. The remaining five units encoded stress and syllable boundaries. NETtalk has 80 hidden units, 26 output values, and 18,629 connections.

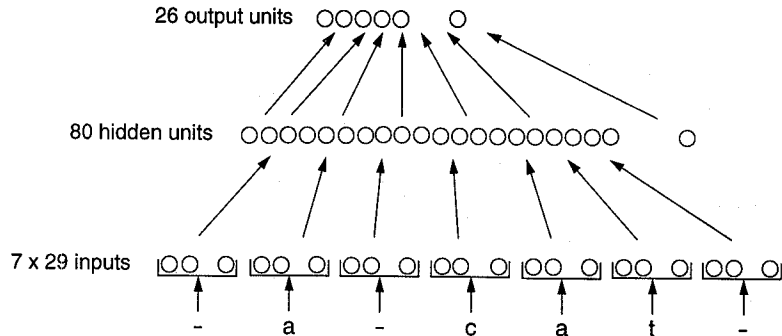

Figure 14.11 The network topology of NETtalk.

NETtalk is trained by giving it a seven character window and letting it attempt to pronounce the middle character. Comparing its attempted pronunciation to the correct pronunciation, it adjusts its weights using backpropagation.

The program illustrates a number of interesting properties of neural networks, many of which reflect the nature of human learning. For example, learning, when measured as a percentage of correct responses, proceeds rapidly at first, and slows as the percentage correct increases. As with humans, the more words the network learns to pronounce, the better it is at correctly pronouncing new words. Experiments in which some of the weights in a fully trained network were randomly altered showed the network to be damage resistant, degrading gracefully as weights were altered. Researchers also found that relearning in a damaged network was highly efficient.

Another interesting aspect of multilayered networks is the role of the hidden layers. Any learning algorithm must learn generalizations that apply to unseen instances in the problem domain. The hidden layers play an important role in allowing a neural network to generalize. NETtalk, like many backpropagation networks, has fewer neurons in the hidden layer than in the input layer. This means that since fewer nodes on the hidden layer are used to encode the information in the training patterns, some form of abstraction is taking place. The shorter encoding implies that different patterns on the input layer can be mapped into identical patterns at the hidden layer. This reduction is a generalization.

NETtalk learns effectively, although it requires a large number of training instances, as well as repeated passes through the training data. In a series of empirical tests comparing backpropagation and ID3 on this problem, Shavlik et al. (1991) found that the algorithms performed comparably. This research evaluated the algorithms by dividing the total set of examples into separate training sets and test sets. Both ID3 (Section 10.3) and NETtalk were able to correctly pronounce about 60% of the test data after training on 500 examples. However, where ID3 required only a single pass through the training data, NETtalk required many repetitions of the training set. In this research, NETtalk was allowed 100 passes through the training data.

As our example demonstrates, the relationship between connectionist and symbolic learning is more complicated than it might seem at first. In our next example we work through the details of a backpropagation solution to the exclusive-or problem.

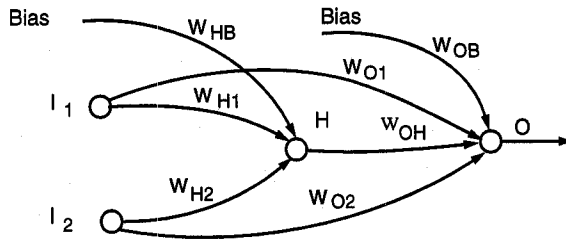

Figure 14.12 A backpropagation net to solve the exclusive-or problem. The W_{ij} are the weights and H is the hidden node.

14.3.3 Backpropagation Example 2: Exclusive-or

We end this section by presenting a simple hidden layer solution to the *exclusive-or* problem. Figure 14.12 shows a network with two input nodes, one hidden node and one output node. The network also has two bias nodes, the first to the hidden node and the second to the output node. The net values for the hidden and output nodes are calculated in the usual manner, as the vector product of the input values times their trained weights. The bias is added to this sum. The weights are trained by backpropagation and the activation function is sigmoidal.

It should be noted that the input nodes are also directly linked, with trained weights, to the output node. This additional linking can often let the designer get a network with fewer nodes on the hidden layer and quicker convergence. In fact there is nothing unique about the network of Figure 14.12; any number of different networks could be used to compute exclusive-or.

We trained our randomly initialized network with multiple instances of the four patterns that represent the truth values of exclusive-or:

$$(0, 0) \rightarrow 0; (1, 0) \rightarrow 1; (0, 1) \rightarrow 1; (1, 1) \rightarrow 0$$

A total of 1400 training cycles using these four instances produced the following values, rounded to the nearest tenth, for the weight parameters of Figure 14.12:

$$\begin{array}{llll} W_{H1} = -7.0 & W_{HB} = 2.6 & W_{O1} = -5.0 & W_{OH} = -11.0 \\ W_{H2} = -7.0 & W_{OB} = 7.0 & W_{O2} = -4.0 & \end{array}$$

With input values (0, 0), the output of the hidden node is:

$$f(0*(-7.0) + 0*(-7.0) + 1*2.6) = f(2.6) \rightarrow 1$$

The output of the output node for (0,0) is:

$$f(0*(-5.0) + 0*(-4.0) + 1*(-11.0) + 1*(7.0)) = f(-4.0) \rightarrow 0$$

With input values (1, 0), the output of the hidden node is:

$$f(1*(-7.0) + 0*(-7.0) + 1*2.6) = f(-4.4) \rightarrow 0$$

The output of the output node for (1,0) is:

$$f(1*(-5.0) + 0*(-4.0) + 0*(-11.0) + 1*(7.0)) = f(2.0) \rightarrow 1$$

The input value of (0, 1) is similar. Finally, let us check our exclusive-or network with input values of (1, 1). The output of the hidden node is:

$$f(1*(-7.0) + 1*(-7.0) + 1*2.6) = f(-11.4) \rightarrow 0$$

The output of the output node for (1,1) is:

$$f(1*(-5.0) + 1*(-4.0) + 0*(-11.0) + 1*(7.0)) = f(-2.0) \rightarrow 0$$

The reader can see that the backpropagation network made a nonlinear separation of these data points. The threshold function f is the sigmoidal of Figure 14.7b, the learned biases have translated it slightly in the positive direction.

We next consider models of competitive learning.

14.4 Competitive Learning

14.4.1 Winner-Take-All Learning for Classification

The winner-take-all algorithm (Kohonen 1984, Hecht-Nielsen 1987) works with the single node in a layer of nodes that responds most strongly to the input pattern. Winner-take-all may be viewed as a competition among a set of network nodes, as in Figure 14.13. In this figure we have a vector of input values, $X=(x_1, x_2, \dots, x_m)$, passed into a layer of network nodes, A, B, ..., N. The diagram shows node B the winner of the competition, with an output signal of 1.

Learning for winner-take-all is unsupervised in that the winner is determined by a "maximum activation" test. The weight vector of the winner is then rewarded by bringing its components closer to those of the input vector. For the weights, W , of the winning node and components X of the input vector, the increment is:

$$\Delta W^t = c(X^t - W^t),$$

where c is a small positive learning constant that usually decreases as the learning proceeds. The winning weight vector is then adjusted by adding ΔW^t .

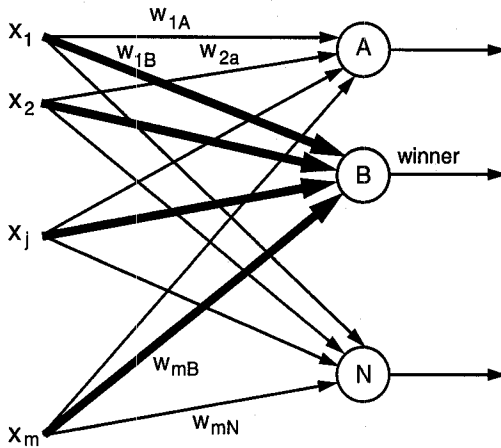

Figure 14.13 A layer of nodes for application of a winner-take-all algorithm. The old input vectors support the winning node.

This reward increments or decrements each component of the winner's weight vector by a fraction of the $x_i - w_i$ difference. The effect is, of course, to make the winning node match more closely the input vector. The winner-take-all algorithm does not need to directly compute activation levels to find the node with the strongest response. The activation level of a node is directly related to the closeness of its weight vector to the input vector. For a node i with a normalized weight vector W_i , the activation level, $W_i X$, is a function of the Euclidean distance between W_i and the input pattern X . This can be seen by calculating the Euclidean distance, with normalized W_i :

$$\|X - W_i\| = \sqrt{(X - W_i)^2} = \sqrt{X^2 - 2XW_i - 1}$$

From this equation it can be seen that for a set of normalized weight vectors, the weight vector with the smallest Euclidean distance, $\|X - W\|$, will be the weight vector with the maximum activation value, WX . In many cases it is more efficient to determine the winner by calculating Euclidean distances rather than comparing activation levels on normalized weight vectors.

We consider the "winner-take-all" Kohonen learning rule for several reasons. First, we consider it as a classification method and compare it to perceptron classification. Second, it may be combined with other network architectures to offer more sophisticated models of learning. We look at the combination of Kohonen prototype learning with an outstar, supervised learning network. This hybrid, first proposed by Robert Hecht-Nielsen (1987, 1990), is called a *counterpropagation* network. We see, in Section 14.4.3, how we can describe conditioned learning using counterpropagation.

Before we leave this introduction, there are a number of issues important for "winner-take-all" algorithms. Sometimes a "conscience" parameter is set and updated at each iteration to keep individual nodes from winning too often. This ensures that all network nodes

eventually participate in representing the pattern space. In some algorithms, rather than identifying a winner that takes all, a *set* of closest nodes are selected and the weights of each are differentially incremented. Another approach is to differentially reward the neighboring nodes of the winner. Weights are typically initialized at random values and then normalized during this learning method (Zurada 1992). Hecht-Nielsen (1990) shows how “winner-take-all” algorithms may be seen as equivalent to the k-means analysis of a set of data. In the next section we present Kohonen’s winner-take-all unsupervised method for the learning of clusters.

14.4.2 A Kohonen Network for Learning Prototypes

Classification of data and the role of prototypes in learning are constant concerns of psychologists, linguists, computer scientists, and cognitive scientists (Wittgenstein 1953, Rosch 1978, Lakoff 1987). The role of prototypes and classification in intelligence is also a constant theme of this book. We demonstrated symbol based-classification and probabilistic clustering algorithms with COBWEB and CLUSTER/2 in Section 13.5. In connectionist models, we demonstrated perceptron-based classification in Section 14.2 and now show a Kohonen (1984) winner-take-all clustering algorithm.

Figure 14.14 presents again the data points of Table 14.3. Superimposed on these points are a series of prototypes created during network training. The perceptron training algorithm converged after a number of iterations, resulting in a network weight configuration defining a linear separation between the two classes. As we saw, the line defined by these weights was obtained by implicitly computing the Euclidean “center” of each cluster. This center of a cluster serves in perceptron classification as a prototype of the class.

Kohonen learning, on the other hand, is unsupervised, with a set of prototypes randomly created and then refined until they come to explicitly represent the clusters of data. As the algorithm continues, the learning constant is progressively reduced so that each new input vector will cause less perturbation in the prototypes.

Kohonen learning, like CLUSTER/2, has a strong inductive bias in that the number of desired prototypes is explicitly identified at the beginning of the algorithm and then continuously refined. This allows the net algorithm designer to identify a specific number of prototypes to represent the clusters of data. Counterpropagation (Section 14.4.3) allows further manipulation of this selected number of prototypes.

Figure 14.15 is a Kohonen learning network for classification of the data of Table 14.3. The data are represented in Cartesian two dimensional space, so prototypes to represent the data clusters will also be ordered pairs. We select two prototypes, one to represent each data cluster. We have randomly initialized node A to (7, 2) and node B to (2, 9). Random initialization only works in simple problems such as ours; an alternative is to set the weight vectors equal to representatives of each of the clusters.

The winning node will have a weight vector closest to that of the input vector. This weight vector for the winning node will be rewarded by being moved even closer to the input data, while the weights on the losing nodes are left unchanged. Since we are explicitly calculating the Euclidean distance of the input vector from each of the prototypes we will not need to normalize the vectors, as described in Section 14.4.1.

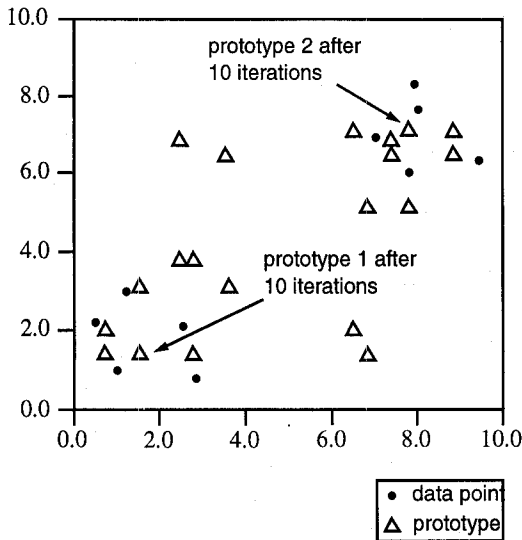

Figure 14.14 The use of a Kohonen layer, unsupervised, to generate a sequence of prototypes to represent the classes of Table 14.3.

Kohonen learning is unsupervised, in that a simple measure of the distance between each prototype and the data point allows selection of the winner. Classification will be “discovered” in the context of this *self-organizing* network. Although Kohonen learning selects data points for analysis in random order, we take the points of Table 14.3 in top to bottom order. For point (1, 1), we measure the distance from each prototype:

$$\begin{aligned} \|(1, 1) - (7, 2)\| &= (1 - 7)^2 + (1 - 2)^2 = 37, \text{ and} \\ \|(1, 1) - (2, 9)\| &= (1 - 2)^2 + (1 - 9)^2 = 65. \end{aligned}$$

Node A (7, 2) is the winner since it is closest to (1, 1). $\|(1, 1) - (7, 2)\|$ represents the distance between these two points; we do not need to apply the square root function in the Euclidean distance measure because the relation of magnitudes is invariant. We now reward the winning node, using the learning constant c set to 0.5. For the second iteration:

$$\begin{aligned} W^2 &= W^1 + c(X^1 - W^1) \\ &= (7, 2) + .5((1, 1) - (7, 2)) = (7, 2) + .5((1 - 7), (1 - 2)) \\ &= (7, 2) + (-3, -.5) = (4, 1.5) \end{aligned}$$

At the second iteration of the learning algorithm we have, for data point (9.4, 6.4):

$$\begin{aligned} \|(9.4, 6.4) - (4, 1.5)\| &= (9.4 - 4)^2 + (6.4 - 1.5)^2 = 53.17 \text{ and} \\ \|(9.4, 6.4) - (2, 9)\| &= (9.4 - 2)^2 + (6.4 - 9)^2 = 60.15 \end{aligned}$$

Again, node A is the winner. The weight for the third iteration is:

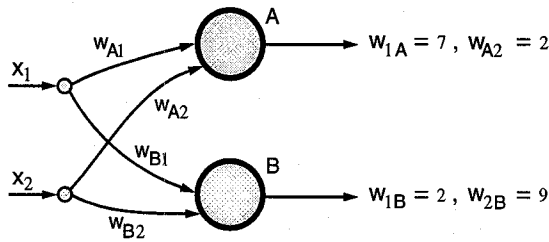

Figure 14.15 The architecture of the Kohonen based learning network for the data of Table 14.3 and classification of Figure 14.14.

$$\begin{aligned}
 W^3 &= W^2 + c(X^2 - W^2) \\
 &= (4, 1.5) + .5((9.4, 6.4) - (4, 1.5)) \\
 &= (4, 1.5) + (2.7, 2.5) = (6.7, 4)
 \end{aligned}$$

At the third iteration we have, for data point (2.5, 2.1):

$$\begin{aligned}
 \|(2.5, 2.1) - (6.7, 4)\| &= (2.5 - 6.7)^2 + (2.1 - 4)^2 = 21.25, \text{ and} \\
 \|(2.5, 2.1) - (2, 9)\| &= (2.5 - 2)^2 + (2.1 - 9)^2 = 47.86.
 \end{aligned}$$

Node A wins again and we go on to calculate its new weight vector. Figure 14.14 shows the evolution of the prototype after 10 iterations. The algorithm used to generate the data of Figure 14.14 selected data randomly from Table 14.3, so the prototypes shown will differ from those just created. The progressive improvement of the prototypes can be seen moving toward the centers of the data clusters. Again, this is an unsupervised, winner-take-all reinforcement algorithm. It builds a set of evolving and explicit prototypes to represent the data clusters. A number of researchers, including Zurada (1992) and Hecht-Nielsen (1990), point out that Kohonen unsupervised classification of data is basically the same as k-means analysis.

We next consider, with a Grossberg, or outstar, extension of Kohonen winner-take-all analysis, an algorithm that will let us extend the power of prototype selection.

14.4.3 Grossberg Learning and Counterpropagation

To this point we considered the unsupervised clustering of input data. Learning here requires little *a priori* knowledge of a problem domain. Gradually detected characteristics of the data, as well as the training history, lead to the identification of classes and the discovery of boundaries between them. Once data points are clustered according to similarities in their vector representations, a teacher can assist in calibrating or giving names to data classes. This is done by a form of supervised training, where we take the output nodes of a "winner-take-all" network layer and use them as input to a second network layer. We will then explicitly reinforce decisions at this output layer.

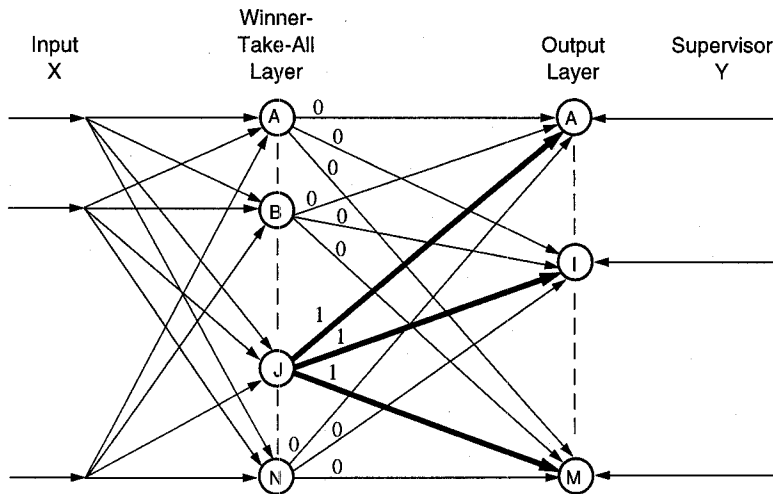

Figure 14.16 The “outstar” of node J, the “winner” in a winner-take-all network. The Y vector supervises the response on the output layer in Grossberg training. The “outstar” is bold with all weights 1; all other weights are 0.

This supervised training and then reinforced output allows us, for example, to map the results of a Kohonen net into an output pattern or class. A Grossberg (1982, 1988) layer, implementing an algorithm called *outstar*, allows us to do this. The combined network, a Kohonen layer joined to a Grossberg layer, is called *counterpropagation* and was first proposed by Robert Hecht-Nielsen (1987, 1990).

In Section 14.4.2 we considered in some detail the Kohonen layer; here we consider the Grossberg layer. Figure 14.16 shows a layer of nodes, A, B, ..., N, where one node, J, is selected as the winner. Grossberg learning is supervised in that we wish, with feedback from a teacher, represented by vector Y, to reinforce the weight connecting J to the node I in the output layer which is supposed to fire. With outstar learning, we identify and increase the weight w_{JI} on the outbound link of J to I.

To train the counterpropagation net we first train the Kohonen layer. When a winner is found, the values on all the links going out from it will be 1, while all the output values of its competitors remain 0. That node, together with all the nodes on the output layer to which it is connected, form what is called an *outstar* (see Figure 14.16). Training for the Grossberg layer is based on outstar components.

If each cluster of input vectors represents a single class and we want all members of a class to map onto the same value at the output layer, we do not need an iterative training. We need only determine which node in the winner-take-all layer is linked to which class and then assign weights from those nodes to output nodes based on the association between classes and desired output values. For example, if the Jth winner-take-all unit wins for all elements of the cluster for which I = 1 is the desired output of the network, we set $w_{JI} = 1$ and $w_{JK} = 0$ for all other weights on the outstar of J.

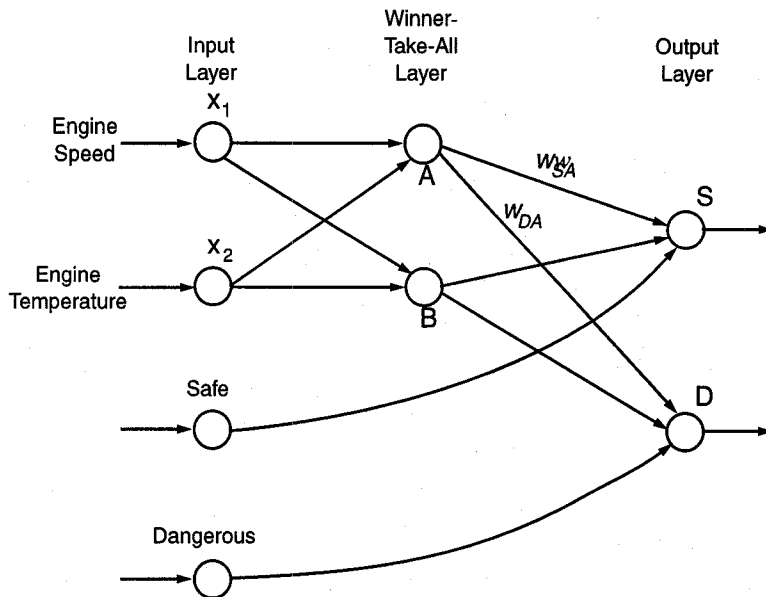

Figure 14.17 A counterpropagation network to recognize the classes in Table 14.3. We train the outstar weights of node A, w_{SA} and w_{DA} .

If the desired output for elements of a cluster vary, then there is an iterative procedure, using the supervision vector Y , for adjusting outstar weights. The result of this training procedure is to *average* the desired output values for elements of a particular cluster. We train the weights on the outstar connections from the winning node to the output nodes according to the equation:

$$W^{t+1} = W^t + c(Y - W^t)$$

where c is a small positive learning constant, W^t is the weight vector of the outstar component, and Y is the desired output vector. Note that this learning algorithm has the effect of increasing the connection between node J on the Kohonen layer and node l on the output layer precisely when l is a winning node with an output of 1 and the desired output of J is also 1. This makes it an instance of Hebbian learning, a form of learning in which a neural pathway is strengthened every time one node contributes to the firing of another. We discuss Hebbian learning in more detail in Section 14.5.

We next apply the rule for training a counterpropagation network to recognize the data clusters of Table 14.3. We also show with this example how counterpropagation nets implement conditioned learning. Suppose the x_1 parameter in Table 14.3 represents engine speed in a propulsion system. x_2 represents engine temperature. Both the speed and the temperature of the system are calibrated to produce data points in the range $[0, 10]$. Our monitoring system samples data points at regular intervals. Whenever speed and temperature are excessively high, we want to broadcast a warning. Let us rename the output values

of Table 14.3 from +1 to “safe” and from -1 to “dangerous.” Our counterpropagation network will look like Figure 14.17.

Since we know exactly what values we want each winning node of the Kohonen net to map to on the output layer of the Grossberg net, we could directly set those values. To demonstrate outstar learning, however, we will train the net using the formula just given. If we make the (arbitrary) decision that node S on the output layer should signal safe situations and node D dangerous, then the outstar weights for node A on the output layer of the Kohonen net should be [1, 0] and the outstar weights for B should be [0, 1]. Because of the symmetry of the situation, we show the training of the outstar for node A only.

The Kohonen net must have stabilized before the Grossberg net can be trained. We demonstrated the Kohonen convergence of this same net in Section 14.4.2. The input vectors for training the A outstar node are of the form $[x_1, x_2, 1, 0]$. x_1 and x_2 are values from Table 14.3 that are clustered at Kohonen output node A and the last two components indicate that when A is the Kohonen winner, safe is “true” and dangerous is “false,” as in Figure 14.15. We initialize the outstar weights of A to [0, 0] and use .2 as the learning constant:

$$\begin{aligned} W^1 &= [0, 0] + .2[[1, 0] - [0, 0]] = [0, 0] + [.2, 0] = [.2, 0] \\ W^2 &= [.2, 0] + .2[[1, 0] - [.2, 0]] = [.2, 0] + [.16, 0] = [.36, 0] \\ W^3 &= [.36, 0] + .2[[1, 0] - [.36, 0]] = [.36, 0] + [.13, 0] = [.49, 0] \\ W^4 &= [.49, 0] + .2[[1, 0] - [.49, 0]] = [.49, 0] + [.10, 0] = [.59, 0] \\ W^5 &= [.59, 0] + .2[[1, 0] - [.59, 0]] = [.59, 0] + [.08, 0] = [.67, 0]. \end{aligned}$$

As we can see, with training these weights are moving toward [1, 0]. Of course, since in this case elements of the cluster associated with A always map into [1,0], we could have used the simple assignment algorithm rather than the averaging algorithm for training.

We now show that this assignment gives the appropriate response from the counterpropagation net. When the first input vector from Table 14.3 is applied to the network in Figure 14.17, we get activation of [1, 1] for the outstar weights of node A and [0, 0] for the outstar of B. The dot product of activation and weights for node S of the output layer is $[1, 0] * [1, 0]$; this gives activation 1 to the S output node. With outstar weights of B trained to [0, 1], the activation for node D is $[1, 0] * [0, 1]$; these are the values that we expect. Testing the second row of data points on Table 14.3, we get activation [0, 0] from the A node and [1,1] from the B at the winner-take-all level. The dot product of these values and the trained weights gives 0 to the S node and 1 to D, again what is expected. The reader may continue to test other data from Table 14.3.

From a cognitive perspective, we can give an associationist interpretation to the counterpropagation net. Consider again Figure 14.17. The learning on the Kohonen layer can be seen as acquiring a conditioned stimulus, since the network is learning patterns in events. The learning on the Grossberg level, on the other hand, is an association of nodes (unconditioned stimuli) to some response. In our situation the system learns to broadcast a danger warning when data fit into a certain pattern. Once the appropriate response is learned, then even without the continued coaching of a teacher, the system responds appropriately to new data.

A second cognitive interpretation of counterpropagation is in terms of the reinforce-

ment of memory links for pattern of phenomena. This is similar to building a lookup table for responses to data patterns.

Counterpropagation has, in certain cases, a considerable advantage over backpropagation. Like backpropagation it is capable of learning nonlinearly separable classifications. It does this, however, by virtue of the preprocessing which goes on in the Kohonen layer, where the data set is partitioned into clusters of homogenous data. This partitioning can result in a significant advantage over backpropagation in learning rate since the explicit partitioning of data into separate clusters replaces the often extensive search required on the hidden layers in backpropagation networks.

14.5 Hebbian Coincidence Learning

14.5.1 Introduction

Hebb's theory of learning is based on the observation that in biological systems when one neuron contributes to the firing of another neuron, the connection or pathway between the two neurons is strengthened. Hebb (1949) stated:

When an axon of cell A is near enough to excite a cell B and repeatedly or persistently takes place in firing it, some growth process or metabolic change takes place in one or both cells such that A's efficiency, as one of the cells firing B, is increased.

Hebbian learning is appealing because it establishes behavior-based reward concepts on the neuronal level. Neural physiological research has confirmed that Hebb's idea is at least approximately correct. There are other mechanisms modifying cells at the neuron level, including chemical metabolism, cell attrition, and the production of new cells. Nonetheless in response to Hebb's pioneering contributions to neuroscience, the particular learning law presented in this section is now referred to as Hebbian learning. This learning belongs to the *coincidence* category of learning laws which cause weight changes in response to localized events in neural processing. We describe the learning laws of this category by their local time and space properties.

Hebbian learning has been used in a number of network architectures. It is used in both supervised and unsupervised learning modes. The effect of strengthening the connection between two neurons, when one contributes to the firing of another, may be simulated mathematically by adjusting the weight on their connection by a constant times the sign of the product of their output values.

Let's see how this works. Suppose neurons i and j are connected so that the output of i is an input of j . We can define the weight adjustment on the connection between them, ΔW , as the sign of $c * (O_i * O_j)$, where c is a constant controlling the learning rate. In Table 14.4, O_i is the sign of the output value of i and O_j of the output of j . From the first line of the table we see that when O_i and O_j are both positive, the weight adjustment, ΔW , is positive. This has the effect of strengthening the connection between i and j when i has contributed to j 's "firing."

O_i	O_j	$O_i * O_j$
+	+	+
+	-	-
-	+	-
-	-	+

Table 14.4 The signs and product of signs of node output values.

In the second and third rows of Table 14.4, i and j have opposite signs. Since their signs differ, we want to inhibit i 's contribution to j 's output value. Therefore we adjust the weight of the connection by a negative increment. Finally, in the fourth row, i and j again have the same sign. This means that we increase the strength of their connection. This weight adjustment mechanism has the effect of reinforcing the path between neurons when they have similar signals and inhibiting them otherwise.

In the next sections we consider two types of Hebbian learning, unsupervised and supervised. We begin by examining an unsupervised form.

14.5.2 An Example of Unsupervised Hebbian Learning

Recall that in unsupervised learning a critic is not available to provide the "correct" output value; thus the weights are modified solely as a function of the input and output values of the neuron. The training of this network has the effect of strengthening the network's responses to patterns that it has already seen. In the next example, we show how Hebbian techniques can be used to model conditioned response learning, where an arbitrarily selected stimulus can be used as a condition for a desired response.

Weight can be adjusted, ΔW , for a node i in unsupervised Hebbian learning with:

$$\Delta W = c * f(X, W) * X$$

where c is the learning constant, a small positive number, $f(X, W)$ is i 's output, and X is the input vector to i .

We now show how a network can use Hebbian learning to transfer its response from a primary or unconditioned stimulus to a conditioned stimulus. This allows us to model the type of learning studied in Pavlov's experiments, where by simultaneously ringing a bell every time food was presented, a dog's salivation response to food was transferred to the bell. The network of Figure 14.18 has two layers, an input layer with six nodes and an output layer with one node. The output layer returns either +1, signifying that the output neuron has fired, or a -1, signifying that it is quiescent.

We let the learning constant be the small positive real number 0.2. In this example we train the network on the pattern [1, -1, 1, -1, 1 -1] which is the concatenation of the two patterns, [1, -1, 1] and [-1, 1, -1]. The pattern [1, -1, 1] represents the unconditioned stimulus and [-1, 1, -1] represents the new stimulus.

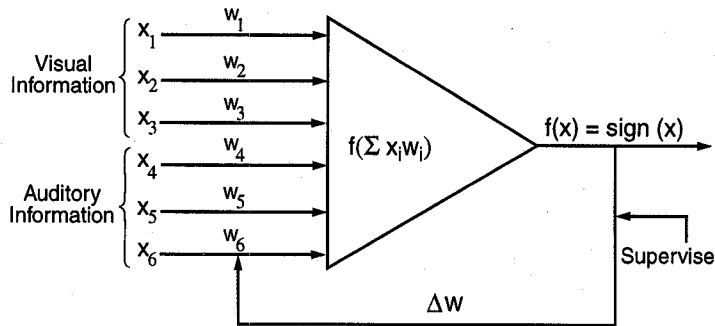

Figure 14.18 An example neuron for application of a Hebbian learning node. Learning is supervised.

We assume that the network already responds positively to the unconditioned stimulus but is neutral with respect to the new stimulus. We simulate the positive response of the network to the unconditioned stimulus with the weight vector [1, -1, 1], exactly matching the input pattern, while the neutral response of the network to the new stimulus is simulated by the weight vector [0, 0, 0]. The concatenation of these two weight vectors gives us the initial weight vector for the network, [1, -1, 1, 0, 0, 0].

We now train the network on the input pattern, hoping to induce a configuration of weights which will produce a positive network response to the new stimulus. The first iteration of the network gives:

$$\begin{aligned}
 W * X &= (1 * 1) + (-1 * -1) + (1 * 1) + (0 * -1) + (0 * 1) + (0 * -1) \\
 &= (1) + (1) + (1) = 3 \\
 f(3) &= \text{sign}(3) = 1.
 \end{aligned}$$

We now create the new weight W^2 :

$$\begin{aligned}
 W^2 &= [1, -1, 1, 0, 0, 0] + .2 * (1) * [1, -1, 1, -1, 1, -1] \\
 &= [1, -1, 1, 0, 0, 0] + [.2, -.2, .2, -.2, .2, -.2] \\
 &= [1.2, -1.2, 1.2, -.2, .2, -.2]
 \end{aligned}$$

We expose the adjusted network to the original input pattern:

$$\begin{aligned}
 W * X &= (1.2 * 1) + (-1.2 * -1) + (1.2 * 1) + (-.2 * -1) + (.2 * 1) + (-.2 * -1) \\
 &= (1.2) + (.1.2) + (1.2) + (.2) + (.2) + (.2) = 4.2 \text{ and} \\
 \text{sign}(4.2) &= 1.
 \end{aligned}$$

We now create the new weight W^3 :

$$\begin{aligned}
 W^3 &= [1.2, -1.2, 1.2, -.2, .2, -.2] + .2 * (1) * [1, -1, 1, -1, 1, -1] \\
 &= [1.2, -1.2, 1.2, -.2, .2, -.2] + [.2, -.2, .2, -.2, .2, -.2] \\
 &= [1.4, -1.4, 1.4, -.4, .4, -.4]
 \end{aligned}$$

It can now be seen that the vector product, $W * X$, will continue to grow in the positive direction, with the absolute value of each element of the weight vector increasing by .2 at each training cycle. After 10 more iterations of the Hebbian training the weight vector will be:

$$W^{13} = [3.4, -3.4, 3.4, -2.4, 2.4, -2.4].$$

We now use this trained weight vector to test the network's response to the two partial patterns. We would like to see if the network continues to respond to the unconditioned stimulus positively and, more importantly, if the network has now acquired a positive response to the new, conditioned stimulus. We test the network first on the unconditioned stimulus [1, -1, 1]. We fill out the last three arguments of the input vector with random 1, and -1 assignments. For example, we test the network on the vector [1, -1, 1, 1, 1, -1]:

$$\begin{aligned} \text{sign}(W*X) &= \text{sign}((3.4*1) + (-3.4*-1) + (3.4*1) \\ &\quad + (-2.4*1) + (2.4*1) + (-2.4*-1)) \\ &= \text{sign}(3.4 + 3.4 + 3.4 - 2.4 + 2.4 + 2.4) \\ &= \text{sign}(12.6) = +1. \end{aligned}$$

The network thus still responds positively to the original unconditioned stimulus. We now do a second test using the original unconditioned stimulus and a different random vector in the last three positions: [1, -1, 1, 1, -1, -1]:

$$\begin{aligned} \text{sign}(W*X) &= \text{sign}((3.4*1) + (-3.4*-1) + (3.4*1) \\ &\quad + (-2.4*1) + (2.4*-1) + (-2.4*-1)) \\ &= \text{sign}(3.4 + 3.4 + 3.4 - 2.4 - 2.4 + 2.4) \\ &= \text{sign}(7.8) = +1. \end{aligned}$$

The second vector also produces a positive network response. In fact we note in these two examples that the network's sensitivity to the original stimulus, as measured by its raw activation, has been strengthened, due to repeated exposure to that stimulus.

We now test the network's response to the new stimulus pattern, [-1, 1, -1], encoded in the last three positions of the input vector. We fill the first three vector positions with random assignments from the set {1,-1} and test the network on the vector [1, 1, 1, -1, 1, -1]:

$$\begin{aligned} \text{sign}(W*X) &= \text{sign}((3.4*1) + (-3.4*-1) + (3.4*1) \\ &\quad + (-2.4*1) + (2.4*1) + (-2.4*-1)) \\ &= \text{sign}(3.4 - 3.4 + 3.4 + 2.4 + 2.4 + 2.4) \\ &= \text{sign}(10.6) = +1. \end{aligned}$$

The pattern of the secondary stimulus is also recognized!

We do one final experiment, with the vector patterns slightly degraded. This could represent the stimulus situation where the input signals are slightly altered, perhaps

because a new food and a different sounding bell are used. We test the network on the input vector [1, -1, -1, 1, 1, -1], where the first three parameters are one off the original unconditioned stimulus and the last three parameters are one off the conditioned stimulus:

$$\begin{aligned} \text{sign}(W \cdot X) &= \text{sign}((3.4 \cdot 1) + (-3.4 \cdot -1) + (3.4 \cdot 1) \\ &\quad + (-2.4 \cdot 1) + (2.4 \cdot 1) + (-2.4 \cdot -1)) \\ &= \text{sign}(3.4 + 3.4 - 3.4 - 2.4 + 2.4 + 2.4) \\ &= \text{sign}(5.8) = +1. \end{aligned}$$

Even the partially degraded stimulus is recognized!

What has the Hebbian learning model produced? We created an association between a new stimulus and an old response by repeatedly presenting the old and new stimulus together. The network learns to transfer its response to the new stimulus without any supervision. This strengthened sensitivity also allows the network to respond in the same way to a slightly degraded version of the stimuli. This was achieved by using Hebbian coincidence learning to increase the strength of the network's response to the total pattern, an increase which has the effect of increasing the strength of the network's response to each individual component of the pattern.

14.5.3 Supervised Hebbian Learning

The Hebbian learning rule is based on the principle that the strength of the connection between neurons is increased whenever one neuron contributes to the firing of another. This principle can be adapted to a supervised learning situation by basing the weight adjustment for this connection on the desired output of the neuron rather than the actual output. For example, if the input of neuron A to neuron B is positive, and the *desired* response of neuron B is a positive output, then the weight on the connection from A to B is increased.

We examine an application of supervised Hebbian learning showing how a network can be trained to recognize a set of associations between patterns. The associations are given by a set of ordered pairs, $\{ \langle X_1, Y_1 \rangle, \langle X_2, Y_2 \rangle, \dots, \langle X_t, Y_t \rangle \}$, where X_i and Y_i are the vector patterns to be associated. Suppose that the length of the X_i is n and the Y_i is m . Therefore, the network we use has two layers, an input layer of size n and an output layer of size m , as in Figure 14.19.

The learning formula for this network can be derived by starting with the Hebbian learning formula from the previous section:

$$\Delta W = c * f(X, W) * X$$

where $f(X, W)$ is the actual output of the network node. In supervised learning, we replace this actual output of a node with the desired output vector D , giving us the formula:

$$\Delta W = c * D * X$$

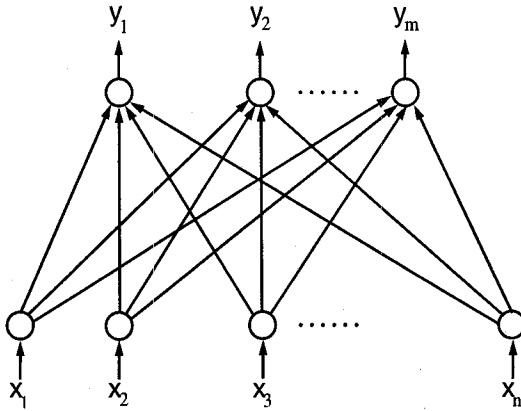

Figure 14.19 A supervised Hebbian network for learning pattern association.

Given a vector pair, $\langle X, Y \rangle$ from the set of associated pairs, we apply this learning rule to the k th node in the output layer:

$$\Delta W_{ik} = c * d_k * x_i,$$

where ΔW_{ik} is the weight adjustment on the i th input to the k th node in the output layer, d_k is the desired output of the k th node, and x_i is the i th element of X . We apply this formula to adjust all the weights on all the nodes in the output layer. The vector $\langle x_1, x_2, \dots, x_n \rangle$ is just the input vector X and the vector $\langle d_1, d_2, \dots, d_m \rangle$ is the output vector Y . Applying the formula for individual weight adjustments across the entire output layer and collecting terms, we can write the formula for the weight adjustment on the output layer as:

$$\Delta W = c * Y * X,$$

where the vector product $Y * X$ is the *outer vector product*. We explain how to compute outer products in the next section.

To train the network on the entire set of associated pairs, we cycle through these pairs, adjusting the weight for each pair $\langle X_i, Y_i \rangle$ according to the formula:

$$W^{t+1} = W^t + c * Y_i * X_i.$$

For the entire training set we get:

$$W^1 = W^0 + c (Y_1 * X_1 + Y_2 * X_2 + \dots + Y_t * X_t),$$

where W^0 is the initial weight configuration. If we initialize W^0 to the 0 vector, $\langle 0, 0, \dots, 0 \rangle$, and set the learning constant c to 1, we get the following formula for assigning network weights:

$$W = Y_1 * X_1 + Y_2 * X_2 + \dots + Y_t * X_t.$$

$$y'_1 = w_{11} x_{11} + w_{12} x_{12} + \dots + w_{1n} x_{1n}$$

$$y'_2 = w_{21} x_{21} + w_{22} x_{22} + \dots + w_{2n} x_{2n}$$

$$y'_m = w_{m1} x_{m1} + w_{m2} x_{m2} + \dots + w_{mn} x_{mn}$$

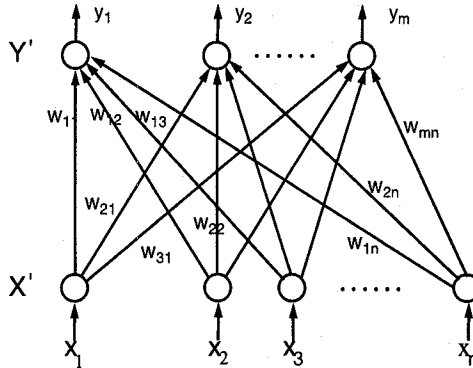

Figure 14.20 The linear association network. The vector X_i is entered as input and the associated vector Y' is produced as output. y'_i is a linear combination of the x input. In training each y'_i is supplied with its correct output signals.

A network which maps input vectors to output vectors using this formula for weight assignment is called a *linear associator*. We have shown that linear associator networks are based on the Hebbian learning rule. In practice this formula can be applied directly to initialize network weights without explicit training.

We next analyze the properties of the linear associator. This model, as we have just seen, stores multiple associations in a matrix of weight vectors. This raises the possibility of interactions between stored patterns. We analyze the problems created by these interactions in the next sections.

14.5.4 Associative Memory and the Linear Associator

The *linear associator* network was first proposed by Tuevo Kohonen (1972) and James Anderson et al. (1977). In this section we present the linear associator network as a method for storing and recovering patterns from memory. We examine different forms of memory retrieval, including the heteroassociative, autoassociative, and interpolative models. We analyze the linear associator network as an implementation of interpolative memory based on the Hebbian learning model. We end this section by considering problems with interference or crosstalk which arise when encoding multiple patterns in memory.

We begin our examination of memory with some definitions. Patterns and memory values are represented as vectors. There is always an inductive bias in reducing the representation of a problem to a set of feature vectors. The associations which are to be stored in memory are represented as sets of vector pairs, $\{ \langle X_1, Y_1 \rangle, \langle X_2, Y_2 \rangle, \dots, \langle X_t, Y_t \rangle \}$. For each vector pair $\langle X_i, Y_i \rangle$, the X_i pattern is a key for retrieval of the Y_i pattern. There are

three types of associative memories:

1. *Heteroassociative*: This is a mapping from X to Y such that if an arbitrary vector X is closer to the vector X_i than any other exemplar, then the associated vector Y_i is returned.
2. *Autoassociative*: This mapping is the same as the heteroassociative except that $X_i = Y_i$ for all exemplar pairs. Since every pattern X_i is related to itself, this form of memory is primarily used when a partial or degraded stimulus pattern serves to recall the full pattern.
3. *Interpolative*: This is a mapping Φ of X to Y such that when X differs from an exemplar, that is, $X = X_i + \Delta_i$, then the output of the $\Phi(X) = \Phi(X_i + \Delta_i) = Y_i + E$ where $E = \Phi(\Delta_i)$. In an interpolative mapping, if the input vector is one of the exemplars X_i the associated Y_i is retrieved. If it differs from one of the exemplars by the vector Δ then the output vector also differs by the vector difference E , where $E = \Phi(\Delta)$.

The autoassociative and heteroassociative memories are used for retrieval of one of the original exemplars. They constitute memory in the true sense, in that the pattern that is retrieved is a literal copy of the stored pattern. We also may want to construct an output pattern that differs from the patterns stored in memory in some systematic way. This is the function of an interpolative memory.

The linear associator network in Figure 14.20 implements a form of interpolative memory. As shown in Section 14.5.3, it is based on the Hebbian learning model. The network weight initialization is described by the equation derived in Section 14.5.3:

$$W = Y_1 * X_1 + Y_2 * X_2 + \dots + Y_t * X_t.$$

Given this weight assignment, the network will retrieve with an exact match one of the exemplars; otherwise it produces an interpolative mapping.

We next introduce some concepts and notation to help us analyze the behavior of this network. First we want to introduce a metric that allows us to define precisely distance between vectors. All our pattern vectors in the examples are *Hamming* vectors, that is vectors composed of +1 and -1 values only. We use *Hamming distance* to describe the distance between two Hamming vectors. Formally, we define a Hamming space:

$$H^n = \{X = (x_1, x_2, \dots, x_n)\}, \text{ where each } x_i \in \{+1, -1\}.$$

Hamming distance is defined for any two vectors from a Hamming space as:

$$\|X, Y\| = \text{the number of components by which } X \text{ and } Y \text{ differ.}$$

For example, the Hamming distance, in four-dimensional Hamming space, between:

(1, -1, -1, 1) and (1, 1, -1, 1) is 1
 (-1, -1, -1, 1) and (1, 1, 1, -1) is 4
 (1, -1, 1, -1) and (1, -1, 1, -1) is 0.

We need two further definitions. First, the complement of a Hamming vector is that vector with each of its elements changed: +1 to -1 and -1 to +1. For example, the complement of (1, -1, -1, -1) is (-1, 1, 1, 1).

Second, we define the *orthonormality* of vectors. Vectors that are orthonormal are orthogonal, or perpendicular, and of unit length. Two orthonormal vectors, when multiplied together with the *dot product*, have all their cross-product terms go to zero. Thus, in an orthonormal set of vectors, when any two vectors, X_i and X_j , are multiplied the product is 0, unless they are the same vector:

$$X_i X_j = \delta_{ij} \text{ where } \delta_{ij} = 1 \text{ when } i = j \text{ and } 0 \text{ otherwise.}$$

We next demonstrate that the linear associator network defined above has the following two properties, with $\Phi(X)$ representing the mapping function of the network. First, for an input pattern X_i which exactly matches one of the exemplars, the network output, $\Phi(X_i)$, is Y_i , the associated exemplar. Second, for an input pattern X_k , which does not exactly match one of the exemplars, the network output, $\Phi(X_k)$, is Y_k , that is the linear interpolation of X_k . More precisely, if $X_k = X_i + \Delta_i$, where X_i is an exemplar, the network returns:

$$Y_k = Y_i + E, \text{ where } E = \Phi(\Delta_i).$$

We first show that, when the network input X_i is one of the exemplars, the network returns the associated exemplar.

$$\Phi(X_i) = WX_i, \text{ by the definition of the network activation function.}$$

Since $W = Y_1 X_1 + Y_2 X_2 + \dots + Y_i X_i + \dots + Y_n X_n$, we get:

$$\begin{aligned} \Phi(X_i) &= (Y_1 X_1 + Y_2 X_2 + \dots + Y_i X_i + \dots + Y_n X_n) X_i \\ &= Y_1 X_1 X_i + Y_2 X_2 X_i + \dots + Y_i X_i X_i + \dots + Y_n X_n X_i, \text{ by distributivity.} \end{aligned}$$

Since, as defined above, $X_i X_j = \delta_{ij}$:

$$\Phi(X_i) = Y_1 \delta_{1i} + Y_2 \delta_{2i} + \dots + Y_i \delta_{ii} + \dots + Y_n \delta_{ni}.$$

By the orthonormality condition, $\delta_{ij} = 1$ when $i = j$ and 0 otherwise. Thus we get:

$$\Phi(X_i) = Y_1 * 0 + Y_2 * 0 + \dots + Y_i * 1 + \dots + Y_n * 0 = Y_i.$$

It can also be shown that, for X_k not equal to any of the exemplars, the network performs an interpolative mapping. That is, for $X_k = X_i + \Delta_i$, where X_i is an exemplar,

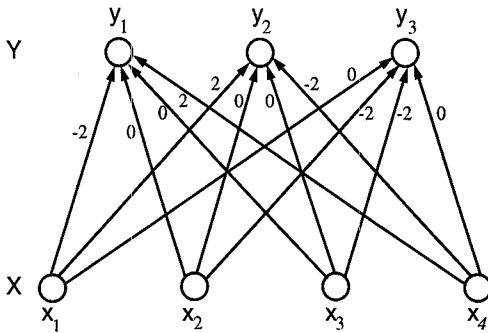

Figure 14.21 A linear associator network for the example in Section 14.5.4. The weight matrix is calculated using the formula presented in the previous section.

$$\begin{aligned} \Phi(X_k) &= \Phi(X_i + \Delta_i) \\ &= Y_i + E, \end{aligned}$$

where Y_i is the vector associated with X_i and

$$E = \Phi(\Delta_i) = (Y_1 X_1 + Y_2 X_2 + \dots + Y_n X_n) \Delta_i.$$

We omit the details of the proof.

We now give an example of linear associator processing. Figure 14.21 presents a simple linear associator network that maps a four-element vector X into a three-element vector Y . Since we are working in a Hamming space, the network activation function f is the *sign* function used earlier.

If we want to store the following two vector associations $\langle X_1, Y_1 \rangle$, $\langle X_2, Y_2 \rangle$ and:

$$\begin{aligned} X_1 &= [1, -1, -1, -1] \leftrightarrow Y_1 = [-1, 1, 1], \\ X_2 &= [-1, -1, -1, 1] \leftrightarrow Y_2 = [1, -1, 1]. \end{aligned}$$

The *outer vector product* YX is defined in general as the matrix:

$$YX = \begin{bmatrix} y_1 \cdot x_1 & y_1 \cdot x_2 & \dots & y_1 \cdot x_m \\ y_2 \cdot x_1 & y_2 \cdot x_2 & \dots & y_2 \cdot x_m \\ \dots & \dots & \dots & \dots \\ y_n \cdot x_1 & y_n \cdot x_2 & \dots & y_n \cdot x_m \end{bmatrix}$$

Using the weight initialization formula for linear associators:

$$W = Y_1 X_1 + Y_2 X_2 + Y_3 X_3 + \dots + Y_N X_N.$$

we calculate $Y_1X_1 + Y_2X_2$, the weight matrix for the network:

$$W = \begin{bmatrix} -1 & 1 & 1 & 1 \\ 1 & -1 & -1 & -1 \\ 1 & -1 & -1 & -1 \end{bmatrix} + \begin{bmatrix} -1 & -1 & -1 & 1 \\ 1 & 1 & 1 & -1 \\ -1 & -1 & -1 & 1 \end{bmatrix} = \begin{bmatrix} -2 & 0 & 0 & 2 \\ 2 & 0 & 0 & -2 \\ 0 & -2 & -2 & 0 \end{bmatrix}$$

We run the linear associator on one of the exemplars. We start with $X = [1, -1, -1, -1]$ from the first exemplar pair to get back the associated Y :

$$y_1 = (-2^*1) + (0^*-1) + (0^*-1) + (2^*-1) = -4, \text{ and } \text{sign}(-4) = -1,$$

$$y_2 = (2^*1) + (0^*-1) + (0^*-1) + (-2^*-1) = 4, \text{ and } \text{sign}(4) = 1, \text{ and}$$

$$y_3 = (0^*1) + (-2^*-1) + (-2^*-1) + (0^*-1) = 4, \text{ and } \text{sign}(4) = 1.$$

Thus $Y_1 = [-1, 1, 1]$, the other half of the exemplar pair, is returned.

We next show an example of linear interpolation of an exemplar. Consider the X vector $[1, -1, 1, -1]$:

$$y_1 = (-2^*1) + (0^*-1) + (0^*1) + (2^*-1) = -4, \text{ and } \text{sign}(-4) = -1,$$

$$y_2 = (2^*1) + (0^*-1) + (0^*1) + (-2^*-1) = 4, \text{ and } \text{sign}(4) = 1, \text{ and}$$

$$y_3 = (0^*1) + (-2^*-1) + (-2^*1) + (0^*-1) = 0, \text{ and } \text{sign}(0) = 1.$$

Notice that $Y = [-1, 1, 1]$ is not one of the original Y exemplars. Notice that the mapping preserves the values which the two Y exemplars have in common. In fact $[1, -1, 1, -1]$, the X vector, has a Hamming distance of 1 from each of the two X exemplars; the output vector $[-1, 1, 1]$ also has a Hamming distance of 1 from each of the other Y exemplars.

We summarize with a few observations regarding linear associators. The desirable properties of the linear associator depend on the requirement that the exemplar patterns comprise an orthonormal set. This restricts its practicality in two ways. First, there may be no obvious mapping from situations in the world to orthonormal vector patterns. Second, the number of patterns which can be stored is limited by the dimensionality of the vector space. When the orthonormality requirement is violated, interference between stored patterns occurs, causing a phenomenon called *crosstalk*.

Observe also that the linear associator retrieves an associated Y exemplar only when the input vector exactly matches an X exemplar. When there is not an exact match on the input pattern, the result is an interpolative mapping. It can be argued that interpolation is not memory in the true sense. We often want to implement a true memory retrieval function where an approximation to an exemplar retrieves the exact pattern that is associated with it. What is required is a *basin* of attraction to capture vectors in the surrounding region.

In the next section, we demonstrate an *attractor* version of the linear associator network.

14.6 Attractor Networks or “Memories”

14.6.1 Introduction

The networks discussed to this point are *feedforward*. In feedforward networks information is presented to a set of input nodes and the signal moves forward through the nodes or layers of nodes until some result emerges. Another important class of connectionist networks are *feedback* networks. The architecture of these nets is different in that the output signal of a node can be cycled back, directly or indirectly, as input to that node.

Feedback networks differ from feedforward networks in several important ways:

1. the presence of feedback connections between nodes,
2. a time delay, i.e., noninstantaneous signal propagation,
3. output of the network is the network's state upon convergence,
4. network usefulness depends on convergence properties.

When a feedback network reaches a time in which it no longer changes, it is said to be in a state of equilibrium. The state which a network reaches on equilibrium is considered to be the network output.

In the feedback networks of Section 14.6.2, the network state is initialized with an input pattern. The network processes this pattern, passing through a series of states until it reaches equilibrium. The network state on equilibrium is the pattern retrieved from memory. In Section 14.6.3, we consider networks that implement a heteroassociative memory, and in Section 14.6.4, an autoassociative memory.

The cognitive aspects of these memories are both interesting and important. They offer us a model for content addressable memory. This type of associator can describe the retrieval of a phone number, the feeling of sadness from an old memory, or even the recognition of a person from a partial facial view. Researchers have attempted to capture many of the associative aspects of this type of memory in symbol-based data structures, including semantic networks, frames, and object systems, as seen in Chapter 8.

An *attractor* is defined as a state toward which states in a neighboring region evolve across time. Each attractor in a network will have a region where any network state inside that region evolves toward that attractor. That region is called its *basin*. An attractor can consist in a single network state or a series of states through which the network cycles.

Attempts to understand attractors and their basins mathematically have given rise to the notion of a network energy function (Hopfield 1984). Feedback networks with an energy function that has the property that every network transition reduces total network energy are guaranteed to converge. We describe these networks in Section 14.6.3.

Attractor networks can be used to implement content addressable memories by installing the desired patterns as attractors in memory. They can also be used to solve optimization problems, such as the traveling salesperson problem, by creating a mapping between the cost function in the optimization problem and the network energy. The solution of the problem then comes through the reduction of total network energy. This type of problem solving is done with what is called a Hopfield network.

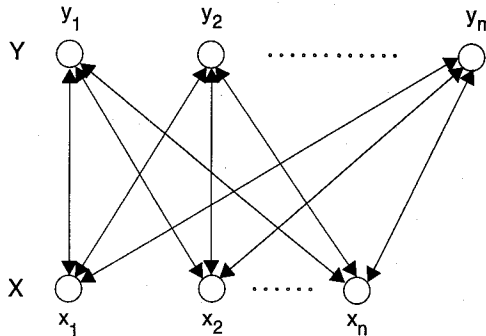

Figure 14.22 A BAM network for the examples of Section 14.6.2. Each node may also be connected to itself.

14.6.2 BAM, the Bi-directional Associative Memory

The BAM network, first described by Bart Kosko (1988), consists of two fully interconnected layers of processing elements. There can also be a feedback link connecting each node to itself. The BAM mapping of an n dimensional input vector X_n into the m dimensional output vector Y_m is presented in Figure 14.22. Since each link from X to Y is bi-directional, there will be weights associated with the information flow going in each direction.

Like the weights of the linear associator, the weights on the BAM network can be worked out in advance. In fact we use the same method for calculating network weights as that used in the linear associator. The vectors for the BAM architecture are taken from the set of Hamming vectors.

Given the N vector pairs that make up the set of exemplars we wish to store, we build the matrix as we did in Section 14.5.4:

$$W = Y_1 * X_1 + Y_2 * X_2 + \dots + Y_t * X_t.$$

This equation gives the weights on the connections from the X layer to the Y layer, as can be seen in Figure 14.22. For example, w_{32} is the weight on the connection from the second unit on the X layer to the third unit on the Y layer. We assume that any two nodes only have one pathway between them. Therefore, the weights connecting nodes on the X and Y layers are identical in both directions. Thus, the weight matrix from Y to X is the transpose of the weight matrix W .

The BAM network can be transformed into an autoassociative network by using the same weight initialization formula on the set of associations $\langle X_1, X_1 \rangle, \langle X_2, X_2 \rangle, \dots$. Since the X and Y layers resulting from this procedure are identical we can eliminate the Y layer, resulting in a network which looks like Figure 14.23. We look at an example of an autoassociative network in Section 14.6.4.

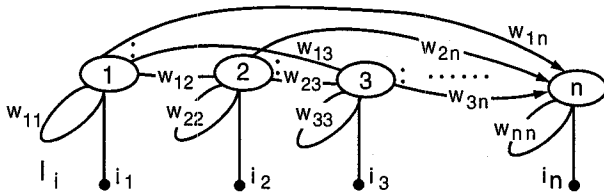

Figure 14.23 An autoassociative network with an input vector I_j . We assume single links between nodes with unique insights, thus $w_{ij} = w_{ji}$ and the weight matrix is symmetric.

The BAM network is used to retrieve patterns from memory by initializing the X layer with an input pattern. If the input pattern is a noisy or incomplete version of one of the exemplars, the BAM can often complete the pattern and retrieve the associated pattern.

To recall data with BAM, we do the following:

1. Apply an initial vector pair (X , Y) to the processing elements. X is the pattern for which we wish to retrieve an exemplar. Y is randomly initialized.
2. Propagate the information from the X layer to the Y layer and update the values at the Y layer.
3. Send the updated Y information back to the X layer, updating the X units.
4. Continue the preceding two steps until the vectors stabilize, that is until there is no further changes in the X and Y vector values.

The algorithm just presented gives BAM its feedback flow, its bidirectional movement toward equilibrium. The preceding set of instructions could have begun with a pattern at the Y level leading, upon convergence, to the selection of an X vector exemplar. It is fully bidirectional: we can take an X vector as input and can get a Y association on convergence or we can take a Y vector as input and get back a X association. We will see these issues worked through with an example in the next section.

Upon convergence, the final equilibrium state gives back one of the exemplars used to build the original weight matrix. If all goes as expected, we take a vector of known properties, either identical to or slightly different, from one of the exemplar vector pairs. We use this vector to retrieve the other vector in the exemplar pair. The distance is Hamming distance measured by component-wise comparison of the vectors, counting one for each element difference. Because of the orthonormality constraints, when BAM converges for a vector, it also converges for its complement. Thus we note that the complement of the vector also becomes an attractor. We give an example of this in the next section.

There are several things that can interfere with the BAM convergence. If too many exemplars are mapped into the weight matrix, the exemplars themselves can be too close together and produce pseudo-stabilities in the network. This phenomenon is called *crosstalk*, and occurs as local minima in the network energy space.

We next consider briefly the BAM processing. The multiplication of an input vector by the weight matrix computes the sums of the pairwise vector products of the vectors for each element of the output vector. A simple thresholding function then translates the resultant vector back to a vector in the Hamming space. Thus:

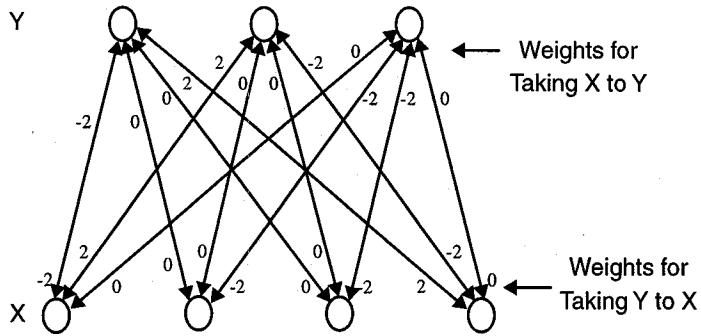

Figure 14.24 A BAM network for the examples of Section 14.6.3.

$$\text{net}(Y) = WX, \text{ or for each } Y_i \text{ component, } \text{net}(Y_i) = \sum w_{ij} * y_j,$$

with similar relationships for the X layer. The thresholding function f for net at time $t + 1$ is also straightforward:

$$f(\text{net}^{t+1}) = \begin{cases} +1 & \text{if net} > 0 \\ f(\text{net}^t) & \text{if net} = 0 \\ -1 & \text{if net} < 0 \end{cases}$$

In the next section we illustrate this *bidirectional associative memory* processing with several examples.

14.6.3 Examples of BAM Processing

Figure 14.24 presents a small BAM network, a simple variation of the linear associator presented in Section 14.5.4. This network maps a four element vector X into a three element vector Y and vice versa. Suppose we want to create the two vector pair exemplars:

$$x_1 = [1, -1, -1, -1] \leftrightarrow y_1 = [1, 1, 1], \text{ and} \\ x_2 = [-1, -1, -1, 1] \leftrightarrow y_2 = [1, -1, 1].$$

We now create the weight matrix according to the formula presented in the previous section:

$$W = Y_1 X_1^t + Y_2 X_2^t + Y_3 X_3^t + \dots + Y_N X_N^t \\ W = \begin{bmatrix} 1 & -1 & -1 & -1 \\ 1 & -1 & -1 & -1 \\ 1 & -1 & -1 & -1 \end{bmatrix} + \begin{bmatrix} -1 & -1 & -1 & 1 \\ 1 & 1 & 1 & -1 \\ -1 & -1 & -1 & 1 \end{bmatrix} = \begin{bmatrix} 0 & -2 & -2 & 0 \\ 2 & 0 & 0 & -2 \\ 0 & -2 & -2 & 0 \end{bmatrix}$$

The weight vector for the mapping from Y to X is the transpose of W, or:

$$\begin{bmatrix} 0 & 2 & 0 \\ -2 & 0 & -2 \\ -2 & 0 & -2 \\ 0 & -2 & 0 \end{bmatrix}$$

We now select several vectors and test the BAM associator. Let's start with an exemplar pair, choosing the X component and seeing if we get the Y. Let $X = [1, -1, -1, -1]$:

$$Y_1 = (0*1) + (-2*-1) + (-2*-1) + (-1*0) = 4, \text{ and } f(4) = 1,$$

$$Y_2 = (1*2) + (-1*0) + (-1*0) + (-1*-2) = 4, \text{ and } f(4) = 1, \text{ and}$$

$$Y_3 = (1*0) + (-1*-2) + (-1*-2) + (-1*0) = 4, \text{ and } f(4) = 1.$$

Thus the other half of the exemplar pair is returned. The reader can make this Y vector an input vector and verify that the original X vector $[1, -1, -1, -1]$ is returned.

For our next example, consider the X vector $[1, 1, 1, -1]$, with Y randomly initialized. We map X with our BAM network:

$$Y_1 = (1*0) + (1*-2) + (1*-2) + (-1*0) = -4, \text{ and } f(4) = -1,$$

$$Y_2 = (1*2) + (-1*0) + (1*0) + (-1*-2) = 4, \text{ and } f(4) = 1,$$

$$Y_3 = (1*0) + (-1*-2) + (1*-2) + (-1*0) = -4, \text{ and } f(4) = -1.$$

This result, with the thresholding function f applied to $[-4, 4, -4]$, is $[-1, 1, -1]$. Mapping back to X gives:

$$X_1 = (-1*0) + (1*2) + (-1*0) = 2,$$

$$X_2 = (-1*-2) + (1*0) + (-1*-2) = 4,$$

$$X_3 = (-1*-2) + (1*0) + (-1*-2) = 4,$$

$$X_4 = (-1*0) + (1*-2) + (-1*0) = -2.$$

The threshold function applied, again as above, gives the original vector $[1, 1, 1, -1]$. Since the starting vector produced a stable result with its first translation, we might think we have just discovered another prototype exemplar pair. In fact, the example we selected is the complement of the original $\langle X_2, Y_2 \rangle$ vector exemplar! It turns out that in a BAM network, when a vector pair is established as an exemplar prototype, so is its complement. Therefore, our BAM network includes two more prototypes:

$$X_3 = [-1, 1, 1, 1] \leftrightarrow Y_3 = -1, -1, -1], \text{ and}$$

$$X_4 = [1, 1, 1, -1] \leftrightarrow Y_4 = [-1, 1, -1].$$

Let us next select a vector near an X exemplar, $[1, -1, 1, -1]$. Note that the Hamming distance from the closest of the four X exemplars is 1. We next randomly initialize the vector Y to $[-1, -1, -1]$:

$$\begin{aligned}
Y_1^{T+1} &= (1*0) + (-1*-2) + (1*-2) + (-1*0) = 0, \\
Y_2^{T+1} &= (1*2) + (-1*0) + (1*0) + (-1*-2) = 4, \\
Y_3^{T+1} &= (1*0) + (-1*-2) + (1*-2) + (-1*0) = 0.
\end{aligned}$$

The evaluation of the net function $f(Y_i^{t+1}) = f(Y_i^t)$ when $y_i^{t+1} = 0$, from the threshold equation at the end of Section 14.6.2. Thus, Y is $[-1, 1, -1]$ due to the random initialization of the first and third parameters of the Y^T to -1 . We now take Y back to X :

$$\begin{aligned}
X_1 &= (-1*0) + (1*2) + (-1*0) = 2, \\
X_2 &= (-1*-2) + (1*0) + (-1*-2) = 4, \\
X_3 &= (-1*-2) + (1*0) + (-1*-2) = 4, \\
X_4 &= (-1*0) + (1*-2) + (-1*0) = -2.
\end{aligned}$$

The threshold function maps this result to the vector $X = [1, 1, 1, -1]$. We repeat the process taking this vector back to Y :

$$\begin{aligned}
Y_1 &= (1*0) + (1*-2) + (1*-2) + (-1*0) = -4, \\
Y_2 &= (1*2) + (-1*0) + (1*0) + (-1*-2) = 4, \\
Y_3 &= (1*0) + (-1*-2) + (1*-2) + (-1*0) = -4.
\end{aligned}$$

The threshold function applied to $[-4, 4, -4]$ again gives $Y = [-1, 1, -1]$. This vector is identical to the most recent version of Y , so the network is stable. This demonstrates that after two passes through the BAM net, a pattern that was close to X_4 converged to the stored exemplar. This would be similar to recognizing a face or other stored image with part of the information missing or obscured. The Hamming distance between the original X vector $[1, -1, 1, -1]$ and the X_4 prototype $[1, 1, 1, -1]$ was 1. The vector settled into the $\langle X_4, Y_4 \rangle$ exemplar pair.

In our BAM examples we started processing with the X element of the exemplar pair. Of course, we could have designed the examples from the Y vector, initializing X when necessary.

Hecht-Nielsen (1990, p. 82) presents an interesting analysis of the BAM network. He demonstrates that the orthonormal property for the linear associator network support for BAM is too restrictive. He gives an argument showing that the requirement for building the network is that the vectors be linearly independent, that is, that no vector can be created from a linear combination of other vectors in the space of exemplars.

14.6.4 Autoassociative Memory and Hopfield Nets

The research of John Hopfield, a physicist at California Institute of Technology, is a major reason connectionist architectures have their current credibility. He studied network convergence properties, using the concept of energy minimization. He also designed a family of networks based on these principles. As a physicist, Hopfield understood stabilities of physical phenomena as energy minimization points of the physical system. An example of this approach is the simulated annealing analysis of the cooling of metals.

Let us first review the basic characteristics of feedback associative networks. These networks begin with an initial state consisting of the input vector. The network then processes this signal through feedback pathways until it reaches a stable state. To use this architecture as an associative memory we would like the network to have two properties. First, starting from any initial state we would like a guarantee that the network will converge on some stable state. Second, we would like this stable state to be the one closest to the input state by some distance metric.

We look first at an autoassociative network built on the same principles as the BAM network. We noted in the previous section that BAM networks can be transformed into autoassociative networks by using identical vectors in the X and Y positions. The result of this transformation, as we see next, is a symmetric square weight matrix. Figure 14.23 of Section 14.6.2 offered an example.

The weight matrix for the autoassociative network that stores a set of vector exemplars $\{X_1, X_2, \dots, X_n\}$ is created by:

$$W = \sum X_i X_i^t \quad \text{for } i = 1, 2, \dots, n.$$

When we create the autoassociative memory from the heteroassociative, the weight from node x_i to x_j will be identical to that from x_j to x_i and so the weight matrix will be symmetric. This assumption only requires that the two processing elements be connected by one path having a single weight. We may also have the special case, again with neural plausibility, that no network node is directly linked to itself, that is, there are no x_i to x_i links. In this situation the main diagonal of the weight matrix, w_{ij} where $i = j$, is all zeros.

As with BAM, we work out the weight matrix based on the patterns to be stored in memory. We clarify this with a simple example. Consider the three vector exemplar set:

$$\begin{aligned} X_1 &= [1, -1, 1, -1, 1], \\ X_2 &= [-1, 1, 1, -1, -1], \\ X_3 &= [1, 1, -1, 1, 1]. \end{aligned}$$

We next calculate the weight matrix using $W = \sum X_i X_i^t$ for $i = 1, 2, 3$:

$$W = \begin{bmatrix} 1 & -1 & 1 & -1 & 1 \\ -1 & 1 & 1 & -1 & -1 \\ 1 & -1 & 1 & -1 & 1 \\ -1 & 1 & 1 & -1 & -1 \\ 1 & -1 & 1 & -1 & 1 \end{bmatrix} + \begin{bmatrix} 1 & -1 & -1 & 1 & 1 \\ -1 & 1 & 1 & -1 & -1 \\ -1 & 1 & 1 & -1 & -1 \\ 1 & -1 & -1 & 1 & 1 \\ 1 & -1 & -1 & 1 & 1 \end{bmatrix} + \begin{bmatrix} 1 & 1 & -1 & 1 & 1 \\ 1 & 1 & -1 & 1 & 1 \\ -1 & -1 & 1 & -1 & -1 \\ 1 & 1 & -1 & 1 & 1 \\ 1 & 1 & -1 & 1 & 1 \end{bmatrix}$$

and,

$$W = \begin{bmatrix} 3 & -1 & -1 & 1 & 3 \\ -1 & 3 & -1 & 1 & -1 \\ -1 & -1 & 3 & -3 & -1 \\ 1 & 1 & -3 & 3 & 1 \\ 3 & -1 & -1 & 1 & 3 \end{bmatrix}$$

We use the thresholding function:

$$f(\text{net}^{t+1}) = \begin{cases} +1 & \text{if net} > 0 \\ f(\text{net}^t) & \text{if net} = 0 \\ -1 & \text{if net} < 0 \end{cases}$$

We first test the network with an exemplar, $X_3 = [1, 1, -1, 1, 1]$, and obtain:

$$X_3 * W = [7, 3, -1, 9, 7],$$

and with the threshold function, $[1, 1, -1, 1, 1]$. We see this vector stabilizes immediately on itself. This illustrates that the exemplars are themselves stable states or attractors.

We next test a vector which is Hamming distance 1 from the exemplar X_3 . The network should return that exemplar. This is equivalent to retrieving a memory pattern from partially degraded data. We select $X = [1, 1, 1, 1, 1]$:

$$X * W = [5, 1, -3, 3, 5].$$

Using the threshold function gives the X_3 vector $[1, 1, -1, 1, 1]$.

We next take a third example, this time a vector whose Hamming distance is 2 away from its nearest prototype, let $X = [1, -1, -1, 1, -1]$. It can be checked that this vector is 2 away from X_3 , 3 away from X_1 , and 4 away from X_2 . We begin:

$$X * W = [3, -1, 1, 5, 3], \text{ which with threshold yields } [1, -1, 1, 1, 1].$$

This doesn't seem to resemble anything, nor is it a stability point, since:

$$[1, -1, 1, 1, 1] * W = [7, -3, -1, 1, 7], \text{ which is } [1, -1, -1, 1, 1].$$

We still do not have one of the prototypes. We check again for stability:

$$[1, -1, -1, 1, 1] * W = [9, -3, -1, 3, 9], \text{ which is } [1, -1, -1, 1, 1].$$

The net is now stable, but not with one of the original stored memories! Have we found another energy minimum? On closer inspection we note that this new vector is the complement of the original X_2 exemplar $[-1, 1, 1, -1, -1]$. Again, as in the case of the heteroassociative BAM network, our autoassociative network creates attractors for the original exemplars as well as for their complements, in this case, six attractors in all.

To this point in our presentation, we have looked at autoassociative networks based on a linear associator model of memory. One of John Hopfield's goals was to give a more general theory of autoassociative networks which would apply to any single-layer feedback network meeting a certain set of simple restrictions. For this class of single layer feedback networks Hopfield proved that there would always exist a network energy function guaranteeing convergence.

A further goal of Hopfield was to replace the discrete time updating model used previ-

ously with one that more closely resembles the continuous time processing of actual neurons. A common way to simulate continuous time asynchronous updating in Hopfield networks is to update nodes individually rather than as a layer. This is done using a random selection procedure for picking the next node to be updated, while also applying some method for ensuring that on average all the nodes in the network will be updated equally often.

The structure of a Hopfield network is identical to that of the autoassociative network above: a single layer of nodes completely connected (see Figure 14.23). The activation and thresholding also work as before. For node i ,

$$x_i^{\text{new}} = \begin{cases} +1 & \text{if } \sum w_{ij}x_j^{\text{old}} > T_i, \\ x_i^{\text{old}} & \text{if } \sum w_{ij}x_j^{\text{old}} = T_i, \\ -1 & \text{if } \sum w_{ij}x_j^{\text{old}} < T_i, \end{cases}$$

Given this architecture, only one further restriction is required to characterize a Hopfield net. If w_{ij} is the weight on the connection into node i from node j , we define a Hopfield network as one which respects the weight restrictions:

$$\begin{aligned} w_{ij} &= 0 && \text{for all } i, \\ w_{ij} &= w_{ji} && \text{for all } i, j. \end{aligned}$$

The Hopfield network does not typically have a learning method associated with it. Like the BAM, its weights are usually calculated in advance.

The behavior of Hopfield networks is now better understood than any other class of networks except perceptrons. This is because its behavior can be characterized in terms of a concise energy function discovered by Hopfield:

$$H(X) = -\sum_i \sum_j w_{ij}x_i x_j + 2\sum_i T_i x_i$$

We will now show that this energy function has the property that every network transition reduces the total network energy. Given the fact that H has a predetermined minimum and that each time H decreases it decreases by at least a fixed minimum amount, we can infer that from any state the network converges.

We first show that for an arbitrary processing element k which is the most recently updated, k changes state if and only if H decreases. The change in energy ΔH is:

$$\Delta H = H(X^{\text{new}}) - H(X^{\text{old}}).$$

Expanding this equation using the definition of H , we get:

$$\Delta H = -\sum_i \sum_j w_{ij}x_i^{\text{new}}x_j^{\text{new}} + 2\sum_i T_i x_i^{\text{new}} + \sum_i \sum_j w_{ij}x_i^{\text{old}}x_j^{\text{old}} + 2\sum_i T_i x_i^{\text{old}}$$

Since only x_k has changed, $x_i^{\text{new}} = x_i^{\text{old}}$ for i not equal to k . This means that the terms of the sum that do not contain x_k cancel each other out. Rearranging and collecting terms we get:

$$\Delta H = -2x_k^{\text{new}} \sum_j w_{kj} x_j^{\text{new}} + 2T_k x_k^{\text{new}} + 2x_k^{\text{old}} \sum_j w_{kj} x_j^{\text{old}} - 2T_k x_k^{\text{old}}.$$

Using the fact that $w_{ij} = 0$ and $w_{ij} = w_{ji}$ we can finally rewrite this as:

$$\Delta H = 2(x_k^{\text{old}} - x_k^{\text{new}}) \left[\sum_j w_{kj} x_j^{\text{old}} - T_k \right].$$

To show that ΔH is negative we consider two cases. First, suppose x_k has changed from -1 to $+1$. Then the term in square brackets must have been positive to make x_k^{new} be $+1$. Since $x_k^{\text{old}} - x_k^{\text{new}}$ is equal to -2 , ΔH must be negative. Suppose that x_k has changed from 1 to -1 . By the same line of reasoning, ΔH must again be negative. If x_k has not changed state, $x_k^{\text{old}} - x_k^{\text{new}} = 0$ and $\Delta H = 0$.

Given this result, from any starting state the network must converge. Furthermore, the state of the network on convergence must be a local energy minimum. If it were not then there would exist a transition that would further reduce the total network energy and the update selection algorithm would eventually choose that node for updating.

We have now shown that Hopfield networks have one of the two properties which we want in a network that implements associative memory. It can be shown, however, that Hopfield networks do not, in general, have the second desired property: they do not always converge on the stable state nearest to the initial state. There is no general known method for fixing this problem.

Hopfield networks can also be applied to the solution of optimization problems, such as the traveling salesperson problem. To do this the designer needs to find a way to map the cost function of the problem to the Hopfield energy function. By moving to an energy minimum the network will then also be minimizing the cost with respect to a given problem state. Although such a mapping has been found for some interesting problems, including the traveling salesperson problem, in general, this mapping from problem states to energy states is very difficult to discover.

In this section we introduced heteroassociative and autoassociative feedback networks. We analyzed the dynamical properties of these networks and presented very simple examples showing evolution of these systems toward their attractors. We showed how the linear associator network could be modified into an attractor network called the BAM. In our discussion of continuous time Hopfield networks, we saw how network behavior could be described in terms of an energy function. The class of Hopfield networks have guaranteed convergence because every network transition can be shown to reduce total network energy.

There still remain some problems with the energy-based approach to connectionist networks. First, the energy state reached need not be a global minimum of the system. Second, Hopfield networks need not converge to the attractor nearest to the input vector. This makes them unsuitable for implementing content addressable memories. Third, in

using Hopfield nets for optimization, there is no general method for creating a mapping of constraints into the Hopfield energy function. Finally, there is a limit to the total number of energy minima that can be stored and retrieved from a network, and even more importantly, this number cannot be set precisely. Empirical testing of these networks shows that the number of attractors is a small fraction of the number of nodes in the net. These and other topics are ongoing issues for research (Hecht-Nielsen 1990, Zurada 1992, Freeman and Skapura 1991).

Biology-based approaches, such as genetic algorithms and cellular automata, attempt to mimic the learning implicit in the evolution of life forms. Processing in these models is also parallel and distributed. In the genetic algorithm model, for example, a population of patterns represents the candidate solutions to a problem. As the algorithm cycles, this population of patterns “evolves” through operations which mimic reproduction, mutation, and natural selection. We consider these approaches in Chapter 15.

14.7 Epilogue and References

We introduced learning with connectionist networks in this chapter. We introduced them from an historical perspective in Section 14.1. For further reading we recommend McCulloch and Pitts (1943), Oliver Selfridge (1959), Claude Shannon (1948), and Frank Rosenblatt (1958). Early psychological models are also important, especially those of Donald Hebb (1949). Cognitive science has continued to explore the relationship between cognition and brain architecture. Contemporary sources include *An Introduction to Natural Computation* (Ballard 1997), *Artificial Minds* (Franklin 1995), *The Cognitive Neuroscience of Action* (Jeannerod 1997), and *Rethinking Innateness: A Connectionist Perspective on Development* (Elman et al. 1996).

We have not addressed many important mathematical as well as computational aspects of connectionist architectures. For an overview, we recommend Robert Hecht-Nielsen (1990), Jacek Zurada (1992), and James Freeman and David Skapura (1991).

There are many issues, both representational and computational, that the learning research scientist must consider. These include architecture and connectivity selection for the network as well as determining what cognitive parameters of the environment are to be processed and what the results might “mean.” There is also the issue of neural-symbol hybrid systems and how these might reflect different aspects of intelligence.

The backpropagation network is probably the most commonly used connectionist architecture, and thus we gave considerable space to its origins, use, and growth. The two volumes of *Parallel Distributed Processing* (Rumelhart et al. 1986b) give an introduction to neural networks both as computational and cognitive tools. *Neural Networks and Natural Intelligence* (Grossberg 1988) is another thorough treatment of the subject.

There are also further questions for use of the backpropagation networks, including the number of hidden nodes and layers, selecting the training set, fine-tuning the learning constant, the use of bias nodes, and so on. Many of these issues come under the general heading of *inductive bias*: the role of the knowledge, expectations, and tools that the problem solver brings to problem solving. We address many of these issues in Chapter 16.

Many of the original connectionist network architecture designers are still actively working in the field and we refer the reader directly to their publications. These include John Anderson et al. (1977), Stephan Grossberg (1976, 1988), Geoffrey Hinton and Terrence Sejnowski (1986), Robert Hecht-Nielsen (1989, 1990), John Hopfield (1982, 1984), Tuevo Kohonen (1972, 1984), Bart Kosko (1988), and Carver Mead (1989). We highly recommend reviewing their referenced materials

14.8 Exercises

1. Make a McCulloch–Pitts neuron that can calculate the logic function implies, \Rightarrow .
2. Build a perceptron net in LISP and run it on the classification example of Section 14.2.2.
 - a. Generate another data set similar to that of Table 14.3 and run your classifier on it.
 - b. Take the results of running the classifier and use the weights to determine the specification for the line separating the sets.
3. Build a backpropagation network in LISP or C++ and use it to solve the exclusive-or problem of Section 14.3.3. Solve the exclusive-or problem with a different backpropagation architecture, perhaps having two hidden nodes and no bias nodes. Compare the convergence speeds using the different architectures.
4. Write a Kohonen net in LISP or C++ and use it to classify the data of Table 14.3. Compare your results with those of Sections 14.2.2 and 14.4.2.
5. Write a counterpropagation net to solve the exclusive-or problem. Compare your results with those of backpropagation net of Section 14.3.3. Use your counterpropagation net to discriminate between the classes of Table 14.3.
6. Use a backpropagation net to recognize the ten (hand drawn) digits. One approach would be to build a 4 x 6 array of points. When a digit is drawn on this grid it will cover some elements, giving them value 1, and miss others, value 0. This 24 element vector would be the input value for your net. You would build your own training vectors. Do the same task with a counterpropagation net; compare your results.
7. Select a different input pattern than that we used in Section 14.5.2. Use the unsupervised Hebbian learning algorithm to recognize that pattern.
8. Section 14.5.4 used the linear associator algorithm to make two vector pair associations. Select three (new) vector pair associations and solve the same task. Test whether your linear associator is interpolative; that is, can it associate near misses of the exemplars? Make your linear associator autoassociative.
9. Consider the bidirectional associative memory (BAM) of Section 14.6.3. Change the association pairs given in our example and create the weight matrix for the associations. Select new vectors and test your BAM associator.
10. Describe the differences between the BAM memory and the linear associator. What is *crosstalk* and how can it be prevented?
11. Write a Hopfield net to solve the traveling salesperson problem for ten cities.

MACHINE LEARNING: SOCIAL AND EMERGENT

What limit can we put to this power, acting during long ages and rigidly scrutinizing the whole constitution, structure and habits of each creature – favoring the good and rejecting the bad? I can see no limit to this power in slowly and beautifully adapting each form to the most complex relations of life.

—CHARLES DARWIN, *On the Origin of Species*

The First Law of Prophecy:

When a distinguished but elderly scientist states that something is possible, he is almost certainly right. When he states that something is impossible, he is very probably wrong.

The Second Law:

The only way of discovering the limits of the possible is to venture a little way past them into the impossible.

The Third Law:

Any sufficiently advanced technology is indistinguishable from magic.

—ARTHUR C. CLARKE, *Profiles of the Future*

15.0 Social and Emergent Models of Learning

Just as connectionist networks received much of their early support and inspiration from the goal of creating an artificial neural system, so also have a number of other biological analogies influenced the design of machine learning algorithms. This chapter considers learning algorithms patterned after the processes underlying evolution: shaping a population of individuals through the survival of its most fit members. The power of selection across a population of varying individuals has been demonstrated in the emergence of species in natural evolution, as well as through the social processes underlying cultural change. It has also been formalized through research in cellular automata, genetic algo-

rhythms, genetic programming, artificial life, and other forms of emergent computation.

Emergent models of learning simulate nature's most elegant and powerful form of adaptation: the evolution of plant and animal life forms. Charles Darwin saw "...no limit to this power of slowly and beautifully adapting each form to the most complex relations of life..." Through this simple process of introducing variations into successive generations and selectively eliminating less fit individuals, adaptations of increasing capability and diversity *emerge* in a population. Evolution and emergence occur in populations of *embodied* individuals, whose actions affect others and that, in turn, are affected by others. Thus, selective pressures come not only from the outside environment, but also from interactions between members of a population. An ecosystem has many members, each with roles and skills appropriate to their own survival, but more importantly, whose cumulative behavior shapes and is shaped by the rest of the population.

Because of their simplicity, the processes underlying evolution have proven remarkably general. Biological evolution produces species by selecting among changes in the genome. Similarly, cultural evolution produces knowledge by operating on socially transmitted and modified units of information. Genetic algorithms and other formal evolutionary analogs produce increasingly capable problem solutions by operating on populations of candidate problem solutions.

When the genetic algorithm is used for problem solving, it has three distinct stages: First, the individual potential solutions of the problem domain are encoded into representations that support the necessary variation and selection operations; often, these representations are as simple as bit strings. In the second stage, mating and mutation algorithms, analogous to the sexual activity of biological life forms, produce a new generation of individuals that recombine features of their parents. Finally, a *fitness* function judges which individuals are the "best" life forms, that is, most appropriate for the eventual solution of the problem. These individuals are favored in survival and reproduction, shaping the next generation of potential solutions. Eventually, a generation of individuals will be interpreted back to the original problem domain as solutions for the problem.

Genetic algorithms are also applied to more complex representations, including production rules, to evolve rule sets adapted to interacting with an environment. For example, genetic programming combines and mutates fragments of computer code in an attempt to evolve a program for solving problems such as capturing the invariants in sets of data.

An example of learning as social interaction leading to survival can be found in games such as *The Game of Life*, which was originally created by the mathematician John Horton Conway and introduced to the larger community by Martin Gardner in *Scientific American* (1970, 1971). In this game, the birth, survival, or death of individuals is a function of their own state and that of their near neighbors. Typically, a small number of rules, usually 3 or 4, are sufficient to define the game. In spite of this simplicity, experiments with the game of life have shown it to be capable of evolving structures of extraordinary complexity and ability, including self replicating, multi-cellular "organisms" (Poundstone 1985).

Work in *artificial life*, or *a-life*, has simulated the conditions of biological evolution through the interactions of finite state machines, complete with sets of states and transition rules. These automata are able to accept information from outside themselves, in particular, from their closest neighbors. Their transition rules include instructions for birth, continuing in life, and dying. When a population of such automata is set loose in a domain and

allowed to act as parallel asynchronous cooperating agents, we sometimes witness the evolution of seemingly independent "life forms."

As another example, Rodney Brooks (1986, 1987) and his students have designed and built simple robots that interact as autonomous agents solving problems in a laboratory situation. There is no central control algorithm; rather cooperation emerges as an artifact of the distributed and autonomous interactions of individuals. The a-life community has regular conferences and journals reflecting their work (Langton 1995).

In Section 15.1 we introduce evolutionary or biology-based models with *genetic algorithms* (Holland 1975), an approach to learning that exploits parallelism, mutual interactions, and often a bit-level representation. In Section 15.2 we present *classifier systems* and *genetic programming*, relatively new research areas where techniques from genetic algorithms are applied to more complex representations, such as to build and refine sets of production rules (Holland et al. 1986) and to create and adapt computer programs (Koza 1992). In Section 15.3 we present *artificial life* (Langton 1995). We begin 15.3 with an introduction to "The Game of Life." We close with an example of emergent behavior from research at the Santa Fe Institute (Crutchfield and Mitchell 1995).

15.1 The Genetic Algorithm

Like neural networks, genetic algorithms are based on a biological metaphor: They view learning as a competition among a population of evolving candidate problem solutions. A "fitness" function evaluates each solution to decide whether it will contribute to the next generation of solutions. Then, through operations analogous to gene transfer in sexual reproduction, the algorithm creates a new population of candidate solutions.

Let $P(t)$ define a population of candidate solutions, x_i , at time t :

$$P(t) = \{x_1^t, x_2^t, \dots, x_n^t\}$$

We now present a general form of the genetic algorithm:

procedure genetic algorithm;

begin

set time $t := 0$;

initialize the population $P(t)$;

while the termination condition is not met do

begin

evaluate fitness of each member of the population $P(t)$;

select most fit members from the population $P(t)$;

produce the offspring of these pairs using genetic operators;

replace the weakest candidates of $P(t)$ with these offspring;

set time $t := t + 1$

end

end.

This algorithm articulates the basic framework of genetic learning; specific implementations of the algorithm instantiate that framework in different ways. What percentage of the population is retained? What percentage mate and produce offspring? How often and to whom are operators such as mutation applied? The procedure “replace the weakest candidates of $P(t)$ ” may be implemented in a simple fashion, by eliminating a fixed percentage of the weakest candidates. More sophisticated approaches may order a population by fitness and then associate a probability measure for elimination with each member, where the probability of elimination is an inverse function of its fitness. Then the replacement algorithm uses this measure as a factor in selecting candidates to eliminate. Although the probability of elimination would be very low for the fittest members of the society, there is a chance that even the best individuals could be removed. The advantage of this scheme is that it may save some individual whose overall fitness is poor but that includes some component that may contribute to a more powerful solution. This replacement algorithm is called the *Monte Carlo* or *wheel of fortune* approach.

Although the examples of Section 15.1.3 introduce more complex representations, we will introduce the representation issues related to genetic algorithms using simple bit strings to represent problem solutions. For example, suppose we want a genetic algorithm to learn to classify strings of 1s and 0s. We can represent a population of bit strings as a pattern of 1s, 0s, and #s, where # is a “don’t care,” that may match with either 0 or 1. Thus, the pattern 1##00##1 represents all strings of eight bits that begin and end with 1 and that have two 0s in the middle.

The genetic algorithm initializes $P(0)$ to a population of candidate patterns. Typically, initial populations are selected randomly. Evaluation of candidate solutions assumes a fitness function, $f(x_t)$ that returns a measure of the candidate’s fitness at time t . A common measure of a candidate’s fitness tests it on a set of training instances and returns the percentage of correct classifications. Using such a fitness function, an evaluation assigns each candidate solution the value:

$$f(x_t)/m(P, t)$$

where $m(P,t)$ is the average fitness over all members of the population. It is also common for the fitness measure to change across time periods, thus fitness could be a function of the stage of the overall problem solution, or $f(x(i,t))$.

After evaluating each candidate, the algorithm selects pairs for recombination. Recombination uses *genetic operators* to produce new solutions that combine components of their parents. As with natural evolution, the fitness of a candidate determines the extent to which it reproduces, with those candidates having the highest evaluations being given a greater probability of reproducing. As just noted, selection is often probabilistic, where weaker members are given a smaller likelihood of reproducing, but are not eliminated outright. That some less fit candidates survive is important since they can still contain some essential component of a solution, for instance part of a bit pattern, and reproduction may extract this component.

There are a number of genetic operators that produce offspring having features of their parents; the most common of these is *crossover*. Crossover takes two candidate solutions and divides them, swapping components to produce two new candidates. Figure 15.1 illustrates crossover on bit string patterns of length 8. The operator splits them in the mid-

dle and forms two children whose initial segment comes from one parent and whose tail comes from the other. Note that splitting the candidate solution in the middle is an arbitrary choice. This split may be at any point in the representation, and indeed, this splitting point may be randomly adjusted or changed systematically during the solution process.

For example, suppose the target class is the set of all strings beginning and ending with a 1. Both the parent strings in Figure 15.1 would have performed relatively well on this task. However, the first offspring would be much better than either parent: it would not have any false positives and would fail to recognize fewer strings that were actually in the solution class. Note also that its sibling is worse than either parent and will probably be eliminated over the next few generations.

Mutation is another important genetic operator. Mutation takes a single candidate and randomly changes some aspect of it. For example, mutation may randomly select a bit in the pattern and change it, switching a 1 to a 0 or #. Mutation is important in that the initial population may exclude an essential component of a solution. In our example, if no member of the initial population has a 1 in the first position, then crossover, because it preserves the first four bits of the parent to be the first four bits of the child, cannot produce an offspring that does. Mutation would be needed to change the values of these bits. Other genetic operators, e.g., *inversion*, could also accomplish this task, and are described in Section 15.1.3.

The genetic algorithm continues until some termination requirement is met, such as having one or more candidate solutions whose fitness exceeds some threshold. In the next section we give examples of genetic algorithm encodings, operators, and fitness evaluations for two situations: the CNF constraint satisfaction and the traveling salesperson problems.

15.1.3 Two Examples: CNF Satisfaction and the Traveling Salesperson

We next select two problems and discuss representation issues and fitness functions appropriate for their solutions. Three things should be noted: First, all problems are not easily or naturally encoded as bit level representations. Second, the genetic operators must preserve crucial relationships within the population, for example, the presence and uniqueness of all the cities in the traveling salesperson tour. Finally, we discuss an important relationship between the fitness function(s) for the states of a problem and the encoding of that problem.

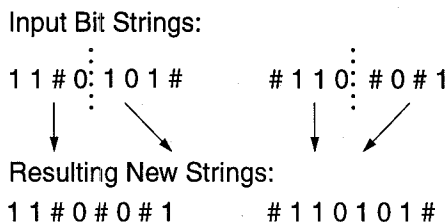

Figure 15.1 Use of crossover on two bit strings of length eight. # is “don’t care.”

The CNF-satisfaction problem

The conjunctive normal form (CNF) satisfiability problem is straightforward: An expression of propositions is in conjunctive normal form when it is a sequence of clauses joined by an and (\wedge) relation. Each of these clauses is in the form of a disjunction, the or (\vee), of literals. For example, if the literals are, a , b , c , d , e , and f , then the expression

$$(\neg a \vee c) \wedge (\neg a \vee c \vee \neg e) \wedge (\neg b \vee c \vee d \vee \neg e) \wedge (a \vee \neg b \vee c) \wedge (\neg e \vee f)$$

is in CNF. This expression is the conjunction of five clauses, each clause is the disjunction of two or more literals. We introduced propositions and their satisfaction in Chapter 2. We discussed the CNF form of propositional expressions, and offered a method of reducing expressions to CNF, when we presented resolution inferencing in Section 12.2.

CNF satisfiability means that we must find an assignment of true or false (1 or 0) to each of the six literals, so that the CNF expression evaluates to true. The reader should confirm that one solution for the CNF expression is to assign false to each of a , b , and e . Another solution has e false and c true.

A natural representation for the CNF satisfaction problem is a sequence of six bits, each bit, in order, representing true (1) or false (0) for each of the six literals, again in the order of a , b , c , d , e , and f . Thus:

1 0 1 0 1 0

indicates that a , c , and e are true and b , d , and f are false, and the example CNF expression is therefore false. The reader can explore the results of other truth assignments to the literals of the expression.

We require that the actions of each genetic operator produce offspring that are truth assignments for the CNF expression, thus each operator must produce a six-bit pattern of truth assignments. An important result of our choice of the bit pattern representation for the truth values of the literals of the CNF expression is that any of the genetic operators discussed to this point will leave the resulting bit pattern a legitimate possible solution. That is, crossover and mutation leave the resulting bit string a possible solution of the problem. Even other less frequently used genetic operators, such as *inversion* (reversing the order of the bits within the six-bit pattern) or *exchange* (interchanging two different bits in the pattern) leave the resulting bit pattern a legitimate possible solution of the CNF problem. In fact, from this viewpoint, it is hard to imagine a better suited representation than a bit pattern for the CNF satisfaction problem.

The choice of a fitness function for this population of bit strings is not quite as straightforward. From one viewpoint, either an assignment of truth values to literals will make the expression true or else the expression will be false. If a specific assignment makes the expression true, then the solution is found; otherwise it is not. At first glance it seems difficult to determine a fitness function that can judge the "quality" of bit strings as potential solutions.

There are a number of alternatives, however. One would be to note that the full CNF expression is made up of the conjunction of five clauses. Thus we can make up a rating

system that will allow us to rank potential bit pattern solutions in a range of 0 to 5, depending on the number of clauses that pattern satisfies. Thus the pattern:

1 1 0 0 1 0 has fitness 1,
0 1 0 0 1 0 has fitness 2,
0 1 0 0 1 1 has fitness 3, and
1 0 1 0 1 1 has fitness 5, and is a solution.

This genetic algorithm offers a reasonable approach to the CNF satisfaction problem. One of its most important properties is the use of the implicit parallelism afforded by the population of solutions. The genetic operators have a natural fit to this representation. Finally, the solution search seems to fit naturally a parallel “divide and conquer” strategy, as fitness is judged by the number of problem components that are satisfied. In the chapter exercises the reader is encouraged to consider other aspects of this problem.

The traveling salesperson problem

The traveling salesperson problem (TSP) is classic to AI and computer science. We introduced it with our discussion of graphs in Section 3.1. Its full state space requires the consideration of $N!$ states where N is the number of cities to be visited. It has been shown to be NP-hard, with many researchers proposing heuristic approaches for its solution. The statement of the problem is simple:

A salesperson is required to visit N cities as part of a sales route. There is a cost (e.g., mileage, air fare) associated with each pair of cities on the route. Find the least cost path for the salesperson to start at one city, visit all the other cities exactly once and return home.

The TSP has some very nice applications, including circuit board drilling, X-ray crystallography, and routing in VLSI fabrication. Some of these problems require visiting tens of thousands of points (cities) with a minimum cost path. One very interesting question in the analysis of the TSP class of problems is whether it is worth running an expensive workstation for many hours to get a near optimal solution or run a cheap PC for a few minutes to get “good enough” results for these applications. TSP is an interesting and difficult problem with many ramifications of search strategies.

How might we use a genetic algorithm to solve this problem? First, the choice of a representation for the path of cities visited, as well as the creation of a set of genetic operators for this path, is not trivial. The design of a fitness function, however, is very straightforward: all we need do is evaluate the path length. We could then order the paths by their length, the shorter the better.

Let's consider some obvious representations that turn out to have complex ramifications. Suppose we have nine cities to visit, 1, 2, ..., 9, so we make the representation of a path the ordered listing of these nine integers. Suppose we simply make each city a four-bit pattern, 0001, 0010, ... 1001. Thus, the pattern:

0001 0010 0011 0100 0101 0110 0111 1000 1001

represents a visit to each city in the order of its numbering. We have inserted blanks into the string only to make it easier to read. Now, what about the genetic operators? Crossover is definitely out, since the new string produced from two different parents would most probably not represent a path that visits each city exactly once. In fact, with crossover, some cities could be removed while others are visited more than once. What about mutation? Suppose the leftmost bit of the sixth city, 0110, is mutated to 1? 1110, or 14, is no longer a legitimate city. Inversion, and the swapping of cities (the four bits in the city pattern) within the path expression would be acceptable genetic operators, but would these be powerful enough to obtain a satisfactory solution? In fact, one way to look at the search for the minimum path would be to generate and evaluate all possible permutations of the N elements of this city list. The genetic operators must be able to produce all permutations.

Another approach to the TSP would be to ignore the bit pattern representation and give each city an alphabetic or numeric name, e.g., 1, 2, ..., 9; make the path through the cities an ordering of these nine digits, and then select appropriate genetic operators for producing new paths. Mutation, as long as it was a random exchange of two cities in the path, would be okay, but the crossover operator between two paths would be useless. The exchange of pieces of a path with other pieces of the same path, or any operator that shuffled the letters of the path (without removing, adding, or duplicating any cities) would work. These approaches, however, make it difficult to combine into offspring the "better" elements of patterns within the paths of cities of the two different parents.

A number of researchers (Davis 1985, Oliver et al. 1987) have created crossover operators that will overcome these problems and let us work with the ordered list of cities visited. For example, Davis has defined an operator called *order crossover*. Suppose we have nine cities, 1, 2, ..., 9, and the order of the integers represents the order of visited cities.

Order crossover builds offspring by choosing a subsequence of cities within the path of one parent. It also preserves the relative ordering of cities from the other parent. First, select two cut points, indicated by a "|", which are randomly inserted into the same location of each parent. The locations of the cut points are random, but once selected, the same locations are used for both parents. For example, for two parents p_1 and p_2 , with cut points after the third and seventh cities:

$$p_1 = (1\ 9\ 2\ | \ 4\ 6\ 5\ 7\ | \ 8\ 3)$$

$$p_2 = (4\ 5\ 9\ | \ 1\ 8\ 7\ 6\ | \ 2\ 3)$$

two children c_1 and c_2 are produced in the following way. First, the segments between cut points are copied into the offspring:

$$c_1 = (x\ x\ x\ | \ 4\ 6\ 5\ 7\ | \ x\ x)$$

$$c_2 = (x\ x\ x\ | \ 1\ 8\ 7\ 6\ | \ x\ x)$$

Next, starting from the second cut point of one parent, the cities from the other parent are copied in the same order, omitting cities already present. When the end of the string is reached, continue on from the beginning. Thus, the sequence of cities from p_2 is:

$$2\ 3\ 4\ 5\ 9\ 1\ 8\ 7\ 6$$

Once cities 4, 6, 5, and 7 are removed, since they are already part of the first child, we get the shortened list 2, 3, 9, 1, and 8, which then makes up, preserving the ordering found in p_2 , the remaining cities to be visited by c_1 :

$$c_1 = (2\ 3\ 9\ |4\ 6\ 5\ 7\ |1\ 8)$$

In a similar manner we can create the second child c_2 :

$$c_2 = (8\ 3\ 9\ |1\ 8\ 7\ 6\ |2\ 4)$$

To summarize, in order crossover, pieces of a path are passed on from one parent, p_1 , to a child, c_1 , while the ordering of the remaining cities of the child c_1 is inherited from the other parent, p_2 . This supports the obvious intuition that the ordering of cities will be important in generating the least costly path, and it is therefore crucial that pieces of this ordering information be passed on from fit parents to children.

The order crossover algorithm also guarantees that the children would be legitimate tours, visiting all cities exactly once. If we wished to add a mutation operator to this result we would have to be careful, as noted earlier, to make it an exchange of cities within the path. The inversion operator, simply reversing the order of all the cities in the tour, would not work (there is no new path when all cities are inverted). However, if a piece within the path is cut out and inverted and then replaced, it would be an acceptable use of inversion. For example, using the cut $|$ indicator as before, the path:

$$c_1 = (2\ 3\ 9\ |4\ 6\ 5\ 7\ |1\ 8),$$

becomes under inversion of the middle section,

$$c_1 = (2\ 3\ 9\ |7\ 5\ 6\ 4\ |1\ 8)$$

A new mutation operator could be defined that randomly selected a city and placed it in a new randomly selected location in the path. This mutation operator could also operate on a piece of the path, for example, to take a subpath of three cities and place them in the same order in a new location within the path. Other suggestions are in the exercises.

15.1.4 Evaluating the Genetic Algorithm

The preceding examples highlight genetic algorithm's unique problems of knowledge representation, operator selection, and the design of a fitness function. The representation selected must support the genetic operators. Sometimes, as with the CNF satisfaction problem, the bit level representation is natural. In this situation, the traditional genetic operators of crossover and mutation could be used directly to produce potential solutions. The traveling salesperson problem was an entirely different matter. First, there did not seem to be any natural bit level representations for this problem. Secondly, new mutation and crossover operators had to be devised that preserved the property that the offspring

had to be legal paths through all the cities, visiting each only once.

Finally, genetic operators must pass on “meaningful” pieces of potential solution information to the next generation. If this information, as in CNF satisfiability, is a truth value assignment, then the genetic operators must preserve it in the next generation. In the TSP problem, path organization was critical, so as we discussed, components of this path information must be passed on to descendants. This successful transfer rests both in the representation selected as well as in the genetic operators designed for each problem.

We leave representation with one final issue, the problem of the “naturalness” of a selected representation. Suppose, as a simple, if somewhat artificial, example, we want our genetic operators to differentiate between the numbers 6, 7, 8, and 9. An integer representation gives a very natural and evenly spaced ordering, because, within base ten integers, the next item is simply one more than the previous. If we change to a binary representation, however, this naturalness disappears. Consider the bit patterns for 6, 7, 8, and 9:

0110 0111 1000 1001

Observe that between 6 and 7 as well as between 8 and 9 there is a 1 bit change. Between 7 and 8, however, all four bits change! This representational anomaly can be huge in trying to generate a solution that requires any organizing of these four bit patterns. A number of techniques, usually under the general heading of *gray coding*, address this problem of non-uniform representation. For instance, a gray coded version of the first sixteen binary numbers may be found in Table 15.1. Note that each number is exactly one bit different from its neighbors. Using gray coding instead of standard binary numbers, the genetic operator’s transitions between states of near neighbors is natural and smooth.

Binary	Gray
0000	0000
0001	0001
0010	0011
0011	0010
0100	0110
0101	0111
0110	0101
0111	0100
1000	1100
1001	1101
1010	1111
1011	1110
1100	1010
1101	1011
1110	1001
1111	1000

Table 15.1 The gray coded bit patterns for the binary numbers 0, 1, . . . , 15.

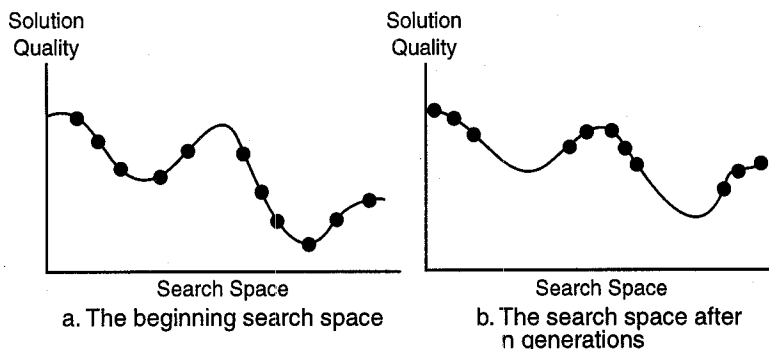

Figure 15.2 Genetic algorithms visualized as parallel hill climbing. Adapted from Holland (1986).

An important strength of the genetic algorithm is in the parallel nature of its search. Genetic algorithms implement a powerful form of hill climbing that maintains multiple solutions, eliminates the unpromising, and improves good solutions. Figure 15.2, adapted from Holland (1986), shows multiple solutions converging toward optimal points in a search space. In this figure, the horizontal axis represents the possible points in a solution space, while the vertical axis reflects the quality of those solutions. The dots on the curve are members of the genetic algorithm's current population of candidate solutions. Initially, the solutions are scattered through the space of possible solutions. After several generations, they tend to cluster around areas of higher solution quality.

When we describe our genetic search as "hill climbing" we implicitly acknowledge moving across a "fitness landscape." This landscape will have its valleys, peaks, with local maxima and minima. In fact, some of the discontinuities in the space will be artifacts of the representation and genetic operators selected for the problem. This discontinuity, for example, could be caused by a lack of gray coding, as just discussed. Note also that genetic algorithms, unlike sequential forms of hill climbing, as in Section 4.1, do not immediately discard unpromising solutions. Through genetic operators, even weak solutions may continue to contribute to the makeup of future candidate solutions.

Another difference between genetic algorithms and the state space heuristics presented in Chapter 4 is the analysis of the present-state/goal-state difference. The information content supporting the A* algorithm, as in Section 4.2, required an estimate of "effort" to move between the present state and a goal state. No such measure is required with genetic algorithms, simply some measure of fitness of each of the current generation of potential solutions. There is also no strict ordering required of next states on an open list as we saw in state space search; rather, there is simply a population of fit solutions to a problem, each potentially available to help produce new possible solutions within a paradigm of parallel search.

An important source of the genetic algorithm's power is the *implicit parallelism* inherent in the evolutionary operators. In comparison with state space search and an ordered open list, search moves in parallel, operating on entire families of potential solu-

tions. By restricting the reproduction of weaker candidates, genetic algorithms may not only eliminate that solution, but all of its descendants. For example, the string, 101#0##1, if broken at its midpoint, can parent a whole family of strings of the form 101#____. If the parent is found to be unfit, its elimination also removes all of these potential offspring.

As genetic algorithms are more widely used in applied problem solving as well as in scientific modeling, there is increasing interest in attempts to understand their theoretical foundations. Several questions that naturally arise are:

1. Can we characterize types of problems for which GAs will perform well?
2. For what problem types do they perform poorly?
3. What does it even “mean” for a GA to perform well or poorly for a problem type?
4. Are there any laws that can describe the macrolevel of behavior of GAs? In particular, are there any predictions that can be made about the changes in fitness of subgroups of the population over time?
5. Is there any way to describe the differential effects of different genetic operators, crossover, mutation, inversion, etc., over time?
6. Under what circumstances (what problems and what genetic operators) will GAs perform better than traditional AI search methods?

Addressing many of these issues goes well beyond the scope of our book. In fact, as Mitchell (1996) points out, there are still more open questions at the foundations of genetic algorithms than there are generally accepted answers. Nonetheless, from the beginning of work in GAs, researchers, including Holland (1975), have attempted to understand how GAs work. Although they address issues on the macro level, such as the six questions just asked, their analysis begins with the micro or bit level representation.

Holland (1975) introduced the notion of a *schema* as a general pattern and a “building block” for solutions. A schema is a pattern of bit strings that is described by a template made up of 1, 0, and # (don’t care). For example, the schema 1 0 # # 0 1, represents the family of six-bit strings beginning with a 1 0 and ending with a 0 1. Since, the middle pattern # # describes four bit patterns, 0 0, 0 1, 1 0, 1 1, the entire schema represents four patterns of six 1s and 0s. Traditionally, each schema is said to describe a hyperplane (Goldberg 1989); in this example, the hyperplane cuts the set of all possible six-bit representations. A central tenet of traditional GA theory is that schemata are the building blocks of families of solutions. The genetic operators of crossover and mutation are said to manipulate these schemata towards potential solutions. The specification describing this manipulation is called the *schema theorem* (Holland 1975, Goldberg 1989). According to Holland, an adaptive system must identify, test, and incorporate structural properties hypothesized to give better performance in some environment. Schemata are meant to be a formalization of these structural properties.

Holland’s schema analysis suggests that the fitness selection algorithm increasingly focuses the search on subsets of the search space with estimated best fitness; that is, the

subsets are described by schemas of above average fitness. The genetic operator crossover puts high fitness building blocks together in the same string in an attempt to create ever more fit strings. Mutation helps guarantee that (genetic) diversity is never removed from the search; that is, that we continue to explore new parts of the fitness landscape. The genetic algorithm can thus be seen as a tension between opening up a general search process and capturing and preserving important (genetic) features in that search space. Although Holland's original analysis of GA search focused at the bit level, more recent work has extended this analysis to alternate representational schemes (Goldberg 1989). In the next section we apply GA techniques to more complex representations.

15.2 Classifier Systems and Genetic Programming

Early research in genetic algorithms focused almost exclusively on low-level representations, such as strings of {0, 1, #}. In addition to supporting straightforward instantiations of genetic operators, bit strings and similar representations give genetic algorithms much of the power of other subsymbolic approaches, such as connectionist networks. There are problems, however, such as the traveling salesperson, that have a more natural encoding at a more complex representational level. We can further ask whether genetic algorithms can be defined for still richer representations, such as *if... then...* rules or pieces of computer code. An important aspect of such representations is their ability to combine distinct, higher level knowledge sources through rule chaining or function calls to meet the requirements of a specific problem instance.

Unfortunately, it is difficult to define genetic operators that capture the syntactic and semantic structure of logical relationships while enabling effective application of operators such as crossover or mutation. One possible way to marry the reasoning power of rules with genetic learning is to translate logical sentences into bit strings and use the standard crossover operator. Unfortunately, under many translations most of the bit strings produced by crossover and mutation will fail to correspond to meaningful logical sentences. As an alternative to representing problem solutions as bit strings, we may define variations of crossover that can be applied directly to higher level representations such as *if... then...* rules or chunks of code in a higher level programming language. This section discusses examples of each approach to extending the power of genetic algorithms.

15.2.1 Classifier Systems

Holland (1986) developed a problem-solving architecture called *classifier systems* that applies genetic learning to rules in a production system. A classifier system (Figure 15.3) includes the familiar elements of a production system: production rules (here called classifiers), working memory, input sensors (or decoders) and outputs, or effectors. Unusual features of a classifier system include the use of competitive bidding for conflict resolution, genetic algorithms for learning and the *bucket brigade algorithm* to assign credit and blame to rules during learning. Feedback from the outside environment

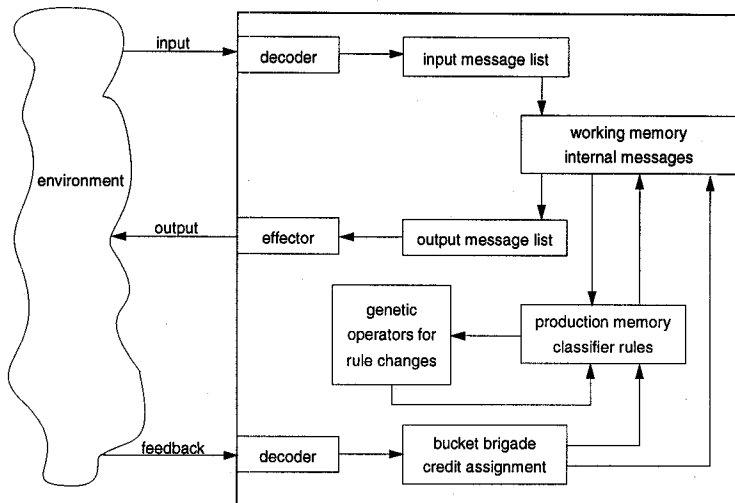

Figure 15.3 A classifier system interacting with the environment, after Holland (1986).

provides a means of evaluating the fitness of candidate classifiers, as required in genetic learning. The classifier system of Figure 15.3 has the following major components.

1. Detectors of input messages from the environment.
2. Detectors of feedback messages from the environment.
3. Effectors translating results of rule applications back to the environment.
4. A production rule set made up of a population of classifiers. Each classifier has an associated fitness measure.
5. A working memory for the classifier rules. This memory integrates the results of production rule firing with input information.
6. A set of genetic operators for production rule modification.
7. A system for giving credit to rules involved in producing successful actions.

In problem solving, the classifier performs as a traditional production system. The environment sends a message, perhaps a move in a game, to the classifier system's detectors. This event is decoded and placed as a pattern on the internal message list, the working memory for the production system. These messages, in the normal action of data-driven production system, match the condition patterns of the classifier rules. The selection of the "strongest activated classifiers" is determined by a bidding scheme, where

a bid is a function of both the accumulated fitness of the classifier and the quality of the match between the input stimulus and its condition pattern. The classifiers with the closest match add messages (the action of the fired rules) to working memory. The revised message list may send messages to the effectors which act upon the environment or activate new classifier rules as the production system processing continues.

Classifier systems implement a form of supervised learning. Based on feedback from a teacher or fitness evaluation function, the learner computes the fitness of a population of candidate rules and adapts this population using a variation of genetic learning. Classifier systems learn in two ways. First, there is a reward system that adjusts the fitness measures of the classifier rules, rewarding successful rule firings and penalizing errors. The credit assignment algorithm passes part of the reward or penalty back to any other classifier rules that have contributed to the final rule firing. This distribution of differential rewards across interacting classifiers as well as those that enabled their firing is often implemented in a *bucket brigade* algorithm. The bucket brigade algorithm addresses the problem of assigning credit or blame in situations where the system's output may be the product of a sequence of rule firings. In the event of an error, how do we know which rule to blame? Is the responsibility that of the last rule to fire, or of some previous rule that provided it with faulty information? The bucket brigade algorithm allocates both credit and blame across a sequence of rule applications according to measures of each rule's contribution to the final conclusion (An analogous assignment of blame for error was described with the backpropagation algorithm of Section 14.3). See (Holland 1986) for more details.

The second form of learning modifies the rules themselves using genetic operators such as mutation and crossover. This allows the most successful rules to survive and combine to make new classifiers, while unsuccessful rule classifiers disappear.

Each classifier rule consists of three components: The rule's condition matches data in the working memory in the typical production system sense. In learning, genetic operators modify the conditions of the production rules. The second component of the rule is the action, unchanged by the genetic operators, whose effect is to change the internal message list (the production memory). Finally, each rule has a fitness measure. This parameter is changed, as just noted, both by successful as well as by unsuccessful activity. This measure is originally assigned to each rule on its creation by the genetic operators; for example, it may be set as the average fitness of its two parents.

A simple example illustrates the interactions of these components of a classifier system. Assume that a set of objects to be classified are defined by six attributes (conditions c_1, c_2, \dots, c_6), and further suppose that each of these attributes can have five different values. Although the possible values of each attribute are of course different (for example, the value of c_3 might be color, while c_5 might describe the weather) we will, without loss of generality, simply give each attribute an integer value from $\{1, 2, \dots, 5\}$. Suppose that the conditions of these rules place their matching object in one of four classes: A_1, A_2, \dots, A_4 .

Based on these constraints, each classifier will have the form:

$$(c_1 c_2 c_3 c_4 c_5 c_6) \rightarrow A_i, \text{ where } i = 1, 2, 3, 4.$$

where each c_i in the condition pattern denotes the value (1, 2, ..., 5) of the i th attribute of the condition. Usually, conditions can also assign a value of # or "don't care" to an

attribute. A_i denotes the classification, A_1 , A_2 , A_3 , or A_4 . Table 15.2 presents a set of classifiers. Note that different condition patterns can have the same classification, as in rules 1 and 2, or the same patterns, as in rules 3 and 5, can lead to different classifications.

Condition (Attributes)	Action (Classification)	Rule Number
(1 # # # 1 #)	→ A1	1
(2 # # 3 # #)	→ A1	2
(# # 4 3 # #)	→ A2	3
(1 # # # # #)	→ A2	4
(# # 4 3 # #)	→ A3	5
etc.		

Table 15.2 A set of condition → action classifiers to be “learned.”

As described so far, a classifier system is simply another form of the ubiquitous production system. The only really novel feature of classifier rules is their use of strings of 0s, 1s, and #s to represent condition patterns. However, it is this representation of conditions that enables the application of genetic algorithms to the rules. The remainder of the discussion describes genetic learning in classifier systems.

In order to simplify the remainder of the example, we will only consider the classifier system’s performance in learning the classification A_1 . That is, we will ignore the other classifications, and assign condition patterns a value of 1 or 0 depending on whether or not they support classification A_1 . Note that there is no loss of generality in this simplification; it may be extended to problems of learning more than one classification by using a vector to indicate the classifications that match a particular condition pattern. For example, the classifiers of Table 15.2 may be summarized by:

(1 # # # 1 #) → (1 0 0 0)
 (2 # # 3 # #) → (1 0 0 0)
 (1 # # # # #) → (0 1 0 0)
 (# # 4 3 # #) → (0 1 1 0)

In this example, the last of these summaries indicates that the condition attributes support classification rules A_2 and A_3 and not A_1 or A_4 . By replacing the 0 or 1 assignment with these vectors, the learning algorithm can evaluate the performance of a rule across multiple classifications.

In this example, we will use the rules in Table 15.2 to indicate the correct classifications; essentially, they will function as teachers or evaluators of the fitness of rules in the learning system. As with most genetic learners, we begin with a random population of rules. Each condition pattern is also assigned a *strength*, or *fitness*, parameter (a real number between 0.0, no strength, and 1.0, full strength). This strength parameter, s , is computed from the fitness of each rule’s parents, and measures its historical fitness.

At each learning cycle, the rules attempt to classify the inputs and are then ranked by the teacher or fitness metric. For example, assume that at some cycle, the classifier has the

following population of candidate classification rules:

(# # # 2 1 #) → 1 s = 0.6
(# # 3 # # 5) → 0 s = 0.5
(2 1 # # #) → 1 s = 0.4
(# 4 # # # 2) → 0 s = 0.23

Suppose a new input message arrives from the environment: (1 4 3 2 1 5), and the teacher (using the rules of Table 15.2) classifies this input vector as a positive example of A1. Let's consider what happens when working memory receives this pattern and the four candidate classifier rules try to match it. Rules 1, 2, and 4 match. Conflict resolution is done through competitive bidding among matching rules. In our example, bidding is a function of the sum of the matches of the attribute values times the strength measure of the rule. "Don't care" matches have the value 0.5, while exact matches have value 1. Since the input vector matches the first classifier with one exact and one "don't care," its bid is $(0.5 + 1) * 0.6$, or 0.9. The second and fourth classifiers match with two "don't cares" so their bids are 0.5 and 0.23 respectively. In our example, only the classifier making the highest bid fires, but in more complex situations, it may be desirable for a percentage of the bids to be accepted.

The first rule wins and posts its action, a 1, indicating that this pattern is an example of A1. Since this action is correct, the fitness measure of rule 1 is increased to between its present value and 1.0. Had the action of this rule been incorrect, the fitness measure would have been lowered. If the system required multiple firings of the rule set to produce some result on the environment, all the rules responsible for this result would receive some proportion of the reward. The exact procedure by which the rule's fitness is calculated varies across systems and may be fairly complex, involving the use of the bucket brigade algorithm or some similar credit assignment technique. See (Holland 1986) for details.

Once the fitness of the candidate rules has been computed, the learning algorithm applies genetic operators to create the next generation of rules. Because of the representation of conditions as strings of {0, 1, #}, the genetic operators, crossover and mutation, may be defined as in the previous section. First, a selection algorithm will decide the most fit members of the rule set. This selection is based on the fitness measure, but may also include an additional random value. The random value gives rules with a poor fitness the opportunity to reproduce, helping to avoid a too hasty elimination of rules that, while performing poorly overall, may incorporate some element of the desired solution. Suppose the first two classifier rules from our example are selected to survive and reproduce. Randomly selecting a crossover position between the fourth and fifth elements,

(# # # 2 | 1 #) → 1 s = 0.6
(# # 3 # | # 5) → 0 s = 0.5

produces the offspring:

(# # 3 # | 1 #) → 0 s = 0.53
(# # # 2 | # 5) → 1 s = 0.57

The fitness measure of the children is a weighted function of the fitness of the parents. The weighting is a function of where the crossover point lies. The first offspring has 1/3 of the original 0.6 classifier and 2/3 of the original 0.5 classifier. Thus, the first offspring has strength of $(1/3 * 0.6) + (2/3 * 0.5) = 0.53$. With a similar calculation, the fitness of the second child is 0.57. The result of firing the classifier rule, always 0 or 1, goes with the majority of the attributes, thus preserving the intuition that these patterns are important in the outcomes of the rules. In a typical classifier system these two new rules, along with their parents, would make up the subset of classifiers for the operation of the system at the next time step.

A mutation operator may also be defined. A simple mutation rule would be to randomly change any attribute pattern to some other valid attribute pattern; for example, a 5 could be mutated to 1, 2, 3, 4 or #. Again, as noted in our discussion of GAs, mutation operators are seen as forcing diversity into the search for classifiers, while crossover attempts to preserve and build new children from successful pieces of parental patterns.

Our example was simple and intended primarily for illustrating the main components of the classifier system. In an actual system, more than one rule might fire and each pass their results along to the production memory. There is often a taxation scheme that keeps any classifier from becoming too prominent in the solution process by lowering its fitness each time it wins a bid. We also did not illustrate the bucket brigade algorithm, differentially rewarding rules supporting successful output messages to the environment. Also, the genetic operators do not usually rework the classifiers at every operation of the system. Rather, there is some general parameter for each application that decides, perhaps on analysis of feedback from the environment, when the classifiers should be evaluated and the genetic operators applied.

Finally, our example is taken from the classifier systems that Holland (1986) at the University of Michigan proposed. The Michigan approach can be viewed as a computational model of cognition, where the knowledge (the classifiers) of a cognitive entity are exposed to a reacting environment and as a result undergo modification over time. We evaluate the success of the entire system over time, while the importance of the individual classifier is minimal. Alternative classifier systems have also been investigated, including work at the University of Pittsburgh (Michalski 1983). The Pittsburgh classifier focuses on the roles of individual rules in producing new generations of classifiers. This approach implements a model of inductive learning proposed by Michalski.

In the next section we consider a different and particularly exciting application for GAs, the evolution of computer programs.

15.2.2 Programming with Genetic Operators

Through the last several subsections we have seen GAs applied to progressively larger representational structures. What began as genetic transformations on bit strings evolved to operations on *if . . . then . . .* rules. It can quite naturally be asked if genetic and evolutionary techniques might be applied to the production of other larger scale computational tools. There have been two major examples of this: the generation of computer programs and the evolution of systems of finite state machines.

Koza (1992) suggested that a successful computer program might evolve through successive applications of genetic operators. In genetic programming, the structures being adapted are hierarchically organized segments of computer programs. The learning algorithm maintains a population of candidate programs. The fitness of a program will be measured by its ability to solve a set of tasks, and programs are modified by applying crossover and mutation to program subtrees. Genetic programming searches a space of computer programs of varying size and complexity; in fact, the search space is the space of all possible computer programs composed of functions and terminal symbols appropriate to the problem domain. As with all genetic learners, this search is random, largely blind and yet surprisingly effective.

Genetic programming starts with an initial population of randomly generated programs made up of appropriate program pieces. These pieces, suitable for a problem domain, may consist of standard arithmetic operations, other related programming operations, and mathematical functions, as well as logical and domain-specific functions. Program components include data items of the usual types: boolean, integer, floating point, vector, symbolic, or multiple-valued.

After initialization, thousands of computer programs are genetically bred. The production of new programs comes with application of genetic operators. Crossover, mutation, and other breeding algorithms must be customized for the production of computer programs. We will see several examples shortly. The fitness of each new program is then determined by seeing how well it performs in a particular problem environment. The nature of the fitness measure will vary according to the problem domain. Any program that does well on this fitness task will survive to help produce the children of the next generation.

To summarize, *genetic programming* includes six components, many very similar to the requirements for GAs:

1. A set of structures that undergo transformation by genetic operators.
2. A set of initial structures suited to a problem domain.
3. A fitness measure, again domain dependent, to evaluate structures.
4. A set of genetic operators to transform structures.
5. Parameters and state descriptions that describe members of each generation.
6. A set of termination conditions.

In the following paragraphs we address each of these topics in more detail.

Genetic programming manipulates hierarchically organized program modules. LISP was (and still remains) the primary representation for the programming language components: Koza represents program segments as LISP symbol expressions, or *s-expressions*. (See Chapter 10 for a discussion of *s-expressions*, their natural representation as tree structures, and their evaluation as programs.)

Genetic operators manipulate s-expressions. In particular, operators map tree structures of s-expressions (LISP program segments) into new trees (new LISP program segments). Although this s-expression is the basis for Koza's early work, other researchers have more recently applied this approach to different programming paradigms.

Genetic programming will construct useful programs, given that the atomic pieces and evaluable predicates of the problem domain are available. When we set up a domain for the generation of a programs sufficient to address a set of problems, we must first analyze what terminals are required for units in its solution as well as what functions are necessary to produce these terminals. As Koza notes (1992, p.86) "... the user of genetic programming should know ... that some composition of the functions and terminals he supplies can yield a solution of the problem."

To initialize the structures for adaptation by genetic operators, we must create two sets: F, the set of functions and T, the set of terminal values required for the domain. F can be as simple as {+, *, -, /} or may require more complex functions such as $\sin(X)$, $\cos(X)$, or functions for matrix operations. T may be the integers, reals, matrices, or more complex expressions. The symbols in T must be closed under the functions defined in F.

Next, a population of initial "programs" is generated by randomly selecting elements from the union of sets F and T. For example, if we begin by selecting an element of T, we have a degenerate tree of a single root node. More interestingly, when we start with an element from F, say +, we get a root node of a tree with two potential children. Suppose the initializer next selects * (with two potential children) from F, as the first child, and then the terminal 6 from T as the second child. Another random selection might yield the terminal 8, and then the function + from F. Assume it concludes by selecting 5 and 7 from T.

The program we have randomly produced is represented in Figure 15.4. Figure 15.4a gives the tree after the first selection of +, 15.4b after selecting the terminal 6, and 15.4c the final program. A population of similar programs is created to initialize the genetic programming process. Sets of constraints, such as the maximum depth for programs to evolve, can help prune this population. Descriptions of these constraints, as well as different methods for generating initial populations, may be found in Koza (1992).

The discussion to this point addresses the issues of representation (s-expressions) and the set of tree structures necessary to initialize a situation for program evolution. Next, we require a fitness measure for populations of programs. The fitness measure is problem domain dependent and usually consists of a set of tasks the evolved programs must address. The fitness measure itself is a function of how well each program does on these tasks. A simple *raw fitness* score would add the differences between what the program produced and the results that the actual task from the problem domain required. Thus, raw fitness could be seen as the sum of errors across a set of tasks. Other fitness measures are possible, of course. Normalized fitness divides raw fitness by the total sum of possible errors and thus puts all fitness measures within the range of 0 to 1. Normalization can have an advantage when trying to select from a large population of programs. A fitness measure can also include an adjustment for the size of the program, for example, to reward smaller, more parsimonious programs.

Genetic operators on programs include both transformations on a tree itself as well as the exchange of structures between trees. Koza (1992) describes the primary transformations as *reproduction* and *crossover*. Reproduction simply selects programs from the

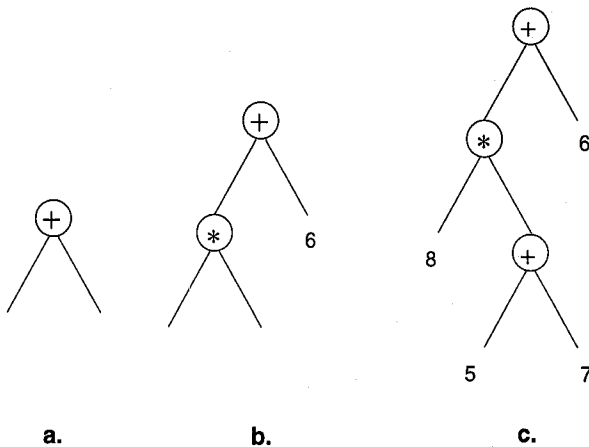

Figure 15.4 The random generation of a program to initialize. The circled nodes are from the set of functions.

present generation and copies them (unchanged) into the next generation. Crossover exchanges subtrees between the trees representing two programs. For example, suppose we are working with the two parent programs of Figure 15.5, and that the random points indicated by | in parent a and parent b are selected for crossover. The resulting children are shown in Figure 15.6. Crossover can also be used to transform a single parent, by interchanging two subtrees from that parent. Two identical parents can create different children with randomly selected crossover points. The root of a program can also be selected as a crossover point.

There are a number of secondary, and much less used, genetic transforms of program trees. These include *mutation*, which simply introduces random changes in the structures of a program. For example, replacing a terminal value with another value or a function subtree. The *permutation* transform, similar to the inversion operator on strings, also works on single programs, exchanging terminal symbols, or subtrees, for example.

The state of the solution is reflected by the current generation of programs. There is no record keeping for backtrack or any other method for skipping around the fitness landscape. In this aspect genetic programming is much like the hill-climbing algorithm described in Section 4.1. The genetic programming paradigm parallels nature in that the evolution of new programs is a continuing process. Nonetheless, lacking infinite time and computation, termination conditions are set. These are usually a function both of program fitness and computational resources.

The fact that genetic programming is a technique for the computational generation of computer programs places it within the automatic programming research tradition. From the earliest days of AI, researchers have worked to automatically produce computer programs from fragmentary information (Shapiro 1992). Genetic programming can be seen as another tool for this important research domain. We conclude this section with a simple example of genetic programming taken from Mitchell (1996).

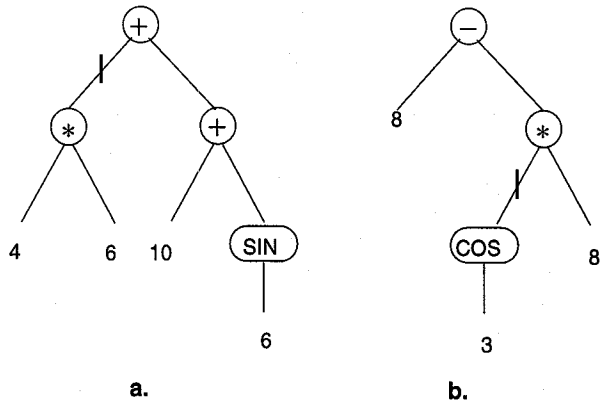

Figure 15.5 Two programs, selected on fitness for crossover. Point *l* from a and b are randomly selected for crossover.

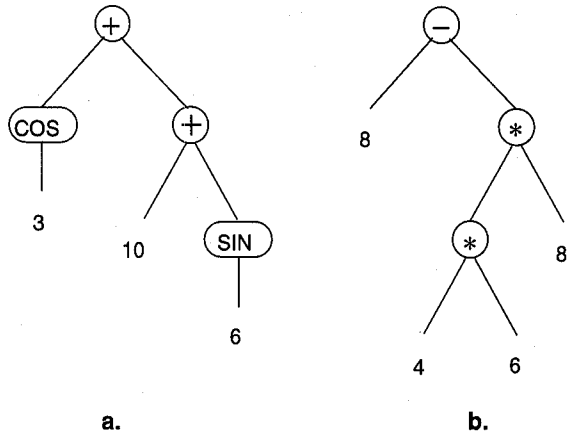

Figure 15.6 The child programs produced by crossover of the points in Figure 15.5.

Evolving a program to reflect Kepler's Third Law of Planetary Motion

Koza (1992) describes many applications of genetic programming to solve interesting problems, but most of these examples are large and too complex for our present purposes. Mitchell (1996), however, has created a simple example that illustrates many of the concepts of genetic programming. Kepler's Third Law of Planetary Motion describes the functional relationship between the orbital period, *P*, of a planet and its average distance, *A*, from the sun. This function is

$$P^2 = cA^3$$

where c is a constant. If we assume that P is expressed in units of earth years, and A is expressed in units of earth's average distance from the sun, then $c = 1$. The s-expression of this relationship is:

$$P = (\text{sqrt} (* A (* A A)))$$

Thus, the program we want to evolve is represented by the tree structure of Figure 15.7.

The selection of the set of terminal symbols in this example is simple; it is the single real value given by A . The set of functions could be equally simple, say $\{+, -, *, /, \text{sq}, \text{sqrt}\}$. Next we will create a beginning random population of programs. The initial population might include:

$(* A (- (* A A) (\text{sqrt} A)))$	fitness: 1
$(/ A (/ (/ A A) (/ A A)))$	fitness: 3
$(+ A (* (\text{sqrt} A) A))$	fitness: 0

(We explain the attached fitness measures shortly). As noted earlier in this section this initializing population often has a priori limits both of size and depth, given knowledge of the problem domain. These three examples are described by the programs trees of Figure 15.8.

Next we determine a suite of tests for the population of programs. Suppose we know some planetary data we want our evolved program to explain. For example, we have the planetary data in Table 15.3, taken from Urey (1952), which gives us a set of data points that our evolving programs must explain.

Planet	A (input)	P (output)
Venus	0.72	0.61
Earth	1.0	1.0
Mars	1.52	1.84
Jupiter	5.2	11.9
Saturn	9.53	29.4
Uranus	19.1	83.5

Table 15.3 A set of fitness cases, with planetary data taken from Urey (1952). A is Earth's semi-major axis of orbit and P is in units of earth-years.

Since the fitness measure is a function of the data points we want to explain, we define fitness as the number of outputs of the program that come within 20% of the correct output values. We use this definition to create the fitness measures of the three programs of Figure 15.8. It remains for the reader to create more members of this initial population, to build crossover and mutation operators that can produce further generations of programs, and to determine termination conditions.

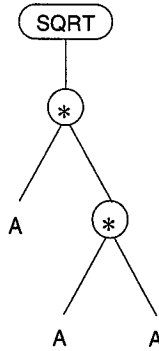

Figure 15.7 The target program relating orbit to period for Kepler's Third Law.

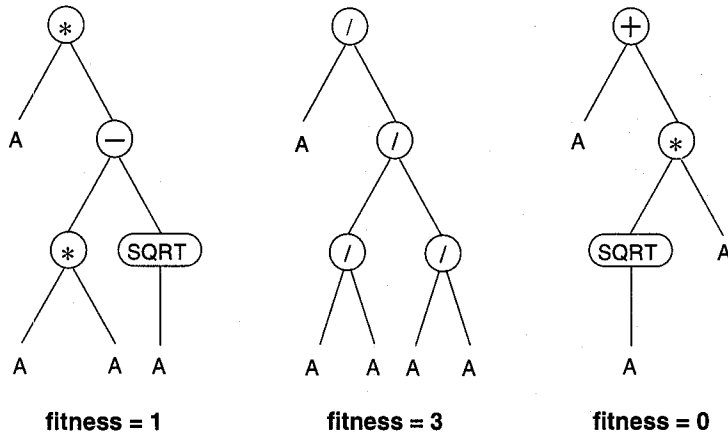

Figure 15.8 Members from the initial population of programs to solve the orbital period problem.

15.3 Artificial Life and Society-Based Learning

Earlier in this chapter, we described a simplified version of “The Game of Life.” This game, most effectively shown in computational visual simulations where succeeding generations rapidly change and evolve on a screen display, has a very simple specification. It was first proposed as a board game by the mathematician John Horton Conway, and made famous through Martin Gardner’s discussion of it in *Scientific American* (1970, 1971). The Game of Life is a simple example of a model of computation called *cellular automata* (CA). Cellular automata are families of simple, finite-state machines that exhibit interesting, emergent behaviors through their interactions in a population.

DEFINITION

FINITE-STATE MACHINE or CELLULAR AUTOMATON

1. A set I called the *input alphabet*.
2. A set S of *states* that the automaton can be in.
3. A designated state s_0 , the *initial state*.
4. A *next state function* $N: S \times I \rightarrow S$, that assigns a next state to each ordered pair consisting of a current state and a current input.

The output of Finite State Machines, or FSMs, is a function of their present states and the states of their near neighboring finite state machines. Thus, the state of a FSM at time $(t + 1)$ is a function of its state and *the state of its neighbors* at time t . It is through these interactions with their neighbors that collections of cellular automata can achieve much richer behaviors than the simple definitions of individual automata would indicate. This emergence of complexity is one of the most fascinating properties of populations of cellular automata. Because the output of a state is a function of its neighboring states, we describe the evolution of a set of neighboring FSMs as society-based adaptation.

For the societies described in this section, there is no explicit evaluation of the fitness of individual members. Fitness results from interactions in the population, interactions that may lead to the “death” of individual automata. Fitness is implicit in the survival of individuals from generation to generation. Learning among cellular automata is typically unsupervised; as occurs in natural evolution, adaptation is shaped by the actions of other, co-evolving members of the population.

A global, or society-oriented viewpoint also allows an important perspective on learning. We no longer need to focus exclusively on the individual, but can rather see invariances and regularities emerging within the society as a whole. The emergence of invariances will be an important aspect of the Crutchfield–Mitchell research presented in Section 15.3.2.

Finally, unlike supervised learning, evolution need not be “intentional.” That is, the society need not be seen as “going somewhere,” say to some “omega” point. We had a convergence bias when we used the explicit fitness measures in the earlier sections of this chapter, i.e., we were evolving towards some testable convergence point. Now the only success is continued existence, and the patterns that emerge are the patterns of a society.

15.3.1 The “Game of Life”

Consider the simple two-dimensional grid or game board of Figure 15.9. Here we have one square occupied, in black, with its eight nearest neighbors indicated by gray shading. The board is transformed over time periods, where the state of each square at time $t + 1$ is a function of its state and the state of these indicated nearest neighbors at time t . Three simple rules can drive evolution in the game: First, if any square, occupied or not, has exactly three of its nearest neighbors occupied, it will be occupied at the next time period.

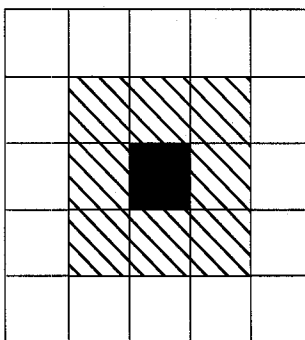

Figure 15.9 The shaded region indicates the set of neighbors for the “game of life.”

Second, if any occupied square has exactly two of its nearest neighbors occupied, it will be occupied in the next time period. Finally, for all other situations the square will not be occupied at the next time period.

One interpretation of these rules is that, for each generation or time period, life at any location, that is, whether or not the square is occupied and has state value 1, is a result of its own as well as its neighbors’ life during the previous generation. Specifically, too dense a population of surrounding neighbors (more than three) or too sparse a neighboring population (less than two) at any time period will not allow life for the next generation.

Consider, for example, the state of life for Figure 15.10a. Here exactly two squares, indicated by an x, have exactly three occupied neighbors. At the next life cycle Figure 15.10b will be produced. Here again there are exactly two squares, indicated by y, with exactly three occupied neighbors. It can be seen that the state of the world will cycle back and forth between Figures 15.10a and 15.10b. The reader can determine what the next state will be for Figures 15.11a and 15.11b and examine other possible “world” configurations. Poundstone (1985) describes the extraordinary variety and richness of the structures that can emerge in the game of life, such as *gliders*, patterns of cells that move across the world through repeated cycles of shape changes.

Because of their ability to produce rich collective behaviors through the interactions of simple cells, cellular automata have proven a powerful tool for studying the mathematics of the emergence of life from simple, inanimate components. *Artificial life* is defined as *life made by human effort rather than by nature*. As can be seen in the previous example, artificial life has a strong “bottom up” flavor; that is, the atoms of a life-system are defined and assembled and their physical interactions “emerge.” Regularities of this life form are captured by the rules of the finite state machine.

But how might a-life constructs be used? In biology, for example, the set of living entities provided by nature, as complex and diverse as they may be, are dominated by accident and historical contingency. We trust that there are logical regularities at work in the creation of this set, but it is unlikely that we will discover many of the total possible regularities when we restrict our view to the set of biological entities that nature actually provides. It is critical to explore the full set of possible biological regularities, some of

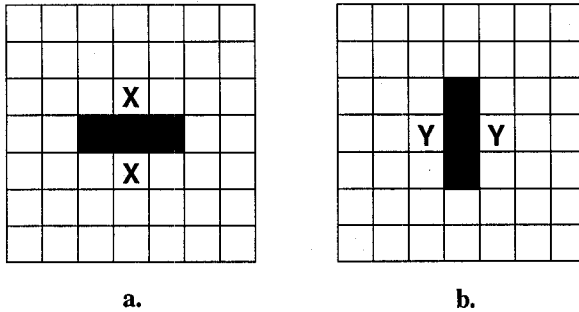

Figure 15.10 A set of neighbors generating the “blinking” light phenomenon.

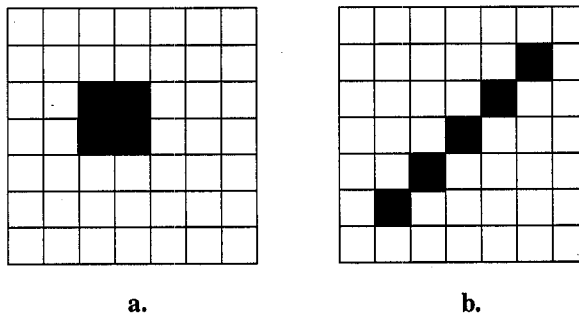

Figure 15.11 What happens to these patterns at the next time cycle?

which may have been eliminated by historical accident. We can always wonder what the present world would be like had not the dinosaurs’ existence been preemptorily terminated. To have a theory of the actual, it is necessary to understand the limits of the possible.

Besides the determined effort of anthropologists and other scientists to fill in the gaps in knowledge of our actual evolution, there is continued speculation about rerunning the story of evolution itself. What might happen if evolution started off with different initial conditions? What if there were alternative intervening “accidents” within our physical and biological surroundings? What might emerge? What would remain constant? The evolutionary path that actually did occur on earth is but one of many possible trajectories. Some of these questions might be addressed if we could generate some of the many biologies that are possible.

A-life technology is not just an artifact of computational or biological domains. Research scientists from areas as diverse as chemistry and pharmacology have built synthetic artifacts, many related to the knowledge of actual entities existing in our world. For example, in the field of chemistry, research into the constitution of matter and the

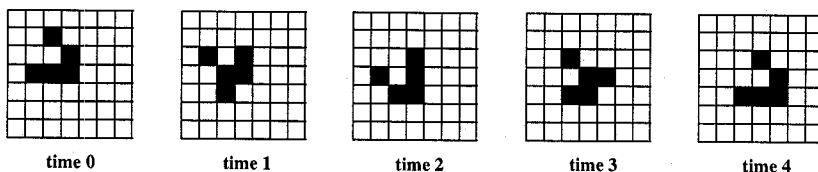

Figure 15.12 A “glider” moves across the display.

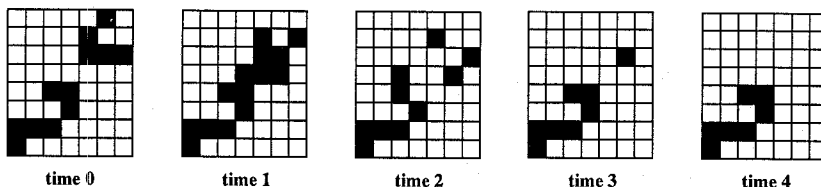

Figure 15.13 A “glider” is “consumed” by another “entity.”

many compounds that nature provides has led to analysis of these compounds, their constituent pieces, and their bonds. This analysis and recombination has led to the creation of numerous compounds that do not exist naturally. Our knowledge of the building blocks of nature has led us to our own synthetic versions, putting components of reality together in new and different patterns. It is through this careful analysis of natural chemical compounds that we come to some understanding of the set of possible compounds.

One tool for understanding possible worlds is to simulate and analyze society based movement and interaction effects. We have simple examples of this in the Game of Life. The sequence of time cycles demonstrated in Figure 15.12 implements the *glider* that was mentioned earlier. The glider sweeps across the game space by cycling among a small number of patterns. Its action is simple as it moves, in four time periods, to a new location one row further to the left and one row closer to the bottom of the grid.

An interesting aspect of the game of life is that entities such as the glider persist until interacting with other members of their society; what then happens can be difficult to understand and predict. For example, in Figure 15.13, we see the situation where two gliders emerge and engage. After four time periods, the glider moving down and to the left is “consumed” by the other entity. It is interesting to note that our ontological descriptions, that is, our use of terms such as “entity,” “blinking light,” “glider,” “consumed,” reflects our own anthropocentric biases on viewing life forms and interactions, whether artificial or not. It is very human of us to give names to regularities as they emerge within our social structures.

15.3.2 Evolutionary Programming

The “Game of Life” is an intuitive, highly descriptive example of cellular automata. We can generalize our discussion of cellular automata by characterizing them as finite state

machines. We now discuss societies of linked FSMs and analyze them as emergent entities. This study is sometimes called *evolutionary programming*.

The history of evolutionary programming goes back to the beginning of computers themselves. John von Neumann, in a series of lectures in 1949, explored the question of what level of organizational complexity was required for self-replication to occur (Burks 1970). Burks cites von Neumann's goal as "...not trying to simulate the self-reproduction of a natural system at the level of genetics and biochemistry. He wished to abstract from the natural self-reproduction problem its logical form."

By removing chemical, biological, and mechanical details, von Neumann was able to represent the essential requirements for self-replication. von Neumann went on to design (it was never built) a self-reproducing automaton consisting of a two-dimensional cellular arrangement containing a large number of individual 29-state automata, where the next state for each automaton was a function of its current state and the states of its four immediate neighbors (Burks 1970, 1987).

Interestingly, von Neumann designed his self-replicating automaton, estimated to contain at least 40,000 cells, to have the functionality of a Universal Turing Machine. This universal computation device was also *construction universal*, in the sense that it was capable of reading an input tape, interpreting the data on the tape, and, through use of a construction arm, building the configuration described on the tape in an unoccupied part of the cellular space. By putting a description of the constructing automaton itself on the tape, von Neumann created a self-reproducing automaton (Arbib 1966).

Later Codd (1968) reduced the number of states required for a computationally universal, self-reproducing automaton from 29 to 8, but required an estimated 100,000,000 cells for the full design. Later Devore simplified Codd's machine to occupy only about 87,500 cells. In modern times, Langton created a self-replicating automaton, without computational universality, where each cell had only eight states and occupied just 100 cells (Langton 1983, Hightower 1992, Codd 1992). Current descriptions of these research efforts may be found in the proceedings of the a-life conferences (Langton 1989, Langton et al. 1992).

Thus, the formal analysis of self-replicating machines has deep roots in the theory of computation. Perhaps even more exciting results are implicit in empirical studies of a-life forms. The success of these programs is not indicated by some *a priori* fitness function, but rather by the simple fact that they can survive and replicate. Their mark of success is that they survive. On the darker side, we have experienced the legacy of computer viruses and worms that are able to work their way into foreign hosts, replicate themselves (usually destroying any information in the memory required for replication), and move on to infect yet other foreign hosts.

We conclude this section by summarizing the empirical research of two projects in a-life, that of Rodney Brooks at MIT and Nils Nilsson and his students at Stanford.

Rodney Brooks (1991a, b) at MIT has built a research program based on the premise of a-life, namely that intelligence emerges through the interactions of a number of autonomous agents. Brook's approach, often described as "intelligence without representation" calls for a different approach to the creation of an artificial intelligence. Brooks argues:

We must incrementally build up the capabilities of intelligent systems, having complete systems at each step of the way and thus automatically ensure that the pieces and their interfaces are valid.

At each step we should build complete intelligent systems that we let loose in the real world with real sensing and real action. Anything less provides a candidate with which we can delude ourselves.

We have been following this approach and have built a series of autonomous mobile robots. We have reached an unexpected conclusion:

When we examine very simple levels of intelligence we find that explicit representations and models of the world simply get in the way. It turns out to be better to use the world as its own model.

Brooks has built a set of robots that are able to sense obstacles and move around the offices and hallways at MIT. They are able to wander about, explore, and avoid other objects. Each of these entities is based on Brooks notion of a *subsumption architecture*, which “embodies the fundamental ideas of decomposition into layers of task achieving behaviors, and incremental composition through debugging in the real world.” The intelligence of this system is an artifact of their simple organization and their embodied interactions with their environment. Brooks states that “We wire finite state machines together into layers of control. Each layer is built on top of existing layers. Lower level layers never rely on the existence of higher level layers.” Further information on this research may be found in Brooks (1986, 1987, 1991).

Nils Nilsson and his students at Stanford, especially Scott Benson, have designed a system for teleo-reactive agent control. In comparison with the efforts of Brooks, Nilsson’s research offers a more global agent architecture along with component subsystems that can integrate the functions needed for robust, flexible performance in dynamic environments. These abilities include the appropriate reaction to environmental situations based on the agent’s goals; selective attention to multiple competing goals; planning new action routines when innovation beyond designer-provided routines is necessary; and finally, learning the effects of actions so that the planner can use them to build ever more reliable plans.

Nilsson and his students (Nilsson 1994, Benson 1995, Benson and Nilsson 1996) have designed a *teleo-reactive* (T-R) program for agent control, a program that directs an agent towards a goal in a manner that continuously takes into account changing environmental circumstances. This program operates very much with the flavor of a production system (Chapter 5) but also supports *durative action*, or action that takes place across arbitrary time periods, such as *go forward until...* Thus, unlike ordinary production systems, conditions must be continuously evaluated, and the action associated with the current highest true condition is always the one being executed.

To summarize:

1. This research supports an architecture for planning that requires stereotypical programs of responses. The architecture also supports planning that allows

agents to react appropriately and rapidly to commonly occurring situations (thus *reactive*). The agents' actions are also dynamic and reflect their goals (thus *teleo*).

2. The agents must be able to maintain multiple time-varying goals and take actions that correspond to this organization of goals.
3. Since it is impossible to store all possible stereotypical situations, it is important for the agent to dynamically plan sequences of actions, and as environmental situations change, to re-plan as necessary.
4. In conjunction with continuously replanning according to environmental circumstances, it is important for the system to learn. This research, besides allowing the human to occasionally recode T-R programs, incorporates learning and adaptation methods that enable the agent to change its program automatically.

The interested reader is directed to Nilsson (1994), Benson (1995), Benson and Nilsson (1996) for further information on this exciting research project.

These two research efforts are samples from a very large population of agent-based research efforts. These projects are fundamentally experimental. They ask questions of the natural world. The natural world responds with survival and growth for successful algorithms or the annihilation of the system incapable of adaptation. We discuss this issue of Artificial Intelligence as empirical enquiry in more detail in the Epilogue, Chapter 16.

Finally, we consider research from the Santa Fe Institute: a case study in emergence.

15.3.3 A Case Study in Emergence (Crutchfield and Mitchell 1994)

Crutchfield and Mitchell explore the ability of evolution and interaction within simple systems to create higher-level collective information processing relationships. Their research offers an example of the (evolutionary or genetic algorithm supported) emergence of instances of global computation across a spatial system consisting of distributed and locally interacting cells or processors. The term *emergent computation* describes the appearance of global information processing structures in these systems. The goal of the Crutchfield and Mitchell research is to describe an architecture and mechanisms sufficient to evolve and support methods for emergent computation.

Specifically, a cellular automaton (CA) is made up of a number of individual cells; in fact, there are 149 cells in each automaton of the examples we present. These binary-state cells are distributed across a one-dimensional space with no global coordination. Each cell changes state as a function of its own state and the states of its two immediate neighbors. The CA forms a two-dimensional lattice as it evolves across time periods. The lattice starts out with an initial randomly generated set of N cells. In the example of Figure 15.14, there are 149 cells represented through the first 149 time steps of their evolution. (There is

a zero time period and the cells are numbered from 0, 1, ..., 148). Two examples of these cellular automata's behavior may be seen in the space-time diagrams of Figure 15.14. In these diagrams the ones are given as black cells and the zeros as white cells. Of course, different rules for the cell neighborhoods will produce different patterns in the space-time diagram of the CA.

Next we describe the rule set that determines the activity of the cells that make up each CA. Figure 15.15 presents a one-dimensional binary-state nearest neighbor CA, with $N = 11$ cells. Both the lattice and the rule table for updating the lattice are presented. The lattice is shown changing across one time step. The lattice is actually a cylinder, with the left end and the right end of the lattice at each time period being neighbors (this is important for applying the rule set). The rule table supports the local *majority vote* rule: if a local neighborhood of three cells has a majority of ones, then the center cell becomes a one at the next time step; otherwise, it becomes a zero at the next time step.

Crutchfield and Mitchell want to find a CA that performs the following collective computation, here called *majority wins*: if the initial lattice contains a majority of ones, the CA should evolve across time to all ones; otherwise, it should evolve to all zeros. They use CAs with neighborhoods containing seven cells, a center cell with three neighbors on each side. An interesting aspect of this research is that it is difficult to design a CA rule that performs the majority wins computation. In fact, in Mitchell et al. (1996), they show that the simple seven-neighbor "majority vote" rule does not perform the "majority wins" computation. The GA is used to search for a rule that will.

The genetic algorithm (GA), Section 15.1, is used to create the rule tables for different experiments with the CAs. Specifically, a GA is used to evolve the rules for the

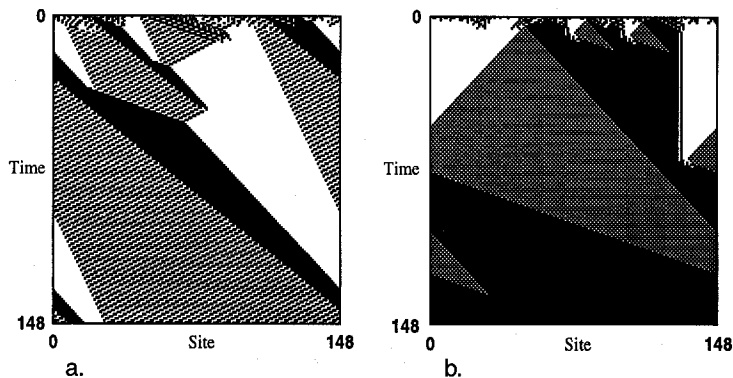

Figure 15.14 Space-time diagrams showing the behavior of two CAs, discovered by the genetic algorithm on different runs. They employ embedded particles for the non local computation required in density classification. Each space-time diagram iterates over a range of time steps, with 1s given as black cells, 0s as white cells; time increases down the page (from Crutchfield and Mitchell, 1994).

one-dimensional binary-state cell population that makes up each CA. A fitness function is designed to reward those rules that support the majority wins result for the CA itself. Thus, over time, the GA built a rule set whose fitness was a function of its eventual success in enforcing global majority rules. The fittest rules in the population were selected to survive and randomly combined by crossover to produce offspring, with each offspring subject to a small probability of mutation. This process was iterated for 100 generations, with fitness estimated for a new set of initial cells at each generation. Full details may be found in Crutchfield and Mitchell (1994).

How can we quantify the emergent computation the more successful CAs are supporting? Like many spatially extended natural processes, the cell configurations often organize over time into spatial regions that are dynamically homogenous. Ideally, the analysis and determination of underlying regularities should be an automated process. In fact, Hanson and Crutchfield (1992) have created a language for minimal deterministic finite automaton and use it for describing the attractor-basins within each cellular automaton. This language can be used to describe our example.

Sometimes, as in Figure 15.14a, these regions are obvious to the human viewer as invariant domains, that is, regions in which the same pattern recurs. We will label these domains as Λ values, and then filter out the invariant elements, in order to better describe the interactions or computations effected by the intersections of these domains. Table 15.4 describes three Λ regions: Λ^0 , the repeated 0s; Λ^1 , the repeated 1s; and Λ^2 , the repeated pattern 10001. There are other Λ domains in Figure 15.14a, but we now only discuss this subset.

Rule table:

neighborhood:	000	001	010	011	100	101	110	111
output bit:	0	0	0	1	0	1	1	1

Lattice

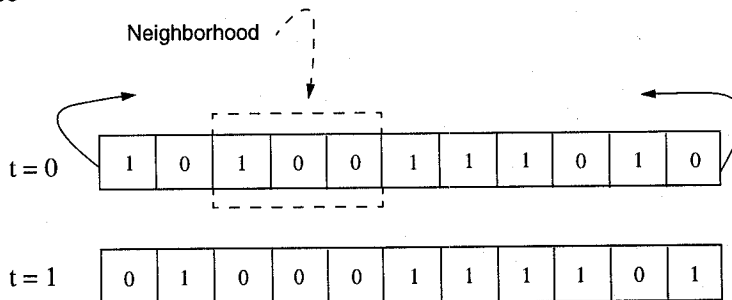

Figure 15.15 Illustration of a one-dimensional, binary-state, nearest-neighbor cellular automaton with $N = 11$. Both the lattice and the rule table for updating the lattice are illustrated. The lattice configuration is shown over one time step. The cellular automaton is circular in that the two end values are neighbors.

Regular Domains		
$\Lambda^0 = 0^*$	$\Lambda^1 = 1^*$	$\Lambda^2 = (10001)^*$
Particles (Velocities)		
$\alpha \sim \Lambda^1 \Lambda^0 (1)$	$\beta \sim \Lambda^0 \Lambda^1 (0)$	
$\gamma \sim \Lambda^2 \Lambda^0 (-2)$	$\delta \sim \Lambda^0 \Lambda^2 (1/2)$	
$\eta \sim \Lambda^2 \Lambda^1 (4/3)$	$\mu \sim \Lambda^1 \Lambda^2 (3)$	
Interactions		
decay	$\alpha \rightarrow \gamma + \mu$	
react	$\alpha + \delta \rightarrow \mu, \eta + \alpha \rightarrow \gamma, \mu + \gamma \rightarrow \alpha$	
annihilate	$\eta + \mu \rightarrow \emptyset_1, \gamma + \delta \rightarrow \emptyset_0$	

Table 15.4 Catalog of regular domains, particles (domain boundaries), particle velocities (in parentheses), and particle interactions of the space-time behavior of the CA of Figure 15.14a. The notation $p \sim \Lambda^x \Lambda^y$ means that p is the particle forming the boundary between regular domains Λ^x and Λ^y .

With the filtering out of invariant elements of the Λ domains, we can see the interactions of these domains. In Table 15.4, we describe the interaction of six Λ areas, for example, the particles at the frontiers of the Λ^1 and Λ^0 domains. The frontier, where the all 1 domain meets the all 0 domain, is called the *embedded particle* α . Crutchfield and Mitchell claim that the collection of embedded particles is a primary mechanism for carrying information (or signals) over long space-time continua. Logical operations on these particles or signals occur when they collide. Thus the collection of domains, domain walls, particles, and particle interactions for a CA represent the basic information-processing elements embedded in the CAs behavior, that is, the CA's intrinsic computation.

As an example, Figure 15.16 describes the emergent logic of Figure 15.14a. The Λ domain areas have been filtered of their invariant content to allow the domain wall particles to be easily observed. Each of the magnified regions of Figure 15.16 demonstrates the logic of two of the interacting embedded particles. The particle interaction $\alpha + \delta \rightarrow \mu$, shown in the upper right, implements the logic of mapping a spatial configuration representing signals α and δ into the signal μ . Similar detail is shown for the particle interaction $\mu + \gamma \rightarrow \alpha$, that maps a configuration representing μ and γ to the signal α . A more complete listing of the particle interactions of Figure 15.16 may be found in Table 15.4.

To summarize, an important result of the Crutchfield–Mitchell research is the discovery of methods for describing emergent computation within a spatially distributed system consisting of locally interacting cell processors. The locality of communication in

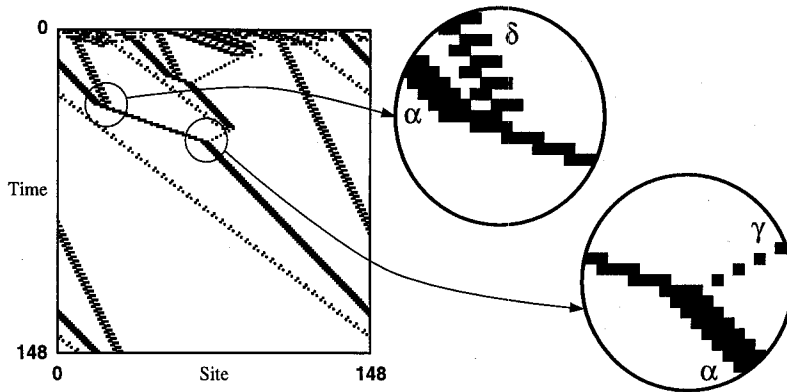

Figure 15.16 Analysis of the emergent logic for density classification of 15.14a. This CA has three domains, six particles, and six particle iterations, as noted in Table 15.3. The domains have been filtered out using an 18-state nonlinear transducer (figure adapted from Crutchfield and Mitchell, 1994).

the cells imposes a constraint of global communication. The role of the GAs is to discover local cell rules whose effect is to perform information processing over “large” space-time distances. Crutchfield and Mitchell have used ideas adopted from formal language theory to characterize these space-time patterns.

For Crutchfield and Mitchell, the result of the evolving automaton reflects an entirely new level of behavior that is distinct from the lower level interactions of the distributed cells. Global particle-based interactions demonstrate how complex coordination can emerge within a collection of simple individual actions. The result of the GA operating on local cell rules showed how an evolutionary process, by taking advantage of certain non-linear pattern-forming actions of cells, produced a new level of behavior and the delicate balance necessary for effective emergent computation.

The results of the Crutchfield–Mitchell research are important in that they have, with GA support, demonstrated the emergence of higher level invariances within a cellular automaton. Furthermore, they present computational tools, adapted from formal language theory, that can be used to describe these invariances. Continued research has the potential to elucidate the emergence of complexity: the defining characteristic of living things, and fundamental to understanding the origins of minds, species, and ecosystems.

15.4 Epilogue and References

Research on genetic algorithms and biology-based learning began with John Holland’s design of genetic algorithms. His early research includes *Adaptation in Natural and Artificial Systems* (1975) and *Escaping Brittleness: The possibilities of general purpose learning algorithms applied to parallel rule-based systems* (1986). This latter paper intro-

duces the *classifier system*. Some examples of work on the analysis of genetic systems can be found in Forrest and Mitchell (Forrest 1990, Mitchell 1996, Forrest & Mitchell 1993a, 1993b). Other researchers, especially Goldberg (1989), Mitchell (1996), and Koza (1992, 1994) have continued the formal analysis of genetic algorithms and learning.

As noted above, Holland (1986) was also responsible for the original design of classifier systems. Classifiers create a macro or complete-system viewpoint of learning. Another similar view is represented by the SOAR project (Rosenbloom and Newell 1987, Rosenbloom et al. 1993).

John Koza is the primary designer of the genetic programming research area. His major contributions are described in: *Genetic Programming: On the programming of computers by means of natural selection* (1992) and *Genetic Programming II: Automatic discovery of reusable programs* (1994). The example of using genetic programs to learn Kepler's Third Law, Section 15.2.2, was suggested by Mitchell (1996).

The Game of Life was originally presented by the mathematician John Horton Conway, but made famous by Martin Gardner's discussion of it in *Scientific American* (1970, 1971). Research in the computational power of finite state machines goes back to the design of the first digital computers. John von Neumann was very active in this research, and in fact was the first to show that the FSM had the computational power of Turing's Universal Machine. Most of von Neumann's early research is presented in the writings of Arthur Burks (1966, 1970, 1987). Other researchers (Hightower 1992, Koza 1992) describe how a-life research evolved from this early work on FSMs. Other researchers in artificial life include Langton (1986) and Ackley and Littmann (1992). Proceedings of the early a-life conferences were edited by Langton (1989, 1990).

Dennett, *Darwin's Dangerous Ideas* (1995), and other philosophers have addressed the importance of evolutionary concepts in philosophical thinking. We also recommend *Full House: The Spread of Excellence from Plato to Darwin* (Gould 1996).

Besides the brief descriptions of agent research in Section 15.3 (Brooks 1986, 1987, 1991a, b; Nilsson 1994; Benson and Nilsson 1996), there are many other projects in this domain, including Maes (1989, 1990) model of spreading activation in behavior networks, the extension of the blackboard architecture by Hayes-Roth et al. (1993) and others. The proceedings of the AAAI and IJCAI contain multiple articles from this important research domain. Crutchfield and Mitchell (1994) supported our presentation of Section 15.3.3.

15.5 Exercises

1. The genetic algorithm is intended to support the search for genetic diversity along with the survival of important skills (represented by genetic patterns) for a problem domain. Describe how different genetic operators can simultaneously support both these goals.
2. Discuss the problem of designing representations for genetic operators to search for solutions in different domains? What is the role of *inductive bias* here?
3. Consider the CNF-satisfaction problem of Section 15.1.3. How does the role of the number of disjuncts in the CNF expression bias the solution space? Consider other possible representations and genetic operators for the CNF-satisfaction problem. Can you design another fitness measure?

4. Build a genetic algorithm to solve the CNF-satisfaction problem.
5. Consider the traveling salesperson problem of Section 15.1.3. Discuss the problem of selecting an appropriate representation for this problem. Design other appropriate genetic operators and fitness measures for this problem.
6. Build a genetic algorithm to search for a solution for the traveling salesperson problem.
7. Discuss the role of representational techniques such as gray coding for shaping the search space for the genetic algorithm. Discuss two other problem domains where similar techniques will be important.
8. Read Holland's Schema Theorem (Mitchell 1996, Koza 1992). How does Holland's schema theory describe the evolution of the GA solution space? What does it have to say about problems not encoded as bit strings?
9. How does the Bucket Brigade Algorithm (Holland 1986) relate to the backpropagation algorithm (Section 14.3)?
10. Write a program to solve Kepler's Third Law of Motion Problem, described with a preliminary representation offered in Section 15.2.2.
11. Discuss the constraints (presented in Section 15.2.2) on using genetic programming techniques to solve problems. For example, what components of a solution cannot be evolved within the genetic programming paradigm?
12. Read the early discussion of the Game of Life in Gardner's column of *Scientific American* (1970, 1971). Discuss other a-life structures, similar to the *glider*, presented in Section 15.3.1.
13. Write an a-life program that implements the functionality of Figures 15.10 – 15.13.
14. The area of agent-based research was introduced in Section 15.3. We recommend further reading on any of the projects mentioned, but especially the Brooks, Nilsson and Benson, or Crutchfield and Mitchell research. Write a short paper on one of these topics.
15. Discuss the role of inductive bias in the representations, search strategies, and operators used in the models of learning presented in Chapter 15. Is this issue resolvable? That is, does the genetic model of learning work solely because of its representational assumptions or can it be translated into broader domains?
16. For further insights into evolution and the emergence of complexity, read and discuss *Darwin's Dangerous Idea* (Dennett 1995) or *Full House: The Spread of Excellence from Plato to Darwin* (Gould 1996).

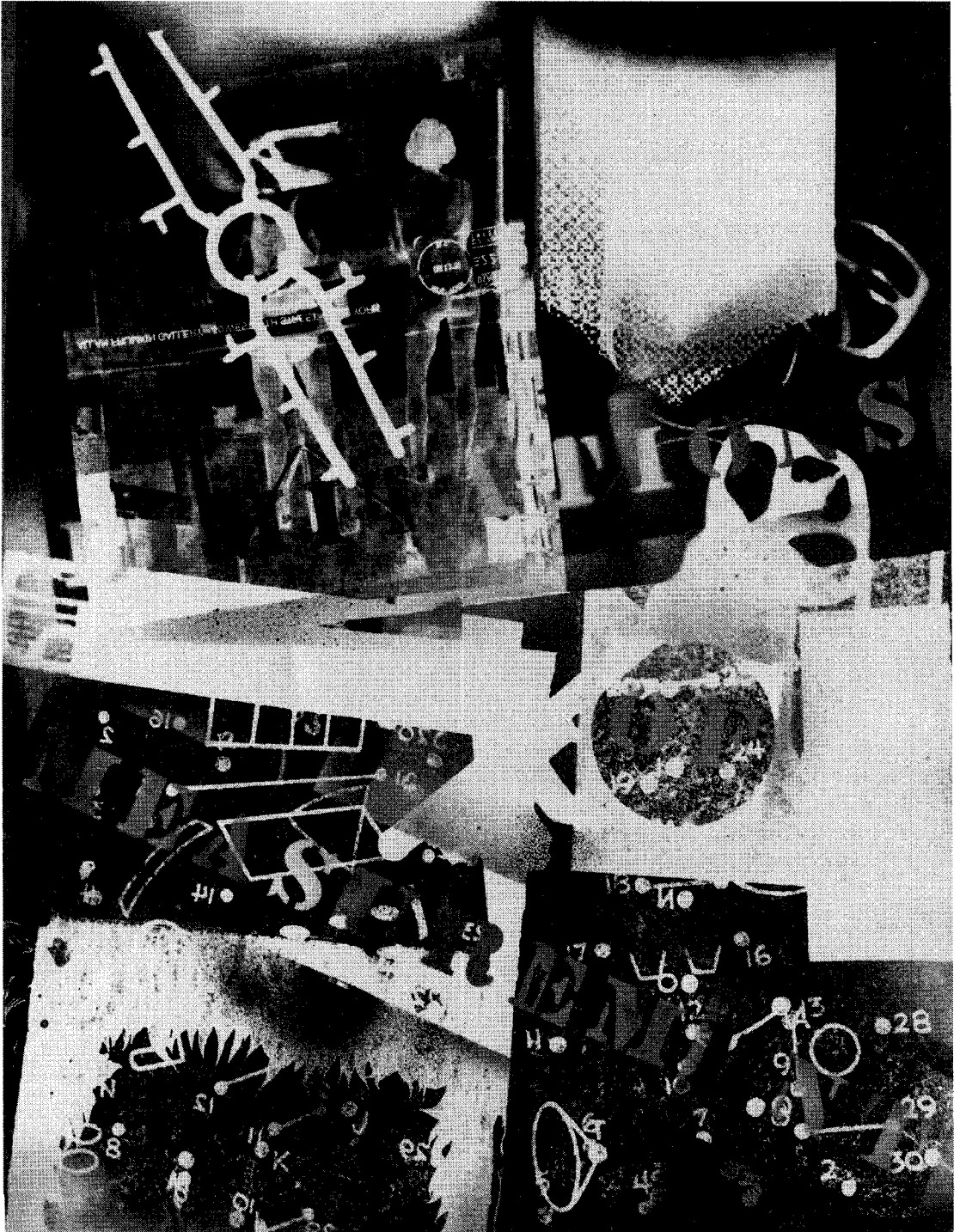

PART VI

EPILOGUE

The potential of computer science, if fully explored and developed, will take us to a higher plane of knowledge about the world. Computer science will assist us in gaining a greater understanding of intellectual processes. It will enhance our knowledge of the learning process, the thinking process, and the reasoning process. Computer science will provide models and conceptual tools for the cognitive sciences. Just as the physical sciences have dominated humanity's intellectual endeavors during this century as researchers explored the nature of matter and the beginning of the universe, today we are beginning the exploration of the intellectual universe of ideas, knowledge structures, and language. I foresee significant advances continuing to be made that will greatly alter our lives. The work Tarjan and I started in the 1970s has led to an understanding of data structures and how to manipulate them. Looking ahead, I can foresee an understanding of how to organize and manipulate knowledge.

—J. HOPCROFT, ACM Turing Award Lecture, 1987

*What is mind? No matter.
What is matter? Never mind.....*

—HOMER SIMPSON

It's what we learn after we know it all that is important.

—EARL WEAVER, Baltimore Orioles

Reflections on the Nature of Intelligence

Although this book has flirted with the larger philosophical implications of artificial intelligence, it has chiefly emphasized the engineering techniques used to build intelligent computer programs. In these final pages, we would like to return to those deeper issues, to consider the philosophical foundations of artificial intelligence, to re-evaluate the possibility of a science of intelligence using AI techniques, and to speculate on the future progress of artificial intelligence.

As we have noted throughout this text, research on human cognition and problem solving has made important contributions to the theory of artificial intelligence and the design of AI programs. In examining the foundations of AI, we would like to revive this eclectic spirit and consider such issues as the limits of symbolic representations, the importance of physical embodiment to mental processes and the role of culture in the growth and interpretation of knowledge. These questions lead us to deeper scientific and philosophical questions, such as those surrounding the falsifiability of models and the nature and capabilities of the scientific method itself. These observations lead us to argue for an interdisciplinary approach that couples work in AI with the findings of psychology, biology, anthropology, epistemology, and other fields that explore the full range of human thought and its products. We believe that by exploring both the intersections of these disciplines and the tensions between them, we can better understand the processes that underlie intelligence, whether in humans, animals, or machines.

Traditionally, work in artificial intelligence is based on the physical symbol system hypothesis (Newell and Simon 1976). Work in this tradition has produced increasingly sophisticated data structures and search strategies and led to many important successes both in creating tools that can achieve elements of intelligent behavior, and in illuminating the many components that make up human intelligence. Still, it is worth noting that "mainstream" AI rests on a number of assumptions, many of which derive from philosophical rationalism. As defined by the rationalist tradition, intelligence itself is largely a process of logical reasoning, scientific problem solving, and a straightforward, empirical approach to understanding the universe. Philosophical rationalism has constrained both the methods of artificial intelligence and the scope of its inquiry.

More recent developments in connectionist learning, agent-based problem solving, models of embodied intelligence, and situated action theories, as well as the insights of evolutionary computation and artificial life, offer much needed alternatives to this rationalist bias. By building on biological and social models of intelligence, they have demonstrated the limits of simple rationalism. By exploring the deeper problems of learning, they have traced the ambiguities, biases, and interpretive complexities underlying even the most straightforward empirical knowledge. They have shown that intelligence is very much a product of our bodies and senses, of our cultural and social institutions, of the art we have enjoyed and the stories we have been told. By establishing methods for building computer simulations of complex processes such as evolution or the adaptation of neural patterns in the human brain, these newer approaches have given AI a new and powerful set of tools to complement such traditional techniques as logical reasoning and state space search.

Artificial intelligence, like most of computer science, is a young field. Where physics and biology measure their progress across centuries, modern computing still reckons its age in decades. Much work needs to be done before we can integrate the findings of AI's different approaches into a unified science of intelligent action. We must let science and engineering, philosophy, and our aesthetic judgment lead us in our continuing creation of new scientific artifacts, which when used appropriately, offer insight into those mental processes we still do not fully understand.

ARTIFICIAL INTELLIGENCE AS EMPIRICAL ENQUIRY

16

Computer science is an empirical discipline. We would have called it an experimental science, but like astronomy, economics, and geology, some of its unique forms of observation and experience do not fit a narrow stereotype of the experimental method. Nonetheless, they are experiments. Each new machine that is built is an experiment. Actually constructing the machine poses a question to nature; and we listen for the answer by observing the machine in operation and analyzing it by all analytical and measurement means available. Each new program that is built is an experiment. It poses a question to nature, and its behavior offers clues to an answer. Neither machines nor programs are black boxes; they are artifacts that have been designed, both hardware and software, and we can open them up and look inside. We can relate their structure to their behavior and draw many lessons from a single experiment.

—A. NEWELL AND H. A. SIMON, ACM Turing Award Lecture, 1976

The study of thinking machines teaches us more about the brain than we can learn by introspective methods. Western man is externalizing himself in the form of gadgets.

—WILLIAM S. BURROUGHS, *Naked Lunch*

Where is the knowledge we have lost in information?

—T. S. ELIOT, *Choruses from the Rock*

16.0 Introduction

For many people, one of the most surprising aspects of work in artificial intelligence is the extent to which AI, and, indeed, much of computer science, turns out to be an empirical discipline. This is surprising, because most people initially think of these fields in terms of their mathematical, or alternatively their engineering, foundations. From the mathematical

viewpoint, there is the rationalist desire to bring standards of proof and analysis to the design of intelligent machines. From the engineering perspective, the task is often viewed as simply making successful artifacts that society wants to call "intelligent." Unfortunately (or fortunately, depending on your temperament and philosophy), the complexity of intelligent software and the ambiguity inherent in its interactions with the worlds of nature and human activity frustrate analysis from the mathematical or engineering perspectives. Rather, a mixture of analytic and empirical techniques are required. Each AI program can be viewed as an experiment: it proposes a question to the natural world and the results of running that program are nature's response. Nature's response to our design commitments shapes our understanding of formalism, mechanism, and intelligence.

Unlike the traditional study of human cognition, we as designers of intelligent computer programs can also inspect the internal workings of our subjects. We can stop program execution, examine internal state, and modify structure at will. As Newell and Simon note, the structure of computers and their programs indicates their potential behavior: they may be examined, and their representations and search algorithms understood. The power of computers as tools for understanding intelligence is a product of this duality: they are both capable of achieving levels of semantic and behavioral complexity that beg to be characterized in psychological terms and also offer an opportunity for a detailed inspection of their internal states that is largely denied scientists studying humans.

Techniques from AI also influence the design of practical computer applications. The excitement of AI is a result of its potential for solving important problems often thought to require human intelligence: delivering financial advice or medical care, configuring computers, troubleshooting hardware, assisting in the design of circuits and machines, controlling particle accelerators, and monitoring processes in factories and spaceflights.

In this final chapter we return to the questions asked in Chapter 1: What is intelligence? Can it be formalized? How can we build mechanisms that exhibit it? In Section 16.1 we begin with a revised definition of artificial intelligence and show how much current work in AI is rooted in the physical symbol system hypothesis of Newell and Simon. Then, we explore alternative approaches to questions of intelligence, and consider their potential for the design of intelligent machines. In Section 16.2 we show how the tools of AI may be used to better understand intelligence itself. The discipline that uses AI techniques to explore the nature of human intelligence is called *Cognitive Science*.

In Sections 16.3 and 16.4 we consider the philosophical foundations of intelligence. The traditional approach, *good old-fashioned AI*, is guilty of a rationalist reductionism: "We know intelligence and recognize it when we see it," is the mantra. "Our scripts, frames, and semantic networks are an exercise in building our expectations into our models." This is a natural bias of intelligence: what we see is a function of what we expect to see. Alternatively, the neural net, GA, and a-life researchers define the world from a Darwinian viewpoint: "What is, is what survives." Knowledge is "knowing how" in a complex situated world, rather than "knowing what." In these final sections, we discuss the future of AI by exploring the philosophical questions that must be addressed in a computational science of intelligence. There remain a number of fundamental limitations to our current understanding of intelligence, but as we will see, these are none other than the limitations of the empirical method itself: the current AI methodology is our best and only tool for exploring the nature of intelligence.

16.1 Artificial Intelligence: A Revised Definition

Based on our experience of the last 15 chapters, we offer a revised definition of artificial intelligence:

AI is the study of the mechanisms underlying intelligent behavior through the construction and evaluation of artifacts that enact those mechanisms.

Under this definition, artificial intelligence is less a theory about the mechanisms underlying intelligence than it is a methodology for constructing such a theory. It is a commitment to the scientific method of designing, running, and evaluating experiments with the goal of model refinement and further experiment. Most importantly, however, this definition, like the field of AI itself, directly attacks centuries of philosophical obscurantism about the nature of mind. It gives people who would understand what is perhaps our defining characteristic an alternative to religion, superstition, Cartesian dualism, new-age placebos, and the search for intelligence in some yet undiscovered quirk of quantum mechanics (Penrose 1989). If the science of artificial intelligence has made any contribution to human knowledge, it is in confirming that intelligence is not some mystic vapor permeating men and angels, but rather the effect of a set of general principles that can be understood and applied to the design of intelligent machines.

Historically, the dominant approach to artificial intelligence involves the construction of representational formalisms and the corresponding search-based reasoning mechanisms. The guiding principle of this representational AI methodology is the *physical symbol system* hypothesis, first articulated by Newell and Simon (1976). This hypothesis states that:

The necessary and sufficient condition for a physical system to exhibit general intelligent action is that it be a physical symbol system.

Sufficient means that intelligence can be achieved by any appropriately organized physical symbol system.

Necessary means that any agent that exhibits general intelligence must be an instance of a physical symbol system. The necessity of the physical symbol system hypothesis requires that any intelligent agent, whether human, space alien, or computer, achieve intelligence through the physical implementation of operations on symbol structures.

General intelligent action means the same scope of action seen in human action. Within physical limits, the system exhibits behavior appropriate to its ends and adaptive to the demands of its environment.

Both AI and cognitive science have explored the territory delineated by the physical symbol system hypothesis. Both have supported its conjectures and clarified its scope. Newell and Simon have summarized the arguments for both the *necessity* and *sufficiency* of the hypothesis (Newell and Simon 1976, Newell 1981, Simon 1981).

The physical symbol system hypothesis leads us to four significant methodological commitments: (a) the use of symbols and systems of symbols (representations) to describe the world; (b) the design of search mechanisms, especially heuristic search, to explore the space of potential inferences those symbol systems provide; (c) the disembodiment of

cognitive architecture, by which we mean that an appropriately designed symbol system can provide a full causal account of intelligence, regardless of its medium of implementation; and (d) the empirical view of computer programs as experiments. As an empirical science, AI takes a constructive approach: we attempt to understand intelligence by building a working model of it.

As the science of artificial intelligence has explored the ramifications of the physical symbol system hypothesis, it has developed its own challenges to this dominant view. Traditionally, artificial intelligence has been dominated by the effort to build symbolic reasoners that can solve problems that would be taken as evidence of intelligence in humans. However, as illustrated in the later chapters of this book, symbolic reasoning is not the only possible basis for intelligence. Models of computing based on the architecture of the animal brain and on the processes of biological evolution also provide possible frameworks for understanding intelligence in terms of scientifically knowable, empirically reproducible processes. The remainder of this section explores the ramifications of each of these approaches in turn.

16.1.1 Intelligence and the Physical Symbol System

Tokens in a formal language, referred to as *symbols*, can denote or reference something other than themselves. Like verbal tokens in a natural language, symbols can stand for or refer to other things in an intelligent agent's world of experience. Tarski demonstrated the possibility of a science of meaning in this object-referent relationship (Chapter 2).

AI's use of symbols goes beyond the questions addressed in Tarskian semantics, extending them to represent all forms of knowledge, skill, intention, and causality. However, all such constructive efforts rely on the fact that symbols, together with their semantics, can be embedded in formal systems. These define a *representation language*. This ability to formalize symbolic models of intelligence is essential to the modeling of intelligence as a running computer program. We have studied several representations in detail: the predicate calculus, semantic networks, scripts, conceptual graphs, frames, and objects. The mathematics of formal systems allows us to argue such issues as soundness, completeness, and the organization of knowledge.

The evolution of representational formalisms has allowed us to establish more complex (richer) semantic relationships. For example, inheritance systems constitute a semantic theory of taxonomic knowledge and its role in intelligence. By formally defining a model of class inheritance, such languages both simplify the construction of expert systems and provide testable models of the organization of categories in the human mind.

Closely bound to representational schemata and their use in reasoning is the notion of search. Search is the step-by-step examination of instances within the representational framework, looking for solutions, subproblem goals, problem symmetries, or whatever aspect of the problem is under consideration.

Representation and search are linked because a commitment to a particular representation determines a state space to be searched. Indeed, some problems can be made more difficult, or even impossible, through a poor choice of a representation language. The discussion of inductive bias in Part V illustrates this point.

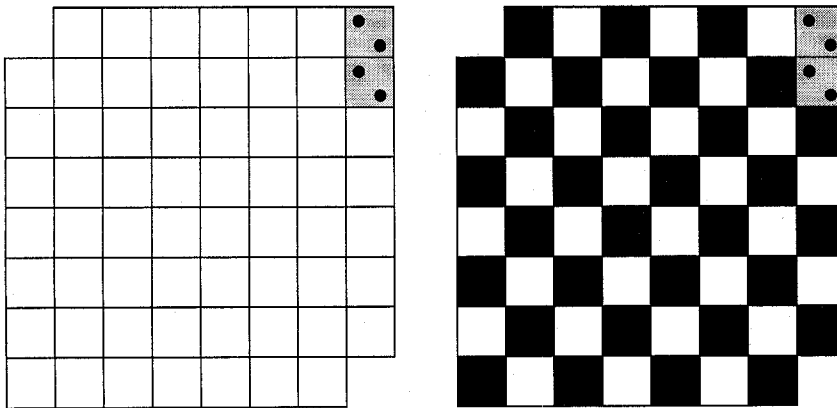

Figure 16.1 Truncated chessboard with two squares covered by a domino.

A dramatic and often cited example of the interplay between search and representation and the difficulty of choosing an appropriate representation is the problem of placing dominos on a truncated chessboard. Assume that we have a chessboard and a set of dominos such that each domino will cover exactly two squares of the board. Also, assume that the board has some missing squares; in Figure 16.1 the upper left-hand corner and lower right-hand corner have been truncated.

The truncated chessboard problem asks whether there is a way of placing dominos on the board so that each square is covered and each domino covers exactly two squares. We might try to solve the problem by trying all placements of dominos on the board; this is the obvious search-based approach and is a natural consequence of representing the board as a simple matrix, ignoring such seemingly irrelevant features as the color of squares. The complexity of such a search is enormous, and would require heuristics for an efficient solution. For example, we might prune partial solutions that leave single squares isolated. We could also start by solving the problem for a smaller board, such as 2×2 or 3×3 , and attempt to extend the solution to the 8×8 case.

A more sophisticated solution, and one that is often found by humans, would note that every placement of a domino must cover both a black and a white square. This truncated board has 32 black squares but only 30 white squares; thus, the desired placement is not possible. This raises a serious question for symbol-based reasoners: how could we design a representation that allows a problem solver to access knowledge with this degree of flexibility and creativity?

Heuristics are the third component, along with representation and search, of symbol-based AI. A heuristic is a mechanism for organizing search across the alternatives offered by a particular representation. Heuristics are designed to overcome the complexity of exhaustive search, the barrier to useful solutions for many classes of interesting problems. In computers, just as in humans, intelligence requires the informed choice of “what to do next.” Throughout the history of AI research, heuristics have taken many forms.

The earliest problem-solving techniques, such as *hill climbing* in Samuel’s checker-playing program (Chapter 4) or *means-ends analysis* in Newell, Shaw, and Simon’s Gen-

eral Problem Solver (Chapter 11), came into AI from other disciplines, such as *operations research*, and gradually matured into general techniques for AI problem solving. Search properties, including *admissibility*, *monotonicity*, and *informedness*, are important results from these early studies. These techniques are often referred to as *weak methods*. Weak methods were general search strategies intended to be applicable across entire classes of problem domains (Newell and Simon 1972, Ernst and Newell 1969). We saw these methods and their properties in Chapters 3, 4, and 11.

We introduced *strong methods* for AI problem solving with the rule-based expert system. In contrast to weak problem solvers, strong methods focus on the information specific to each problem area, such as internal medicine or integral calculus, rather than on designing heuristic methods that generalize across problem areas. Strong methods underlie expert systems and other knowledge-intensive approaches to problem solving. Strong methods emphasize such issues as the amount of knowledge needed for problem solving, learning and knowledge acquisition, the syntactic representation of knowledge, the management of uncertainty, and the quality of knowledge.

The amount of knowledge in a strong problem solver determines its power. An essential feature of human expertise in areas such as medicine, mathematics, or design is the fact that these humans know a lot of things. It has been estimated that a grandmaster chess player has on the order of 50,000 patterns guiding his or her play. The large amounts of knowledge required to solve realistic problems is a major obstacle to the design of strong problem solvers.

In spite of these problems, the power of large rule sets is now available in many expert system application programs. The computer configuration expert at Digital Equipment Corporation contains over 6,000 rules (Soloway et al. 1987). CYC (Lenat and Guha 1990) employs several hundred thousand rules in an attempt to represent commonsense knowledge of the world. CYC represents a valuable experiment on the possibility of symbolically representing commonsense knowledge. CYC has addressed a number of issues in knowledge representation, acquiring and integrating new knowledge, and the use of knowledge in continued learning. The large amounts of knowledge required for such problems represent a departure from the “toy” domains or microworld applications of much early AI research. Viable knowledge representation and problem-solving strategies must scale up in such large applications, effectively managing the combinatorics of growth.

A second source of heuristic power is the representation of individual rules and its effect on a program’s behavior. We saw in Chapters 2 and 12 that there are often several equivalent expressions for any predicate calculus relationship. For instance:

$$(A \vee B) \rightarrow C = \neg A \wedge \neg B \vee C = \dots$$

With the equivalence of various forms of the same relationship, the way the rule is presented is important for using it within a reasoning scheme, such as back chaining. Often the human expert can assist us in structuring rules and guiding inferences. Perhaps the most important of the human expert’s skills is the ability to pick the relevant issues from a myriad of possible alternatives and, focusing on the important details in data, use these to prune the search space and draw appropriate conclusions. We often try to mimic this skill in our rule- and object-based problem solving.

A third aspect of heuristic search in knowledge-based programs is the management of the uncertainty introduced by heuristic reasoning. A certainty factor measures the confidence the expert has in the rule. The use of an algebra for combining and propagating certainty measures is a weak heuristic method, in that it is a general method applicable to a number of problem domains. The assignment of certainty measures to rules in a particular condition-action form is part of a strong method, in that it represents a domain specific piece of knowledge. A more complete picture of reasoning under uncertain conditions was presented in Chapter 7.

Of course, as we saw in Chapter 6, the success of any knowledge-based system rests on the integrity of the knowledge base. The most difficult part of producing a knowledge-based program involves uniquely human skills: eliciting problem-solving skill from human experts, dealing with subtly interconnected and sometimes misleading descriptions, creating and maintaining the knowledge base, and adding, without inconsistencies, new knowledge. But when everything does come together, we are reminded again of Bacon's famous claim: *in knowledge is power!*

16.1.2 Minds, Brains, and Neural Computing

Perhaps the most significant alternative to the physical symbol system hypothesis has been brought by research into neural networks and other biologically inspired models of computing. Neural networks are computational, physically instantiable models of cognition that do not rely on symbols to describe the world. Because the knowledge in a neural network is distributed across the structure of the network, it is very difficult, if not impossible, to isolate individual concepts to specific regions of the network. A given portion of the network may be instrumental in the representation of many different concepts. Consequently, neural networks are a strong counter-example to at least the necessity clause of the physical symbol system hypothesis.

Neural networks shift the emphasis of artificial intelligence away from problems of symbolic representation and sound inference strategies to problems of learning and adaptation. Neural networks, like human beings and other animals, are mechanisms for adapting to the world: the structure of a trained neural network is shaped by learning, as much as by design. The intelligence of a neural network does not require that the world be recast in an explicit symbolic model. Rather, the network is shaped by its interactions with the world, replacing explicit models with the implicit traces of experience. This approach has made a number of contributions to our understanding of intelligence, giving us a plausible model of the mechanisms underlying the physical embodiment of mental processes, a more viable account of learning and development, a demonstration of the ability of simple, local rules of adaptation to shape a complex system in response to actual data, and a powerful research tool for cognitive neuroscientists.

Precisely because they are so different, neural nets can answer a number of questions that may be outside the expressive abilities of symbol-based AI. An important class of such questions concerns perception. Nature is not so generous as to deliver our perceptions as neat bundles of predicate calculus expressions. Neural networks offer a model of how we can recognize "meaningful" patterns in the chaos of sensory stimuli.

Because of their distributed representation, neural networks are often more robust than their symbolic counterparts. A properly trained neural network can effectively categorize completely novel instances, exhibiting a human-like perception of similarity rather than strict logical necessity. Similarly, the loss of a few neurons will not seriously compromise the performance of a large neural network. This results from the extensive redundancy inherent in the network model.

The most appealing aspect of neural networks is their ability to learn. Rather than attempting to construct a detailed symbolic model of the world, neural networks rely on the plasticity of their own structure to adapt directly to experience. They do not construct a model of the world so much as they are shaped by their experience within the world. We feel that learning is one of the most important aspects of intelligence. It is also the problem of learning that raises some of the hardest questions for work in neural computing.

One of the more difficult questions facing researchers in neural networks concerns the role of innate knowledge in learning. Can effective learning occur on a *tabula rasa*, or "blank slate," starting with no initial knowledge and learning entirely from experience; or must it start out with some prior inductive bias? Experience in the design of machine learning programs suggests that some sort of prior knowledge, usually expressed as an inductive bias, is necessary for learning in complex environments. This applies to neural networks as well as symbolic learning models: the ability of neural networks to converge on a meaningful generalization from a set of training data has proven sensitive to the number of artificial neurons, the network topology, and the specific learning algorithms used in training. Together, these factors constitute as strong an inductive bias as can be found in any symbolic representation. Research into human development supports this conclusion. There is increasing evidence that human infants inherit a range of "hard-wired" cognitive biases that enable the learning of concept domains such as language and commonsense physics. Characterizing innate biases in neural networks is an active area of research (Elman et al. 1996).

This problem becomes even harder if we consider more complex learning problems. For example, suppose we are developing a computational model of scientific discovery and want to model Copernicus' shift from a geocentric to heliocentric view of the universe. This requires that we represent both the Copernican and Ptolemaic views in a computer program. Although we could represent these views as patterns of activations in a neural network, our networks would tell us nothing about their behavior *as theories*. Instead, we prefer explanations such as "Copernicus was troubled by the complexity of the Ptolemaic system and preferred the simpler model of letting the planets revolve around the sun." Explanations such as this require symbols. Clearly, neural networks must be capable of supporting symbolic reasoning; after all, human beings are neural networks, and they seem to manipulate symbols tolerably well. Still, the neural foundation of symbolic reasoning is an important and open research problem.

Another problem is the role of development in learning. Human children cannot simply learn on the basis of available data. Their ability to learn in specific domains appears in well-defined developmental stages (Karmiloff-Smith 1992). An interesting question is whether this developmental progression is solely a result of human biology, or whether it reflects some logically necessary limits on the ability of an intelligence to learn about the world. Could developmental stages function as a mechanism for decomposing the problem

of learning about the world into more manageable subproblems? Might a series of artificially imposed developmental restrictions provide artificial networks with a necessary framework for learning about a complex world?

Agent-based computation and modular theories of cognition raise another set of research problems for work in neural networks. One important school of thought in cognitive science holds that the mind is organized into sets of specialized functional units, or modules (Minsky 1985, Fodor 1983). These modules are specialists. They employ a range of innate structures, from "hard-wired" problem solving to inductive biases, to account for the diversity of problems any practical intelligence must solve. This makes sense: how can a single neural network be trained to handle functions as diverse as perception, motor control, memory, and higher-level reasoning? Modular theories provide both a framework for answering these questions and a direction for continued research into such issues as the nature of innate biases in individual modules and the mechanisms of module interaction.

The application of neural networks to practical problems raises a number of additional research problems. The very properties of neural networks that make them so appealing, i.e., adaptability, sub-symbolic representation and robustness in light of missing or ambiguous data, also create problems for their practical application. Because networks are trained, rather than programmed, their behavior is difficult to predict. There are few solid guidelines for designing networks that will converge properly in a given problem domain. Explanations for the reasons a network arrived at a given conclusion are difficult to construct and often take the form of complex, statistical arguments. These are all areas of ongoing research.

Neural networks and symbolic AI are, it is clear, very different models of intelligence. Still, they share a number of important commonalities. Both are mathematical models of mind, and, as such, are fundamentally bounded by formal computational limits such as the Church/Turing hypothesis. Both approaches offer theoretical models of mind that have been shaped by application to practical problems. Most importantly, both approaches deny philosophical dualism and place the foundations of intelligence in the structure of physically realized computational systems.

We believe that a final reconciliation of these two very different approaches to intelligence is inevitable. When it is accomplished, a theory of how symbols reduce to patterns in a network and, in turn, influence future adaptation of that network, will be an extraordinary contribution, allowing a number of developments, such as integrating network-based perceptual and knowledge-based reasoning facilities into a single intelligence. In the meantime, however, both approaches have considerable work to do, and we see no reason they cannot co-exist for the foreseeable future. For researchers who may feel uncomfortable with two incommensurable models of intelligence, we point out that even physics functions quite well with the seemingly contradictory notion that light is sometimes best understood as a wave and sometimes as a particle.

16.1.3 Agents, Emergence, and Intelligence

Genetic and emergent models of computation (Holland 1995) provide one of the newest and most exciting approaches to understanding both human and artificial intelligence. By

demonstrating how globally intelligent behavior can arise from the cooperation of large numbers of restricted, independent, embodied, individual agents, genetic and emergent theories can address the issue of complex intelligence expressed in the interrelationships of relatively simple structures. The mechanisms that keep a large city, such as New York, supplied with bread demonstrate the fundamental processes underlying the emergence of intelligence in an agent-based system. It is unlikely that we could write a centralized planner that would successfully supply New Yorkers with the rich variety of daily breads to which they are accustomed. Indeed, the Communist world's unfortunate experiment with central planning revealed the limitations of such approaches. However, in spite of the practical impossibility of writing a centralized planning algorithm that will keep New York supplied with bread, the loosely coordinated efforts of the city's many bakers, truckers, suppliers of raw materials, and retailers, solve the problem quite nicely. As in all agent-based emergent systems, there is no central plan. No one baker has more than a very limited knowledge of the city's bread requirements; each baker simply tries to optimize his or her own business. The solution to the global problem emerges from the collective activities of these independent agents.

By demonstrating how highly goal-directed, robust, nearly optimal behaviors can arise from the interactions of simple individual agents, these models provide yet another answer to old philosophical questions of the origins of mind. The central lesson of emergent approaches to intelligence is that full intelligence can and does arise from the interactions of many simple, individual, embodied agents.

The second major feature of emergent models is their reliance on Darwinian selection as the basic mechanism that shapes the behavior of the individual agents. In the bakery example, it is obvious that individual bakers do behave in a manner that is, in some sense, close to optimal. The source of this optimality is not a central design; it is the simple fact that bakers who do a poor job of satisfying their customers generally fail. It is through the tireless, persistent operations of these selective pressures that individual bakers arrive at the behaviors that lead to their individual survival and a useful emergent behavior.

The combination of a distributed, agent-based architecture and the adaptive pressures of natural selection are a powerful model of the origins and operations of mind. Evolutionary psychologists (Cosmides and Tooby 1992, 1994; Barkow et al. 1992) have provided a model of the way in which natural selection has shaped the development of the innate structure and biases in the human mind. The basis of evolutionary psychology is a view of the mind as highly modular, as a system of interacting, highly specialized agents. Indeed, discussions of evolutionary psychology often compare the mind to a Swiss army knife, a collection of specialized tools that can be applied to solving different problems. There is increasing evidence that human minds are, indeed, highly modular. Fodor (1983) offers a philosophical argument for the modular structure of mind. Minsky (1985) has explored the ramifications of modular theories for artificial intelligence. This architecture is important to theories of the evolution of mind. It would be difficult to imagine how evolution could shape a single system as complex as a mind. It is, however, plausible that evolution, working over millions of years, could successively shape individual, specialized cognitive units. As evolution of the brain continued, it could also work on combinations of modules, forming the mechanisms that enable the modules to interact, to share information and to cooperate to perform increasingly complex cognitive tasks (Mithen 1996).

Theories of neuronal selection (Edelman 1992) show how these same processes can account for the adaptation of the individual neural network. Neural Darwinism models the adaptation of neural systems in Darwinian terms: the strengthening of particular circuits in the brain and the weakening of others is a process of selection in response to the world. In contrast to symbolic learning methods, which attempt to extract information from training data and use that information to build models of the world, theories of neuronal selection examine the effect of selective pressures on populations of neurons and their interactions. Edelman (1992, page 81) states:

In considering brain science as a science of recognition I am implying that recognition is not an instructive process. No direct information transfer occurs, just as none occurs in evolutionary or immune processes. Instead, recognition is selective.

Agent technologies offer models of social cooperation as well. Using agent-based approaches, economists have constructed informative (if not completely predictive) models of economic markets. Agent technologies have exerted an increasing influence on the design of distributed computing systems, the construction of internet search tools and implementation of cooperative work environments.

Agent-based models have exerted an influence on theories of consciousness. For example, Daniel Dennett (1991) has based an account of the function and structure of consciousness on an agent architecture of mind. He begins by arguing that it is incorrect to ask where consciousness is located in the mind/brain. Instead, his *multiple draft theory of consciousness* focuses on the role of consciousness in the interactions of agents in a distributed mental architecture. In the course of perception, motor control, problem solving, learning, and other mental activities, we form coalitions of interacting agents. These coalitions are highly dynamic, changing in response to the needs of different situations. Consciousness, for Dennett, serves as a binding mechanism for these coalitions, supporting agent interaction and raising critical coalitions of interacting agents to the foreground of cognitive processing.

Emergent approaches have opened up a number of problems that must be solved if their promise is to be realized. For example, we have yet to fill in all the steps that have enabled the evolution of higher-level cognitive abilities such as language. Like paleontologists' efforts to reconstruct the evolution of species, tracing the development of these higher level problems will take a great deal of additional detailed work. We must both enumerate the agents that underlie the architecture of mind and trace their evolution across time. Another important problem for agent-based theories is in explaining the interactions between modules. Although the "Swiss army knife" model of mind is a useful intuition builder, the modules that compose mind are not as independent as the blades of a pocket knife. Minds exhibit extensive, highly fluid interactions between cognitive domains: we can talk about things we see, indicating an interaction between visual and linguistic modules. We can construct buildings that enable a specific social purpose, indicating an interaction between technical and social intelligence. Poets can construct tactile metaphors for visual scenes, indicating a fluid interaction between visual and tactile modules. Defining the representations and processes that enable these inter-module interactions is an active area of research (Karmiloff-Smith 1992, Mithen 1996).

Practical applications of agent-based technologies are also becoming increasingly important. Using agent-based computer simulations, it is possible to model complex systems that have no closed-form mathematical description, and were heretofore impossible to study in this detail. Simulation-based techniques have been applied to a range of phenomena, such as the adaptation of the human immune system and the control of complex processes, including particle accelerators, the behavior of global currency markets, and the study of weather systems. The representational and computational issues that must be solved to implement such simulations continue to drive research in knowledge representation, algorithm design, and even the design of computer hardware.

Perhaps the most exciting aspect of emergent theories of mind is their potential for placing mental activities within a unified model of the emergence of order from chaos. Even the brief overview provided in this section has cited work using emergent theories to model a range of processes, from the evolution of the brain over time, to the forces that enable learning in individuals to the construction of economic and social models of behavior. There is something extraordinarily appealing in the notion that the same processes of emergent order as shaped by Darwinian processes can explain intelligent behavior at a variety of resolutions, from the interactions of individual neurons, to the shaping of the modular structure of the brain, to the functioning of economic markets and social systems. It is almost as if intelligence has a fractal geometry, where the same processes appear at whatever level of resolution we view the system.

16.1.4 Situated Actors and the Existential Mind

Symbolic reasoning, neural computing, and the various forms of emergent computation are the dominant approaches to modern artificial intelligence. Another line of thought that has influenced all of these approaches is exemplified by situated action theories of mind (Suchman 1987). Situated action theories argue that intelligence is not a result of manipulations on explicit models of the mind. Instead, it is best viewed in terms of actions taken by an agent that is situated in the world. As a metaphor for the difference between the two approaches, Lucy Suchman (1987) offers a comparison between European methods of navigation and less formal navigation methods such as practiced by the Trukese islanders. European navigation techniques require keeping track of the ship's location at every step of a voyage. To accomplish this, navigators rely on extensive, detailed models of world geography. In contrast, Trukese navigators, like many other native sailors, do not rely on charts and other tools to define their position at every step of a voyage. Instead, they use stars, winds, and currents to continue progress in the direction of their destination, improvising a route that responds more directly to the specific circumstances of their journey. Instead of relying on models of the world to pinpoint their position, Trukese navigators rely on their interaction with the world itself to reach their destination. Although they may not know their location at every moment of a voyage, they do reach their destination in a highly reliable, flexible fashion.

Situated action theories argue that we should not view intelligence as a process of building and evaluating models of the world, so much as a less structured process of acting in the world and responding to the results. This view places a great emphasis on our ability

to sense the world around us, to act purposefully and to respond quickly and continuously to changes in that world. It emphasizes the bodies and senses that situate us in the world over the higher level processes that reason about it. It places greater value on our ability to act than on our ability to explain those actions.

The influence of such a viewpoint on neural networks and agent-based approaches is obvious. It is at the heart of their rejection of general symbolic methods in favor of processes of adaptation and learning. Work in artificial life (Langton 1995) is perhaps the purest example of research that has been influenced by situated action theories. These models of mind have influenced the approach taken to robotics by Rodney Brooks (1989) and his associates. They argue that AI was mistaken in starting with higher level reasoning processes in modeling mind. This emphasis on logical reasoning took us down the wrong path, away from the underlying processes that enable an agent to be situated in the world and act productively in that world. Instead, Brooks has argued, we should begin by constructing and evaluating small, simple robots, creatures that operate at the level of insects but which enable us to study the processes by which both simple and complex creatures act in the world. After building a number of such simple robots, Brooks and his associates are attempting to apply the insights they have gained to the construction of COG, a more complex robot that is hoped to approach human capabilities.

However, situated action theory has also influenced symbolic approaches to AI. For example, work in reactive planning (Benson 1995, Benson and Nilsson 1995, Klein et al. 1997) has rejected traditional planning techniques that attempt to lay out a complete plan that will take an agent all the way from a starting state to a desired goal. Such plans rarely work properly, since there are simply too many errors or unanticipated problems that can occur along the way. Instead, reactive planning systems implement a cycle of constructing a partial plan, acting on that plan, and then reassessing the situation for new plans.

Situated action theories have also exerted a strong influence on human-computer interaction (Suchman 1987). Because they emphasize the importance of context and situatedness to intelligent action, they are able to provide software designers with a powerful model of the way in which humans will interact with computer programs.

Situated action theories seem to incorporate many of the ideas of existential philosophy. The existentialists held that people defined themselves through their actions in the world; what people believed (or professed to believe) was less important than what they did in critical situations. This emphasis on action is becoming increasingly important to artificial intelligence. Researchers have become aware of the importance of placing intelligent programs within an application domain, rather than cocooning them safely in a laboratory. This underlies a resurging interest in robotics and problems of perception. It is also reflected in the interest AI researchers have taken in the internet. There is considerable excitement in the design of Web agents, or "Softbots," programs that go out into the Web and perform useful, intelligent tasks. Much of the appeal of the Web to AI researchers is its ability to offer intelligent programs to a world that is far more complex than anything built in the laboratory, a world that equals the worlds of nature and society in complexity and a world that intelligent programs can inhabit without requiring bodies that can sense and act in a physical world.

We believe that situated action theories will continue to influence artificial intelligence, leading us to place greater emphasis on such issues as the importance of embodi-

ment to an intelligent agent, the influence of social, cultural, and economic factors on learning, and the way the world that an agent is situated within affects its evolution.

To summarize, the development of models of intelligence based on the empirical methods afforded by AI research supports understanding of intelligence as it exists in humans and animals. Next we examine *cognitive science* and its relationship to AI. In the final section we address theoretical limits of using AI tools to understand intelligence.

16.2 Cognitive Science: An Overview

It is not a coincidence that a major subgroup of the artificial intelligence community has focused its research on understanding *human* intelligence. Humans provide the best example of intelligent activity, and AI engineers, even though they are usually *not* committed to “making their programs act like humans,” seldom ignore the human’s solution. Some applications, such as delivering medical care, are deliberately modeled on the solution processes of human experts working in the area. Most importantly, understanding human intelligence is a fascinating and open scientific challenge in itself.

Modern cognitive science began with the advent of the digital computer, even though, as we saw in Chapter 1, there were many intellectual forebears of this discipline, from Aristotle through Descartes to more modern theorists such as Turing, McCulloch, and Pitts, the founders of the *neural net* model, and John von Neumann. The study became a science, however, with the ability to design and run experiments based on these theoretical notions; that is, with the arrival of the computer.

16.2.1 The Analysis of Human Performance

Early research in cognitive science examined human solutions to logic problems, simple games, planning, and concept learning. At the beginning of Chapter 12 we described the Logic Theorist, a program by Newell, Shaw, and Simon, that proved many of the theorems in Russell and Whitehead’s *Principia Mathematica*. Heuristic mechanisms, such as replacing a problem with a series of simpler subproblems, were used to manage the combinatorics involved in exhaustive search.

Coincident with their work on the Logic Theorist, Newell and Simon began to compare their computational heuristics with search strategies used by human subjects. Their data consisted of *think-aloud protocols*, descriptions by human subjects of their conscious thoughts during the process of devising a logic proof. Newell and Simon then compared these protocols with the behavior of the computer program solving the same problem. The researchers found remarkable similarities and interesting differences across both problems and subjects (Feigenbaum and Feldman 1963, Newell and Simon 1972, Simon 1981).

In the research that eventually led to the General Problem Solver (GPS), Newell and Simon proposed a theory of human problem solving and tested that theory with an implemented program. The difference reduction algorithm that compared two states of the problem and attempted to reduce the differences between them was called *means-ends*

analysis. The link between the differences in the states of the problem was the *table of connections*, that is, the problem-specific information that linked states of the problem solution. The table of connections allowed the solution to progress from state to state (see Section 12.1 and Figure 12.2).

Models for memory and concept learning also got attention early in the history of cognitive science. The work of Collins and Quillian on human associative memory, see Section 8.2, is an important example of this. The semantic network representation that resulted from this research has had a far-reaching influence on AI data structures.

During the period 1956 to 1964, Edward Feigenbaum and Herbert Simon developed a program called EPAM: Elementary Perceiver And Memorizer. This program modeled human rote learning of nonsense syllables, an area of research called *verbal learning behavior*. The task involves the memorization of syllables consisting of two constants with a vowel between them, such as JUK, JIR, DAX. These syllables are designed to be free of any meaning that might affect their encoding by the human. A data structure called a *discrimination net* was created by Feigenbaum and Simon that modeled the learning behavior of human subjects on this task (Feigenbaum 1963).

These early projects established the methodology that cognitive science would employ during the following decades:

1. Based on data from humans solving particular classes of problems, design a representational scheme and related search strategy for solving the problem.
2. Run this computer-based model to produce a trace of its problem-solving behavior.
3. Observe human subjects working on these problems and keep track of measurable parameters of their solution process, such as think-aloud protocols, eye movements, written partial results, or whatever might aid the researchers in understanding the solution process.
4. Analyze and compare the human and computer solutions.
5. Revise the computer model for the next test and comparison.

This approach closely reflects the empirical methodologies described in Newell and Simon's Turing Award Lecture (quoted at the beginning of this chapter); these are the methods that underlie science in general. An important aspect of cognitive science is the use of experiments to validate a problem-solving architecture, perhaps a production system or an architecture based on the interaction of distributed agents.

16.2.2 The Production System and Human Cognition

The production system is supported as a cognitive architecture by decades of research in a number of diverse application areas (Chapter 5, Newell and Simon 1972, Rosenbloom and Newell 1987, Rosenbloom et al. 1993). In viewing the production system as a model of human problem solving, the *production memory* takes the role of the human's long-term memory or permanent store of problem-solving skills; these might range from generating

moves in chess to delivering medical treatment. *Working memory* represents the human's short-term memory or attention. The *control mechanism*, matching the contents of working memory to the set of production rules, models the current focus of attention, triggering one or more of the skills represented as production rules. This, in turn, changes the focus of attention.

The production system offers an important link between strong and weak heuristic methods for problem solving. The division between the logic or knowledge and the control mechanism for using the knowledge allows focus either on the general (weak) heuristic methods as used in the control mechanism, or on the number and power of the production rules in the knowledge base (strong methods).

In recent years, a number of research projects have used the production system model to describe human problem-solving performance. Areas of research interest include:

Intelligent tutoring systems. If we conjecture that a person's problem-solving skills can be represented by a set of production rules, then errors in problem-solving efforts can be described by the absence, incorrectness, or misuse of one of these rules. Intelligent computer-aided instruction seeks to identify the missing or incorrect rule and then to teach the learner that skill or rule. This approach has been used in the areas of:

1. Teaching children subtraction skills (Brown and Burton 1978, Brown and VanLehn 1980).
2. Teaching skills in algebra problem solving (Sleeman and Smith 1981, Sleeman 1982).
3. Teaching concepts in debugging electronic circuits (Brown et al. 1982).
4. Teaching computer programming skills (Soloway et al. 1983, Johnson and Keravnou 1985, Anderson 1983*b*).
5. Teaching medical skills to doctors (Clancy 1983; Clancy and Shortliffe, 1984*a*).

Analysis of game-playing and problem-solving skills. A most thorough analysis of subjects solving cryptarithmic problems, playing chess, and proving theorems in the propositional calculus is found in Newell and Simon (1972). This early work influenced the design of the General Problem Solver (Section 12.1), as well as in supporting the production system as a viable model of human problem-solving performance. Simon and his colleagues (Simon 1975) have also studied subjects in the process of acquiring problem-solving skills on the task of solving the four- and five-ring tower of Hanoi problem and its isomorphs (Simon 1975, Luger and Bauer 1978).

Analysis of problem-solving skills in applied mathematics. This problem area includes human performance on distance rate time problems, moment of inertia problems, and energy problems (Hinsley et al. 1977, deKleer 1975, Novak 1977). Research at the University of Edinburgh showed that search strategies responsible for generating systems of simultaneous equations to represent the relationships within these problems could be produced with goal-driven search on a set of production rules, each representing potential relationships within the problem (Bundy et al. 1979, Luger 1981). Other work at Carnegie Mellon University characterized the knowledge, referred to as problem related schemata, that high school students possessed for successfully solving algebra word problems. Sev-

eral researchers constructed such schemata and tested them in computational models to determine their sufficiency for the problem-solving task (Hinsley et al. 1977, Luger 1981). Genesereth has created a consultation program for MACSYMA users (Genesereth 1982).

Comparisons of novices' and experts' problem-solving skills. These studies describe and compare skills within a particular problem area, such as the differences between the novice and expert problem solver in physics (Larkin et al. 1980) or in solving algebra word problems (Simon and Simon 1978). Studying these novice/expert differences can lead to better designs for rule bases or object specifications for expert systems, as well as offering suggestions for teaching these skills in the classroom.

Modeling developmental skills. A related use of production rules or object representations is to describe the developmental stages of language or other skills. Piaget (1954, 1970), Anderson (1982), and others have shown how the human problem solver matures through distinct growth periods. Recognition, conservation, and use skills evolve through fixed invariant stages. These stages can be described at each level of development by precise algorithms, and then compared to better understand their evolution. These stages are studied for seriation tasks by Young (1976), for object permanence by Luger et al. (1984), and for language development Luger (1994).

The separation of knowledge and control and the modularity of the production rules make the production system ideally suited for experimentally modeling skilled problem-solving behavior, where altered results can be achieved by removing, adding, or simply changing the priority of the rules (Luger 1981, Neches et al. 1987). Alternatively, criticisms of this very simplicity, a number of which were mentioned in Chapters 8, 11, and Section 16.1 have led to more advanced representations for AI problem solving. These have also played an important role in modeling human performance.

The organization of memory is an important feature of human intelligence that is not fully explained by the production system. Human memory does not appear to be an unstructured collection of productions. Instead, it is organized into thematically related structures called *schemata* that enable a human to efficiently retrieve the knowledge that may be needed in a given context. Schemata also provide a reasonable source of default assumptions. There is also evidence that human memory exploits the organization of knowledge into class hierarchies. Such representations as semantic networks, frames, scripts, and objects provide formal models of this organization.

Research at Carnegie Mellon (Bhaskar and Simon 1977) used a schema-based representation to account for problem solving in applied mathematics. Researchers at the University of Edinburgh examined subjects solving classes of pulley problems. The result of this research was to simulate experts' search behavior and offer explicit information content for knowledge schemata (Bundy et al. 1979, Luger 1981, Stern and Luger 1996).

Research in English language understanding also used AI data structures to model human behavior. Simple tree hierarchies provided models for Linde's (1974) research on apartment descriptions and Grosz's (1977) work on task-based dialogues. Grosz's research is interesting in that she models performance in a complex task: working with an expert to build a pump. This interaction is modeled with a task-subtask hierarchy. More recently, Bayesian models has shed light on the patterns of human language (Section 11.4).

COBWEB (Section 13.6.3) addresses the problems of category formation and a family resemblance model of category structure. Though not intended as a model of human

categorization, it provides a plausible account of such human characteristics as base level category effects and the distribution of properties throughout a taxonomy. Lakoff (1987) offers an extensive survey of results on human category structure.

A number of researchers are attempting to model the full range of human perception, problem solving, and learning. This project offers an opportunity to integrate many of the issues that are too often addressed in a manner isolated from the rest of intellectual activity. This attempt at integrating models into a larger explanatory unit offers important constraints on its individual pieces as well as the total model.

ACT* (Anderson 1983*b*) is one of the first efforts to establish a complete theory of human cognition. ACT* combines declarative knowledge (semantic nets) with procedural knowledge (production rules). ACT* learns through *knowledge compilation*, a process of forming new procedures through the combination of existing production rules.

SOAR (Rosenbloom and Newell 1986, Newell et al. 1989) attempts to model human cognition through an extension of the production system architecture. SOAR solves problems by defining and searching a *problem space*. An important issue in the SOAR architecture is the management of attention across different problem spaces. It models learning through a mechanism called *chunking*, which is related to explanation-based learning. ACT* and SOAR are similar in attempting to provide a comprehensive account of intelligence in terms of a single uniform architecture.

An alternative approach, presented in Section 16.1, argues that a single architecture cannot account for all intelligent behavior. Instead, intelligence results from the cooperation of highly specialized agents. Minsky's (1985) *The Society of Mind* outlines such a model. In this model, mind consists of a collection of specialized agents; each agent contributes a particular ability to such tasks as understanding visual data, communicating in natural language, or high-level problem solving. Intelligence results from the cooperation of groups of these agents. Other proponents of this cooperating multi-agent view of mind include Selfridge (1959), Fodor (1983), Brooks (1989), and Dennett (1991).

Even with the help of powerful representation techniques and some impressive early successes, cognitive science is a discipline yet to reach its promise. Several deep issues that both support its power as well as plague its progress are presented in the final section.

16.3 Current Issues in Machine Learning

If you don't know where you are going, you will wind up somewhere else...

—YOGI BERRA

The development of artificial intelligence has been shaped by a number of important challenges and questions. Natural language understanding, planning, problem solving, and learning are all typical of those types of problems that capture some essential aspect of intelligent behavior. In the last three chapters of Part V, we introduced models for machine learning that touched on many issues in this interesting and dynamic area. We presented machine learning for three reasons:

First, we felt that by exploring at least one key problem area in artificial intelligence in some depth, we could give the reader a more honest, complete flavor of the practice of artificial intelligence at the leading edge of research. Second, advances in machine learning, particularly neural networks, genetic algorithms, and other emergent approaches, hold great potential for revolutionizing the field of AI. Finally, we find learning to be one of the most exciting areas of work in artificial intelligence.

However, in spite of this progress, learning remains one of the most difficult problems facing artificial intelligence. In this section, we discuss three important issues limiting our current research progress: first, the problem of generalization and overlearning, second, the role of “inductive bias” in learning, and third, the “empiricist’s dilemma” of understanding constraint-free evolution. The last two problems are related: The implicit inductive bias of many learning algorithms is an expression of the rationalists’ problem of being biased by expectations, that is, what we learn is a direct function of what we expect to learn. From the opposite viewpoint, as we saw in a-life research, there are very few *a priori* expectations of what is learned. Is it sufficient to say, “Build it and it will happen”? Or conversely, is Yogi Berra correct: “If you don’t know where you are going, you will wind up somewhere else...”? In the following paragraphs, we briefly address these issues.

The generalization problem

The examples we used to introduce the various learning models, symbol-based, connectionist, and emergent, were usually very constrained. For example, connectionist architectures often contained only a few nodes or one partial layer. This is appropriate in that the main learning laws can be adequately explained in the context of single neurons or partial layers. It can be very misleading in that neural net applications are usually considerably larger and the problem of scale is important. For instance, for backpropagation learning, a large number of training examples with larger networks is generally required to solve problems of any significant practical interest. Many researchers comment extensively on the matter of selecting appropriate numbers of input values, the ratio between input parameters and hidden nodes, and the training trials necessary before convergence can be expected (Hecht-Nielsen 1990, Zurada 1992, Freeman and Skapura 1991). In fact, other than acknowledging that these are difficult, important, and often open issues, this type of “engineering” discussion has not been addressed in our book. This same analysis is true for our presentation of GAs and symbol-based learning.

The quality and quantity of training data is an important issue for any learning algorithm. Without extensive built-in knowledge of a domain, a learning algorithm can be totally misled attempting to find patterns in noisy, insufficient, or bad data.

Another related problem is the issue of “sufficiency” in learning. When can we say our algorithms are sufficient for capturing the important constraints or invariants of a problem domain? Do we reserve a portion of our original data to test our learning algorithms? Does the amount of data we have relate to the quality of learning? Perhaps the sufficiency judgement is heuristic or aesthetic: we humans judge our algorithms as “good enough.”

Let us illustrate this generalization problem with an example, using backpropagation to induce a general function from a set of data points. Figure 16.2 might represent data points we are asking our algorithm to generalize from. The lines across this set of points

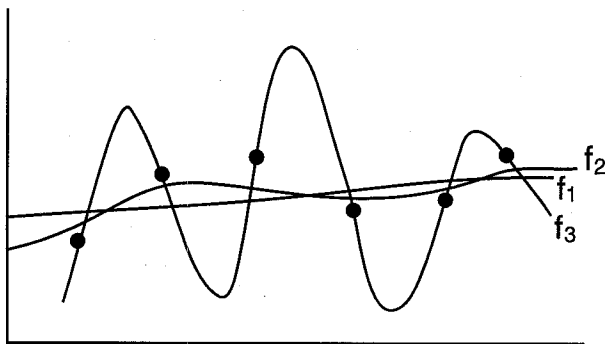

Figure 16.2 A set of data points and three function approximations.

represent functions induced by the learning algorithm. Remember that once the algorithm is trained we will want to offer it new data points and have the algorithm produce a good generalization for these data also.

The induced function f_1 might represent a fairly accurate least mean squares fit. With further training the system might produce f_2 , which seems a fairly “good” fit to the set of data points; but still, f_2 does not exactly capture the data points. Further training can produce functions that exactly fit the data but may offer terrible generalizations for further data. This phenomena is referred to as *overtraining* a network. One of the strengths of backpropagation learning is that in many application domains it is known to produce effective generalizations, that is, functional approximations which fit the training data well *and also* handle new data correctly. However, identifying the point where a network passes from an undertrained to an overtrained state is nontrivial. It is naive to think that one can present a neural network, or for that matter any other learning technique, with raw data and then simply step aside and watch while it produces the most effective and useful generalizations for its problem domain.

Research on parameters for problem and solution generalization continues.

Inductive bias, the rationalists' *a priori*

The automated learning techniques of Chapters 13 to 15 reflected the *a priori* biases of their creators. The problem of inductive bias is that the resulting representations and search strategies give us a medium for encoding an already interpreted world. They do not offer us mechanisms for questioning our interpretations, generating new viewpoints, or for backtracking and changing perspectives when they are unproductive. This implicit bias leads to the rationalist epistemological trap of seeing in the world exactly and only what we expect or are trained to see.

The role of inductive bias must be made explicit in each learning paradigm. (The alternative statement says that just because no inductive bias is acknowledged, that doesn't mean it does not exist and critically affect the parameters of learning.) In symbol-based

learning the inductive bias is usually obvious, for example, using a semantic net for concept learning. In Winston's (1975a) learning algorithms, biases include the conjunctive relationship representation and the importance of using "near misses" for constraint refinement. We see similar biases in the use of predicates in version space search, Section 13.1, decision trees in ID3, Section 13.3, or even rules for Meta-DENDRAL, Section 13.5.

As we have intimated throughout Chapters 14 and 15, however, many aspects of connectionist and genetic behavior also assume an inductive bias. For instance, the limitations of perceptron networks led to the introduction of hidden nodes. We may well ask what contribution the hidden nodes make in solution generation. One way of understanding what hidden nodes do is to note that they add dimensions to the representation space. As a simple example of this, we saw in Section 14.3.3 that the data points for the *exclusive-or* problem were not linearly separable in two dimensions. The learned weight on the hidden node, however, provides another dimension to the representation. In three-space, the points are separable using a two-dimensional plane. Given the two dimensions of the input space and the hidden node, the output layer of this network can then be seen as an ordinary perceptron, which is finding a plane which separates the points in three dimensions.

A complementary perspective is that many of the "different" learning paradigms shared (sometimes not obvious) common inductive biases. We pointed out many of these: the relationship between clustering with CLUSTER/2 in Section 13.5, the perceptron in Section 14.2, and prototype networks in Section 14.3. We noted that counterpropagation, the coupled network that uses unsupervised competitive learning on a Kohonen layer together with supervised Hebbian learning on a Grossberg layer, is in many ways similar to backpropagation learning. In counterpropagation, clustered data on the Kohonen layer play a role similar to the generalizations learned by the hidden nodes of backpropagation.

In many important ways, the tools we presented are similar. In fact, even the discovery of prototypes representing clusters of data offers the complementary case to function approximation. In the first situation, we are attempting to classify sets of data; in the second, we are generating functions that explicitly divide data clusters from each other. We saw this when the minimum distance classification algorithm used by the perceptron also gave the parameters defining the linear separation.

Even the generalizations that produce functions can be seen from many different viewpoints. Statistical techniques, for example, have for a long time been able to discover data correlations. Iterative expansion of Taylor series can be used to approximate most functions. Polynomial approximation algorithms have been used for over a century to approximate functions from data points.

The empiricist's dilemma

If the symbol-based approach to machine learning possesses a dominant inductive bias, the genetic and connectionist approaches have to grapple with the opposite problem, sometimes called *the empiricist's dilemma*. A constant theme of these research areas is that solutions will emerge, alternatives are evolved, or a solution reflects the survival of the fittest. This is powerful stuff, especially when it is situated in the context of parallel and distributed search power. But there remains a problem: How can we know we are someplace if we are not sure where we are going?

Plato long ago posed this problem in the words of the slave Meno (Plato 1961):

And how can you enquire, Socrates, into that which you do not already know? What will you put forth as the subject of the enquiry? And if you find out what you want, how will you ever know that this is what you did not know?

Perhaps the empiricist requires the remnants of an inductive bias to save the science!

Nonetheless, there is great excitement about connectionist and evolutionary models of learning, for example, in creating networks based on exemplars or energy minimization, which can be seen as fixed-point attractors or basins for complex relational invariances. We watch as data points “settle” toward attractors and are tempted to see these new architectures as tools for modeling dynamic phenomena. What, we might ask, are the limits of computation in these paradigms?

In fact, researchers have shown (Siegelman and Sontag 1991) that recurrent networks are computationally complete, that is, equivalent to the class of Turing Machines. This Turing equivalence extends earlier results: Kolmogorov (1957) showed that for any continuous function there exists a neural network that computes that function. It has also been shown that a one hidden-layer backpropagation network can approximate any of a more restricted class of continuous functions (Hecht-Nielsen 1989). Similarly, we saw in Section 15.3, that von Neumann created finite state automata that were Turing complete. Thus connectionist networks and finite state automata appear to be but two more classes of algorithms capable of computing virtually any computable function. It is how these paradigms are used that adds to their power and promise.

So what is it that the connectionist learning architectures or evolving finite state machines in their various forms offer us?

1. One of the most attractive features of connectionist learning is that most models are data or example driven. That is, they are not explicitly programmed, as are the symbol-based learning architectures. They learn by example, generalizing from data in a particular problem domain.
2. Genetic algorithms also support a powerful and flexible search of a problem space. Genetic search is driven both by the diversity enforced by mutation and by operators, such as crossover and inversion, that preserve important aspects of parental information for succeeding generations.
3. Both genetic algorithms and connectionist architectures may be viewed as instances of parallel asynchronous processing. They provide us with results achievable through parallel processing that we do not yet know how to produce using explicit sequential programming.
4. Even though the neural and sociological inspiration is not important for many modern practitioners of connectionist and genetic learning, these techniques do reflect many important aspects of human evolution. We saw models for error reduction learning with perceptron, backpropagation, and Hebbian models. We

also saw the autoassociative Hopfield nets in Section 14.3.4. Various models of evolution were reflected in the paradigms of Chapter 15.

5. Finally, all learning paradigms are tools for empirical enquiry. As we capture the invariants of our world, we can begin to ask further questions related to the nature of perception, understanding, learning, and problem solving.

There are a number of excellent books available now, many mentioned in the Epilogue and References sections of Chapters 13 – 15, that can take the reader deeper into any of the domains and issues we have introduced.

16.4 Understanding Intelligence: Issues and Directions

*like the geometer who strives
to square the circle and cannot find
by thinking the principle needed,*

was I at that new sight. . .

—DANTE, *Paradiso*

Although the use of AI techniques to solve practical problems has demonstrated its utility, the use of these techniques to found a general science of intelligence is a difficult and continuing problem. In this final section we return to the questions that led us to enter the field of artificial intelligence and to write this book: is it possible to give a formal, computational account of the processes that enable thought?

The computational characterization of intelligence begins with the abstract specification of computational devices. Research through the 1930s, 40s, and 50s began this task, with Turing, Post, Markov, and Church all contributing formalisms describing computation. The goal of this research was not just to specify what it meant to compute, but rather to specify limits on what could be computed. The Universal Turing Machine (Turing 1950), is the most commonly studied specification, although Post's rewrite rules, the basis for production system computing (Post 1943), are an important contribution. Church's model (1941), based on partially recursive functions, is also an important support for modern high-level functional languages, such as LISP, Scheme (Abelson and Sussman 1985), and Standard ML (Milner et al. 1990, Milner and Tofte 1991).

Theoreticians have proven that all of these formalisms have equivalent computational power in that any function computable by one is computable by the others. In fact, it is possible to show that the universal Turing machine is equivalent to any modern computational device. Based on these results, the Church–Turing thesis makes the even stronger argument that no model of computation can be defined which is more powerful than these known models. Once we establish equivalence of computational specifications, we have freed ourselves from the medium of mechanizing these specifications: we can implement

our algorithms with vacuum tubes, silicon, protoplasm, or tinker toys. The automated design in one medium can be seen as equivalent to mechanisms in another. This makes the empirical enquiry method even more critical, as we experiment in one medium to test our understanding of mechanism implemented in another.

One of the possibilities we are exploring is that the universal machine of Turing and Post may be too general. Paradoxically, intelligence may require a less powerful computational mechanism with more focused control. Levesque and Brachman (1985) have suggested that human intelligence may require more computationally efficient (although less expressive) representations, including the use of Horn clauses for reasoning, the restriction of factual knowledge to ground literals, and the use of computationally tractable truth maintenance systems. Our agent-based and emergent models of intelligence also seem to espouse this philosophy.

Another point addressed by the formal equivalence of our models of mechanism is the duality issue and the mind-body problem. At least since Descartes (see Section 1.1), philosophers have asked the question of the interaction and integration of mind, consciousness, and a physical body. Philosophers have offered every possible response, from total materialism to the denial of material existence, even to the supporting intervention of a benign god. AI and cognitive science research reject Cartesian dualism in favor of a material model of mind based on the physical implementation or instantiation of symbols, the formal specification of computational mechanisms for manipulating those symbols, the equivalence of representational paradigms, and the mechanization of knowledge and skill in embodied models. The success of this research is an indication of the validity of this model (Johnson-Laird 1988, Dennett 1987, Luger 1994).

Many consequential issues remain, however, within the epistemological foundations of intelligence in a physical system. We present several of these issues.

1. **Representational indeterminacy.** Anderson's representational indeterminacy conjecture (Anderson 1978) suggests that it may in principle be impossible to determine what representational scheme best approximates the human problem solver in the context of a particular act of skilled performance. This conjecture is founded on the fact that every representational scheme is inextricably linked to a larger computational architecture, as well as search strategies. In the detailed analysis of human skill, it may be impossible to control the process sufficiently so that we can determine the representation; or establish a representation to the point where a process might be uniquely determined. As with the uncertainty principle of physics, this is an important concern for constructing models of intelligence but need not limit their utility, as we show below.
2. **The assumptions of the physical symbol system hypothesis.** Newell and Simon hypothesized that the physical symbol system and its potential for search are necessary and sufficient explanations for intelligence (see Section 16.1). Many researchers in cognitive science take this hypothesis literally. In what sense may it be demonstrated? Or is it simply a conjecture necessary to support much of the research in the area? Are the successes of the neural or sub-symbolic models, and of the genetic and emergent approaches to intelligence refutations of the physical symbol hypothesis?

Even a weak interpretation of this hypothesis—that the physical symbol system is a *sufficient* model for intelligence—has produced many powerful and useful results in the modern field of cognitive psychology. What this argues is that we can implement physical symbol systems that will demonstrate intelligent behavior. Sufficiency allows creation and testing of symbol-based models for many aspects of human performance (Pylyshyn 1984, Posner 1989). But the strong interpretation—that the physical symbol system and search are *necessary* for intelligent activity—is open to question (Searle 1980, Weizenbaum 1976, Winograd and Flores 1986, Dreyfus and Dreyfus 1985, Penrose 1989).

3. **The role of embodiment in cognition.** One of the main assumptions of the physical symbol system hypothesis is that the particular instantiation of a physical symbol system is irrelevant to its performance; all that matters is its formal structure. This has been challenged by a number of thinkers (Searle 1980, Johnson 1987, Agre and Chapman 1987, Brooks 1989, Varela et al. 1993) who essentially argue that the requirements of intelligent action in the world require a physical embodiment that allows the agent to be fully situated in that world. The architecture of modern computers does not allow this degree of situatedness, requiring that an artificial intelligence interact with the world through the narrow straw provided by contemporary input and output devices. If this challenge is correct, then, although machine intelligence may be possible, it will require a very different sort of architecture than is afforded by contemporary computers.
4. **Culture and intelligence.** Traditionally, artificial intelligence has focused on the individual mind as the sole source of intelligence; we have acted as if an explanation of the way the brain encodes and manipulates knowledge would be a complete explanation of the origins of intelligence. However, we could also argue that knowledge can best be regarded as a social, rather than an individual, construct. It is possible that an understanding of the social context of knowledge and human behavior is just as important to a theory of intelligence as an understanding of the dynamics of the individual brain or the logical manipulation of predicate calculus expressions.
5. **The necessity of designing computational models that are falsifiable.** Popper (1959) and others have argued that scientific theories must be falsifiable. This means that there must exist circumstances under which the model is not a successful approximation of the phenomenon. The obvious reason for this is that *any* number of confirming experimental instances is not sufficient for confirmation of a model. Much research is done in response to the failure of existing theories.

The general nature of the physical symbol system hypothesis as well as situated and emergent models of intelligence may make them impossible to falsify and therefore of limited use as models. The same criticism can also be made of the conjectures of the phenomenological tradition (see point 6). Some AI data structures, such as the semantic network, are so general that they can model almost anything describable, or as with the universal Turing machine, any computable function. When a cognitive scientist is asked under what conditions his or

her model for intelligent activity does *not* work, the answer is often as difficult as determining the limitations of any scientific theory.

6. **Characterizing the nature of interpretation.** Most computational models in the representational tradition work with an already interpreted domain: that is, there is an implicit and *a priori* commitment of the system's designers to an interpretive context. Under this commitment there is little ability to shift contexts, goals, or representations as the problem solving evolves. Currently, there is also little effort at illuminating the process by which humans construct interpretations.

The Tarskian view of a semantic commitment as a mapping between symbols and objects is certainly too weak and doesn't explain, for example, the fact that one domain may have different interpretations in the light of different practical goals. Linguists generally try to remedy the limitations of Tarskian semantics by adding a theory of pragmatics (Austin 1962, and see Section 11.1). Research in discourse analysis, with its fundamental dependence on symbol use in context, has dealt with these issues extensively in recent years, although the problem is much broader in that it deals with the use and failure of referential tools in general (Lave 1988, Grosz and Sidner 1990).

The semiotic tradition started by C. S. Peirce (1958) and continued by Eco, Seboek, and others (Eco 1976, Grice 1975, Seboek 1985) takes a more radical approach to language. It places symbolic expressions within the wider context of signs and sign interpretation. This suggests that the meaning of a symbol can only be understood in the context of its role as interpretant, that is, in the context of an interpretation and interaction with the environment.

7. **The limitations of the scientific method.** A number of researchers (Winograd and Flores 1986, Weizenbaum 1976) claim that the most important aspects of intelligence are not and, in principle, cannot be modeled, and in particular not with a symbolic representation. These areas include learning, understanding natural language and the production of speech acts. Many of these issues have deep roots in philosophical tradition. Winograd and Flores's criticisms, for example, are based on issues raised in phenomenology (Husserl 1970, Heidegger 1962).

Most of the assumptions of modern AI can trace their roots back from Carnap, Frege, and Leibniz through Hobbes, Locke, and Hume to Aristotle. This tradition argues that intelligent processes conform to universal laws and are, in principle, understandable.

Heidegger and his followers represent an alternative approach to understanding intelligence. For Heidegger, reflective awareness is founded in a world of embodied experience (life-world). This position, shared by Winograd and Flores, Dreyfus, and others, argues that a person's understanding of things is rooted in the practical activity of coping with the everyday world. This world is essentially a context of socially organized roles and purposes. This context, and human functioning within it, is not something explained by propositions and understood by theorems. It is rather a flow that shapes and is itself continuously created. In a fundamental sense, human expertise is not knowing *that*, but rather, in a world of evolving social norms and implicit purposes, knowing *how*. We are inherently

unable to place our knowledge and most of our intelligent behavior into language, either formal or natural.

Let us consider this point of view. First, as a criticism of the *pure* rationalist tradition, it is correct. Rationalism asserts that all human activity, intelligence, and responsibility can, in principle at least, be represented, formalized, and understood. Most reflective people do not believe this to be the case, reserving important roles for emotion, self-affirmation and responsible commitment (at least!). Aristotle himself said, in his *Essay on Rational Action*, “Why is it that I don’t feel compelled to perform that which is entailed?” There are many human activities outside the realms of the scientific method that play an essential role in responsible human interaction; these cannot be reproduced by or abrogated to machines.

This being said, however, the scientific tradition of examining data, constructing models, running experiments, and examining results with model refinement for further experiments has brought an important level of understanding, explanation, and ability to predict to the human community. The scientific method is a powerful tool for increasing human understanding. Nonetheless, there remain a number of caveats to this approach that scientists must understand.

First, scientists must not confuse the model with the phenomenon being modeled. The model allows us to progressively approximate the phenomenon: there will, of necessity, always be a “residue” that is not empirically explained. In this sense also representational indeterminacy is *not* an issue. A model is used to explore, explain, and predict; and if it allows scientists to accomplish this it is successful (Kuhn 1962). Indeed, different models may successfully explain different aspects of a single phenomenon, for instance the wave and particle theories of light.

Furthermore, when researchers claim that aspects of intelligent phenomena are outside the scope and methods of the scientific tradition, this statement itself can be verified only by using that very tradition. The scientific method is the only tool we have for explaining in what sense issues may still be outside our current understanding. Every viewpoint, even that from the phenomenological tradition, if it is to have any meaning, must relate to our current notions of explanation—even to give a coherent explanation of the sense in which phenomena cannot be explained.

Perhaps the most exciting aspect of work in AI is that to be coherent and contribute to the endeavor we must address these issues. To understand problem solving, learning, and language we must comprehend the philosophical level of representations and knowledge. In a humbling way we are asked to resolve Aristotle’s tension between *theoria* and *praxis*, to fashion a union of understanding and practice, of the theoretical and practical, to live between science and art.

We are tool makers. Our representations, algorithms, and languages are tools for designing and building mechanisms that exhibit intelligent behavior. Through experiment we test both their computational adequacy for solving problems as well as our own understanding of our environment.

Indeed, we have a tradition of this: Hobbes, Leibniz, Descartes, Babbage, Turing, and others whose contributions we presented in Chapter 1. Engineering and philosophy, the nature of ideas, knowledge, and skill, the power and limitations of formalism and mechanism; these are the limitations and tensions with which we must live and from which we continue our explorations.

16.5 Epilogue and References

We refer the reader to the references at the end of Chapter 1 and add *Computation and Cognition* (Pylyshyn 1984) and *Understanding Computers and Cognition* (Winograd and Flores 1986). For issues in cognitive science see Norman (1981), Newell and Simon (1972), Posner (1989), Luger (1994), Ballard (1997), Franklin (1995), Jeannerod (1997), and Elman et al. (1996).

Haugeland (1981, 1997), Dennett (1978) and Smith (1996) describe the philosophical foundations of cognitive science. Anderson's book on cognitive psychology offers valuable examples of information processing models (Anderson 1990). Pylyshyn (1984) and Anderson (1978) give detailed descriptions of many critical issues in cognitive science, including a discussion of representational indeterminacy. Dennett (1991) applies the methodology of cognitive science to an exploration of the structure of consciousness itself. We also recommend books on the philosophy of science (Popper 1959, Kuhn 1962, Bechtel 1988; Hempel 1965, Lakatos 1976, Quine 1963).

We leave the reader with address information on two important groups:

The American Association for Artificial Intelligence
445 Burgess Drive
Menlo Park, CA 94025

Computer Professionals for Social Responsibility
P.O. Box 717
Palo Alto, CA 94301

BIBLIOGRAPHY

-
- Abelson, H., and Sussman, G. J. 1985. *Structure and Interpretation of Computer Programs*. Cambridge, MA: MIT Press.
- Ackley, D. H., Hinton, G. E., and Sejnowski, T. J. 1985. A learning algorithm for Boltzmann machines. *Cognitive Science* 9.
- Ackley, D. H. and Littman, M. 1992. Interactions between learning and evolution. In Langton et al. (1992).
- Agre, P. and Chapman, D. 1987. Pengi: an implementation of a theory of activity. *Proceedings of the Sixth National Conference on Artificial Intelligence*, pp. 268–272. CA: Morgan Kaufmann.
- Aho, A. V. and Ullman, J. D. 1977. *Principles of Compiler Design*. Reading, MA: Addison-Wesley.
- Allen, J. 1987. *Natural Language Understanding*. Menlo Park, CA: Benjamin/Cummings.
- Allen, J. 1995. *Natural Language Understanding*, 2nd ed. Menlo Park, CA: Benjamin/Cummings.
- Allen, J., Hendler, J., and Tate, A. 1990. *Readings in Planning*. Los Altos, CA: Morgan Kaufmann.
- Alty, J. L. and Coombs, M. J. 1984. *Expert Systems: Concepts and Examples*. Manchester: NCC Publications.
- Anderson, J. A., Silverstein, J. W., Ritz, S. A., and Jones, R. S. 1977. Distinctive features, categorical perception and probability learning: Some applications of a neural model. *Psychological Review*, 84:413–451.
- Anderson, J. R. 1978. Arguments concerning representations for mental imagery. *Psychological Review*, 85:249–277.
- Anderson, J. R. 1982. Acquisition of cognitive skill. *Psychological Review*, 89:369–406.
- Anderson, J. R. 1983a. Acquisition of proof skills in geometry. In Michalski et al. (1983).
- Anderson, J. R. 1983b. *The Architecture of Cognition*. Cambridge, MA: Harvard University Press.
- Anderson, J. R. 1990. *Cognitive Psychology and its Implications*. New York: W. H. Freeman.
- Anderson, J. R. and Bower, G. H. 1973. *Human Associative Memory*. Hillsdale, NJ: Erlbaum.
- Andrews, P. 1986. *An Introduction to Mathematical Logic and Type Theory: To Truth Through Proof*. New York: Academic Press.
- anon. Digitalk. 1986. *Smalltalk/V: Tutorial and Programming Handbook*. Los Angeles: Digitalk.
- Appelt, D. 1985. *Planning English Sentences*. London: Cambridge University Press.
- Arbib, M. 1966. Simple self-reproducing universal automata. *Information and Control* 9: 177–189.
- Aspray, W. and Burks, A. W., ed. 1987. *Papers of John Von Neumann on Computing and Computer Theory*. Cambridge, MA: MIT Press.
- Auer, P., Holte, R. C., and Maass, W. 1995. Theory and application of agnostic pac-learning with small decision trees. *Proceedings of the Twelfth International Conference on Machine Learning*, pp. 21–29. San Francisco: Morgan Kaufmann.

- Austin, J. L. 1962. *How to do Things with Words*, Cambridge, MA: Harvard University Press.
- Bach, E. and Harms, R., eds. 1968. *Universals of Linguistic Theory*. New York: Holt, Rinehart and Winston.
- Bachant, J. and McDermott, J. 1984. R1 revisited: Four years in the trenches. *AI Magazine* 5(3).
- Backus, J. 1978. Can programming be liberated from the Von Neumann style? A functional style and its algebra of programs, *Communications of the ACM*, 21(8):613-641.
- Ballard, D. 1997. *An Introduction to Natural Computation*. Cambridge, MA: MIT Press.
- Balzer, R., Erman, L. D., London, P. E., and Williams, C. 1980. HEARSAY III: A domain independent framework for expert systems. *Proceedings AAAI 1980*.
- Bareiss, E. R., Porter, B. W., and Weir, C. C. 1988. Protos: An exemplar-based learning apprentice. *International Journal of Man-Machine Studies*, 29:549-561.
- Barker, V. E. and O'Connor, D. E. 1989. Expert Systems for configuration at DIGITAL: XCON and Beyond. *Communications of the ACM*, 32(3):298-318.
- Barkow, J. H., Cosmides, L., and Tooby, J. 1992. *The Adapted Mind*. New York: Oxford Univ. Press.
- Barr, A. and Feigenbaum, E., eds. 1981. *Handbook of Artificial Intelligence*. Los Altos, CA: William Kaufman.
- Bartlett, F. 1932. *Remembering*. London: Cambridge University Press.
- Bateson, G. 1979. *Mind and Nature: A Necessary Unity*. New York: Dutton.
- Bechtel, W. 1988. *Philosophy of Mind*. Hillsdale, NJ: Lawrence Erlbaum.
- Benson, S. 1995. Action Model Learning and Action Execution in a Reactive Agent. *Proceedings of the International Joint Conference on Artificial Intelligence (IJCAI-95)*.
- Benson, S. and Nilsson, N. 1995. Reacting, Planning and Learning in an Autonomous Agent. *Machine Intelligence 14*. Edited by K. Furukawa, D. Michie, and S. Muggleton. Oxford: Clarendon Press.
- Berger, A., Brown, P., Della Pietra, S., Della Pietra, V., Gillett, J., Lafferty, J., Mercer, R., Printz, H., and Ures, L. 1994. The Candide System for Machine Translation. *Human Language Technology: Proceedings of the ARPA Workshop on Speech and Natural Language*. San Mateo, CA: Morgan Kaufmann.
- Bhaskar, R. and Simon, H. A. 1977. Problem solving in semantically rich domains. *Cog. Sci.* 1.
- Bledsoe, W. W. 1971. Splitting and reduction heuristics in automatic theorem proving. *Artificial Intelligence*, 2:55-77.
- Bledsoe, W. W. 1977. Non-resolution theorem proving. *Artificial Intelligence*, 9.
- Bobrow, D. G. 1975. Dimensions of representation. In Bobrow and Collins (1975).
- Bobrow, D. G. and Collins A., eds. 1975. *Representation and Understanding*. NY: Academic Press.
- Bobrow, D. G. and Winograd, T. 1977. An overview of KRL, a knowledge representation language. *Cognitive Science* 1(1).
- Boole, G. 1847. *The Mathematical Analysis of Logic*. Cambridge: MacMillan, Barclay & MacMillan.
- Boole, G. 1854. *An Investigation of the Laws of Thought*. London: Walton & Maberly.
- Boyer, R. S. and Moore, J. S. 1979. *A Computational Logic*. New York: Academic Press.
- Brachman, R. J. 1979. On the epistemological status of semantic networks. In Brachman and Levesque (1985).
- Brachman, R. J. 1985. I lied about the trees. *AI Magazine* 6(3).
- Brachman, R. J. and Levesque, H. J. 1985. *Readings in Knowledge Representation*. Los Altos, CA: Morgan Kaufmann.
- Brachman, R. J., Fikes, R. E., and Levesque, H. J. 1985. KRYPTON: A functional approach to knowledge representation. In Brachman and Levesque (1985).
- Brachman, R. J., Levesque, H. J., and Reiter, R., ed. 1990. *Proceedings of the First International Conference on Principles of Knowledge Representation and Reasoning*, Los Altos, CA: Morgan Kaufmann.

- Breiman, L., Friedman, J., Olsen, R., and Stone, C. 1984. *Classification and Regression Trees*. Monterey, CA: Wadsworth.
- Brodie, M. L., Mylopoulos, J., and Schmidt, J. W. 1984. *On Conceptual Modeling*. New York: Springer-Verlag.
- Brooks, R. A. 1986. A robust layered control system for a mobile robot. *IEEE Journal of Robotics and Automation*, 4:14-23.
- Brooks, R. A. 1987. A hardware retargetable distributed layered architecture for mobile robot control. *Proceedings IEEE Robotics and Automation*, pp. 106-110. Raleigh, NC.
- Brooks R. A. 1989. A robot that walks: Emergent behaviors from a carefully evolved network. *Neural Computation* 1(2):253-262.
- Brooks, R. A. 1991a. Intelligence without reason. *Proceedings of IJCAI-91*, pp. 569-595. San Mateo, CA: Morgan Kaufmann.
- Brooks, R. A. 1991b. Challenges for complete creature architectures. In Meyer and Wilson 1991.
- Brown, J. S. and Burton, R. R. 1978. Diagnostic models for procedural bugs in basic mathematical skills. *Cognitive Science*, 2.
- Brown, J. S. and VanLehn, K. 1980. Repair theory: A generative theory of bugs in procedural skills. *Cognitive Science*, 4:379-426.
- Brown, J. S., Burton, R. R., and deKleer, J. 1982. Pedagogical, natural language and knowledge engineering techniques in SOPHIE. In Sleeman and Brown (1982).
- Brownston, L., Farrell, R., Kant E., and Martin, N. 1985. *Programming Expert Systems in OPS5: An Introduction to Rule-Based Programming*. Reading, MA: Addison-Wesley.
- Buchanan, B. G. and Mitchell, T. M. 1978. Model-directed learning of production rules. In Waterman and Hayes-Roth (1978).
- Buchanan, B. G. and Shortliffe, E. H. eds. 1984. *Rule-Based Expert Systems: The MYCIN Experiments of the Stanford Heuristic Programming Project*. Reading, MA: Addison-Wesley.
- Bundy, A. 1983. *Computer Modelling of Mathematical Reasoning*. New York: Academic Press.
- Bundy, A., Byrd, L., Luger, G., Mellish, C., Milne, R., and Palmer, M. 1979. Solving mechanics problems using meta-level inference. *Proceedings of IJCAI-1979*, pp. 1017-1027.
- Bundy, A. and Welham, R. 1981. Using meta-level inference for selective application of multiple rewrite rules in algebraic manipulation, *Artificial Intelligence*, 16:189-212.
- Burks, A. W. 1966. *Theory of Self Reproducing Automata*. University of Illinois Press.
- Burks, A. W. 1970. *Essays on Cellular Automata*. University of Illinois Press.
- Burks, A. W. 1987. Von Neumann's self-reproducing automata. In Aspray and Burks (1987).
- Burstall, R. M. and Darlington, J. A. 1977. A transformational system for developing recursive programs. *JACM*, 24 (January).
- Burstein, M. 1986. Concept formation by incremental analogical reasoning and debugging. In Michalski et al. (1986).
- Carbonell, J. G. 1983. Learning by analogy: Formulating and generalizing plans from past experience. In Michalski et al. (1983).
- Carbonell, J. G. 1986. Derivational analogy: A theory of reconstructive problem solving and expertise acquisition. In Michalski et al. (1986).
- Carbonell, J. G., Michalski, R. S., and Mitchell, T. M. 1983. An Overview of Machine Learning. In Michalski et al. (1983).
- Carpenter, P. A. and Just, M. A. 1977. *Cognitive processes in Comprehension*. Hillsdale, NJ: Erlbaum.
- Ceccato, S. 1961. *Linguistic Analysis and Programming for Mechanical Translation*. New York: Gordon & Breach.
- Chang, C. L. and Lee, R. C. T. 1973. *Symbolic Logic and Mechanical Theorem Proving*. New York: Academic Press.

- Charniak, E. 1972. Toward a model of children's story comprehension. Report No. TR-266, AI Laboratory, MIT.
- Charniak, E. 1993. *Statistical Language Learning*. Cambridge, MA: MIT Press.
- Charniak, E., Hendrickson, C., Jacobson, N., and Perkowitz, M. 1993. Equations for Part-of-speech Tagging. *Proceedings of the Eleventh National Conference on Artificial Intelligence*. Menlo Park, CA: AAAI/MIT Press.
- Charniak, E. and McDermott, D. 1985. *Introduction to Artificial Intelligence*. Reading, MA: Addison-Wesley.
- Charniak, E., Riesbeck, C. K., McDermott, D. V., and Meehan, J. R. 1987. *Artificial Intelligence Programming*, 2nd ed. Hillsdale, NJ: Erlbaum.
- Charniak, E. and Shimony, S. 1990. Probabilistic Semantics for Cost Based Abduction. *Proceedings of the Eighth National Conference on Artificial Intelligence*, pp. 106–111. Menlo Park, CA: AAAI Press/ MIT Press.
- Charniak, E. and Wilks, Y. 1976. *Computational Semantics*. Amsterdam: North-Holland.
- Chomsky, N. 1965. *Aspects of the Theory of Syntax*. Cambridge, MA: MIT Press.
- Chorafas, D. N. 1990. *Knowledge Engineering*. New York: Van Nostrand Reinhold.
- Church, A. 1941. The calculi of lambda-conversion. *Annals of Mathematical Studies*. Vol. 6. Princeton: Princeton University Press.
- Churchland, P. S., 1986, *Neurophilosophy: Toward a Unified Science of the Mind/Brain*, Cambridge, MA: MIT Press.
- Clancy, W. J. 1983. The advantages of abstract control knowledge in expert system design. AAAI-3.
- Clancy, W. J. 1985. Heuristic Classification. *Artificial Intelligence*, 27:289–350.
- Clancy, W. J. and Shortliffe, E. H. 1984a. Introduction: Medical artificial intelligence programs. In Clancy and Shortliffe (1984b).
- Clancy, W. J. and Shortliffe, E. H., eds. 1984b. *Readings in Medical Artificial Intelligence: the First Decade*. Reading, MA: Addison Wesley.
- Clocksink, W. F. and Mellish, C. S. 1984. *Prog. in PROLOG*, 2nd ed. New York: Springer-Verlag.
- Codd, E. F. 1968. *Cellular Automata*. New York: Academic Press.
- Codd, E. F. 1992. Private communication to J. R. Koza. In Koza (1992).
- Cohen, P. R. and Feigenbaum, E. A. 1982. *The Handbook of Artificial Intelligence*. Vol. 3. Los Altos, CA: William Kaufmann.
- Cole, P. and Morgan, J. L. ed. 1975. *Studies in Syntax*. Vol. 3. New York: Academic Press.
- Collins A. and Quillian, M. R. 1969. Retrieval time from semantic memory. *Journal of Verbal Learning & Verbal Behavior*, 8:240–247.
- Colmerauer, A. 1975. Les Grammaires de Metamorphose, Groupe Intelligence Artificielle, Université Aix-Marseille II.
- Colmerauer, A., Kanoui, H., Pasero, R., and Roussel, P. 1973. *Un Systeme de Communication Homme-machine en Francais*. Research Report, Groupe Intelligence Artificielle, Université Aix-Marseille II, France.
- Coombs, M. J., ed. 1984. *Developments in Expert Systems*. New York: Academic Press.
- Cormen, T. H., Leiserson, C. E., and Rivest, R. J. 1990. *Introduction to Algorithms*. Cambridge, MA: MIT Press.
- Cosmides, L. and Tooby, J. 1992. Cognitive adaptations for social exchange. In Barkow et al. (1992)
- Cosmides, L. and Tooby, J. 1994. Origins of domain specificity: the evolution of functional organization. In Hirschfeld and Gelman (1994).
- Crick, F. H. and Asanuma, C. 1986. Certain aspects of the anatomy and physiology of the cerebral cortex. In McClelland et al. (1986).
- Crutchfield, J. P. and Mitchell, M. 1994. The Evolution of Emergent Computation. *Working Paper 94-03-012*. Santa Fe Institute.

- Dahl, V. 1977. Un Système Deductif d'Interrogation de Banques de Donnes en Espagnol, PhD thesis, Université Aix-Marseille.
- Dahl, V. and McCord, M. C. 1983. Treating Coordination in Logic Grammars. *American Journal of Computational Linguistics*, 9:69-91.
- Dallier, J. H. 1986. *Logic for Computer Science: Foundations of Automatic Theorem Proving*. New York: Harper & Row.
- Davis, E. 1990. *Representations of Commonsense Knowledge*. Los Altos, CA: Morgan Kaufmann.
- Davis, L. 1985. Applying Adaptive Algorithms to Epistatic Domains. *Proceedings of the International Joint Conference on Artificial Intelligence*, pp. 162-164.
- Davis, R. 1982. Applications of meta level knowledge to the construction, maintenance, and use of large knowledge bases. In Davis and Lenat (1982).
- Davis, R. and Lenat, D. B. 1982. *Knowledge-based Systems in Artificial Intelligence*. New York: McGraw-Hill.
- Davis, R. and Hamscher, W. 1992. *Model-based Reasoning: Trouble Shooting*. In Hamscher et al. (1992).
- Davis, R., Shrobe, H., Hamscher, W., Wieckert, K., Shirley, M., and Polit, S. 1982. Diagnosis Based on Description of Structure and Function. *Proceedings of the National Conference on Artificial Intelligence*. Menlo Park, California: AAAI Press.
- DeJong, G. and Mooney, R. 1986. Explanation-based learning: An alternative view. *Machine Learning*, 1(2):145-176.
- deKleer, J. 1975. Qualitative and quantitative knowledge of classical mechanics. *Technical Report AI-TR-352*, AI Laboratory, MIT.
- deKleer, J. 1976. *Local methods for localizing faults in electronic circuits* (MIT AI Memo 394). Cambridge: MIT.
- deKleer, J. 1984. Choices without backtracking. *Proceedings of the Fourth National Conference on Artificial Intelligence*, Austin, TX, pp. 79-84. Menlo Park, CA: AAAI Press.
- deKleer, J. 1986. An assumption based truth maintenance system, *Artificial Intelligence*, 28.
- Dempster, A. P. 1968. A generalization of Bayesian inference. *Journal of the Royal Statistical Society*, 30 (Series B):1-38.
- Dennett, D. C. 1978. *Brainstorms: Philosophical Essays on Mind and Psychology*. Montgomery, AL: Bradford.
- Dennett, D. C. 1984. *Elbow Room: The Varieties of Free Will Worth Wanting*. London: Cambridge University Press.
- Dennett, D. C. 1987. *The Intentional Stance*. Cambridge MA: MIT Press.
- Dennett, D. C. 1991. *Consciousness Explained*. Boston: Little, Brown.
- Dennett, D. C. 1995. *Darwin's Dangerous Idea: Evolution and the Meanings of Life*. New York: Simon & Schuster.
- Dietterich, T. G. 1986. Learning at the knowledge level. *Machine Learning*, 1(3):287-316.
- Dietterich, T. G. and Michalski, R. S. 1981. Inductive learning of structural descriptions: Evaluation criteria and comparative review of selected methods. *Proceedings IJCAI 6*.
- Dietterich, T. G. and Michalski, R. S. 1986. Learning to predict sequences. In Michalski et al. (1986).
- Doyle, J. 1979. A truth maintenance system. *Artificial Intelligence*, 12.
- Doyle, J. 1983. Some theories of reasoned assumptions: An essay in rational psychology. *Tech. Report CS-83-125*. Pittsburgh: Carnegie Mellon University.
- Dressler, O. 1988. An extended basic ATMS. *Proceedings of the Second International Workshop on Non-Monotonic Reasoning*, pp. 143-163. Edited by Reinfrank, deKleer, Ginsberg and Sandewall. Lecture Notes in Artificial Intelligence 346. Heidelberg: Springer-Verlag.
- Dreyfus, H. L. and Dreyfus, S. E. 1985. *Mind Over Machine*. New York: Macmillan/The Free Press.
- Druzdel, M. J. 1996. Qualitative Verbal Explanations in Bayesian Belief Networks. *AISB Quar.* 94.

- Druzdel, M. J. and Henrion, M. 1993. Efficient reasoning in qualitative probabilistic networks. *Proceedings of the 11th National Conference on Artificial Intelligence (AAAI-93)*, pp. 548–553.
- Duda, R. O., Gaschnig, J., and Hart, P. E. 1979a. Model design in the PROSPECTOR consultant system for mineral exploration. In Michie (1979).
- Duda, R. O., Hart, P. E., Konolige, K., and Reboh, R. 1979b. *A computer-based consultant for mineral exploration*. SRI International.
- Durkin, J. 1994. *Expert Systems: Design and Development*. New York: Macmillan.
- Eco, Umberto. 1976. *A Theory of Semiotics*. Bloomington, Indiana: University of Indiana Press.
- Edelman, G. M. 1992. *Bright Air, Brilliant Fire: On the Matter of the Mind*. Basic Books:New York.
- Elman, J. L., Bates, E. A., Johnson, M. A., Karmiloff-Smith, A., Parisi, D., and Plunkett, K. 1996. *Rethinking Innateness: A Connectionist Perspective on Development*. Camb., MA: MIT Press.
- Erman, L. D., Hayes-Roth, F., Lesser, V., and Reddy, D. 1980. The HEARSAY II speech understanding system: Integrating knowledge to resolve uncertainty. *Computing Surveys*, 12(2):213–253.
- Erman, L. D., London, P. E., and Fickas, S. F. 1981. The design and an example use of HEARSAY III. In *Proceedings IJCAI 7*.
- Ernst, G. W. and Newell, A. 1969. *GPS: A Case Study in Generality and Problem Solving*. New York: Academic Press.
- Etherington, D. W. and Reiter, R. 1983. On inheritance hierarchies with exceptions. *Proceedings AAAI-83*, pp. 104–108.
- Euler, L. 1735. The seven bridges of Konigsberg. In Newman (1956).
- Evans, T. G. 1968. A heuristic program to solve geometric analogy problems. In Minsky (1968).
- Falkenhainer, B. 1990. Explanation and theory formation. In Shrager and Langley (1990).
- Falkenhainer, B., Forbus, K. D., and Gentner, D. 1989. The structure mapping engine: Algorithm and examples. *Artificial Intelligence*, 41(1):1–64.
- Fass, D. and Wilks, Y. 1983. Preference semantics with ill-formedness and metaphor. *American Journal of Computational Linguistics IX*, pp. 178–187.
- Feigenbaum, E. A. 1963. The simulation of verbal learning behavior. In Feigenbaum and Feldman (1963).
- Feigenbaum, E. A., and Feldman, J., eds. 1963. *Computers and Thought*. New York: McGraw-Hill.
- Feigenbaum, E. A. and McCorduck, P. 1983. *The Fifth Generation: Artificial Intelligence and Japan's Computer Challenge to the World*. Reading, MA: Addison-Wesley.
- Fikes, R. E. and Nilsson, N. J. 1971. STRIPS: A new approach to the application of theorem proving to artificial intelligence. *Artificial Intelligence*, 1(2).
- Fikes, R. E., Hart, P. E., and Nilsson, N. J. 1972. Learning and executing generalized robot plans. *Artificial Intelligence*, 3(4):251–88.
- Fillmore, C. J. 1968. The case for case. In Bach and Harms (1968).
- Fisher, D. H. 1987. Knowledge acquisition via incremental conceptual clustering. *Machine Learning*, 2:139–172.
- Fisher, D. H., Pazzani, M. J., and Langley, P. 1991. *Concept Formation: Knowledge and Experience in Unsupervised Learning*. San Mateo, CA: Morgan Kaufmann Publishing.
- Fodor, J. A. 1983. *The Modularity of Mind*. Cambridge, MA: MIT Press.
- Forbus, K. D. and deKleer, J. 1988. Focusing the ATMS. *Proceedings of the Seventh National Conference on Artificial Intelligence*, pp. 193–198. Menlo Park, CA.
- Forbus, K. D. and deKleer, J. 1993. *Building Problem Solvers*. Cambridge, MA: MIT Press.
- Ford, K. M. and Hayes, P. J. 1995. Turing Test Considered Harmful. *Proceedings of International Joint Conference on Artificial Intelligence*, Montreal.
- Forgy, C. L. 1982. RETE: a fast algorithm for the many pattern/many object pattern match problem. *Artificial Intelligence*, 19(1):17–37.

- Forney, G. D., Jr. 1973. The Viterbi Algorithm. *Proceedings of the IEEE* (March), pp. 268-278.
- Forrest, S. 1990. Emergent Computation: Self-organizing, collective, and cooperative phenomena in natural and artificial computing networks. *Physica D*, 42:1-11.
- Forrest, S. and Mitchell, M. 1993a. What makes a problem hard for a genetic algorithm? Some anomalous results and their explanation. *Machine Learning*, 13:285-319.
- Forrest, S. and Mitchell, M. 1993b. Relative building block fitness and the building block hypothesis. In L. D. Whitley (1993).
- Franklin, S. 1995. *Artificial Minds*. Cambridge, MA: MIT Press.
- Freeman, J. A. and Skapura, D. M. 1991. *Neural Networks: Algorithms, Applications and Programming Techniques*. New York: Addison-Wesley.
- Frege, G. 1879. *Begriffsschrift, eine der arithmetischen nachgebildete Formelsprache des reinen Denkens*. Halle: L. Niebert.
- Frege, G. 1884. *Die Grundlagen der Arithmetik*. Breslau: W. Koerber.
- Gadamer, H. G. 1976. *Philosophical Hermeneutics*. Translated by D. E. Linge. Berkeley: University of California Press.
- Gallier, J. H. 1986. *Logic for Computer Science: Foundations of Automatic Theorem Proving*. New York: Harper and Row.
- Gardner, M. 1970. Mathematical Games. *Scientific American* (October 1970).
- Gardner, M. 1971. Mathematical Games. *Scientific American* (February 1971).
- Garey, M. and Johnson, D. 1979. *Computers and Intractability: A Guide to the Theory of NP-Completeness*. San Francisco: Freeman.
- Gazdar, G. and Mellish, C. 1989. *Natural Language Processing in PROLOG: An Introduction to Computational Linguistics*. Reading, MA: Addison-Wesley.
- Genesereth, M. and Nilsson, N. 1987. *Logical Foundations of Artificial Intelligence*. Los Altos, CA: Morgan Kaufmann.
- Genesereth, M. R. 1982. The role of plans in intelligent teaching systems. In Sleeman and Brown (1982).
- Gennari, J. H., Langley, P., and Fisher, D. 1989. Models of incremental concept formation. *Artificial Intelligence*, 40(1-3):11-62.
- Gentner, D. 1983. Structure-mapping: A theoretical framework for analogy. *Cognitive Science*, 7:155-170.
- Giarratano, J. and Riley. 1989. *Expert Systems: Principles and Programming*. PWS-Kent Publishing Co.
- Gluck, M. and Corter, J. 1985. Information, uncertainty and the utility of categories. *Seventh Annual Conference of the Cognitive Science Society in Irvine, Calif.*
- Glymour, C., Ford, K., and Hayes, P. 1995a. The Prehistory of Android Epistemology. In Glymour et al. (1995b).
- Glymour, C., Ford, K., and Hayes, P. 1995b. *Android Epistemology*. Menlo Park, CA: AAAI Press.
- Goldberg, A. and Robson, D. 1983. *Smalltalk 80: The Language and Its Implementation*. Reading, MA: Addison-Wesley.
- Goldberg, D. E. 1989. *Genetic Algorithms in Search, Optimization and Machine Learning*. Reading, MA: Addison-Wesley.
- Goldstine, H. H. 1972. *The Computer from Pascal to Von Neumann*. Princeton, NJ: Princeton University Press.
- Goodman, N. 1954. *Fact, Fiction and Forecast*, 4th ed. Cambridge, MA: Harvard University Press.
- Goodwin, J. 1982. An Improved Algorithm for Non-Monotonic Dependency Net Update. *Technical Report LITH-MAT-R-82-23*. Department of Computer Science and Information Science, Linköping University, Linköping, Sweden.
- Gould, S. J. 1996. *Full House: The Spread of Excellence from Plato to Darwin*. NY: Harmony Books.

- Graham, P. 1994. *On LISP: Advanced Techniques for Common LISP*. Englewood Cliffs, NJ: Prentice Hall.
- Grice, H. P. 1975. Logic and conversation. In Cole and Morgan (1975).
- Grossberg, S. 1976. Adaptive pattern classification and universal recoding. I. Parallel development and coding of neural feature detectors. *Biological Cybernetics*, 23:121-134.
- Grossberg, S. 1982. *Studies of Mind and Brain: Neural Principles of Learning, Perception, Development, Cognition and Motor Control*. Boston: Reidel Press.
- Grossberg, S., ed. 1988. *Neural Networks and Natural Intelligence*. Cambridge, MA: MIT Press.
- Grosz, B. 1977. The representation and use of focus in dialogue understanding. *PhD thesis*, University of California, Berkeley.
- Hall, R.P. 1989. Computational approaches to analogical reasoning: A comparative analysis, 39(1):39-120.
- Hammond, K., ed. 1989. *Case Based Reasoning Workshop*. San Mateo, CA: Morgan Kaufmann.
- Hamscher, W., Console, L., and deKleer, J. 1992. *Readings in Model-based Diagnosis*. San Mateo: Morgan Kaufmann.
- Hanson, J. E. and Crutchfield, J. P. 1992. The Attractor-basin portrait of a cellular automaton. *Journal of Statistical Physics*, 66(5/6):1415-1462.
- Harmon, P. and King, D. 1985. *Expert Systems: Artificial Intelligence in Business*. New York: Wiley.
- Harmon, P., Maus, R., and Morrissey, W. 1988. *Expert Systems: Tools and Applications*. New York: Wiley.
- Harris, M. D. 1985. *Introduction to Natural Language Processing*. Reston, VA: Reston.
- Hasemer, T. and Domingue, J. 1989. *Common LISP Programming for Artificial Intelligence*. Reading, MA: Addison-Wesley.
- Haugeland, J., ed. 1981. *Mind Design: Philosophy, Psychology, Artificial Intelligence*. Cambridge, MA: MIT.
- Haugeland, J. 1985. *Artificial Intelligence: the Very Idea*. Cambridge/Bradford, MA: MIT Press.
- Haugeland, J., ed. 1997. *Mind Design: Philosophy, Psychology, Artificial Intelligence*, 2nd ed. Cambridge, MA: MIT.
- Hausler, D. 1988. Quantifying inductive bias: AI learning algorithms and Valiant's learning framework. *Artificial Intelligence*, 36:177-222.
- Hayes, P. J. 1974. Some problems and non-problems in representation theory. *Proc. AISB Summer Conference*, pp. 63-69, University of Sussex.
- Hayes, P. J. 1977. In defense of logic. *Proceedings IJCAI-77*, pp. 559-564, Cambridge, MA.
- Hayes, P. J. 1979. The logic of frames. In Metzger (1979).
- Hayes-Roth, B., Pfeleger, K., Morignot, P., and Lalanda, P. 1993. Plans and Behavior in Intelligent Agents. *Technical Report, Knowledge Systems Laboratory (KSL-95-35)*.
- Hayes-Roth, F., and McDermott, J. 1983. An inference matching technique for inducing abstractions. *Communications of the ACM* 26:401-410.
- Hayes-Roth, F., Waterman, D., and Lenat, D. 1984. *Building Expert Systems*. Reading, MA: Addison-Wesley.
- Hebb, D. O. 1949. *The Organization of Behavior*. New York: Wiley.
- Hecht-Nielsen, R. 1982. Neural analog processing. *Proc. SPIE*, 360, pp. 180-189. Bellingham, WA.
- Hecht-Nielsen, R. 1987. Counterpropagation networks. *Applied Optics*, 26:4979-4984 (December 1987).
- Hecht-Nielsen, R. 1989. Theory of the backpropagation neural network. *Proceedings of the International Joint Conference on Neural Networks, I*, pp. 593-611. New York: IEEE Press.
- Hecht-Nielsen, R. 1990. *Neurocomputing*. New York: Addison-Wesley.
- Heidegger, M. 1962. *Being and Time*. Translated by J. Masquarrie and E. Robinson. New York: Harper & Row.

- Heidorn, G. E. 1975. Augmented phrase structure grammar. In Schank and Nash-Webber (1975).
- Helman, P. and Veroff, R. 1986. *Intermediate Problem Solving and Data Structures: Walls and Mirrors*. Menlo Park, CA: Benjamin/Cummings.
- Hempel, C. G. 1965. *Aspects of Scientific Explanation*. New York: The Free Press.
- Henderson, Peter. 1980. *Functional programming: Application and Implementation*. Englewood Cliffs NJ: Prentice-Hall.
- Hightower, R. 1992. *The Devore universal computer constructor*. Presentation at the Third Workshop on Artificial Life, Santa Fe, NM.
- Hillis, D. W. 1985. *The Connection Machine*. Cambridge: MIT Press.
- Hinsley, D., Hayes, J., and Simon, H. 1977. From words to equations: Meaning and representation in algebra word problems. In Carpenter and Just (1977).
- Hinton, G. E. and Sejnowski, T. J. 1986. Learning and relearning in Boltzmann machines. In McClelland et al. (1986).
- Hinton, G. E. and Sejnowski, T. J. 1987. Neural network architectures for AI. Tutorial, AAAI Conference.
- Hirschfeld, L. A. and Gelman, S. A., ed. 1994. *Mapping the Mind: Domain Specificity in Cognition and Culture*. Cambridge: Cambridge University Press.
- Hobbs, J. R. and Moore, R. C. 1985. *Formal Theories of the Commonsense World*. Norwood, NJ: Ablex.
- Hodges, A. 1983. *Alan Turing: The Enigma*. New York: Simon and Schuster.
- Holland, J. H. 1975. *Adaptation in Natural and Artificial Systems*. University of Michigan Press.
- Holland, J. H. 1976. Studies of the spontaneous emergence of self-replicating systems using cellular automata and formal grammars. In Lindenmayer and Rozenberg (1976).
- Holland, J. H. 1986. Escaping brittleness: The possibilities of general purpose learning algorithms applied to parallel rule-based systems. In Michalski et al. (1986).
- Holland, J. H. 1995. *Hidden Order: How Adaptation Builds Complexity*. Reading, MA: Addison-Wesley.
- Holland, J. H., Holyoak, K. J, Nisbett, R. E., and Thagard, P. R. 1986. *Induction: Processes of Inference, Learning and Discovery*. Cambridge, MA: MIT Press.
- Holyoak, K. J. 1985. The pragmatics of analogical transfer. *The Psychology of Learning and Motivation*, 19:59-87.
- Hopcroft, J. E. and Ullman, J. D. 1979. *Introduction to Automata Theory, Languages and Computation*. Reading, MA: Addison-Wesley.
- Hopfield, J. J. 1982. Neural networks and physical systems with emergent collective computational abilities. *Proceedings of the National Academy of Sciences* 79.
- Hopfield, J. J. 1984. Neural networks and physical systems with emergent collective computational abilities. *Proceedings of the National Academy of Sciences*, 79:2554-2558.
- Horowitz, E. and Sahni, S. 1978. *Fundamentals of Computer Algorithms*. Rockville, MD: Computer Science Press.
- Hume, D. 1748. *An Inquiry Concerning Human Understanding*. New York: Bobbs-Merrill.
- Husserl, E. 1970. *The Crisis of European Sciences and Transcendental Phenomenology*. Translated by D. Carr. Evanston, IL: Northwestern University Press.
- Husserl, E. 1972. *Ideas: General Introduction to Pure Phenomenology*. New York: Collier.
- Ignizio, J. P. 1991. *Introduction to Expert Systems: The Development and Implementation of Rule-Based Expert Systems*. New York: McGraw-Hill.
- Jackson, P. 1986. *Introduction to Expert Systems*. Reading, MA: Addison-Wesley.
- Jeannerod, M. 1997. *The Cognitive Neuroscience of Action*. Oxford: Blackwell.
- Johnson, L. and Keravnou, E. T. 1985. *Expert Systems Technology: A Guide*. Cambridge, MA: Abacus Press.

- Johnson, M. 1987. *The Body in the Mind: The Bodily Basis of Meaning, Imagination and Reason*. Chicago: University of Chicago Press.
- Johnson, W. L. and Soloway, E. 1985. Proust. *Byte* (April).
- Johnson-Laird, P. 1983. *Mental Models*. Cambridge, MA: Harvard University Press.
- Johnson-Laird, P. N. 1988. *The Computer and the Mind*. Cambridge, MA: Harvard University Press.
- Josephson, J. R. and Josephson, S. G., ed. 1994. *Abductive Inference: Computation, Philosophy and Technology*. New York: Cambridge University Press.
- Karmiloff-Smith, A., 1992. *Beyond Modularity: A Developmental Perspective on Cognitive Science*. Cambridge, MA: MIT Press.
- Kedar-Cabelli, S. T. 1988. Analogy – From a unified perspective. In Helman (1988).
- Kedar-Cabelli, S. T. and McCarty, L. T. 1987. Explanation based generalization as resolution theorem proving. *Proceedings of the Fourth International Workshop on Machine Learning*.
- Keravnou, E. T. and Johnson, L. 1986. *Competent Expert Systems: A Case Study in Fault Diagnosis*. London: Kegan Paul.
- King, S. H. 1991. *Knowledge Systems Through PROLOG*. Oxford: Oxford University Press.
- Klahr, D., Langley, P., and Neches, R., ed. 1987. *Production System Models of Learning and Development*. Cambridge, MA: MIT Press.
- Klahr, D. and Waterman, D. A. 1986. *Expert Systems: Techniques, Tools and Applications*. Reading, MA: Addison-Wesley.
- Klein, W. B., Westervelt, R. T., and Luger, G. F. 1997. A general purpose intelligent control system for particle accelerators. *Journal of Intelligent & Fuzzy Systems*. New York: John Wiley.
- Kodratoff, Y. and Michalski, R. S., ed. 1990. *Machine Learning: An Artificial Intelligence Approach*. Vol. 3. Los Altos, CA: Morgan Kaufmann.
- Kohonen, T. 1972. Correlation matrix memories, *IEEE Transactions Computers*, 4:353-359.
- Kohonen, T. 1984. *Self-Organization and Associative Memory*. Berlin: Springer-Verlag.
- Kolmogorov, A. N. 1957. On the representation of continuous functions of many variables by superposition of continuous functions of one variable and addition (in Russian). *Dokl. Akad. Nauk USSR*, 114:953-956.
- Kolodner, J. L. 1987. Extending problem solver capabilities through case based inference. *Proceedings of the Fourth International Workshop on Machine Learning*. CA: Morgan Kaufmann.
- Kolodner, J. L. 1988a. Retrieving events from a case memory: A parallel implementation. *Proceedings of the Case Based Reasoning Workshop*. Los Altos, CA: Morgan Kaufmann.
- Kolodner, J. L., ed. 1988b. *Case Based Reasoning Workshop*. San Mateo, CA: Morgan Kaufmann.
- Kolodner, J. L. 1991. Improving human decision making through case-based decision aiding. *AI Magazine*, 12(2):52-68.
- Kolodner, J. L. 1993. *Case-based Reasoning*. San Mateo, CA: Morgan Kaufmann.
- Korf, R. E. 1987. Search. In Shapiro (1987b).
- Kosko, B. 1988. Bidirectional associative memories. *IEEE Transactions Systems, Man & Cybernetics*, 18:49-60.
- Koton, P. 1988a. Reasoning about evidence in causal explanation. *Proceedings of AAAI-88*. Cambridge, MA: AAAI Press/MIT Press.
- Koton, P. 1988b. Integrating case-based and causal reasoning. *Proceedings of the Tenth Annual Conference of the Cognitive Science Society*. Northdale, NJ: Erlbaum.
- Kowalski, R. 1979a. Algorithm = Logic + Control. *Communications of the ACM*, 22:424-436.
- Kowalski, R. 1979b. *Logic for Problem Solving*. Amsterdam: North-Holland.
- Koza, J. R. 1991. Genetic evolution and co-evolution of computer programs. In Langton et al. (1991).
- Koza, J. R. 1992. *Genetic Programming: On the Programming of Computers by Means of Natural Selection*. Cambridge, MA: MIT Press.

- Koza, J. R. 1994. *Genetic Programming II: Automatic Discovery of Reusable Programs*. Cambridge, MA: MIT Press.
- Kuhn, T. S. 1962. *The Structure of Scientific Revolutions*. Chicago: University of Chicago Press.
- Laird, J., Rosenbloom, P., and Newell, A. 1986a. Chunking in SOAR: The Anatomy of a General Learning Mechanism. *Machine Learning* 1(1).
- Laird, J., Rosenbloom, P., and Newell, A. 1986b. *Universal Subgoaling and Chunking: The automatic Generation and Learning of Goal Hierarchies*. Dordrecht: Kluwer.
- Lakoff, G. 1987. *Women, Fire and Dangerous Things*. Chicago: University of Chicago Press.
- Lakatos, I. 1976. *Proofs and Refutations: The Logic of Mathematical Discovery*. Cambridge University Press.
- Langley, P., Bradshaw, G. L., and Simon, H. A. 1981. Bacon 5: The discovery of conservation laws. *Proceedings of the Seventh International Joint Conference on Artificial Intelligence*.
- Langley, P., Simon, H. A., Bradshaw, G. L., and Zytkow, J. M. 1987. *Scientific Discovery: Computational Explorations of the Creative Processes*. Cambridge, MA: MIT Press.
- Langley, P., Zytkow, J., Simon, H. A., and Bradshaw, G. L. 1986. The search for regularity: Four aspects of scientific discovery. In Michalski et al. (1986).
- Langton, C. G. 1986. Studying artificial life with cellular automata. *Physica D*, 120-149.
- Langton, C. G. 1989. *Artificial Life: Santa Fe Institute Studies in the Sciences of Complexity*, VI. Reading, MA: Addison-Wesley.
- Langton, C. 1990. Computation at the edge of chaos: Phase transitions and emergent computation. *Physica D*, 42:12-37.
- Langton, C. G. 1995. *Artificial Life: An Overview*. Cambridge, MA: MIT Press.
- Langton, C. G., Taylor, C., Farmer, J. D., and Rasmussen, S. 1992. *Artificial Life II, SFI Studies in the Sciences of Complexity*. Vol. 10. Reading, MA: Addison-Wesley.
- Larkin, J. H., McDermott, J., Simon, D.P., and Simon, H. A. 1980. Models of Competence in solving physics problems. *Cognitive Science*, 4.
- Lauritzen, S. L. and Spiegelhalter, D. J. 1988. Local computations with probabilities on graphical structures and their application to expert systems. *Journal of the Royal Statistical Society*, B 50(2):157-224.
- Lave, J. 1988. *Cognition in Practice*. Cambridge: Cambridge University Press.
- Leake, D. B. 1992. *Constructing Explanations: A Content Theory*. Northdale, NJ: Erlbaum.
- Leake, D. B., ed. 1996. *Case-based Reasoning: Experiences, Lessons and Future Directions*. Menlo Park: AAAI Press.
- Leibniz, G. W. 1887. *Philosophische Schriften*. Berlin.
- Lenat, D. B. 1977. On automated scientific theory formation: a case study using the AM program. *Machine Intelligence*, 9:251-256.
- Lenat, D. B. 1982. AM: an artificial intelligence approach to discovery in mathematics as heuristic search. In Davis and Lenat (1982).
- Lenat, D. B. 1983. EURISKO: A program that learns new heuristics. *Artificial Intelligence*, 21(1, 2):61-98.
- Lenat, D. B. and Brown, J. S. 1984. Why AM and Eurisko appear to work. *Artificial Intelligence*, 23(3).
- Lenat, D. B. and Guha, R. V. 1990. *Building Large Knowledge Based Systems*, Reading MA: Addison-Wesley.
- Lennon, J. and McCartney, P. 1968. Rocky Raccoon. *The White Album*. Apple Records.
- Lesser, V. R. and Corkill, D. D. 1983. The distributed vehicle monitoring testbed. *AI Magazine*, 4(3).
- Levesque, H. 1984. Foundations of a functional approach to knowledge representation. *Artificial Intelligence*, 23(2).

- Levesque, H. J. 1989. A knowledge level account of abduction. *Proceedings of the Eleventh International Joint Conference on Artificial Intelligence*, pp. 1051–1067. San Mateo, CA: Morgan Kaufman.
- Levesque, H. J. and Brachman, R. J. 1985. A fundamental tradeoff in knowledge representation and reasoning (revised version). In Brachman and Levesque (1985).
- Lifschitz, V. 1984. Some Results on Circumscription. *AAAI 1984*.
- Lifschitz, V. 1986. Pointwise Circumscription: Preliminary Report. *Proceedings of the Fifth National Conference on Artificial Intelligence*, pp. 406–410. Menlo Park, CA: AAAI Press.
- Linde, C. 1974. Information structures in discourse. *PhD thesis*, Columbia University.
- Lindenmayer, A. and Rosenberg, G., ed. 1976. *Automata, Languages, Development*. New York: North-Holland.
- Lindsay, R. K. Buchanan, B. G. Feigenbaum, E. A., and Lederberg, J. 1980. *Applications of artificial intelligence for organic chemistry: the DENDRAL project*. New York: McGraw-Hill.
- Lloyd, J. W. 1984. *Foundations of Logic Programming*. New York: Springer-Verlag.
- Lovelace, A. 1961. Notes upon L. F. Menabrea's sketch of the Analytical Engine invented by Charles Babbage. In Morrison and Morrison (1961).
- Loveland, D. W. 1978. *Automated Theorem Proving: a Logical Basis*. New York: North-Holland.
- Lucas, R. 1996. *Mastering PROLOG*. London: UCL Press.
- Luger, G. F. 1978. Formal analysis of problem solving behavior. in *Cognitive Psychology: Learning and Problem Solving*, Milton Keynes: Open University Press.
- Luger, G. F. 1981. Mathematical model building in the solution of mechanics problems: human protocols and the MECHO trace. *Cognitive Science*, 5:55–77.
- Luger, G. F., Wishart, J. G., and Bower, T. G. R. 1984. Modelling the stages of the identity theory of object-concept development in infancy. *Perception*, 13:97–115.
- Luger, G. F. 1994. *Cognitive Science: The Science of Intelligent Systems*. San Diego and New York: Academic Press.
- Luger, G. F. 1995. *Computation & Intelligence: Collected Readings*. CA: AAAI Press/MIT Press.
- Luger, G. F. and Bauer, M. A. 1978. Transfer effects in isomorphic problem solving. *Acta Psychologica*, 42.
- Machtey, M. and Young, P. 1979. *An Introduction to the General Theory of Algorithms*. Amsterdam: North-Holland.
- MacLennan, B. J. 1987. *Principles of Programming Languages: Design, Evaluation, and Implementation*, 2nd ed. New York: Holt, Rinehart & Winston.
- Maes, P. 1990. *Designing Autonomous Agents*. Cambridge, MA: MIT Press.
- Maes, P. 1989. The dynamics of action selection. *Proceedings of the 11th international Joint Conference on Artificial Intelligence*, pp. 991–997. Los Altos, CA: Morgan Kaufmann.
- Magerman, D. 1994. Natural Language as Statistical Pattern Recognition. *PhD dissertation*, Stanford University, Department of Computer Science.
- Maier, D. and Warren, D. S. 1988. *Computing with Logic*. Menlo Park, CA: Benjamin/Cummings.
- Malpas, J. 1987. *PROLOG: A Relational Language and its Applications*. Englewood Cliffs, NJ: Prentice Hall.
- Manna, Z. and Waldinger, R. 1985. *The Logical Basis for Computer Programming*. Reading, MA: Addison-Wesley.
- Marcus, M. 1980. *A Theory of Syntactic Recognition for Natural Language*. Camb., MA: MIT Press.
- Markov, A., 1954. A theory of algorithms, *National Academy of Sciences*, USSR.
- Martins, J. 1990. The Truth, the Whole Truth, and Nothing but the Truth: An Indexed Bibliography to the Literature on Truth Maintenance Systems. *AI Magazine*, 11(5):7-25.
- Martins, J. 1991. A structure for epistemic states. *New Directions for Intelligent Tutoring Systems*. Costa, ed. NATO ASI Series F. Heidelberg: Springer-Verlag.

- Martins, J. and Shapiro, S. C. 1983. Reasoning in multiple belief spaces. *Proceedings of the Eighth IJCAI*. San Mateo, CA: Morgan Kaufmann.
- Martins, J. and Shapiro, S. C. 1988. A Model for Belief Revision. *Artificial Intelligence*, 35(1), 25–79.
- Masterman, M. 1961. Semantic message detection for machine translation, using Interlingua. *Proceedings of the 1961 International Conference on Machine Translation*.
- McAllester, D. A. 1978. *A three-valued truth maintenance system*. MIT AI Lab., Memo 473.
- McCarthy, J. 1960. Recursive functions of symbolic expressions and their computation by machine. *Communications of the ACM*, 3(4).
- McCarthy, J. 1968. Programs with common sense. In Minsky (1968), pp. 403–418.
- McCarthy, J. 1977. Epistemological problems in artificial intelligence. *Proceedings IJCAI-77*, pp. 1038–1044.
- McCarthy, J. 1980. Circumscription – A form of non-monotonic reasoning. *Artificial Intelligence* 13.
- McCarthy, J. 1986. Applications of Circumscription to Formalizing Common Sense Knowledge. *Artificial Intelligence*, 28:89–116.
- McCarthy, J. and Hayes, P. J. 1969. Some philosophical problems from the standpoint of artificial intelligence. In Meltzer and Michie (1969).
- McClelland, J. L., Rumelhart, D. E., and The PDP Research Group. 1986. *Parallel Distributed Processing*. 2 vols. Cambridge, MA: MIT Press.
- McCord, M. C. 1982. Using slots and modifiers in logic grammars for natural language. *Artificial Intelligence*, 18:327–367.
- McCord, M. C. 1986. Design of a PROLOG based machine translation system. *Proceedings of the Third International Logic Programming Conference*, London.
- McCulloch, W. S. and Pitts, W. 1943. A logical calculus of the ideas immanent in nervous activity. *Bulletin of Mathematical Biophysics*, 5:115–133.
- McDermott, D. 1978. Planning and acting. *Cognitive Science* 2, 71–109.
- McDermott, D. and Doyle, J. 1980. Non-monotonic logic I. *Artificial Intelligence*, 13:14–72.
- McDermott, J. 1981. R1, The formative years. *AI Magazine* (summer 1981).
- McDermott, J. 1982. R1: A rule based configurer of computer systems. *Artificial Intelligence*, 19.
- McDermott, J. and Bachant, J. 1984. R1 revisited: Four years in the trenches. *AI Magazine*, 5(3).
- McGraw, K. L. and Harbison-Briggs, K. 1989. *Knowledge Acquisition: Principles and Guidelines*, Englewood Cliffs, N. J.: Prentice-Hall.
- Mead, C. 1989. *Analog VLSI and Neural Systems*. Reading, MA: Addison-Wesley.
- Meltzer, B. and Michie, D. 1969. *Machine Intelligence 4*. Edinburgh: Edinburgh University Press.
- Merleau-Ponty, M. 1962. *Phenomenology of Perception*. London: Routledge & Kegan Paul.
- Metzing, D., ed. 1979. *Frame Conceptions and Text Understanding*. Berlin: Walter de Gruyter and Co.
- Meyer, J. A. and Wilson, S. W., ed. 1991. *From animals to animats. Proceedings of the First International Conference on Simulation of Adaptive Behavior*. Cambridge, MA: MIT Press/Bradford Books.
- Michalski, R. S., Carbonell, J. G., and Mitchell, T. M., ed. 1983. *Machine Learning: An Artificial Intelligence Approach*. Vol. 1. Palo Alto, CA: Tioga.
- Michalski, R. S., Carbonell, J. G., and Mitchell, T. M., ed. 1986. *Machine Learning: An Artificial Intelligence Approach*. Vol. 2. Los Altos, CA: Morgan Kaufmann.
- Michalski, R. S. and Stepp, R. E. 1983. Learning from observation: conceptual clustering. In Michalski et al. (1983).
- Michie, D., ed. 1979. *Expert Systems in the Micro-electronic Age*. Edinburgh: Edinburgh Univ. Press.
- Milner, R., Tofte, M., and Harper, R. 1990. *Definition of Standard ML*. Cambridge, MA: MIT Press, 1990.

- Milner, R. and Tofte, M. 1991. *Commentary on Standard ML*, Cambridge, MA: MIT Press.
- Minsky, M. 1975. A framework for representing knowledge. In Brachman and Levesque (1985).
- Minsky, M. 1985. *The Society of Mind*, New York: Simon and Schuster.
- Minsky, M. and Papert, S. 1969. *Perceptrons: An Introduction to Computational Geometry*. Cambridge, MA: MIT Press.
- Minsky, M., ed. 1968. *Semantic Information Processing*. Cambridge, MA: MIT Press.
- Minton, S. 1988. *Learning Search Control Knowledge*. Dordrecht: Kluwer Academic Publishers.
- Mitchell, M. 1996. *An Introduction to Genetic Algorithms*. Cambridge, MA: The MIT Press.
- Mitchell, M., Crutchfield, J., and Das, R. 1996. Evolving cellular automata with genetic algorithms: A review of recent work. *Proceedings of the First International Conference on Evolutionary Computation and Its Applications*. Moscow, Russia: Russian Academy of Sciences.
- Mitchell, T. M. 1978. Version spaces: an approach to concept learning. *Report No. STAN-CS-78-711*, Computer Science Dept., Stanford University.
- Mitchell, T. M. 1979. An analysis of generalization as a search problem. *Proceedings IJCAI*, 6.
- Mitchell, T. M. 1980. The need for biases in learning generalizations. *Technical Report CBM-TR-177*. Department of Computer Science, Rutgers University, New Brunswick, NJ.
- Mitchell, T. M. 1982. Generalization as search. *Artificial Intelligence*, 18(2):203-226.
- Mitchell, T. M., Utgoff, P. E., and Banarji, R. 1983. Learning by experimentation: Acquiring and refining problem solving heuristics. In Michalski, Carbonell, and Mitchell (1983).
- Mitchell, T. M., Keller, R. M., and Kedar-Cabelli, S. T. 1986. Explanation-based generalization: A unifying view. *Machine Learning*, 1(1):47-80.
- Mithen, S. 1996. *The Prehistory of the Mind*. London: Thames & Hudson.
- Mockler, R. J. and Dologite, D. G. 1992. *An Introduction to Expert Systems*, New York: Macmillan.
- Moore, O. K. and Anderson, S. B. 1954. Modern logic and tasks for experiments on problem solving behavior. *Journal of Psychology*, 38:151-160.
- Moore, R. C. 1982. The role of logic in knowledge representation and commonsense reasoning. *Proceedings AAAI-82*.
- Moore, R. C. 1985. Semantical considerations on nonmonotonic logic. *Artificial Intelligence*, 25(1):75-94.
- Moret, B. M. E. and Shapiro, H. D. 1991. *Algorithms from P to NP*, vol 1. Redwood City, CA: Benjamin/Cummings.
- Morrison, P. & Morrison, E., ed. 1961. *Charles Babbage and His Calculating Machines*. NY: Dover.
- Mostow, D. J. 1983. Machine transformation of advice into a heuristic search procedure. In Michalski et al. (1983).
- Mycroft, A. and O'Keefe, R. A. 1984. A polymorphic type system for PROLOG. *Artificial Intelligence*, 23:295-307.
- Mylopoulos, J. and Levesque, H. J. 1984. An overview of knowledge representation in Brodie et al. (1984).
- Nagel, E. and Newman, J. R. 1958. *Godel's Proof*. New York: New York University Press.
- Neches, R., Langley, P. and Klahr, D. 1987. Learning, development and production systems. In Klahr et al. (1987).
- Negoita, C. 1985. *Expert Systems and Fuzzy Systems*. Menlo Park, CA: Benjamin/Cummings.
- Neves, J. C. F. M, Luger, G. F., and Carvalho, J. M. 1986. A formalism for views in a logic data base. In *Proceedings of the ACM Computer Science Conference*, Cincinnati, OH.
- Newell, A. 1981. Physical symbol systems. In Norman (1981).
- Newell, A. 1982. The knowledge level. *Artificial Intelligence*, 18(1):87-127.
- Newell, A. 1990. *Unified Theories of Cognition*. Cambridge, MA: Harvard University Press.
- Newell, A., Rosenbloom, P. S., and Laird, J. E. 1989. Symbolic architectures for cognition. In Posner (1989).

- Newell, A., Shaw, J. C., and Simon, H. A. 1958. Elements of a theory of human problem solving. *Psychological Review*, 65:151-166.
- Newell, A. and Simon, H. 1956. The logic theory machine. *IRE Transactions of Information Theory*, 2:61-79.
- Newell, A. and Simon, H. 1963a. Empirical explorations with the Logic Theory Machine: a case study in heuristics. In Feigenbaum and Feldman (1963).
- Newell, A. and Simon, H. 1963b. GPS: a program that simulates human thought. In Feigenbaum and Feldman (1963).
- Newell, A. and Simon, H. 1972. *Human Problem Solving*. Engelwood Cliffs, N. J.: Prentice Hall.
- Newell, A. and Simon, H. 1976. Computer science as empirical inquiry: symbols and search. *Communications of the ACM*, 19(3):113-126.
- Newman, J. R. 1956. *The World of Mathematics*. New York: Simon and Schuster.
- Ng, H. T. and Mooney, R. J. 1990. On the Role of Coherence in Abductive Explanation. *Proceedings of the Eighth National Conference on Artificial Intelligence*, pp. 347-342. Menlo Park, CA: AAAI Press/ MIT Press.
- Nii, H. P. 1986a. Blackboard systems: The blackboard model of problem solving and the evolution of blackboard architectures. *AI Magazine*, 7(2).
- Nii, H. P. 1986b. Blackboard systems: Blackboard application systems from a knowledge based perspective. *AI Magazine*, 7(3).
- Nii, H. P. and Aiello, N. 1979. AGE: A knowledge based program for building knowledge based programs. *Proceedings IJCAI 6*.
- Nilsson, N. J. 1965. *Learning Machines*. New York:Mcgraw-Hill.
- Nilsson, N. J. 1980. *Principles of Artificial Intelligence*. Palo Alto, CA: Tioga.
- Nilsson, N. J. 1994. Teleo-Reactive Programs for Agent Control. *Journal of Artificial Intelligence Research*, 1:139-158.
- Nordhausen, B. and Langley, P. 1990. An integrated approach to empirical discovery. In Shrager and Langley (1990).
- Norman, D. A. 1972. Memory, knowledge and the answering of questions. *CHIP Technical Report 25*, Center for Human Information Processing, University of California, San Diego.
- Norman, D. A. 1981. *Perspectives on Cognitive Science*. Hillsdale, NJ: Erlbaum.
- Norman, D. A., Rumelhart, D. E., and the LNR Research Group. 1975. *Explorations in Cognition*. San Francisco: Freeman.
- Novak, G. S. 1977. Computer understanding of physics problems stated in natural language. *Proceedings IJCAI 5*.
- Noyes, J. L. 1992. *Artificial Intelligence with Common LISP: Fundamentals of Symbolic and Numeric Computing*. Lexington, MA: D. C. Heath and Co.
- O'Keefe, R. 1990. *The Craft of PROLOG*. Cambridge, MA: MIT Press.
- Oliver, I. M., Smith, D. J., and Holland, J. R. C. 1987. A Study of Permutation Crossover Operators on the Traveling Salesman Problem. *Proceedings of the Second International Conference on Genetic Algorithms*, pp. 224-230. Hillsdale, NJ: Erlbaum & Assoc.
- Papert, S. 1980. *Mindstorms*. New York: Basic Books.
- Patil, R., Szolovits, P., and Schwartz, W. 1981. Causal understanding of patient illness in medical diagnosis. *Proceedings of the International Joint Conference on Artificial Intelligence*. Palo Alto: Morgan Kaufmann.
- Pearl, J. 1984. *Heuristics: Intelligent Strategies for Computer Problem Solving*. Reading, MA: Addison-Wesley.
- Pearl, J. 1988. *Probabilistic Reasoning in Intelligent Systems: Networks of Plausible Inference*. Los Altos, CA: Morgan Kaufmann.
- Peirce, C. S. 1958. *Collected Papers 1931-1958*. Cambridge MA:Harvard University Press.

- Penrose, R. 1989. *The Emperor's New Mind*. Oxford: Oxford University Press.
- Pereira, L. M. and Warren, D. H. D. 1980. Definite clause grammars for language analysis – A survey of the formalism and a comparison with augmented transition networks. *Artificial Intelligence*, 13:231–278.
- Perlis, D. 1988. Autocircumscription. *Artificial Intelligence*, 36:223–236.
- Piaget, J. 1954. *The Construction of Reality in The Child*. New York: Basic Books.
- Piaget, J. 1970. *Structuralism*. New York: Basic Books.
- Pinker, S. 1994. *The Language Instinct*. New York: William Morrow and Company.
- Polya, G. 1945. *How to Solve It*. Princeton, NJ: Princeton University Press.
- Popper, K. R. 1959. *The Logic of Scientific Discovery*. London: Hutchinson.
- Posner, M. I. 1989. *Foundations of Cognitive Science*. Cambridge, MA: MIT Press.
- Post, E. 1943. Formal reductions of the general combinatorial problem. *American Journal of Mathematics*, 65:197–268.
- Poundstone, W. 1985. *The Recursive Universe: Cosmic Complexity and the Limits of Scientific Knowledge*. New York: William Morrow and Company.
- Pratt, T. W. 1984. *Programming Languages: Design and Implementation*. Englewood Cliffs, N. J.: Prentice-Hall.
- Prerau, D. S. 1990. *Developing and Managing Expert Systems: Proven Techniques for Business and Industry*. Reading, MA: Addison-Wesley.
- Pylyshyn, Z. W. 1973. What the mind's eye tells the mind's brain: a critique of mental imagery. *Psychological Bulletin*, 80:1–24.
- Pylyshyn, Z. W. 1980. The causal power of machines. *Behavioral and Brain Sciences* 3:442–444.
- Pylyshyn, Z. W. 1984. *Computation and Cognition: Toward a Foundation for Cognitive Science*. Cambridge: MIT Press.
- Quillian, M. R. 1967. Word concepts: A theory and simulation of some basic semantic capabilities. In Brachman and Levesque (1985).
- Quine, W. V. O. 1963. *From a Logical Point of View*. 2nd Ed. New York: Harper Torchbooks.
- Quinlan, J. R. 1983. Learning efficient classification procedures and their application to chess end-games. In Michalski et al. (1983).
- Quinlan, J. R. 1986a. Induction of decision trees. *Machine Learning*, 1(1):81–106.
- Quinlan, J. R. 1986b. The effect of noise on concept learning. In Michalski et al. (1986).
- Quinlan, J. R. 1996. Bagging, Boosting and CN4.5. *Proceedings AAAI 96*. Menlo Park: AAAI Press.
- Quinlan, P. 1991. *Connectionism and Psychology*. Chicago, IL: University of Chicago Press.
- Raphael, B. 1968. SIR: A computer program for semantic information retrieval. In Minsky (1968).
- Reddy, D. R. 1976. Speech recognition by machine: A review. *Proceedings of the IEEE* 64 (May 1976).
- Reggia, J., Nau, D. S., and Wang, P. Y. 1983. Diagnostic expert systems based on a set covering model. *International Journal of Man–Machine Studies*, 19(5):437–460.
- Reinfrank, M. 1989. Fundamental and Logical Foundations of Truth Maintenance. Linköping Studies in Science and Technology, Dissertation 221, Department of Computer and Information Science, Linköping University, Linköping, Sweden.
- Reiter, R. 1978. On closed world databases. In Webber and Nilsson (1981).
- Reiter, R. 1980. A logic for default reasoning. *Artificial Intelligence*, 13:81–132.
- Reiter, R. 1985. On reasoning by default. In Brachman and Levesque (1985).
- Reiter, R. and Crisculo, G. 1981. On interacting defaults. *Proceedings of the International Joint Conference on Artificial Intelligence*.
- Reitman, W. R. 1965. *Cognition and Thought*. New York: Wiley.
- Rendell, L. 1986. A general framework for induction and a study of selective induction. *Machine Learning*, 1(2).

- Rich, E. and Knight, K. 1991. *Artificial Intelligence*, 2nd ed. New York: McGraw-Hill.
- Rissland, E. L. 1983. Examples in legal reasoning: Legal hypotheticals. *Proceedings of IJCAI-83*. San Mateo, CA: Morgan Kaufman.
- Rissland, E. L. and Ashley, K. 1987. HYPO: A case-based system for trade secrets law. *Proceedings, First International Conference on Artificial Intelligence and Law*.
- Roberts, D. D. 1973. *The Existential Graphs of Charles S. Pierce*. The Hague: Mouton.
- Robinson, J. A. 1965. A machine-oriented logic based on the resolution principle. *Journal of the ACM*, 12:23-41.
- Rochester, N., Holland, J. H., Haibit, L. H., and Duda, W. L. 1988. Test on a cell assembly theory of the actuation of the brain, using a large digital computer. In J. A. Anderson and E. Rosenfeld, ed. *Neurocomputing: Foundations of Research*. Cambridge, MA: MIT Press.
- Rosch, E. 1978. Principles of categorization. In Rosch and Lloyd (1978).
- Rosch, E. and Lloyd, B. B., ed. 1978. *Cognition and Categorization*, Hillsdale, NJ: Erlbaum.
- Rosenblatt, F. 1958. The perceptron: A probabilistic model for information storage and organization in the brain. *Psychological Review*, 65:386-408.
- Rosenblatt, F. 1962. *Principles of Neurodynamics*. New York: Spartan.
- Rosenbloom, P. S. and Newell, A. 1986. The chunking of goal hierarchies: A generalized model of practice. In Michalski et al. (1986).
- Rosenbloom, P. S. and Newell, A. 1987. Learning by chunking, a production system model of practice. In Klahr et al. (1987).
- Rosenbloom, P. S., Lehman, J. F., and Laird, J. E. 1993. Overview of Soar as a unified theory of cognition: Spring 1993. *Proceedings of the Fifteenth Annual Conference of the Cognitive Science Society*. Hillsdale, NJ: Erlbaum.
- Ross, P. 1989. *Advanced PROLOG*. Reading, MA: Addison-Wesley.
- Ross, T. 1995. *Fuzzy Logic with Engineering Applications*. New York: McGraw-Hill.
- Roussel, P. 1975. *PROLOG: Manuel de Reference et d'Utilisation*. Groupe d'Intelligence Artificielle, Université d'Aix-Marseille, Luminy, France.
- Rumelhart, D. E., Lindsay, P. H., and Norman, D. A. 1972. A process model for long-term memory. In Tulving and Donaldson (1972).
- Rumelhart, D. E. and Norman, D. A. 1973. Active semantic networks as a model of human memory. *Proceedings IJCAI-3*.
- Rumelhart, D. E., Hinton, G. E., and Williams, R. J. 1986a. Learning internal representations by error propagation. In McClelland et al. (1986).
- Rumelhart, D. E., McClelland, J. L., and The PDP Research Group. 1986b. *Parallel Distributed Processing*. Vol. 1. Cambridge, MA: MIT Press.
- Russell, S. J. 1989. *The Use of Knowledge in Analogy and Induction*. San Mateo, CA: Morgan Kaufmann.
- Russell, S. J. and Norvig, P. 1995. *Artificial Intelligence: A Modern Approach*. Englewood Cliffs, NJ: Prentice-Hall.
- Sacerdotti, E. D. 1974. Planning in a hierarchy of abstraction spaces. *Artificial Intelligence*, 5:115-135.
- Sacerdotti, E. D. 1975. The non linear nature of plans. *Proceedings IJCAI 4*.
- Sacerdotti, E. D. 1977. *A Structure of Plans and Behavior*. New York: Elsevier.
- Samuel, A. L. 1959. Some studies in machine learning using the game of checkers, *IBM Journal of R & D*, 3:211-229.
- Schank, R. C. 1982. *Dynamic Memory: A Theory of Reminding and Learning in Computers and People*. London: Cambridge University Press.
- Schank, R.C. and Abelson, R. 1977. *Scripts, Plans, Goals and Understanding*. Hillsdale, NJ: Erlbaum.

- Schank, R. C. and Colby, K. M., ed. 1973. *Computer Models of Thought and Language*. San Francisco: Freeman.
- Schank, R. C. and Nash-Webber, B. L., ed. 1975. *Theoretical Issues in Natural Language Processing*. Association for Computational Linguistics.
- Schank, R. C. and Rieger, C. J. 1974. Inference and the computer understanding of natural language. *Artificial Intelligence* 5(4):373-412.
- Schank, R. C. and Riesbeck, C. K., ed. 1981. *Inside Computer Understanding: Five Programs Plus Miniatures*. Hillsdale, N. J.: Erlbaum.
- Searle, J. 1969. *Speech Acts*. London: Cambridge University Press.
- Searle, J. R. 1980. Minds, brains and programs. *The Behavioral and Brain Sciences*, 3:417-424.
- Sebeok, T. A. 1985. *Contributions to the Doctrine of Signs*. Lanham, MD: Univ. Press of America.
- Sedgewick, R. 1983. *Algorithms*. Reading, MA: Addison-Wesley.
- Sejnowski, T. J. and Rosenberg, C. R. 1987. Parallel networks that learn to pronounce english text. *Complex Systems*, 1:145-168.
- Selfridge, O. 1959. Pandemonium: A paradigm for learning. *Symposium on the Mechanization of Thought*. London: HMSO.
- Selman, B. and Levesque, H. J. 1990. Abductive and Default Reasoning: A Computational Core. *Proceedings of the Eighth National Conference on Artificial Intelligence*, pp. 343-348. Menlo Park, CA: AAAI Press/MIT Press.
- Selz, O. 1913. *Über die Gesetze des Geordneten Denkverlaufs*. Stuttgart: Spemann.
- Selz, O. 1922. *Zur Psychologie des Produktiven Denkens und des Irrtums*. Bonn: Friedrich Cohen.
- Shafer, G., Pearl, J., ed. 1990. *Readings in Uncertain Reasoning*, Los Altos, CA: Morgan Kaufmann.
- Shannon, C. 1948. A mathematical theory of communication. *Bell System Technical Journal*.
- Shapiro, E. 1987. *Concurrent Prolog: Collected Papers*, 2 vols. Cambridge, MA: MIT Press.
- Shapiro, S. C., ed. 1987. *Encyclopedia of Artificial Intelligence*. New York: Wiley-Interscience.
- Shapiro, S. C., ed. 1992. *Encyclopedia of Artificial Intelligence*. New York: Wiley.
- Shavlik, J. W. and Dietterich, T. G. ed. 1990. *Readings in Machine Learning*. San Mateo, CA: Morgan Kaufmann.
- Shavlik, J. W., Mooney, R. J., and Towell, G. G. 1991. Symbolic and neural learning algorithms: An experimental comparison. *Machine Learning*, 6(1):111-143.
- Shrager, J. and Langley, P., ed. 1990. *Computational Models of Scientific Discovery and Theory Formation*. San Mateo, CA: Morgan Kaufmann.
- Siegelman, H. and Sontag, E. D. 1991. Neural networks are universal computing devices. *Technical Report SYCON 91-08*. New Jersey: Rutgers Center for Systems and Control.
- Siegler, ed. 1978. *Children's Thinking: What Develops*. Hillsdale, NJ: Erlbaum.
- Siekman, J. H. and Wrightson, G., ed. 1983a. *The Automation of Reasoning: Collected Papers from 1957 to 1970*. Vol I. New York: Springer-Verlag.
- Siekman, J. H. and Wrightson, G., ed. 1983b. *The Automation of Reasoning: Collected Papers from 1957 to 1970*. Vol II. New York: Springer-Verlag.
- Simmons, R. F. 1966. Storage and retrieval of aspects of meaning in directed graph structures. *Communications of the ACM*, 9:211-216.
- Simmons, R. F. 1973. Semantic networks: Their computation and use for understanding english sentences. In Schank (1972).
- Simon, D. P. and Simon, H. A. 1978. Individual differences in solving physics problems. In Siegler (1978).
- Simon, H. A. 1944. Decision making and administrative organization. *Public Administration Review*, 4:16-31.
- Simon, H. A. 1975. The functional equivalence of problem solving skills. *Cognitive Psychology*, 7:268-288.

- Simon, H. A. 1981. *The Sciences of the Artificial*, 2nd ed. Cambridge, MA: MIT Press.
- Simon, H. A. 1983. Why should machines learn? In Michalski et al. (1983).
- Sims, M. H. 1987. Empirical and analytic discovery in IL. *Proceedings of the Fourth International Workshop on Machine Learning*. Los Altos, CA: Morgan Kaufmann.
- Skinner, J. M. and Luger, G. F. 1991. A Synergistic Approach to Reasoning for Autonomous Satellites. *Proceedings for NATO Conference of the Advisory Group for Aerospace Research and Development*.
- Skinner, J. M. and Luger, G. F. 1992. An Architecture for Integrating Reasoning Paradigms. *Principles of Knowledge Representation and Reasoning*. Edited by B. Nobel, C. Rich and W. Swartout. San Mateo, CA: Morgan Kaufmann.
- Skinner, J. M. and Luger, G. F. 1995. Contributions of a case-based reasoner to an integrated reasoning system. *Journal of Intelligent Systems*. London: Freund.
- Sleeman, D. 1982. Assessing aspects of competence in basic algebra. In Sleeman and Brown (1982).
- Sleeman, D. and Smith, M. J. 1981. Modelling students' problem solving. *AI Journal*, pp. 171-187.
- Sleeman, D. and Brown, J. S. 1982. *Intelligent Tutoring Systems*. New York: Academic Press.
- Smalltalk/V: Tutorial and Programming Handbook*. 1986. Los Angeles: Digital.
- Smart, G. and Langeland-Knudsen, J. 1986. *The CRI Directory of Expert Systems*. Oxford: Learned Information (Europe) Ltd.
- Smith, B. C. 1985. Prologue to reflection and semantics in a procedural language. In Brachman and Levesque (1985).
- Smith, B. C. 1996. *On the Origin of Objects*. Cambridge, MA: MIT Press.
- Smith, R. G. and Baker, J. D. 1983. The dipmeter advisor system: a case study in commercial expert system development. *Proc. 8th IJCAI*, pp. 122-129.
- Smoliar, S. W. 1985. A View of Goal-oriented Programming, Schlumberger-Doll Research Note.
- Soloway, E., Rubín, E., Woolf, B., Bonar, J., and Johnson, W. L. 1983. MENO-II: an AI-based programming tutor. *Journal of Computer Based Instruction*, 10(1,2).
- Soloway, E., Bachant, J., and Jensen, K. 1987. Assessing the maintainability of XCON-in-RIME: Coping with the problems of a very large rule base. *Proceedings AAAI-87*. Los Altos, CA: Morgan Kaufmann.
- Sowa, J. F. 1984. *Conceptual Structures: Information Processing in Mind and Machine*. Reading, MA: Addison-Wesley.
- Steele, G. L., 1990, *Common LISP: The Language*, 2nd ed. Bedford, MA: Digital Press.
- Stefik, M., Bobrow, D., Mittal, S., and Conway, L. 1983. Knowledge programming in LOOPS: Report on an experimental course. *Artificial Intelligence*, 4(3).
- Sterling, L. and Shapiro, E. 1986. *The Art of Prolog: Advanced Programming Techniques*. Cambridge, MA: MIT Press.
- Stern, C. R. 1996. *An Architecture for Diagnosis Employing Schema-based Abduction*. PhD dissertation, Department of Computer Science, University of New Mexico.
- Stern, C. R. and Luger, G. F. 1992. A Model for Abductive Problem Solving Based on Explanation Templates and Lazy Evaluation. *International Journal of Expert Systems*, 5(3):249-265.
- Stern, C. R. and Luger, G. F. 1997. Abduction and Abstraction in Diagnosis: A Schema-Based Account. *Situated Cognition: Expertise in Context*. Ford et. al. ed. Cambridge, MA: MIT Press.
- Stubblefield, W. A. 1995. *Source Retrieval in Analogical Reasoning: An Interactionist Approach*. PhD dissertation, Department of Computer Science, University of New Mexico.
- Stubblefield, W. A. and Luger, G. F. 1996. Source Selection for Analogical Reasoning: An Empirical Approach. *Proceedings: Thirteenth National Conference on Artificial Intelligence*.

- Suchman, L. 1987. *Plans and Situated Actions: The Problem of Human Machine Communication*. Cambridge: Cambridge University Press.
- Sussman, G. J. 1975. *A Computer Model of Skill Acquisition*. Cambridge: MIT.
- Tanimoto, S. L. 1990. *The Elements of Artificial Intelligence using Common LISP*. New York: W. H. Freeman.
- Tarski, A. 1944. The semantic conception of truth and the foundations of semantics. *Philos. and Phenom. Res.*, 4:341-376.
- Tarski, A. 1956. *Logic, Semantics, Metamathematics*. London: Oxford University Press.
- Thagard, P. 1988. Dimensions of analogy. In Helman (1988).
- Touretzky, D. S. 1986. *The Mathematics of Inheritance Systems*. Los Altos, CA: Morgan Kaufmann.
- Touretzky, D. S. 1990. *Common LISP: A Gentle Introduction to Symbolic Computation*. Redwood City, CA: Benjamin/Cummings.
- Tulving, E. and Donaldson, W. 1972. *Organization of Memory*. New York: Academic Press.
- Turing, A. A. 1950. Computing machinery and intelligence. *Mind*, 59:433-460.
- Turner, R. 1984. *Logics for Artificial Intelligence*. Chichester: Ellis Horwood.
- Ullman, J. D. 1982. *Principles of Database Systems*. Rockville, MD: Computer Science Press.
- Urey, H. C. 1952. *The Planets: Their Origin and Development*. Yale University Press.
- Utgoff, P. E. 1986. Shift of bias in inductive concept learning. In Michalski et al. (1986).
- Valiant, L. G. 1984. A theory of the learnable. *CACM*, 27:1134-1142.
- van der Gaag, L. C., ed. 1996. Special issue on Bayesian Belief Networks. *AISB Quarterly*. 94.
- van Emden, M. and Kowalski, R. 1976. The semantics of predicate logic and a programming language. *Journal of the ACM*, 23:733-742.
- VanLe, T. 1993. *Techniques of PROLOG Programming with Implementation of Logical Negation and Quantified Goals*. New York: Wiley.
- Varela, F. J., Thompson, E., and Rosch, E. 1993. *The Embodied Mind: Cognitive Science and Human Experience*. Cambridge, MA: MIT Press.
- Vere, S. A. 1975. Induction of concepts in the predicate calculus. *Proceedings IJCAI 4*.
- Vere, S. A. 1978. Inductive learning of relational productions. In Waterman and Hayes-Roth (1978).
- Walker, A., McCord, M., Sowa, J. F., and Wilson, W. G. 1987. *Knowledge Systems and PROLOG: A Logical Approach to Expert Systems and Natural Language Processing*. Reading, MA: Addison-Wesley.
- Warren, D. H. D. 1976. Generating conditional plans and programs. *Proc. AISB Summer Conference*, Edinburgh, pp. 334-354.
- Warren, D. H. D. 1980. Logic programming and compiler writing. *Software-Practice and Experience*, 10(II).
- Warren, D. H. D., Pereira, F., and Pereira, L. M. 1979. *User's Guide to DEC-System 10 PROLOG*. Occasional Paper 15, Department of Artificial Intelligence, University of Edinburgh.
- Warren, D. H. D., Pereira, L. M., and Pereira, F. 1977. PROLOG-the language and its implementation compared with LISP. *Proceedings, Symposium on AI and Programming Languages, SIGPLAN Notices*, 12:8.
- Waterman, D. and Hayes-Roth, F. 1978. *Pattern Directed Inference Systems*. New York: Academic Press.
- Waterman, D. A. 1968. Machine Learning of Heuristics. *Report No. STAN-CS-68-118*, Computer Science Dept., Stanford University.
- Waterman, D. A. 1986. *A Guide to Expert Systems*. Reading, MA: Addison-Wesley.
- Webber, B. L. and Nilsson, N. J. 1981. *Readings in Artificial Intelligence*. Los Altos, CA: Tioga Press.
- Weiss, S. M. and Kulikowski, C. A. 1991. *Computer Systems that Learn*. San Mateo, CA: Morgan Kaufmann.

- Weiss, S. M., Kulikowski, C. A., Amarel, S., and Safir, A. 1977. A model-based method for computer-aided medical decision-making. *Artificial Intelligence*, 11(1-2):145-172.
- Weizenbaum, J. 1976. *Computer Power and Human Reason*. San Francisco: W. H. Freeman.
- Weld, D. S. and deKleer, J., ed. 1990. *Readings in Qualitative Reasoning about Physical Systems*. Los Altos, CA: Morgan Kaufmann.
- Welham, R. 1976. *Geometry Problem Solving*. Research Report 14, Department of Artificial Intelligence, University of Edinburgh.
- Wellman, M. P. 1990. Fundamental concepts of qualitative probabilistic networks. *Artificial Intelligence*, 44(3):257-303.
- Weyrauch, R. W. 1980. Prolegomena to a theory of mechanized formal reasoning. *Artificial Intelligence*, 13(1,2):133-170.
- Whitehead, A. N. and Russell, B. 1950. *Principia Mathematica*, 2nd ed. London: Cambridge University Press.
- Whitley, L. D., ed. 1993. *Foundations of Genetic Algorithms 2*. Los Altos, CA: Morgan Kaufmann.
- Widrow, B. and Hoff, M. E. 1960. Adaptive switching circuits. *1960 IRE WESTCON Convention Record*, pp. 96-104. New York.
- Wilensky, R. 1986. *Common LISPCraft*, Norton Press.
- Wilks, Y. A. 1972. *Grammar, Meaning and the Machine Analysis of Language*. London: Routledge & Kegan Paul.
- Winograd, T. 1972. *Understanding Natural Language*. New York: Academic Press.
- Winograd, T. 1973. A procedural model of language understanding. In Schank and Colby (1973).
- Winograd, T. 1983. *Language as a Cognitive Process: Syntax*. Reading, MA: Addison-Wesley.
- Winograd, T. and Flores, F. 1986. *Understanding Computers and Cognition*. Norwood, N. J.: Ablex.
- Winston, P. H. 1975a. Learning structural descriptions from examples. In Winston (1975b).
- Winston, P. H., ed. 1975b. *The Psychology of Computer Vision*. New York: McGraw-Hill.
- Winston, P. H. 1986. Learning by augmenting rules and accumulating censors. In Michalski et al. (1986).
- Winston, P. H. 1992. *Artificial Intelligence*, 3rd ed. Reading, MA: Addison-Wesley.
- Winston, P. H., Binford, T. O., Katz, B., and Lowry, M. 1983. Learning physical descriptions from functional definitions, examples and precedents. *National Conference on Artificial Intelligence in Washington, D. C.*, Morgan Kaufmann, pp. 433-439.
- Winston, P. H. and Horn, B. K. P. 1984. *LISP*. Reading, MA: Addison-Wesley.
- Winston, P. H. and Prendergast, K. A., ed. 1984. *The AI Business*. Cambridge, MA: MIT Press.
- Wirth, N. 1976. *Algorithms + Data Structures = Programs*. Engelwood Cliffs, N. J.: Prentice-Hall.
- Wittgenstein, L. 1953. *Philosophical Investigations*. New York: Macmillan.
- Wolstencroft, J. 1989. Restructuring, reminding and repair: What's missing from models of analogy. *AICOM*, 2(2):58-71.
- Woods, W. 1985. What's in a Link: Foundations for Semantic Networks. In Brachman and Levesque (1985).
- Wos, L. and Robinson, G. A. 1968. Paramodulation and set of support, *Proceedings of the IRIA Symposium on Automatic Demonstration, Versailles, France*, New York: Springer-Verlag, pp. 367-410.
- Wos, L. 1988. *Automated Reasoning, 33 Basic Research Problems*. NJ: Prentice Hall.
- Wos, L., Overbeek, R., Lusk, E., and Boyle, J. 1984. *Automated reasoning: Introduction and Applications*. Englewood Cliffs, NJ: Prentice-Hall.
- Yager, R. R. and Zadeh, L. A. 1994. *Fuzzy Sets, Neural Networks and Soft Computing*. New York: Van Nostrand Reinhold.
- Young, R. M. 1976. *Seriation by Children: An Artificial Intelligence Analysis of a Piagetian Task*. Basel: Birkhauser.

- Yuasa, T. and Hagiya, M. 1986. *Introduction to Common LISP*. Boston: Academic Press.
- Zadeh, L. A. 1983. Commonsense knowledge representation based on fuzzy logic. *Computer*, 16:61-65.
- Zurada, J. M. 1992. *Introduction to Artificial Neural Systems*. New York: West Publishing.

AUTHOR INDEX

-
- Abelson, H. 324, 511, 556, 775
Ackley, D. H. 747
Aeschylus 3
Agre, P. 24, 777
Aho, A. 121
Aiello, N. 198
Alexander, C. 517
Allen, J. 30, 199, 520, 542, 555-556
Alty, J. 245
Amarel, S. 266, 290
Anderson, J. A. 696, 712
Anderson, J. R. 30, 174, 301, 334, 562, 696, 712,
769-770, 776, 780
Andrews, P. B. 79
Appelt, D. 62
Arbib, M. 741
Aristotle 4-5, 8-9, 29-31, 217, 247, 778
Ashley, K. 235
Asunuma, C. 26
Auer, P. 659
Austin, J. L. 14, 778
- Babbage, C. 7-8, 29
Bacon, F. 203
Baker, J. D. 21
Ballard, D. 711, 780
Balzer, R. 198
Bareiss, E. R. 235
Barker, V. 174
Barkow, J. H. 762
Barr, A. 30, 199
Bartlett, F. 324
Bates, E. A. 711, 780
Bateson, G. 29
Bauer, M. A. 768
Bechtel, W. 780
Benson, S. 199, 201, 742, 748, 765
- Berger, A. 550
Bhaskar, R. 769
Blake, A. 519
Bledsoe, W. 30, 566, 599-600
Bobrow, D. 293, 335
Boole, G. 8, 29
Bower, G. H. 301, 334
Boyer, R. S. 19, 30, 600
Brachman, R. 79, 205, 304, 328, 330, 333, 335, 776
Brooks, R. A. 24, 715, 741-742, 747, 765, 770, 777
Brown, J. S. 232, 245, 649-650, 768
Brown, P. 550
Brownston, L. 184, 199
Buchanan, B. G. 20, 245, 263, 287, 289, 639
Bundy, A. 79, 335, 768-769
Burks, A. W. 740, 747
Burroughs, W. S. 753
Burstall, R. M. 9
Burton, R. R. 245, 768
Byron, A. 4, 17
- Carbonell, J. G. 239, 659
Carnap, R. 778
Carroll, L. 425
Ceccato, S. 301
Chang, C. L. 81, 569, 579, 600
Chapman, D. 24, 777
Charniak, E. 121, 283, 289, 328, 556
Chomsky, N. 532
Chorfias, D. N. 245
Church, A. 351, 775
Clancy, W. J. 231, 768
Clarke, A. C. 17, 713
Clocksin, W. F. 350, 358, 421
Codd, E. F. 741
Cohen, P. R. 199
Colby, K. M. 30, 304
-

- Collins, A. 298, 334–335, 767
 Colmerauer, A. 350
 Conway, J. H. 714, 736, 747
 Coombs, M. J. 245, 289
 Copernicus, N. 5
 Corkill, D. D. 199
 Cormen, T. 121
 Corter, J. 656
 Cosmides, L. 762
 Crick, F. 26
 Crisculo, G. 273, 290
 Crutchfield, J. P. 715, 743–745, 748
- Dahl, V. 422
 Dante 4
 Darlington, J. A. 9
 Darwin, C. 4, 713
 Das, R. 744
 Davis, E. 335
 Davis, L. 688, 720
 Davis, R. 26, 233, 245–246, 290, 649
 DeJong, G. 26, 640, 643
 deKleer, J. 232, 278–282, 290, 335, 511, 768
 Della Pietra, S. 550
 Della Pietra, V. 550
 Dempster, A. P. 259
 Dennett, D. C. 29, 81, 747, 749, 763, 770, 776, 780
 Descartes, R. 6, 13, 776
 Dietterich, T. G. 645, 658
 Dologite, D. G. 245
 Domingue, J. 511
 Doyle, J. 271–272, 276, 278, 290
 Dressler, O. 279
 Dreyfus, H. L. 14, 777–778
 Dreyfus, S. E. 14, 777–778
 Druzdel, M. J. 256, 258, 289, 291
 Duda, W. L. 21, 665
 Durkin, J. 245, 289
- Eco, U. 778
 Edelman, G. M. 763
 Einstein, A. 247
 Eliot, T. S. 159, 293, 517, 661, 753
 Elman, J. L. 711, 760, 780
 Erman, L. D. 196, 198–199
 Ernst, G. W. 560, 565, 758
 Euler, L. 7, 82
 Evans, T. G. 337
- Falkenhainer, B. 647
 Fass, D. 556
 Feigenbaum, E. A. 30, 199, 207, 600, 603, 659,
 766–767
 Feldman, J. 600, 766
- Fermat, P. de 47
 Fikes, R. E. 192–193, 335, 566, 640
 Fillmore, C. J. 304
 Fisher, D. H. 237, 654, 659
 Flores, F. 14, 30, 34, 556, 777–778, 780
 Fodor, J. A. 761, 770
 Forbus, K. D. 279, 511
 Ford, K. 12, 30, 249
 Forgy, C. L. 230, 237
 Forney, G. D. 545
 Forrest, S. 747
 Franklin, S. 711, 780
 Freeman, J. A. 711, 771
 Frege, G. 5, 8–9, 29, 778
 Frost, R. 81
- Galileo 6, 13
 Gallier, J. H. 79
 Gardner, M. 714, 736, 747–748, 762
 Garey, M. 124
 Gazdar, G. 421
 Genesereth, M. 79, 275, 290, 600
 Gennari, J. H. 655
 Gentner, D. 647
 Giarratano, J. 245–246
 Gillett, J. 550
 Gluck, M. 656
 Glymour, C. 30, 249
 Gödel, K. 5, 8, 14
 Goethe, J. W. 603
 Goldberg, D. E. 724, 747
 Goodwin, J. 277
 Gould, S. J. 747, 749
 Graham, P. 511
 Grice, H. P. 14, 283, 778
 Grossberg, S. 663, 687, 711–712
 Grosz, B. 23, 769, 778
 Guha, R. V. 758
- Haibit, L. H. 665
 Hall, R. P. 646
 Hammond, K. 239
 Hamscher, W. 233, 246
 Hanson, J. E. 745
 Harbison-Briggs, K. 245
 Harmon, P. 30, 245, 299
 Harris, M. D. 556
 Hasemer, T. 511
 Haugeland, J. 29, 780
 Haussler, D. 638
 Hayes, J. 30
 Hayes, P. 12, 187, 249, 294, 334, 350
 Hayes-Roth, B. 748
 Hayes-Roth, F. 30, 199, 245

- Hebb, D. O. 663, 665, 690, 711
 Hecht-Nielsen, R. 662, 682-683, 686-687, 706,
 711-712, 771, 774
 Heidegger, M. 14, 778
 Heidorn, G. E. 534
 Helman, P. 121
 Hempel, C. G. 780
 Henrion, M. 258, 291
 Hightower, R. 741, 747
 Hillis, D. W. 27
 Hinsley, D. 768-769
 Hinton, G. E. 712
 Hobbes, T. 778
 Hobbs, J. R. 290
 Hodges, A. 30
 Hoff, M. E. 673
 Holland, J. H. 665, 683, 691, 715, 723-727,
 747-748, 761
 Holte, R. C. 659
 Holyoak, K. J. 659
 Hopcroft, J. E. 532, 556
 Hopfield, J. J. 663, 701, 706, 712
 Horowitz, E. 92, 121
 Hume, D. 7, 357, 634, 778
 Husserl, E. 14, 778

 Ignizio, J. P. 245

 Jackson, P. 289
 Jeannerond, M. 711, 780
 Johnson, D. 124
 Johnson, L. 245, 289, 768
 Johnson, M. 777
 Johnson, M. A. 711, 780
 Johnson, P. 769
 Johnson-Laird, P. 776
 Jones, R. S. 696, 712
 Josephson, J. R. 291
 Josephson, S. G. 291

 Kant, I. 559
 Karmiloff-Smith, A. 711, 763, 780
 Kay, A. 352
 Kedar-Cabelli, S. 646, 659
 Keravnou, E. T. 245, 289, 768
 King, D. 30
 King, S. H. 421
 Klahr, D. 658
 Klahr, P. 199, 245, 289
 Klein, W. B. 765
 Knight, K. 121, 289
 Kodratoff, Y. 30, 658
 Kohonen, T. 662-663, 682, 684, 696, 712
 Kolmogorov, A. N. 774

 Kolodner, J. L. 237-239, 245-246, 328
 Korf, R. E. 106
 Korzybski, A. 339
 Kosko, B. 702, 712
 Koton, P. 235
 Kowalski, R. 250, 421-422, 566, 587-588, 590, 600
 Koza, J. R. 715, 731-733, 747-748
 Kuhn, T. S. 780
 Kulikowski, C. A. 266, 290, 659

 Lafferty, J. 550
 Lakatos, I. 780
 Lakoff, G. 650, 684, 770
 Lalanda, P. 748
 Langeland-Knudsen, J. 245, 289
 Langley, P. 650, 659
 Langton, C. G. 30, 683, 715, 741, 747, 765
 LaoTzu 425
 Larkin, J. 174, 769
 Lauritzen, S. L. 258, 289, 291
 Leake, D. B. 239, 245
 Lee, R. C. 79, 569, 579, 600
 Lehman, J. F. 747
 Leibniz, G. W. von 7, 13, 357, 778
 Leiserson, C. 121
 Lenat, D. B. 25, 649-650, 758
 Lennon, J. 312, 339
 Lesser, V. R. 199
 Levesque, H. J. 79, 205, 281-283, 294, 333,
 335, 776
 Lieber, J. 123
 Lifschitz, V. 274-275, 290
 Linde, C. 769
 Lindsay, R. K. 20, 199
 Littman, M. 747
 Lloyd, J. W. 350
 Locke, J. 603, 778
 Lovelace, A. 7-8, 12, 17
 Loveland, D. W. 600
 Lucas, R. 421
 Luger, G. F. 23, 30, 174, 198-199, 217, 235-237,
 239, 246, 335, 562, 768-769, 776, 780

 Maass, W. 659
 Machtey, M. 34
 MacLennan, B. J. 30
 Maes, P. 748
 Magerman, D. 549
 Maier, D. 421
 Malpas, J. 391, 422
 Manna, Z. 79
 Marcus, M. 23
 Markov, A. 172
 Martins, J. 278-279, 281, 290

- Masterman, M. 301, 304
 Matisse, H. 517
 McAllester, D. A. 278, 281, 290
 McCarthy, J. 62, 187, 274–275, 290–291, 334, 351
 McCartney, P. 312, 339
 McCelland, J. L. 673
 McCord, M. 422
 McCorduck, P. 603
 McCulloch, W. S. 662, 664, 711
 McDermott, D. 121, 199, 271–272, 289
 McDermott, J. 36, 174, 208, 215
 McGraw, K. L. 245
 Mead, C. 712
 Mellish, C. 350, 358, 421
 Mercer, R. 550
 Merleau-Ponty, M. 14
 Michalewicz, 747
 Michalski, R. 30, 652, 658, 730
 Milner, R. 775
 Milton, J. 4
 Minsky, M. 30, 320, 323–324, 666–667, 761, 770
 Minton, S. 640
 Mitchell, M. 30, 692, 715, 724, 733, 743–748,
 Mitchell, T. 26, 612, 619, 639–641, 643–644
 Mithen, S. 762–763
 Mockler, R. J. 245
 Mooney, R. 283, 640, 643
 Moore, J. S. 19, 30, 600
 Moore, O. K. 562
 Moore, R. C. 272, 290, 334
 Morignot, P. 748
 Morrison, E. 7
 Morrison, P. 7
 Mycroft, A. 391, 393, 422
 Mylopoulos, J. 294

 Nash-Webber, B. L. 304
 Nau, D. S. 281
 Neches, R. 769
 Negoita, C. 245
 Neves, J. C. F. M. 391
 Newell, A. 7, 18–19, 28, 30, 33, 41, 51, 121, 123,
 159, 172, 174, 199, 203, 340, 560, 562–565,
 600, 747, 753, 755, 757–758, 766–768, 770,
 776, 780
 Ng, H. T. 283
 Nii, P. 198–199
 Nilsson, N. 30, 79, 121, 150, 152, 192–193, 199,
 201, 275, 290, 566, 594, 599–600, 666, 741–
 742, 748, 765
 Nordhausen, B. 650
 Norman, D. A. 301, 304, 780
 Norvig, P. 246
 Novak, G. S. 768

 Noyes, J. L. 511

 O'Conner, D. E. 174
 O'Keefe, R. 393, 421–422
 Oliver, I. M. 688, 720

 Papert, S. 215, 352, 666–667
 Parisi, D. 711, 780
 Patil, R. 290
 Pearl, J. 30, 121, 127, 149, 258, 289–291
 Peirce, C. S. 301, 778
 Penrose, R. 755, 777
 Pereira, F. 350, 422
 Perlis, D. 275, 290
 Pfleger, K. 748
 Piaget, J. 769
 Pierce, C.S. 47
 Pitts, W. 662, 664, 711
 Plato 13
 Plunkett, K. 711, 780
 Polya, G. 123
 Popper, K. 777, 780
 Porter, B. W. 235
 Posner, M. 777, 780
 Post, E. 172, 775
 Poundstone, R. 714, 738
 Prerau, D. S. 245, 289
 Printz, H. 550
 Pylyshyn, Z. 30, 777, 780

 Quillian, M. R. 298, 301–303, 334, 767
 Quine, W.V.O. 780
 Quinlan, J. R. 26, 624, 659
 Quinlan, P. 665

 Raphael, B. 301
 Reddy, D. 196, 199
 Reggia, J. 281
 Reinfrank 278, 290
 Reiter, R. 271–273, 290
 Reitman, W. R. 301
 Rich, E. 121, 289, 307
 Rieger, C. J. 304–306
 Riesbeck, C. K. 30, 328, 556
 Riley 245–246
 Rissland, E. 235
 Ritz, S. A. 696, 712
 Rivers, R. 121
 Roberts, D. D. 301
 Robinson, J. A. 350, 566–567, 580, 600
 Rochester, S. 665
 Rosch, E. 653–654, 684
 Rosenberg 679
 Rosenblatt, F. 666, 711

- Rosenbloom, P. S. 747, 767, 770
 Ross, P. 421
 Ross, T. 289–290, 292
 Roussel, P. 350
 Rumelhart, D. E. 301, 304, 673, 711
 Russell, B. 5, 8–9, 19, 29, 41, 51, 203, 246–247, 560, 661
 Russell, S. 646
- Sacerdotti, E. 199, 201, 566
 Sacks, O. 293
 Safir, A. 266, 290
 Sahni, S. 92, 121
 Samuels, A. 236, 239, 757
 Schank, R. 30, 245, 304–306, 324, 327–328, 556
 Schwartz, W. 290
 Searle, J. 14, 34, 556, 777
 Seboek, T. A. 778
 Sedgewick, R. 121
 Sejnowski, T. 679, 712
 Selfridge, O. 711, 770
 Selman, B. 282
 Selz, O. 301, 334
 Shafer, G. 290
 Shakespeare, W. 4, 203, 519–520
 Shannon, C. 628, 711
 Shapiro, E. 421–422
 Shapiro, S. C. 199, 258, 278, 289–290, 590, 602, 733
 Shavlik, J. W. 658, 680
 Shaw, J. C. 52, 203, 757, 766
 Shelley, M. 1, 4
 Shelley, P. 4
 Shimony, S. 283
 Shortliffe, E. H. 20, 245, 263, 288–289, 768
 Shrager, J. 650, 659
 Siegelman, H. 774
 Siekmann, J. H. 600
 Silverstein, J. W. 696, 712
 Simmons, R. F. 301, 304
 Simon, D. P. 174, 769
 Simon, H. A. 13, 18–19, 28, 30, 33, 41, 51, 121, 123, 159, 172, 174, 199, 203, 559–560, 563–564, 600, 604, 753, 755, 757–758, 766–769, 776, 780
 Sims, M. H. 650
 Skapura, D. M. 711, 771
 Skinner, J. M. 198–199, 236–237, 239, 246
 Sleeman, D. 768
 Smart, G. 245, 289
 Smith, B. C. 206, 556, 780
 Smith, J. C. 688, 720
 Smith, M. 768
 Smith, R. G. 21
 Smolier, S. 199
- Snyder, G. 339
 Socrates 5
 Soloway, E. 174, 758
 Sontag, E. D. 774
 Sowa, J. 309, 334, 422, 534, 541, 552, 556
 Spiegelhalter, D. J. 258, 289, 291
 Steele, G. 505, 511
 Stepp, R. E. 652
 Sterling, L. 421–422
 Stern, C. 235–236, 281, 769
 Stoller, M. 123
 Stubblefield, W. A. 237–238, 650
 Suchman, L. 764–765
 Sussman, G. J. 26, 511, 775
 Szolovits, P. 290
- Tanimoto, S. L. 511
 Tarski, A. 5, 9
 Terrence 519
 Thagard, P. 659
 Tofte, M. 775
 Tooby, J. 762
 Touretzky, D. S. 273, 290, 328, 331, 511
 Turing, A. 5, 8, 10, 12–14, 27–31, 766, 775
 Turner, R. 294, 318, 334
 Twain, M. 661
- Ullman, J. D. 532, 551–552, 556
 Ures, L. 550
 Urey, H. C. 735
 Utgoff, P. E. 635
- Valient, L. G. 637–638
 vanEmden, M. 588, 590
 VanLe, T. 421
 van Lehn, K. 245, 768
 Varela, F. J. 777
 Veroff, R. 121
 von Neumann, J. 10, 663, 740, 747, 766
- Waldinger, R. 79
 Walker, A. 422
 Wang, P. Y. 281
 Warren, D. H. D. 350
 Warren, D. S. 421–422
 Waterman, D. 21, 30, 199, 209, 245, 289
 Weir, C. C. 235
 Weiss, S. M. 266, 290, 659
 Weizanbaum, J. 30, 777–778
 Weld, D. S. 335
 Wellman, M. P. 256
 Weyrauch, R. W. 334
 Whitehead, A. N. 8–9, 19, 29, 41, 52, 203, 560

Widrow, B. 673
Wilks, Y. 30, 301, 304, 556
Wilson, W. 422
Winograd, T. 14, 22, 30, 34, 335, 520, 542, 555-556,
777-780
Winston, P. H. 26, 121, 608, 641
Wirth, N. 82, 422
Wittgenstein, L. 14, 654, 684
Wolstencroft, J. 646
Woods, W. 295, 298, 308, 336
Wos, L. 30, 79, 559, 580-581, 597, 599-601
Yager, R. R. 290
Young, R. M. 34, 769
Zadeh, L. A. 284, 287, 290, 308
Zurada, J. M. 675, 686, 711, 771

SUBJECT INDEX

-
- 15-puzzle 18, 89
8-puzzle 88-91, 102-105, 131-144, 174-175, 204, 226
- abduction 80, 206, 248, 281-283
 coherence-based selection 283
 cost-based 283
 logic-based 281-283
 set cover 281
- ABEL 267-268, 290
- ABSTRIPS 199, 566
- ACT* 174, 770
- active images 353
- active values 353
- admissibility 127, 139-142, 156-157, 758
- agent-based systems 761-764
- agents 13-17, 293, 345, 440, 770, 774; *see also*
 emergent computation
- agglomerative clustering 651
- Algorithm A 140
- Algorithm A* 140-144, 156-157, 723
- alpha-beta pruning 127, 150-152, 156
- AM 25, 649-650
- analogy 25, 607, 646-649
 inference 646
 retrieval 646
 structure mapping 647
 systematicity 648-649
- analytic engine 7-8, 17
- and elimination 66-67
- and introduction 66-67
- and/or graph search 164-165, 169
- and/or graphs 109-121, 154, 164-169, 222-223, 594
- answer extraction 574, 583-587, 592
- arity 53-54, 56
- artificial intelligence defined 1-2, 28-29, 755
- artificial life 15, 604, 714-715, 736-747; *see also*
 emergent computation
- associationist representation 297-309, 334
- associationist theories 297-309, 334
- associative law 51
- associative memory 696-711, 767; *see also* semantic
 networks, conceptual graphs
- assumption-based truth maintenance 278-281
- attractor network 663, 701-711
- augmentations of logic grammars 534
- augmented phrase structure grammars 534, 555
- augmented transition networks 528, 533-538, 556
- autoassociative memory 663, 696-711
- autoepistemic logic 272
- automated reasoning 8-9, 15, 19, 30, 45, 67,
 517-518, 559-601
 and logic programming 587-593
 and PROLOG 587-593
 answer extraction 574, 583-587, 592
 binary resolution 567, 573-578, 597
 breadth-first strategy 579-580
 clause form 567-573, 593
 completeness 566
 conjunctive normal form 569-572
 converting to clause form 568-573, 576
 demodulation 598-599
 factoring 575
 General Problem Solver 172-174, 203-204,
 560-566, 757-758, 766, 768
 Herbrand's theorem 600
 heuristics 578-583, 593-596
 horn clause 361, 472, 588-589, 593, 636
 hyperresolution 575, 597
 linear input form 581, 592
 literal 567, 573, 589
 logic theorist 203, 560-562
 means-ends analysis 204, 560-566, 757, 766-767
 natural deduction 560, 599-600

- automated reasoning (*continued*)
 - paramodulation 598–600
 - prenix normal form 570
 - refutation 566–567, 573–577
 - refutation completeness 566–567, 579
 - resolution 30, 66–67, 350, 560, 566–577
 - resolution refutation 566–577
 - rule-based approaches 593–596
 - set of support 560, 580, 600
 - skolemization 68, 569–571
 - soundness 65–67, 566, 593
 - subsumption 583, 600
 - unit preference 560, 580–581, 592
 - unit resolution 581, 600
 - weak methods 593
- axon 26
- back chaining 758
- backpropagation 662, 668, 675–682, 771
- backtracking 96–101, 110, 130, 160, 163, 176, 198, 223, 361, 368, 592
- backward chaining 93–96, 112–116
- base-level categories 654
- Bayes' theorem 251
- Bayesian belief networks 252–258
 - causal influence measure 252
 - d-separation 255
 - qualitative probabilistic network 256–258
 - qualitative influence graph 256–258
- Bayesian reasoning 249–258, 263, 518, 769
 - Bayes theorem 251
 - belief networks 252–258
 - complexity 251
- beam search 624
- behaviorism 23
- best-first search 99, 107, 127–136, 156, 384–386, 462–463, 560
 - implementation 131–136
- bidirectional associative memory 702–706
- binary resolution 567, 573–578, 597
- binding 39, 69–70, 343, 428
- blackboard architecture 46, 160, 196–199
- blocks world 22, 26, 37, 62–63, 188–196, 386–389, 520–521, 608–612
- boolean algebra 8
- bottom-up parsing 526
- branch and bound 92
- branching factor 96, 153–154, 182
- breadth-first search 99–105, 159, 162, 174, 383–384, 459–461, 560–561, 579–580
- bridges of Königsberg problem 7, 82–84, 121
- bucket brigade algorithm 725–730
- candidate elimination algorithm 613–620
- car/cdr recursion 441–443
- CART trees 546–547
- case-based reasoning 206, 209–210, 235–242
 - case retrieval 236–238
 - case adaptation 237
- case frame 540
- case-grammars 555
- CASEY 235
- CASNET 266–267, 290
- category formation 605
- category utility 656
- causal influence measure 252
- causal networks 266–268
- CBR *see* case-based reasoning
- cellular automata 713–714, 736–747
- certainty factor algebra *see* certainty theory
- certainty theory 206, 249, 263–266, 402–411
- checkers 18, 127, 147–148
- chess 18, 42–44, 164–170
- Chomsky hierarchy 531–533, 556
- chronological backtracking 276
- circumscription 249, 274–275
- classifier systems 715, 725–730
 - and production systems 726–728
 - bucket brigade algorithm 725–730
 - condition strength 728–730
 - fitness function 727
 - fitness measures 714–719, 727, 735–736, 744
- clause form 567–573, 593
- CLIPS 174
- CLOS 347, 497–511
 - class precedence list 503–505
 - defining classes 499
 - function
 - defclass 499–501
 - defgeneric 501–503
 - defmethod 503
 - generic functions 498–503
 - inheritance 503–505
 - meta-classes 505
 - multiple inheritance 503–505
 - simulation 505–511
 - slot options 499–501
 - slot-specifiers 499–501
 - thermostat simulation 505–511
- closed world assumption 235, 270, 273–274, 360, 592–593
- CLUSTER/2 605, 635, 773
- CNF Satisfaction 717–719
- COBWEB 605, 769
- COG 765
- cognitive neuroscience 759
- cognitive science 23, 30, 760–762, 766–770, 776, 779

coincidence learning *see* Hebbian learning
 Common LISP Object System *see* CLOS
 commonsense reasoning 17, 21, 213, 521
 commutative law 51
 competitive learning 662, 682–690
 completeness 65–67, 566
 complexity 88–92, 105–106, 124–127, 152–155
 and Bayesian reasoning 251
 composition of substitutions 69–70
 concept learning 605
 concept space 606–608
 conceptual clustering 605–606
 conceptual dependencies 294, 305–309, 324–328,
 556
 conceptual graphs 309–320, 334, 534, 538–543,
 551–556, 756
 absurd type 314
 and frames 321
 and modal logic 318–320
 and predicate calculus 318–320
 canonical formation rules 316
 concepts 309–310
 conceptual relations 309–310
 copy rule 314
 existential quantification 318–319
 generalization 314–316
 individuals 311–312
 inheritance 314–316
 join 314–317
 marker 311–312
 names 311–312
 proposition nodes 316–318
 quantification 318–320
 referent 312
 restrict 314–316
 simplify 314
 specialization 314–316
 subtype 311–313
 type hierarchy 313–316
 type lattice 313
 types 311–312
 universal quantification 318–319
 universal type 314
 conceptual models 216–219
 condition 171–186
 conflict resolution 171–186
 recency 184
 refraction 184
 specificity 184
 conflict set 171–186
 conjunction 48–50, 56, 59–60, 568
 conjunctive normal form 569–572
 connectionist models of intelligence 15, 26–27, 518,
 603–604, 661–712, 759–761, 773–774
 activation level 664
 associative memory 696–711
 attractor 701
 attractor network 663, 701–711
 autoassociative memory 663, 696–711
 backpropagation 662, 668, 675–682, 771
 backpropagation & exclusive or 681–682
 bidirectional associative memory 702–706
 classification 668, 672
 competitive learning 662, 682–690
 counter propagation 663, 683, 686–690
 delta rule 662, 668, 672–676
 early history 663–665
 feedback networks 701
 feedforward networks 701
 gradient descent learning 673; *see also* delta rule
 Grossberg learning 686–690
 Hebbian learning 663, 688–696, 773
 heteroassociative memory 663, 697
 Hopfield network 701, 706–711
 interpolative memory 697–700
 Kohonen networks 684–689
 linear associator network 697–711
 McCulloch-Pitts neuron 662–666
 NETalk 679–680
 ID3 compared 680
 network topology 664
 neurons 26–27, 34, 38, 663–665
 perceptron learning 666–675
 perceptrons 662, 675
 self-organizing networks 685
 supervised Hebbian learning 694–696
 threshold function 664
 unsupervised Hebbian learning 691–694
 winner take all learning 682–690
 consciousness 763
 constraint propagation 343, 348
 context-free grammars 524–533
 context-sensitive grammars 532–533
 contrapositive law 51
 counter propagation 663, 683, 686–690
 covering a concept 613
 credit assignment 623; *see also* bucket brigade
 algorithm
 crossover 716–721, 727–735
 CYC 758
 d-separation 255
 DAG *see* directed acyclic graph
 data-driven search 93–96, 121, 181–183, 198, 206,
 226–230, 594–595
 data-driven parsing 119
 data-driven reasoning *see* data-driven search
 data flow diagrams 552

- declarative representation 350, 415–421
- declarative semantics 357
- default logic 272–273
- defeasability 270
- delayed evaluation 482–486
- delta rule 662, 668, 672–676
- demodulation 598–599
- demons 296, 323, 353
- de Morgan's law 51, 204, 589
- Dempster–Shafer theory of evidence 206, 249, 259–263
 - Dempster's rule 261
 - plausibility measures 259–260
 - probability density function 261
 - subjective probabilities 259–260
- DENDRAL 20, 95–96, 199, 639–640
- dendrite 26
- dependency-directed backtracking 276
- depth-first iterative deepening 106
- depth-first search 99, 102–106, 159–163, 174, 367–369, 381–383, 449–455, 459–460, 560, 592
- development, modeling human 763, 769–770
- difference engine 7
- Dipmeter advisor 95
- directed acyclic graph 88
- directed graph 85
- disjunction 48–50, 56, 59–60, 568
- distributive law 51
- domain expert 20, 214–219
- domain of a function 53
- Dynabook 352
- dynamic binding 343–345, 348

- embodiment and cognition 777
- emergent computation 15–16, 26–27, 34, 219, 345, 518, 604, 713–749, 761–764
 - artificial life 15, 604, 714–715
 - cellular automata 713–714, 736–747
 - classifier systems 715, 725–730
 - evolutionary programming 740–743
 - finite state machines 736–742
 - Game of Life 714–715, 737–740
 - genetic algorithms 15, 34, 219, 345, 518, 604, 713–725, 730–736, 774
 - genetic programming 715, 730–736
 - Santa Fe Institute 715
 - society-based learning 736–747
 - subsumption architecture 741–742
 - teleo-reactive agents 742
- EMYCIN 211–212
- entity-relationship diagrams 552
- EPAM 767
- epistemology 5–10, 27–28

- equivalence 48–50, 56, 59–60
- Euler path 84
- evolutionary programming 740–743
- exclusive or 84, 667, 681–682
- existential quantification 56–58, 61–63, 318–319, 361–362, 570–571, 585–586
- existentialism 14, 765
- expert systems 20–22, 28–31, 34, 45–46, 136–139, 156, 160, 174, 203–256, 343, 401–411, 486–494, 560, 756, 758
 - certainty factors 486–488
 - conceptual models 216–219
 - expert system shell 486–494
 - explanation 20–21, 208, 211, 224–225, 241
 - exploratory programming 214–219
 - how query 211, 224–225
 - model-based reasoning 230–235
 - problem selection 212–214
 - separation of knowledge and control 205–206, 210–211
 - why query 211, 224–225
 - validation 208–209
- expert systems shell 210–211, 343, 401–411, 486–494
- explanation-based learning 206, 605–606, 641–645
 - explanation structure 643
 - generalization 642–643
 - goal regression 643
 - knowledge-level learning 645
 - operationality criteria 641
 - speed-up learning 645
- explanations 208, 224–225, 241; *see also* explanation-based learning
- exploratory programming 208, 214–219, 343–348
- expressiveness 34, 40–41
- extensibility of a programming language 347
- extensional definition 295, 652

- factoring 575
- falsifiability of models 777
- family resemblance theory 654
- farmer, wolf, goat, and cabbage problem 121, 375–380, 449–455
- feedback networks 701
- feedforward networks 701
- financial advisor 75–78, 115–116, 136–139, 180
- finite state machine 35–36, 527–538, 556, 736–742
- first-order predicate calculus 9, 17, 35–41, 46–47, 52–84, 90, 107–120, 160, 164–170, 179, 183–184, 188–196, 294, 297–298, 318–320, 343, 350, 358–361, 427, 560, 566–589, 593, 607–608, 758–759; *see also* automated reasoning; resolution and planning 188–196

- first-order predicate calculus (*continued*)
 - and the knight's tour problem 164-170
 - atomic sentence 55-59
 - clause form 568-573, 576
 - closed world assumption 592-593
 - completeness 65-67
 - conjunction 56, 59-60, 169-170
 - conjunctive normal form 569-572
 - constant 53-54, 64-66
 - converting to clause form 568-573, 576
 - declarative semantics 183-184
 - disjunction 56, 59-60, 170
 - equivalence 56, 59-60
 - existential quantifier 56-58, 61-63, 68
 - function 53-58
 - function expression 53-55
 - horn clause 588-589, 593
 - implication 56, 59-60
 - improper symbols 53
 - inconsistent 65-66
 - inference 38, 46
 - interpretation 59-60
 - model 65-67
 - negation 56, 59-60, 169-170
 - predicate 38, 53-58
 - prenex normal form 570
 - procedural semantics 183-184
 - proof procedures 66
 - quantification 39, 56-58, 61-63
 - resolution 66
 - rules of inference 64-74
 - satisfiability 65-67
 - searching the space of inferences 164-170
 - semantics 46-47, 52, 58-63, 298
 - sentences 56-58
 - skolemization 569-571
 - soundness 65-67
 - symbols 52-58
 - term 54
 - truth symbol 53-54
 - truth value 59-60
 - undecidability 60-61
 - universal quantifier 56-58, 61-63, 68
 - unsatisfiability 65-67
 - validity 65-67
 - variable 53-63
- FORTRAN 35-36, 340, 342, 351
- forward chaining 93-96
- FP 351
- frame problem 187-188, 190-191, 333
- frames 206, 294, 320-324, 335, 353, 412-415, 534, 538, 756
 - and vision 323-324
 - default information 322
- demons 323
- procedural attachment 323
- slots 321
- free variable 445
- function 53-58
 - closure 482-483
 - domain 53
 - evaluation 54
 - expression 53-55
 - range 53
- functional programming 425-426
- fuzzy associative matrix 286
- fuzzy reasoning 284-289
- fuzzy sets 284-289
- Game of Life 714-715, 737-740
- game playing 18, 42-44, 124, 127, 144-152, 156-157, 164-170, 768
 - alpha-beta pruning 127, 150-152, 156
 - checkers 18, 127, 147-148
 - chess 18, 42-44, 164-170
 - heuristics 144-152
 - horizon effect 149
 - minimax 127, 144-152, 156-157
 - minimax to fixed ply depth 147-150
 - n-move look ahead 147
 - nim 144-146
 - ply 147
 - Samuel's checker player 127, 148, 757
 - tic-tac-toe 42, 88-89, 107, 124-127, 149-152
- games *see* game-playing
- General Problem solver 172-174, 203-204, 560-566, 757-758, 766, 768
 - difference table 560-566
 - means-ends analysis 560-566
- generic functions 498, 501-503
- genetic algorithms 15, 34, 219, 345, 518, 604, 713-725, 730-736, 774
 - artificial life 736-747
 - classifier systems 725-730
 - CNF Satisfaction Problem 717-719
 - crossover 716-721, 727, 729-735
 - defined 715-716
 - genetic operators *see* crossover, mutation, inversion, order crossover, permutation
 - genetic programming 730-736
 - gray coding 722
 - hill climbing 723
 - implicit parallelism 723
 - inversion 717-718
 - Monte Carlo replacement algorithms 716
 - mutation 717-718, 721, 727-733, 736
 - order crossover 720-721
 - performance evaluation 721-725

- genetic algorithms (*continued*)
 - permutation 733
 - traveling salesperson 717-721
- genetic operators *see* crossover, mutation, inversion,
 - order crossover, permutation
- genetic programming 715, 730-736
- goal-directed search 167, 181-183, 198, 206,
 - 220-225, 561, 595-596
- goal-driven search 93-96, 112-116, 121
- goal-driven reasoning 206, 220-225
- goal regression 643
- goal state 87
- GOFAI 14
- GPS *see* General Problem solver
- gradient descent learning 673; *see also* delta rule
- grammar 116-121
- graph theory 7, 10, 42, 84-88
 - ancestor 85-86
 - arc 40
 - child 85-86
 - connected nodes 87
 - cycle 85-88
 - descendant 85-86
 - directed acyclic graph 88
 - directed graph 85
 - Hamiltonian path 121
 - labeled graph 84-85
 - leaf node 86
 - link 40, 42
 - loop 85-88
 - node 42, 84-88, 121
 - parent 85-86
 - path 85-86
 - rooted graph 85-86
 - sibling 85-86
 - tree 85-87
- gray coding 722
- Grossberg learning 686-690
- ground instance 69

- Hacker 26
- Hamiltonian path 121
- Hamming distance 697-700, 703-706
- HEARSAY-II 196-199
- HEARSAY-III 198-199
- Hebbian learning 663, 688-696, 773
- Herbrand's theorem 600
- heteroassociative memory 663, 697
- heuristics 18-20, 24-25, 28, 30, 44, 46, 92, 106, 121,
 - 123-159, 204, 208, 215, 229-234, 346, 353,
 - 560-566, 578-583, 593-596, 605, 607,
 - 619-636, 645, 755, 759
- admissibility 127, 139-142, 156-157
- Algorithm A 140
- Algorithm A* 140-144, 156-157
- alpha-beta pruning 127, 150-152, 156
- and expert systems 136-139
- and the 8-puzzle 131-144
- best-first search 156
- branching factor 153-154
- complexity 124-127, 152-155
- evaluation function 131-136, 139-143
- game playing 144-152
- hill climbing 127, 129, 148, 757
- horizon effect 149
- implementation 131-136
- in and/or graphs 154
- information theoretic 628-631
- informedness 129, 139, 142-144, 153-157
- means-ends analysis 204, 757
- minimax 127, 144-152, 156-157
- monotonicity 127, 139-142, 156
- nearest neighbor 92, 121
- Samuel's checker player 127, 148
- strong methods 204-206
- tic-tac-toe 149-152
- weak methods 204
- hierarchical abstraction 340
- hierarchical problem decomposition 24
- higher order functions 455-458
- higher order predicate calculi 61-62
- hill climbing 127, 129, 628, 657, 675, 723, 757
- homomorphism 333
- Hopfield networks 701, 706-711
- horizon effect 149
- Horn clause 361, 472, 588-589, 593, 636
- how query 211, 224-225, 400-401
- human associative memory 767; *see also* associative
 - memory
- human development 763, 769-770
- human performance modeling 23
- human problem solving 41, 186
- hybrid design 243-244
- hybrid programming environments 353
- hyperarc 109
- hypergraph 109
- hyperresolution 575, 597

- ID3 26, 249, 547-548, 605, 619, 624-636, 650, 680
 - and hill climbing 628
 - bagging 633
 - boosting 633
 - information theoretic test selection 628-631
 - performance evaluation 632-633
 - top-down decision tree induction 627-628
- image processing 35-36
- imitation game *see* Turing Test
- implication 48-50, 56, 59-60, 198

improper symbols 53
inconsistent 65-66
induction 603-633, 771-775
inductive bias 604-605, 624, 633-639, 662, 772-773
inference engine 210
informality of behavior 12
information theory 628-631
informedness 129, 139, 142-144, 153-155, 758
inheritance 40, 294-300, 303, 313-316, 328-331,
355, 411-415, 497, 503-505
intensional definition 295, 652
INTERNIST 21
interpolative memory 697-700
interpretation 49-50, 59-60
inversion 717-718

Java 342
justification-based truth maintenance 276-279

k-connector *see* hyperarc
KEE 347
knight's tour problem 164-170, 175-180, 226,
366-369
knowledge acquisition 216-219
knowledge-base editor 211
knowledge-based system 17-18, 20, 25-26, 36, 47,
203-246, 758; *see also* expert system
knowledge engineering 20, 209-219, 235
knowledge level 340-342, 345, 645
knowledge-level learning 645
knowledge representation 1, 17, 24, 33-41, 45, 206,
240-244, 293-337, 411-421, 497, 503-505,
534, 538-543, 556, 756-757
associationist representation 297-309, 334
conceptual dependencies 294, 305-309, 324-328,
556
conceptual graphs 309-320, 334, 534, 538-543,
551-556, 756
declarative representation 415-421
demons 296
efficiency 333
exceptions 329-331
exhaustiveness 333
extensional representation 295
frame problem 187-191, 333
frames 206, 294, 320-324, 335, 353, 412-415,
534, 538, 756
higher-order logics 334
homomorphism 333
inheritance 40, 294-300, 303, 313-316, 328-331,
355, 411-415, 497, 503-505
intensional representation 295
meta-knowledge 295
modal logics 334

MOPs 308, 328
multiple-valued logics 334, 360
naturalness 331-333
plasticity 333
schemas *see* frames
scripts 294, 308, 324-328, 756
semantic network 10, 23, 36, 40, 107, 206, 294,
299-309, 343, 411-412, 494-497, 518, 527,
756, 767
standardization of network relationships 303-309
taxonomy of representation schemes 294
temporal logics 334
knowledge representation hypothesis 206
Kohonen networks 684-689
KRL 335
KR-ONE 335

labeled graph 84-85
Lady Lovelace's objection 12
lambda expressions 457-458
law of the excluded middle 284
learnability 633-638
learning *see* machine learning
LEX 619-623, 635, 644
lexical closure 482-483
linear associator network 696-700, 702, 711
linear input form 581, 592
linear inseparability 773
link grammars 550
LISP 17, 25, 41, 70, 161, 180, 206, 225, 289, 294,
339, 342-349, 351, 397-398, 425-515, 731,
see also CLOS, Lisp functions
a-list 467-469
and functional programming 425-426
and global variables 459
and symbolic computing 436-438
applying functions 428
association lists 467-469
atom 426
best-first search 462-463
binding 428
binding variables 444-446
bound variable 444-456
breadth-first search 459-461
car/cdr recursion 441-443
class precedence list 503-505
CLOS 347, 497-511
Common Lisp Object System *see* CLOS
conditionals 433-436
control of evaluation 430-431
data abstraction 436-438
data types 448-449
defining classes 499
defining functions 431-433

LISP (*continued*)

- delayed evaluation 482-486
 - depth-first search 449-455, 459-460
 - dotted pairs 468
 - evaluation 427-431
 - expert system shell 486-494
 - farmer, wolf, goat cabbage problem 449-455
 - filters 455-457
 - form 428-430
 - free variable 445
 - function closure 482-483
 - functional arguments 457-458
 - generic functions 498, 501-503
 - higher-order functions 455-458
 - inheritance 497, 503-505
 - lambda expressions 457-458
 - lexical closure 482-483
 - list defined 426-427
 - local variables 446-448
 - logic programming 472-481
 - maps 455-457
 - meta-classes 505
 - meta-interpreters 469-472
 - meta-linguistic abstraction 472
 - multiple inheritance 503-505
 - nil 427
 - pattern matching 463-469
 - predicates 433-436
 - procedural abstraction 455-458
 - program control 433-436, 453-454
 - property list 494-497
 - read-eval-print loop 427, 469-472
 - recursion 438-443
 - s-expression 426, 429-430, 731
 - semantic networks 494-497
 - simulation 505-511
 - slot options 499-501
 - slot-specifiers 499-501
 - special declaration 481
 - state-space search 449-455
 - streams 474-476, 482-486
 - streams and delayed evaluation 482-486
 - thermostat simulation 505-511
 - tree-recursion 441-443
 - unification 463-469
- LISP functions
- * 428
 - + 428
 - 428
 - < 434
 - = 428-434
 - > 428
 - >= 434
 - acons 469
 - and 435
 - append 441
 - apply 456-457
 - assoc 468-469
 - car 438-439
 - case 509
 - cdr 438-439
 - cond 433-434
 - cons 439
 - declare 481
 - defclass 499-501
 - defgeneric 501-503
 - defmethod 503
 - defun 432-433
 - eq 452
 - equal 439
 - eval 430-431, 456-457
 - funcall 456-457
 - gensym 480-481
 - get 495
 - if 435
 - length 429
 - let 446-448
 - list 429
 - listp 448
 - mapcar 457-458
 - member 429, 434-435, 460
 - minusp 434
 - nth 428-429
 - null 429, 448
 - numberp 434
 - oddp 434-435
 - or 435
 - plusp 434
 - print 435-436
 - quote 430-431
 - read 470
 - remprop 496
 - set 444
 - setf 446
 - setf 444, 495
 - terpri 470
 - zerop 434
 - / 428
 - literal 567, 573, 589
 - logic 5, 7-10, 13-15, 19, 33, 37-41, 46-84, 90, 107-120, 160, 164-170, 179, 183-184, 188-196, 294, 297-298, 318-320, 343, 350, 358-361, 427, 560, 566-589, 593, 607-608, 758-759; *see also* propositional calculus; first-order predicate calculus; automated reasoning
 - logic programming 347, 350, 472-481, 587-593
in LISP 472-481
 - logic theorist 203, 560-562

- logical inference 107-108
- logically follows 64-66
- LOGO 215, 352
- long-term memory 173
- LT *see* Logic Theorist

- machine learning 16-17, 21, 25, 28, 30, 41, 43, 45, 237, 351, 517-518, 520, 603-712, 760, 770-775
 - AM 25, 649-650
 - analogical 607, 646-649
 - autoassociative memory 696-711
 - BACON 650
 - bidirectional associative memory 702-706
 - candidate elimination algorithm 613-620
 - category formation 605
 - classification 668, 672
 - CLUSTER/2 605, 635, 652-653, 684
 - COBWEB 605, 653-658, 684
 - competitive learning 662, 682-690
 - concept learning 605
 - concept space 606, 608
 - conceptual clustering 605-606, 651-653
 - conjunctive bias 636
 - connectionist 603-604, 661-712
 - counterpropagation 663, 683, 686-690
 - covering a concept 613
 - credit assignment 623; *see also* bucket brigade algorithm
 - decision trees 624-633, 636
 - discovery 649-650
 - emergent computation 713-749
 - empiricist's dilemma 771, 773-775
 - EURISKO 650
 - evolutionary learning *see* genetic learning
 - explanation-based 605-606, 638-646
 - generalization 607-615, 620-621, 642-643, 771
 - genetic learning 604
 - Grossberg learning 686-690
 - Hebbian learning 688-696
 - heuristics 607, 619-624, 634-636, 645
 - hill climbing 675
 - Hopfield nets 701, 706-711
 - ID3 26, 249, 547-548, 605, 619, 624-636, 650, 680
 - IL 650
 - induction 603-633, 771-775
 - inductive bias 604-605, 624; 633-639, 662, 772-773
 - information theoretic selection 628-631
 - knowledge-level learning 645
 - Kohonen networks 684-689
 - learnability 633-638
 - learning search heuristics 619-623
 - LEX 619-623, 635, 644
 - meta-DENDRAL 26, 199, 639-640, 773
 - near miss 608-610
 - negative instances and overgeneralization 615-616
 - neural networks *see* connectionist models of intelligence
 - operationality criteria 641
 - overgeneralization 615-616
 - PAC learning 638
 - performance evaluation 623-624, 632-633, 680, 721-725
 - similarity-based learning 605, 638
 - specialization 608-615
 - speed-up learning 645
 - supervised Hebbian learning 694-696
 - supervised learning 605, 613, 694-696
 - symbol-based 603-660
 - taxonomic learning 651-658
 - top-down decision tree induction 627-628
 - unsupervised Hebbian learning 691-694
 - unsupervised learning 605, 649-658, 691-694
 - version space search 605, 612-624
 - winner-take-all learning 682-690
- macro operator 193-196
- MACSYMA 111-113
- Markov algorithm 172
- Markov chains 522
- Markov models 545-546
- McCulloch-Pitts neuron 662-666
- means-ends analysis 204, 560-566, 757, 766-767
- meta-knowledge 180
- meta-classes 505
- meta-DENDRAL 26, 199, 639-640, 773
- meta-interpreters 357-358, 389-391, 397-415, 469-472
- meta-linguistic abstraction 398, 472
- meta-planning 199
- metaphor 520
- mgu *see* most general unifier
- micro-world 22
- mind-body problem 6-7, 30
- minimax 127, 144-152, 156-157
 - to fixed ply depth 147-150
- minimum distance classification 669
- minimum models 273-275
- modal logics 334
- model 65-67
- model-based reasoning 206, 230-235, 243
- modular theories of mind 763
- modus ponens 5, 65-68, 77-78, 81, 164-165, 561, 567, 593, 596
- modus tollens 66-67, 80
- monotonicity 127, 139, 141-142, 156, 758

- Monte Carlo replacement algorithms 716
- MOPs 308, 328
- morphology 522, 535
- most general unifier 70
- multi-value logics 334, 360
- multiple belief reasoner 281
- multiple inheritance 329, 503–505
- mutation 717–718, 721, 727–733, 736
- mutual information clustering 547–548
- MYCIN 20–21, 199, 209, 211–212, 230, 249, 263–266, 289, 296

- n-move look ahead 147
- natural deduction 560, 599–600
- natural language understanding 17, 22–23, 28, 30, 34, 45, 116–121, 301–306, 350, 417–421, 517–557
 - and databases 523, 551–555
 - applications 550–555
 - augmentations of logic grammars 534
 - augmented phrase structure grammars 534, 555
 - augmented transition networks 528, 533–538, 556
 - bottom-up parsing 526
 - CART trees 546–547
 - case frame 540
 - case-grammars 555
 - Chomsky hierarchy 531–533, 556
 - combining syntax and semantics 534–542
 - context-free grammars 524–528, 531–533
 - context-sensitive grammars 532–533
 - deep structure 555
 - generation 527, 542
 - grammar 116–121, 524–528, 532–534, 555; *see also* parsing
 - grammatical markers 555
 - link grammars 550
 - Markov chains 522
 - Markov models 545–546
 - metaphor 556
 - morphology 522, 535
 - mutual information clustering 547–548
 - parse tree 118–119, 525–526, 537–538
 - parsing 22, 116–121, 417–421, 520, 523–531, 543–550
 - phonology 522
 - phrase structure 526
 - pragmatics 522, 556
 - prosody 522
 - recursive descent parsing 526
 - semantic grammars 555
 - semantic interpretation 523–524
 - sentential form 525
 - SHRDLU 22, 521
 - statistical techniques *see* stochastic analysis
- stochastic analysis 543–550
- story understanding 550–551
- subject–verb number agreement 532
- surface structure 555
- syntax 521–542
- top-down parsing 525
- transformational grammars 555–556
- transition network parsers 527–531
- Viterbi algorithm 545–546
- near miss 608–610
- nearest neighbor heuristic 92, 121
- negation 48–50, 56, 59–60
 - as failure 360
- NETtalk 679–680
- neural networks *see* connectionist systems
- neuron 26–27, 34, 38, 663–665
- nim 144–146
- NOAH 199
- nonprocedural computing 415–421
- nonmonotonic reasoning 206, 219, 249, 269–283, 360, 520
 - autoepistemic logic 272
 - circumscription 274–275
 - closed world assumption 273–274
 - default logic 272–273
 - defeasibility 270
 - minimum models 273–275
 - modal operators 270–272
 - truth maintenance systems 270, 275–281
- NP completeness 156
- numeric taxonomy 651

- object-oriented programming 12, 25, 206, 294, 334, 345, 352–356, 360, 497–511, 756
 - encapsulation 498
 - inheritance 499
 - polymorphism 498
- object-oriented simulation 505–511
- Occam's Razor 627, 653
- occurs check 69, 467, 593
- operationality criteria 641
- opportunistic planning 199
- OPS 347
- OPS5 174, 184, 199
- order crossover 720–721
- overgeneralization 615–616

- PAC learning 638
- parallel distributed processing *see* connectionist models of intelligence
- paramodulation 598–600
- parse tree 118–119, 525–526, 537–538
- parsing 22, 116–121, 417–421, 520–531, 543–550

- pattern-directed search 164–170, 177; *see also*
 - production systems
- pattern matching *see* unification
- PDP (parallel distributed processing) *see also*
 - connectionist models of intelligence
- penetrance 182
- perceptrons 666–675
 - and exclusive or 667
 - linear seperability 666–667, 670
- permutation 733
- phenomenology 14
- philosophical relativism 14
- phonology 522
- phrase structure 526
- physical symbol system hypothesis 28, 33–34, 41, 343, 756–759, 776
- planning 23–24, 30, 34, 39, 160, 186–196, 199, 357, 386–389, 520, 566
- planning-triangle table 193–196
- plausibility measures 259–260
- ply 147
- possibility theory 284
- possible world 49
- post-modern 14
- posterior probability 250
- pragmatics 522, 556
- predicate 53–58
- predicate calculus *see* first-order predicate calculus
- prelix normal form 570
- prior probability 250
- probability density function 261
- probability theory 249–268, 544, 629–630
- procedural abstraction 455–458
- procedural attachment 323, 583
- procedural semantics 179–180, 229–230
- production rule 171–186
- production systems 12, 46, 120–121, 171–186, 220–231, 375–380, 726–728, 767–770
 - action 171–186
 - advantages 184–185
 - and classifier systemss 726–728
 - condition 171–186
 - conflict resolution 171–186
 - conflict set 171–186
 - control 180–184
 - data-driven reasoning 226–230
 - goal-driven reasoning 220–225
 - production rule 171–186
 - recognize–act cycle 171–186
 - working memory 171–186
- PROLOG predicates
 - | 364
 - ! 369–371
 - * 395
 - + 395
 - 395
 - / 395
 - = 395
 - =.. 390
- append 363
- assert 362
- atom 357
- bagof 382–383
- call 391
- clause 390
- consult 362
- functor 390
- is 395
- listing 363
- member 363, 365
- MOD 395
- nl 366
- nonvar 390
- nospy 363
- retract 362
- see 363
- seen 363
- spy 363
- tell 363
- told 363
- trace 363
- var 390
- write 366
- [] 363–364
- PROLOG 17, 19, 25, 41, 70, 161, 180, 206, 225, 270, 289, 294, 339, 342–351, 357–424, 450, 454–455, 463, 472, 511, 518, 560, 566, 582, 587–594
 - abstract data types 357, 371–375
 - and automated reasoning 587–593
 - and horn clauses 361
 - and logic programming 587–593
 - and relational databases 391–394
 - and resolution theorem proving 587–593
 - anonymous variables 365–366
 - best-first search 384–386
 - breadth-first search 383–384
 - closed world assumption 360, 592–593
 - cut 369–371, 591
 - data types 391–394
 - declarative representation 415–421
 - declarative semantics 357
 - depth-first search 367–369, 381–383
 - difference lists 396
 - evaluation 394–396
 - expert system shell 401–411
 - fact 358
 - frames 412–415

PROLOG (*continued*)

meta-interpreters 358, 397-415
meta-predicates 347, 357, 389-391
negation as failure 360
non procedural computing 415-421
occurs check 593
parsing 417-421
planning 357, 386-389
priority-queue 373-374
production system 375-380
PROLOG in PROLOG 397-399
proof trees 400-401
quantification 361-362
queue 373
recursion 364-369
semantic networks 411-412
set 375-376
stack 371-372
unification 394-396
variables 358
proof procedures 66
proof tree 400-401, 569, 575, 578, 642-643
propositional calculus 47-51, 107-108, 110-111,
573-575
conjunction 48-50
disjunction 48-50
implication 48-50
interpretation 49-50
negation 48-50
propositions 48-49
semantics 49-51
sentence 47-49
symbols 47-48
syntax 47-49
truth symbol 48-49
truth table 50-51
well-formed formula 48-49
prosody 522
PROSPECTOR 21, 95, 252, 263
protocol analysis 766
PROTOS 235
PUFF 212

qualitative probabilistic network 256-258
quantification 56-58, 61-63, 318-320, 361-362,
569-572, 585-586

range of a function 53
rationalism 13-14, 772-773
read-eval-print loop 427, 469-472
reasoning with uncertainty 248-292
recency 184
recognize-act cycle 171-186, 220
recursion 160-163, 364-369, 438-443; *see also*

and search 161-170
recursive descent parsing 526
recursive function theory 351
recursively enumerable languages 532
refraction 184
refutation 566-577
refutation completeness 566-567, 579
relational database 552
representational indeterminacy 776
resolution 30, 66-67, 350, 560, 566-577, 580-593,
597-600
resolution refutation 566, 568-577
and logic programming 587-593
and PROLOG 587-593
answer extraction 574, 583-587, 592
binary resolution 567, 573-578, 597
breadth-first strategy 579-580
clashing 568
clause form 567-573
completeness 566
converting to clause form 568-573, 576
demodulation 598-599
factoring 575
heuristics 578-583
hyperresolution 575, 597
linear input form 581, 592
literal 567
paramodulation 598-600
prenix normal form 570
refutation 566-567, 573-577
refutation completeness 566-567, 579
resolution refutation 568-573
set of support 580, 600
soundness 566
subsumption 583, 600
unit preference 580-581, 592
unit resolution 581, 600
RETE algorithm 230, 237
robot *see* robotics
robotics 23-24, 30, 39, 160, 186-196, 765
rooted graph 85-86
ROSIE 347
rule-based expert systems 206-246; *see also*
expert-systems

s-expression 426, 429-430, 731
Samuel's checker player 127, 148, 757
Santa Fe Institute 715
satisfiability 65-67
schemas *see* frames
SCHEME 351
scope of quantifier 60
scripts 294, 308, 324-328, 756
and conceptual dependencies 324

- scripts (*continued*)
- between-the-lines problem 326
 - entry conditions 325
 - roles 325
- search *see* state-space search
- self-organizing networks 685
- semantic grammars 555
- semantic network 10, 23, 36, 40, 107, 206, 294, 299–309, 343, 411–412, 494–497, 518, 527, 756, 767
- semantics 22–23, 27–28, 37–41, 47, 49–52, 58–63, 120, 179–180, 349, 778
- set of support 560, 580, 600
- SHAKEY 192
- short-term memory 173
- SHRDLU 22, 521
- similarity-based learning 605
- Simula 352
- simulation 505–511
- situated action theory 764–766
- situatedness 14–16
- skolem function 68
- skolemization 68, 569–571
- Smalltalk 30, 352
- SOAR 174, 770
- social models of learning 736–747; *see also* emergent computation
- society of mind 770
- solution path 87
- soundness 65–67, 566, 593
- specificity 184
- speech understanding 196–198
- speed-up learning 645
- SQL 551–554
- standardization of network relationships 303–309
- Stanford certainty factor algebra *see* certainty factor algebra
- start state 87
- state space search 7, 17, 25–26, 29, 33–34, 41–46, 81–122, 127, 130, 132–134, 139–144, 152–157, 159–201, 227, 361, 364–371, 449–455, 459–460, 560, 592, 628, 657, 723, 755, 757–758
- admissibility 127, 139–142, 156–157, 758
 - Algorithm A 140
 - Algorithm A* 127, 139–144, 156–157
 - alpha-beta pruning 127, 150–152, 156
 - and logical inference 108–120
 - and planning 190–196
 - and propositional calculus 107–111
 - and/or graphs 109–121
 - backtracking 96–101, 110, 130, 160, 163, 176, 198, 223, 361, 368, 592
 - backward chaining 93–96, 112–116
 - beam search 154
 - best-first search 99, 107, 124, 127–130, 156
 - branch and bound 92
 - branching factor 96
 - breadth-first search 99–105, 124
 - complexity 88–89, 91–92, 105–106, 124–127, 152–155
 - data driven search 93–96, 121, 181–183, 198, 206, 226–230, 594–595
 - defined 87
 - depth-first iterative deepening 106
 - depth-first search 99, 102–106, 124, 159–163, 174, 367–369, 381–383, 449–460, 560, 592
 - exhaustive search 91
 - forward chaining 93–96
 - goal driven search 93–96, 112–116, 121
 - hill-climbing 127, 129, 628, 657, 675, 723, 757
 - implementation 96–106, 159–201
 - informedness 129, 139, 142–144, 153–155, 758
 - minimax 127, 144–152, 156–157
 - monotonicity 127
 - opportunistic search 227
 - pattern-directed search 164–170; *see also* production systems
 - production systems 160, 171–186
 - recursive search 161–170
 - shortest path 132–134, 139–142
 - solution path 87
 - state 42
 - subgoal 93
 - uninformed search 106
- statistical approaches to uncertainty 249–268
- stochastic analysis 543–550
- story understanding 550–551
- streams 474–476, 482–486
- and delayed evaluation 482–486
- STRIPS 192–196, 199, 566, 640
- strong methods 758
- structure mapping 647
- subgoal 93, 164, 167
- subjective probabilities 259–260
- subsumption 583, 600
- subsumption architecture 741–742
- supervised learning 605, 613, 694–696
- syllogism 67
- symbol level 340–342
- symbolic computing 436–438
- synapse 26
- syntax 47–49
- systematicity 648–649
- Tarskian semantics *see* first-order predicate calculus; semantics; propositional calculus; semantics
- taxonomy 769–770
- taxonomy of representation schemes 294

- Teiresias 199, 269
- teleo-reactive agents 742
- teleo-reactive planning 199
- temporal logics 334
- term 54
- theorem proving *see* automated reasoning
- thermostat simulation 505-511
- tic-tac-toe 42, 88-89, 107, 124-127, 149-152
- top-down decision tree induction 627-628
- top-down parsing 525
- towers of Hanoi 768
- transformational analogy 239-240
- transformational grammars 555-556
- transition network parsers 527-531
- traveling salesperson 91-92, 121, 717, 719-721
- tree-recursion 441-443
- triangle table 46, 193-196
- truth maintenance systems 249, 270, 275-281
 - assumption-based truth maintenance 278-281
 - chronological backtracking 276
 - dependency-directed backtracking 276
 - justification-based truth maintenance 276-279
 - logic-based 281
 - multiple belief reasoner 281
- truth symbol 48-49, 53-54
- truth table 50-51, 79
- truth value 59-60
- Turing Test 10-13, 30, 31, 34, 209
- tutoring systems 768
- type hierarchy 529-543

- uncertainty *see* reasoning with uncertainty
- undecidability 60-61
- unification 67-78, 113-114, 160, 165, 169, 181, 344, 364, 368, 394-396, 463-469, 583-587

- algorithm defined 71-74
- and PROLOG 394-396
- answer extraction 583-587, 592
- binding 69-70
- composition of substitutions 69-70, 592
- ground instance 69
- in LISP 463-469
- most general unifier (mgu) 70
- occurs check 69, 467
- substitution 69
- uninformed search 106
- unit preference 560, 580-581, 592
- unit resolution 581, 600
- universal instantiation 66-68
- universal quantification 56-58, 61-63, 318-319, 361-362, 569-572
- unsatisfiability 65-67
- unsupervised learning 605, 649-658, 691-694

- validity 65-67
- variable 53-63
- verification 19, 21
- version space search 605, 612-624
- Viterbi algorithm 545-546

- weak methods 518, 560, 758
- well-formed formula 9, 48-49
- WFF *see* well-formed formula
- why query 211, 224-225, 399-400
- winner-take-all learning 682-690
- working memory 171-186, 227

- XCON 21, 174, 209, 212, 214, 758

ACKNOWLEDGEMENTS

Figure 3.22 from *Problem Solving Methods in Artificial Intelligence* by N. Nilsson. Copyright © 1971 by McGraw-Hill. Reprinted by permission.

Figure 4.22 from *Principles in Artificial Intelligence* by N. Nilsson. Copyright © 1980 by Morgan Kaufmann. Reprinted by permission.

Figure 8.1 from *Expert Systems: AI in Business* by P. Harmon and D. King. Copyright © 1985 by John Wiley & Sons. Reprinted by permission.

Figures 8.3 and 8.4 from *Word Concepts: A Theory and Simulation of Some Basic Capabilities* by Ross Quillian. Copyright © 1967 by Society of General Systems Research. Reprinted by permission.

Figures 8.6, 8.9, and 8.10 from "Inference and the Computer Understanding of Natural Language" by R. Schank and C.J. Rieger in *Artificial Intelligence*. Copyright © 1974 by Elsevier Science Publishers. Reprinted by permission.

Figure 8.8 from *Computer Models of Thought and Language* by R. Schank and K. Colby. Copyright © 1973 by W.H. Freeman and Co. Reprinted by permission.

Figure 9.25 from "A Framework for Representing Knowledge" by M. Minsky in *Psychology of Computer Vision* by P. Winston. Copyright © 1975 by McGraw-Hill. Reprinted by permission.

Figure 8.26 from *Scripts, Plans, Goals, and Understanding* by R. Schank and R. Abelson. Copyright © 1977 by Lawrence Erlbaum Assoc. Reprinted by permission.

Figure 12.1 from "GPS: A Program that Simulates Human Thought" by A. Newell and H.A. Simon in *Lernende Automaten*. Copyright © 1961 by R. Oldenbourg. Reprinted by permission.

Figure 12.2 from *Computers and Thought*, edited by E.A. Feigenbaum and J. Feldman. Copyright © 1963 by McGraw-Hill. Reprinted by permission.

Part II, p. 33; Chapter 4, p. 123; and Chapter 16, p. 751: A Newell and H.A. Simon, ACM Turing Award Lecture, 1976. Copyright © 1976, Association for Computing Machinery, Inc.

Chapter 6, p. 207: Excerpt from *Knowledge Based Systems in Artificial Intelligence* by Randall Davis. Copyright © 1982, p. 330. Reprinted with permission from McGraw-Hill Publishing, Inc.

Part VI, p. 751: J. Hopcroft, ACM Turing Award Lecture, 1987. Copyright © 1987, Association for Computing Machinery, Inc.

Chapter 3, p. 81: Copyright © 1916 by Holt, Rinehart and Winston, Inc., and renewed 1944 by Robert Frost. Reprinted from *The Poetry of Robert Frost*, edited by Edward Connery Lathem, by permission of Henry Holt and Company, Inc.

Chapter 4, p. 123: Copyright © 1957 Jerry Lieber Music, Mike Stoller Music, Chappell & Co. (renewed). All rights reserved. Used by permission.

Chapter 12, p. 559: Larry Wos, *Automated Reasoning*, Copyright © 1984, p. 450. Prentice-Hall, Inc., Englewood Cliffs, New Jersey. Excerpt from "Decision-Making and Administrative Organization" by H.A. Simon from *Pub. Admin. Rev.*, 4: Winter, 1944. American Soc. for Public Administration.

Chapter 5, p. 159: Excerpt from "Little Gidding" in *Four Quartets*, Copyright © 1943 by T.S. Eliot, renewed 1971 by Esme Valerie Eliot, reprinted in the U.S. by permission of Harcourt Brace Jovanovich, Inc. Reprinted outside the U.S. by permission of Faber & Faber Ltd. from *Four Quartets* by T.S. Eliot.

Chapter 16, p. 753: Excerpt from "Choruses from the Rock" by T.S. Eliot, Copyright © 1936 by Harcourt Brace Jovanovich, Inc., Copyright © 1963, 1964 by T.S. Eliot, reprinted in the U.S. by permission of Faber and Faber Ltd. from *Collected Poems 1909–1962* by T.S. Eliot.

Chapter 8, p. 293: Excerpt from "The Naming of Cats" in *Old Possum's Book of Practical Cats*, Copyright © 1939 by T.S. Eliot, renewed 1978 by Esme Valerie Eliot, reprinted in the U.S. by permission of Harcourt Brace Jovanovich, Inc. Reprinted outside the U.S. by permission of Faber & Faber Ltd. from *Old Possum's Book of Practical Cats* by T.S. Eliot.

Chapter 14, p. 661–712, appeared in an earlier form in *Cognitive Science: The Science of Intelligent Systems*, by George F. Luger, Copyright © 1994 by Academic Press, Orlando FL. Used by permission.

Chapter 15, Figures 15.14, 15.15, and 15.16, adapted from *Evolving Cellular Automata with Genetic Algorithms: A Review of Recent Work*, by Mitchell et al., Copyright © 1996, Moscow: Russian Academy of Sciences. Used by Permission.