

MIG/MAG Welding Guide



For Gas Metal Arc Welding (GMAW)

This booklet contains basic guidelines on
the Gas Metal Arc Process.

The basic information is from “Recommended Practices for
Gas Metal Arc Welding”, AWS C5.6-89. It has been
edited and is reprinted through the courtesy of the
American Welding Society.

Mild Steel procedures were developed by
The Lincoln Electric Company.

Aluminum procedures are from
THE ALUMINUM ASSOCIATION

Stainless Steel procedures are primarily from
JOINING OF STAINLESS STEEL
published by
American Society for Metals.



Welding Aluminum: Theory and Practice

The Aluminum Association 
Incorporated

This book has been prepared by H.L. Saunders, Consultant, Alcan (Retired), with information and assistance from the Aluminum Association and from member companies represented on the Technical Advisory Panel on Welding and Joining.

Mr. Saunders (BASc, Mechanical Engineering, University of British Columbia) has 36 years of experience in the aluminum welding industry. He has been active in AWS, CSA, WIC and undertaken special studies for the National Research Council and the Welding Research Council. He was a former member and Chairman of the Aluminum Association's Technical Committee on Welding and Joining.

Technical Advisory Panel on Welding and Joining:

B. Alshuller, Alcan (Chairman)
P. Pollak, Aluminum Association (Secretary)
P.B. Dickerson, Consultant, Alcoa (Retired)
F. Armao, Alcoa
Eric R. Pickering, Reynolds Metals

Use of the Information

Any data and suggestions contained in this publication were compiled and/or developed by the Aluminum Association, Inc. In view of the variety of conditions and methods of use to which such data and suggestions may be applied, the Aluminum Association and its member companies assume no responsibility or liability for the use of information contained herein. Neither the Aluminum Association nor any of its member companies give any warranties, express or implied, in respect to this information.

Third Edition • November 1997

Copyright © 1991 by The Aluminum Association, Inc.

Library of Congress Catalog Card Number: 89-80539

GAS METAL ARC WELDING GUIDE

CONTENTS

I. INTRODUCTION	1
II. FUNDAMENTALS	1
Principles of Operation	1
Characteristics	2
III. TRADITIONAL MODES OF METAL TRANSFER	3
Axial Spray Transfer	3
Globular Transfer	3
Short Circuiting Transfer	3
IV. HIGH LEVEL MODES OF METAL TRANSFER	4
Pulsed Spray Transfer (GMAW-P)	4
Surface Tension Transfer	4
V. EQUIPMENT	4
Semiautomatic Welding Gun and Accessories	5
Wire Feed Motor	6
Welding Control	6
Shielding Gas Regulators	6
Power Source	6
Power Supply Variables	9
Voltage	9
Slope	9
Inductance	10
Automatic Welding Equipment	11
VI. PROCESS REQUIREMENTS AND APPLICATIONS	11
Shielding Gas	11
Inert Shielding Gases, Argon and Helium	12
Mixtures of Argon and Helium	14
Oxygen and CO ₂ Additions	14
Carbon Dioxide	14
Shielding Gas Selection	14
Electrodes	15
Composition	15
Formulation	15
Selection of Process Variables	15
Equipment Selection	15
Mode of Metal Transfer and Shielding Gas	15
Design and Service Performance	15
Process Control	15
Appearance	15
Electrode Selection	17
Equipment	17
Weld Size	17
Standardization and Inventory	17
Materials Handling System	17
Operating Conditions	17
Deposition Rate	17
Welding Current — Wire Feed Speed	18
Welding Voltage	18
Electrode Stickout	18
Guidelines for Operating Conditions	23

VII. PROCEDURES FOR CARBON STEELS	24
Welding Recommendations	24
Wire Feed Speed	24
Arc Voltage	24
Shielding Gas and Gas Mixtures	24
Carbon Dioxide	24
Argon	24
Argon and Carbon Dioxide	24
Preheat & Interpass	25
Horizontal Fillets or Flat Butt Welds by Short Circuiting	26
Vertical Down Fillets or Square Butt Welds by Short Circuiting	26
Vertical Up Welds by Short Circuiting	27
Flat and Horizontal Fillet Welds by Spray Transfer	27
Flat Butt Welds by Spray Transfer	28
Flat and Horizontal Fillet Welds by Pulsed Spray Transfer	28
Vertical Up Fillet Welds by Pulsed Spray Transfer	29
VIII. WELDING STAINLESS STEEL	29
Spray Arc Transfer	29
Short Circuiting Transfer	29
Procedure Range Blue Max MIG	30
Flat Butt Welds by Spray Transfer	30
Flat and Horizontal Fillets and Flat Butts by Spray-Arc Transfer	31
Horizontal Flat Fillets or Flat Butt Welds by Short Circuiting	32
Pulsed-Arc Transfer	32
Flat and Horizontal Fillets by Short Circuit Transfer	33
Vertical Up Fillets by Short Circuit Transfer	34
Flat and Horizontal Fillets by Pulsed Spray Transfer	34
IX. WELDING ALUMINUM	35
Horizontal Fillets with 5356 Filler Wire	35
Horizontal Fillets with 4043 Filler Wire	36
Flat Butt Welds with 5356 Filler Wire	36
Flat Butt Welds with 4043 Filler Wire	37
Flat and Horizontal Fillet Welds by Pulsed Spray Transfer	37
X. SAFE PRACTICES	38
Introduction	38
Handling of Shielding Gas Cylinders & Regulators	38
Cylinder Use	38
Gases	38
Ozone	38
Nitrogen Dioxide	38
Carbon Monoxide	38
Metal Fumes	38
Radiant Energy	39
Noise — Hearing Protection	39
Arc Welding Safety Precautions	40-42
XI. PRODUCT REFERENCES	39

<p>The serviceability of a product or structure utilizing this type of information is and must be the sole responsibility of the builder/user. Many variables beyond the control of The Lincoln Electric Company affect the results obtained in applying this type of information. These variables include, but are not limited to, welding procedure, plate chemistry and temperature, weldment design, fabrication methods and service requirements.</p>
--

Note: The U.S. customary units are primary in this publication. However, the approximate equivalent SI values are listed in text and tables to familiarize the reader with the SI system of metric units.

I. INTRODUCTION

This publication describes the basic concepts of the gas metal arc welding (GMAW) process. It will provide the reader with a fundamental understanding of the process and its variations. This knowledge, combined with basic information about other welding processes, will be helpful in selecting the best welding process for the materials to be joined. In addition, the reader will find specific technical data which will be a guide in establishing optimum operation of this process.

The GMAW process was developed and made commercially available in 1948, although the basic concept was actually introduced in the 1920's. In its early commercial applications, the process was used to weld aluminum with an inert shielding gas, giving rise to the term "MIG" (metal inert gas) which is still commonly used when referring to the process.

Variations have been added to the process, among which was the use of active shielding gases, particularly CO₂, for welding certain ferrous metals. This eventually led to the formally accepted AWS term of gas metal arc welding (GMAW) for the process. Further developments included the short circuiting mode of metal transfer (GMAW-S), a lower heat energy variation of the process that permits welding out-of-position and also on materials of sheet metal thicknesses; and a method of controlled pulsating current (GMAW-P) to provide a uniform spray droplet metal transfer from the electrode at a lower average current levels.

The GMAW process uses either semiautomatic or automatic equipment and is principally applied in high production welding. Most metals can be welded with this process and may be welded in all positions with the lower energy variations of the process. GMAW is an economical process that requires little or no cleaning of the weld deposit. Warpage is reduced and metal finishing is minimal compared to stick welding.

II. FUNDAMENTALS

Principles of Operation. GMAW is an arc welding process which incorporates the automatic feeding of a continuous, consumable electrode that is shielded by an externally supplied gas. Since the equipment provides for automatic self-regulation of the electrical characteristics of the arc and deposition rate, the only manual controls required by the welder for semiautomatic operation are gun positioning, guidance, and travel speed. The arc length and the current level are automatically maintained.

Process control and function are achieved through these three basic elements of equipment (See Fig. 1):

1. Gun and cable assembly
2. Wire feed unit
3. Power source

The gun and cable assembly performs three functions. It delivers shielding gas to the arc region, guides the consumable electrode to the contact tip and conducts electrical power to the contact tip. When the gun switch is depressed, gas, power, and electrode are simultaneously delivered to the work and an arc is created. The wire feed unit and power source are normally coupled to provide automatic self-regulation of the arc length. The basic combination used to produce this regulation consists of a constant voltage (CV) power source (characteristically providing an essentially flat volt-ampere curve) in conjunction with a constant speed wire feed unit.

Some GMAW equipment, however, uses a constant current (CC) power source (characteristically providing a drooping volt-ampere curve) plus an arc voltage-controlled wire feed unit. With this latter combination, arc voltage changes, caused by a change in the arc length, will initiate a response in the wire feed unit to either increase or decrease the wire feed speed to maintain the original arc length setting. The arc length self-regulation produced by the constant voltage (CV) power supply-constant speed wire feed unit combination is described in detail in Section III.

In some cases (the welding of aluminum, for example), it may be preferable to couple a constant current power source with a constant speed wire feed unit. This combination will provide only a small degree of automatic self-regulation and can be quite demanding in technique and set-up for semiautomatic welding. However, some users think this combination affords the range of control over the arc energy that is considered important in coping with the high thermal conductivity of the aluminum base metal.

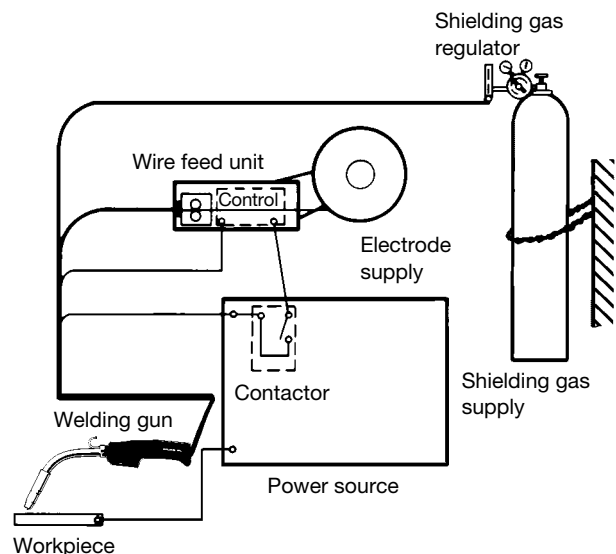

FIGURE 1 — Basic GMAW equipment.

Characteristics. The characteristics of GMAW are best described by the five basic modes of transfer which may occur with the process. Three traditional modes of transfer are short circuiting, globular and axial spray. With more recent developments in power source technology, two higher level transfer modes, pulsed spray and Surface Tension Transfer™ (STT) have been developed. Even though these power sources are more expensive, the advantages enable users to easily justify the additional cost on many applications.

Axial spray and globular transfer are associated basically with relatively high arc energy. With the occasional exception of the spray mode in very small diameter electrodes, both axial spray and globular transfer are normally limited to the flat and horizontal welding positions with material thicknesses of not less than 1/8 in. (3.2 mm). Pulsed spray transfer, in which the average energy level is reduced, is another exception (see GMAW-P). STT and traditional short circuiting transfer are relatively low energy processes generally limited to metal thicknesses not more than 1/8 in. (3.2mm), but is used in all welding positions.

The physical weld metal transfers are understood and can be described as shown in Figure 2. Pinch force is responsible for detaching the molten metal from the electrode and propelling it across the arc to the base metal. This momentary necking of the liquid portion of the electrode is a result of the current flow. Electromagnetic forces are produced and controlled by the amount of current flowing through the electrode to the work.

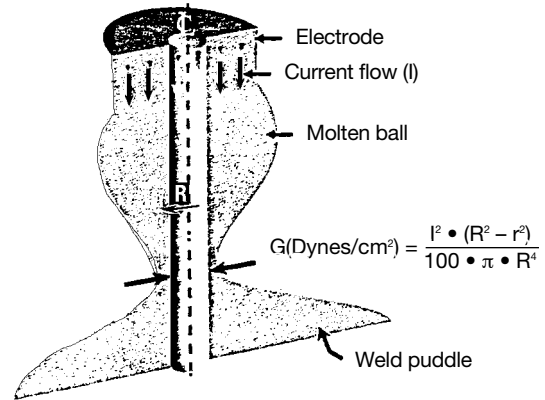

FIGURE 2 — Metal transfer as described by the Northrup equation.

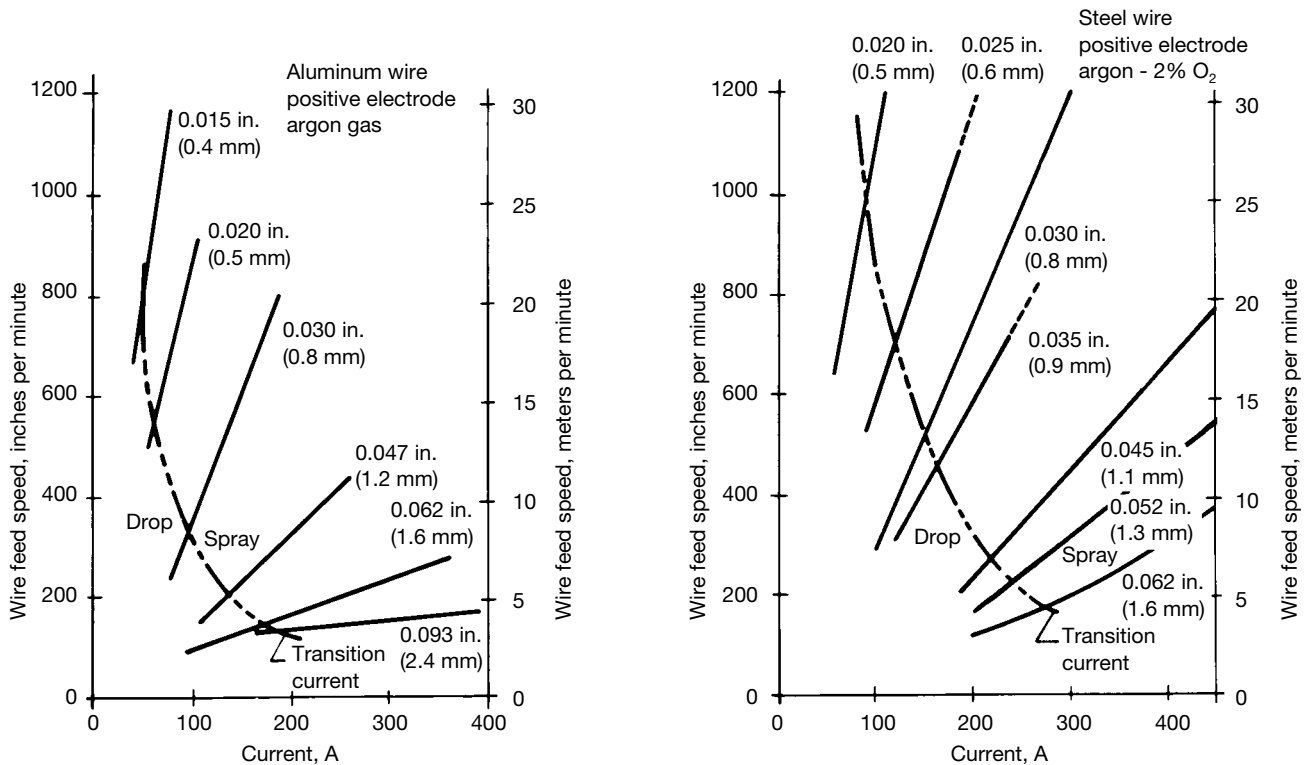

FIGURE 3 — Burnoff curves of aluminum and steel gas metal arc electrodes.

III. TRADITIONAL MODES OF METAL TRANSFER

Axial Spray Transfer (gas shield with a minimum of 80 percent argon). In this mode, metal transfer across the arc is in the form of droplets of a size equal to or less than the electrode diameter. The droplets are directed axially in a straight line from the electrode to the weld puddle. The arc is very smooth and stable. The result is little spatter and a weld bead of relatively smooth surface. The arc (plasma) energy is spread out in a cone-shaped pattern. This results in good “wash” characteristics at the weld bead extremities but yields relatively shallow penetration (shallow depth of fusion). Penetration is deeper than that obtained with shielded metal arc welding (SMAW) but less than can be obtained with the high energy globular transfer mode of GMAW.

The axial spray transfer mode is established at a minimum current level for any given electrode diameter (current density). This current level is generally termed “the transition current” (See Figs. 3 and 4). A well defined transition current exists only with a gas shield containing a minimum of 80 percent argon. At current levels below the transition current the drop size increases [larger than the diameter of the electrode (See Figs. 4 and 5)]. The arc characteristics are quite unstable in this operating range.

Globular Transfer (gas shield with CO₂ or helium). In this mode, metal transfer across the arc is in the form of irregular globules randomly directed across the arc in irregular fashion (See Fig. 5), resulting in a considerable amount of spatter.

Spatter is minimized when using a CO₂ shield by adjusting the welding conditions so that the tip of the electrode is below the surface of the molten weld metal and within a cavity generated by the force of the arc. The CO₂ arc is generally unstable in nature and characterized by a “crackling” sound. It presents a weld bead surface that is rough in appearance (ripple effect) in comparison to a bead obtained with axial spray transfer. Since most of the arc energy is directed downward and below the surface of the molten weld metal, the weld bead profile exhibits extremely deep penetration with a “washing” action at the weld bead extremities that is less than that obtained in the axial spray transfer mode. Relative stability of the CO₂ arc can be established at higher current levels using a buried arc.

When helium-rich gas mixtures are used, a broader weld bead is produced with a penetration depth similar to that of argon, but with a more desirable profile.

Short Circuiting Transfer. In the short circuiting, low energy mode, all metal transfer occurs when the electrode is in contact with the molten puddle on the work-piece. In this mode of metal transfer, the power source characteristics control the relationship between the intermittent establishment of an arc and the short circuiting of the electrode to the work (See Fig. 6). Since the heat input is low, weld bead penetration is very shallow and care must be exercised in technique to assure good fusion in heavy sections. However, these characteristics permit welding in all positions. Short circuiting transfer is particularly adaptable to welding thin gauge sections.

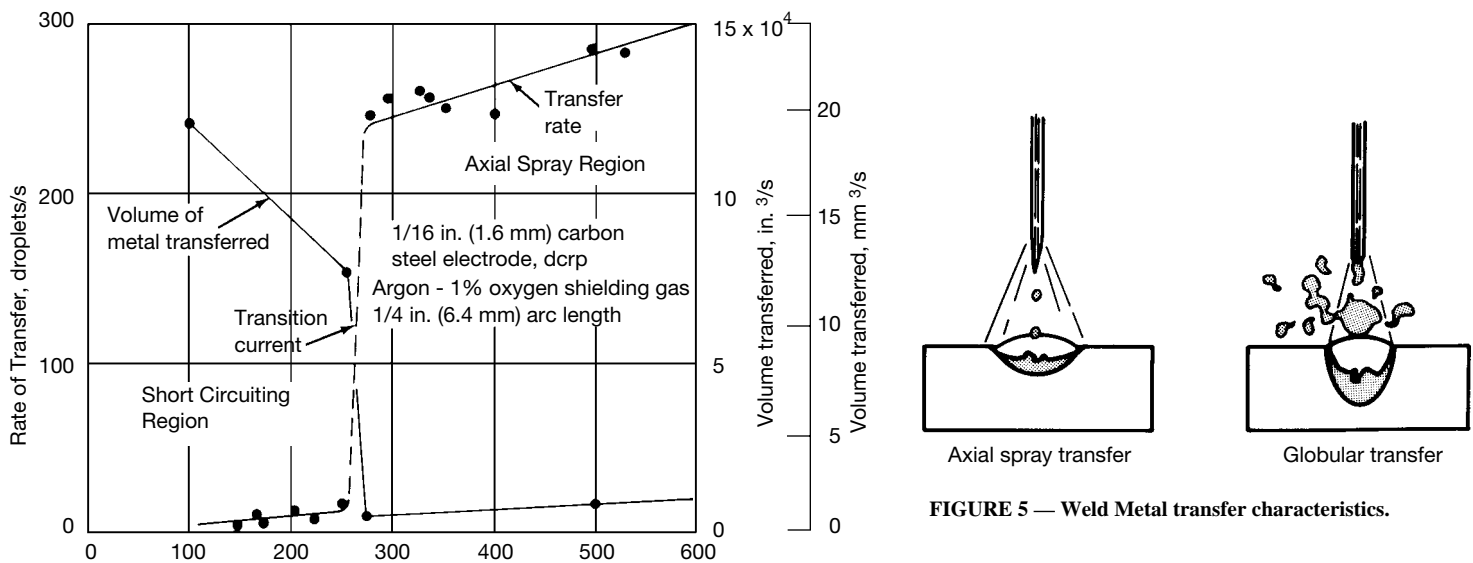

FIGURE 4 — Variation in volume and transfer rate of drops with welding current (steel electrodes).

FIGURE 5 — Weld Metal transfer characteristics.

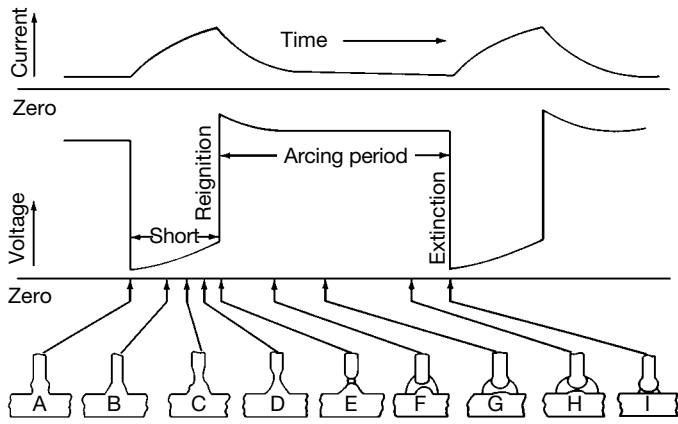
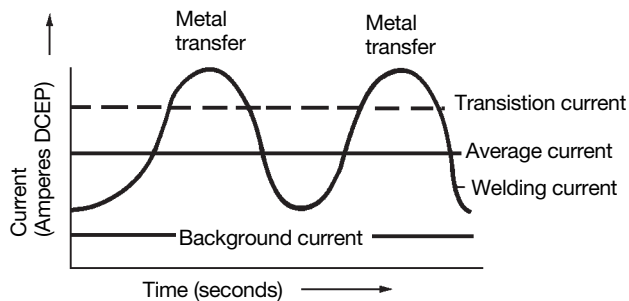

FIGURE 6 — Oscillograms and sketches of short circuiting arc metal transfer.

IV. HIGH LEVEL MODES OF METAL TRANSFER SPRAY

Pulsed Spray Transfer (GMAW-P). Pulsed spray transfer (GMAW-P) is a variation of spray transfer where the power source quickly pulses between a peak and background current for a fixed period of time (See Figure 7). In doing so, there is greater control of the metal transfer. Because of this, pulse spray is capable of all position welding at a higher energy level than short circuit, thus reducing the chances of cold lapping. Pulsed spray also has better arc stability at high wire feed speeds.

Most power sources capable of pulse welding operate as current controlled (CC) units rather than constant voltage (CV). These high speed microprocessor controlled inverter systems are capable of switching from peak to background at over 40 khz. This high speed switching controls the metal transfer while low speed closed loop samples voltage to control the arc length. This adaptive nature of the power source is more forgiving to contact tip to work changes.



Note: DCEP means Direct Current Electrode Positive.

FIGURE 7 — Volt-ampere curve for pulsed current.

Surface Tension Transfer™ (STT®). STT is a current controlled short circuiting transfer process. The two major differences between STT and traditional short arc are: the welding current is based on the instantaneous requirements of the arc. Wire feed speed and current are independent of one another. The current is always controlled in a logical manner based on what portion of the shorting cycle is being performed (See Figure 7.5).

Just before the wire shorts to the work ($T_1 - T_2$) and prior to molten material separating from the wire ($T_3 - T_5$) current is reduced to minimize spatter. High current is needed in order to quickly neck down the wire ($T_2 - T_3$) or to reignite the arc, re-establish the proper arc length and promote good fusion ($T_5 - T_6$). During the rest of the cycle the current is gently reduced ($T_6 - T_7$) and held at an optimum level controlling the overall heat input to the weld.

V. EQUIPMENT

The GMAW process can be used either semiautomatically or automatically. The basic equipment for any GMAW installation consist of the following:

1. A welding gun
2. A wire feed motor and associated gears or drive rolls
3. A welding control
4. A welding power source
5. A regulated supply of shielding gas
6. A supply of electrode
7. Interconnecting cables and hoses

Typical semiautomatic and automatic components are illustrated in Figs. 9 and 10.

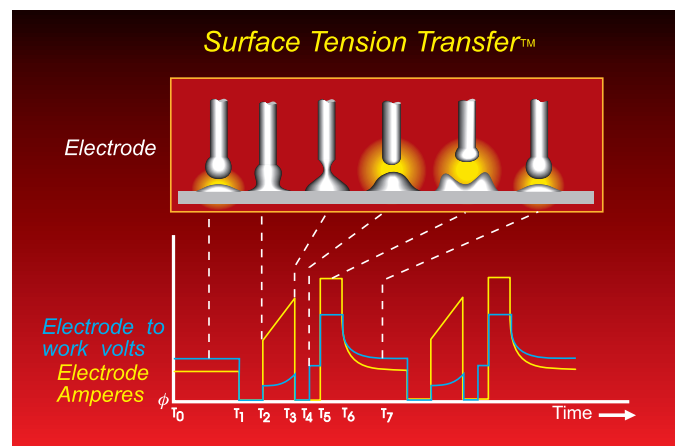

FIGURE 7.5 — Electrode current and voltage waveforms for a typical welding cycle.

SEMIAUTOMATIC WELDING EQUIPMENT

Welding Gun and Accessories. The welding gun (Fig. 8) is used to introduce the electrode and shielding gas into the weld zone and to transmit electrical power to the electrode.

Different types of welding guns have been designed to provide maximum efficiency regardless of the application, ranging from heavy duty guns for high current, high production work to lightweight guns for low current or out-of-position welding.

Water or air cooling and curved or straight nozzles are available for both heavy duty and lightweight guns. Air cooling permits operation at up to 600 amperes with a reduced duty cycle. The same current capacity is available for continuous operation with a water-cooled gun.

The following are basic accessories of these arc welding guns:

1. Contact tip
2. Gas nozzle
3. Electrode conduit and/or liner
4. Gas hose
5. Water hose (for water-cooled guns)
6. Power cable
7. Control switch

The contact tip, usually made of copper or a copper alloy, is used to transmit welding power to the electrode and to direct the electrode towards the work. The contact tip is connected electrically to the welding power source by the power cable. The inner surface of the contact tip is very important since the electrode must feed easily through this tip and also make good

electrical contact. The literature typically supplied with every gun will list the correct size contact tip for each electrode size and material. The contact tip must be held firmly by the collet nut (or holding device) and must be centered in the shielding gas nozzle.

The nozzle directs an even-flowing column of shielding gas into the welding zone. This even flow is extremely important in providing adequate protection of the molten weld metal from atmospheric contamination. Different size nozzles are available and should be chosen according to the application; i.e., larger nozzles for high current work where the weld puddle is large, and smaller nozzles for low current and short circuiting welding.

The electrode conduit and liner are connected to align with the feed rolls of the wire feed unit. The conduit and liner support, protect, and direct the wire from the feed rolls to the gun and contact tip. Uninterrupted wire feed is necessary to insure good arc stability. Buckling or kinking of the electrode must be prevented. The electrode will tend to jam anywhere between the drive rolls and the contact tip if not properly supported. The liner may be an integral part of the conduit or supplied separately. In either case the liner material and inner diameter are important. A steel liner is recommended when using hard electrode materials such as steel and copper, while nylon liners should be used for soft electrode materials such as aluminum and magnesium. Care must be taken not to crimp or excessively bend the conduit even though its outer surface is usually steel-supported. The instruction manual supplied with each unit will generally list the recommended conduits and liners for each electrode size and material.

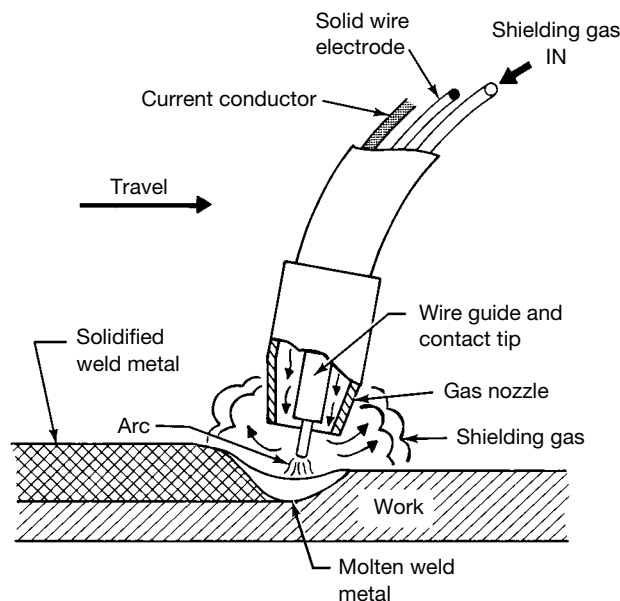

FIGURE 8 — Typical semiautomatic air-cooled, curved-neck gas metal arc welding gun.

The remaining accessories bring the shielding gas, cooling water, and welding power to the gun. These hoses and cables may be connected directly to the source of these facilities or to the welding control. Trailing-gas shields are available and may be required to protect the weld pool during high speed welding.

The basic gun uses a wire feeder to push the electrode from a remote location through the conduit, a distance of typically about 12 ft. (3.7 m). Several other designs are also available, including a unit with a small electrode feed mechanism built into the gun. This system will pull the electrode from a more distant source where an additional drive may also be used to push the electrode into the longer conduit needed. Another variation is the “spool-on-gun” type in which the electrode feed mechanism and the electrode source are self-contained.

Wire Feed Motor. Lincoln wire feeders provide the means for driving the electrode through the gun and to the work. The LN-7 GMA, LN-742, LN-9 GMA, LN-10, LN-25, DH-10, STT-10, Power Feed 10 and Power Feed 11 semiautomatic, constant speed wire feeders have trouble-free solid state electronic controls which provide regulated starting, automatic compression for line voltage fluctuations and instantaneous response to wire drag. This results in clean positive arc starting with each strike, minimizes stubbing, skipping and spatter, and maintains steady wire feeding when welding. All components are totally contained within the feeder box for maximum protection from dirt and weather, contributing to the low maintenance and reliable long life of these wire feeders.

Wire feed speeds on Lincoln GMA wire feeders range from 75 to 1200 inches per minute (1.9 to 30.5 m/min.). The LN-7 GMA has a range from 75 to 700 inches per minute (1.9 to 18 m/min.) and the LN-9 GMA and LN-9F GMA units have a range of 80 to 980 inches per minute (2 to 25 m/min.). LN-25 has a low range of 50 to 350 inches per minute (1.2 to 8.9 m/min.), and a high range of 50 to 700 inches per minute (1.2 to 17.8 m/min.). The LN-7 GMA, LN-9 GMA and LN-9F GMA wire feeders feature dynamic breaking which stops the feed motor when the gun trigger is released to minimize crater sticking problems and simplify restriking.



Lincoln LN-7 GMA Wire Feeder.

The LN-742 has a range of 50 to 770 inches per minute (1.25 to 19.5 m/min.). The LN-742H has a range of 80 to 1200 inches per minute (2.00 to 30.5 m/min.).

A full line of feeders is available with special features such as digital meters and the ability to be directly interfaced with a robotic controller. Lincoln wire feeders can be used with most constant voltage (CV) type power sources. See Lincoln Product Specification Bulletins for complete details and information.

Welding Control. The welding control and the wire feed motor for semiautomatic operation are available in one integrated package (See Fig. 9). The welding control’s main function is to regulate the speed of the wire feed motor, usually through the use of an electronic governor in the control. The speed of the motor is manually adjustable to provide variable wire feed speed, which, with a constant-voltage (CV) power supply, will result in different welding current. The control also regulates the starting and stopping of the electrode feed through a signal received from the gun switch.

Shielding gas, water, and welding power are usually delivered to the gun through the control, requiring direct connection of the control to these facilities and the power supply. Gas and water flow are regulated to coincide with the weld start and stop by use of solenoids. The control can also sequence the starting and stopping of gas flow and energize the power supply output. The control may permit some gas to flow before welding starts as well as a post-flow to protect the molten weld puddle. The control is usually powered by 115 VAC from the power source but may be powered from another source such as the arc voltage.

Shielding Gas Regulators. A system is required to provide constant shielding gas pressure and flow rate during welding. The regulator reduces the source gas pressure to a constant working pressure regardless of variations at the source. Regulators may be single or dual stage and may have a built-in flowmeter. Dual stage regulators provide a more constant delivery pressure than single stage regulators.

The shielding gas source can be a high pressure cylinder, a liquid-filled cylinder, or a bulk liquid system. Gas mixtures are available in a single cylinder. Mixing devices are used for obtaining the correct proportions when two or more gas or liquid sources are used. The size and type of the gas storage source are usually determined by economic considerations based on the usage rate in cubic feet (cubic meters) per month.

Power Source. The welding power source delivers electrical power to the electrode and workpiece to produce the arc. For the vast majority of GMAW applications, direct current with positive polarity is used; therefore, the positive lead must go to the gun and the negative to the workpiece. The major types of direct current power supplies are the engine-generator (rotating), the transformer-rectifier (static), and inverters. Inverters can be used for their small size and high level transfer modes which generally require faster changes in output current. The transformer-rectifier type is usually preferred for in-shop fabrication where a source of electrical power is available. The engine-generator is used when there is no other available source of electrical power, such as in the field.

As GMAW applications increased, it was found that a constant voltage (CV) machine provided improved operation, particularly with ferrous materials. The (CV) power supply, used in conjunction with a constant wire feed speed, maintains a constant voltage during the welding operation. The major reason for selecting (CV) power is the self-correcting arc length inherent in this system. The (CV) system compensates for variations in the contact tip-to-workpiece distance which readily occur during welding by automatically supplying increased or decreased welding current at a constant voltage to maintain an arc length. The desired arc length is selected by adjusting the output voltage of the power source and, normally, no other changes during welding are required. The wire feed speed, which also becomes the current control, is preset by the welder or welding operator prior to welding and can be changed over a considerable range before stubbing to the workpiece or burning-back into the contact tip occurs. Both adjustments are easily made.

Figure 11 shows the typical static output, volt-ampere characteristics of both constant current (CC) and constant voltage (CV) power sources. The (CV) source has a relatively flat curve. With either of the two sources, a small change in the contact tip-to-workpiece distance will cause a change in welding voltage (ΔV)¹ and a resultant change in welding current (ΔA). For the given Δ shown, a (CV) power source will produce a large ΔA . This same ΔV causes a smaller ΔA in the constant current power source. The magnitude of ΔA is very important because it determines the change in the electrode burnoff and is the primary mechanism responsible for arc self-correction.

Figure 12 schematically illustrates the self-correction mechanism. As the contact tip-to-work distance increases, the welding voltage and arc length increase and the welding current decreases, as the volt-ampere characteristic predicts. This also decreases the electrode burnoff (melting rate). Because the electrode is now feeding faster than it is being burned off, the arc will return to the preset shorter length. The converse would occur for a decrease in the contact tip-to-work distance.

The larger change in current and burnoff rate associated with (CV) power can be advantageous, particularly with ferrous electrodes. Constant current (CC) supplies are very slow to accomplish this type of correction as the ΔA for any ΔV is too small. If a constant wire feed speed is used with the constant current (CC) type power supply, the low-conductivity electrode materials have a tendency to stub into the workpiece or burn back into the contact tip.

Lincoln Idealarc SP-125 Plus, SP-170T, SP-175 Plus, SP-255 and Wire-Matic 255 units (single phase power input) incorporate all wire feed and power supply welding controls in one reliable unit. The SP series units are complete semiautomatic, constant voltage (CV) DC arc welding machines for the GMAW process. They are designed for use in light commercial applications such as auto body, ornamental iron, sheet metal, fabrication, maintenance and repair. These compact and easily portable units feature solid state controls which help hold a constant arc voltage, a single phase transformer power source, and a wire feeder.

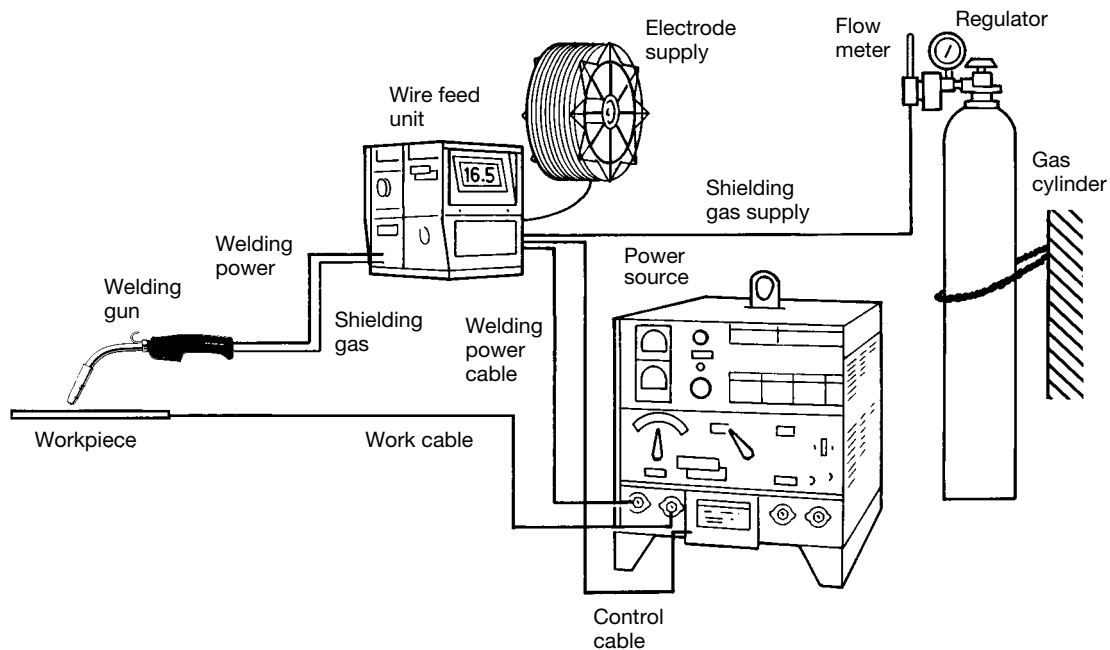

FIGURE 9 — Semiautomatic gas metal arc welding installation.

¹ The Greek symbol Δ (Delta) is used to represent a change.

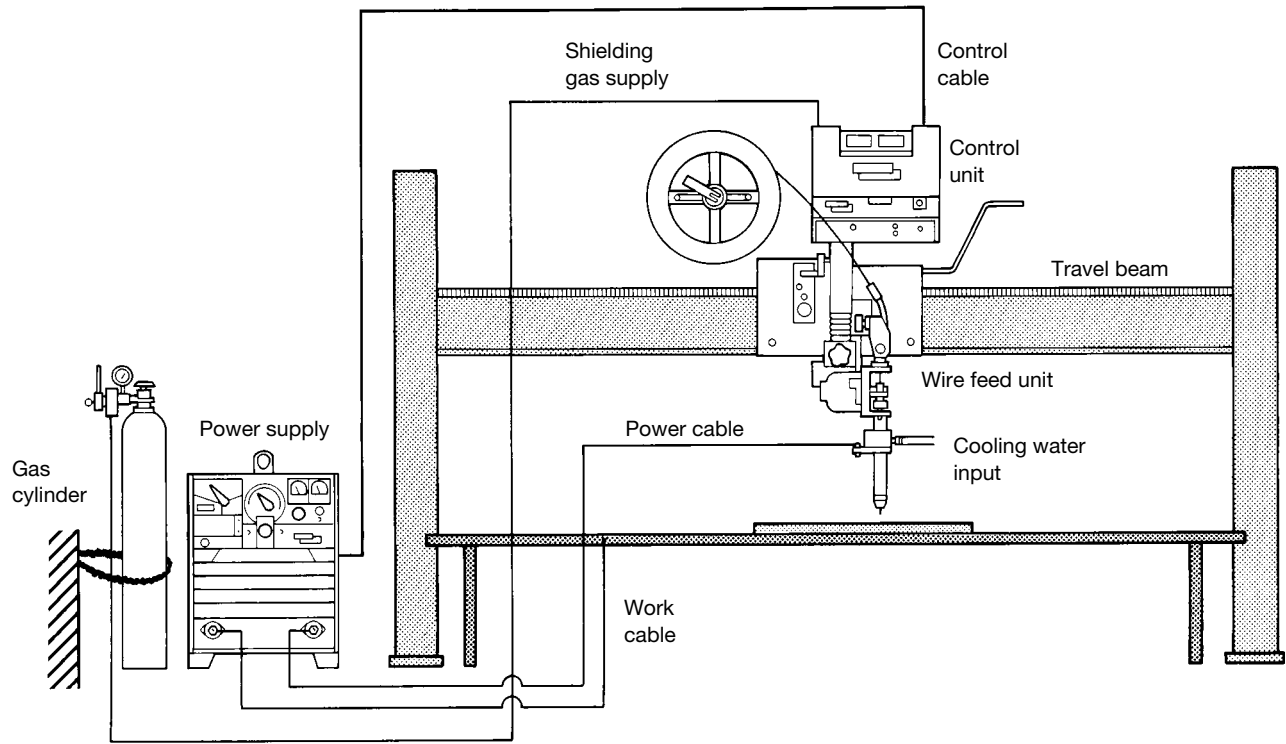

FIGURE 10 — Automatic gas metal arc welding installation.

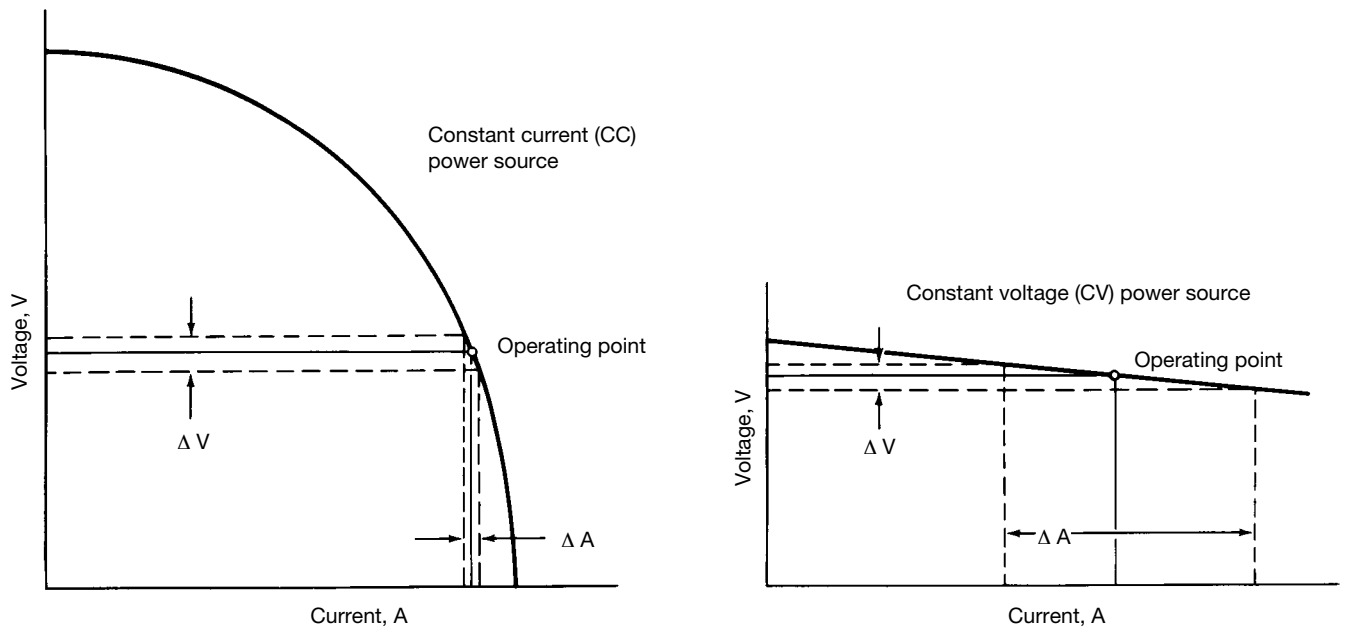

FIGURE 11 — Static volt-ampere characteristics.

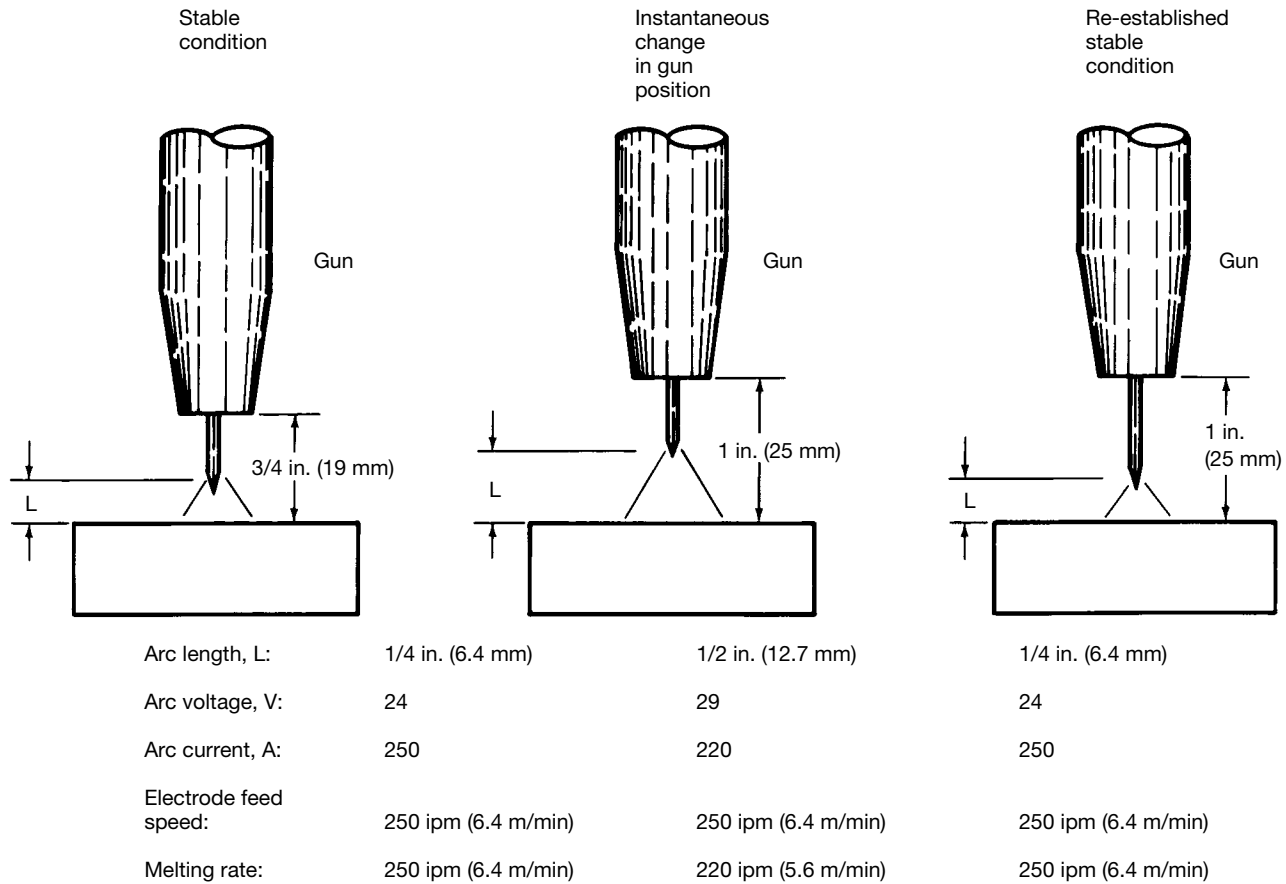

FIGURE 12 — Arc length regulation for traditional GMAW transfer modes.

Power Supply Variables. The self-correcting arc property of the (CV) power supply is important in producing stable welding conditions, but there are additional adjustments necessary to produce the best possible condition. These are particularly important for short circuiting welding.

Voltage. Arc voltage is the electrical potential between the electrode and the workpiece. This voltage cannot be directly read at the power supply because other voltage drops exist throughout the welding system. The arc voltage varies in the same direction as the arc length; therefore, increasing or decreasing the output voltage of the power source will increase or decrease the arc length (See Figure 11).

Slope. Figure 11 illustrates the static volt-ampere characteristics (static output) for GMAW power supply. The slant of the curve is referred to as the “slope” of the power supply. Slope has the dimensions of resistance since: Slope = change

in voltage/change in current = (volts/amperes) = ohms. This equation states that slope is equivalent to a resistance. However, the slope of a power supply is customarily defined as the voltage drop per 100 amperes of current rise, instead of ohms. For example, a 0.03 ohm slope can be restated as a 3 volts per 100 amperes slope.

The slope of Lincoln power supplies is a dynamic and virtually instant characteristic. Slope is built-in as an inherent part of the power source design to provide optimum welding conditions.

Anything which adds resistance to the welding system increases slope and thus increases the voltage drop at a given welding current. Power cables, poor connections, loose terminals, dirty contacts, etc., add to the slope.

The slope can be calculated by determining ΔV and ΔA , as illustrated by Fig. 13. As an example, if the open circuit voltage is 48 volts and the welding condition is 28 volts and 200 amperes, then ΔV is 10 volts and ΔA is 100 amperes; the slope is 10 volts per 100 amperes.

The short circuit current is a function of the slope of the volt-ampere characteristics of the power source, as shown in Fig. 15. Although the operating voltage and amperage of these two power sources are identical, the short circuit current of curve A is less than that of curve B. Curve A has the steeper slope or a greater voltage drop per 100 amperes as compared to curve B.

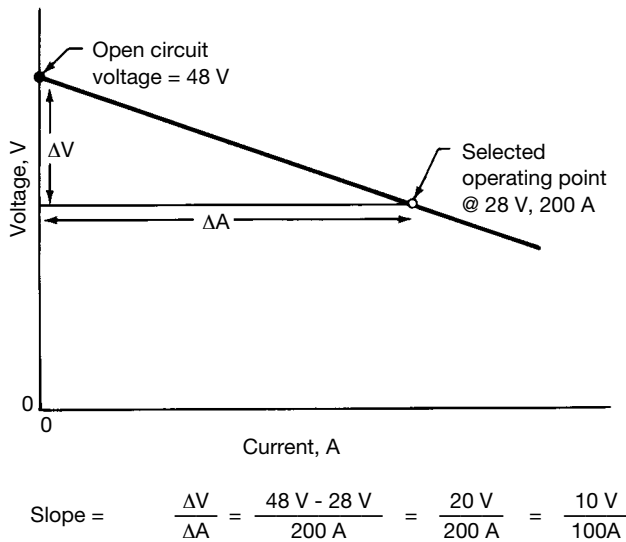

FIGURE 13 — Calculation of the slope for a power supply.

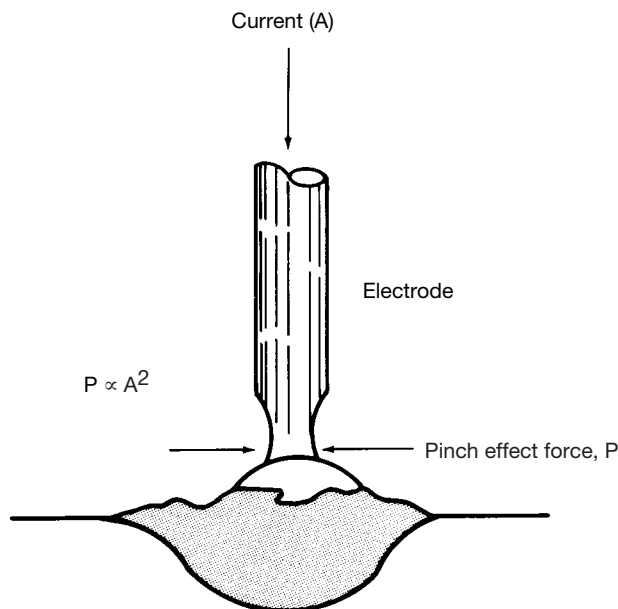

FIGURE 14 — Illustration of pinch effect during short circuiting transfer.

When the peak short circuit current is at the correct value, the parting of the molten drop from the electrode is smooth with very little spatter. Typical peak short circuit currents required for metal transfer with the best arc stability are shown in Table 1.

TABLE 1 — Typical peak currents (short circuit) for metal transfer in the short circuiting mode (Power source — Static characteristics)

Electrode material	Electrode Diameter		Short circuit current amperes (dcep)
	in.	mm	
Carbon steel	0.030	0.8	300
Carbon steel	0.035	0.9	320
Aluminum	0.030	0.8	175
Aluminum	0.035	0.9	195

Inductance. When the load changes on a power source, the current takes a finite time to attain its new level. The circuit characteristic primarily responsible for this time lag is the inductance. This power source variable is usually measured in henrys. The effect of inductance is illustrated by the curves plotted in Fig. 16. Curve A shows a typical current-time curve as the current rises from zero to a final value when some inductance is added. This curve is said to have an exponential rate of current rise. Curve B shows the path the current would have taken if there were no inductance in the circuit.

In GMAW, the separation of molten drops of metal from the electrode is controlled by an electrical phenomenon called the “pinch effect,” the squeezing force on a current-carrying conductor due to the current flowing through it. Figure 14 illustrates how the pinch effect acts upon an electrode during short circuiting welding. On most Lincoln power sources the “arc control” adjusts the inductance for the proper pinch effect.

The maximum amount of pinch effect is determined by the short circuit current level. As noted earlier, this current level is determined by the design of the power supply. The rate of increase of the pinch effect is controlled by the rate of current rise. This rate of current rise is determined by the inductance of the power supply. If the pinch effect is applied rapidly, the molten drop will be violently “squeezed” off the electrode and cause spatter. Greater inductance will decrease the number of short circuit metal transfers per second and increase the “arc-on” time. This increased arc-on time makes the puddle more fluid and results in a flatter, smoother weld bead. The opposite is true when the inductance is decreased.

In spray transfer welding, the addition of some inductance to the power supply will produce a softer, more usable start without reducing the final amount of current available. Too much inductance will result in electrode stubbing on the start (unless a special start circuit is built into the feeder).

Lincoln power sources adjust inductance by a “Pinch control” or “Arc control” (depending on the machine).

**Adjustment of Pinch Control
on Lincoln Electric Power Sources**

Minimum Pinch	Maximum Pinch
Maximum Inductance 1. More penetration 2. More fluid puddle 3. Flatter weld 4. Smoother bead	Minimum Inductance 1. Use only for arc stability when welding open gaps 2. More convex bead 3. Increased spatter 4. Colder arc

Spatter is held to a minimum when adequate current and correct rate of current rise exists. The power source adjustments required for minimum spatter conditions vary with the electrode material and size. As a general rule, both the amount of short circuit current and the amount of inductance needed for the ideal pinch effect are increased as the electrode diameter is increased.

AUTOMATIC WELDING EQUIPMENT

This type of welding equipment installation is effectively used when the work can be more easily brought to the welding station or when a great deal of welding must be done. Production and weld quality can be greatly increased because the arc travel is automatically controlled, and nozzle position is more securely maintained.

Basically, all of the equipment is identical to that needed in a semiautomatic station except for the following changes (See Fig. 10):

1. The welding gun, or nozzle, is usually mounted directly under the wire feed unit. The electrode conduit, gun handle, and gun switch are not used.
2. The welding control is mounted separately from the wire feed unit and remote control boxes are used.

Also, equipment is needed to provide automatic arc or work travel, and nozzle positioning.

Examples of this equipment are:

1. Beam carriage with motor control
2. Carriage motor
3. Positioner or manipulator
4. Robotics

When the welding equipment is moved, the carriage is mounted on a side beam which must be parallel to the weld joint. The electrode feed motor, electrode supply, welding control, and travel speed control are usually mounted on the carriage. The carriage motor supplies movement to the carriage. The speed of travel is adjusted through connections to the travel speed control.

Other types of equipment can be used for automatic travel. These include special beams, carriages mounted on tracks, and specially built positioners and fixtures. The welding control regulates travel start and stop to coordinate with the weld start and stop. Automatic welding can also be accomplished by either mechanizing the work or welding head. Welding robots, programmable controllers and hard automation are effective ways to mechanize.

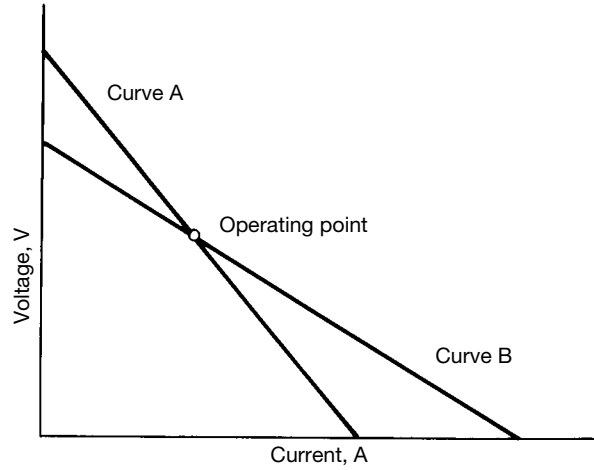

FIGURE 15 — Effect of changing slope.

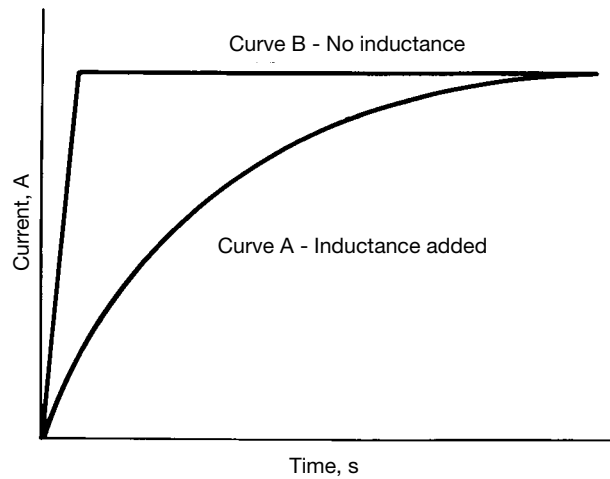

FIGURE 16 — Change in rate of current rise due to added inductance.

VI. PROCESS REQUIREMENTS AND APPLICATIONS

In GMAW, by definition, coalescence of metals is produced by heating them with an arc established between a continuous, consumable filler metal electrode and the work. The shielding gas and the consumable electrode are two essential requirements for this process.

SHIELDING GAS

General. Most metals exhibit a strong tendency to combine with oxygen (to form oxides) and to a lesser extent with nitrogen (to form metal nitrides). Oxygen will also react with carbon to form carbon monoxide gas. These reaction products are all a source of weld deficiencies in the form of: fusion defects due to oxides; loss of strength due to porosity, oxides and nitrides; and weld metal embrittlement due to dissolved oxides and nitrides. These reaction products are easily formed since the atmosphere is more or less composed of 80 percent nitrogen and 20 percent oxygen. The primary function of the shielding gas is to exclude the surrounding atmosphere from contact with the molten weld metal.

The shielding gas will also have a pronounced effect upon the following aspects of the welding operation and the resultant weld:

1. Arc characteristics
2. Mode of metal transfer
3. Penetration and weld bead profile
4. Speed of welding
5. Undercutting tendency
6. Cleaning action

The Inert Shielding Gases — Argon and Helium. Argon and helium are inert gases. These gases and mixtures of the two are necessarily used in the welding of nonferrous metals and also widely used to weld stainless steel and low alloy steels. Basic differences between argon and helium are:

1. Density
2. Thermal conductivity
3. Arc characteristics

The density of argon is approximately 1.4 times that of air (heavier) while the density of helium is approximately 0.14 times that of air (lighter). The heavier the gas the more effective it is at any given flow rate for shielding the arc and blanketing the weld area in flat position (downhand) welding. Therefore, helium shielding requires approximately two or three times higher flow rates than argon shielding in order to provide the same effective protection.

Helium possesses a higher thermal conductivity than argon and also produces an arc plasma in which the arc energy is more uniformly dispersed. The argon arc plasma is characterized by a very high energy inner core and an outer mantle of lesser heat energy. This difference strongly affects the weld bead profile. The helium arc produces a deep, broad, parabolic weld bead. The argon arc produces a bead profile most often characterized by a papillary (nipple) type penetration pattern (See Fig. 17).

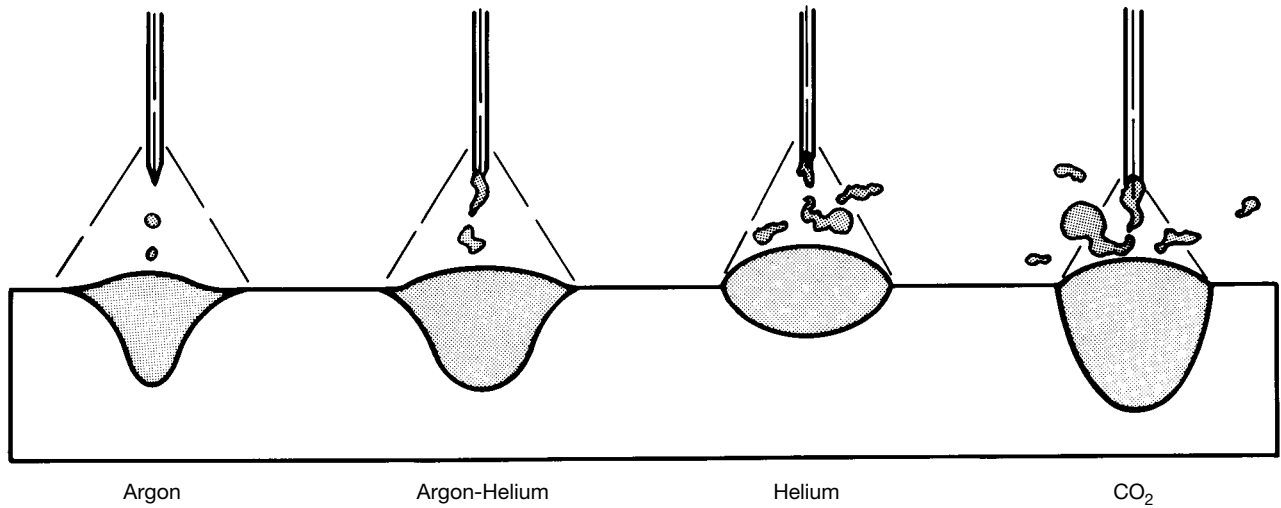

FIGURE 17 — Bead contour and penetration patterns for various shielding gases.

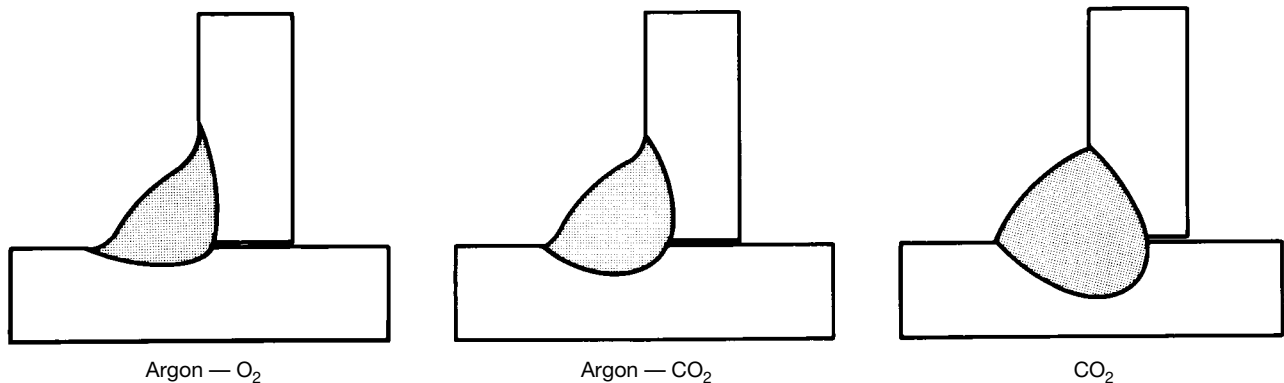

FIGURE 18 — Relative effect of O₂ versus CO₂ additions to the argon shield.

TABLE 2 — Shielding gases and gas mixtures for GMAW

Shielding gas	Chemical behavior	Typical application
Argon	Inert	Virtually all metals except steels.
Helium	Inert	Aluminum, magnesium, and copper alloys for greater heat input and to minimize porosity.
Ar + 20-80% He	Inert	Aluminum, magnesium, and copper alloys for greater heat input and to minimize porosity (better arc action than 100% helium).
Nitrogen		Greater heat input on copper (Europe).
Ar + 25-30% N ₂		Greater heat input on copper (Europe); better arc action than 100 percent nitrogen.
Ar + 1-2% O ₂	Slightly oxidizing	Stainless and alloy steels; some deoxidized copper alloys.
Ar + 3-5% O ₂	Oxidizing	Carbon and some low alloy steels.
CO ₂	Oxidizing	Carbon and some low alloy steels.
Ar + 20-50% CO ₂	Oxidizing	Various steels, chiefly short circuiting mode.
Ar + 10% CO ₂ + 5% O ₂	Oxidizing	Various steels (Europe).
CO ₂ + 20% O ₂	Oxidizing	Various steels (Japan).
90% He + 7.5% Ar + 2.5% CO ₂	Slightly oxidizing	Stainless steels for good corrosion resistance, short circuiting mode.
60% to 70% He + 25 to 35% Ar + 4 to 5% CO ₂	Oxidizing	Low alloy steels for toughness, short circuiting mode.

TABLE 3 — Selection of gases for GMAW with spray transfer

Metal	Shielding gas	Advantages
Aluminum	Argon	0 to 1 in. (0 to 25 mm) thick: best metal transfer and arc stability; least spatter.
	35% argon + 65% helium	1 to 3 in. (25 to 76 mm) thick: higher heat input than straight argon; improved fusion characteristics with 5XXX series Al-Mg alloys.
	25% argon + 75% helium	Over 3 in. (76 mm) thick: highest heat input; minimizes porosity.
Magnesium	Argon	Excellent cleaning action.
Carbon steel	Argon + 1-5% oxygen	Improves arc stability; produces a more fluid and controllable weld puddle; good coalescence and bead contour; minimizes undercutting; permits higher speeds than pure argon.
	Argon + 3-10% CO ₂	Good bead shape; minimizes spatter; reduces chance of cold lapping; can not weld out-of-position.
Low-alloy steel	Argon + 2% oxygen	Minimizes undercutting; provides good toughness.
Stainless steel	Argon + 1% oxygen	Improves arc stability; produces a more fluid and controllable weld puddle, good coalescence and bead contour; minimizes undercutting on heavier stainless steels.
	Argon + 2% oxygen	Provides better arc stability, coalescence, and welding speed than 1 percent oxygen mixture for thinner stainless steel materials.
Copper, nickel and their alloys	Argon	Provides good wetting; decreases fluidity of weld metal for thickness up to 1/8 in. (3.2 mm).
	Argon + helium	Higher heat inputs of 50 & 75 percent helium mixtures offset high heat dissipation of heavier gases.
Titanium	Argon	Good arc stability; minimum weld contamination; inert gas backing is required to prevent air contamination on back of weld area.

At any given wire feed speed, the voltage of the argon arc will be noticeably less than that of the helium arc. As a result, there will be less change in the voltage with respect to change in arc length for the argon arc and the arc will tend to be more stable than the helium arc. The argon arc (including mixtures with as low as 80 percent argon) will produce an axial spray transfer at current levels above the transition current. The helium-shielded arc produces a metal transfer of large droplets in the normal operating range. Therefore, the helium arc will produce a higher spatter level and poorer weld bead appearance compared to the argon arc.

The more readily ionized argon gas also facilitates arc starting and will provide superior surface cleaning action when used with reverse polarity (electrode positive).

Mixtures of Argon and Helium. Pure argon shielding is used in many applications for welding nonferrous materials. The use of pure helium is generally restricted to more specialized areas because of its limited arc stability. However, the desirable weld profile characteristics (deep, broad, and parabolic) obtained with the helium arc are quite often the objective in using an argon-helium shielding gas mixture. The result is an improved weld bead profile plus the desirable axial spray metal transfer characteristic of argon (See Fig. 17).

In short circuiting transfer, argon-helium mixtures of from 60 to 90 percent helium are used to obtain the higher heat input into the base metal for better fusion characteristics. For some metals, such as stainless and low alloy steels, helium additions instead of CO₂ additions are chosen to obtain higher heat input, because helium will not produce weld metal reactions that could adversely affect the mechanical properties of the deposit.

Oxygen and CO₂ Additions to Argon and Helium. Pure argon and, to some extent, helium produce excellent results in welding nonferrous metals. However, these shielding gases in the pure form do not produce the most satisfactory operational characteristics in welding ferrous materials. The arc tends to be erratic, accompanied by spatter with helium shielding, and shows a marked tendency to produce undercutting with pure argon shielding. Additions to argon of from 1 to 5 percent

oxygen or from 3 to 10 percent CO₂ (and up to 25 percent CO₂) produce a very noticeable improvement.

The optimum amount of oxygen or CO₂ to be added to the inert gas is a function of the surface condition (mill scale) of the base metal, the joint geometry, welding position or technique, and the base metal composition. Generally, 3 percent oxygen or 9 percent CO₂ is considered a good compromise to cover a broad range of these variables.

Carbon dioxide additions to argon also tend to enhance the weld bead by producing a more readily defined “pear-shaped” profile (See Fig. 18).

Carbon Dioxide. Carbon dioxide (CO₂) is a reactive gas widely used in its pure form for the gas metal arc welding of carbon and low alloy steels. It is the only reactive gas suitable for use alone as a shield in the GMAW process. Higher welding speed, greater joint penetration, and lower cost are general characteristics which have encouraged extensive use of CO₂ shielding gas.

With a CO₂ shield, metal transfer is either of the short circuiting or globular mode. Axial spray transfer is a characteristic of the argon shield and cannot be achieved with a CO₂ shield. The globular type transfer arc is quite harsh and produces a rather high level of spatter. This requires that the welding conditions be set with relatively low voltage to provide a very short “buried arc” (the tip of the electrode is actually below the surface of the work), in order to minimize spatter.

In overall comparison to the argon-rich shielded arc, the CO₂-shielded arc produces a weld bead of excellent penetration with a rougher surface profile and much less “washing” action at the extremity of the weld bead due to the buried arc. Very sound weld deposits are achieved but mechanical properties may be adversely affected due to the oxidizing nature of the arc.

Shielding Gas Selection. A summary for typical usage for the various shielding gases based upon the metal being welded is shown in Tables 2, 3 and 4.

TABLE 4 — Selection of gases for GMAW with short circuiting transfer.

Metal	Shielding gas	Advantages
Carbon steel	75% argon +25% CO ₂	Less than 1/8 in. (3.2 mm) thick: high welding speeds without burn-thru; minimum distortion and spatter.
	75% argon +25% CO ₂	More than 1/8 in. (3.2 mm) thick: minimum spatter; clean weld appearance; good puddle control in vertical and overhead positions.
	CO ₂	Deeper penetration; faster welding speeds.
Stainless steel	90% helium + 7.5% argon + 2.5% CO ₂	No effect on corrosion resistance; small heat-affected zone; no undercutting; minimum distortion.
Low alloy steel	60-70% helium + 25-35% argon + 4-5% CO ₂	Minimum reactivity; excellent toughness; excellent arc stability, wetting characteristics, and bead contour; little spatter.
	75% argon + 25% CO ₂	Fair toughness; excellent arc stability, wetting characteristics, and bead contour; little spatter.
Aluminum, copper, magnesium, nickel, and their alloys	Argon & argon + helium	Argon satisfactory on sheet metal; argon-helium preferred on thicker sheet material (over 1/8 in. [3.2 mm]).

ELECTRODES

General. In the engineering of weldments, filler metals are selected to produce a weld deposit with these basic objectives:

1. A deposit closely matching the mechanical properties and physical characteristics of the base metal
2. A sound weld deposit, free of discontinuities

Note the first objective. A weld deposit, even one of composition identical to the base metal, will possess unique metallurgical characteristics. Therefore, the first objective of the weldment design is to produce a weld deposit composition having desired properties equal to or better than those of the base metal. The second objective is achieved, generally, through use of a filler metal electrode that was formulated to produce a relatively defect-free deposit.

Composition. The basic filler metal composition is designed to be compatible with one or more of the following base metal characteristics:

1. Chemistry
2. Strength
3. Ductility
4. Toughness

Alternate or additional consideration may be given to other properties such as corrosion, heat-treatment responses, wear resistance, color match, etc. All of these considerations, however, are secondary to the metallurgical compatibility of the base metal to the filler metal.

American Welding Society (AWS) specifications have been established for filler metals in common usage. Table 5 provides a basic guide to some typical base-metal to filler-metal combinations along with the applicable AWS filler metal specification. Other filler metal compositions for special applications, such as for high-strength steels, are available.

Formulation. The electrode must also meet certain demands of the process regarding arc stability, metal transfer behavior, and solidification characteristics. Deoxidizers or other scavenging agents are always added to compensate for base metal reactions with oxygen, nitrogen and hydrogen from the surrounding atmosphere or the base metal. The deoxidizers most frequently used in steel are silicon and manganese. Some steel electrodes may also use aluminum for additional deoxidation, as well as titanium and zirconium for denitrating. Nickel alloy electrodes generally use titanium and silicon for deoxidation and copper alloys will use titanium and silicon or phosphorus for the same purpose.

Selection of Process Variables. Many process variables must be considered for complete application of GMAW. These variables are found in the following three principle areas:

1. Equipment selection
 2. Mode of metal transfer and shielding gas
 3. Electrode selection
- (These three areas are very much interrelated.)

Equipment Selection. Welding equipment must meet the requirements of every application. Range of power output,

range of open circuit voltage, static and dynamic characteristics, wire feed speed range, etc., must correspond to the weldment design and the electrode size selected. Also to be considered are the accessories required for the selected mode of metal transfer and any other special requirements.

Lincoln Electric GMAW products offer a variety of basic equipment designs and options which will produce maximum efficiency in every welding application.

When new equipment is to be purchased, some consideration should be given to the versatility of the equipment and to standardization. Selection of equipment for single-purpose or high volume production can generally be based upon the requirements of that particular application only. However, if multiples of jobs are to be performed (as in job shop operation), many of which may be unknown at the time of selection, versatility is very important. Other equipment already in use at the facility should be considered. Standardizing certain components and complementing existing equipment will minimize inventory requirements and provide maximum efficiency of overall operation.

Mode of Metal Transfer and Shielding Gas. The characteristics of the mode of metal transfer are very important in analysis of the process application. Characteristics such as weld bead profile, reinforcement shape, spatter, etc., are relevant to the weldment design. The following major considerations reflect the importance of these characteristics.

Design and Service Performance. Product design, as well as specific weld joint design, requires consideration of penetration and reinforcement profiles. Both static and dynamic service performance requirements may dictate the need for additional strength (in the form of penetration) or minimal stress concentration (good “wash” characteristics). The shielding gas selected is very important in determining these basic characteristics.

Process Control. Material thickness may require using the low energy short circuit transfer mode rather than either the spray or globular transfer mode with their inherently higher energy input. Joint fit-up tolerances (gap) and weld size and length may also be a major influence in selection of the process mode to be used.

The designed weld bead profile (including reinforcement, fusion pattern, and penetration) can be controlled by the shielding gas selection. Proper shielding gas selection can be an important factor to assure, for instance, good fusion characteristics when a welder may be “extended” to reach a difficult location and unable to maintain his gun in an optimum position.

Appearance. The appearance of the weldment is not of technical concern but may be important. Smooth and spatter-free weld beads on a product in an area highlighted in the purchaser’s view are cited as a sales factor in many instances. The spray arc and the short circuiting modes of metal transfer will produce the smoothest and neatest-appearing welds. Smooth and spatter-free areas adjacent to GMAW welds may also be required to assure proper fits in subsequent final assembly operations.

TABLE 5 — Recommended filler metals for GMAW

Base metal type	Recommended electrode		AWS filler metal specification (use latest edition)	Electrode diameter		Current range Amperes
	Material type	Electrode classification		in.	mm	
Aluminum and aluminum alloys	1100	ER1100 or ER4043	A5.10	0.030	0.8	50-175
	3003, 3004	ER1100 or ER5356		³ / ₆₄	1.2	90-250
	5052, 5454	ER5554, ER5356, or ER5183		¹ / ₁₆	1.6	160-350
	5083, 5086, 5456 6061, 6063	ER5556 or ER5356 ER4043 or ER5356		³ / ₃₂ ¹ / ₈	2.4 3.2	225-400 350-475
Magnesium alloys	AZ10A	ERAZ61A, ERAZ92A	A5.19	0.040	1.0	150-300 ²
	AZ31B, AZ61A, AZ80A	ERAZ61A, ERAZ92A		³ / ₆₄	1.2	160-320 ²
	ZE10A	ERAZ61A, ERAZ92A		¹ / ₁₆	1.6	210-400 ²
	ZK21A	ERAZ61A, ERAZ92A		³ / ₃₂	2.4	320-510 ²
	AZ63A, AZ81A	ERAZ92A		¹ / ₈	3.2	400-600 ²
	AZ91C			ERAZ92A		
	AZ92A, AM100A	ERAZ92A				
	HK31A, HM21A	EREZ33A				
	HM31A			EREZ33A		
	LA141A			EREZ33A		
Copper and copper alloys	Silicon Bronze	ERCuSi-A	A5.7	0.035	0.9	150-300
	Deoxidized copper	ERCu				
	Cu-Ni alloys	ERCuNi				
	Aluminum bronze	ERCuA1-A1, A2 or A3				
Phosphor bronze		ERCuSn-A				
				0.045	1.2	200-400
				¹ / ₁₆	1.6	250-450
				³ / ₃₂	2.4	350-550
Nickel and nickel alloys	Monel ³ Alloy 400 Inconel ³ Alloy 600	ERNiCu-7 ERNiCrFe-5	A5.14	0.020	0.5	—
				0.030	0.8	—
				0.035	0.9	100-160
				0.045	1.2	150-260
				¹ / ₁₆	1.6	100-400
Titanium and titanium alloys	Commercially pure Ti-0.15 Pd Ti-5Al-2.5Sn	Use a filler metal one or two grades lower ERTi-0.2 Pd ERTi-5Al-2.5Sn or comm. pure	A5.16	0.030	0.8	—
				0.035	0.9	—
				0.045	1.2	—
Austenitic stainless steels	Type 201 Types 301, 302, 304, & 308 Type 304L Type 310 Type 316 Type 321 Type 347	ER308 ER 308 ER308L ER310 ER316 ER321 ER347	A5.9	0.020	0.5	—
				0.025	0.6	—
				0.030	0.8	75-150
				0.035	0.9	100-160
				0.045	1.2	140-310
				¹ / ₁₆	1.6	280-450
				⁵ / ₆₄	2.0	—
				³ / ₃₂	2.4	—
				⁷ / ₆₄	2.8	—
				¹ / ₈	3.2	—
Steel	Hot rolled or cold-drawn plain carbon steels	ER70S-3 or ER70S-1 ER70S-2, ER70S-4 ER70S-5, ER70S-6	A5.18	0.020	0.5	—
				0.025	0.6	—
				0.030	0.8	40-220
				0.035	0.9	60-280
				0.045	1.2	125-380
				0.052	1.3	260-460
				¹ / ₁₆	1.6	275-450
				⁵ / ₆₄	2.0	—
				³ / ₃₂	2.4	—
				¹ / ₈	3.2	—
Steel	Higher strength carbon steels and some low alloy steels	ER80S-D2 ER80S-Ni1 ER100S-G	A5.28	0.035	0.9	60-280
				0.045	1.2	125-380
				¹ / ₁₆	1.6	275-450
				⁵ / ₆₄	2.0	—
				³ / ₃₂	2.4	—
				¹ / ₈	3.2	—
	⁵ / ₃₂	4.0	—			

² Spray Transfer Mode

³ Trademark-International Nickel Co.

Electrode selection. The selection of the welding electrode should be based principally upon matching the mechanical properties and the physical characteristics of the base metal (See Table 5). Secondary considerations should be given to items such as the equipment to be used, the weld size (deposition rates to be utilized), existing electrode inventory, and materials handling systems.

Lincoln Electric offers a choice of electrode compositions. For welding mill steel with the GMAW process, L-50 is the preferred electrode. It has excellent feedability through gun and cable systems. L-50 conforms to AWS classification ER70S-3.

L-54 is designed for improved operation versus L-50 for welding over small amounts of rust and dirt, but still not as much as L-56. L-54 conforms to AWS classification ER70S-4.

L-52 is triple deoxidized with aluminum, titanium, and zirconium in addition to manganese and silicon. It produces less fluid weld metal which makes it ideal for welding out-of-position and for welding small diameter pipe. L-52 conforms to AWS classification ER70S-2.

For best performance on rusty or dirty surfaces, L-56 is the preferred choice. It conforms to AWS classification ER70S-6.

L-50B, L-54B and L-56B are non-copper coated versions of each respective electrode, and are recommended for applications where non-coated electrodes are preferred.

LA-75 is designed for use on applications requiring excellent low temperature impacts and on weathering steels. It conforms to AWS classification ER80S-Ni1.

LA-90 is designed for welding on high strength steels where weld tensile strengths of 90,000 psi (620 mPa) or higher are required. LA-90 conforms to AWS ER80S-D-2 and ER90S-G classification per A5.28.

LA-100 electrode is designed for welding high strength, low alloy steels. LA-100 conforms to ER100S-G per A5.28 and also meets the requirements of ER110S-G. It is also approved as an MIL-100S-1 classification.

For gas metal arc welding of stainless steels, Lincoln Electric offers Blue Max MIG 308LSi, 309LSi and 316LSi. All are classified per AWS A5.9. For further information on these electrodes consult Lincoln bulletin C6.1.

In addition, there are numerous other Lincoln electrodes to satisfy the specific requirements of other welding applications. Consult your local Lincoln distributor for detailed information.

Equipment. The electrode package size should be compatible with the available handling equipment. The package size should be determined by a cost evaluation that considers product volume, change time versus the consideration of available space, inventory cost, and the materials handling system.

Weld Size. The electrode diameter should be chosen to best fit the requirements of the weld size and the deposition rate to be used. In general, it is economically advantageous to use the largest diameter possible.

Standardization and Inventory. Evaluation of each welding job on its own individual merit would require an increasingly larger inventory with an increasing number of jobs. Minimizing inventory requires a review of overall welding requirements in the plant, with standardization of the basic electrode composition and sizes as well as the electrode packages as the objective. This can be accomplished readily with minimum compromise since quite broad and overlapping choices are available.

Materials Handling Systems. The electrode package size should also take into account the requirements for handling. Generally speaking, one individual can be expected to change an electrode package weighing up to 60 lb (27 kg) without assistance. However, some systems are designed so that an individual can handle the larger reels up to 1000 lb (454 kg) without additional assistance. The larger packages necessitate a handling system (lift truck or similar) capable of moving the electrode package from storage to the welding station when required for changing, or additional space is needed to accommodate at least two packages in order to avoid delays.

Lincoln electrodes are available in various package arrangements to facilitate individual production and handling requirements.

Consult your local Lincoln office or distributor for complete electrode type and packaging information.

Operating Conditions. After selecting the basic process variables, the basic operating conditions to be met are as follows:

1. Deposition rate — travel speed
2. Wire feed speed (welding current)
3. Welding voltage
4. Electrode extension (stickout)

Deposition Rate. The deposition rate is defined as the actual amount of weld metal deposited per unit of time (generally in terms of pounds (kilograms) per hour). It is necessary to balance the deposition rate against the travel speed, since proper balance achieves an optimum rate of metal deposition for the weld joint design. This is particularly important in semiautomatic welding when weld quality depends upon the physical movement capability of the welder. The following factors affect this balanced relationship:

1. Weld size
2. Weld joint design
3. Number of weld passes
4. Physical limitation of the welder (in semiautomatic welding) to retain control of the weld puddle as travel speed is increased to keep weld metal from “overrunning” the arc. This maximum limitation is typically around 25 in./min (.6 m/min) although in many reported instances the travel speed may reach as high as 150 in./min (3.8 m/min). In general, these higher rates of travel speed are attainable when the weld size is very small, the weld length is very short, the weld is along a straight line, or when optimum weld appearance is not a factor.

Welding Current — Wire Feed Speed. After determining the optimum deposition rate for the application, the next step is to determine the wire feed speed at required stickout, and the related welding current to achieve that deposition rate. In a practical application, the deposition rate is more accurately set, maintained, and reproduced by measurement of the wire feed speed rather than the welding current value.

Welding Voltage. The welding voltage (related to the proper arc length) is established to maintain arc stability at the chosen electrode feed speed or welding current level and to minimize spatter.

Electrode Extension (Stickout). The basic control setting for low conductivity electrode metals are very much dependent upon the electrode stickout. Variation in electrode stickout

results in a change in the electrical characteristics of the balanced system, as determined by the resistivity of the electrode length between the contact tip and the arc (See Fig. 19). In essence, as the contact tip-to-work distance is increased the I^2R heating effect is increased, thus decreasing the welding current (I) required to melt the electrode (in effect, increasing the deposition rate for a given current level). Conversely, as the contact tip-to-work distance is decreased, the I^2R effect is decreased, thus increasing the welding current requirements for a given wire feed speed (in effect, decreasing the deposition rate for a given current level). This point emphasizes the importance of maintaining proper nozzle-to-contact tip distance in welding gun maintenance, as well as the importance of maintaining good welding techniques through proper gun positioning.

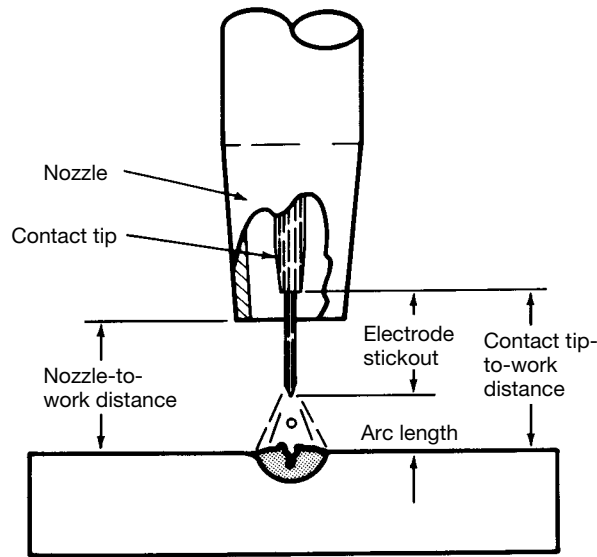

FIGURE 19 — Electrode stickout.

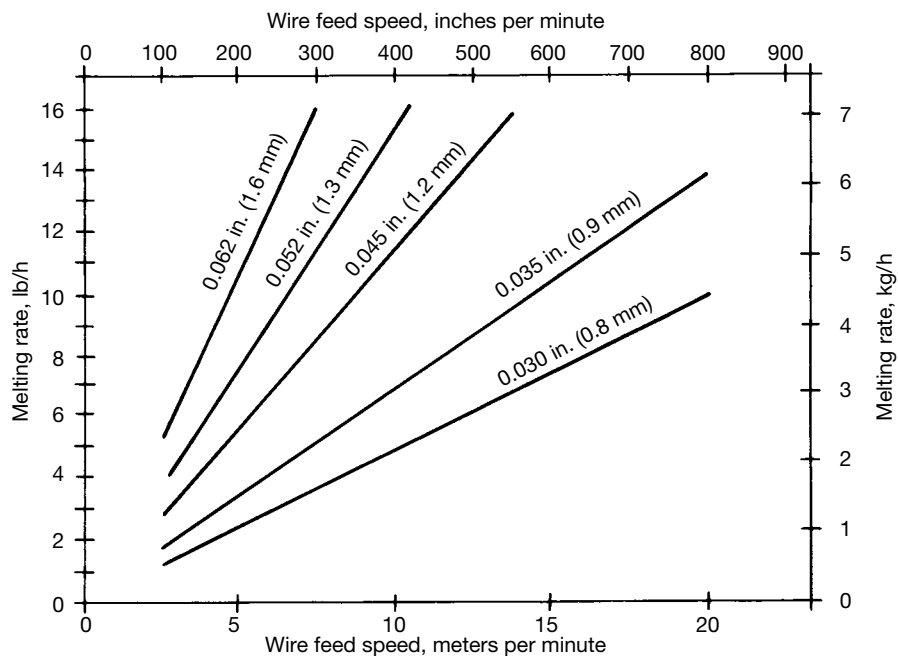

FIGURE 20 — Typical melting rates for plain carbon steel.

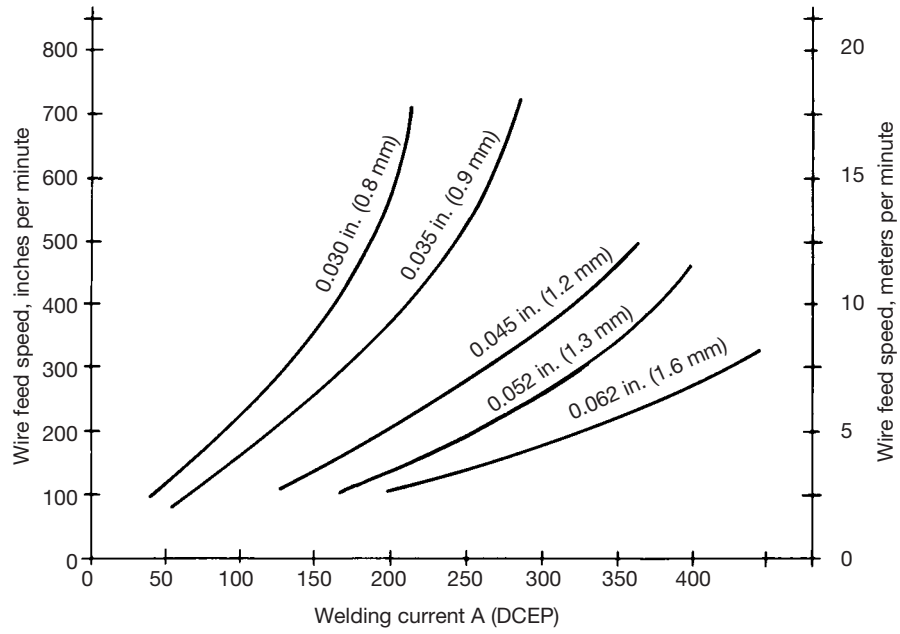

FIGURE 21 — Typical welding currents vs. wire feed speeds for carbon steel electrodes at a fixed stickout.

Note: DCEP means Direct Current Electrode Positive.

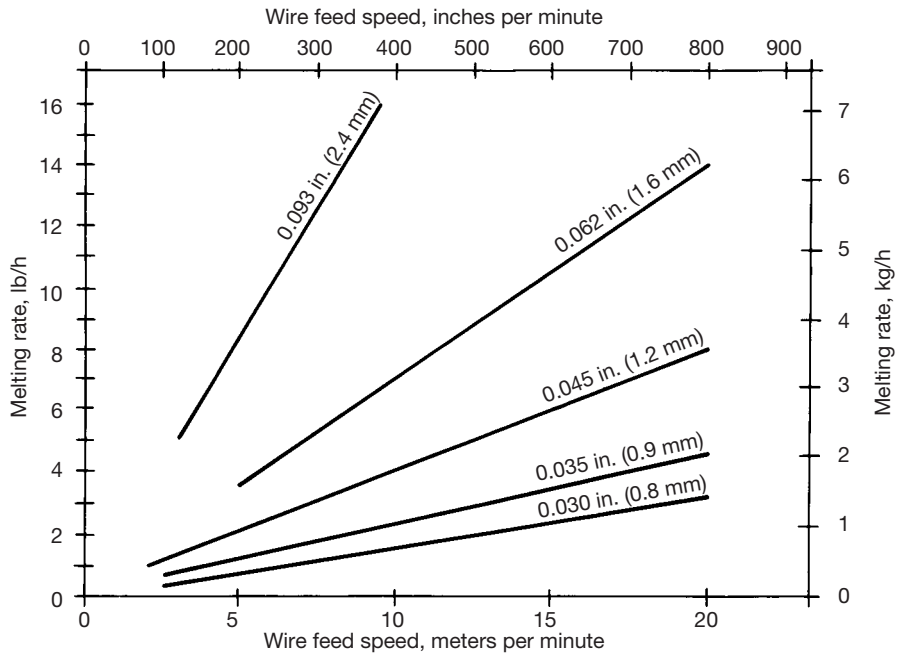

FIGURE 22 — Typical melting rates for aluminum electrodes.

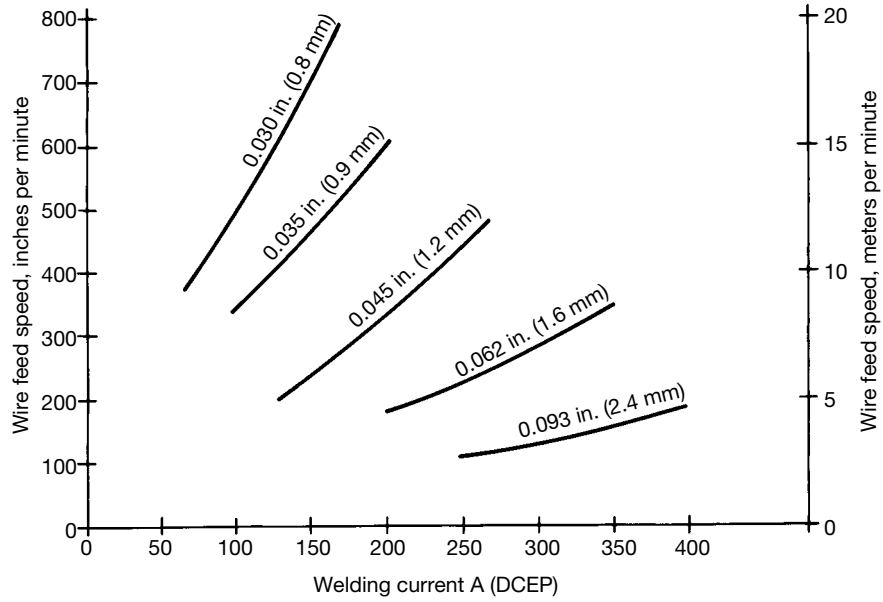

FIGURE 23 — Welding currents vs. wire feed speed for ER4043 aluminum electrodes at a fixed stickout.

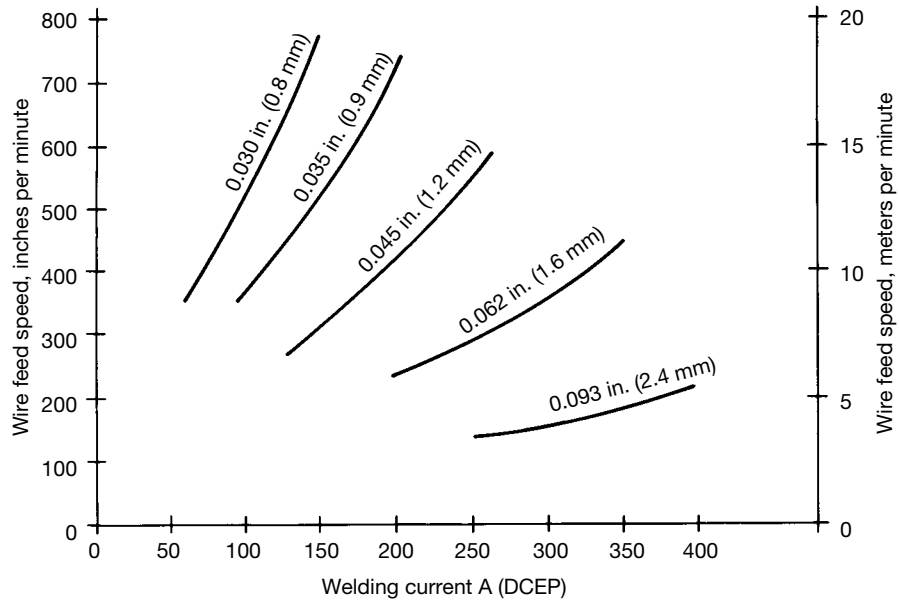

FIGURE 24 — Welding currents vs. wire feed speed for ER5356 aluminum electrodes at a fixed stickout.

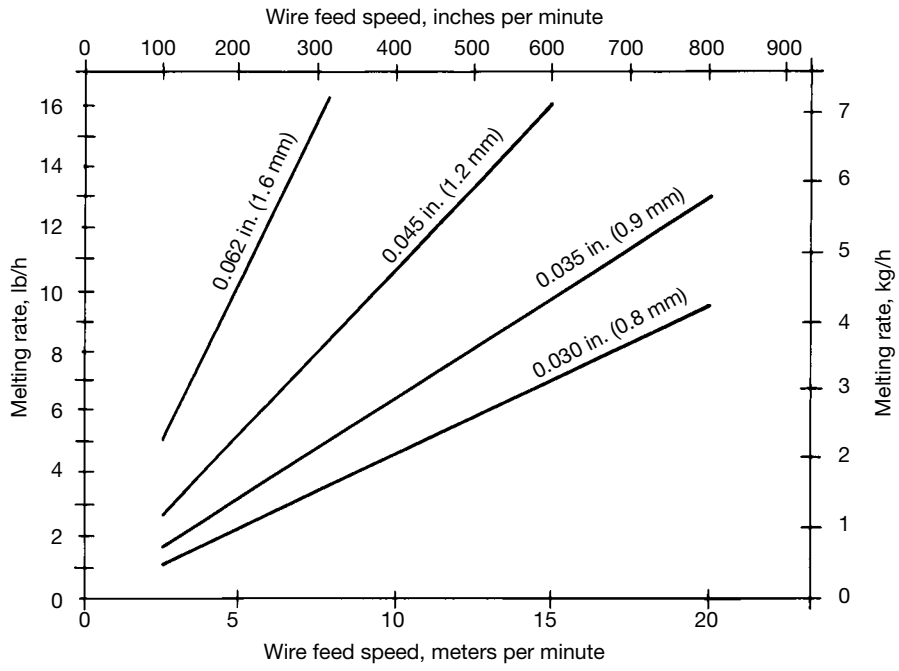

FIGURE 25 — Typical melting rates for 300 series stainless steel electrodes.

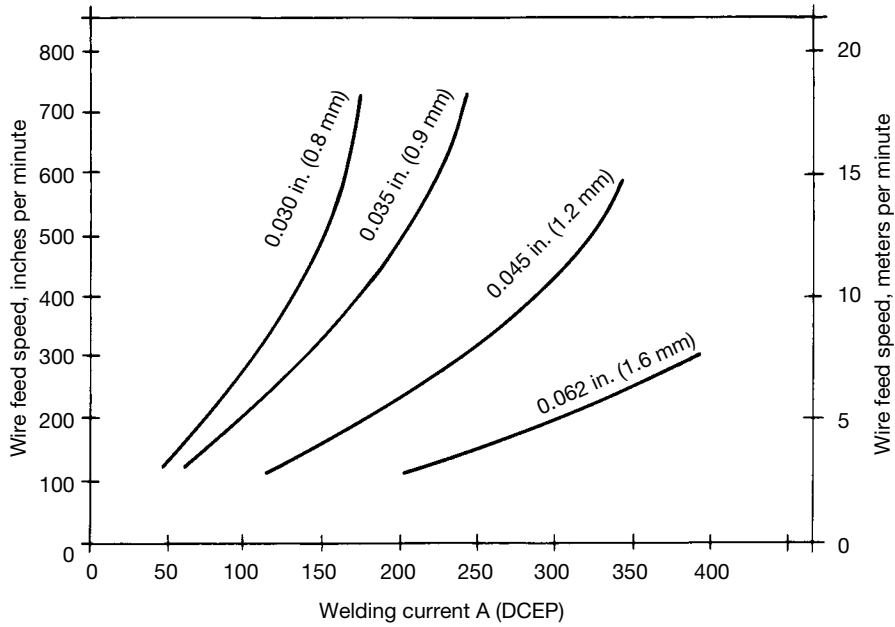

FIGURE 26 — Typical welding currents vs. wire feed speeds for 300 series stainless steel electrodes at a fixed stickout.

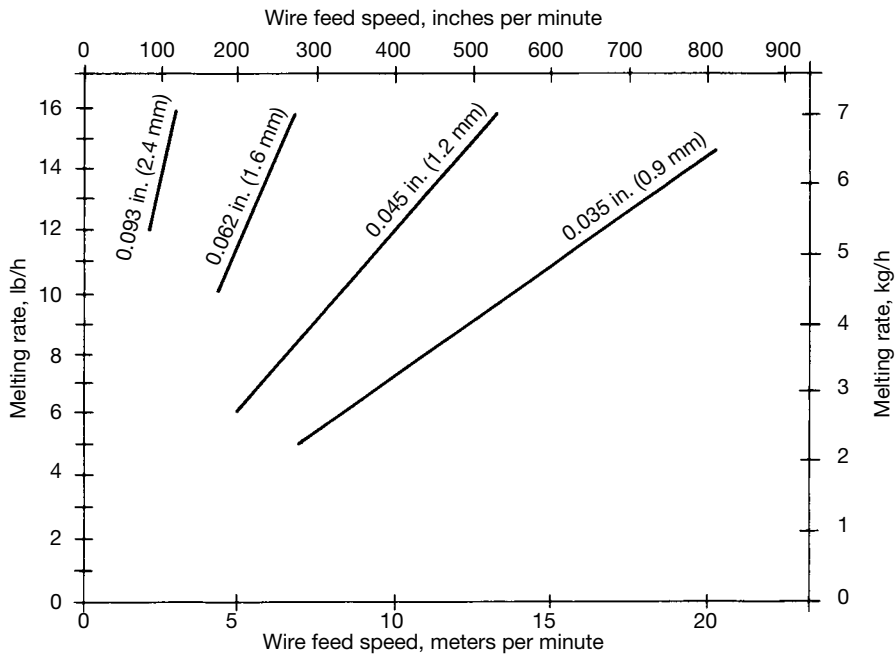

FIGURE 27 — Typical melting rates for ERCu copper electrodes.

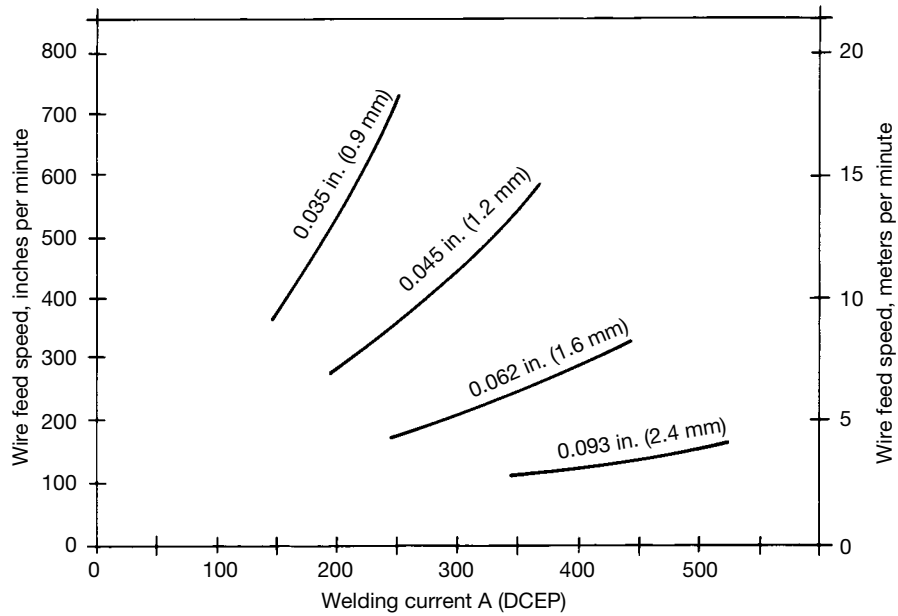

FIGURE 28 — Welding currents vs. wire feed speed for ERCu copper electrodes at a fixed stickout.

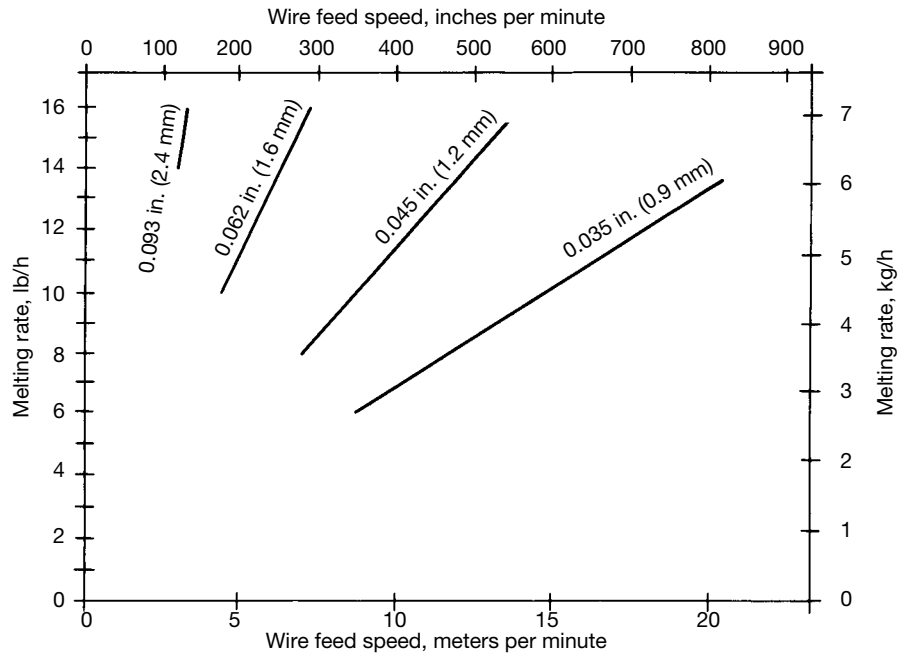

FIGURE 29 — Typical melting rates for ERCuSi-A copper electrodes.

Guidelines for Operating Conditions. Figures 20 through 29 illustrate the basic concept of and provide basic information for establishing “deposition-rate to wire-feed-speed” relationships. The distinction should be made between the melting rate (rate of melting of the electrode) and the deposition rate (rate of actual metal deposited). The two are not the same, due to arc and spatter loss, but are related by the arc transfer efficiency. Also note that the relationship between wire feed speed and welding current can be altered by the wire extension or stickout (not shown in these figures).

VII. PROCEDURES FOR CARBON STEELS

WELDING RECOMMENDATIONS

When welding with short circuiting transfer, use a drag or push angle as shown.

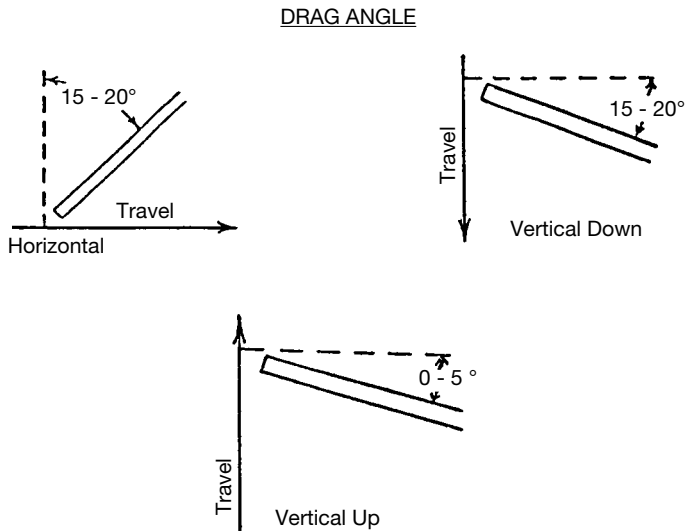
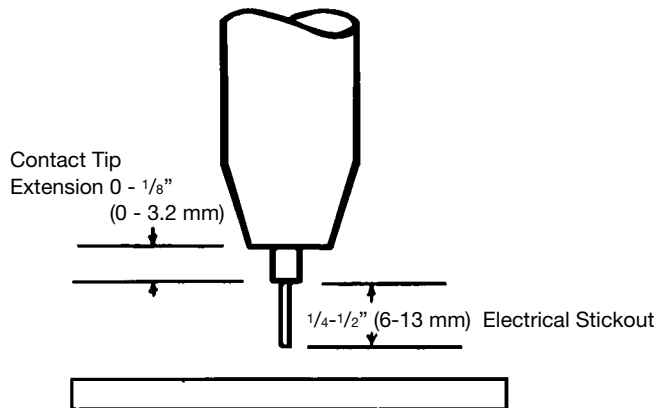

FIGURE 30 — Drag angles for short circuit transfer.

ELECTRICAL STICKOUT FOR SHORT CIRCUIT TRANSFER MODE



The contact tip should be flush with the end of the nozzle or extend a maximum of 1/8" (3.2 mm) as shown.

FIGURE 31 — Stickout for short circuiting transfer.

WIRE FEED SPEED [WFS(IN/MIN)] AND RESULTING CURRENT (AMPS)

Deposition rate measured in lbs/hr (kg/hr) is directly related to wire feed speed measured in inches/minute (m/min). Accurate weld settings can be made by setting wire feed speed

(WFS). The procedure pages list the primary settings in WFS in./min (m/min) and the resulting current when the proper electrical stickout is used.

ARC VOLTAGE

Arc voltage, as referred to in the procedure pages, is the voltage measured from the wire feeder gun cable block to work. Arc voltages listed are starting points.

SHIELDING GAS AND GAS MIXTURES

Carbon Dioxide. Carbon Dioxide is a reactive gas and can be used to shield gas metal arc welds on carbon and low alloy steels in the short circuit mode of transfer.

Typical characteristics are:

1. Best penetration
2. Low cost
3. Harsh arc — high spatter
4. Will not support axial spray transfer
5. Out-of-Position capability

Argon. Argon is an inert gas and generally cannot be used alone as a shielding gas for gas metal arc welds on carbon or low alloy steels. Oxygen or carbon dioxide is added to stabilize the arc. Without the addition of oxygen or carbon dioxide the arc will be erratic.

Argon and Carbon Dioxide. Argon with 20-50% carbon dioxide gas mixtures are used to shield gas metal arc welds on carbon and low alloy steels in the short circuiting mode of transfer.

Typical characteristics are:

1. Good bead shape
2. Less penetration than straight carbon dioxide shielding
3. Weld puddle not as fluid with carbon dioxide shielding
4. Colder weld puddle — possible cold lapping
5. Minimum argon mixture to support axial spray is 80% argon, 20% carbon dioxide
6. Can weld out-of-position

ARGON WITH 3 TO 10% CARBON DIOXIDE OR 1 TO 5% OXYGEN

Mixture of 3 to 10% carbon dioxide or 1 to 5% oxygen are most often used for axial spray transfer mode welding. The lower the percentage of argon in a shielding gas mixture, the higher the arc voltage needed to develop an arc length long enough to support axial spray transfer.

Typical characteristics are:

1. Good bead shape
2. Minimum to no spatter
3. Best mixtures to eliminate cold spatter
4. Cannot weld out-of-position
5. Best process for thick plate

When welding with spray transfer use a slight push angle as shown below.

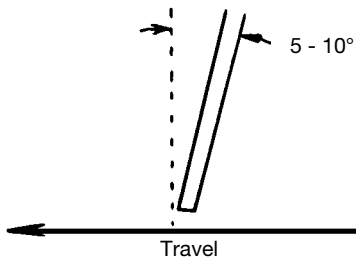

To weld with spray transfer it is necessary to use a gas mixture containing at least 80% argon. It is also necessary to remove mill scale from plates being welded.

FIGURE 32 — Drag angle for spray transfer.

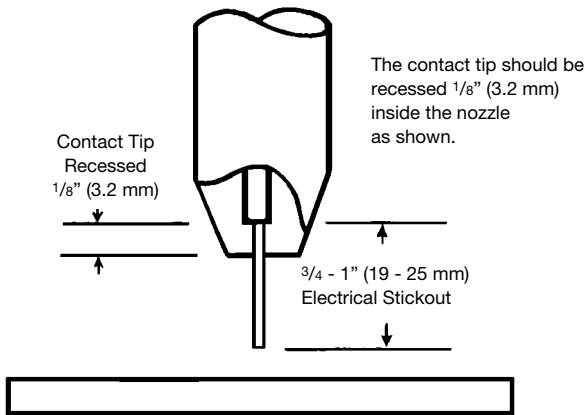

FIGURE 33 — Electrical stickout for spray transfer mode.

PREHEAT AND INTERPASS TEMPERATURE

Preheat and interpass temperature control are recommended for optimum mechanical properties, crack resistance and hardness control. This is particularly important on multiple pass welds and heavier plate. Job conditions, prevailing codes, high restraint, alloy level, and other considerations may also require preheat and interpass temperature control. The following minimum preheat and interpass temperatures are recommended as starting points. Higher or lower temperatures may be used as required by the job conditions and/or prevailing codes. If cracking occurs, higher preheat and interpass temperature may be required.

Plate Thickness in. (mm)	Up to $\frac{3}{4}$ (19)	$\frac{3}{4}$ - $1\frac{1}{2}$ (19-38)	$1\frac{1}{2}$ - $2\frac{1}{2}$ (38-64)	Over $2\frac{1}{2}$ (64)
Recommended Minimum Preheat Temperature, °F (°C)	70 (21)	150 (66)	150 (66)	225 (107)
Recommended Minimum Interpass Temperature, °F (°C)	70 (21)	150 (66)	225 (107)	300 (149)

Because design, fabrication, erection and welding variables affect the results obtained in applying this type of information, the serviceability of a product or structure is the responsibility of the user. Variations such as plate chemistry, plate surface condition (oil, scale), plate thickness, preheat, quench, joint fit-up, gas type, gas flow rate, and equipment may produce results different than those expected. Some adjustments to procedures may be necessary to compensate for unique individual conditions. When possible, test all procedures, duplicating actual field conditions.

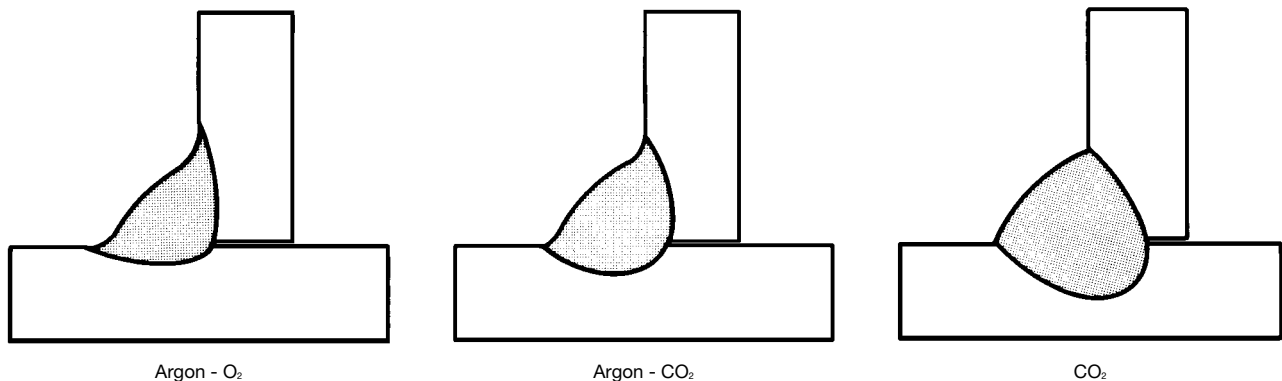

FIGURE 34 — Effects of blended gases.

**TABLE 6 — Procedures for Carbon and Low Alloy Steel — Short Circuiting Transfer Horizontal Fillets or Flat Butt Joint
CO₂ Gas Shield**

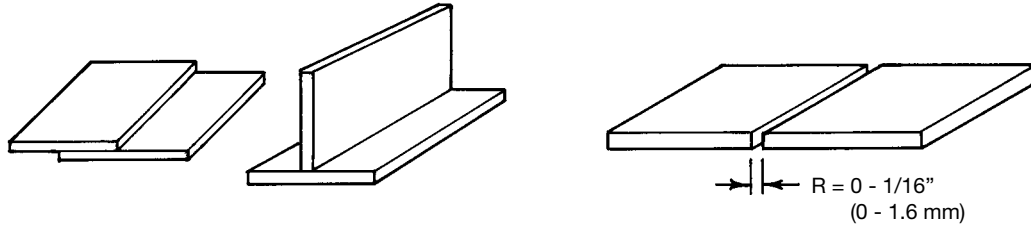

Plate Thickness, (mm)	24 ga (.6)		20 ga (.9)		16 ga (1.5)		14 ga (1.9)		12 ga (2.6)		10 ga (3.4)		3/16" (4.8)	1/4" (6.4)	
Electrode Size, in. (mm)	.025 (.6)	.030 (.8)	.030 (.8)	.035 (.9)	.030 (.8)	.035 (.9)	.030 (.8)	.035 (.9)	.030 (.8)	.035 (.9)	.030 (.8)	.035 (.9)	.045 (1.1)	.045 (1.1)	.045 (1.1)
WFS, in./min (m/min)	100 (2.5)	75 (1.9)	125 (3.2)	100 (2.5)	175 (4.4)	150 (3.8)	225 (5.7)	175 (4.4)	275 (7.0)	225 (5.7)	300 (7.6)	250 (6.4)	125 (3.2)	150 (3.8)	200 (5.0)
Amps (Approx)	35	35	55	80	80	120	100	130	115	160	130	175	145	165	200
Travel Speed, in./min (m/min)	10 (.25)	10 (.25)	14 (.35)	13 (.33)	13 (.33)	20 (.50)	18 (.45)	18 (.45)	20 (.50)	20 (.50)	17 (.43)	20 (.50)	18 (.45)	15 (.38)	13 (.33)
Voltage ⁴ (DCEP)	17	17	18	18	19	19	20	20	21	21	22	22	18-20	19-21	20-22
Gas Flow, cfh (L/min)	25-35 (12-17)														
Electrical Stickout, in. (mm)	1/4-1/2 (6-12)														

⁴ Decrease 2 Volts for Ar/CO₂ Mix.

Because design, fabrication, erection and welding variables affect the results obtained in applying this type of information, the serviceability of a product or structure is the responsibility of the builder/user.

**TABLE 7 — Procedures for Carbon and Low Alloy Steel — Short Circuiting Transfer Vertical Down Fillets or Square Butt Joint
CO₂ Gas Shield**

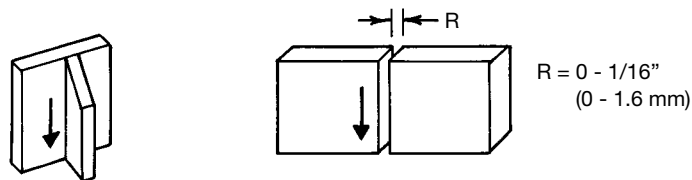
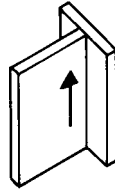

Plate Thickness, (mm)	24 ga (.6)		18 ga (1.2)		14 ga (1.9)		10 ga (3.4)			3/16" (4.8)	1/4" (6.4)
Electrode Size, in. (mm)	.025 (.6)	.030 (.8)	.030 (.8)	.035 (.9)	.030 (.8)	.035 (.9)	.030 (.8)	.035 (.9)	.045 (1.1)	.045 (1.1)	.045 (1.1)
WFS, in./min (m/min)	100 (2.5)	75 (1.9)	150 (3.8)	125 (3.2)	225 (5.7)	175 (4.4)	300 (7.6)	250 (6.4)	125 (3.2)	150 (3.8)	200 (5.0)
Amps (Approx)	35	35	70	100	100	130	130	175	145	165	200
Travel Speed, in./min (m/min)	10 (.25)	10 (.25)	15 (.38)	19 (.48)	20 (.50)	20 (.50)	20 (.50)	20 (.50)	20 (.50)	17 (.43)	17 (.43)
Voltage ⁵ (DCEP)	17	17	18	18	20	20	22	22	19	20	21
Gas Flow, cfh (L/min)	25-35 (12-17)										
Electrical Stickout, in. (mm)	1/4-1/2 (6-12)										

⁵ Decrease 2 Volts for Ar/CO₂ Mix.

**TABLE 8 — Procedures for Carbon and Low Alloy Steel — Short Circuiting Transfer Vertical Up Fillets
75% Ar/25% CO₂ Gas Shield**

Welder Prequalification Recommended For This Job



Technique:

Use Vee Weave or
Triangle Weave

Plate Thickness, in. (mm)	⁵ / ₁₆ (7.9)		³ / ₈ (9.5)	
Leg Size, in. (mm)	¹ / ₄ (6.4)		⁵ / ₁₆ (7.9)	
Electrode Dia., in. (mm)	.035 (.9)	.045 (1.1)	.035 (.9)	.045 (1.1)
WFS, in./min (m/min)	225 (5.7)	150 (3.8)	250 (6.4)	150 (3.8)
Amps (Approx)	160	165	175	165
Voltage (DCEP)	18	19	20	19
Travel Speed, in./min (m/min)	5-6 (.13-.15)	4-5 (.10-.13)	4-4.5 (.10-.11)	4-5 (.10-.11)
Gas Flow, cfh (L/min)	25-35 (12-17)			
Electrical Stickout, in. (mm)	¹ / ₄ - ¹ / ₂ (6-12)			

Because design, fabrication, erection and welding variables affect the results obtained in applying this type of information, the serviceability of a product or structure is the responsibility of the builder/user.

**TABLE 9 — Procedures for Carbon and Low Alloy Steel — Spray Transfer Flat and Horizontal Fillets
90% Argon/10% CO₂**

Technique:

Use Push Angle

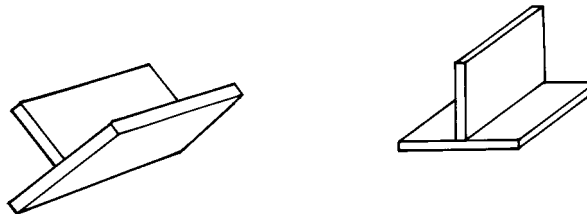

Plate Thickness, (mm)	³ / ₁₆ (4.8)	¹ / ₄ (6.4)		⁵ / ₁₆ (7.9)				³ / ₈ (9.5)			¹ / ₂ (12)	
Leg Size, in. (mm)	⁵ / ₃₂ (4.0)	³ / ₁₆ (4.8)		¹ / ₄ (6.4)				⁵ / ₁₆ (7.9)			³ / ₈ (9.5)	
Electrode Size, in. (mm)	.035 (.9)	.035 (.9)	.045 (1.1)	.035 (.9)	.045 (1.1)	.052 (1.3)	¹ / ₁₆ (1.6)	.035 ⁷ (.9)	.045 (1.1)	¹ / ₁₆ (1.6)	.052 (1.3)	¹ / ₁₆ (1.6)
WFS, in./min (m/min)	375 ⁶ (9.5)	400 ⁶ (10)	350 (8.9)	500 (12.7)	375 (9.5)	320 (8.1)	235 (6.0)	600 (15.2)	475 (12)	235 (6.0)	485 (12.3)	235 (6.0)
Amps (Approx)	195	200	285	230	300	320	350	275	335	350	430	350
Voltage (DCEP)	23	24	27	29	28	29	27	30	30	27	32	27
Travel Speed, in./min (m/min)	24 (.6)	19 (.48)	25 (.63)	14 (.35)	18 (.45)	18 (.45)	19 (.48)	10 (.25)	13 (.33)	12 (.30)	13 (.33)	9 (.23)
Gas Flow, cfh (L/min)	35-45 (17-21)											
Deposit Rate, lb/hr (kg/hr)	6.0 (2.7)	6.4 (2.9)	9.2 (4.2)	8.0 (3.6)	9.9 (4.5)	11.5 (5.2)	12.0 (5.4)	9.6 (4.4)	12.5 (5.7)	12.0 (5.4)	17.1 (7.8)	12.0 (5.4)
Electrical Stickout, in. (mm)	³ / ₄ -1 (19-25)											

⁶ Not a True Spray Transfer.

⁷ Flat Position Only.

TABLE 10 — Procedures for Carbon and Low Alloy Steel — Spray Transfer Flat Butt Joints
90% Argon/10% CO₂

Technique:
Use Push Angle

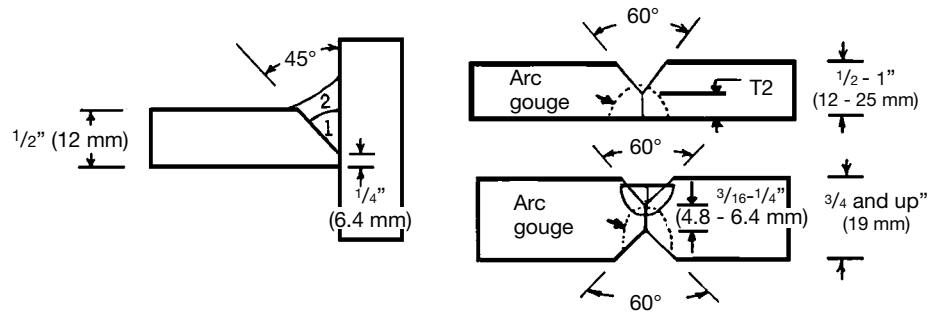

Electrode Diameter, in. (mm)	.035 (.9)	.045 (1.1)	.052 (1.3)	1/16 (1.6)
WFS, in./min (m/min)	500-600 (12.7-15.2)	375-500 (9.5-12.7)	300-485 (7.6-12.3)	210-290 (5.3-7.4)
Amps (Approx)	230-275	300-340	300-430	325-430
Voltage (DCEP)	29-30	29-30	30-32	25-28
Travel Speed, in./min (m/min)	10-15 (.25-.38)	12-18 (.30-.45)	14-24 (.35-.6)	14-23 (.35-.58)
Gas Flow, cfh (L/min)	40-45 (19-21))			
Deposit Rate, lb/hr (kg/hr)	8.0-9.6 (3.6-4.4)	9.9-13.2 (4.5-6.0)	10.6-17.1 (4.8-7.8)	10.7-14.8 (4.8-6.7)
Electrical Stickout, in. (mm)	3/4-1 (19-25)			

Because design, fabrication, erection and welding variables affect the results obtained in applying this type of information, the serviceability of a product or structure is the responsibility of the builder/user.

TABLE 11 — Procedures for Carbon and Low Alloy Steel — Pulsed Spray Transfer
Flat or Horizontal Fillets
(For Use with Lincoln IdealArc Pulse Power 500)

Mode Selector 66/67 Electrical Stickout, 3/4-1" (19-25 mm) Gas Flow, 30-40 cfh (17-19 L/min) Use Push Angle				
Plate Thickness, in. (mm)		1/4 (6.4)	5/16 (7.9)	3/8 (9.5)
Leg Size, in. (mm)		3/16 (4.8)	1/4 (6.4)	5/16 (7.9)
Electrode Size, in. (mm)		.045 (1.1)		
Wire Feed Speed, in./min (m/min)		300 (7.6)	325 (8.3)	375 (9.5)
Volts (DCEP)	Argon +5% CO ₂ ⁸	23-24	24-25	27-28
	Argon +10% CO ₂ ⁸	24.5-25.5	25.5-26.5	28-29
	Argon +20-25% CO ₂	28-29	28.5-30	30-31
Travel Speed, in./min (m/min)		13-14 (.33-.36)	14-15 (.35-.38)	10-11 (.25-.28)
Deposit Rate, lb/hr (kg/hr)		8.1 (3.6)	8.8 (4.0)	10.1 (4.5)

⁸ For use on descaled plates only.

TABLE 12 — Procedures for Carbon and Low Alloy Steel — Pulsed Spray Transfer
Vertical Up Fillets
Power Wave 455

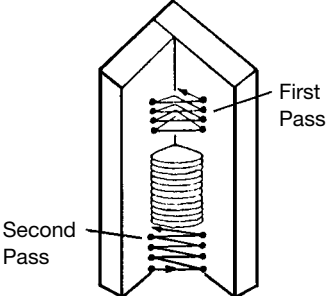
Mode Selector 73-74 Electrical Stickout, $\frac{1}{2}$ - $\frac{3}{4}$ " (13-19 mm) Gas Flow, 30-40 cfh (17-19 L/min) Use Push Angle		
Plate Thickness, in. (mm)	$\frac{3}{8}$ (9.5)	$\frac{1}{2}$ (12.5) and up
Leg Size, in. (mm)	$\frac{5}{16}$ (7.9)	Pass 2 and up
Electrode Size, in. (mm)	.045 (1.1)	.045 (1.1)
Wire Feed Speed, in./min (m/min)	125 (3.2)	130-145 (3.3-3.7)
Trim Value ¹	Trim nominally set at 1.0	
Deposition Rate, lbs/hr (kg/hr)	3.4 (1.5)	3.5-3.9 (1.6-1.8)

¹ Trim can be a function of travel speed, weld size and quality of work connection. Adjusting the Trim Value controls the arc length, thus values set below 1.0 produce shorter arc lengths than those above 1.0.

VIII. WELDING STAINLESS STEELS WITH THE GAS METAL-ARC PROCESS

Stainless steels may be welded by the gas metal-arc process, using either spray-arc, short-circuiting, or pulsed-arc transfer.

Copper backup strips are necessary for welding stainless-steel sections up to $\frac{1}{16}$ in. (1.6 mm) thick. Backup is also needed when welding $\frac{1}{4}$ in. (6.4 mm) and thicker plate from one side only.

No air must be permitted to reach the underside of the weld while the weld puddle is solidifying. Oxygen and nitrogen will weaken molten and cooling stainless steel. If the jig or fixture members permit an appreciable quantity of air to contact the underside of the weld, argon backup gas should be used.

SPRAY ARC TRANSFER

Electrode diameters as great as $\frac{3}{32}$ in. (2.4 mm), but usually around $\frac{1}{16}$ in. (1.6 mm), are used with relatively high currents to create the spray-arc transfer. A current of approximately 300-350 amperes is required for a $\frac{1}{16}$ in. (1.6 mm) electrode, depending on the shielding gas and type of stainless wire being used. The degree of spatter is dependent upon the composition and flow rate of the shielding gas, wire-feed speed, and the characteristics of the welding power supply. DCEP (Direct Current Electrode Positive) is used for most stainless-steel welding. A 1 or 2% argon-oxygen mixture is recommended for most stainless-steel welding.

On square butt welds, a backup strip should be used to prevent weld metal drophthrough. When fit-up is poor or copper backing cannot be used, drophthrough may be minimized by short-circuiting transfer welding the first pass.

When welding with the semiautomatic gun, push angle techniques are beneficial. Although the operators hand is exposed to more radiated heat, better visibility is obtained.

For welding plate $\frac{1}{4}$ in. (6.4 mm) and thicker, the gun should be moved back and forth in the direction of the joint and at the same time moved slightly from side to side. On thinner metal, however, only back and forth motion along the joint is used. Tables 14 and 15 summarize the welding procedures normally used for the spray-arc welding of stainless steel.

SHORT-CIRCUITING TRANSFER

Power-supply units with voltage, and inductance (pinch) controls are recommended for the welding of stainless steel with short-circuiting transfer. Inductance, in particular, plays an important part in obtaining proper puddle fluidity.

The shielding gas recommended for short-circuiting welding of stainless steel contains 90% helium, 7.5% argon, and 2.5% carbon dioxide. The gas gives the most desirable bead contour while keeping the CO₂ level low enough so that it does not influence the corrosion resistance of the metal. High inductance in the output is beneficial when using this gas mixture.

Single-pass welds may also be made using argon/CO₂ gas. The CO₂ in the shielding gas will affect the corrosion resistance of multipass welds made with short-circuiting transfer.

Wire extension or stickout should be kept as short as possible. Drag technique welding is usually easier on fillet welds and will result in a neater weld. Push technique welding should be used for butt welds. Outside corner welds may be made with a straight (no weave) motion.

Recommended procedure ranges for Lincoln Blue Max MIG stainless electrode are shown in Table 13.

TABLE 13 — Procedure Range Blue Max MIG ERXXXXLSi

Short Circuit Transfer						
Diameter, in (mm) Polarity, Electrical Stickout Shielding Gas, Electrode Weight, lbs (grams)	Wire Feed Speed		Approximate Current (amperes)	Arc Voltage (volts)	Deposition Rate	
	(in/min)	m/min			(lbs/hr)	(kg/hr)
.035" (.9 mm) DC(+) 1/2" (13 mm) ESO 90% He/7-1/2% Ar/2 1/2% CO ₂ .035" .279 lbs/1000" (.9 mm) 5.11 g/m	120	3.0	55	19-20	2.0	0.9
	150	3.8	75	19-20	2.5	1.2
	180	4.6	85	19-20	3.0	1.4
	205	5.2	95	19-20	3.4	1.6
	230	5.8	105	20-21	3.9	1.8
	275	6.9	110	20-21	4.6	2.1
	300	7.6	125	20-21	5.0	2.3
	325	8.3	130	20-21	5.4	2.5
	350	8.9	140	21-22	5.9	2.7
	375	9.5	150	21-22	6.3	2.9
	400	10.2	160	22-23	6.7	3.1
425	10.8	170	22-23	7.1	3.3	
.045" (1.1 mm) DC(+) 1/2" (13 mm) ESO 90% He/7-1/2% Ar/2 1/2% CO ₂ .045" .461 lbs/1000" (1.1 mm) 7.63 g/m	100	2.5	100	19-20	2.8	1.1
	125	3.2	120	19-20	3.5	1.5
	160	3.8	135	21	4.2	1.7
	175	4.4	140	21	4.8	2.0
	220	5.6	170	22	6.1	2.6
	250	6.4	175	22-23	6.9	2.9
	275	7.0	185	22-23	7.6	3.2
Spray Arc Transfer						
.035" (.9 mm) DC(+) 1/2" (13 mm) ESO 96% Ar/2% O ₂ .035" .279 lbs/1000" (.9 mm) 5.11 g/m	400	10.2	180	23	6.7	3.1
	425	10.8	190	24	7.1	3.3
	450	11.4	200	24	7.5	3.5
	475	12.1	210	25	8.0	3.7
.045" (1.1 mm) DC(+) 3/4" (19 mm) ESO 98% Ar/2% O ₂ .045" .461 lbs/1000" (1.1 mm) 7.63 g/m	240	6.1	195	24	6.6	2.8
	260	6.6	230	25	7.2	3.0
	300	7.6	240	25	8.3	3.5
	325	8.3	250	26	9.0	3.8
	360	9.1	260	26	10.0	4.2
1/16" (1.6 mm) DC(+) 3/4" (19 mm) ESO 98% Ar/2% O ₂ .062" .876 lbs/1000" (1.6 mm) 16.14 g/m	175	4.4	260	26	9.2	4.3
	200	5.1	310	29	10.5	4.9
	250	6.4	330	29	13.1	6.2
	275	7.0	360	31	14.4	6.8
	300	7.6	390	32	15.8	7.4

TABLE 14 — Gas Metal-Arc Welding (Semiautomatic) General Welding Conditions for Spray-Arc Transfer
AISI 200 and 300 Series Stainless Steels

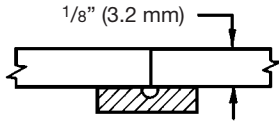
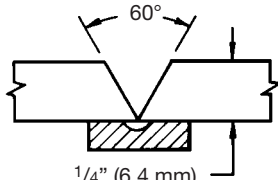
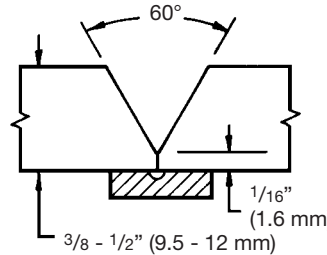
Gas-Argon + 1% Oxygen. Gas Flow, 35 cfh (17 L/min)			
Plate Thickness, in. (mm)	1/8 (3.2)	1/4 (6.4)	3/8-1/2 (9.5-12)
Electrode Size, in. (mm)	1/16 (1.6)	1/16 (1.6)	1/16 (1.6)
Passes	1	2	2
Current DCEP	225	275	300
Wire Feed Speed, in./min (m/min)	140 (3.6)	175 (4.4)	235 (6.0)
Arc Speed, in./min (m/min)	19-21 (.48-.53)	15 (.38)	20 (.51)
Electrode Required, lb/ft (kg/100m)	0.075 (1.0)	0.189 (2.6)	0.272 (3.8)

Data from *Metals Handbook*, Ninth Edition, Volume 6 — Welding, Brazing and Soldering, page 330, American Society for Metals, 1983.

**TABLE 15 — Suggested Procedures for Stainless Steel — Spray-Arc Transfer
for Horizontal and Flat Fillets and Flat Butts
(Using BLUE MAX MIG Stainless Steel Electrode)**

Gas-90% Argon + 2% Oxygen. Electrode Push Angle 5°								
.035" (0.9 mm) Electrode								
Plate Thickness, in (mm)	3/16	(4.8)	1/4	(6.4)	5/16 & Up	(7.9)		
Electrode Size, in (mm)	.035	(.9)	.035	(.9)	.035	(.9)		
Wire Feed Speed, in/min (m/min)	400-425	(10.2-10.8)	450-475	(11.4-12.1)	475	(12.1)		
Voltage, DCEP	23-24	(23-24)	24-25	(24-25)	25	(25)		
Current Amps, approx.	180-190	(180-190)	200-210	(200-210)	210	(210)		
Travel Speed, in/min (m/min)	18-19	(.46-.48)	11-12	(.28-.30)	10-11	(.25-.28)		
Electrical Stickout, in (mm)	1/2	(13)	1/2	(13)	1/2	(13)		
Gas Flow Rate, cfh (L/min)	30	(14)	30	(14)	30	(14)		
.045" (1.1 mm) Electrode								
Plate Thickness, in (mm)	3/16	(4.8)	1/4	(6.4)	5/16 & Up	(7.9)		
Electrode Size, in (mm)	.045	(1.1)	.045	(1.1)	.045	(1.1)		
Wire Feed Speed, in/min (m/min)	240-260	(6.1-6.6)	300-325	(7.6-8.3)	360	(9.1)		
Voltage, DCEP	24-25	(24-25)	25-26	(25-26)	26	(26)		
Current Amps, approx.	195-230	(195-230)	240-250	(240-250)	260	(260)		
Travel Speed, in/min (m/min)	17-19	(.43-.48)	15-18	(.38-.46)	14-15	(.36-.38)		
Electrical Stickout, in (mm)	3/4	(19)	3/4	(19)	3/4	(19)		
Gas Flow Rate, cfh (L/min)	40	(19)	40	(19)	40	(19)		
1/16" (1.6 mm) Electrode								
Plate Thickness, in (mm)	3/16	(4.8)	1/4	(6.4)	5/16	(7.9)	3/8 & Up	(9.5)
Electrode Size, in (mm)	1/16	(1.6)	1/16	(1.6)	1/16	(1.6)	1/16	(1.6)
Wire Feed Speed, in/min (m/min)	175	(4.4)	200-250	(5.1-6.4)	275	(7.0)	300	(7.6)
Voltage, DCEP	26	(26)	29	(29)	31	(31)	32	(32)
Current Amps, approx.	260	(260)	310-330	(310-330)	360	(360)	390	(390)
Travel Speed, in/min (m/min)	19-23	(.48-.58)	23-25	(.58-.64)	16	(.41)	16	(.41)
Electrical Stickout, in (mm)	3/4	(19)	3/4	(19)	3/4	(19)	3/4	(19)
Gas Flow Rate, cfh (L/min)	40	(19)	40	(19)	40	(19)	40	(19)

These procedures were developed using a shielding gas blend of 98% Argon 2% Oxygen. Other proprietary blends may require small voltage adjustments.

**TABLE 16 — Gas Metal-Arc Welding (Semiautomatic) General Welding Conditions for Short-Circuiting Transfer
AISI 200 and 300 Series Stainless Steels**

Arc Voltages listed are for Helium, + 7 ¹ / ₂ % Argon, + 2 ¹ / ₂ % CO ₂ For Argon + 2% Oxygen reduce voltage 6 volts For Argon + 25% CO ₂ reduce voltage 5 volts Gas Flow, 15 to 20 cfh (7 to 9.5 L/min) Electrode, 0.030 in. (.8 mm) dia.						
Plate Thickness, in (mm)	1/16 (1.6)	5/64 (2.0)	3/32 (2.4)	1/8 (3.2)	1/16 (1.6)	5/64 (2.0)
Electrode Size, in. (mm)	0.030 (.8)	0.030 (.8)	0.030 (.8)	0.030 (.8)	0.030 (.8)	0.030 (.8)
Current, DCEP	85	90	105	125	85	90
Voltage	21	22	23	23	22	22
Wire Feed Speed, in/min (m/min)	184 (4.7)	192 (4.9)	232 (5.9)	280 (7.1)	184 (4.7)	192 (4.9)
Arc Speed, in./min (m/mm)	17-19 (.43-.48)	13-15 (.33-.38)	14-16 (.36-.41)	14-16 (.36-.41)	19-21 (.48-.53)	11.5-12.5 (.29-.32)
Electrode Required lb/ft (kg/100m)	0.025 (.35)	0.034 (.47)	0.039 (.54)	0.046 (.64)	0.023 (.32)	0.039 (.54)

Data from *Metals Handbook*, Ninth Edition, Volume 6 — Welding, Brazing and Soldering, page 330, American Society for Metals, 1983.

A slight backward and forward motion along the axis of the joint should be used. Tables 16, 17 and 18 summarize the welding procedures normally used for the short-circuiting transfer welding of stainless steel.

Short-circuiting transfer welds on stainless steel made with a shielding gas of 90% He, 7¹/₂% Ar, 2¹/₂% CO₂ show good corrosion resistance and coalescence. Butt, lap, and single fillet welds in material ranging from .060 in. (1.5 mm) to .125 in. (3.2 mm) in 321, 310, 316, 347, 304, 410, and similar stainless steels can be successfully made.

PULSED-ARC TRANSFER

The pulsed-arc process is, by definition, a spray transfer process wherein spray transfer occurs in pulses at regularly spaced intervals rather than at random intervals. In the time between pulses, the welding current is reduced and no metal transfer occurs.

Pulsed-arc transfer is obtained by operating a power source between low and high current levels. The high current level or “pulse” forces an electrode drop to the workpiece. The low current level or “background” maintains the arc between pulses (Fig. 35).

The pulsing operation is obtained by combining the output of two power sources working at two current levels. One acts as a “background” current to preheat and precondition the advancing continuously fed electrode; the other power

source supplies a “peak” current for forcing the drop from the electrode to the workpiece. The peaking current is usually halfwave DC. If it is tied into line frequency, drops will be transferred 60 or 120 times/sec (Fig. 35). The Power Wave 455 and other pulsed-arc power sources are capable of providing a pulse rate of various frequencies

Wire diameters of .035 in. (.9 mm) and .045 in. (1.1 mm) are most common with this process for stainless electrodes. Gases for pulsed-arc transfer are similar to spray-arc welding, namely argon plus 2% oxygen.

Table 19 summarizes the welding procedures normally used for pulsed spray welding of stainless steel.

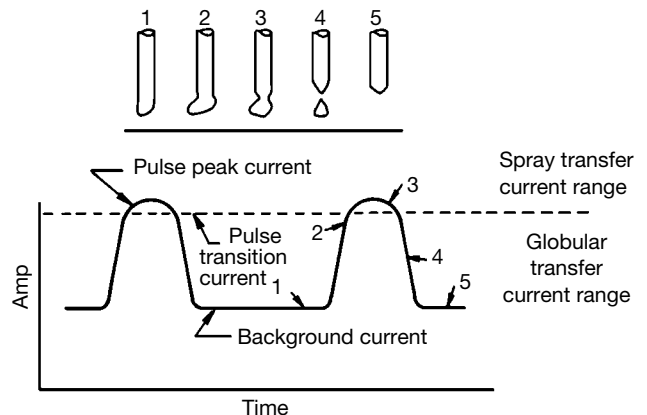
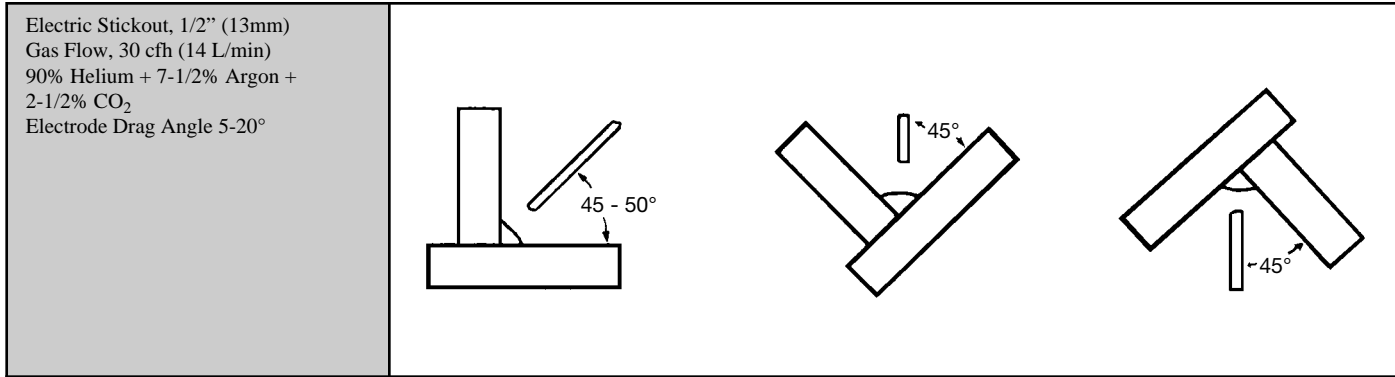

FIGURE 35 — Pulsed-arc transfer.

TABLE 17 — Suggested Procedures for Stainless Steel — Short Circuit Transfer
Horizontal, Flat and Vertical Down Fillets
(Using BLUE MAX MIG Stainless Steel Electrode)



.035" (0.9 mm) Electrode						
Plate Thickness, in (mm)	18 ga (1.2)	16 ga (1.5)	14 ga (1.9)			
Electrode Size, in (mm)	.035 (.9)	.035 (.9)	.035 (.9)			
Wire Feed Speed, in/min (m/min)	120-150 (3.0-3.8)	180-205 (4.6-5.2)	230-275 (5.8-7.0)			
Voltage, DCEP	19-20 (19-20)	19-20 (19-20)	20-21 (20-21)			
Current Amps, approx.	55-75 (55-75)	85-95 (85-95)	105-110 (105-110)			
Arc Speed, in/min (m/min)	10-16 (.25-.41)	15-22 (.38-.56)	18-21 (.46-.53)			
Plate Thickness, in (mm)	12 ga (2.7)	10 ga (3.5)	3/16 (4.8)	1/4 (6.4)		
Electrode Size, in (mm)	.035 (.9)	.035 (.9)	.035 (.9)	.035 (.9)		
Wire Feed Speed, in/min (m/min)	300-325 (7.6-8.3)	300-325 (7.6-8.3)	350-375 (8.9-9.5)	400-425 (10.2-10.8)		
Voltage, DCEP	20-21 (20-21)	20-21 (20-21)	21-22 (21-22)	22-23 (22-23)		
Current Amps, approx.	125-130 (125-130)	125-130 (125-130)	140-150 (140-150)	160-170 (160-170)		
Arc Speed, in/min (m/min)	15-21 (.38-.53)	14-20 (.36-.51)	18-22 (.46-.56)	12-13 (.30-.33)		
.045" (1.1 mm) Electrode						
Plate Thickness, in (mm)	12 ga (2.7)	10 ga (3.5)	3/16 (4.8)	1/4 (6.4)		
Electrode Size, in (mm)	.045 (1.1)	.045 (1.1)	.045 (1.1)	.045 (1.1)		
Wire Feed Speed, in/min (m/min)	100-125 (2.5-3.2)	150-175 (3.8-4.4)	220-250 (5.6-6.4)	250-275 (6.4-7.0)		
Voltage, DCEP	19-20 (19-20)	21 (21)	22 (22)	22-23 (22-23)		
Current Amps, approx.	100-120 (100-120)	135-150 (135-140)	170-175 (170-175)	175-185 (175-185)		
Arc Speed, in/min (m/min)	14-21 (.36-.53)	19-20 (.48-.51)	20-21 (.51-.53)	13-14 (.33-.36)		

**TABLE 18 — Suggested Procedures for Stainless Steel —
Short Circuit Transfer for Vertical Up Fillets
(Using BLUE MAX MIG Stainless Steel Electrode)**

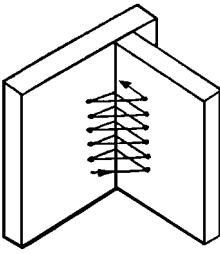
Electrical Stickout, 1/2" (13mm) Gas Flow, 30 cfh (14 L/min) 90% Helium 7-1/2% Argon + 2-1/2% CO ₂ Electrode Drag Angle 5-10°		
Steel Thickness, in (mm)	1/4	(6.4)
Electrode Size, in (mm)	.035	(.9)
Wire Feed Speed, in/min (m/min)	175	(4.4)
Voltage, DCEP	21.5	(21.5)
Current Amps, approx.	90	(90)
Arc Speed, in/min (m/min)	4	(.10)

**TABLE 19 — Procedures for Stainless Steel — Pulsed Spray Transfer
Flat or Horizontal Fillets
(For use with Power Wave 455)**

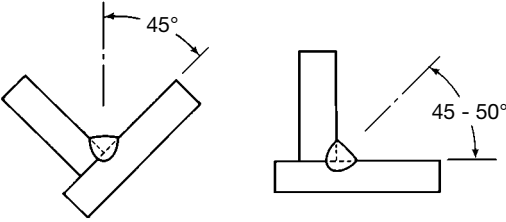
Electrical Stickout, 3/8"-1/2" (9.5-13 mm) Gas Flow, 25-40 cfh (12-19 L/min) Argon + 2% Oxygen Use Push Angle					
Plate Thickness, in. (mm)	14 ga (1.9)	12 ga (2.6)	3/16 (4.8)	1/4 (6.4)	5/16 (7.9)
Leg Size, in. (mm)	—	—	—	3/16 (4.8)	1/4 (6.4)
Electrode Size, in. (mm)	.045 (1.1)				
Wire Feed Speed, in./min (m/min)	150 (3.8)	180 (4.6)	200 (5.0)	275 (7.0)	300 (7.6)
Trim Value ¹	Trim nominally set at 1.0				
Mode Selector	62	63	65	66	67
Electrical Stickout, in. (mm)	3/8-1/2 (9.5-13)				
Gas Flow Rate, cfh (L/min)	25-40 (12-19)				
Drag Angle (deg)	0-5 Push				
Deposition Rate, lbs/hr (kg/hr)	4.2 (1.9)	5.0 (2.3)	5.5 (2.5)	7.6 (3.4)	8.3 (3.8)

These procedures were developed using 98% argon 2% oxygen shielding gas.
For out-of-position welding start with settings for one gauge or thickness smaller.

¹ Trim can be a function of travel speed, weld size and quality of work connection. Adjusting the Trim Value controls the arc length, thus values set below 1.0 produce shorter arc lengths than those above 1.0.

IX. WELDING ALUMINUM

Principal factors for consideration in the GMAW (MIG) welding of aluminum are thickness of plate, alloy, and type of equipment available. Typical procedures for GMAW (MIG) welding of various joint designs in aluminum sheet and plate are given in Tables 20 through 24. The data supplied is approximate and is intended to serve only as a starting point. For each application, an optimum set of welding conditions can be established from these procedures.

It is considered good practice to prepare prototype weldments in advance of the actual production so that welding conditions can be determined on the prototype. It is further recommended that welders practice beforehand under simulated production conditions. This helps avoid mistakes caused by lack of experience.

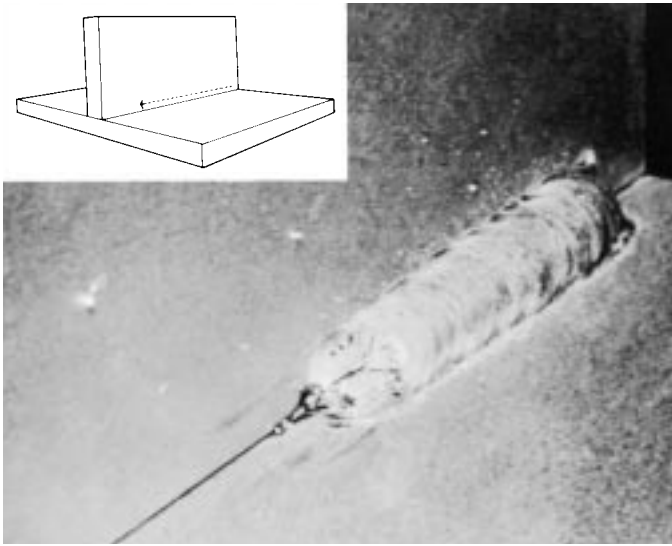

FIGURE 36 — The finish of a MIG weld in aluminum leaves a crater that is very susceptible to cracking.

JOINT GEOMETRY

Typical joint geometrics for semiautomatic MIG welding are shown in Fig 38. Factors affecting the choice of the joint geometry include metal thickness, whether backing is to be used (and if so, what kind), the welding position and whether welding is to be done from one side of the joint, mostly from one side, or about equally from both sides.

Where intermittent welding is to be used, one deviation from the regular pattern of torch travel is recommended. GMAW (MIG) welding of aluminum normally leaves a crater at the end of the weld, as illustrated in Fig. 36. This crater is prone to cracking which, in turn, could initiate fracture in the intermittent weld.

One method of avoiding this problem is to reverse the direction of welding at the end of each tack or intermittent weld, so that the crater is filled, as shown in Fig. 37. Other techniques for eliminating problems of cracking of the crater area are:

1. Use run-on and run-off tabs
2. Break the arc and restrike it to fill the crater
3. Use special circuitry and power source control to produce a specific rate of arc decay

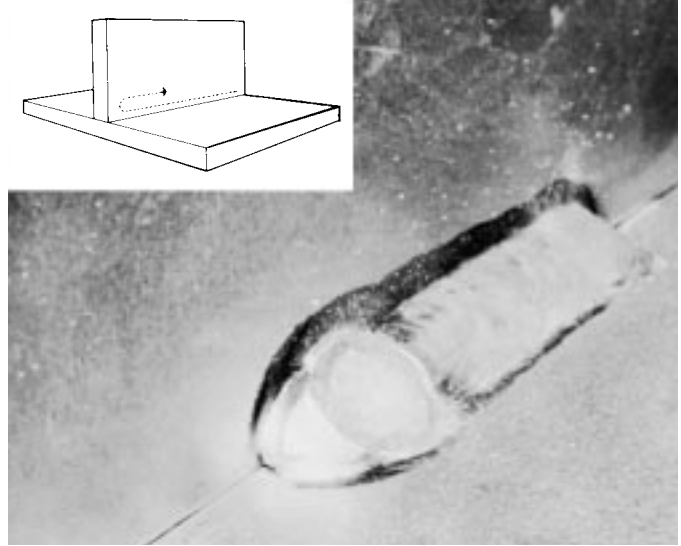

FIGURE 37 — Doubling back at the end of a MIG weld eliminates the crater and the cracking problems that usually accompany it.

SETTING A PROCEDURE

For semiautomatic welding, the welding speed and other variables, such as gun angle and gun-to-work distance, are under the continuous control of the welder. However, gas flow, current and arc length must be preset. Gas flow can be set easily because it is independent of the other variables. However, the welder has two machine settings to concern him, one for arc length and one for arc current.

The two basic power source types, drooper and CV, are opposites in the adjustment of current and voltage. With a drooper, the current is set by adjusting the power source, just as it would be for shielded metal arc (stick electrode) welding. The arc length is set by adjusting the electrode wire feed speed. Conversely, with a CV machine, the arc length is set by adjusting the output voltage of the power source and the current is set by adjusting the electrode wire feed speed.

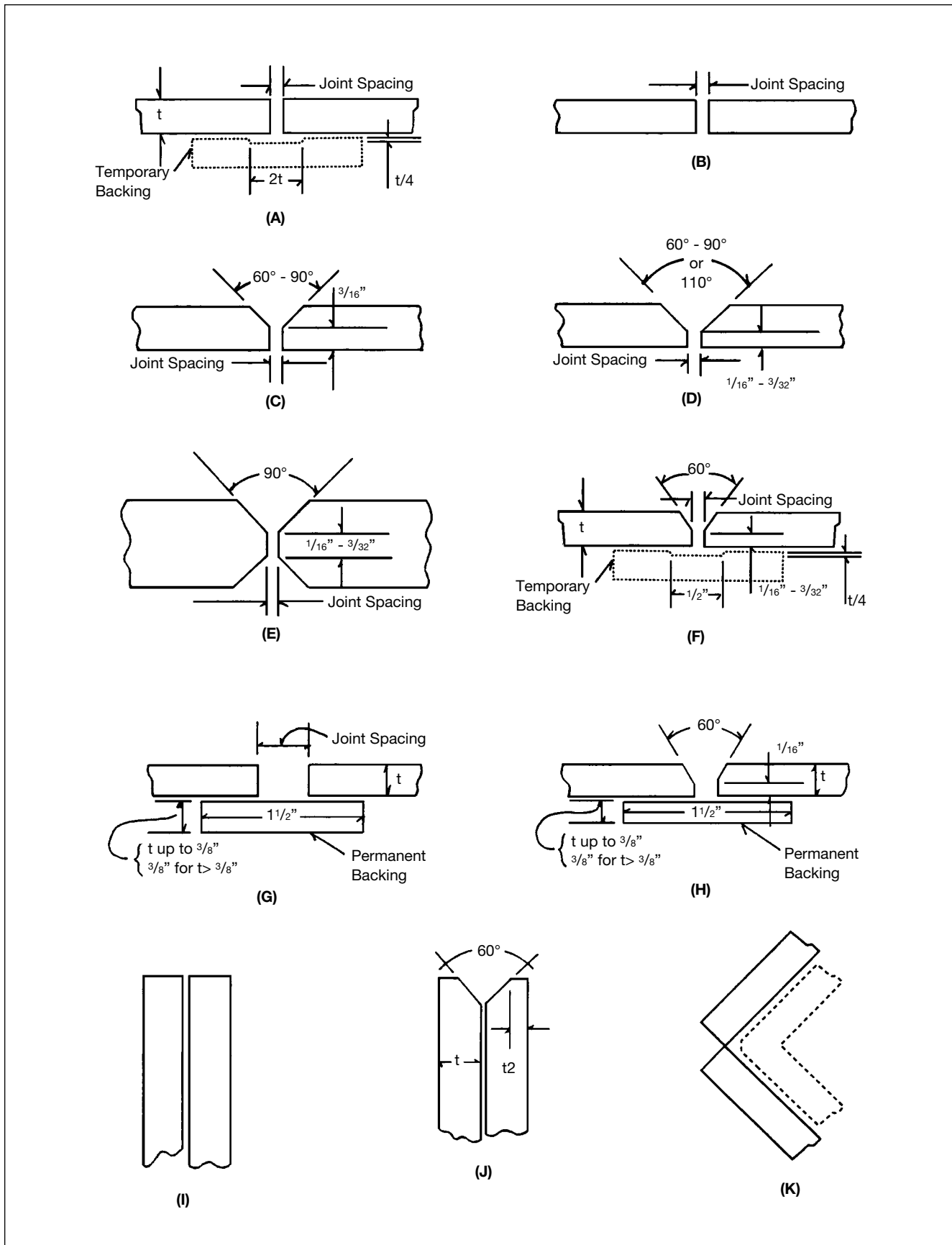

FIGURE 38 — Typical Joint Geometries for Semiautomatic MIG Welding Aluminum.

TABLE 20 — Typical Semiautomatic MIG Procedures for Groove Welding Aluminum

Metal Thickness (Inches)	Weld Position ¹	Edge Preparation ²	Joint Spacing (Inches)	Weld Passes	Electrode Diameter (Inches)	DC (EP) ³ (Amps)	Arc Voltage ³ (Volts)	Argon Gas Flow (cfh)	Arc Travel Speed (ipm/pass)	Approx. Electrode Consump. (lb/100 ft.)
1/16	F	A	None	1	.030	70-110	15-20	25	25-45	1.5
	F	G	3/32	1	.030	70-110	15-20	25	25-45	2
3/32	F	A	None	1	.030-3/64	90-150	18-22	30	25-45	1.8
	F, V, H, O	G	1/8	1	.030	110-130	18-23	30	25-30	2
1/8	F, V, H	A	0-3/32	1	.030-3/64	120-150	20-24	30	24-30	2
	F, V, H, O	G	3/16	1	.030-3/64	110-135	19-23	30	18-28	3
3/16	F, V, H	B	0-1/16	1F, 1R	.030-3/64	130-175	22-26	35	24-30	4
	F, V, H	F	0-1/16	1	3/64	140-180	23-27	35	24-30	5
	O	F	0-1/16	2F	3/64	140-175	23-27	60	24-30	5
	F, V	H	3/32-3/16	2	3/64-1/16	140-185	23-27	35	24-30	8
	H, O	H	3/16	3	3/64	130-175	23-27	60	25-35	10
1/4	F	B	0-3/32	1F, 1R	3/64-1/16	175-200	24-28	40	24-30	6
	F	F	0-3/32	2	3/64-1/16	185-225	24-29	40	24-30	8
	V, H	F	0-3/32	3F, 1R	3/64	165-190	25-29	45	25-35	10
	O	F	0-3/32	3F, 1R	3/64-1/16	180-200	25-29	60	25-35	10
	F, V	H	1/8-1/4	2-3	3/64-1/16	175-225	25-29	40	24-30	12
	O, H	H	1/4	4-6	3/64-1/16	170-200	25-29	60	25-40	12
3/8	F	C-90°	0-3/32	1F, 1R	1/16	225-290	26-29	50	20-30	16
	F	F	0-3/32	2F, 1R	1/16	210-275	26-29	50	24-35	18
	V, H	F	0-3/32	3F, 1R	1/16	190-220	26-29	55	24-30	20
	O	F	0-3/32	5F, 1R	1/16	200-250	26-29	80	25-40	20
	F, V	H	1/4-3/8	4	1/16	210-290	26-29	50	24-30	35
	O, H	H	3/8	8-10	1/16	190-260	26-29	80	25-40	50
3/4	F	C-60°	0-3/32	3F, 1R	3/32	340-400	26-31	60	14-20	50
	F	F	0-1/8	4F, 1R	3/32	325-375	26-31	60	16-20	70
	V, H, O	F	0-1/16	8F, 1R	1/16	240-300	26-30	80	24-30	75
	F	E	0-1/16	3F, 3R	1/16	270-330	26-30	60	16-24	70
	V, H, O	E	0-1/16	6F, 6R	1/16	230-280	26-30	80	16-24	75

1 F = Flat; V = Vertical; H = Horizontal; O = Overhead.

2 See joint designs in Figure 38.

3 For 5xxx series electrodes use a welding current in the high side of the range and an arc voltage in the lower portion of the range. 1xxx, 2xxx, and 4xxx series electrodes would use the lower currents and higher arc voltages.

TABLE 21 — Typical Semiautomatic MIG Procedures for Fillet and Lap Welding Aluminum

Metal Thickness ¹ (Inches)	Weld Position ²	Weld Passes ³	Electrode Diameter (Inches)	DC (EP) ⁴ (Amps)	Arc Voltage ⁴ (Volts)	Argon Gas Flow (cfh)	Arc Travel Speed	Approx. Electrode Consumption ³ (lb/100 feet)
3/32	F, V, H, O	1	0.030	100-130	18-22	30	24-30	1.8
1/8	F	1	0.030-3/64	125-150	20-24	30	24-30	2
	V, H	1	0.030	110-130	19-23	30	24-30	2
	O	1	0.030-3/64	115-140	20-24	40	24-30	2
3/16	F	1	3/64	180-210	22-26	30	24-30	4.5
	V, H	1	0.030-3/64	130-175	21-25	35	24-30	4.5
	O	1	0.030-3/64	130-190	22-26	45	24-30	4.5
1/4	F	1	3/64-1/16	170-240	24-28	40	24-30	7
	V, H	1	3/64	170-210	23-27	45	24-30	7
	O	1	3/64-1/16	190-220	24-28	60	24-30	7
3/8	F	1	1/16	240-300	26-29	50	18-25	17
	H, V	3	1/16	190-240	24-27	60	24-30	17
	O	3	1/16	200-240	25-28	85	24-30	17
3/4	F	4	3/32	360-380	26-30	60	18-25	66
	H, V	4-6	1/16	260-310	25-29	70	24-30	66
	O	10	1/16	275-310	25-29	85	24-30	66

1 Metal thickness of 3/4 in. or greater for fillet welds sometimes employs a double vee bevel of 50 deg. or greater included vee with 3/32 to 1/8 in. land thickness on the abutting member.

2 F = Flat; V = Vertical; H = Horizontal; O = Overhead.

3 Number of weld passes and electrode consumption given for weld on one side only.

4 For 5xxx series electrodes use a welding current in the high side of the range given and an arc voltage in the lower portion of the range. 1xxx, 2xxx and 4xxx series electrodes would use the lower currents and higher arc voltages.

X. SAFE PRACTICES

Introduction. The general subject of safety and safety practices in welding, cutting, and allied processes is covered in ANSI Z49.1⁸, “Safety in Welding and Cutting,” and ANSI Z49.2⁹. “Fire Prevention in the Use of Welding and Cutting Processes.” The handling of compressed gases is covered in CGA P-1¹⁰.

Personnel should be familiar with the safe practices discussed in these documents, equipment operating manuals, and Material Safety Data Sheets (MSDS) for consumables.

In addition to the hazards discussed in the Arc Welding Safety Precautions following this section, be familiar with the safety concerns discussed below.

Safe Handling of Shielding Gas Cylinders and Regulators. Compressed gas cylinders should be handled carefully and should be adequately secured when in use. Knocks, falls, or rough handling may damage cylinders, valves, or fuse plugs and cause leakage or accident. Valve protecting caps, when supplied, should be kept in place (handtight) until the connecting of container equipment.

Cylinder Use. The following should be observed when setting up and using cylinders of shielding gas:

1. Properly secure the cylinder.
2. Before connecting a regulator to the cylinder valve, the valve should momentarily be slightly opened and closed immediately (opening) to clear the valve of dust or dirt that otherwise might enter the regulator. The valve operator should stand to one side of the regulator gauges, never in front of them.
3. After the regulator is attached, the adjusting screw should be released by turning it counter-clockwise. The cylinder valve should then be opened slowly to prevent a too-rapid surge of high pressure gas into the regulator.
4. The source of the gas supply (i.e., the cylinder valve) should be shut off if it is to be left unattended.

Gases. The major toxic gases associated with GMAW welding are ozone, nitrogen dioxide, and carbon monoxide. Phosgene gas could also be present as a result of thermal or ultraviolet decomposition of chlorinated hydrocarbon cleaning agents located in the vicinity of welding operations, such as trichloroethylene and perchlorethylene. **DEGREASING OR OTHER CLEANING OPERATIONS INVOLVING CHLORINATED HYDROCARBONS SHOULD BE SO LOCATED THAT VAPORS FROM THESE OPERATIONS CANNOT BE REACHED BY RADIATION FROM THE WELDING ARC.**

Ozone. The ultraviolet light emitted by the GMAW arc acts on the oxygen in the surrounding atmosphere to produce ozone, the amount of which will depend upon the intensity and the wave length of the ultraviolet energy, the humidity, the amount of screening afforded by any welding fumes, and other factors. The ozone concentration will generally be increased with an increase in welding current, with the use of argon as the shielding gas, and when welding highly reflective metals. If the ozone cannot be reduced to a safe level by ventilation or process variations, it will be necessary to supply fresh air to the welder either with an air supplied respirator or by other means.

Nitrogen Dioxide. Some test results show that high concentrations of nitrogen dioxide are found only within 6 in. (152 mm) of the arc. With normal natural ventilation, these concentrations are quickly reduced to safe levels in the welder’s breathing zone, so long as the welder keeps his head out of the plume of fumes (and thus out of the plume of welding-generated gases). Nitrogen dioxide is not thought to be a hazard in GMAW.

Carbon Monoxide. Carbon dioxide shielding used with the GMAW process will be dissociated by the heat of the arc to form carbon monoxide. Only a small amount of carbon monoxide is created by the welding process, although relatively high concentrations are formed temporarily in the plume of fumes. However, the hot carbon monoxide oxidizes to carbon dioxide so that the concentrations of carbon monoxide become insignificant at distances of more than 3 or 4 in. (76 or 102 mm) from the welding plume.

Under normal welding conditions there should be no hazard from this source. When the welder must work with his head over the welding arc, or with the natural ventilation moving the plume of fumes towards his breathing zone, or where welding is performed in a confined space, ventilation adequate to deflect the plume or remove the fumes and gases must be provided. Because shielding gases can displace air, use special care to insure that breathing air is safe when welding in a confined space. (See ANSI Z49.1.)

Metal Fumes. The welding fumes generated by GMAW can be controlled by general ventilation, local exhaust ventilation, or by respiratory protective equipment as described in ANSI Z49.1. The method of ventilation required to keep the level of toxic substances within the welder’s breathing zone below acceptable concentrations is directly dependent upon a number of factors. Among these are the material being welded, the size of the work area, and the degree of the confinement or obstruction to normal air movement where the welding is being done. Each operation should be evaluated on an individual basis in order to determine what will be required. Acceptable levels of toxic substances associated with welding, and designated as time-weighted average threshold limit values (TLV) and ceiling values, have been established by the American Conference of Governmental Industrial Hygienists (ACGIH) and by the Occupational Safety and Health Administration (OSHA). Compliance with these acceptable levels can be checked by sampling the atmosphere under the welder’s helmet or in the immediate vicinity of the helper’s breathing zone. The principle composition or particulate matter (welding fume) which may be present within the welder’s breathing zone are listed in Table 22. Sampling should be in accordance with ANSI/ AWS F1.1, Method for Sampling Airborne Particulates Generated by Welding and Allied Processes.

⁸ ANSI Z49.1 is available from the American Welding Society, 550 N.W. LeJeune Road, Miami, Florida 33126.

⁹ ANSI Z49.2 is available from the American National Standards Institute, 11 West 42nd Street, New York, NY 10036.

¹⁰ CGA P-1 is available from the Compressed Gas Association, Inc., 1235 Jefferson Davis Highway, Suite 501, Arlington, VA 22202.

TABLE 22— Particulate matter with possible significant fume concentrations in the welder’s breathing zone¹¹

Material being welded	Particulate matter
Aluminum and aluminum alloys	Al, Mg, Mn, Cr
Magnesium alloys	Mg, Al, Zn
Copper and copper alloys	Cu, Be, Zn, Pb
Nickel and nickel alloys	Ni, Cu, Cr, Fe
Titanium and titanium alloys	Ti
Austenitic stainless steels	Cr, Ni, Fe
Carbon steels ¹²	Fe, Cu, Mn

¹¹ See AWS F1.3, “Evaluating Contaminants in the Welding Environment, A Sampling Strategy Guide”.

¹² For plated, coated, or painted materials, also Cd, Zn, Pb, and Hg.

Radiant Energy. The total radiant energy produced by the GMAW process can be higher than that produced by the SMAW process, because of the significantly lower welding fumes and the more exposed arc. Generally, the highest ultraviolet radiant energy intensities are produced when using an argon shielding gas and when welding on aluminum.

The minimum suggested filter glass shades for GMAW, as presented in ANSI Z49.1 as a guide, are:

TABLE 23— Minimum suggested Filter Glass Shades

	Shades ¹³
When welding ferrous (steel) material	12
When welding nonferrous (Al, Brass, etc.)	11
Flash goggles	2

¹³ The choice of a filter shade may be made on the basis of visual acuity and may therefore vary from one individual to another, particularly under different current densities, materials, and welding processes. However, the degree of protection from radiant energy afforded by the filter plate or lens when chosen to allow visual acuity will still remain in excess of the needs of eye filter protection.

Dark leather or wool clothing (to reduce reflection which cause ultraviolet burns to the face and neck underneath the helmet) is recommended for GMAW. The greater intensity of the ultraviolet radiation will cause rapid disintegration of cotton clothing.

Noise — Hearing Protection. Personnel must be protected against exposure to noise generated in welding and cutting processes in accordance with paragraph 1910.95 “Occupational Noise Exposure” of the Occupational Safety and Health Standards, Occupational Safety and Health Administration, U.S. Department of Labor.

XI. PRODUCT REFERENCES

These Lincoln products are available for Gas Metal Arc Welding. Further information may be obtained by writing for the specification bulletins shown. Application assistance is available from your local Lincoln Distributor.

TABLE 24— Lincoln GMAW Product Bulletins

EQUIPMENT		BULLETIN
SP-100T	115V Single Phase Wire Feeder Welder	E7.10
SP-125 Plus	115V Single Phase Wire Feeder Welder	E7.20
SP-170T	230V Single Phase Wire Feeder Welder	E7.30
SP-175 Plus	230V Single Phase Wire Feeder Welder	E7.35
SP-255	230V Single Phase Wire Feeder Welder	E7.61
V300-Pro	Multiprocess Power Source	E5.90
DC-400	Multiprocess Power Source	E5.20
DC-655	Multiprocess Power Source	E5.46
CV-250	Constant Voltage MIG Power Source	E4.10
CV-300	Constant Voltage MIG Power Source	E4.20
CV-400	Constant Voltage MIG Power Source	E4.30
CV-655	Constant Voltage MIG Power Source	E4.40
STT-II	Surface Tension Transfer	E4.52
Power Wave 455	Synergic Pulse Power Source	E5.160
Ranger 8	Engine Driven Welder/Aux. Power Source	E6.90
Ranger 9	Engine Driven Welder/Aux. Power Source	E6.100
Ranger 275	Engine Driven Welder/Aux. Power Source	E6.105
Ranger 300D/DLX	Engine Driven Welder/Aux. Power Source	E6.115
Commander 300	Engine Driven Welder/Aux. Power Source	E6.205
Commander 400 S & W	Engine Driven Welder/Aux. Power Source	E6.210
LN-7 GMA	Industry Standard Wire Feeder	E8.10
LN-742	42 VAC	E8.20
LN-9 GMA	Rugged Wire Feeder	E8.50
LN-10	Heavy Duty Wire Feeder	E8.200
LN-25	Portable Wire Feeder	E8.100
DH-10	Double Header Wire Feeder	E8.200
STT-10	STT-II Wire Feeder	E8.190
Power Feed 10	Bench/Boom Wire Feeder	E8.260
Power Feed 11	Suitcase Wire Feeder	E8.261
ELECTRODES		
L-50, L-50B	Automatic Welding Electrode ER70S-3	C4.10
L-52	Automatic Welding Electrode ER70S-2	C4.10
L-54, L-54 B	Automatic Welding Electrode ER70S-4	C4.10
L-56, L-56B	Automatic Welding Electrode ER70S-6	C4.10
LA-90	Automatic Welding Electrode ER80S-D2	C4.10
LA-100	Automatic Welding Electrode MIL-100S.1	C4.10
LA-75	ER80S-Ni 1	C4.10
Blue Max	MIG Electrodes	C6.1

⚠ WARNING

⚠ CALIFORNIA PROPOSITION 65 WARNINGS ⚠

Diesel engine exhaust and some of its constituents are known to the State of California to cause cancer, birth defects, and other reproductive harm.

The Above For Diesel Engines

The engine exhaust from this product contains chemicals known to the State of California to cause cancer, birth defects, or other reproductive harm.

The Above For Gasoline Engines

ARC WELDING CAN BE HAZARDOUS. PROTECT YOURSELF AND OTHERS FROM POSSIBLE SERIOUS INJURY OR DEATH. KEEP CHILDREN AWAY. PACEMAKER WEARERS SHOULD CONSULT WITH THEIR DOCTOR BEFORE OPERATING.

Read and understand the following safety highlights. For additional safety information, it is strongly recommended that you purchase a copy of "Safety in Welding & Cutting - ANSI Standard Z49.1" from the American Welding Society, P.O. Box 351040, Miami, Florida 33135 or CSA Standard W117.2-1974. A Free copy of "Arc Welding Safety" booklet E205 is available from the Lincoln Electric Company, 22801 St. Clair Avenue, Cleveland, Ohio 44117-1199.

BE SURE THAT ALL INSTALLATION, OPERATION, MAINTENANCE AND REPAIR PROCEDURES ARE PERFORMED ONLY BY QUALIFIED INDIVIDUALS.



FOR ENGINE powered equipment.

1.a. Turn the engine off before troubleshooting and maintenance work unless the maintenance work requires it to be running.



1.b. Operate engines in open, well-ventilated areas or vent the engine exhaust fumes outdoors.



1.c. Do not add the fuel near an open flame welding arc or when the engine is running. Stop the engine and allow it to cool before refueling to prevent spilled fuel from vaporizing on contact with hot engine parts and igniting. Do not spill fuel when filling tank. If fuel is spilled, wipe it up and do not start engine until fumes have been eliminated.

1.d. Keep all equipment safety guards, covers and devices in position and in good repair. Keep hands, hair, clothing and tools away from V-belts, gears, fans and all other moving parts when starting, operating or repairing equipment.

1.e. In some cases it may be necessary to remove safety guards to perform required maintenance. Remove guards only when necessary and replace them when the maintenance requiring their removal is complete. Always use the greatest care when working near moving parts.



1.f. Do not put your hands near the engine fan. Do not attempt to override the governor or idler by pushing on the throttle control rods while the engine is running.

1.g. To prevent accidentally starting gasoline engines while turning the engine or welding generator during maintenance work, disconnect the spark plug wires, distributor cap or magneto wire as appropriate.

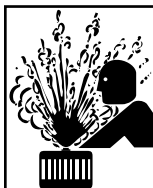

1.h. To avoid scalding, do not remove the radiator pressure cap when the engine is hot.



ELECTRIC AND MAGNETIC FIELDS may be dangerous

2.a. Electric current flowing through any conductor causes localized Electric and Magnetic Fields (EMF). Welding current creates EMF fields around welding cables and welding machines

2.b. EMF fields may interfere with some pacemakers, and welders having a pacemaker should consult their physician before welding.

2.c. Exposure to EMF fields in welding may have other health effects which are now not known.

2.d. All welders should use the following procedures in order to minimize exposure to EMF fields from the welding circuit:

2.d.1. Route the electrode and work cables together - Secure them with tape when possible.

2.d.2. Never coil the electrode lead around your body.

2.d.3. Do not place your body between the electrode and work cables. If the electrode cable is on your right side, the work cable should also be on your right side.

2.d.4. Connect the work cable to the workpiece as close as possible to the area being welded.

2.d.5. Do not work next to welding power source.

Mar '95



ELECTRIC SHOCK can kill.

- 3.a. The electrode and work (or ground) circuits are electrically "hot" when the welder is on. Do not touch these "hot" parts with your bare skin or wet clothing. Wear dry, hole-free gloves to insulate hands.
- 3.b. Insulate yourself from work and ground using dry insulation. Make certain the insulation is large enough to cover your full area of physical contact with work and ground.

In addition to the normal safety precautions, if welding must be performed under electrically hazardous conditions (in damp locations or while wearing wet clothing; on metal structures such as floors, gratings or scaffolds; when in cramped positions such as sitting, kneeling or lying, if there is a high risk of unavoidable or accidental contact with the workpiece or ground) use the following equipment:

- Semiautomatic DC Constant Voltage (Wire) Welder.
 - DC Manual (Stick) Welder.
 - AC Welder with Reduced Voltage Control.
- 3.c. In semiautomatic or automatic wire welding, the electrode, electrode reel, welding head, nozzle or semiautomatic welding gun are also electrically "hot".
- 3.d. Always be sure the work cable makes a good electrical connection with the metal being welded. The connection should be as close as possible to the area being welded.
- 3.e. Ground the work or metal to be welded to a good electrical (earth) ground.
- 3.f. Maintain the electrode holder, work clamp, welding cable and welding machine in good, safe operating condition. Replace damaged insulation.
- 3.g. Never dip the electrode in water for cooling.
- 3.h. Never simultaneously touch electrically "hot" parts of electrode holders connected to two welders because voltage between the two can be the total of the open circuit voltage of both welders.
- 3.i. When working above floor level, use a safety belt to protect yourself from a fall should you get a shock.
- 3.j. Also see Items 6.c. and 8.



ARC RAYS can burn.

- 4.a. Use a shield with the proper filter and cover plates to protect your eyes from sparks and the rays of the arc when welding or observing open arc welding. Headshield and filter lens should conform to ANSI Z87.1 standards.
- 4.b. Use suitable clothing made from durable flame-resistant material to protect your skin and that of your helpers from the arc rays.
- 4.c. Protect other nearby personnel with suitable, non-flammable screening and/or warn them not to watch the arc nor expose themselves to the arc rays or to hot spatter or metal.



FUMES AND GASES can be dangerous.

- 5.a. Welding may produce fumes and gases hazardous to health. Avoid breathing these fumes and gases. When welding, keep your head out of the fume. Use enough ventilation and/or exhaust at the arc to keep fumes and gases away from the breathing zone. **When welding with electrodes which require special ventilation such as stainless or hard facing (see instructions on container or MSDS) or on lead or cadmium plated steel and other metals or coatings which produce highly toxic fumes, keep exposure as low as possible and below Threshold Limit Values (TLV) using local exhaust or mechanical ventilation. In confined spaces or in some circumstances, outdoors, a respirator may be required. Additional precautions are also required when welding on galvanized steel.**
- 5.b. Do not weld in locations near chlorinated hydrocarbon vapors coming from degreasing, cleaning or spraying operations. The heat and rays of the arc can react with solvent vapors to form phosgene, a highly toxic gas, and other irritating products.
- 5.c. Shielding gases used for arc welding can displace air and cause injury or death. Always use enough ventilation, especially in confined areas, to insure breathing air is safe.
- 5.d. Read and understand the manufacturer's instructions for this equipment and the consumables to be used, including the material safety data sheet (MSDS) and follow your employer's safety practices. MSDS forms are available from your welding distributor or from the manufacturer.
- 5.e. Also see item 1.b.

Mar '95

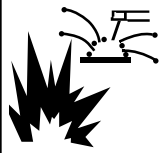

WELDING SPARKS can cause fire or explosion.

- 6.a. Remove fire hazards from the welding area. If this is not possible, cover them to prevent the welding sparks from starting a fire. Remember that welding sparks and hot materials from welding can easily go through small cracks and openings to adjacent areas. Avoid welding near hydraulic lines. Have a fire extinguisher readily available.
- 6.b. Where compressed gases are to be used at the job site, special precautions should be used to prevent hazardous situations. Refer to "Safety in Welding and Cutting" (ANSI Standard Z49.1) and the operating information for the equipment being used.
- 6.c. When not welding, make certain no part of the electrode circuit is touching the work or ground. Accidental contact can cause overheating and create a fire hazard.
- 6.d. Do not heat, cut or weld tanks, drums or containers until the proper steps have been taken to insure that such procedures will not cause flammable or toxic vapors from substances inside. They can cause an explosion even though they have been "cleaned". For information, purchase "Recommended Safe Practices for the Preparation for Welding and Cutting of Containers and Piping That Have Held Hazardous Substances", AWS F4.1 from the American Welding Society (see address above 1.a. [Safety]).
- 6.e. Vent hollow castings or containers before heating, cutting or welding. They may explode.
- 6.f. Sparks and spatter are thrown from the welding arc. Wear oil free protective garments such as leather gloves, heavy shirt, cuffless trousers, high shoes and a cap over your hair. Wear ear plugs when welding out of position or in confined places. Always wear safety glasses with side shields when in a welding area.
- 6.g. Connect the work cable to the work as close to the welding area as practical. Work cables connected to the building framework or other locations away from the welding area increase the possibility of the welding current passing through lifting chains, crane cables or other alternate circuits. This can create fire hazards or overheat lifting chains or cables until they fail.
- 6.h. Also see item 1.c.

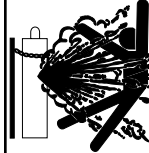

CYLINDER may explode if damaged.

- 7.a. Use only compressed gas cylinders containing the correct shielding gas for the process used and properly operating regulators designed for the gas and pressure used. All hoses, fittings, etc. should be suitable for the application and maintained in good condition.
- 7.b. Always keep cylinders in an upright position securely chained to an undercarriage or fixed support.
- 7.c. Cylinders should be located:
 - Away from areas where they may be struck or subjected to physical damage.
 - A safe distance from arc welding or cutting operations and any other source of heat, sparks, or flame.
- 7.d. Never allow the electrode, electrode holder or any other electrically "hot" parts to touch a cylinder.
- 7.e. Keep your head and face away from the cylinder valve outlet when opening the cylinder valve.
- 7.f. Valve protection caps should always be in place and hand tight except when the cylinder is in use or connected for use.
- 7.g. Read and follow the instructions on compressed gas cylinders, associated equipment, and CGA publication P-1, "Precautions for Safe Handling of Compressed Gases in Cylinders," available from the Compressed Gas Association 1235 Jefferson Davis Highway, Arlington, VA 22202.



FOR ELECTRICALLY powered equipment.

- 8.a. Turn off input power using the disconnect switch at the fuse box before working on the equipment.
- 8.b. Install equipment in accordance with the U.S. National Electrical Code, all local codes and the manufacturer's recommendations.
- 8.c. Ground the equipment in accordance with the U.S. National Electrical Code and the manufacturer's recommendations.

Mar '95

LINCOLN NORTH AMERICA

DISTRICT OFFICE AND SALES AGENT LOCATIONS

USA	ILLINOIS	MISSISSIPPI	OKLAHOMA	VIRGINIA
ALABAMA	CHICAGO 60521-5629 (630) 920-1500 PEORIA 61607-2046 (309) 697-8240	JACKSON 39212-9635 (601) 372-7679	OKLAHOMA CITY 73119-2416 (405) 686-1170 TULSA 74146-1622 (918) 622-9353	HERNDON 20170-5227 Washington, D.C. (703) 904-7735 ROANOKE 24153-1447 (540) 389-4032 WILLIAMSBURG 23602-7048 (757) 881-9762
BIRMINGHAM 35124-1156 (205) 988-8232 MOBILE 36693-4310 (334) 666-6524	INDIANA	MISSOURI	OREGON	WASHINGTON
ALASKA	EVANSVILLE 47710-4514 (812) 428-3225 FT. WAYNE 46825-5547 (219) 484-4422 SOUTH BEND 46530-0577 (219) 277-8619 INDIANAPOLIS 46038-9459 (317) 845-8445	KANSAS CITY (KS) 66214-1625 (913) 894-0888 ST. LOUIS 63146-3572 (314) 993-5465	PORTLAND 97230-1030 (503) 252-8835	SEATTLE 98188-7615 (206) 575-2456 SPOKANE 99005-9637 (509) 468-2770
Contact SEATTLE District Office (206) 575-2456	MONTANA	NEBRASKA	PENNSYLVANIA	WEST VIRGINIA
ARIZONA	Contact SEATTLE District Office (206) 575-2456	OMAHA 68046-2826 (402) 339-1809	BETHLEHEM 18020-2062 (610) 866-8788 ERIE 16506-2979 (814) 835-3531 JOHNSTOWN 15905-2506 (814) 535-5895 PHILADELPHIA 19008-4310 (610) 543-9462 PITTSBURGH 15275-1002 (412) 787-7733 YORK 17404-1144 (717) 764-6565	CHARLESTON 25526-9796 (304) 757-9862
PHOENIX 85260-1768 (602) 348-2004	IOWA	NEW JERSEY	SOUTH CAROLINA	WISCONSIN
ARKANSAS	CEDAR RAPIDS 52402-3160 (319) 362-6804 MOLINE, ILL 52806-1344 (319) 386-6522 DES MOINES 50265-6218 (515) 224-4121	EDISON 08837-3939 (732) 225-2000 LEBANON 08833-0700 (888) 427-2269	FLORENCE 29505-3615 (803) 673-0830 GREENVILLE 29612-0126 (864) 967-4157	GREEN BAY 54302-1829 (920) 435-1012 MILWAUKEE 53186-0403 (414) 650-9364
LITTLE ROCK 72116-7034 (501) 771-4842	KANSAS	NEW MEXICO	SOUTH DAKOTA	CANADA
CALIFORNIA	KANSAS CITY 66214-1625 (913) 894-0888 WICHITA 67037 (316) 788-7352	ALBUQUERQUE 87111-2158 (505) 237-2433	SIoux FALLS 57108-2609 (605) 339-6522	ALBERTA
FRESNO 93722-3949 (209) 276-0110 LOS ANGELES 90670-2936 (562) 906-7700 SACRAMENTO 95677-4729 (916) 630-1885 SAN DIEGO 92108-3911 (619) 208-9001 SAN FRANCISCO 94550-9657 (925) 443-9353	KENTUCKY	NEW YORK	EDMONTON T6H 2K1 (403) 436-7385 WINNIPEG R3N 0C7 (204) 488-6398	BRITISH COLUMBIA
COLORADO	LOUISVILLE 40203-2906 (502) 636-5125	ALBANY 12205-5427 (518) 482-3389 BUFFALO 14225-5515 (716) 681-5554 NEW YORK CITY (888) 269-6755 EAST SYRACUSE 13057-1040 (315) 432-0281	MEMPHIS 38115-5946 (901) 363-1075 NASHVILLE 37210-3816 (615) 316-9777 TRI-CITIES 37604-3338 (423) 928-6047	VANCOUVER V3H 3W8 (604) 306-0339
DENVER 80112-5115 (303) 792-2418	LOUISIANA	NORTH CAROLINA	TENNESSEE	MARITIMES
CONNECTICUT	BATON ROUGE 70809-2256 (504) 922-5151 SHREVEPORT 71108-2521 (318) 869-3531	CHARLOTTE 28273-6200 (704) 588-3251 RALEIGH 27604-8456 (919) 231-5855	KNOXVILLE 37923-4506 (423) 693-5513 MEMPHIS 38115-5946 (901) 363-1075 NASHVILLE 37210-3816 (615) 316-9777 TRI-CITIES 37604-3338 (423) 928-6047	NOVA SCOTIA B2X 3N2 (902) 434-2725
NORTH HAVEN 06238 (860) 742-8887	MARYLAND	OHIO	TEXAS	MANITOBA
WASHINGTON DC	BALTIMORE 21045-2565 (410) 720-5232	CINCINNATI 45215-1187 (513) 772-1440 CLEVELAND 44143-1433 (216) 289-4160 COLUMBUS 43221-4073 (614) 488-7913 DAYTON 45439-1254 (937) 299-9506 TOLEDO 43528-9483 (419) 867-7284	CONROE 77304-1524 (409) 588-1116 DALLAS 76051-7602 (817) 329-9353 HOUSTON 77060-3143 (281) 847-9444 SAN ANTONIO 78133-3502 (830) 964-2421	WINNIPEG R3N 0C7 (204) 488-6398
HERNDON, VA 20170-5227 (703) 904-7735	MASSACHUSETTS	ONTARIO	QUEBEC	
FLORIDA	BOSTON 02154-8414 (781) 899-2010	DALLAS 76051-7602 (817) 329-9353 HOUSTON 77060-3143 (281) 847-9444 SAN ANTONIO 78133-3502 (830) 964-2421	MONTREAL J5Y 2G3 (514) 654-3121	
JACKSONVILLE 32259-4396 (904) 287-9595 MIAMI 33014-6719 (305) 556-0142 TAMPA 33619-4480 (770) 475-0955	MICHIGAN			
GEORGIA	DETROIT 48034-4005 (248) 353-9680 FLUSHING 48433-1855 (810) 487-1310 GRAND RAPIDS 49512-3924 (616) 942-8780			
ATLANTA 30076-4914 (770) 475-0955 SAVANNAH 31401-5140 (912) 231-9604	MINNESOTA			
HAWAII	MINNEAPOLIS 55447-5435 (612) 551-1990			
See SEATTLE District Office (206) 575-2456				

LINCOLN INTERNATIONAL HEADQUARTERS

22801 St. Clair Avenue, Cleveland, Ohio 44117-1199 USA
Phone: (216) 481-8100 • Fax: (216) 486-1363 • Website: www.lincolnelectric.com

Contact International Headquarters in Cleveland, Ohio
for Specific Locations of over 120
International Distributors Worldwide



**THE
LINCOLN ELECTRIC
COMPANY**

Local Sales and Service through Global
Subsidiaries and Distributors
Cleveland, Ohio 44117-1199 U.S.A.
TEL: 216.481.8100
FAX: 216.486.1751
WEB SITE: www.lincolnelectric.com

**MIG
C4.200 9/98**