



# SurvivalRing

*Study Yesterday... Prepare Today... Live Tomorrow*

This digital document created and presented by Richard Fleetwood. He is the founder, author, producer, and webmaster of the **SurvivalRing** (<http://www.survivalring.org>) and **Civil Defense Now!** (<http://www.survivalring.org/cd-main.htm>) websites.

SurvivalRing has as its goal the ideal of being the leading source of survival, preparedness, and self reliance information on the Internet. Linkage, assistance, and creation of digital content in areas that until now have only been hinted at or impossible to find, is being added to everyday via the SurvivalRing website and email lists.

Thousands of hours of searching, writing, and communications have been spent collecting over 2 gigabytes of digital content, as well as tens of thousands of pages of hard copy original public domain material in the areas of civil defense, survival, training, and preparedness, from all over the globe.

As much as possible is being put online at his website at  
**<http://www.survivalring.org>**

## Civil Defense Now!

*Part of The SurvivalRing website*

The content of THIS file, while created from PUBLIC DOMAIN material, produced by the U.S. (or other) Government at taxpayer expense, is presented in THIS digital format, produced from the ORIGINAL hardcopy document, for the benefit of all mankind, in hoping to help spread the idea of PREPAREDNESS for any and all threats that may come from either natural, extraterrestrial (space based), or manmade sources.

There are too many situations and incidents that can come to pass in everyday life, that when time is taken to learn and skills obtained, can mean the difference between life and death. Sept. 11, 2001 proved to the world that no matter how safe a person thinks they may be, death and injury can come from the most UN-LIKELY place, at any time. The documents presented in this series of digitized works, can help the average person with the knowledge within, to know how to save those persons closest to them in REAL disaster. Help spread this idea of sharing SURVIVAL INFORMATION.

If you have documents from any era, on any disaster or civil defense area, PLEASE contact Richard at his email address of [RAFLEET@AOL.COM](mailto:RAFLEET@AOL.COM). Check the website for the LATEST additions to the CIVIL DEFENSE NOW online library archive. All data online, and much more, is also available on CD-ROM. Information is available at the website on how to obtain it. Thanks for your support, and enjoy the information contained on the following pages. Share them with those who will learn from them and teach what they know to others.

*Donations of U.S. or other civil defense documents, articles, books, videos, digitized ephemera, patches, tools, photos, or anything of this nature is appreciated, as well as cash gifts or donations to support the website costs and bills. Address information is available on the homepage of Civil Defense Now! (URL located above)*

**- Richard Fleetwood – January 2002 — ALL RIGHTS RESERVED –**

This document may NOT be reproduced commercially on any media WITHOUT EXPRESSLY WRITTEN permission from the creator of this digital presentation. Educational Institutions MAY use this material in any way needed.

**Permission granted to individuals for PERSONAL USE ONLY.**

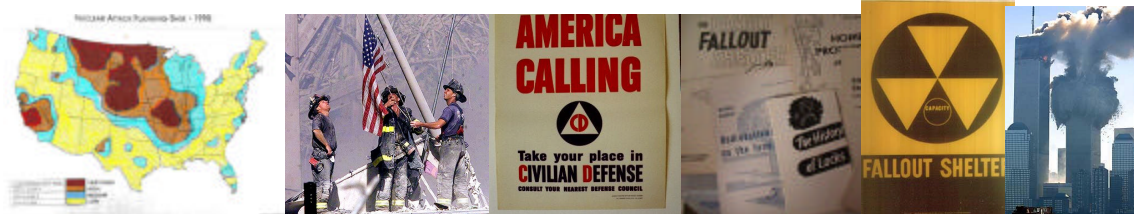



# SHELTERS IN NEW HOMES



Message from the Director of Civil Defense

This technical report, "Shelters in New Homes," presents some very fine examples of relatively low cost solutions to a potential danger, radiation due to fallout.

Since the principal goal of the Civil Defense Program continues to be fallout shelters for the total population wherever they may be - at home, at work, or at school, it is gratifying to me to find the problem of shelter so well stated, and suggested multi-purpose areas in new homes, so well presented.

This report, prepared for the Office of Civil Defense by the National Association of Home Builders Research Foundation, is a planning tool. It provides information to help home builders or owners in planning for protection against fallout radiation.

The members of the NAHB Research Foundation who participated in developing this report have performed a valuable service, for which I extend my appreciation.

We look to the home builders and owners to build upon their efforts by preparing their homes for emergencies we must anticipate but hope will never occur.

A handwritten signature in cursive script that reads "John E. Davis". The signature is written in dark ink and is positioned above the printed name.

John E. Davis  
Director of Civil Defense

# TABLE OF CONTENTS

## SECTION I 5A



### BONUS SHELTERS CAN SELL YOUR HOMES

Multiple-use bonus rooms as a marketing tool. Lists ways to highlight positive marketing features. Illustrates suggested multipurpose areas.

## SECTION II 9A

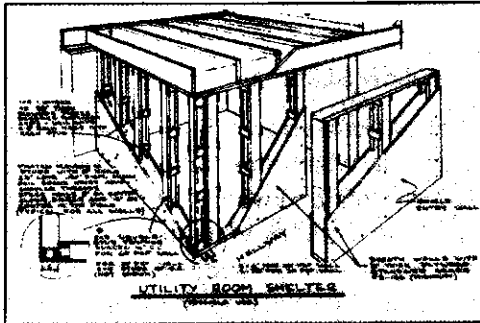

### SHELTER DESIGNS AND DETAILS

Provides design details, materials specifications, shielding mass requirements, and estimated building costs for fallout shelters in houses.

## SECTION III 27A

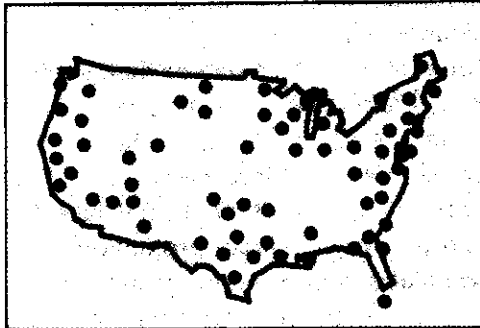

### RADIATION SHIELDING PRINCIPLES

How barriers, geometry, distance, and time are used to achieve effective gamma radiation shielding.

## SECTION IV 31A

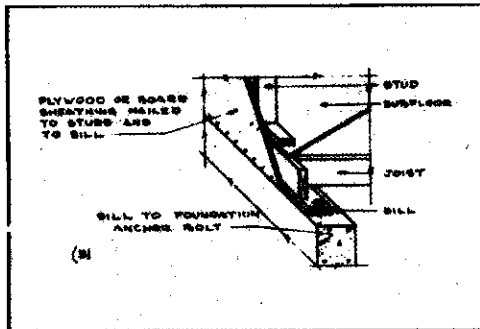

### STORM RESISTANCE DETAILS FOR SHELTER AREAS

Construction details for making shelters more resistant to high-intensity windstorms.

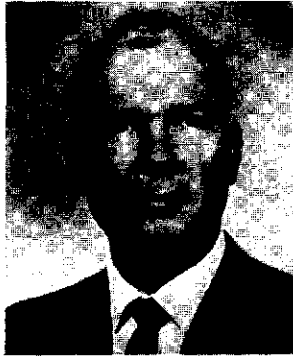

**Fellow Builders:**

The provision of better housing within the reach of all Americans is a matter of urgent concern in which the National Association of Home Builders shares. Toward this end we are continuously trying to improve security, shelter, and livability in the homes we build. Homes being constructed today will be lived in for many years. Therefore, it is important that we build homes today that will fulfill tomorrow's requirements.

This builders manual, prepared by the NAHB Research Foundation, shows how any home builder or owner can provide an area that protects against fallout radiation and windstorm without sacrificing its day-to-day usefulness.

Studies by the Department of Defense of hypothetical nuclear attacks on the United States show that, without proper shelters, millions would die from the effects of fallout radiation. With shelter designs used in this manual, many of these people could survive. At the annual rate that homes are being built, it would not take long to provide millions of people with home fallout protection.

The cost-effective solutions developed by the Research Foundation show how to provide economical areas of livable space that also offer protection from radioactive fallout and windstorm.

A handwritten signature in cursive script that reads "Eugene A. Gullidge". The signature is written in dark ink and is positioned above the printed name and title.

**Eugene A. Gullidge, President**  
**NATIONAL ASSOCIATION OF HOME BUILDERS**

# Bonus Shelters Can Help Sell Your Homes

*A new home represents to most American families a better and more attractive way of life. Ample and useful space and attractive facilities provide every member of the family with enjoyment, comfort, privacy, and security.*

*Today's buyer looks on a new home as something more than just shelter from the elements. He also has a deep concern and interest in security and safety.*

*The purpose of this booklet is to explore with the home builder a number of ways that he may increase the marketability of his homes by offering home buyers a better way of life as well as security without creating consumer resistance.*

## IS THE HOME BUYER INTERESTED IN SECURITY?

As remote as the possibility of nuclear attack may seem to some individuals, a recent survey has shown that most Americans are receptive to the idea of a home fallout shelter.

When this desire for security is combined with the idea of a "bonus area" or multipurpose room, the concept becomes even more acceptable.

In addition, most parts of the Nation suffer, more or less frequently, from heavy storms, hurricanes, and tornadoes, and most Americans are extremely conscious of the weather.

The builder who can offer a home environment that combines enjoyable living and security has added to the saleability of his product. Americans are value conscious—they want more for their money. A multipurpose room or area can give them a bonus.

The bonus can be a photographic darkroom, a sauna bath, a sound-conditioned room or shop, a utility area, laundry or sewing room, study area, playroom, in fact, any multipurpose room.

## HOW TO MARKET THE CONCEPT OF A BONUS FALLOUT SHELTER

The concept can be marketed as a reasonable approach to meeting family needs and not from a "fear" standpoint. Most Americans are aware that it is possible to provide protection

against radiation from fallout. When they find that the builder can provide this protection in the form of an attractive, useful area that is desirable in itself—and at reasonable cost—they will be receptive to the concept.

The builder need not involve himself in the details of shelter living since there are several publications dealing with this subject. Nor need he engage in an extensive discussion of the subject of nuclear warfare.

The concept should be marketed as an optional attraction available to those who appreciate and are receptive to the values made evident by the builder.

If the prospect indicates that he is sensitive about the subject, it need not be pressed beyond the explanation that the builder is one who believes in offering as much as possible to the buyer.

Salesmen should be alerted to the marketing values of the concept when presented in a positive way. Their explanation of the options available to the prospect should include the bonus shelter concept. If the prospect indicates interest and receptivity, the subject can be discussed as fully as the prospect desires.

## WHAT MARKETING EXPERTS SAY ABOUT THE CONCEPT

It is the opinion of nationally recognized new-home marketing experts that the bonus shelter concept can be

a marketing advantage. A well-known marketing consultant says: "The trend today is for the prospect to shop for the most he can get in usable space and amenities in an attractive environment. Anything that enhances the livability and security of the new home adds to its marketability. The builder who will make the effort to use this concept effectively will find that it helps sell homes." (See back cover for builders' views on this concept.)

## CONSTRUCTION PRESENTS NO PROBLEMS

Providing fallout shelter in the form of a bonus room or area does not present any construction problems to the experienced builder. Most home designs can incorporate the concept without difficulty and at reasonably low cost.

Essentially all that is required is increased mass and strength in a limited area. The cost for this is surprisingly low. For example, building the required mass into a basement corner shelter of a large, two-story home (see design 1, page 10A) would require an interior wall mass of 30 pounds per square foot with an added cost per square foot of \$0.18. Ceiling mass in this case would be 70 pounds per square foot at \$0.67 per square foot added cost. Therefore, an 8- by 12-foot wall would cost \$17.28 more, and the 10- by 12-foot ceiling would cost an extra \$80. Estimated direct material and labor cost for including a shelter in this new home would be about \$100.

## EXAMPLES OF MULTI-PURPOSE AREAS

### SAUNA BATH

**SAUNA** is a modern version of the ancient Finnish bath. It provides a healthy, relaxing atmosphere for the entire family.

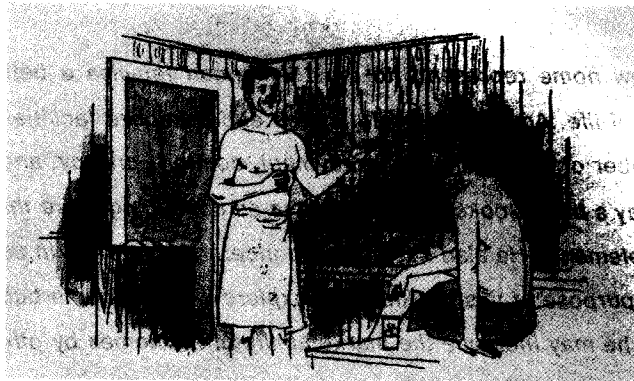

### WINE CELLAR

The wine cellar is a place where wine—the only beverage that improves with age in the bottle—may be stored safely and conveniently.

But it's more. It could be the start of a hobby where you collect and compare, and perhaps, do a little tacit boasting—a marvelous conversation piece.



### GAME ROOM

**GAME ROOMS** are becoming more important to the family and for company too. They can be a place for listening to or playing music on the piano, drums, ukelele or guitar. Or, how about games? What a fine place for table tennis or billiards, darts, cards—you name it.

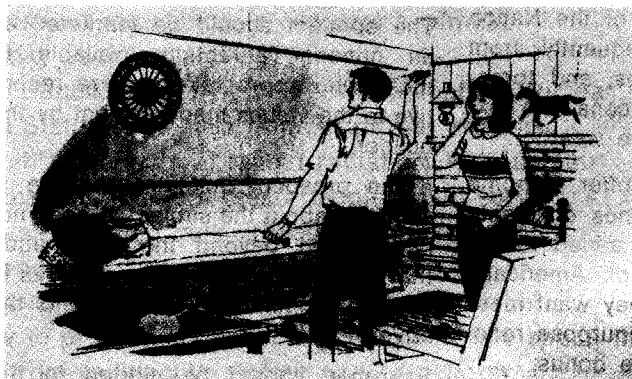

### STUDY

Educators advise that students need a room where they can retreat and concentrate on their work. This **STUDY** could have shelves for school books, dictionaries, encyclopedias, and other reference works—a boon to people of all ages.

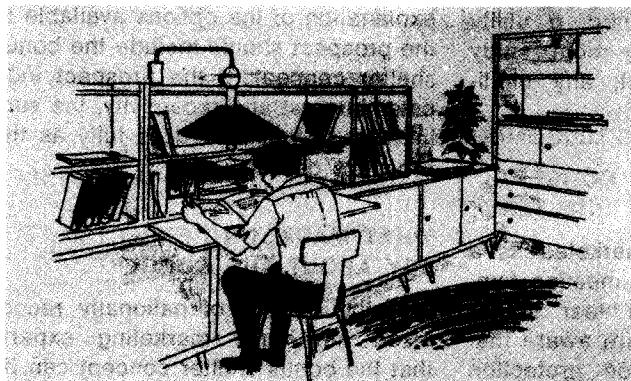



### RAINY DAY ROOM

The RAINY DAY ROOM is a place where children can play with their trains, dolls, blocks, jigsaw puzzles, and the like. With a sofa, chairs, and maybe a couple of blankets, they can make a tent or a playhouse—it's their room.



### HOME OFFICE

The lady of the house does a lot of office work. She could use a room for her desk and filing cabinet, and she needs a place to keep bills, records, and her social and work calendar.



### GUEST ROOM

A room that is cozy, comfortable, and furnished to your liking can be converted to a GUEST ROOM when company comes.



### UTILITY ROOM

A UTILITY ROOM or center is a place where Mrs. Housewife does so many important jobs and where she stores soaps, cleansers, polishes, detergents, brooms, etc. It can be a happy space, too, where she can iron and watch T.V.



## STORAGE ROOM

A room where tools, equipment, supplies, toys, and bikes can be STORED is a welcome addition to any home.



## MUSIC ROOM OR DEN

A MUSIC ROOM OR DEN is a desirable addition to any home. There, one can retreat to read, write, or just relax and think. And what a place for the budding musician to practice while keeping family and neighbors complaints down.



## PHOTOGRAPHIC DARK ROOM

A DARK ROOM is an ideal space where the avid photographer can develop his own films, make prints and enlargements. Here, the hobbyist can experiment and create special photographic effects. He has a place to store camera equipment, films, and photographic supplies.



Typical fallout shelter designs for use in residential construction are outlined in this section. Suggestions are made on how to select the proper shelter design for a particular house style.

Proper shelter designs are related to the following:

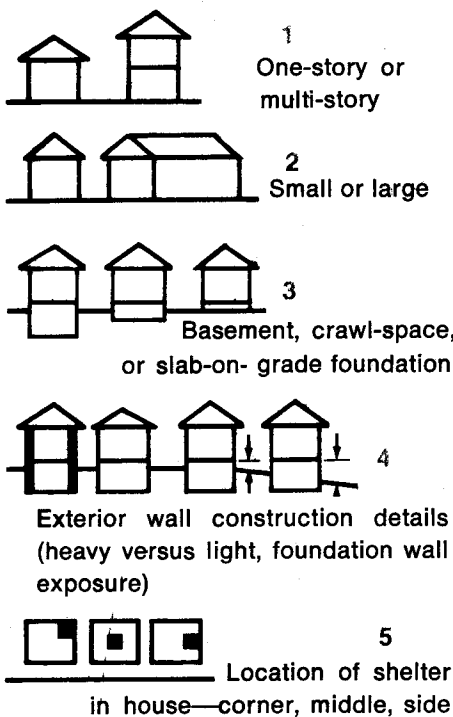

A builder should decide which of the above first four items best describe the house in which he wants to build a shelter. Next, look through the shelter designs to find those suitable for the house for which a shelter is being provided. Then use that design as a guide.

Mass—weight in pounds per square foot (PSF)—of fallout shelter walls and ceiling depends on the above categories. Recommended wall and ceiling masses for a specific design can be selected from the shelter design table on page 26A. Examples from the table follow:

1. Assume a small (under 1600 square feet), one-story house with a base-

ment has foundation walls of 8-inch-thick hollow concrete block and that not more than 2 feet of the foundation wall is above grade. A basement corner fallout shelter requires an overhead mass of 100 PSF. The two inside walls must have a mass of 30 PSF. Footnote 2 on page 26A indicates an additional wall mass of 30 PSF is necessary along the basement exterior walls.

2. Assume a large (over 1600 square feet per floor), one-story wood-frame house with siding has 8-inch-thick cast-in-place concrete crawl-space foundation walls. The design table on page 26A assumes crawl-space foundation wall exposures do not exceed 3 feet. A fallout shelter in the middle of this house requires an overhead mass of 123 PSF, and its four walls must have a mass of 140 PSF.

3. Assume a large (over 900 square feet per floor), two-story house on a concrete slab has masonry block exterior walls covered with brick veneer. A shelter along one side of the house requires an overhead mass of 110 PSF. Its three interior walls need a mass of 130 PSF. Footnote 6 of the table shown with 130 PSF indicates that the outside wall of the shelter must have a minimum mass of 150 PSF (see page 26A).

These examples illustrate uses of the design table to arrive at required wall and ceiling masses in fallout shelters to provide minimum recommended protection from radioactive fallout.

Design suggestions include shelters under garages, porches, and patios and in houses with basement, crawl-space, and slab-on-grade foundations. In addition, all ceilings have been structurally designed to withstand a modest, inward-acting over-pressure caused by blast and windstorm loads.

Principles to obtain more effective

fallout radiation shielding are outlined in Section III, "Radiation Shielding Principles," and construction details that will improve the storm resistance of shelters in homes are shown in Section IV, "Storm Resistance Details."

Corner shelter designs for houses with slab-on-grade or crawl-space foundations are not used because shelters at the side or middle of such houses are more cost-effective. Above-grade corner shelters require wall and ceiling masses weighing 150 PSF. In addition, these corner shelters cost more because shelter ceilings must extend to the center of the house in both directions.

Fallout shelter areas need no special electrical, heating, or plumbing equipment but should be equipped for their normal uses.

The Office of Civil Defense, Department of Defense, Washington, D.C. 20310, will answer questions concerning proper construction of shelters. On request, it will furnish a list of specially-trained architects and engineers qualified in fallout shelter design.

Actual shelter construction cost will vary depending on local wage rates and material prices. Estimated shelter construction costs given in the design section provide an idea of comparative costs required to build a shelter with a PF of 40 (see Section III).

Providing a shelter in a home to be built may cost less than expected. To obtain the added cost for building a fallout shelter, subtract the cost of building a conventional room from that of constructing a fallout shelter in the same area. The cost difference of replacing an interior wood frame wall with one of concrete block to obtain a 30-PSF shelter is: \$0.60/SF Shelter wall cost minus \$0.42/SF Conventional wall cost = \$0.18/SF Added wall cost (see Design #1, page 10A).

# 1. BASEMENT | 2 STORY | LARGE | CORNER

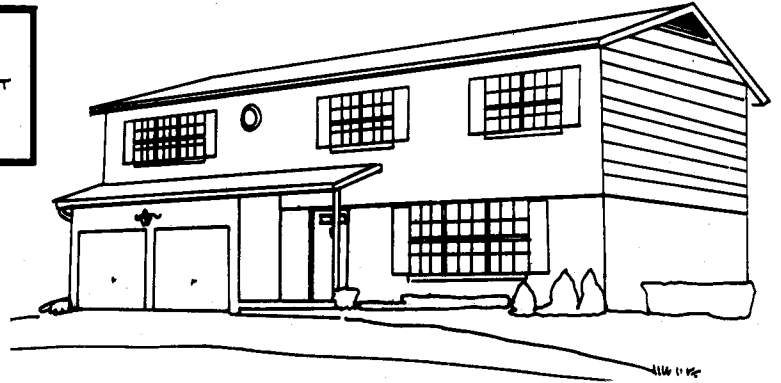
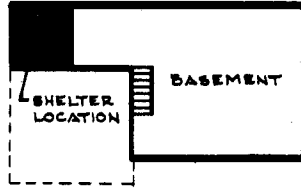
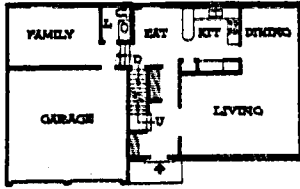

Two-story homes with basements have special radiation protection design advantages over many other types of homes. Radioactive fallout on the roof is farther from the basement shelter, and the house provides more overhead protective mass than other types. Fallout shelter space in this house could serve as a sauna bath, hobby room, laundry room, workshop, or storage area.

This design shows how mass can be added between conventional joists to obtain a protection factor (PF) of 40. The design table on page 26A indicates a corner shelter in this house requires the following masses:

Foundation Wall Exposure	Wall Mass Required PSF	Ceiling Mass Required PSF
2 ft or less (lightweight wall such as hollow masonry block)	30	70
2 to 4 ft (lightweight wall such as hollow masonry block)	60	90
2 ft or less (heavyweight wall such as cast-in-place concrete)	None	70
2 to 4 ft (heavyweight wall such as cast-in-place concrete)	30	80

Other wall and ceiling constructions that might be used for this type of shelter design are shown on pages 11A, 12A, 13A, 16A, 17A, 19A, and 20A. It would be necessary to revise those designs for the appropriate wall and ceiling masses.

ESTIMATED DIRECT CONSTRUCTION COSTS PER SQUARE FOOT OF CEILING OR WALLS FOR SHELTER (1)

	Mass PSF	Total with Shelter	Conventional Construction	Cost For Adding Shelter
Ceiling	70	\$1.12	\$.45	\$.67
	80	1.22	.45	.77
	90	1.31	.45	.86
Walls	30	.60	.42	.18
	60	.90	.42	.48

(1) See page 9A for explanation

## 1. WORKSHOP SHELTER possible use

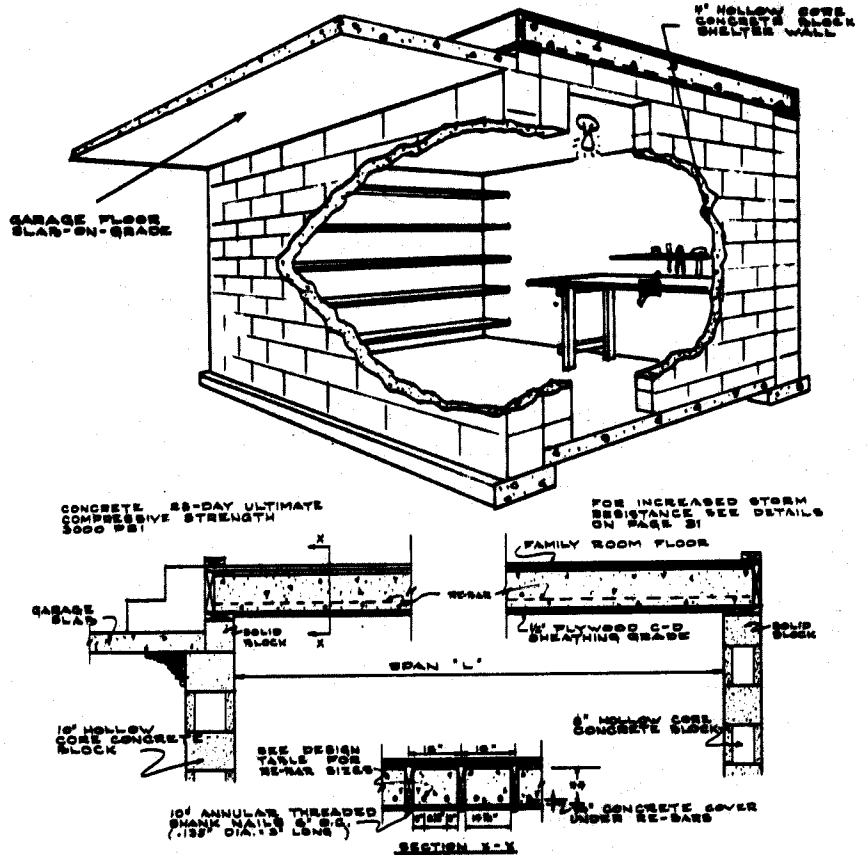

### CEILING CONSTRUCTION DETAILS

SPAN 'L' IN FEET	70 PSF	80 PSF	90 PSF
6	#3	#3	#3
8	#4	#4	#4
10	#5	#5	#5
12	#6	#6	#6
14	#7	#6	#6

SPAN 'L' IN FEET	CEILING MASS IN PSF		
	70	80	90
6	2x6	2x6	2x6
8	2x6	2x6	2x6
10	2x6	2x6	2x6
12	2x10	2x10	2x10
14	2x10	2x12	2x12

\*\* 70 PSF REQUIRES 6" THICK CONCRETE \* USE LUMBER WITH MINIMUM ALLOWABLE BENDING STRESS OF 1200 PSI  
 \*\* 80 PSF REQUIRES 6 1/2" THICK CONCRETE  
 \*\* 90 PSF REQUIRES 7" THICK CONCRETE

## 2. BASEMENT | 1 STORY | LARGE | CORNER

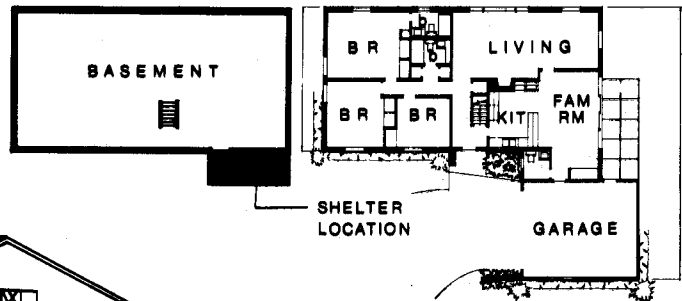
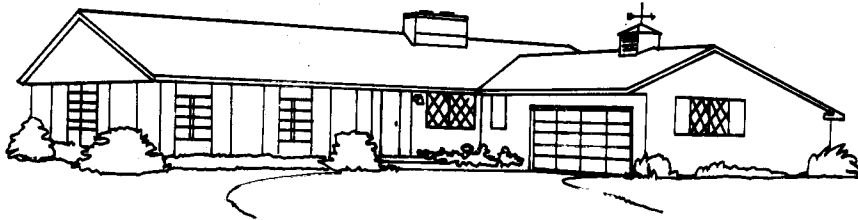

### 2. PHOTOGRAPHIC DARKROOM possible use

This design provides a fallout shelter that can be used as a photographic darkroom, a sound-conditioned workshop, an office, or a wine cellar.

Details illustrate how cost-effective fallout shelter space can be constructed while the new home is being built. The design table on page 26A indicates that a basement fallout shelter in a small one-story home requires partitions having a wall mass of 30 or 60 pounds per square foot (PSF). Overhead mass required depends on the height above grade and mass of the exterior foundation wall. The table below summarizes four typical conditions.

Foundation Wall Exposure	Wall Mass Required PSF	Ceiling Mass Required PSF
2 ft or less (lightweight wall such as hollow masonry block)	30	125
2 to 4 ft (lightweight wall such as hollow masonry block)	60	125
2 ft or less (heavyweight wall such as cast-in-place concrete)	30	80
2 to 4 ft (heavyweight wall such as cast-in-place concrete)	30	105

Other wall and ceiling constructions that might be used for this type of shelter design are shown on pages 10A, 12A, 13A, 16A, 17A, 19A, and 20A. It would be necessary to revise those designs for the appropriate wall and ceiling masses.

### ESTIMATED DIRECT CONSTRUCTION COSTS PER SQUARE FOOT OF CEILING OR WALLS FOR SHELTER (1)

	Mass PSF	Total with Shelter	Conventional Construction	Cost For Adding Shelter
Ceiling	80	\$ .98	\$.45	\$.53
	105	1.17	.45	.72
	125	1.34	.45	.89
Wall	30	.60	.42	.18
	60	.90	.42	.48

(1) See page 9A for explanation

CONCRETE 28-DAY ULTIMATE COMPRESSIVE STRENGTH OF 3000 PSI

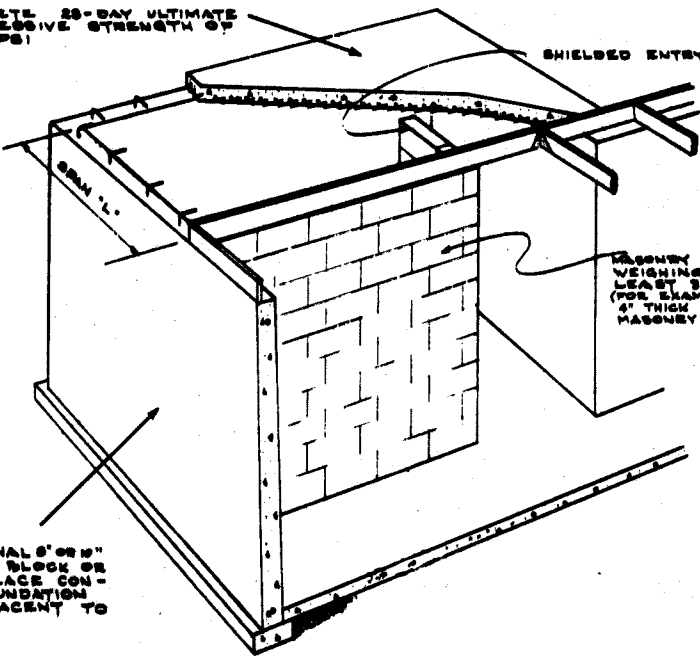

CONVENTIONAL 8" OR 10" CONCRETE BLOCK OR CAST-IN-PLACE CONCRETE FOUNDATION WALL ADJACENT TO SHELTER

MASONRY BLOCK WEIGHING AT LEAST 30 PSF (FOR EXAMPLE 4" THICK SOLID MASONRY BLOCK)

3/8" REINFORCING BARS FOR TEMPERATURE STEEL PLACED ABOVE MAIN REINFORCING

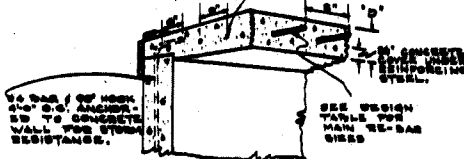

CAST-IN-PLACE CONCRETE WALL

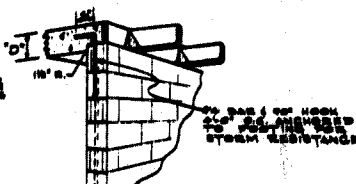

MASONRY BLOCK WALL

### SHELTER CEILING DETAILS

CEILING MASS	SLAB DEPTH 'D'
80 PSF	6 1/2"
100 PSF	8"
105 PSF	8 1/2"
122 PSF	9 1/2"

SPAN 'L' IN FEET	REINFORCING BAR SIZE TO USE ON 6 INCH O.C. BRACING
6	#3
8	#3
10	#4
12	#5
14	#5

### 3. BASEMENT | 1 STORY | SMALL | SIDE

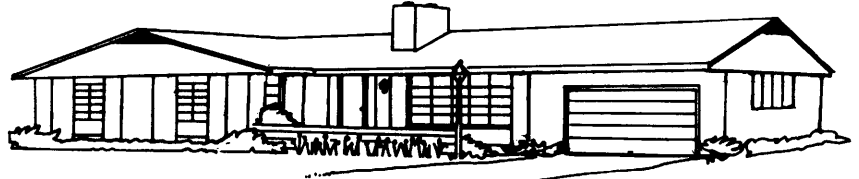

This design shows solid concrete masonry blocks laid in both spaces between ceiling joists and wall studs. The fireplace foundation provides substantial shielding along one side of the shelter. Design that takes advantage of normally massive structures such as fireplace foundations makes the addition of fallout shelter space economically feasible.

The design table on page 26A indicates that a side shelter for this house type requires the following wall and ceiling masses:

Foundation Wall Exposure	Wall Mass Required PSF	Ceiling Mass Required PSF
2 ft or less (lightweight wall such as hollow masonry block)	60	80
2 to 4 ft (lightweight wall such as hollow masonry block)	60	122
2 ft or less (heavyweight wall such as cast-in-place concrete)	30	95
2 to 4 ft (heavyweight wall such as cast-in-place concrete)	30	120

Other acceptable wall and ceiling constructions that might be used for this type of shelter design are shown on pages 10A, 11A, 13A, 16A, 17A, 19A, and 20A. It would be necessary to revise those designs for the appropriate wall and ceiling masses.

#### ESTIMATED DIRECT CONSTRUCTION COSTS PER SQUARE FOOT OF CEILING OR WALLS FOR SHELTER (1)

	Mass PSF	Total with Shelter	For Conventional Construction	Cost For Adding Shelter
Ceiling	80	\$ .98	\$ .45	\$ .53
	95	.98	.45	.53
	120	1.03	.45	.58
	122	1.03	.45	.58
Walls	30	.73	.42	.31
	60	1.03	.42	.61

(1) See page 9A for explanation

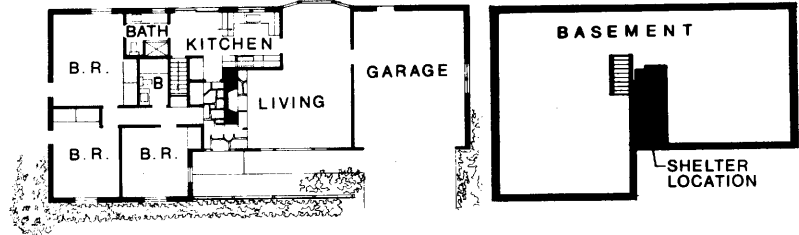

### 3. MUSIC PRACTICE ROOM possible use

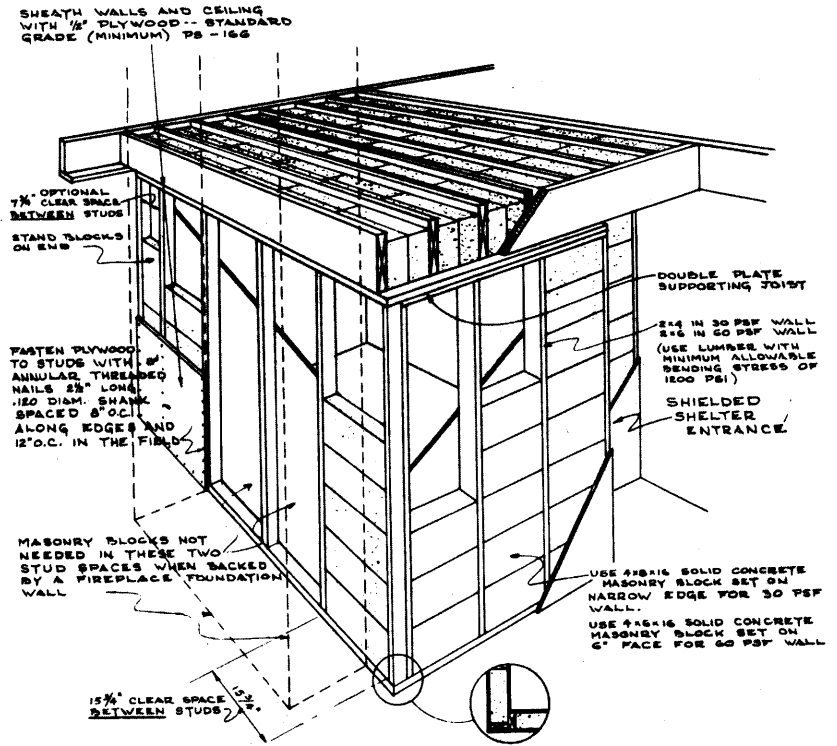

SEE PAGE 31 FOR METHODS OF PROVIDING STORM RESISTANCE ANCHORAGE  
SOLID CONCRETE MASONRY BLOCKS SET ON NARROW FACE  
USE 4-#6-16 FOR OVERHEAD MASS UP TO 122 PSF.

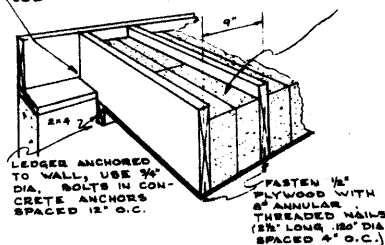

#### FOUNDATION WALL AND CEILING DETAILS

USE JOISTS SPACED A MAXIMUM OF 9" O.C. WITH MINIMUM ALLOWABLE BENDING STRESS OF 1200 PSI

SPAN	JOIST SIZE
6'	2 x 10
8'	2 x 10
10'	2 x 12
12'	2 x 12

# 4. BASEMENT | 2 STORY | LARGE | MIDDLE

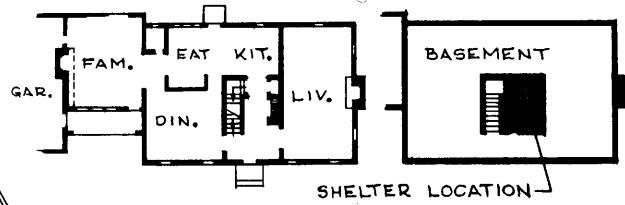

## 4. SOUND-CONDITIONED PLAYROOM possible use

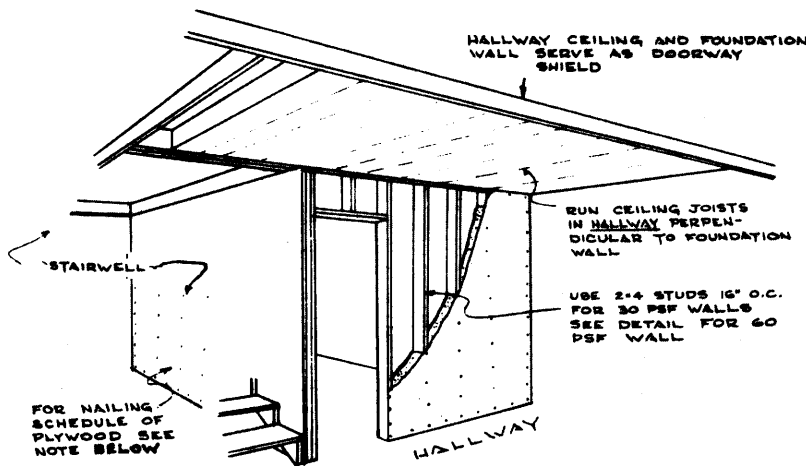

SHELTER WALL & CEILING DETAILS

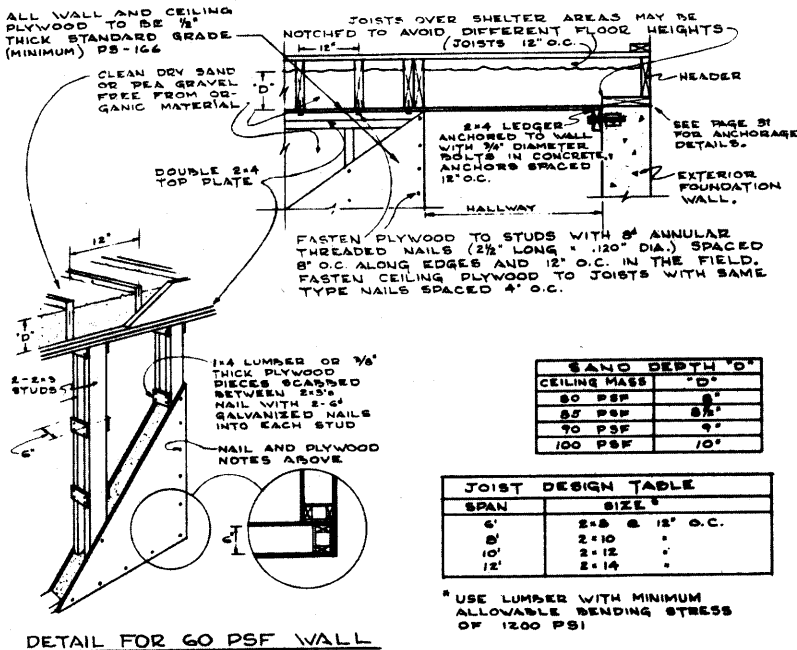

SAND DEPTH	CEILING MASS
0"	5'
5"	8 1/2'
10"	9'
100 PSF	10'

JOIST DESIGN TABLE	
SPAN	SIZE*
6'	2x6 @ 12' O.C.
8'	2x10 "
10'	2x12 "
12'	2x14 "

\* USE LUMBER WITH MINIMUM ALLOWABLE BENDING STRESS OF 1200 PSI

A centrally-located basement room can be used for practicing or listening to music, to keep noises from the rest of the house, or to mend and sew, in addition to doubling as a fallout and storm shelter.

Conventional wood framing techniques can be used for partition walls and ceiling. To add shielding mass, fill spaces between framing members with sand or gravel. To maintain a protection factor (PF) of 40, radiation from fallout particles on the roof is shielded from the doorway by extending the ceiling with heavy mass beyond the doorway. Wall and ceiling masses for different exterior wall foundations follow:

Foundation Wall Exposure	Wall Mass Required PSF	Ceiling Mass Required PSF
2 ft or less (lightweight wall such as hollow masonry block)	30	90
2 to 4 ft (lightweight wall such as hollow masonry block)	60	100
2 ft or less (heavyweight wall such as cast-in-place concrete)	None	80
2 to 4 ft (heavyweight wall such as cast-in-place concrete)	30	85

Other wall and ceiling constructions that might be used for this type of shelter design are shown on pages 10A, 11A, 12A, 16A, 17A, 19A, and 20A. It would be necessary to revise those designs for the appropriate wall and ceiling masses.

### ESTIMATED DIRECT CONSTRUCTION COSTS PER SQUARE FOOT OF CEILING OR WALLS FOR SHELTER (1)

	Mass PSF	Total with Shelter	For Conventional Construction	Cost For Adding Shelter
Ceiling	80	\$1.06	\$.45	\$.61
	85	1.07	.45	.62
	90	1.08	.45	.63
	100	1.19	.45	.74
Walls	30	.60	.42	.18
	60	.90	.42	.48

(1) See page 9A for explanation

# 5. SHELTER UNDER GARAGE OR CARPORT

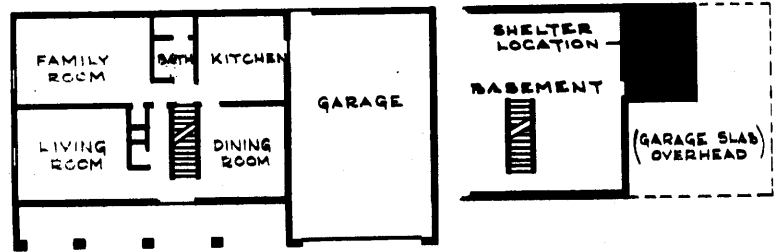
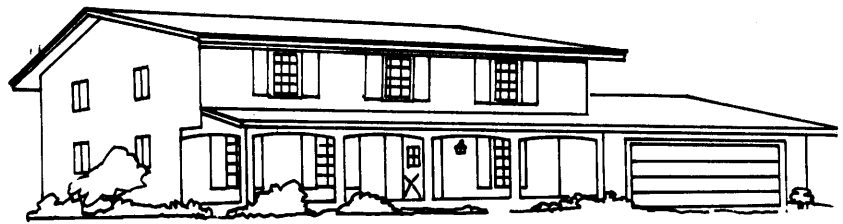

Much usable living space can be gained by building a room under garage or carport concrete floor slab. Construction work to be added includes extending foundation walls an additional 4 feet. The garage or carport floor slab will have to be thicker and more reinforcing steel must be used than is normally required. This is about the only cost increase required to provide fallout shelter protection to a room useful for tool storage, a hobby shop, a workshop, a sauna bath, or a wine cellar.

A shielded entrance can be provided from an adjoining basement or from the garage above. Garages adjacent to houses with concrete slab floor or crawl-space foundation can be provided with a bulkhead-type entrance (see page 21A). Small windows and a standard interior door entrance will provide sufficient natural ventilation to make the room comfortable and usable for almost any application desired.

The under-the-garage or carport-type fallout shelter makes an excellent windstorm shelter. Rural families might find this room would serve as a root cellar for storing vegetables and fruits and also for keeping frozen foods in a freezer.

ESTIMATED DIRECT CONSTRUCTION COSTS PER SQUARE FOOT (1) OF CEILING, WALLS, AND FLOOR FOR SHELTER (2)

	Mass PSF	Total with Shelter	For Conventional Construction	Cost For Adding Shelter
Ceiling	100	\$1.14	\$.55	\$.59
Walls	30	.60	.42	.18
Excavation	—	1.00/CY	—	1.00/CY
Floor	—	.40	—	.40

(1) Except as otherwise noted  
 (2) See page 9A for explanation

## 5. HOBBYSHOP SHELTER UNDER GARAGE OR CARPORT possible use

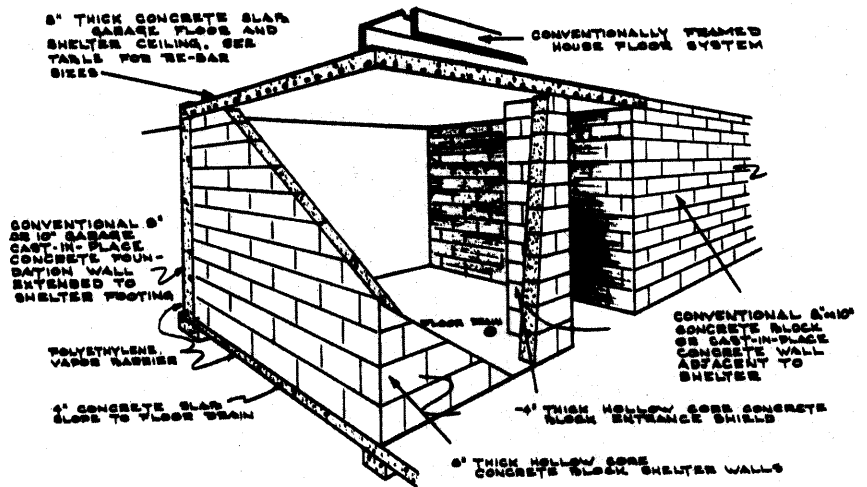

GARAGE FLOOR CONSTRUCTION DETAILS

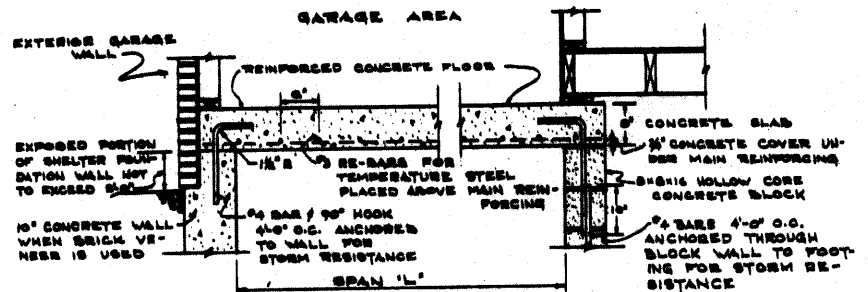

NOTE  
 CONCRETE 28-DAY ULTIMATE COMPRESSIVE STRENGTH OF 3000 PSI  
 1/4\"/>

SPAN 'L'	REINFORCING BAR SIZE TO USE IN FEET OR 6-INCH O.C. SPACING
10	#4
12	#5
14	#6

# 6. BASEMENT | 2 STORY | LARGE | UNDER PORCH SLAB

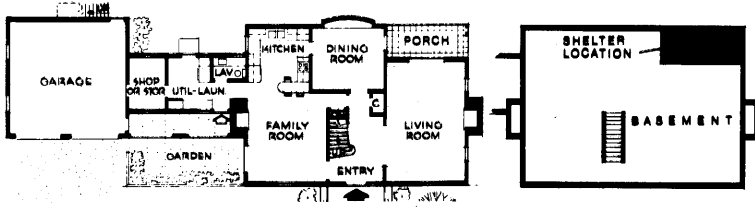

## 6. STUDY UNDER DEN OR PORCH possible use

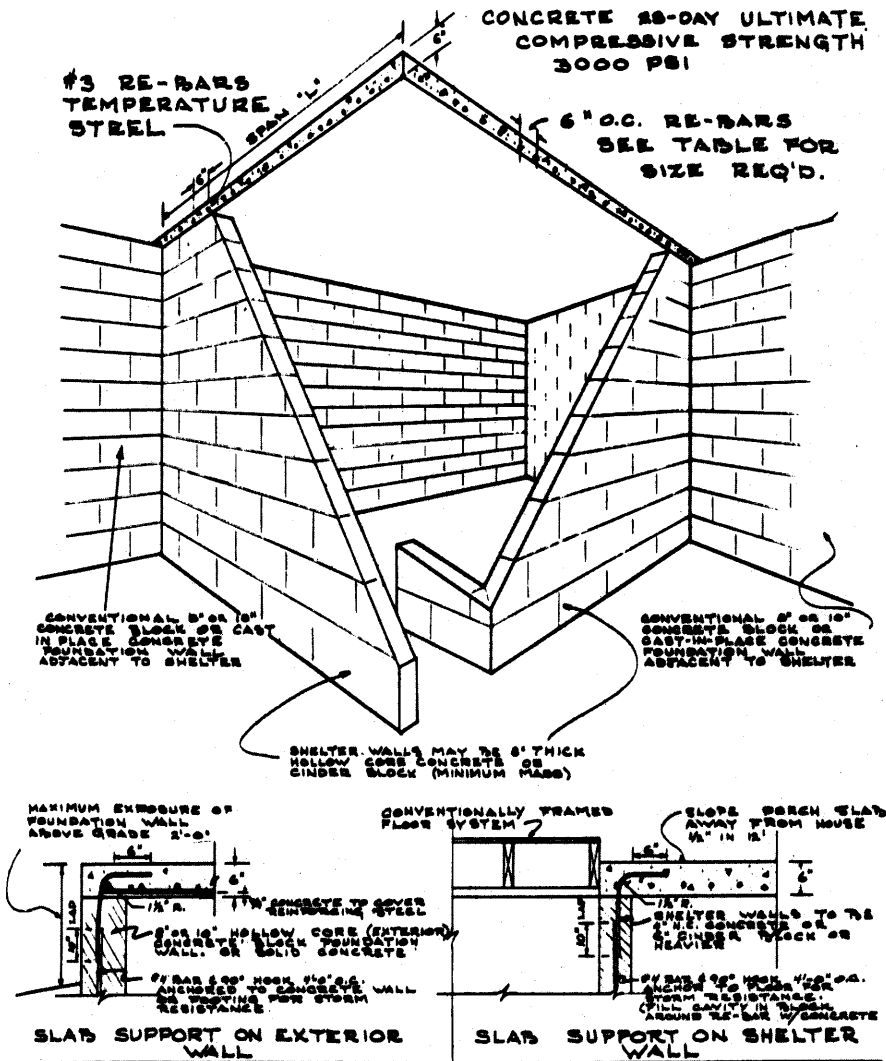

A room under a porch adds usable space at low cost. To provide PF 40, the porch slab should be at least 6 inches thick and rest on 8-inch-thick hollow masonry block or cast-in-place concrete walls.

Brick or stone planters and concrete steps adjacent to porch sides tend to increase the PF of the shelter.

Load-bearing walls supporting the slab at both ends should be selected on the basis that the cumulative floor load may be 250 pounds per square foot to resist reasonable storm and blast pressures.

A concrete slab design can be utilized under the entry of the house. Flagstone or resilient tile over the slab provides an attractive entrance floor for all-weather traffic.

This fallout shelter costs little extra to include in new homes. It provides space for normal living, and construction details vary only slightly from conventional practices.

ESTIMATED DIRECT CONSTRUCTION COSTS PER SQUARE FOOT OF CEILING OR WALLS FOR SHELTER (1)

	Mass	Total with Shelter	For Conventional Construction	Cost For Adding Shelter
Ceiling	75	\$. 93	\$. 45	\$. 48
Walls	30	.60	.42	.18

(1) see page 9A for explanation

SPAN	REINFORCING STEEL REQUIRED
8'	3#3 DEFORMED BAR
10'	4#3 DEFORMED BAR
12'	5#3 DEFORMED BAR



# 7. BASEMENT | 1 STORY | SMALL | SIDE

A cost-effective fallout shelter combined with a utility room adjacent to the basement wall can be incorporated in this hillside home.

One method of cost-effective construction to obtain required shielding mass is the use of dry sand or pea gravel in the wall and floor cavities between 1/2-inch-thick plywood facings. It is extremely important that structural framing, supporting posts, beams, and fastenings be adequate for the increased dead load of the sand or gravel.

It is suggested that the utility room partition be set up before the overhead floor is installed. To do this, temporarily install the top plate and plywood facings that will hold the studs in place (do not nail through the plywood into the top plate at this time). Remove the top plate, fill the wall cavities, and then permanently install the top plate. The design table on page 26A indicates the following masses would be required for a side shelter in the basement:

Foundation Wall Exposure	Wall Mass Required PSF	Ceiling Mass Required PSF
2 ft or less (lightweight wall such as hollow masonry block)	60	80
2 to 4 ft (lightweight wall such as hollow masonry block)	60	122
2 ft or less (heavyweight wall such as cast-in-place concrete)	30	95
2 to 4 ft (heavyweight wall such as cast-in-place concrete)	30	120

ESTIMATED DIRECT CONSTRUCTION COSTS PER SQUARE FOOT OF CEILING OR WALLS FOR SHELTER (1)

	Mass PSF	Total with Shelter	Conventional Construction	Cost For Adding Shelter
Ceiling	80	\$1.06	\$.45	\$.61
	95	1.16	.45	.71
	120	1.32	.45	.87
	122	1.34	.45	.89
Walls	30	.60	.42	.18
	60	.90	.42	.48

(1) See page 9A for explanation

Other wall and ceiling constructions that might be used for this type of shelter are shown on pages 10A, 11A, 12A, 13A, 17A, 19A, and 20A. It would be necessary to revise those designs for the appropriate wall and ceiling masses.

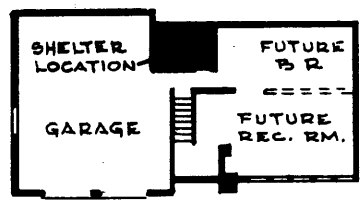
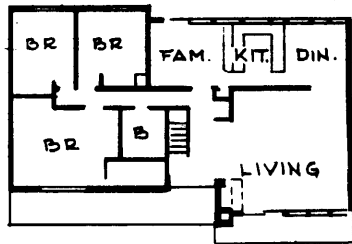
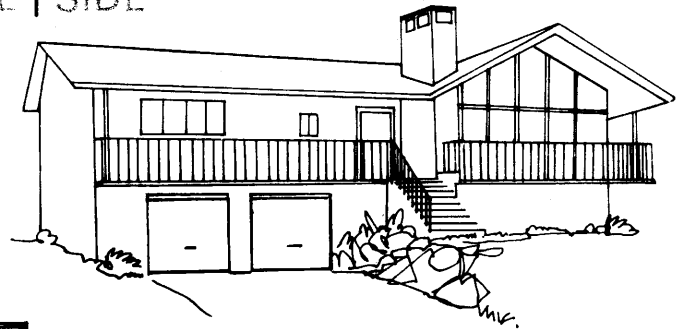

## 7. UTILITY ROOM SHELTER possible use

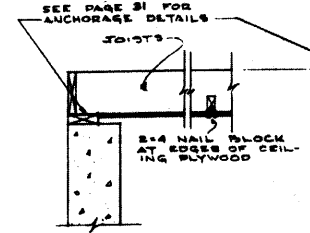
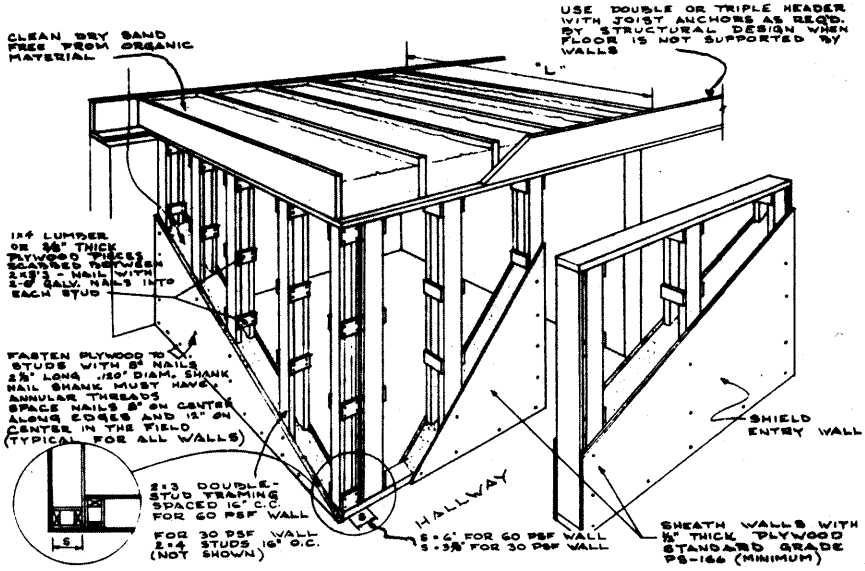

DETAIL FOR UNNOTCHED JOIST

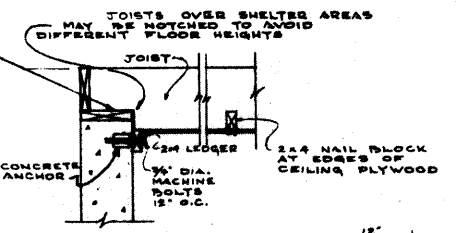

DETAIL FOR NOTCHED JOIST

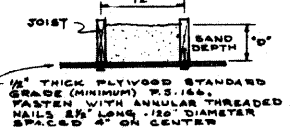

CEILING DETAILS

SAND DEPTH "D"	CEILING MASS "C"
6"	80 PSF
9"	95 PSF
12"	120 PSF
12 1/2"	122 PSF

JOIST DESIGN TABLE

SPAN "L"	SIZE "
6'	2x8
8'	2x10
10'	2x12
12'	2x14

\* USE LUMBER WITH MINIMUM ALLOWABLE BENDING STRESS OF 1500 PSI

# 8. BASEMENT | 1 STORY | SMALL | CORNER

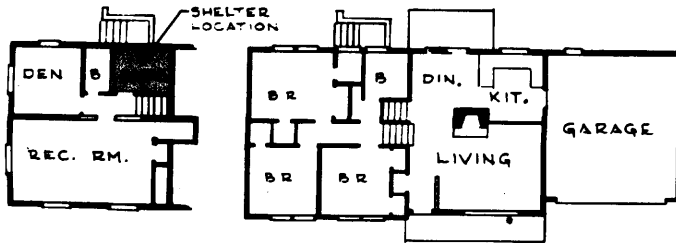
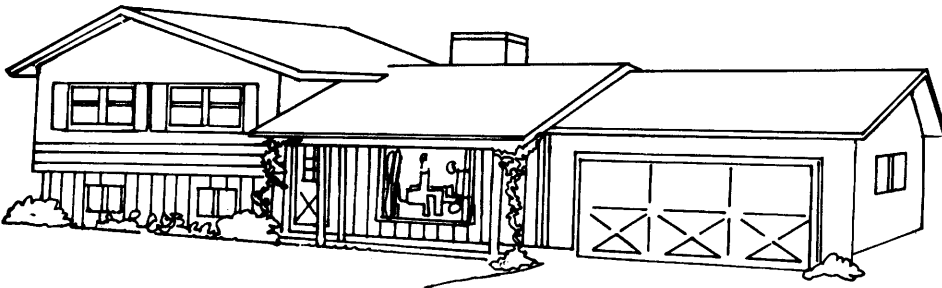

## 8. LAUNDRY-BATHROOM possible use

Many combinations of building materials are possible for building rooms to protect against fallout radiation. This design shows a cost-effective combination of walls using solid concrete masonry block and a ceiling with sand-filled joist spaces. The heavier mass around the bathroom and laundry room absorbs some noises generated in these rooms, helping to keep the rest of the house more quiet. Other suggested uses of such a quiet room would be a child's play area, a guest room, and a musical instrument practice room.

Overhead shielding in the hallway blocks radiation coming from the roof area that would otherwise enter the doors of the shelter rooms.

The shelter design table on page 26A indicates the following interior wall and overhead ceiling mass required for this example:

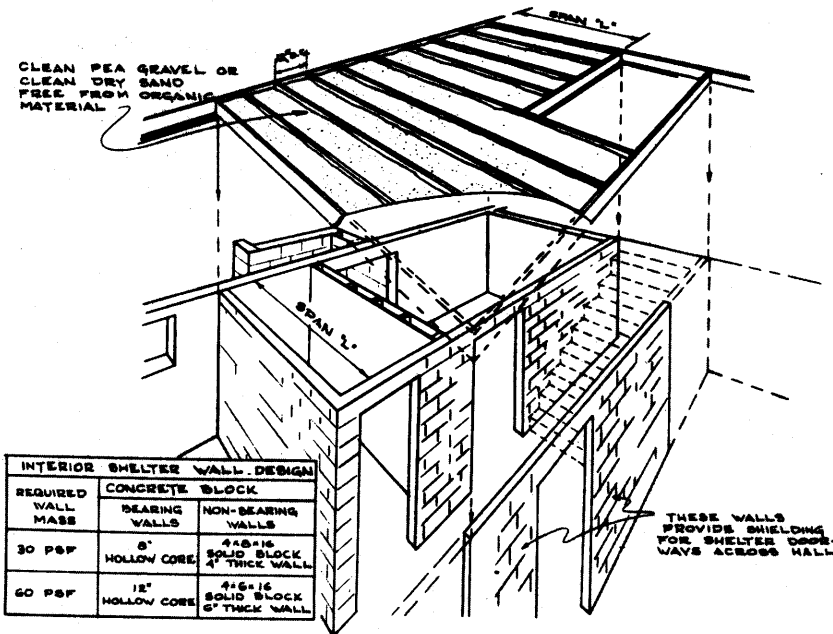

REQUIRED WALL MASS	BEARING WALLS	NON-BEARING WALLS
30 PSF	8" HOLLOW CORE	4#x16 SOLID BLOCK 4" THICK WALL
60 PSF	12" HOLLOW CORE	4#x16 SOLID BLOCK 6" THICK WALL

SPAN L'	SIZE "
6'	2 x 8
8'	2 x 10
10'	2 x 12
12'	2 x 14

USE LUMBER WITH MINIMUM ALLOWABLE BENDING STRESS OF 1200 PSI. JOIST DEPTH SHOULD BE SUFFICIENT TO ACCOMMODATE DIMENSION 'D'.

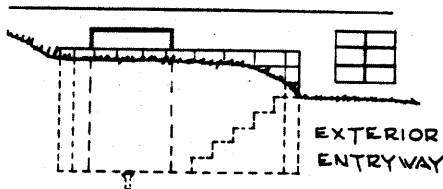

JOISTS OVER SHELTER MAY BE NOTCHED TO AVOID DIFFERENT FLOOR HEIGHTS

CEILING PLYWOOD TO BE 5/8" THICK STANDARD GRADE (MINIMUM) PS-166 FASTEN PLYWOOD TO JOISTS WITH 2" ANNULAR THREADED NAILS 4" O.C.

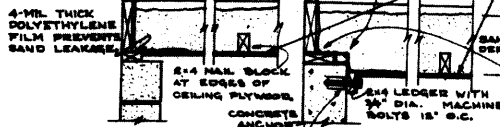

DETAIL FOR UNNOTCHED JOIST

DETAIL FOR NOTCHED JOIST

CEILING MASS PSF	'D'
30 PSF	8"
100 PSF	10"
105 PSF	10 1/2"
122 PSF	12 1/2"

FOR INCREASED STORM RESISTANCE SEE PAGE 28 FOR ANCHORAGE DETAILS

Foundation Wall Exposure	Wall Mass Required PSF	Ceiling Mass Required PSF
2 ft or less (lightweight wall such as hollow masonry block)	30	100
2 to 4 ft (lightweight wall such as hollow masonry block)	60	122
2 ft or less (heavyweight wall such as cast-in-place concrete)	30	80
2 to 4 ft (heavyweight wall such as cast-in-place concrete)	30	105

Other wall and ceiling constructions that might be used for this type of shelter design are shown on pages 10A, 11A, 12A, 13A, 16A, 19A, and 20A. It would be necessary to revise those designs for the appropriate wall and ceiling masses.

### ESTIMATED DIRECT CONSTRUCTION COSTS PER SQUARE FOOT OF CEILING OR WALLS FOR SHELTER (1)

Mass PSF	Total with Shelter	For Conventional Construction	Cost For Adding Shelter
Ceiling 70	\$ .98	\$.45	\$.53
80	1.05	.45	.60
90	1.13	.45	.68
Walls 30	.60	.42	.18
60	.90	.42	.48

(1) See page 9A for explanation

# 9. SLAB | 1 STORY | SMALL | SIDE

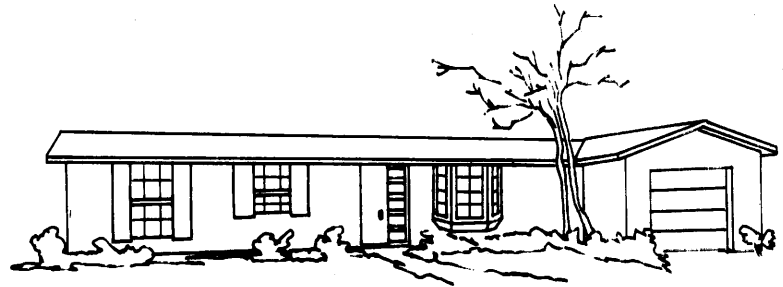
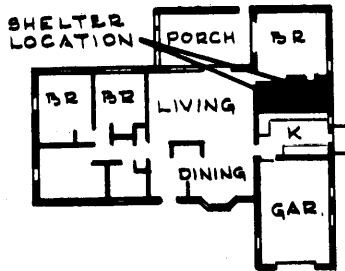

Few cost-effective fallout shelter designs have been available for houses constructed with slab or crawl-space foundations.

Closets, bathrooms, hallways, utility rooms, and other small rooms provide practical abovegrade shelter space more efficiently than do larger rooms. Extend the massive ceiling 3 or 4 feet beyond the wall above the shelter entrance to prevent radiation on the roof from entering the shelter doorway. Side or middle shelters for above-grade houses are more cost-effective because they require less shielding than corner shelters. The other bathroom-hall-closet combination shown on the floor plan could have been selected for the shelter area.

The design table on page 26A shows that a small one-story house on a concrete slab foundation requires a 150 PSF interior wall mass and a 145 PSF ceiling mass if the house exterior walls are of wood framing with siding. A 120 PSF interior wall mass and a 124 PSF ceiling mass are needed if house exterior walls are masonry block or other heavy construction. The exterior shelter wall must have a mass of 150 PSF.

ESTIMATED DIRECT CONSTRUCTION COSTS PER SQUARE FOOT OF CEILING OR WALLS FOR SHELTER (1)

	Mass PSF	Total with Shelter	For Conventional Construction	Cost For Adding Shelter
Ceiling	124	\$1.24	\$.31	\$.93
	145	1.40	.31	1.09
Walls	120	1.15	.42	.73
	150	1.22	.42	.80

(1) See page 9A for explanation

## 9. BATHROOM-WALK-IN CLOSET SHELTER possible use

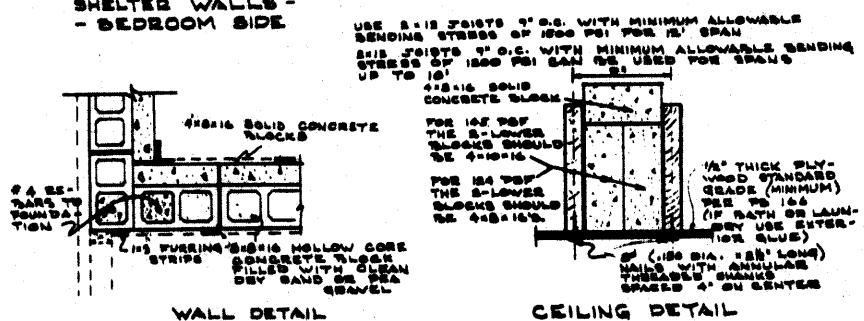
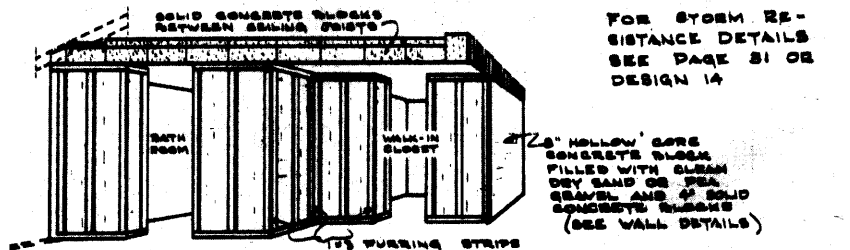
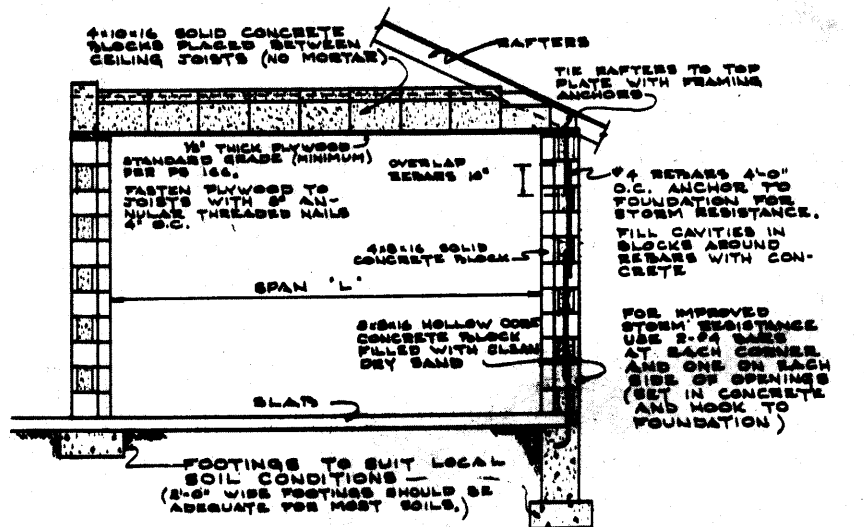

**NOTE:** SUPPLY HOMEOWNERS WITH LOOSE SOLID 4#1616 CONCRETE BLOCK TO SHIELD DOORWAYS IF THE WALLS OPPOSITE DOORS ARE OF LIGHTWEIGHT CONSTRUCTION

# 10. BASEMENT | 1 STORY | LARGE | CORNER

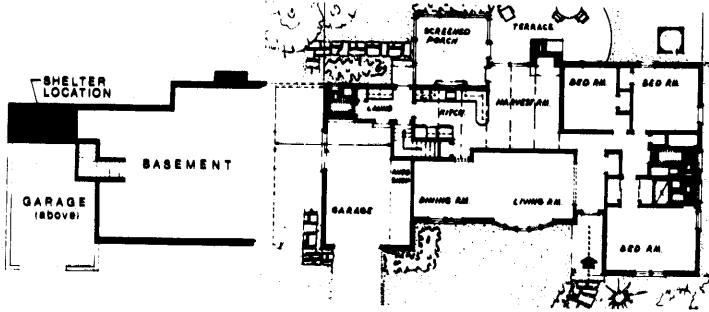
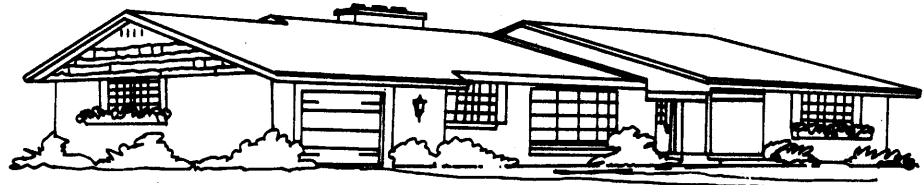

## 10. SEWING OR QUIET ROOM possible use

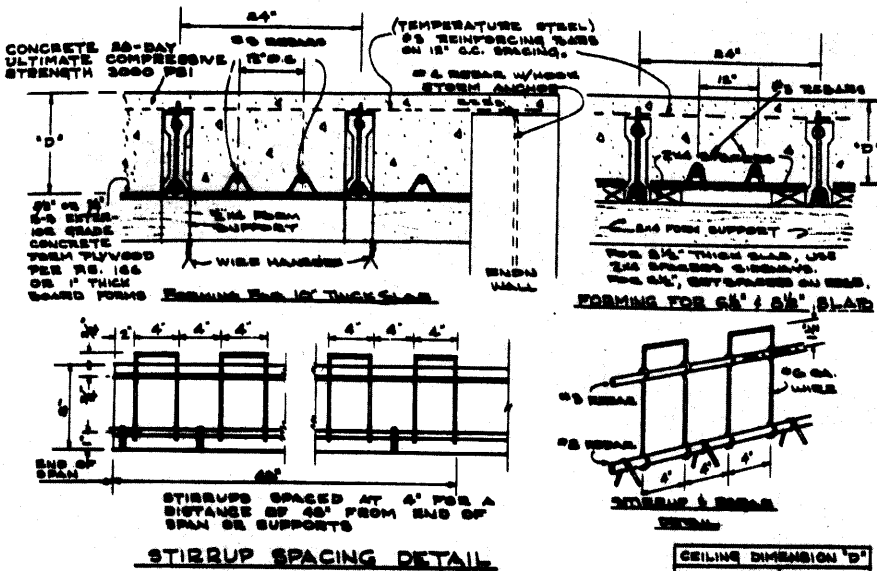

**NOTE**  
THIS DESIGN MAY BE USED ON CLEAR JOIST SPANS UP TO 14-FEET. SPANS OVER 10-FEET SHOULD BE SHORED AT MIDSPAN UNTIL THE CONCRETE SLAB IS CURED

Precast concrete joists with cast-in-place concrete floors represent another cost-effective method of building ceilings over shelters.

This design shows how a concrete slab can be thickened over a shelter area to provide adequate protection from fallout radiation. Concrete floors 2 inches thick not over shelter can prove to be cost-effective for remaining house floors.

From the shelter design table on page 26A, the following interior partition wall and ceiling masses were obtained:

Foundation Wall Exposure	Wall Mass Required PSF	Ceiling Mass Required PSF
2 ft or less (lightweight wall such as hollow masonry block)	30	125
2 to 4 ft (lightweight wall such as hollow masonry block)	60	125
2 ft or less (heavyweight wall such as cast-in-place concrete)	30	80
2 to 4 ft (heavyweight wall such as cast-in-place concrete)	30	105

Other wall and ceiling constructions that can be used for this type shelter design are shown on pages 10A, 11A, 12A, 13A, 16A, 17A, and 20A. It would be necessary to revise those designs for the appropriate wall and ceiling masses.

### ESTIMATED DIRECT CONSTRUCTION COSTS PER SQUARE FOOT OF CEILING OR WALLS FOR SHELTER (1)

	Mass PSF	Total with Shelter	For Conventional Construction	Cost For Adding Shelter
Ceiling	80	\$1.09	\$.73	\$.36
	105	1.29	.73	.56
	125	1.44	.73	.71
Walls	30	.60	.42	.18
	60	.90	.42	.48

(1) See page 9A for explanation

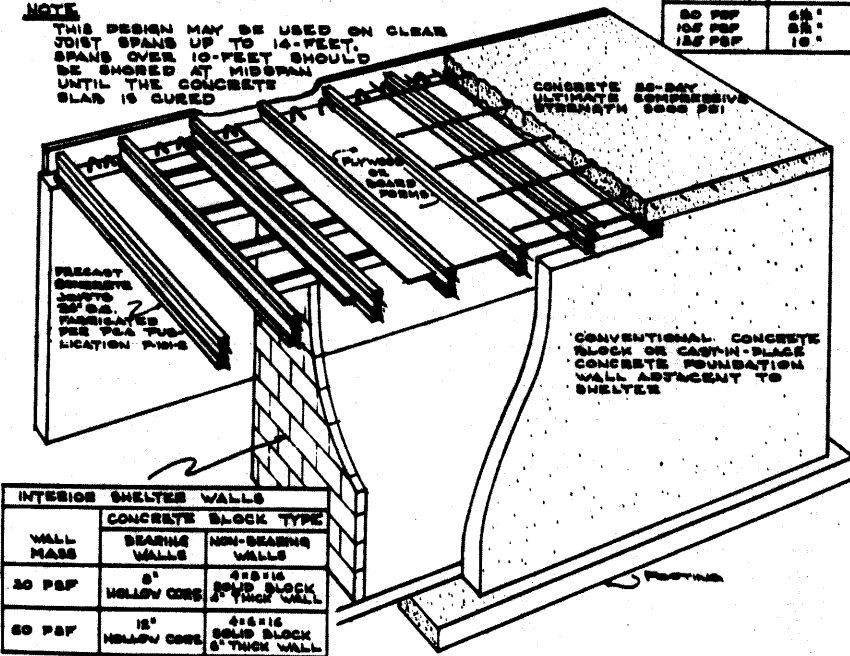

INTERIOR SHELTER WALLS		
WALL MASS	CONCRETE BLOCK TYPE	
	BEARING WALLS	NON-BEARING WALLS
30 PSF	8" HOLLOW CORE	4" x 16" SOLID BLOCK 6" THICK WALL
60 PSF	12" HOLLOW CORE	4" x 16" SOLID BLOCK 6" THICK WALL

# 11. BASEMENT | 1 STORY | SMALL | MIDDLE

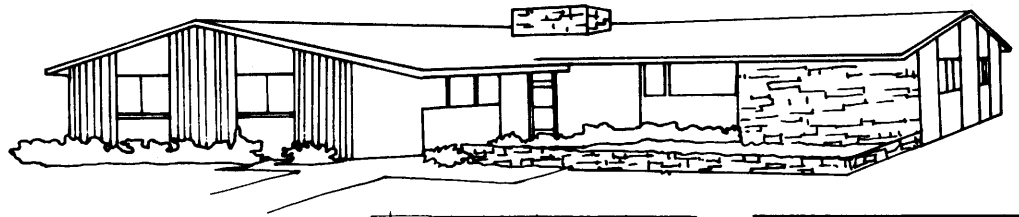

Interior design concepts may be compatible with fallout shelter design. Breakfast areas and foyers with brick or flagstone floors provide ceiling mass and decrease the cost required to provide overhead radiation shielding in shelters below these rooms.

A basement room having this kind of overhead mass can serve as a guest room, den, extra bedroom, or study.

The design table on page 26A indicates a middle shelter in this house requires the following wall and ceiling masses:

Foundation Wall Exposure	Wall Mass Required PSF	Ceiling Mass Required PSF
2 ft or less (lightweight wall such as hollow masonry block)	30	138
2 to 4 ft (lightweight wall such as hollow masonry block)	60	123
2 ft or less (heavyweight wall such as cast-in-place concrete)	30	110
2 to 4 ft (heavyweight wall such as cast-in-place concrete)	30	123

Other wall and ceiling constructions that might be used for this shelter design are shown on pages 10A, 11A, 12A, 13A, 16A, 17A, and 19A. It would be necessary to revise those designs for the appropriate wall and ceiling masses.

ESTIMATED DIRECT CONSTRUCTION COSTS PER SQUARE FOOT OF CEILING OR WALLS FOR SHELTER (1)

	Mass PSF	Total with Shelter	For Conventional Construction	Cost For Adding Shelter
Ceiling with				
brick	123	1.36	.60	.76
	138	1.42	.60	.82
Ceiling without	110	1.25	.45	.80
brick	123	1.30	.45	.85
	138	1.36	.45	.91
Walls	30	.60	.42	.18
	60	.90	.42	.48

(1) See page 9A for explanation

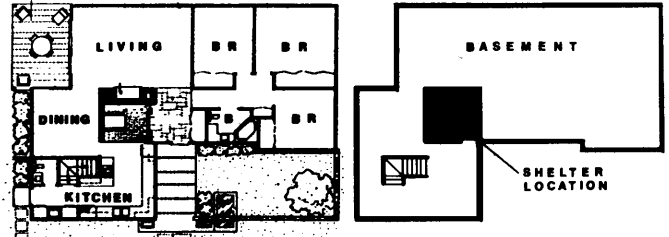

## 11. STORAGE OR SAUNA BATH possible use

INTERIOR SHELTER WALL DESIGN		
WALL MASS	CONCRETE BLOCK TYPE	
	BEARING WALLS	NON-BEARING WALLS
30 PSF	8" HOLLOW CORE	4-8-16 SOLID BLOCK 8" THICK WALL
60 PSF	16" HOLLOW CORE	4-8-16 SOLID BLOCK 8" THICK WALL

FOR INCREASED STORM RESISTANCE SEE DETAILS ON PAGE 31

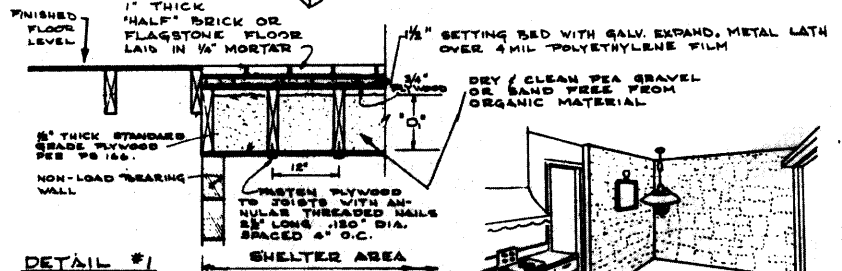
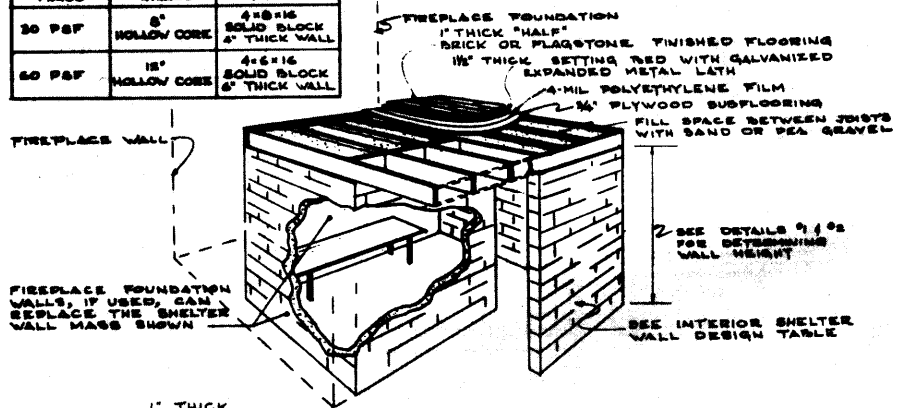

DETAIL #1 SHELTER CEILING CONSTRUCTION WHEN BRICK IS USED

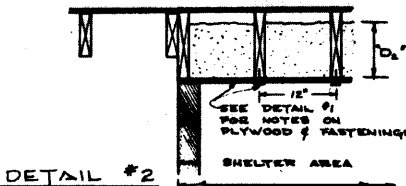

DETAIL #2 SHELTER CEILING CONSTRUCTION WHEN BRICK IS NOT USED

FILL DEPTHS 'D <sub>1</sub> ' & 'D <sub>2</sub> '		
CEILING MASS	'D <sub>1</sub> ' AND 'D <sub>2</sub> '	
	COMBINED WITH BRICK	BRICK FLOOR NOT USED
110 PSF	8 1/4"	10 1/4"
123 PSF	9 1/4"	11 1/4"
138 PSF	10 1/4"	12 1/4"

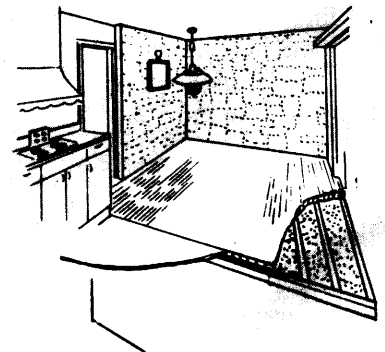

JOIST DESIGN TABLE* (FOR 120 PSF LOADINGS OR LESS)	
SPAN 'L'	SIZE
8'	2 x 10
10'	2 x 10
12'	2 x 12
14'	2 x 14

\* SPACE JOISTS 12" O.C. USE LUMBER WITH MINIMUM ALLOWABLE BENDING STRESS OF 1800 PSI

JOIST DEPTH SHOULD BE SUFFICIENT TO ACCOMMODATE DIMENSIONS 'D<sub>1</sub>' & 'D<sub>2</sub>'

## 12. SHELTER UNDER PATIO

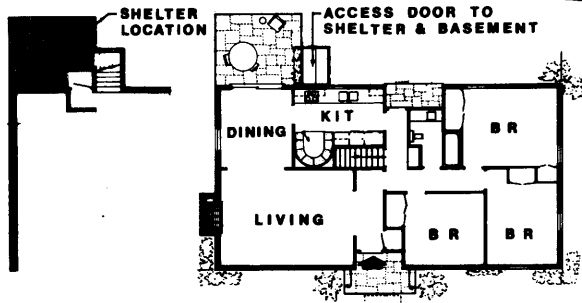
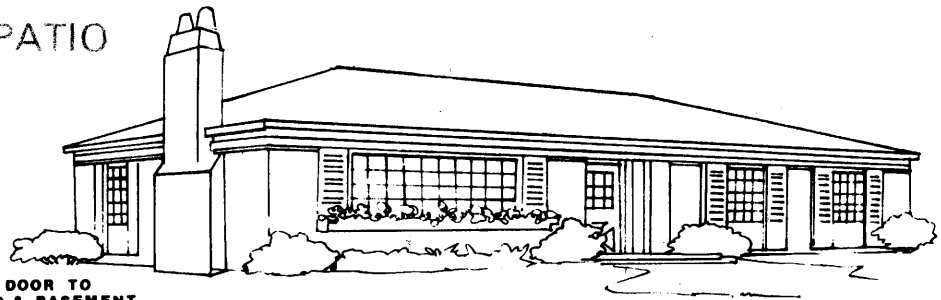

## 12. WINE CELLAR OR TOOL STORAGE UNDER PATIO *possible use*

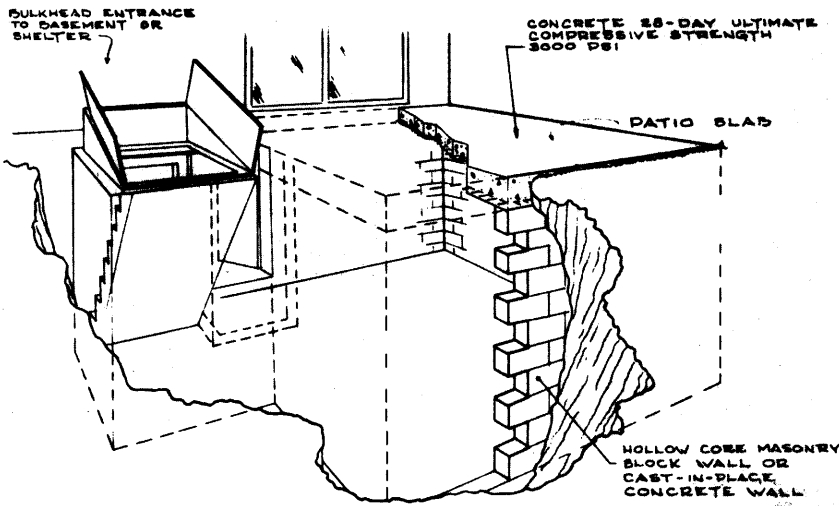

### PATIO SLAB AND ANCHORAGE DETAIL

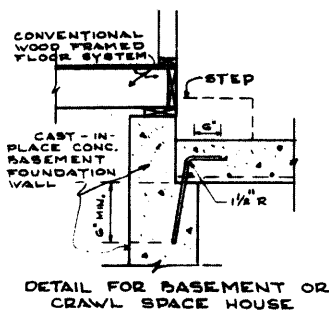
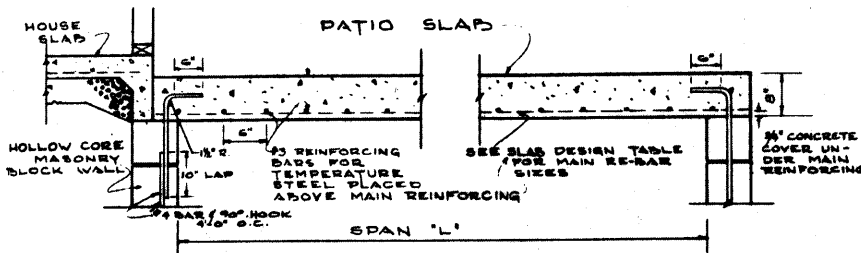

SLAB DESIGN TABLE	
SPAN 'L' IN FEET	RE-BAR SIZE & C.C. SPACING
6	#3
8	#3
10	#4
12	#5
14	#5

Patios give sales appeal to new homes and, when added to existing homes, make yards more attractive.

A storm and fallout shelter located under a patio offers a cost-effective design. Such a room can be used to store gardening tools, or it might be made into a sound-conditioned workshop away from the main structure.

As indicated in the design, an 8-inch-thick reinforced concrete slab doubles as patio deck and overhead shielding for the shelter. If the shelter is next to the basement, persons can enter through a door in the basement wall. Otherwise, the entrance can be through any shelter wall.

A bulkhead entrance, as illustrated, prevents radioactive fallout particles from dropping into the stairwell and contaminating the areaway. Adding a bulkhead entrance increases the shelter cost.

ESTIMATED DIRECT CONSTRUCTION COSTS PER SQUARE FOOT (1) OF CEILING, WALLS AND FLOOR FOR SHELTER (2)

	Mass with PSF	Total with Shelter	For Conventional Construction	Cost For Adding Shelter
Ceiling	100	\$1.14	\$ .40	\$ .74
Walls	30	.50	—	.50
Excavation	—	1.00/CY	—	1.00/CY
Floor	—	.40	—	.40

(1) Except as otherwise noted  
 (2) See page 9A for explanation

# 13. SLAB | 1 STORY | SMALL | SIDE

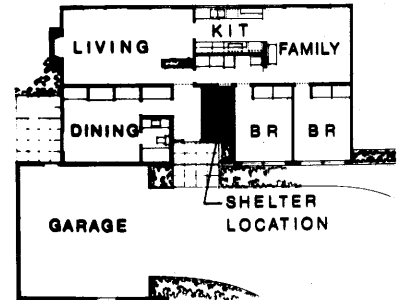
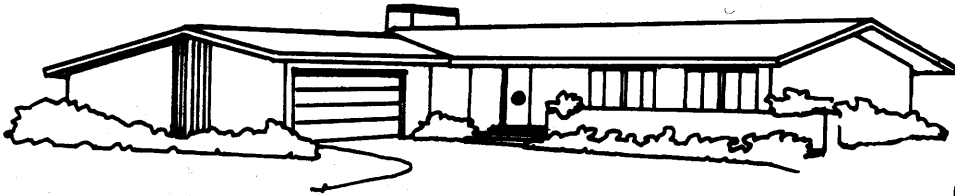

Some homes being built in southeastern states have cast-in-place concrete floors, walls, and pitched roofs. House construction of this type is especially compatible with fallout shelters because concrete provides much needed mass. Cast-in-place concrete can be used to build fallout shelter space in an abovegrade house as indicated in the design, whether or not the balance of the house uses concrete. The shelter area should be along one side or in the middle of the house and could be used as a bath, hallway, storage closet, or utility room.

The design table on page 26A shows that a side shelter in this type of house requires the following wall and ceiling masses:

	Wall Mass Required PSF	Ceiling Mass Required PSF
Exterior House Wall		
Light, such as wood frame and siding	150	145
Heavy, such as 8-inch masonry block with brick veneer	120*	124

\*Exterior wall of shelter must be 150 PSF.

Other wall and ceiling constructions that might be used for this type of shelter design are shown on pages 23A, 24A, and 25A. It would be necessary to revise those designs for the appropriate wall and ceiling masses.

ESTIMATED DIRECT CONSTRUCTION COSTS PER SQUARE FOOT OF CEILING OR WALLS FOR SHELTER (1)

	Mass PSF	Total with Shelter	For Conventional Construction	Cost For Adding Shelter
Ceiling	124	\$1.26	\$ .31	\$ .95
	145	1.45	.31	1.14
Walls	120	1.04	.42	.62
	150	1.26	.42	.84

(1) See page 9A for explanation

## 13. BATH-UTILITY-HALLWAY SHELTER possible use

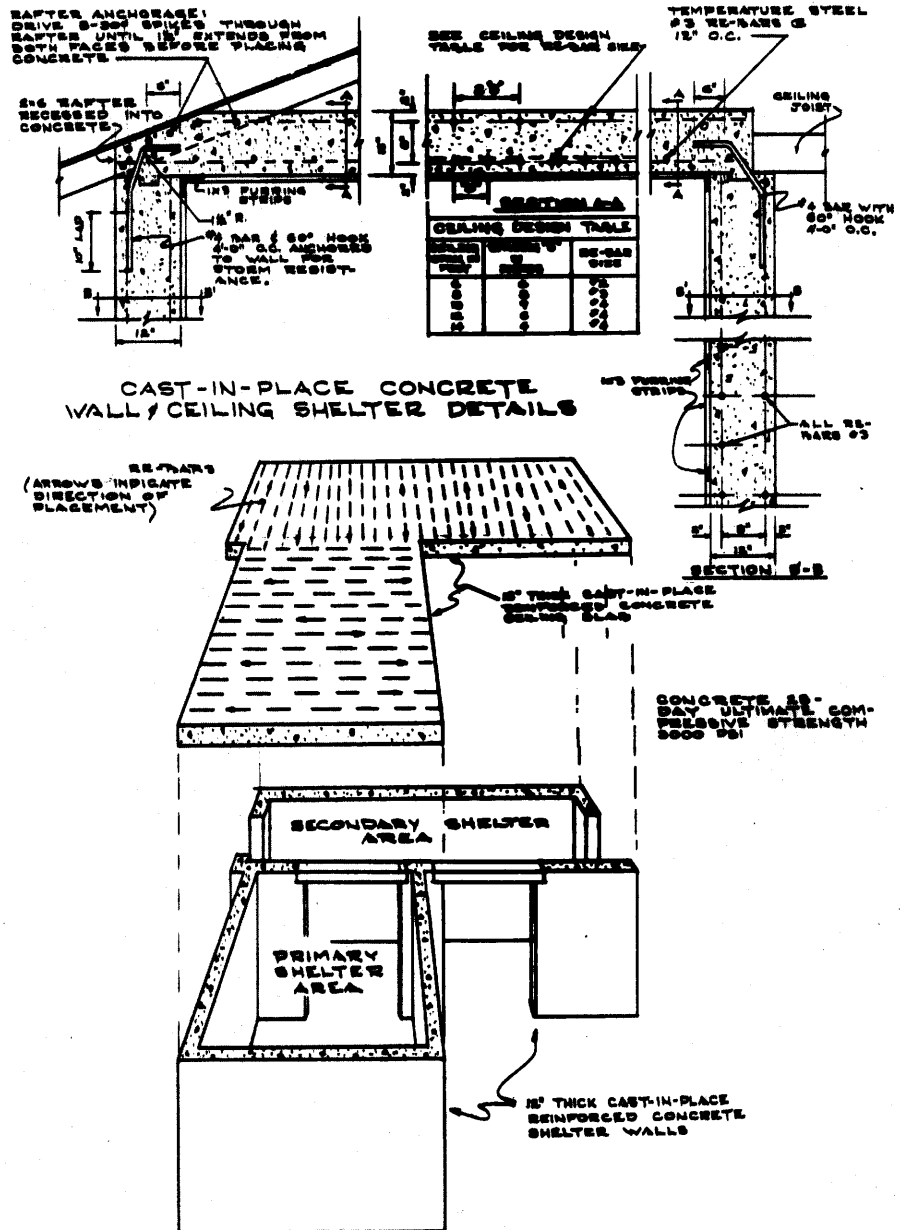

# 14. CRAWL SPACE | 1 STORY | LARGE | SIDE

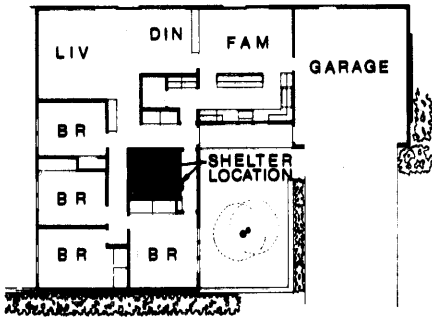
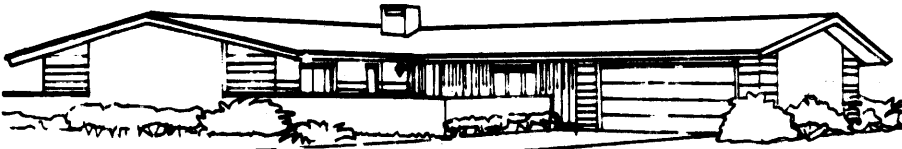

## 14. BATHROOM SHELTER possible use

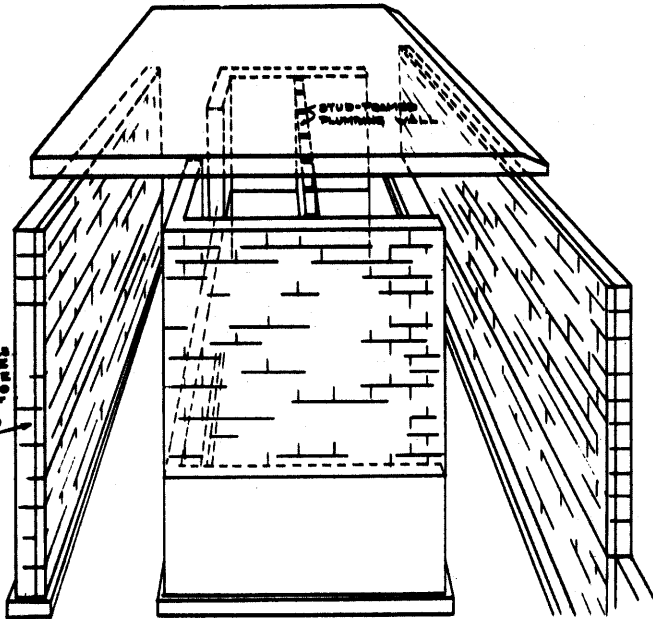

SHELTER WALLS  
DETAILED ABOVE  
ARE AS QUANTIFIED  
FOR BOTH 100  
AND 140 PSF  
MASSES

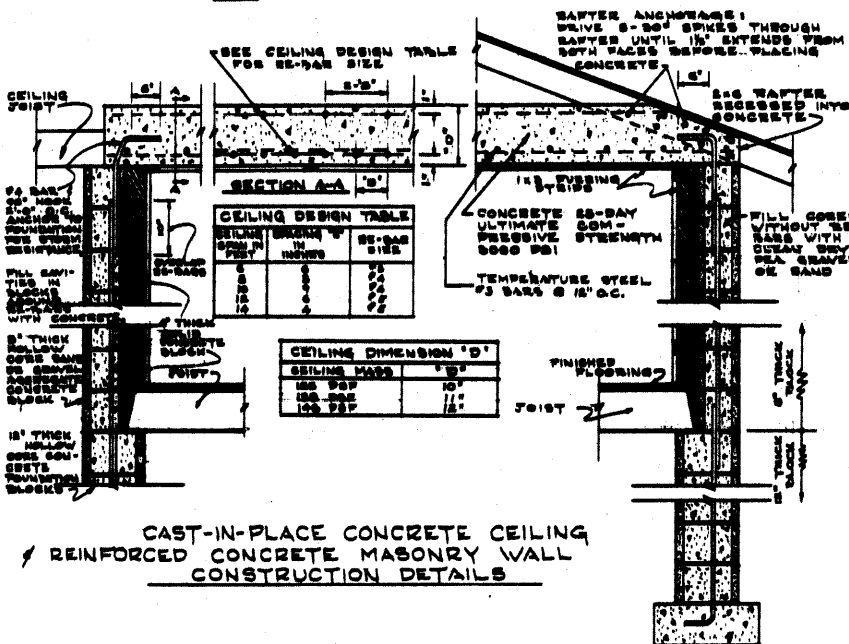

Crawl-space and slab-on-grade foundation houses require careful design considerations to keep fallout shelter costs low. Above-grade areas are highly vulnerable to direct radiation from radioactive fallout dust particles on the lawn and roof. Slope the yard away from the house and use earth shields such as planters or terraces to provide the shelter with effective shielding mass.

Select a small room in the middle or along one side of the house for the shelter. The reinforced cast-in-place concrete ceiling and reinforced concrete masonry block wall shown in the design also offer excellent protection in areas frequented by high intensity windstorms.

The design table on page 26A shows that a side shelter in this type of house requires the following wall and ceiling masses:

Foundation Wall	House Wall	Wall Mass Required PSF	Ceiling Mass Required PSF
Light (1)	Light (3)	140	146
Light (1)	Heavy (4)	120	138
Heavy (2)	Light (3)	140	137
Heavy (2)	Heavy (4)	120	126

- (1) Such as 8-inch-thick hollow masonry block
- (2) Such as 8-inch-thick cast-in-place concrete
- (3) Such as wood frame with siding
- (4) Such as masonry block with brick veneer

Other wall and ceiling constructions that might be used for this type of shelter design are shown on pages 24A and 25A. It would be necessary to revise those designs for the appropriate wall and ceiling masses.

### ESTIMATED DIRECT CONSTRUCTION COST PER SQUARE FOOT OF CEILING OR WALLS FOR SHELTER (1)

	Mass PSF	Total with Shelter	For Conventional Construction	Cost For Adding Shelter
Ceiling	126	\$1.31	\$ .31	\$1.00
	137	1.38	.31	1.07
	138	1.38	.31	1.07
	146	1.45	.31	1.14
Walls	150	1.22	.42	.80

Foundation—Depending on type and location of house

(1) See page 9A for explanation



# 15. CRAWL SPACE | 1 STORY | SMALL | MIDDLE

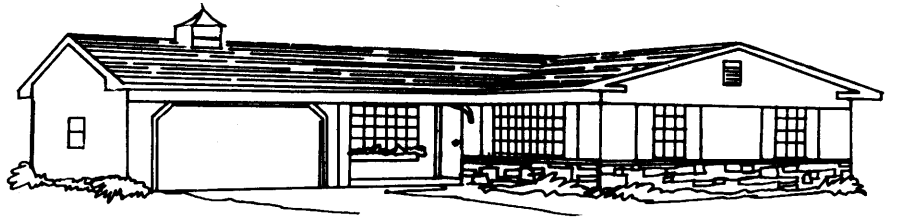

An excellent choice for a fallout and storm shelter in a one-story house on a crawl-space foundation is a centrally-located small room, such as a bathroom, with reinforced concrete walls and ceiling.

The fallout shelter ceiling should project beyond the wall over the door as illustrated so radiation from the roof area cannot readily enter the shelter entrance. Notice the shielding afforded by the wall opposite the door keeps out direct radiation from lawn areas.

The design table on page 26A shows that a middle shelter in this type of house requires the following wall and ceiling masses:

Foundation Wall	House Wall	Wall Mass Required PSF	Ceiling Mass Required PSF
Light (1)	Light (3)	140	133
Light (1)	Heavy (4)	120	110
Heavy (2)	Light (3)	140	125
Heavy (2)	Heavy (4)	120	108

- (1) Such as 8-inch-thick hollow masonry block
- (2) Such as 8-inch-thick cast-in-place concrete
- (3) Such as wood frame with siding
- (4) Such as masonry block with brick veneer

Other acceptable wall and ceiling constructions that might be used for this type of shelter design are shown on pages 22A, 23A, and 25A. It would be necessary to revise those designs for the appropriate wall and ceiling masses.

ESTIMATED DIRECT CONSTRUCTION COSTS PER SQUARE FOOT OF CEILING OR WALLS FOR SHELTER (1)

	Mass PSF	Total with Shelter	For Conventional Construction	Cost For Adding Shelter
Ceiling	109	\$1.20	\$.31	\$.89
	112	1.21	.31	.90
	123	1.28	.31	.97
	130	1.33	.31	1.02
Walls	120	1.03	.42	.61
	140	1.18	.42	.76

Foundation—Depending on type and location of house

(1) See page 9A for explanation

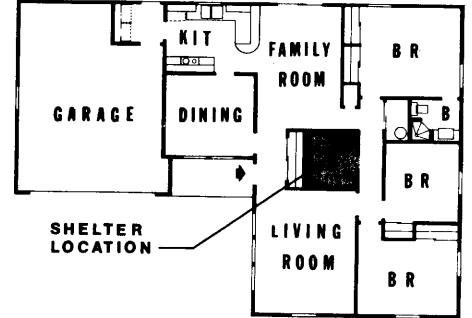

15. BATHROOM SHELTER possible use

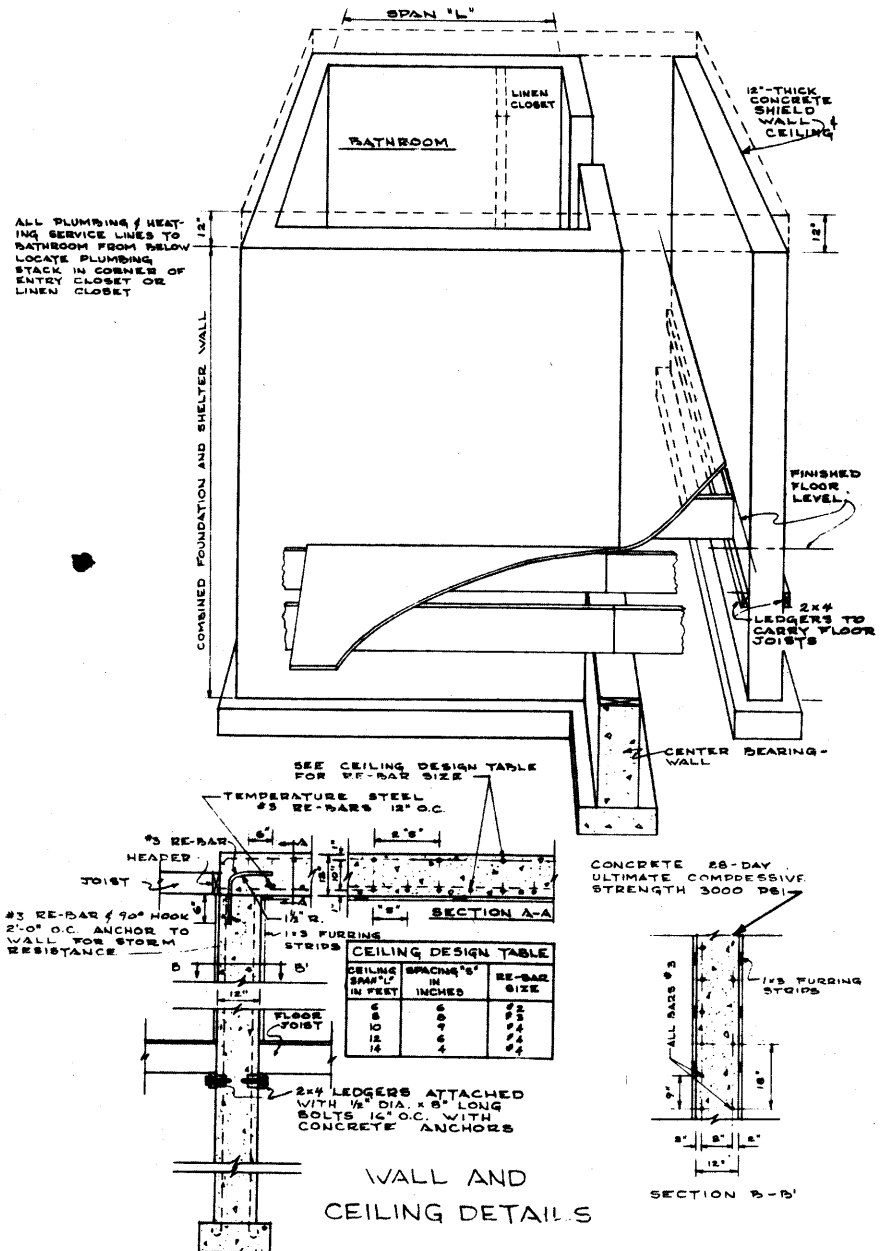

# 16. SLAB | 2 STORY | LARGE | MIDDLE

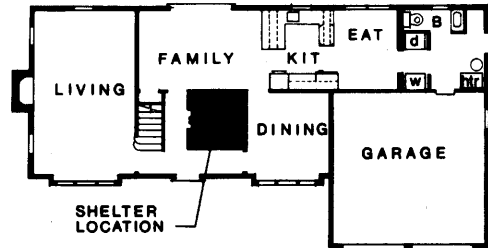

## 16. STORAGE CLOSET SHELTER possible use

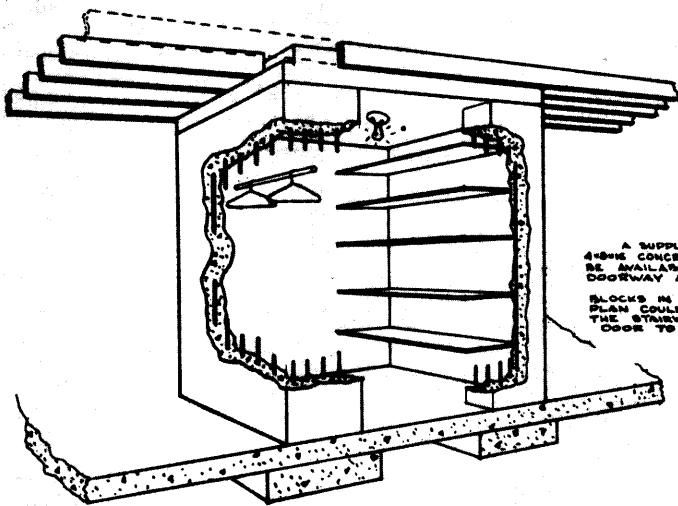

A SUPPLY OF LOOSE SOLID 4-INCH CONCRETE BLOCKS SHOULD BE AVAILABLE TO SHIELD THE DOORWAY AT TIME OF NEED  
BLOCKS IN THIS PARTICULAR PLAN COULD BE STORED UNDER THE STAIRWAY OPPOSITE THE DOOR TO SHELTER

Any above-grade shelter requires quite massive walls, and as a result, reinforced concrete appears to be a cost-effective material to use. Reinforcing steel in thick concrete slabs or walls is quite efficient, and a small quantity will provide strength at low cost. This fallout shelter design provides excellent resistance against tornadoes or other high intensity windstorms.

The design table on page 26A shows that a shelter located in the middle of this type of house requires the following wall and ceiling masses:

	Wall Mass Required PSF	Ceiling Mass Required PSF
Exterior House Wall		
Light, such as wood frame and siding	140	146
Heavy, such as 8-inch masonry block with brick veneer	120	105

Other acceptable wall and ceiling constructions that might be used for this type of shelter design are shown on pages 22A, 23A, and 24A. It would be necessary to revise those designs for the appropriate wall and ceiling masses.

### ESTIMATED DIRECT CONSTRUCTION COSTS PER SQUARE FOOT (1) OF CEILING OR WALLS FOR SHELTER (2)

	Mass PSF	Total Cost For Shelter	For Conventional Construction	Cost For Adding Shelter
Ceiling	113	\$1.23	\$ .31	\$ .92
	151	1.45	.31	1.14
Walls	120	1.03	.42	.61
	140	1.18	.42	.76
Footing	—	.63/LF	—	.63/LF

(1) Except as otherwise noted

(2) See page 9A for explanation

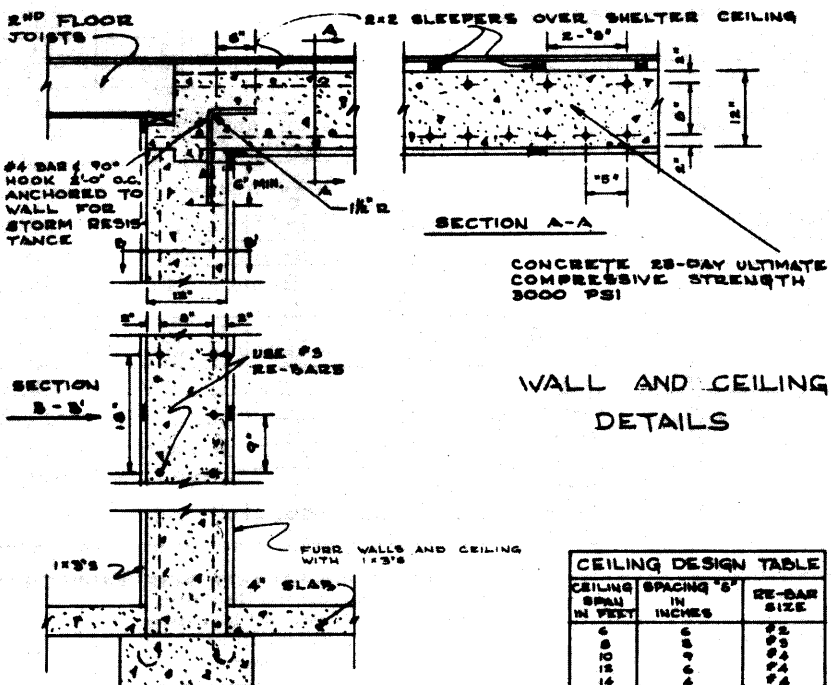

# SHELTER WALL AND CEILING MASS DESIGN TABLE TO OBTAIN A PROTECTION FACTOR OF 40 (PF40)

NO. STORIES & AREA PER FLOOR	BASEMENT FOUNDATION					CRAWL SPACE MAX FDN WALL EXPOS 3 FT			SLAB ON GRADE	
	FDN TYPE & WT PER SQ FT (BASEMENT & CRAWL SPACE)	EXPOSURE OF FDN WALL ABOVE GRADE (BASEMENT)	SHELTER LOCATION	SHELTER AREA WALL MASSES REQUIRED IN POUNDS PER SQ FT (PSF)	SHELTER CEILING MASS REQUIRED IN PSF	HOUSE WALL TYPE & WT PER SQ FT (CRAWL SPACE AND SLAB)	SHELTER AREA WALL MASSES REQUIRED IN PSF	SHELTER CEILING MASS REQUIRED IN PSF	SHELTER AREA WALL MASSES REQUIRED IN PSF	SHELTER CEILING MASS REQUIRED IN PSF
One Story Small Under 1600 sq ft	Light (1) Approx. 40 PSF	To 2' Above Grade	Corner	30 (2)	100	Light (3) Approx. 5 PSF	(4)	(4)	(4)	(4)
			Middle	30	138		140	133	150	123
			Side	60	80		140 (6)	156	150	145
		2' to 4' Above Grade	Corner	60 (2)	122	Heavy (5) Approx. 43 PSF	(4)	(4)	(4)	(4)
			Middle	60	123		120	110	120	113
			Side	60 (2)	122		130 (6)	130	120 (6)	124
	Heavy (7) Approx. 100 PSF	To 2' Above Grade	Corner	30	80	Light (3) Approx. 5 PSF	(4)	(4)	The above is not repeated because the results do not depend on foundation wall types	
			Middle	30	110		140	125		
			Side	30	95		140 (6)	145		
		2' to 4' Above Grade	Corner	30 (2)	105	Heavy (5) Approx. 43 PSF	(4)	(4)		
			Middle	30	123		120	108		
			Side	30 (2)	120		120 (6)	122		
One Story Large 1600 sq ft & Over	Light (1) Approx. 40 PSF	To 2' Above Grade	Corner	30	125	Light (3) Approx. 5 PSF	(4)	(4)	(4)	(4)
			Middle	30	138		140	130	140	151
			Side	60	100		140 (6)	146	150	138
		2' to 4' Above Grade	Corner	60 (2)	125	Heavy (5) Approx. 43 PSF	(4)	(4)	(4)	(4)
			Middle	60	122		120	112	120	113
			Side	90 (2)	104		120 (6)	138	120 (6)	132
	Heavy (7) Approx. 100 PSF	To 2' Above Grade	Corner	30	80	Light (3) Approx. 5 PSF	(4)	(4)	The above is not repeated because the results do not depend on foundation wall types	
			Middle	30	103		140	123		
			Side	60	85		140 (6)	137		
		2' to 4' Above Grade	Corner	30 (2)	105	Heavy (5) Approx. 43 PSF	(4)	(4)		
			Middle	30	125		120	109		
			Side	60	110		120 (6)	126		
Two Stories Small Under 900 sq ft	Light (1) Approx. 40 PSF	To 2' Above Grade	Corner	30	50	Light (3) Approx. 5 PSF	(4)	(4)	(4)	(4)
			Middle	30	75		140	140	150	116
			Side	30	57		140 (6)	131	150 (6)	120
		2' to 4' Above Grade	Corner	60 (2)	75	Heavy (5) Approx. 43 PSF	(4)	(4)	(4)	(4)
			Middle	60	93		120	94	120	96
			Side	60 (2)	74		120 (6)	108	120 (6)	104
	Heavy (7) Approx. 100 PSF	To 2' Above Grade	Corner	None	65	Light (3) Approx. 5 PSF	(4)	(4)	The above is not repeated because the results do not depend on foundation wall types	
			Middle	None	65		140	140		
			Side	None	56		140 (6)	125		
		2' to 4' Above Grade	Corner	30	70	Heavy (5) Approx. 43 PSF	(4)	(4)		
			Middle	30	70		120	90		
			Side	30	60		120 (6)	100		
Two Stories Large 900 sq ft & Over	Light (1) Approx. 40 PSF	To 2' Above Grade	Corner	30	70	Light (3) Approx. 5 PSF	(4)	(4)	(4)	(4)
			Middle	30	90		140	122	140	146
			Side	30 (2)	83		140 (6)	130	150	125
		2' to 4' Above Grade	Corner	60 (2)	90	Heavy (5) Approx. 43 PSF	(4)	(4)	(4)	(4)
			Middle	60	100		120	100	120	105
			Side	60 (2)	75		120 (6)	117	130 (6)	110
	Heavy (7) Approx. 100 PSF	To 2' Above Grade	Corner	None	70	Light (3) Approx. 5 PSF	(4)	(4)	The above is not repeated because the results do not depend on foundation wall types	
			Middle	None	80		140	116		
			Side	None	109		140 (6)	123		
		2' to 4' Above Grade	Corner	30	80	Heavy (5) Approx. 43 PSF	(4)	(4)		
			Middle	30	85		120	97		
			Side	30	97		120 (6)	106		

- (1) An example would be 8-inch thick hollow masonry block.
- (2) Additional wall mass equivalent to interior shelter wall is necessary along basement exterior wall.
- (3) Conventional wood frame with composition, wood, or metal siding.

- (4) Corner location not recommended for abovegrade shelters because they cost more than side or middle shelters.
- (5) Conventionally wood frame with brick veneer.
- (6) Exterior wall mass should be 150 PSF.
- (7) 8-inch thick cast-in-place concrete.

Basic knowledge about the effects of nuclear attack is useful to understand construction of cost-effective fallout shelters. This concerns the type of attack, number and location of cities hit, size of weapons used, type of bomb such as a fusion bomb (hydrogen) or fission bomb (uranium or plutonium), and whether an airburst or ground burst. Precipitation during and after an attack (mainly wind, rain, or snow) also greatly affects how much danger might result from an attack.

In the event our large cities and military installations came under attack, there are a number of ways in which housing would be affected. If a nuclear explosion occurs near the ground, the large fireball dissolves and vaporizes materials near it and changes them into hot gasses. These hot gasses rapidly rise into the cooler atmosphere to an altitude of about 80,000 feet. Any radioactive byproducts of the explosion are swept upward into this mushroom-shaped cloud. As the gasses cool, they condense onto small dust particles which fall back to the ground and are called fallout. If the fireball touches the ground, debris rises into the mushroom cloud, but if there is an airburst, no debris rises.

The particles of fallout vary in size from that of coarsely ground coffee to finely sifted flour. These particles of dust gradually settle to earth as does snow or the dust from an erupting volcano. Earth's surface winds may cause these fallout particles to settle over much of the United States.

The map on page 28A shows how fallout might begin to spread over our country just one hour after an assumed attack. The map on page 28A shows a possible situation 24 hours after the same assumed attack. Seasonal wind pattern variations can create situations much different than the example shown, so regions that appear safe become areas of extreme danger.

Each small radioactive fallout par-

ticle sends out deadly gamma rays in all directions. Fallout radiation is very intense when the dust from the explosion first covers the ground. As time passes, the gamma radiation will gradually lose most of its energy. The purpose of having a fallout shelter is to keep harmful and lethal dosages of gamma radiation from reaching people during the high-intensity period. The Office of Civil Defense believes that a fallout shelter should provide sufficient gamma radiation shielding to reduce the intensity of gamma radiation to 1/40th of its intensity outside the shelter. A shelter that provides this reduction in gamma radiation intensity is said to have a protection factor of 40 (often called PF 40).

Families would have to occupy fallout shelters with a PF 40 for up to two weeks or until local civil defense officials advise that it is safe to leave. Shelters, however, could normally be left for short periods of from five to fifteen minutes after the first 24 to 48 hours as long as occupants remain within the house. As fallout gamma radiation intensity decreases, persons could go to other portions of the house for longer times. Civil defense officials would inform occupants when to leave the house and how long it is safe to remain outside.

There are four basic principles of shielding against gamma radiation that will aid a builder in constructing effective fallout shelters at the least cost.

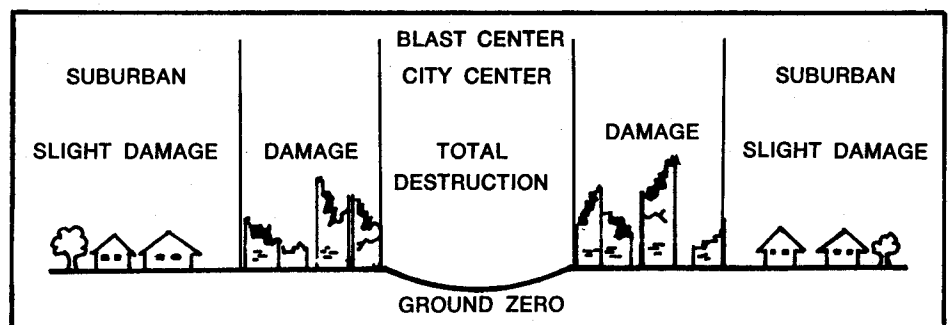
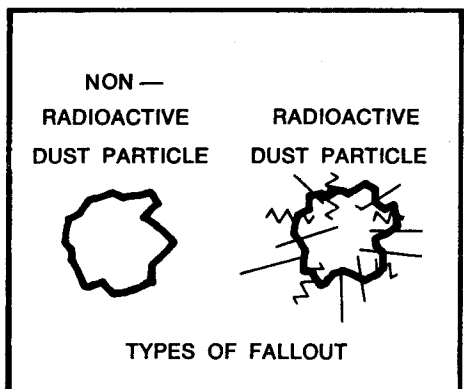
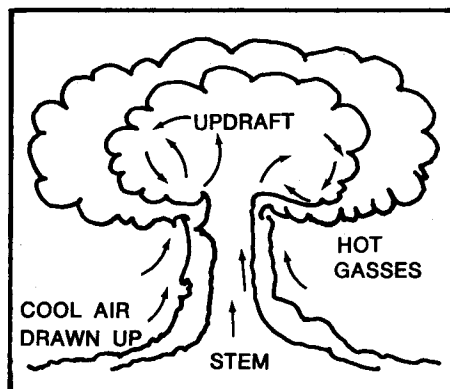
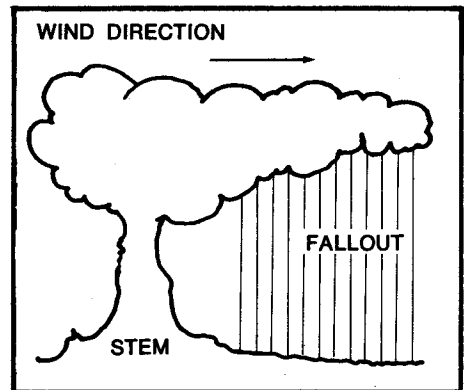
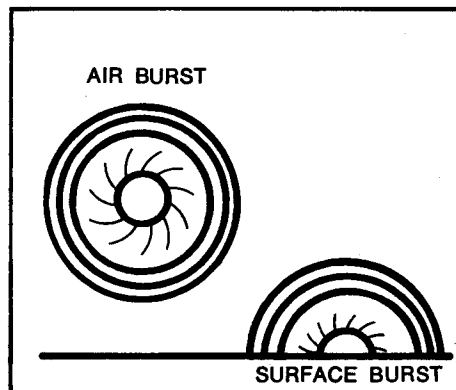

The four principles are: Barrier Shielding, Geometry Shielding, Distance Effect, and Time Effect.

**BARRIER SHIELDING:** Gamma radiation penetrating any material is captured or stopped if there is sufficient material present. Fallout gamma radiation intensity is initially very high and requires a relatively thick barrier of massive material to effectively reduce the amount of radiation energy that passes through it. Sometimes, it is possible to provide very effective barrier shielding in houses while adding very little cost. Usually this requires taking advantage of economical shielding materials such as concrete, masonry, and earth that are already part of the house design.

The space under a porch and garage floor, for example, usually has a concrete slab overhead, masonry or concrete walls supporting the slab, and earth surrounding most of the wall.

Using a concrete slab floor of an entryway that has a tile or flagstone covering is another way to provide effective barrier shielding economically. Houses built into a hillside attain barrier shielding from the hill. Sloping the yard away from the house or using a higher earth backfill on exposed basement walls are effective barrier shielding techniques. Much fallout shelter cost can be saved by taking advantage of terraces, retaining walls, courtyards, and planters that are part of landscaping. Pools of water can provide an effective barrier because the fallout particles that drop into pools are covered with water, and the water acts as a shield. Precast concrete panels or decorative masonry screens are also possible barrier shielding devices. Other buildings or houses may act as effective barriers. The centrally-located rowhouse units are excellent examples of barrier shielding that is obtained from other structures with no increase in cost. Hollow spaces in walls, such as the cores in concrete masonry blocks, may be filled with sand or gravel to make walls into more effective barriers.

The table on page 26A lists typical wall and ceiling masses required to provide a PF 40 for different types of residential construction.

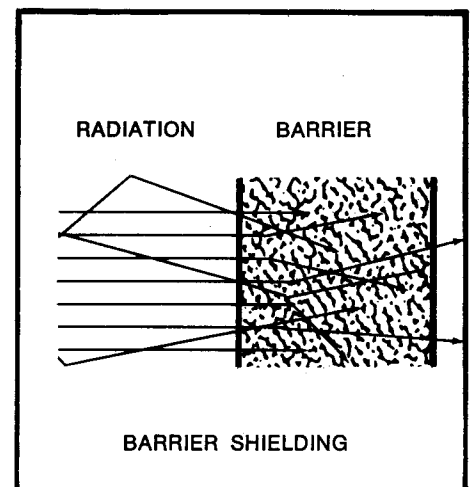
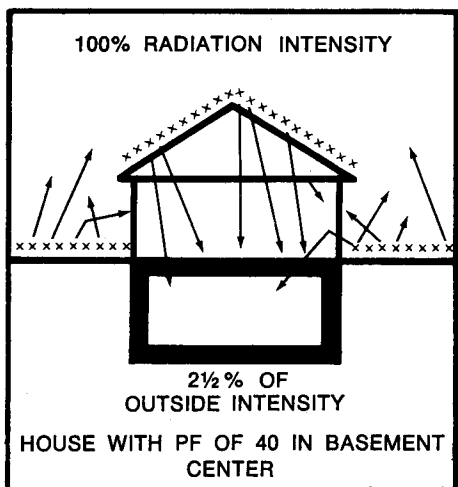
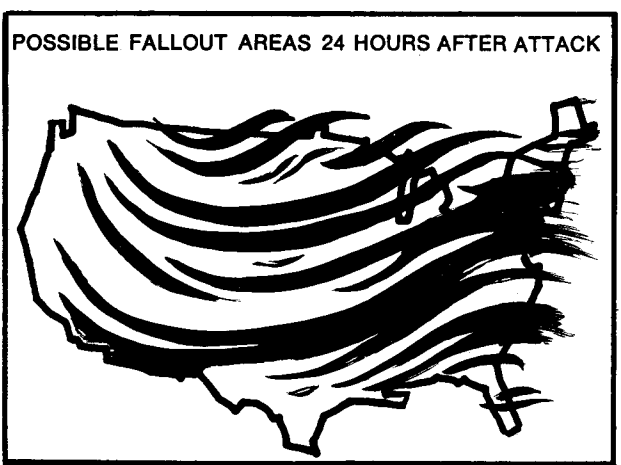
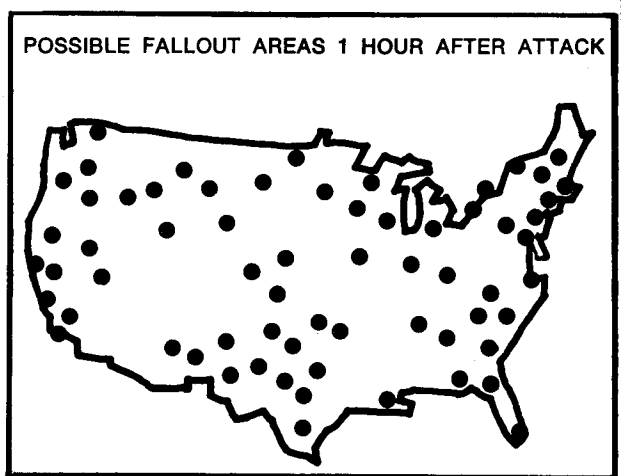
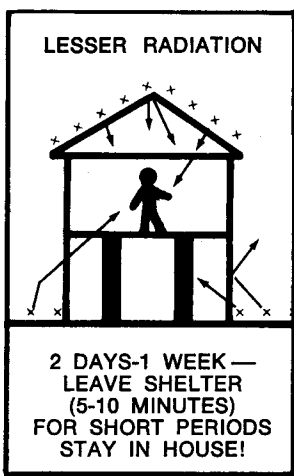

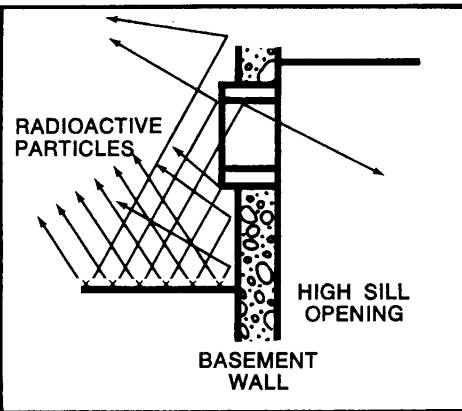
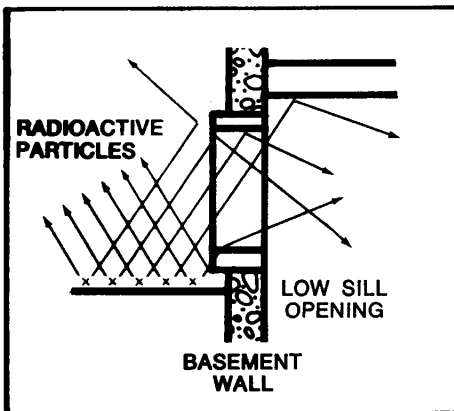
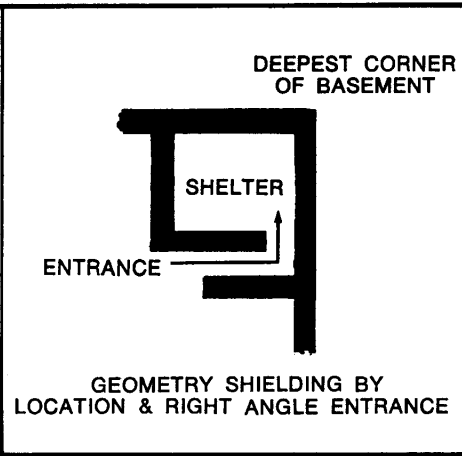
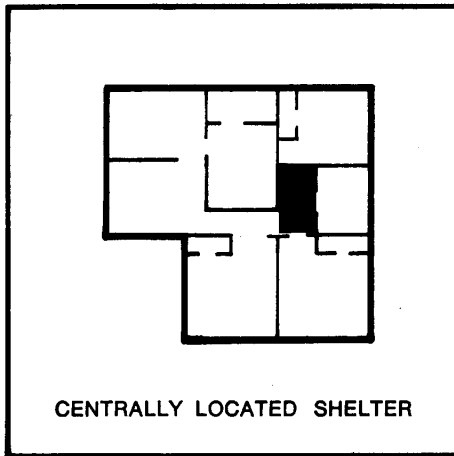
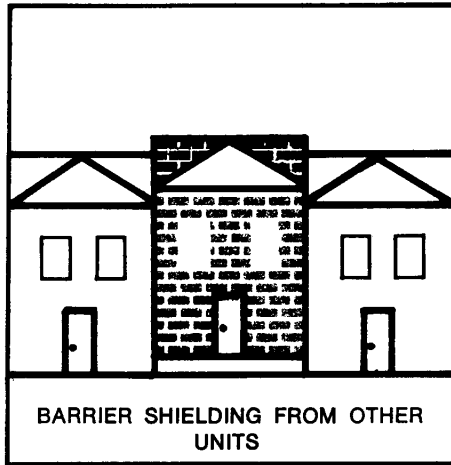
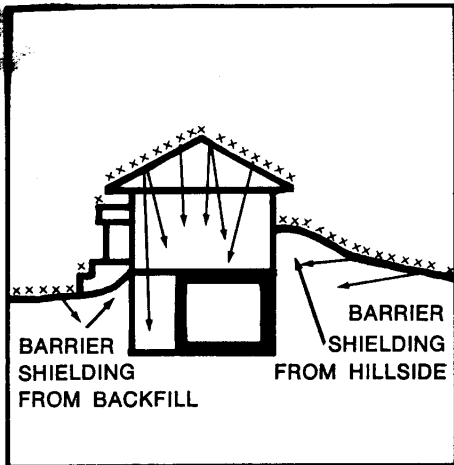

GEOMETRY SHIELDING BY LOCATION OF WINDOWS

**GEOMETRY SHIELDING:** Often, it is possible to arrange the size, shape, or position of a house; the parts of a house; or its surroundings to decrease the amount of fallout gamma radiation that can enter the structure. Using a centrally located hall takes advantage of geometry because this position has more wall barriers between the shelter space and the outside contaminated area. Lightweight doors and windows are not good shielding barriers, and it is often necessary to use geometry to prevent radiation from streaming into a shelter area through such openings. It is often possible to provide right angle turns at entrances or to move door or window locations slightly to eliminate direct paths for the radiation into a shelter. Courtyard walls and decorative concrete or masonry screens outside the doors or windows allow normal use of such openings but provide shielding against gamma radiation. Windows need not be eliminated from space used as a fallout shelter, but it is desirable to keep the window areas small. Raising the sill height of windows is very effective in reducing direct gamma radiation from yards. Lightwells and skylights, if small, work very effectively for getting light into core areas of the house used for fallout shelters.

House-site planning can provide the advantage of geometry shielding through positioning retaining walls, planters, and terraces around that portion of the house used as a shelter. If the house has a basement, the best location for a fallout shelter is in the corner of the basement that is deepest in the ground, with the fewest windows.

**DISTANCE EFFECT:** A simple way to lower the amount of fallout gamma radiation that reaches a shelter area is to keep as much distance as possible between the shelter area and the roof and yard areas that become contaminated with fallout radiation. The roof of a two-story house is farther away from the basement than the roof of a one-story house. Two-story houses with basement fallout shelters benefit from the distance effect requiring less overhead barrier shielding than one-story houses with basement fallout shelters. In houses built slightly above grade without basements, the fallout shelter should be located near the center.

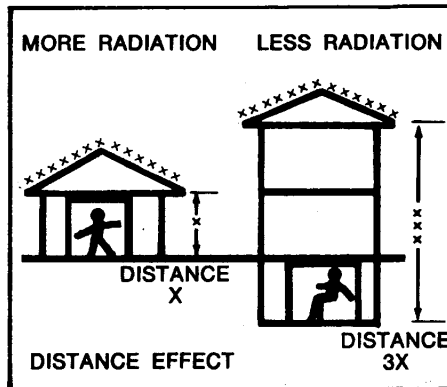

**TIME EFFECT:** Fallout gamma radiation decreases rapidly with time, a phenomenon known as "time effect." Moving from a heavily shielded and possibly small area to a larger area with less shielding allows occupants

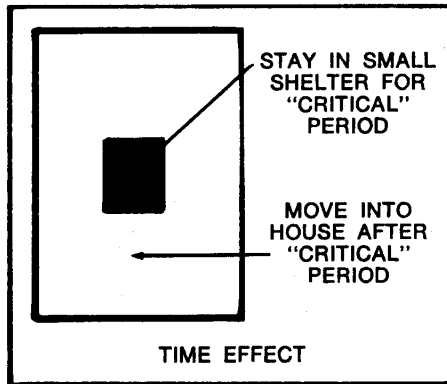

to take advantage of the time effect. The first 24 to 48 hours after a nuclear attack are the most critical, because during this period the intensity is highest. Fallout shelter building cost can be lower if the time effect is taken into consideration. This is especially true for houses that are built above grade where it is more practical to construct small shelters. These small, heavily shielded areas would be crowded until radioactive intensity decreases, but families could move into more spacious quarters with less shielding when so advised by the local civil defense authorities.

The critical period for remaining in a shelter can be determined only by the intensity of fallout and radiation at a given location. In most cases, however, the radiation intensity will have decreased enough within from one to two weeks, so that one probably could leave the house safely.

## RADIATION SHIELDING PRINCIPLES SUMMARY

### DO

1. Build a normal use space so it can be used as a shelter.
2. If a house is built into a hillside, put the shelter on the side of the house that extends into the hill.
3. If the house is a split-level design with a basement or subbasement, place the shelter in the lowest basement. If there is no basement, consider putting the shelter in that portion of the house with the most mass of materials overhead and around.
4. Put shelter in basement whenever possible and try to use a corner location; next best would be along a side wall; and third best, the middle of the basement.
5. If shelter is above grade, as is necessary in houses on a slab or crawl-space, try to locate the shelter near the middle of the house and keep the shelter small.
6. Anchor roof members, wall framing, and floor joists to the foundation

- with adequate framing anchors or reinforcing rods as required.
7. Use planters, terraces, or yards sloped from the house to provide barrier shielding at little or no increase in cost. Dirt against foundation is also effective.
8. Build shelters in those areas of the house that preferably do not have windows. If windows are present, those with high sills provide more shielding than those with low sills. Small windows are preferable to large windows in or near the shelter.
9. Take advantage of any material that will provide barrier shielding. The amount of weight in pounds per square foot of wall or ceiling is more important than the type of material being used.
10. Fill cavity walls with sand or gravel to add barrier shielding.
11. Use right angle turns at shelter entrance and baffles or screens over openings to provide barriers at these normally low mass areas.

12. Use indirect lighting or small skylights to illuminate shelter areas attractively.
13. Bricks, masonry block, sandbags, or other mass are effective for covering window or door areas in event of a nuclear attack.

### DON'T

1. Don't build a fallout shelter above grade in a house that has a basement. It is less expensive to achieve a PF 40 in a basement.
2. Don't build shelters adjacent to walls with large windows.
3. Don't advise buyers that family members must stay in shelters all the time. When radiation intensity decreases, it is safe to leave the shelter for other parts of the house for short periods.
4. Don't add large amounts of mass to ceilings and floors without first checking to see if the framing will carry the increased load. Shoring may be required in some areas.

**1. ANCHORING ROOF TRUSS OR RAFTER TO WALL FRAMING**

Roof trusses or rafters anchored directly to stud framing are less likely to lift off walls due to wind action. Install framing anchors according to engineering design and manufacturer's instructions.

**2. ANCHORING WALL FRAMING TO FOUNDATION using steel straps**

Steel straps nailed to studs and fastened to the sill transfer uplifting forces on the wall to the sill. To secure the sill to the concrete foundation, set 1/2-inch-diameter anchor bolts 16 to 24 inches on center. Straps may be 1 1/2-inch-wide and 18-gage-thick galvanized steel. Use five 8<sup>d</sup> common wire nails per stud for attaching straps to wall.

**3. ANCHORING WALL FRAMING TO FOUNDATION using sheathing**

Wall sheathing extending below the band joist and nailed to the sill provides a means of anchoring walls to sills. Secure the sill to the foundation as mentioned in No. 2 above.

**4. ANCHORING ROOF TRUSSES TO BOND BEAMS**

For masonry wall construction, roof trusses or rafters can be anchored to walls and walls to footings as shown. Follow manufacturer's instructions for installing and nailing roof framing anchor.

