

## SELF-AID/BUDDY-AID

IS0821  
EDITION 100

UNITED STATES ARMY MEDICAL DEPARTMENT CENTER AND SCHOOL  
FORT SAM HOUSTON, TEXAS

15 Credit Hours

Edition Date: JULY 2000

### SUBCOURSE OVERVIEW

Interschool Subcourse 0821, Self-Aid/Buddy-Aid, contains instructions for performing the 15 self-aid/buddy-aid (first aid) tasks that all soldiers are required to know. All of the tasks contain important, lifesaving information.

Terminal objectives for the subcourse are given below.

**TASK:** Practice individual preventive medicine countermeasures

**CONDITIONS:** You are a soldier deployed to a unit in the field. Necessary equipment and materials: water, food, uniforms, replacement clothing, standard military skin extended-duration arthropod repellent lotion, permethrin clothing repellent, malaria pills, soap, mosquito bednet, iodine tablets, canteen, covered container, plastic bags, earplugs, foot powder, talcum powder, razor, toothbrush, dental floss, condoms, and an entrenching tool.

**STANDARDS:** Preventive medicine measures are applied to protect against: cold, heat, arthropod bites and arthropod-borne diseases, water-borne diseases, food-borne diseases, hearing loss, skin infections, sexually-transmitted diseases (STD), acquired immunodeficiency syndrome (AIDS), foot problems and practice oral hygiene, disposal of waste, and Army tobacco use rules.

**TASK:** Evaluate a casualty.

**CONDITIONS:** A soldier exhibits signs and/or symptoms of an injury.

**STANDARDS:** The soldier was correctly evaluated in the correct sequence of steps. All injuries and/or conditions were identified. The casualty was immobilized if a neck or back injury is suspected.

**TASK:** Administer appropriate first aid to a casualty.

**CONDITIONS:** A soldier exhibits signs and/or symptoms of an injury.

**STANDARDS:** Correct and appropriate first aid was given to the injured casualty The first aid was correct, complete, and done in the proper sequence of steps without causing further harm to the casualty.

**TASK:** Transport a casualty.

**CONDITIONS:** You have evaluated and given first aid to a casualty. You need to move the casualty to get further medical aid. There may or may not be other soldiers to help. Necessary equipment and materials: two pistol belts or rifle slings or improvised material that will not cut or bind the casualty (cravat bandages or litter straps), poncho, shirts or jackets, and poles or tree limbs.

**STANDARDS:** The casualty was transported using an appropriate carry without dropping or causing further unnecessary injury to the casualty.

<b>Task Number</b>	<b>Task Title/Lesson Title</b>	<b>Lesson</b>
081-831-1053	Practice individual preventive medicine countermeasures.....	2
081-831-1000	Evaluate a casualty.....	3
081-831-1044	Perform first aid for a nerve agent ..... .....	
	4	
081-831-1003	Perform first aid to clear an object stuck in the throat of a conscious casualty ..... .....	
	5	
081-831-1042	Perform mouth-to-mouth resuscitation ..... .....	
	6	
081-831-1032	Perform first aid for bleeding of an extremity.....	7
081-831-1026	Perform first aid for an open chest wound.....	8
081-831-1025	Perform first aid for an open abdominal wound.....	9
081-831-1033	Perform first aid for an open head wound.....	10
081-831-1005	Perform first to prevent or control shock.....	11
081-831-1034	Perform first aid for a suspected fracture.....	12
081-831-1007	Perform first aid for burns.....	13
081-831-1008	Perform first aid for heat injuries.....	14
081-831-1045	Perform first aid for cold injuries.....	15
081-831-1046	Transport a Casualty.....	16



## TABLE OF CONTENTS

<b>Section</b>	<b>Page</b>
TITLE PAGE.....	i
TABLE OF CONTENTS.....	iii
ADMINISTRATIVE INSTRUCTIONS.....	xii
GRADING AND CERTIFICATION INSTRUCTIONS.....	xii
<b>Lesson 1: SUBCOURSE OVERVIEW.....</b>	<b>1-1</b>
<b>Lesson 2: PRACTICE INDIVIDUAL PREVENTIVE MEDICINE COUNTERMEASURES</b> <b>.....2-1</b>	
Introduction.....	2-1
PMMs for protection against cold injuries.....	2-1
PMMs for protection against heat injuries.....	2-4
.PMMs for protection against arthropod bites and arthropod-borne diseases.....	2-6
PMMs for protection against water-borne and food-borne diseases.....	2-
10	
PMMs for protection against hearing loss.....	2-
12	
PMMs for prevention of skin infections.....	2-
12	
PMMs for care of the feet.....	2-
12	
PMMs for oral hygiene.....	2-
13	
PMMs for protection against respiratory diseases.....	2-
13	
PMMs to follow for protection against sexually transmitted	

	diseases (STD).....	2-
	14	
15	PMMs for human waste disposal.....	2-
15	PMMs for prevention of tobacco use injuries.....	2-
17	Practice exercises.....	2-

**Lesson 3: EVALUATE A CASUALTY.....**  
**.....3-1**

	Introduction.....	3-1
	Evaluate and perform needed buddy-aid procedures.....	3-2
	Check for hazards.....	3-2
	Check casualty for responsiveness.....	
	3-3	
	Check casualty for breathing difficulties.....	
	3-3	
	Check for bleeding.....	
	3-4	
	Check for shock.....	
	3-4	
	Check for fractures.....	
	3-5	
	Check for burns.....	
	3-6	
	Check for heat injury.....	3-6
	Check for cold injury.....	3-6
	Check for head injury.....	
	3-7	
	Seek medical aid.....	
	3-7	

	Monitor the casualty.....	3-8
	Practice exercises.....	3-9
<b>Lesson 4:</b>	<b>PERFORM FIRST AID FOR A NERVE AGENT INJURY.....</b>	<b>4-1</b>
	<b>Section I. Administer Nerve Agent Antidote to Self (Self-Aid).....</b>	<b>4-2</b>
	Introduction.....	4-2
	Take pyridostigmine bromide pretreatment tablets.....	4-2
	Identify when protective measures are to be initiated.....	4-5
	Identify early signs and symptoms of nerve agent poisoning.....	4-6
	Put on your protective mask.....	4-6
	Select injection site.....	4-7
	Administer one nerve agent antidote kit.....	4-8
12	Decontaminate your skin.....	4-
13	Upgrade MOPP and seek aid.....	4-
	<b>Section II. Administer First Aid to a Nerve Agent Casualty (Buddy-Aid).....</b>	<b>4-</b>
13	Introduction.....	4-
	Identify signs of severe nerve agent poisoning.....	4-14
14	Mask the casualty.....	4-
16	Administer nerve agent antidote kits.....	4-
20	Administer CANA injection.....	4-

21	Decontaminate the casualty's exposed skin.....	4-
23	Practice exercises.....	4-
<b>Lesson 5:</b>	<b>PERFORM FIRST AID TO CLEAR AN OBJECT STUCK IN THE THROAT OF A CONSCIOUS CASUALTY.....</b>	<b>5-1</b>
	Introduction.....	5-1
	Recognize a person with an airway obstruction.....	5-2
	Evaluate the blockage.....	5-2
	Determine what actions are needed.....	5-3
	Administer abdominal thrusts.....	5-4
	Administer chest thrusts.....	5-5
	Practice exercises.....	5-7

<b>Lesson 6:</b>	<b>PERFORM MOUTH-TO-MOUTH RESUSCITATION.....</b>	<b>6-1</b>
	Introduction.....	6-1
	Check for responsiveness.....	6-2
	Position the casualty for mouth-to-mouth resuscitation... 6-2	
	Open the casualty's airway.....	6-2
	Check for breathing.....	6-4
	Initiate mouth-to mouth resuscitation.....	6-5
	Perform finger sweep, if needed.....	6-8
11	Perform abdominal thrusts, if needed.....	6-
12	Perform chest thrusts, if needed.....	6-
14	Continue mouth-to-mouth resuscitation.....	6-
15	Monitor the casualty.....	6-
16	Practice exercises.....	6-
<b>Lesson 7:</b>	<b>PERFORM FIRST AID FOR BLEEDING OF AN EXTREMITY.....</b>	<b>7-1</b>
	Introduction.....	7-1
	Expose the wound.....	7-2
	Apply and secure a field dressing.....	7-3
	Apply manual pressure.....	7-5
	Elevate the wound.....	7-5
	Apply a pressure dressing.....	7-6
	Tourniquet.....	7-8



	Gather material for making a tourniquet.....	7-8
10	Apply a tourniquet to a wound.....	7-
12	Apply a tourniquet to an amputation.....	7-
13	Mark the casualty.....	7-
14	Practice exercises.....	7-
<b>Lesson 8:</b>	<b>PERFORM FIRST AID FOR AN OPEN CHEST WOUND.....</b>	<b>8-1</b>
	Introduction.....	8-1
	Identify signs and symptoms of an open chest wound.....	8-2
	Seal and dress an open chest wound.....	8-2
	Position a casualty with an open chest wound.....	8-7
	Monitor a casualty with an open chest wound.....	8-7
	Practice exercises.....	8-8
<b>Lesson 9:</b>	<b>PERFORM FIRST AID FOR AN OPEN ABDOMINAL WOUND.....</b>	<b>9-1</b>
	Introduction.....	9-1
	Position a casualty with an open abdominal wound.....	9-1
	Dress an open abdominal wound.....	9-2
	Monitor a casualty with an open abdominal wound.....	9-5
	Practice exercises.....	9-6
<b>Lesson 10:</b>	<b>PERFORM FIRST AID FOR AN OPEN HEAD WOUND.....</b>	<b>10-1</b>

1	Introduction.....	10-
1	Identify signs and symptoms of open and closed head injuries...	10-
	Determine level of consciousness.....	
	10-2	
	Position a casualty with a head injury.....	
	10-2	
	Expose the wound.....	
	10-4	
	Apply a dressing to the wound on the head.....	
	10-4	
5	Secure a dressing to the forehead.....	10-
6	Secure a dressing to the top of the head.....	10-
8	Secure a dressing to the cheek.....	10-
	Monitor a casualty with a head injury.....	
	10-10	
	Practice exercises.....	
	10-11	
<b>1</b>	<b>Lesson 11: PERFORM FIRST AID TO PREVENT OR CONTROL SHOCK.....</b>	<b>11-</b>
1	Introduction.....	11-
2	Identify the signs and symptoms of shock.....	11-
	Position the casualty to prevent/control shock.....	
	11-2	
	Take additional measures to prevent /control shock.....	
	11-4	

Practice exercises.....  
11-6

**Lesson 12: PERFORM FIRST AID FOR A SUSPECTED FRACTURE..... 12-1**

1 Introduction..... 12-

2 Identify signs and symptoms of a fractured spine..... 12-

3 Immobilize a fractured spine..... 12-

5 Identify signs and symptoms of a fractured arm or leg..... 12-

Prepare the casualty prior to splinting .....  
12-5

Prepare the splint.....  
12-7

Apply the splint.....  
12-8

Apply a sling to a fractured arm.....  
12-12

Apply a swathe to a fractured arm.....  
12-15

Practice exercises.....  
12-16

<b>Lesson 13: PERFORM FIRST AID FOR BURNS.....</b>	<b>13-</b>
1	
1	Introduction..... 13-
2	Classify burn as to type..... 13-
	Put out flames.....
	13-3
3	Remove a casualty from electrical current..... 13-
5	Remove chemicals that cause burns..... 13-
6	Treat radiant energy (laser) burns of the eye..... 13-
7	Treat skin burns..... 13-
9	Practice exercises..... 13-
<b>Lesson 14: PERFORM FIRST AID FOR HEAT INJURIES.....</b>	<b>14-</b>
1	
1	Introduction..... 14-
	Identify signs and symptoms of heat cramps.....
	14-1
2	Identify signs and symptoms of heat exhaustion..... 14-
3	Identify signs and symptoms of heatstroke..... 14-
3	Treat heat cramps..... 14-
	Treat heat exhaustion.....
	14-4

4	Treat heatstroke.....	14-
	Practice exercises.....	
	14-6	
<b>1</b>	<b>Lesson 15: PERFORM FIRST AID FOR COLD INJURIES.....</b>	<b>15-</b>
1	Introduction.....	15-
	Identify signs and symptoms of chilblain/frostnip.....	
	15-2	
	Identify signs and symptoms of frostbite.....	
	15-2	
	Identify signs and symptoms of immersion foot/trench foot.....	
	15-3	
	Identify signs and symptoms of snowblindness.....	
	15-4	
	Identify signs and symptoms of hypothermia.....	
	15-4	
weather)	Identify signs and symptoms of dehydration (cold weather).....	15-5
	Treat chilblain/frostnip.....	
	15-6	
	Treat frostbite.....	
	15-6	
	Treat immersion foot/trench foot.....	
	15-8	
	Treat snow blindness.....	
	15-8	
	Treat for hypothermia.....	
	15-9	
	Treat dehydration (cold weather).....	
	15-9	

Practice exercises.....  
15-11

**Lesson 16: TRANSPORT A CASUALTY.....**  
.....**16-1**

Introduction.....  
16-1

**Section I. One-man Carries..... 16-**

2

Choose the appropriate method to move a casualty on  
the battlefield.....  
.....16-2

Choose an appropriate one-man carry.....  
16-2

Position a casualty.....  
16-3

Raise a casualty to a standing position.....  
16-4

Perform the fireman's carry.....  
16-7

Perform the support carry.....  
16-9

Perform the arms carry.....  
16-9

Perform the saddleback carry.....  
16-10

Perform the pack-strap carry.....  
16-11

Perform the pistol-belt carry.....  
16-12

Perform the pistol-belt drag.....  
16-14

Perform the neck drag..... 16-15

Perform the cradle drop drag..... 16-16

18

**Section II. Two-man Carries..... 16-**

Move a casualty using the two-man fore-and-aft carry.... 16-18

Move a casualty using the two-man support carry..... 16-19

Move a casualty using the two-man arms carry..... 16-20

Move a casualty using the two-hand seat carry..... 16-23

Move a casualty using the four-hand seat carry..... 16-23

25

**Section III. Litter Carry..... 16-**

Make an improvised pole and poncho litter..... 16-25

Make an improvised pole and jacket litter..... 16-25

Make an improvised pole and sack litter..... 16-26

Make an improvised blanket litter..... 16-27

Evacuate a casualty by litter..... 16-27

Practice exercises..... 16-30

**APPENDIX**

Answers to practice exercises  
A-1

**EXAMINATION.....**  
**.....EXAM-1**

Student Comment Sheet



## **ADMINISTRATIVE INSTRUCTIONS**

### **SUBCOURSE CONTENT**

This subcourse presents the 15 self-aid/buddy-aid (first aid) and soldier health maintenance (preventive medicine) tasks for which all soldiers are responsible. Each lesson (other than this lesson) covers one task.

### **SUPPLEMENTARY REQUIREMENTS**

**Materials Needed.** You must furnish a No. 2 pencil to be used in marking the computer-graded examination response sheet furnished with this subcourse.

**Supervisory Assistance.** There are no supervisory requirements for completion of this subcourse.

**References.** No supplementary references are needed for this subcourse.

### **SUGGESTED STUDY PROCEDURES**

After reading a lesson, work the lesson exercises at the end of the lesson. Mark your responses in this booklet. Refer to the lesson text as needed.

When you have completed the lesson exercises, compare your answers with the solution sheet following the lesson exercises. For each exercise answered incorrectly, reread the material referenced for that exercise.

Complete each lesson before proceeding to the next.

After you have completed all of the lessons and lesson exercises, complete the examination. We suggest that you mark your answers on the examination pages, then transfer your responses to the computer-graded response sheet. Refer to the lessons as needed. Double check your responses.

As you study this subcourse, write down comments or criticism on the student comment sheet located at the end of this subcourse. Remove, fold, tape, and mail the comment sheet after you complete the examination. (Remember: The comment sheet goes to the Academy of Health Sciences; the examination response sheet goes to the Army Institute for Professional Development.) If you wish a response from the Academy, please write a separate letter. Be sure to include your name, rank, social security number, and return address. Mail your letter to:

Academy of Health Sciences  
Multimedia Development Branch  
ATTN: MCCS-HLD Team A  
2250 Stanley Road (Room 326)  
Fort Sam Houston, TX 78234-6130

### **GRADING AND CERTIFICATION INSTRUCTIONS**

#### **INSTRUCTIONS TO THE STUDENT**

This subcourse has a multiple-choice examination. The examination is comprehensive, covering all 15 lessons. You must score a minimum of 70 percent on this examination in order to satisfactorily complete this subcourse. Record your responses to the

examination items on the enclosed ACCP examination response sheet. Use a No. 2 pencil to mark the response sheet. After completing the examination, place the answer sheet in the self-addressed envelope provided and mail it to the Army Institute for Professional Development (IPD) for scoring. IPD will send you a copy of your score. Fifteen credit hours will be awarded for successful completion of this subcourse.

### **CLARIFICATION OF TRAINING LITERATURE TERMINOLOGY**

When used in this publication, words such as "he", "him," "his," and "men" are intended to include both the masculine and feminine genders unless specifically stated otherwise or when obvious in context.

This subcourse is approved for resident and correspondence course instruction. It reflects the current thought of the U.S. Army Medical Department Center and School (AMEDDC&S) and conforms to printed Department of the Army doctrine as closely as currently possible. Development and progress render such doctrine continuously subject to change.

THIS PAGE INTENTIONALLY LEFT BLANK

## LESSON 1 SUBCOURSE OVERVIEW

### INTRODUCTION

Self-aid is the emergency care that an injured or sick person gives to himself or herself. Buddy-aid is the emergency care that one person gives to another person. The combination of self-aid and buddy-aid is usually referred to as first aid. First aid is emergency care given by nonmedical personnel. Medical care refers to care given by medical personnel such as the combat medic, physician assistant, or physician.

### SUBCOURSE CONTENT

This subcourse presents the 15 self-aid/buddy-aid (first aid) and soldier health maintenance (preventive medicine) tasks for which all soldiers are responsible. Each lesson (other than this lesson) covers one task.

Lessons 2 deals with preventive measures. While not actually emergency care procedures, following these preventive measures will help to keep you from becoming ill and from suffering heat and cold injuries. Historically, disease and environmental injuries have resulted in greater loss of manpower than actual combat.

Lessons 3 through 16 give procedures for evaluating, treating, and evacuating a casualty. Although they are written as buddy-aid procedures, the procedures can also be used for self-aid. The lessons are presented in the general sequence for evaluating a casualty and treating his injuries.

**NOTE:** You will see the terms "sign" and "symptom" several times in this booklet. A sign is anything that you can tell about another person's condition by using your own senses. For example, you can see a wound, hear breathing difficulty, and feel that a person has a fever by touching his skin. A symptom is any change from the norm which is felt by the person with the condition, but which cannot be directly sensed by another person. Examples of symptoms felt by the casualty are chest pains, nausea, and a headache. An injury can produce both signs and symptoms. If you bump your leg against a chair, for example, a bruise may develop. The bruise is a sign of injury since other people can see the bruise. The pain you feel is a symptom since other people cannot feel your pain.

### LESSON EXERCISES

This lesson has no lesson exercises.

THIS PAGE INTENTIONALLY LEFT BLANK

**LESSON 2**  
**PRACTICE INDIVIDUAL PREVENTIVE MEDICINE COUNTERMEASURES**  
**(TASK 081-831-1053)**

**TASK:**

Practice Individual Preventive Medicine Countermeasures.

**CONDITION:**

Given multiple-choice questions about preventive medicine countermeasures.

**STANDARD:**

Score 70 or more points on a 100-point comprehensive examination.

**REFERENCE:**

AR 40-5, Preventive Medicine.  
AR 600-63, Army Health Promotion.  
FM 21-10, Field Hygiene and Sanitation.  
FM 21-11, First Aid For Soldiers.

**NOTE:** Some of the task titles and information have changed and are not reflected in FM 21-11 and STP 21-1-SMCT. Refer to the Army Training Support Center, Common Core Task internet site at:  
<http://www.atsc.army.mil/dld/comcor/comcore.htm> for up-to-date task information.

**2-1. INTRODUCTION**

Preventive medicine measures (PMMs) are simple, common sense actions that any soldier can perform and must know, for protection against cold weather conditions, heat injury, insect-borne disease, intestinal disorders known as diarrhea and dysentery, and hearing loss. It is each individual's responsibility to maintain good health and use PMMs to reduce time lost due to disease and nonbattle injuries.

**2-2. PMMs FOR PROTECTION AGAINST COLD INJURIES**

Cold injuries are caused by the body losing heat faster than it can be replaced. Cold injuries are most likely to occur when an unprepared person is exposed to cold winter temperatures. Cold injuries can be painful and are sometimes fatal. A person may be unaware that he is developing cold injury until it is too late. Although cold injuries are often associated with very cold weather, preventive measures against cold are needed anytime the temperature drops to 50°F or below. Wind and moisture increase the rate

at which the body loses heat. Trench foot can occur when feet remain wet for a long period of time. Fear, fatigue, dehydration (not drinking enough water), inadequate food intake, inadequate rest, inadequate clothing, sustained contact with cold ground, and long periods of immobilization also contribute to cold injury. A person who has previously suffered from cold injuries has a higher-than-normal risk of having another cold injury.

### **Wear of the uniform**

Wear an adequate amount of properly fitting clothes as directed by your commander. The clothing should be worn in loose layers. Layering clothing allows air to be trapped inside the clothing. This trapped air helps to slow down the loss of heat produced by the body.

Loose clothing also helps to promote blood circulation. The blood carries oxygen and nutrients which cells need in order to produce heat.

When clothing becomes wet, it loses its ability to keep the body warm. One way that clothing becomes wet is by absorbing perspiration. You should, therefore, try to prevent excessive sweating whenever possible. If you have some hard work to do, remove a layer or two of clothing before starting the work in order to reduce sweating. When you have completed your work, replace the dry clothing that you removed.

Launder clothing regularly. Dirty or wet clothing adds to the cold injury process.

### **WARNING**

**Do not take off your protective chemical gear in a chemical environment.**

### **Exercise Your Muscles**

When your body performs work, heat is produced. Exercise the large muscle groups (shoulders, trunk, and legs) to produce heat and to increase blood circulation.

If your situation prevents excessive movement, change positions frequently, move your feet, wiggle your toes, and exercise your arms, hands, and fingers. Use your hands to massage and warm your face.

### **Protect your feet**

Your feet probably perspire more and are less ventilated than other parts of your body. This moisture accumulates in socks and decreases their ability to insulate your feet from the cold. Being moist and being close to the cold ground makes your feet especially susceptible to cold injury. Since your feet are more difficult to observe than other parts of your body, special care is needed to prevent cold injury.

Wear proper-fitting (not tight) boots and socks. Boots should be laced loosely so that blood circulation is not impaired. Inactive feet in damp or wet socks and boots or tightly laced boots that impair circulation are even more susceptible to injury.

Keep your socks clean and dry. Change wet or damp socks as soon as practical, usually during a rest break. Wet or damp socks can be dried by placing them inside your shirt. The heat from your body will dry the socks.

Bring at least five pair of boot socks with you.

Wash your feet daily and use foot powder.

Wear overshoes to keep your boots dry.

Avoid standing on cold, wet ground.

### **Drink and eat adequate amounts**

Many people do not drink enough fluids in cold weather, especially if it is inconvenient to drink such as during cold weather operations. Dehydration (excessive loss of body fluids) is a risk in cold weather just as it is during hot weather. Drink plenty of water, juices, and warm fluids. Do not drink alcoholic beverages. Dark-yellow urine is an indication that you are not drinking enough fluids.

Eat all of your meals. Your body needs food to produce heat energy.

Avoid drinking alcoholic beverages. Although they may make you feel warmer, the alcohol will cause your body to lose heat faster.

Do not smoke. The chemicals in tobacco result in decreased blood flow to the skin.

### **Protect your hands**

Wear your gloves or mittens (with inserts) to protect your hands and wrists. Lengthy exposure of your hands and wrists to cold will cause blood circulation to be reduced. Once the hands and wrists "stiffen," considerable time may be required for rewarming and reconditioning the hands for normal use.

Warm your hands under clothing if they become numb. You may need to remove your gloves and stick your hands beneath your uniform so that your body heat can rewarm your fingers.

Avoid coming into direct skin contact with snow, ice, bare metal, or fuel since all of these items increase heat loss.

Exercise your hands and fingers if they become tingly or numb.



## **Use the buddy system**

Many times it is easier to notice the first signs of frostbite on someone else rather than on yourself. Because of this, soldiers should watch one another's face and hands for signs of frostbite (a red or a pale, waxy area on a light-skinned soldier; a gray area on a dark-skinned soldier). If you notice signs of frostbite, have the person massage his face, put his hands under his arms for warmth, or take some other measure to counteract the frostbite.

## **2-3. PMMs FOR PROTECTION AGAINST HEAT INJURIES**

A soldier who is in good physical condition and is not injured or sick may think he has nothing to worry about when working or marching in a hot climate. This is not so. Even a healthy person can suffer heat injury. Heat injuries can be painful and, in some cases, fatal.

Heat injuries are caused by insufficient water in the body, by insufficient salt in the body, or by a combination of the two. Heat injuries can be avoided by consuming adequate amounts of water and salt, wearing clothing properly, and taking rest breaks.

### **Drink sufficient water**

The amount of water a person needs to drink depends upon the temperature and the work being done (figures 2-1 & 2-2). A person working in a hot environment should drink at least one full canteen (one quart) of cool water every hour. A person who is performing strenuous physical labor or who is working in a very hot environment should drink at least one quart of cool water every hour.

**CAUTION:** You should not drink more than 1½ quarts of water hourly or 12 quarts daily.

Drink small quantities of cool water frequently, even if you are not thirsty.

Follow your leader's instructions concerning water intake. Drink water when you are ordered to do so even if you are not thirsty.

Do not rely on thirst to remind you when to drink water. People in a hot climate seldom feel thirsty enough to replace all the water that is lost through perspiration and urination.

Refill your canteen with cool, disinfected water at every opportunity. Drink extra water before an attack or mission or before starting hard work. The excess water in your system will help to keep you physically strong and mentally alert until the situation allows you time to drink again.

A person wearing chemical protection (MOPP) gear is especially prone to heat injury and should drink plenty of water.

### Use work/rest cycles

Work and rest as your leader directs. Rest breaks give the body a chance to cool off. A soldier performing moderate work in a hot (WBGT Index 88-89.9) environment should rest about 30 minutes for each hour he works.

**NOTE:** The asterisked (\*) fluid retention information is per: "Memorandum, Policy Guidance for Fluid Replacement During Training, 29/04/98, Office of the Surgeon General.

**FIGURE 2-1. FLUID REPLACEMENT POLICY**

<b>*Fluid Replacement Policy for Warm Weather</b>							
<b>(Average acclimated soldier wearing BDU, Hot Weather)</b>							
<b>HEAT CATEGORY</b>	<b>WBGT INDEX, °F</b>	<b>Easy Work</b>		<b>Moderate Work</b>		<b>Hard work</b>	
		<b>Work/Rest</b>	<b>Water Intake Qt/hr</b>	<b>Work/ Rest</b>	<b>Water Intake, Qt/hr</b>	<b>Work/ Rest</b>	<b>Water Intake, Qt/hr</b>
1*	78 - 81.9	NL	½	NL	¾	40/20 min	¾
2	82 - 84.9	NL	½	50/10 min	¾	30/30 min	1
3	85 - 87.9	NL	¾	40/20 min	¾	30/30 min	1
4	88 - 89.9	NL	¾	30/30 min	¾	20/40 min	1
5**	>90	50/10 min	1	20/40 min	1	10/50 min	1

\*NL = no limit to work time per hour.

**FIGURE 2-2. CATEGORIES OF WORK**

<b>*Examples of Categories of Work</b>		
<b>Easy Work</b>	<b>Moderate Work</b>	<b>Hard Work</b>
<ul style="list-style-type: none"> <li>• Weapon maintenance</li> <li>• Walking on hard surfaces at 2.5 mph, ≤ 30 lb. load.</li> <li>• Manual of arms.</li> <li>• Marksmanship training.</li> <li>• Drill and Ceremony</li> </ul>	<ul style="list-style-type: none"> <li>• Walking on loose sand at 2.5 mph, no load.</li> <li>• Walking on hard surface at 3.5 mph, &lt; 40 lb. Load.</li> <li>• Calisthenics</li> <li>• Patrolling.</li> <li>• Individual movement techniques. i.e. low crawl, high crawl.</li> <li>• Defensive position construction.</li> <li>• Field assaults.</li> </ul>	<ul style="list-style-type: none"> <li>• Walking on loose sand at 2.5 mph with load.</li> <li>• Walking on hard surface at 3.5 mph, ≥ 40 lb. Load</li> </ul>

Rest breaks should be taken only if the tactical situation allows time to stop and rest.

If possible, work and rest in a shaded area.

**Eat meals to replace salt**

A person who eats regular meals should get enough salt to replace the salt lost through perspiration. You should eat three full meals each day even if you are not hungry. You should not take additional salt (salt tablets, salty water, etc.) except when directed by medical personnel.

**Protect yourself from exposure**

Wear clothing to protect your skin from solar radiation (sunlight). Unprotected skin may develop serious sunburn. Using barrier creams and lotions may help protect the skin. Some situations may not permit the use of the lotions and creams.

When possible, clothing should be loose fitting, especially at the neck, wrists, and legs. This allows for better air circulation which helps to cool off the body. Soldiers wearing chemical protective overgarments are especially prone to heat injury because the protective clothing traps much of the heat energy produced by the body.

**2-4. PMMS FOR PROTECTION AGAINST ARTHROPOD BITES AND ARTHROPOD-BORNE DISEASES**

**NOTE:** An arthropod is a segmented invertebrate of the phylum arthropoda that includes *insects, arachnids, crustaceans, centipedes and millipedes*. Some examples are given at figure 2-3.

FIGURE 2-3. EXAMPLES OF BITING INSECTS

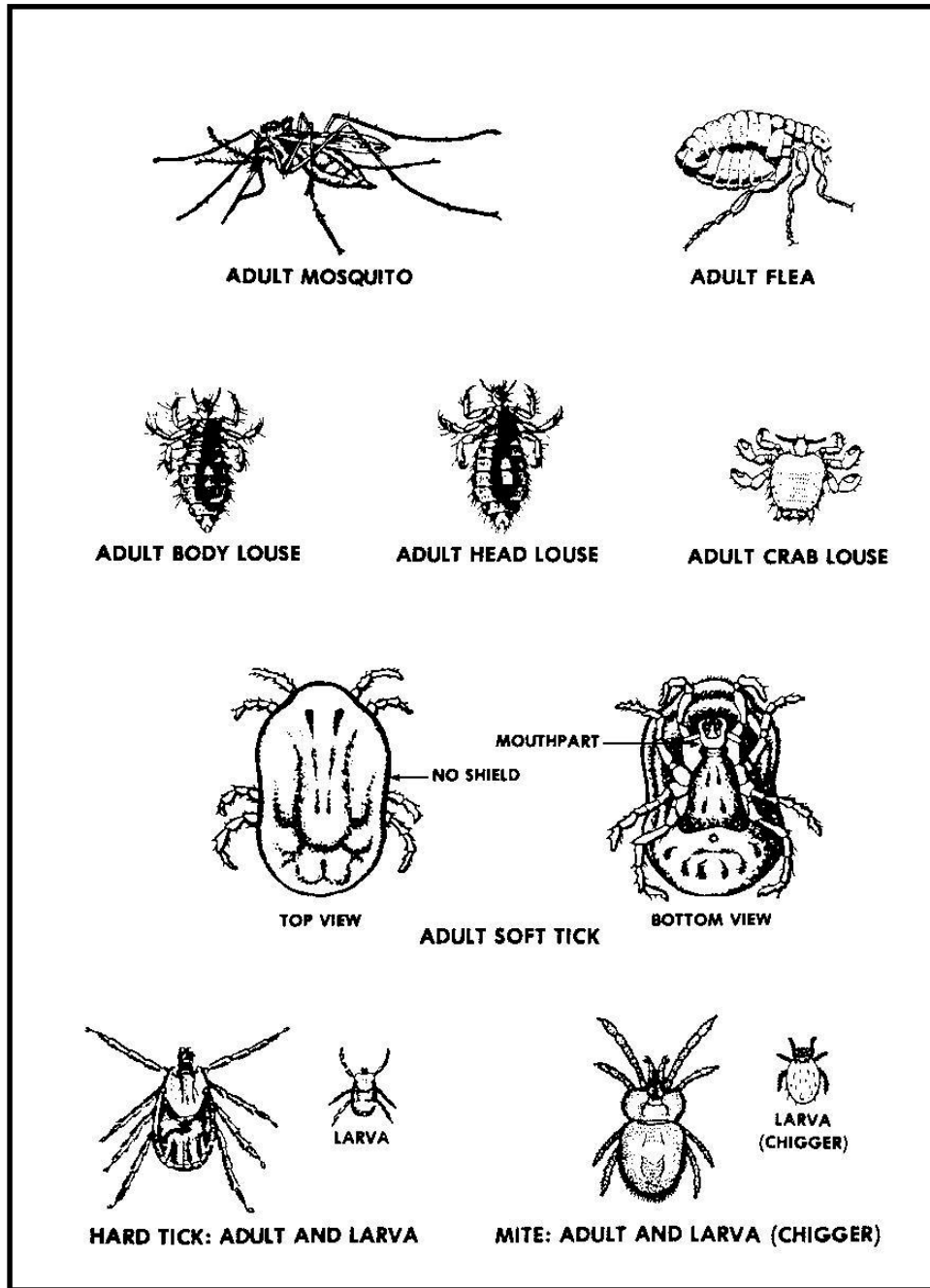

**NOTE:** The Department of Defense Arthropod Repellent System -- DEET on the skin + permethrin on the uniform + wear of the uniform = total protection.

"Arthropod-borne diseases" refers to diseases transmitted by insects (such as mosquitoes, lice, and fleas) and by certain other animals that closely resemble insects (such as ticks and mites). Examples of communicable arthropod-borne diseases include malaria (transmitted by mosquitoes), yellow fever (transmitted by mosquitoes), typhus (transmitted by lice), Rocky Mountain spotted fever (transmitted by ticks), and plague (transmitted by fleas).

### **Apply insect repellent**

**NOTE:** Read instructions that accompany the repellents before use.

One of the best ways to keep the insects from transmitting diseases to you is to keep them away by using arthropod repellent. Some guidelines are given below.

Apply the extended-duration arthropod repellent skin lotion to all exposed skin except your eyes, lips and other sensitive skin. Also apply the repellent two inches under the edges of the battle dress uniform (BDU). This includes the wrists, ankles, and waistline.

Blouse your uniform inside your boots and apply permethrin clothing repellent where they meet.

**NOTE:** Use the IDA (most effective) or aerosol treatments.

Apply permethrin clothing repellent to all areas of the uniform that fit tightly enough for mosquitoes to bite through. This includes the upper back, buttocks, and knees. Do not apply the clothing repellent while wearing the uniform and do not apply to undergarments.

Reapply repellent as soon after stream crossings as practical since the water will dilute and wash away much of the repellent on your clothing.

Reapply repellent every 6 hours if you are performing strenuous work.

### **Take malaria pills**

If you are in an area where malaria may be a problem, you will be given medication to take. You will be told how many to take at one time and when to take them (usually at mealtime). This medication, commonly referred to as "malaria pills," will help to protect you from the full effects of the disease, but does not make you immune to malaria. If you should have the pills but have not been issued them, contact your NCO.

### **Wear your uniform properly**

Wear your uniform as your commander directs.

Wear your headgear to protect the top of your head.

Roll your sleeves down.

Tuck your shirt and undershirt in at the waist.

Blouse your uniform inside your boots.

Lace your boots completely.

Repair any tears or holes in your uniform.

### **Keep yourself clean**

Wash yourself daily if the tactical situation permits. Pay special attention to hairy regions of the body, including armpits and groin, where insects may deposit their eggs. Sometimes a shower will be available. At other times creeks, streams, or individual temporary showers will have to be used.

Use a buddy-system to examine each other for the presence of ticks, lice, fleas, and mites. The buddy can look at hard to see areas such as the back of the head.

Seek medical help if an insect problem exists. Insecticide powder, cream, or shampoo may be prescribed by medical personnel to eliminate the insects.

### **Keep your uniform clean**

Your uniform should be washed at least once each week. Use the supporting laundry unit if possible. If one is not available, scrub the uniform with soap and water. A good washing will eliminate ticks and mites that are on the uniform. Lice eggs in the seams of your uniform can be killed if the uniform is washed in water heated to at least 140°F.

If ticks, mites, or lice are a problem, dust your clothing with insecticide powder to kill these pests. Pay special attention to the seams of your uniform. Seams may contain eggs, which may hatch if not dusted. The powder can be applied to delouse infected clothing and as a louse prevention measure to keep clothing from becoming infested.

Insecticide powder can be obtained from the unit's field sanitation team.

### **Protect yourself at night**

When you rest at night, no one wants to be bothered, especially by insects. Your sleep is important. Protecting yourself against biting arthropods at night includes the use of your bednet and the use of insect spray inside the bednet.

The proper use of the bednet is important. Suspend the bednet above the sleeping area and tuck the edges of the net under the sleeping pad or bag. You should treat the net with permethrin clothing repellent and spray the interior space with d-phenothrin

(or other approved spray) aerosol spray insecticide. Avoid breathing vapors from the spray.

## **2-5. PMMS FOR PROTECTION AGAINST WATER-BORNE AND FOOD-BORNE DISEASES**

Food-borne and water-borne diseases can cause diarrhea or dysentery. Diarrhea refers to the frequent passage of abnormally watery bowel movements. Dysentery is a term applied to a number of intestinal diseases characterized by inflammation of the intestines, abdominal pain, and bowl movements containing blood and mucus. Diarrhea and dysentery are often caused by, but not limited to, disease organisms found in human and animal feces. These organisms enter the body through the consumption of water or food that has been contaminated with feces. Water in a stream or lake can be contaminated by untreated sewage. Food can be contaminated by fecal material on a person's hands or under his fingernails.

### **Disinfect your drinking water.**

Whenever possible, obtain your drinking water from sources that have been approved for consumption. In the field, however, you may have to obtain water from other sources. Always assume that water from an unapproved source is contaminated and must be disinfected before drinking. The following procedures are used when disinfecting water with iodine tablets.

Fill your canteen with the cleanest, clearest water available.

Check the color of the iodine tablets in the bottle. The tablets should be uniformly steel gray in color. Discard any tablet which is not gray in color.

Add two tablets to your one-quart canteen of water. If you are using a two-quart canteen, add four tablets.

Replace the cap on the canteen and wait five minutes for the tablets to dissolve.

Shake the canteen to mix the dissolved tablets and the water.

Loosen the cap on the canteen.

Turn the canteen upside down and allow the water to flow over the threads of the cap and canteen neck to disinfect them.

Turn the canteen upright and tighten the cap on the canteen.

Wait an additional 30 minutes before drinking the water. The additional time is needed to ensure that the iodine has sufficient time to kill all of the harmful microorganisms in the water.

There are other methods for purifying water, such as chlorine ampoules, tincture of iodine, and common household bleach. If none of the purifying agents are available, **boil** the water for five to ten minutes.

### **Obtain food and drink from approved sources.**

Obtain food, drink, and ice only from sources approved by the local military medical authority. Do not buy food and drink from unapproved civilian sources. These sources almost never meet the high standards of the medical authority. Obtaining ice from an unapproved source is particularly dangerous because few civilian vendors disinfect their water before freezing it. As the ice melts in your glass or mouth, bacteria in the ice will become active again.

If you must eat in a local establishment, eat only hot, cooked food. Again, only eat at the approved establishments.

The food product container condition plays a part in the maintenance of the food. Inspect all cans and food packets prior to use. Discard cans with leaks or bulges. Discard food packets with visible holes or obvious signs of deterioration. Do not eat food or drink beverages prepared in galvanized containers.

### **Wash your hands**

Wash your hands after using the latrine. Pay special attention to cleaning under your fingernails.

Wash your hands just before and after you eat. Also, wash your hands after smoking. Your hands may have collected germs from many sources (the ground, dust in the air, the latrine door, the hands of your friends, your own nose, your weapon, ammunition, etc.). You should spend at least 30 seconds washing your hands with soap and water. Water from your canteen can be used if other water is not available.

Handwashing devices should be set up near latrines and dining areas.

### **Dispose of food waste properly**

Waste disposal is important for the protection of soldiers' health in the field. Intestinal diseases are usually spread through contact with infectious organisms, which can be spread by flies. A number of precautions that can be taken are:

- Use covered containers if available.
- Use plastic bags in the event you have a dumpster-type receptacle or regular waste pick-up.
- Bury your food waste if other options are not available.



## **2-6. PMMs FOR PROTECTION AGAINST HEARING LOSS**

You may not be able to curtail the noise in your work environment, but you can take some protective measures to prevent damage to your hearing.

Soldiers should avoid high noise areas if possible. If noise avoidance is not possible you should take precautions like using protective devices: earplugs, ear canal caps, earmuffs over earplugs, vehicle headgear such as helicopter crew helmets and armored vehicle crew helmets.

## **2-7. PMMs FOR PROTECTION AGAINST SKIN INFECTIONS**

We have heard how important keeping clean is to fighting disease. Well, it is no less important in preventing skin infections. Take a full bath or shower at least once every week. If showers or baths are not available, you should use a washcloth daily to wash your genital area, your armpits, your feet, and any other areas where you sweat or which become wet. These areas include the thighs and, for females, under the breasts. Use of perfumed soaps or feminine deodorants in the field could cause irritation.

Keep your skin dry. After bathing or as needed, use foot powder on your feet, especially if you have had fungal infections in the past. Talcum powder is recommended for areas where wetness is a problem. If talcum powder is not available, use cornstarch as a substitute.

After a bath or shower, you should change to clean clothing. The clean uniforms should fit a little loose. Loose-fitting uniforms allow for better ventilation and blood circulation. Wear the proper clothing for the environment. Nylon and silk-type undergarments are not suitable, especially in hot weather. Cotton undergarments are more absorbent, and they allow the skin to dry.

Males should shave facial hair often enough to allow a tight fit of the protective mask.

## **2-8. PMMs FOR CARE OF THE FEET**

Your feet play a very important role in your ability to complete your mission. Technology has made many changes in our life, but keeping your feet in good condition is as important today as it was years ago.

Before you go on a movement, you must take care of your feet by wearing footgear that is correctly fitted. Wearing good clean socks and using foot powder will go a long way to protecting your feet. If blisters, pressure spots, or infections do occur, treat them before you go on the movement.

A bad time to have problems with your feet is during the movement. Actions to take during the movement to prevent foot problems are as follows:

- Keep your feet as dry as possible.
- Change your socks if they become damp or wet.
- Socks can be dried by putting them under your shirt around your waist.
- Try to relieve pressure spots on the feet by adjusting your gear.
- Dust your feet with foot powder once or twice daily.
- Elevate your feet while resting to help reduce congestion and swelling.
- Take care of blisters--wash with soap and water and seek medical treatment.

## **2-9. PMMs FOR ORAL HYGIENE**

Brushing your teeth after each meal, using dental floss, and rinsing your mouth with potable water are all good oral hygiene practices. You can continue to have good oral hygiene while in the field. You can brush your teeth even if you don't have toothpaste. Toothpaste helps but it is not a necessity.

## **2-10. PMMs FOR PROTECTION AGAINST RESPIRATORY DISEASES**

Respiratory diseases are usually transmitted from person to person by discharges from the nose, mouth, throat, or lungs of an infected person. A person who sneezes or coughs throws many droplets into the air. These droplets carry disease germs that can be inhaled by another person. Sometimes, disease germs may exist on the ground until they come into contact with a person's bare skin or until they are stirred up and become airborne again. Examples of communicable respiratory diseases include the common cold, influenza (flu), pneumonia, and streptococcal throat infection (strep). Protect yourself from respiratory diseases by using the following guidelines.

If possible, avoid close contact with soldiers who have respiratory diseases whenever possible.

Encourage sick soldiers to go to sick call. Once the soldier is cured, he will not be able to transmit the disease to you.

Avoid using borrowed towels, caps, cigarettes, and other objects that have been handled by other people.

Provide an opening for fresh air into your fighting position, bunker, or shelter. Fresh air dilutes the contaminated air and carries much of the contamination away.

## **2-11. PMMs FOR PROTECTION AGAINST SEXUALLY-TRANSMITTED DISEASES (STD)**

STD (including HIV, the virus that causes acquired immunodeficiency syndrome (AIDS)) are infections that are transmitted through sexual contact with persons who are already infected. HIV is a disease contracted through sexual contact (homosexual or heterosexual) with an infected person or from the transfer of blood (blood transfusion, used intravenous needles, etc.) from an infected person. HIV is not transmitted through casual contact such as touching.

**There is no cure for AIDS and there is no vaccination to prevent HIV infection. Soldiers must take necessary precautions to protect themselves from being infected.**

Avoiding sexual contact with persons who may have one of these infections is the surest way to avoid becoming infected. Because it is difficult to know who is infected with a STD or the HIV virus and who is not, the decision to have sex with someone should follow an estimate of the chances that the sexual partner may be infected. Persons who are more likely to be infected include those who have more than one sex partner, unprotected sex, anal sex, sex with casual partners, sex with prostitutes or their clients, or sex with partners who are HIV infected. In addition to sexual contact, the HIV virus can be spread through the practice among drug abusers of sharing needles when injecting drugs. The virus is passed from an infected person to another through the blood that contaminates the shared needles or syringes.

Using a latex prophylactic (condom) provides reasonably good protection against venereal disease for both males and females since it provides physical separation of the sex organs. There is no other practical mechanical device that will protect females from contamination by male secretions.

Urinating immediately following sexual intercourse is considered to be of some value in flushing venereal disease organisms out of the urinary tract. This applies to both males and females.

Washing the genitals thoroughly with soap and water after intercourse may reduce the probability of acquiring a venereal infection for males and females. Vaginal douching after intercourse, however, is not effective since the washing action may actually push the disease organisms further into the female organs.

Do not use injected nonprescribed drugs or permit yourself to be injected or cut with a nonsterile sharp object. Avoid tattoos and body piercing with nonsterile needles.

Alcohol often plays a role in the sexual encounter that may lead to problems at a later date. Control alcohol intake (it effects your ability to use safe sex practices).

## **2-12. PMMs FOR HUMAN WASTE DISPOSAL**

Human waste disposal is an important element in the protection of soldiers' health in the field. Intestinal diseases are usually spread through contact with infectious organisms that can be spread in human waste. The method used for disposal of human waste depends upon the military situation and the unit and its location. Waste disposal does impact upon the health of a unit's personnel and must be done correctly.

Recommended methods of disposing of human waste are as follows:

- Use the unit latrine when available. (Deep pit for extended bivouac.)
  - Use a cat-hole latrine on marches. On a march, cover the cat-hole with dirt immediately after use.
  - Use a straddle trench for 1-3 day bivouac.

## **2-13. PMMs FOR PREVENTION OF TOBACCO USE INJURIES**

The DOD has a ***smoke-free workplace policy***. The ***Army has the same policy***. There are programs established to help you and family members become tobacco-free. AR 600-63, Army Health Promotion & Tobacco Use, provides the policy and guidelines.

The leading cause of death in the United States is heart and blood vessel disease. The leading preventable cause underlying death in the U.S is tobacco use. Tobacco use is responsible for more deaths than all other causes. Heart disease, cancer, emphysema, stroke are all diseases that are linked to tobacco use. The use of tobacco can cause poor circulation, increase risk during surgery, and prolong the healing process.

Smoking effects on the health of nonsmokers (or second hand smoke as it has been called) is linked to lung cancer, asthma attacks, low birth weight, and preterm births. It is also known that children exposed to cigarette smoke have more middle ear and lower respiratory infections.

Many people have switched to using smokeless tobacco products thinking it is safer than smoking. It is well established that smokeless tobacco of all types (chew, snuff, bandits) leads to the development of heart disease, various cancers, gum recession, and bone loss around the teeth.

Cancers of the mouth and throat are particularly deforming and deadly.

A soldier's performance and health is affected by tobacco use. Tobacco use increases the likelihood of cold weather injuries, respiratory infections (to include pneumonia), and longer hospital stays after surgery, all of which decrease soldier readiness. Smoking makes it far more likely that you will be susceptible to upper respiratory infections (colds and flu). The bottom line is that tobacco use decreases readiness.

Tobacco use impacts on the soldier's ability to do the job (readiness) as follows:

- (a) Decreases night vision.
- (b) Decreases hand-eye coordination.
- (c) Decreases stamina.
- (d) Increases cold weather injuries.
- (e) Increases overall number of injuries.
- (f) Leads to addiction.

Despite the fact that people know tobacco is bad for their health and longevity and want to give it up, it is very difficult for most to do so. The physical and emotional dependence developed with tobacco use is very great. Withdrawal symptoms are unpleasant. Often tobacco users feel jittery and irritable after a certain period of time without nicotine. These are symptoms of withdrawal! We need soldiers who are alert, can concentrate on the task at hand, and who are team players, not individuals who are easily aggravated by other people or stressful situations due to their bodies' reaction to not having tobacco.

There are resources available for tobacco use cessation. Your health care provider may be able to prescribe medication to help with your cessation effort. Many of the cessation programs and materials are available through your health care facility or local preventive medicine service. There are community agencies such as the American Cancer Society (800-486-2345) or local public health department. Additionally, nicotine gum and or patches available on the economy can also help you quit using tobacco.

## PRACTICE EXERCISES LESSON 2

### Practice Individual Preventive Medicine Countermeasures

**INSTRUCTIONS:** Answer the following exercises by circling the letter of the response that best answers the question or best completes the sentence. Refer to the lesson text, if needed. After you have answered all of the exercises, check your answers against the "Solutions to Exercises" in the Appendix. For each exercise answered incorrectly, reread the lesson material referenced.

#### **PMMs for protection against cold injuries.**

1. A soldier says, "Don't worry about cold injuries when the temperature is above freezing." Is he correct?
  - a. Yes.
  - b. No, cold injuries can occur when the temperature is as high as 35°F.
  - c. No, cold injuries can occur when the temperature is as high as 40°F.
  - d. No, cold injuries can occur when the temperature is as high as 50°F.
  
2. A person who has previously suffered cold injuries needs to take \_\_\_\_\_ than normal precautions against cold.
  - a. Greater.
  - b. Less.
  
3. In cold weather, you should:
  - a. Reduce the amount of food you eat.
  - b. Exercise your muscles.
  - c. Reduce the amount of water you drink.
  - d. Increase your intake of alcoholic beverages.

4. When working in cold weather, you should:
  - a. Wear your clothing as tight-fitting as possible.
  - b. Put on extra clothing when you are going to perform strenuous work.
  - c. Wear your clothing in loose layers.
5. Which of the following is a procedure to protect your feet in cold weather?
  - a. Change your socks during rest breaks.
  - b. Do not wear overshoes.
  - c. Lace your boots tightly.
  - d. Wear five pairs of socks at one time.
6. Which of the following is/are signs of cold injury?
  - a. A red area on the face of a light-skinned individual.
  - b. A pale, waxy area on the face of a light-skinned individual.
  - c. A gray area on the face of a dark-skinned individual.
  - d. Responses a and c only are correct.
  - e. Responses a, b, and c are correct.
7. One of your hands is becoming numb. What measure can you take to prevent serious cold injury?
  - a. Remove your glove and soak your hand in gasoline or kerosene.
  - b. Remove your glove and rub your hand in the snow.
  - c. Remove your glove and put your hand under your shirt.
  - d. Keep your glove on and rub your hand in the snow.

8. Darker than normal urine is an indication that you:
  - a. Are drinking too much water.
  - b. Are not drinking enough water.
  - c. Need more salt with your meals.
  - d. Need less salt with your meals.

**PMMs for protection against heat injuries.**

9. You are preparing to attack an enemy-held position. Should you drink extra water before the attack?
  - a. Yes, the water will help you keep physically strong and mentally sharp during the attack.
  - b. Yes, the water will act as a defense against chemical agent poisoning.
  - c. No, the water will make you sluggish.
  - d. No, the water will make you more likely to be overcome by chemical agents used against you.
10. You are working very hard in a hot environment. How much water should you drink?
  - a. Enough so that you are not thirsty.
  - b. Enough so that you remain slightly thirsty.
  - c. At least one canteen (one quart) every two hours.
  - d. At least one canteen (one quart) every hour.



11. When you are working in hot weather, the loss of salt from the body can result in heat injuries. What is the best way of replacing the salt that your body loses?
- a. Taking one salt tablet for each hour that you work.
  - b. Eat table salt freely while you work.
  - c. Dissolve one packet of salt from your rations in your canteen and repeat each time you refill your canteen.
  - d. Eat three full meals each day.
12. Which of the following work procedures is/are correct when you are in a hot environment?
- a. Take rest breaks regardless of the tactical situation.
  - b. When your leader calls a rest break, continue to work if you are not too tired.
  - c. Take your rest break in a shady area.
  - d. Avoid working in the shade.
  - e. All of the above are correct work procedures.
13. When working in a hot environment, you should wear your uniform so that it is:
- a. Tight-fitting.
  - b. Loose-fitting.

**PMMs for protection against arthropod bites and arthropod-borne diseases.**

14. Malaria is a disease that is transmitted by:
- a. Fleas.
  - b. Lice.
  - c. Mites.
  - d. Mosquitoes.
  - e. Ticks.

15. Which one of the following gives the best instructions for applying insect repellent?
- a. Apply repellent to the soles of your boots.
  - b. Apply repellent to all exposed skin areas other than the skin immediately around the eyes.
  - c. Apply repellent to all exposed skin areas and apply extra repellent to your eyelids and other skin near the eyes.
  - d. Apply repellent in the morning and do not apply additional repellent during the day.
16. When performing outdoor work in an insect-infested area, you should:
- a. Blouse your uniform inside your boots.
  - b. Take off your shirt.
  - c. Remove your headgear.
  - d. Roll up your shirtsleeves.
17. You have lost your supply of malaria pills. Should you see your NCO about being resupplied with the pills?
- a. Yes.
  - b. No.
18. If possible, you should bathe:
- a. Daily.
  - b. Twice a week.
  - c. Weekly.
  - d. Twice a month.

19. When performing strenuous work in an insect-infested area, you should reapply insect repellent:
- a. Every 30 minutes.
  - b. Every hour.
  - c. Every 6 hours.
  - d. Once per day.
20. Malaria pills are usually taken:
- a. Immediately upon waking up.
  - b. Just before going to sleep.
  - c. At mealtime.
21. Wash your uniform at least:
- a. Daily.
  - b. Weekly.
  - c. Monthly.
  - d. Every two months.

**PMMs for protection against water-borne and food-borne diseases.**

22. You are a member of a small group of combat soldiers in a foreign country. Your team has exhausted its supply of water and the climate is very hot. There is a clear stream nearby, but you do not know if the water in the stream is safe to drink. One soldier says that he knows of a nearby village. What should your group do?
- a. Use the water in the stream as is.
  - b. Go to the village and use its water as is since it will be safe to drink.
  - c. Use the water from the stream, but disinfect the water before drinking it.
  - d. Do without water until you meet some other soldiers who have water that is safe to drink.
23. A soldier says, "Ice can safely be bought from civilian sources because freezing kills the disease-causing bacteria." Is he right?

- a. Yes.
  - b. No.
24. You have filled a one-quart canteen with water of unknown quality. How many iodine tablets should you put into the canteen.
- a. One.
  - b. Two.
  - c. Three.
  - d. Four.
  - e. Five.
25. You have added iodine tablet(s) to the water in your canteen in order to purify the water. What should you do next?
- a. Drink the water.
  - b. Shake the water in the canteen.
  - c. Wait five minutes, then shake the water in the canteen.
  - d. Wait twenty minutes, then shake the water in the canteen.
  - e. Wait one hour, then shake the water in the canteen.
26. Washing your hands before eating is especially important in the prevention of:
- a. Insect-borne diseases.
  - b. Intestinal diseases.
  - c. Respiratory diseases.
  - d. Venereal diseases.

27. Before you purify water, you should check the color of your iodine tablets. Use only those tablets that are still:
- a. Black.
  - b. White.
  - c. Orange.
  - d. Gray.
28. When you wash your hands, you should wash them for at least:
- a. 15 seconds.
  - b. 30 seconds.
  - c. 1 minute.
  - d. 3 minutes.
29. Which of the following is a recommended action for disposing of food waste in the field?
- a. Place in a plastic bag and place it under a bush with the other soldiers' bags.
  - b. Locate an area 100 feet from the camp and spread the food waste on the ground so that the local animals will eat the food.
  - c. Bury the food waste to prevent flies from feeding on the waste.

**PMMs for protection against hearing loss.**

30. In high steady-state noise level areas which of the following actions should you take to protect against hearing loss?
- a. Limit time in hazardous noise areas.
  - b. Wear ear canal caps.
  - c. Wear specialized vehicle headgear.
  - d. All of the above.
  - e. None of the above.
  - f. Responses "b" and "c" only.

**PMMs for prevention of skin infections.**

31. Which of the following listed actions is not an action done to prevent skin infections?
- a. Bathe frequently.
  - b. Wear loose fitting clothing.
  - c. Shave facial hair.
  - d. Use perfumed soaps and feminine deodorants.

**PMMs for care of the feet.**

32. When in the field you should do which of the following?
- a. Wear brand new footwear to ensure durability during the field exercise.
  - b. Reduce congestion and swelling in your feet by standing and shifting your weight from one foot to the other foot.
  - c. Wear socks that are free of holes and/or knotty darns.

**PMMs for oral hygiene.**

33. Is it possible to practice good oral hygiene in a field environment?
- a. Yes.
  - b. No.

**PMMs for protection against respiratory disease.**

34. You have a respiratory disease. Which of the following is not a proper measure to protect other soldiers from catching the disease?
- a. Avoid close contact with other soldiers.
  - b. Avoid going to sick call.
  - c. Avoid lending personal items to other soldiers.
  - d. Allow fresh air into your fighting position.

**PMMs to follow for protection against sexually transmitted disease.**

35. Which of the following will not help prevent a female from contracting a venereal disease?
- a. Avoiding sexual intercourse.
  - b. Having the male use a condom during sexual intercourse.
  - c. Administering a vaginal douche immediately after sexual intercourse.
36. A male with AIDS can spread the disease:
- a. Only to other males with whom he has sexual contact.
  - b. Only to females with whom he has sexual contact.
  - c. To both males and females with whom he has sexual contact.
37. The use of a condom during sexual intercourse will help to protect a male from syphilis.
- a. The statement is true.
  - b. The statement is false.

38. The use of a condom during sexual intercourse will help to protect a female from syphilis.
- a. The statement is true.
  - b. The statement is false.
39. The use of a condom during sexual intercourse will help to protect a male from AIDS.
- a. The statement is true.
  - b. The statement is false.
40. The use of a condom during sexual intercourse will help to protect a female from AIDS.
- a. The statement is true.
  - b. The statement is false.

**PMMs for human waste disposal.**

41. For a bivouac of 1-3 days what method is recommended for human waste disposal?
- a. Cat-hole latrine.
  - b. Straddle trench latrine.
  - c. Deep pit latrine.

**PMMs for prevention of tobacco use injuries.**

42. What is the DOD policy on smoking in the workplace?
- a. The workplace will be smoke free.
  - b. Smoke breaks may be taken at the individual workstation.
  - c. Smoke breaks are scheduled for 10 minutes every two hours.
  - d. Smoking will be permitted in the restrooms.



43. Which of the following is the correct statement about physical responses caused by tobacco use?
- a. The soldier can better endure colder climates when smoking.
  - b. The soldier has better night vision.
  - c. The soldier has decreased hand-eye coordination.
  - d. The soldier has decreased number of injuries.

Check your answers

**LESSON 3**  
**EVALUATE A CASUALTY**  
**(TASK 081-831-1000)**

**TASK:**

Identify the first aid evaluation procedures performed on the battlefield and the sequence in which they are performed.

**CONDITIONS:**

Given multiple-choice examination items pertaining to evaluating and treating a casualty.

**STANDARD:**

Score 70 or more points on a 100-point comprehensive examination.

**REFERENCES:**

STP 21-1-SMCT, Soldier's Manual of Common Tasks: Skill Level 1.  
FM 21-11, First Aid for Soldiers.

**NOTE:** Some of the task titles and information have changed and are not reflected in FM 21-11 and STP 21-1-SMCT. Refer to the Army Training Support Center, Common Core Task internet site at: <http://www.atsc.army.mil/dld/comcor/comcore.htm> for up-to-date task information.

**3-1. INTRODUCTION**

Every soldier must know how to identify and treat certain life-threatening medical conditions. On the battlefield, the ability to quickly evaluate a person's condition and to take immediate corrective measures can mean the difference between life and death. When treating a casualty, you must identify and treat the most serious condition first. In general, you must make sure that the casualty is breathing, then control any major bleeding, and then take measures to control shock.

During the evaluating or treating process, you should seek medical aid as soon as possible. Do not stop the treatment, but if the situation allows, send another person to find medical aid.

Your evaluation must be adjusted to the situation. If the environmental conditions favor heatstroke, for example, you will check the casualty's breathing, then quickly check for other conditions while you begin treatment for heatstroke. If a soldier collapses during

a battle, however, you will probably spend a good deal more time looking for entry and exit wounds.

Some of the standard evaluation steps may be performed so fast that they appear to be skipped. A casualty who is yelling in pain, for example, is obviously conscious (responsive) and breathing.

### **3-2. EVALUATE AND PERFORM NEEDED BUDDY-AID PROCEDURES**

The following paragraphs give the steps normally used in evaluating a casualty and present the steps in an appropriate sequence.

Assume that you are in a combat situation and see a fellow soldier lying on the ground. Also assume that your mission will allow you to stop and give buddy-aid.

### **3-3. CHECK FOR HAZARDS**

Quickly evaluate your immediate surroundings and the casualty for obvious, immediate, life-threatening hazards. Examples of such hazards include burning vehicles, explosion, enemy fire, flames from casualty's clothing, flames (burning chemicals) from casualty's skin, and electrical wires touching or very near the casualty.

If there are any signs of chemical or biological agent poisoning, immediately mask the casualty. If the casualty appears to have chemical agent poisoning other than nerve agent poisoning, get medical help immediately and decontaminate exposed skin and gross contamination (large wet or oily spots) of the clothing or overgarments.

If it is nerve agent poisoning, administer the antidote before decontamination (Lesson 4, Perform First Aid for a Nerve Agent Injury).

If you and the casualty are in a relatively safe location and the casualty is not being burned, continue your evaluation.

If the casualty is being burned, eliminate the source of the burn (Lesson 13, Perform First Aid for Burns). Take care to prevent being injured yourself, especially if removing an electrical wire.

If an immediate, life-threatening hazard (such as a burning building) is present, remove the casualty to a place of safety using an appropriate carry (Lesson 16, Transport a Casualty). Then continue your evaluation.

### **3-4. CHECK CASUALTY FOR RESPONSIVENESS**

Calmly ask in a loud voice, "Are you okay?" or some similar question that demands a response from the casualty. If he does not answer, gently shake him or tap him on the shoulder and repeat the question.

If the casualty responds, ask the casualty for information, (Where do you hurt? Were you hit? Were you exposed to chemical agents? etc.) This information will be useful, but continue to evaluate the casualty in a systematic method since the injury that hurts the most may not be the injury that needs to be treated first.

If the casualty is not responsive, send someone to get medical help (usually a combat medic) and continue your evaluation.

### **3-5. CHECK CASUALTY FOR BREATHING DIFFICULTIES**

If the casualty is responsive, evaluate him for airway obstruction (universal choking sign, difficulty in breathing).

If the casualty has good exchange, continue your evaluation.

If the casualty has poor or no air exchange, expel the obstruction (Lesson 5, Perform First Aid to Clear an Object Stuck in the Throat of a Conscious Casualty) and continue your evaluation.

If the casualty is not responsive (unconscious), evaluate his respirations by:

- (1) Looking for rise and fall of the casualty's chest.
- (2) Listening for breathing by placing your ear about one inch above the casualty's mouth and nose.
- (3) Feeling for breathing by placing your hand or cheek about one inch above the casualty's mouth and nose.

If the casualty has good air exchange, continue your evaluation.

If the casualty is not breathing, open his airway and perform mouth-to-mouth resuscitation (Lesson 6, Perform Mouth-To-Mouth Resuscitation). [NOTE: Mouth-to-mouth (or mouth-to-nose) resuscitation is not performed in a chemical environment.]

If the casualty has no pulse after initiating mouth-to-mouth (or mouth-to-nose) resuscitation, seek medical aid immediately.

If the casualty resumes breathing, continue your evaluation.

### **3-6. CHECK FOR BLEEDING**

Check the casualty for bloody clothing, pools of blood, spurts of blood, entry and exit wounds, etc.

If there is no serious bleeding, continue the evaluation.

If bleeding is present, stop the evaluation and begin treatment as appropriate.

**CAUTION:** Do not turn the casualty onto his back or move his head or trunk until

you have checked for a back or neck injury.

- Partial or complete amputation (Lesson 7, Perform First Aid for Bleeding of an Extremity).
- Arm or leg wound (Lesson 7, Perform First Aid for Bleeding of an Extremity).
- Open chest wound (Lesson 8, Perform First Aid for an Open Chest Wound).
- Open abdominal wound (Lesson 9, Perform First Aid for an Open Abdominal Wound).
- Open head wound (Lesson 10, Perform First Aid for an Open Head Wound).

### **3-7. CHECK FOR SHOCK**

Some features of shock are the following:

- Shock can be caused by injury or wounds or bleeding.
- Shock can interfere with the normal flow of blood through the body.
- Shock may cause death.

Check the casualty for clammy skin, pale or blotchy skin, bluish skin (especially around the mouth), nausea and/or vomiting, severe loss of blood, increased breathing rate, unusual thirst, restlessness, and mental confusion.

If shock is not present, continue your evaluation.

If shock is present, stop the evaluation and begin treatment (Lesson 11, "Perform First Aid to Prevent or Control Shock"). Splint leg fractures before elevating the legs as a treatment for shock (Lesson 12, "Perform First Aid for a Suspected Fracture").

### **3-8. CHECK FOR FRACTURES**

## WARNING

**UNLESS THERE IS IMMEDIATE LIFE-THREATENING DANGER,  
DO NOT MOVE A CASUALTY WHO HAS A SUSPECTED BACK OR  
NECK INJURY.**

Check for cuts and bruises in and around the neck and back area, paralysis or numbness, pain or tenderness around the spinal column, severe head injury (deformed skull or visible brain tissue or skull fragments), and unusual positioning of the head, neck, and/or back.

If no spinal injury is suspected, continue your evaluation.

If a neck or back injury is suspected, immobilize the casualty by doing the following:

- (1) Tell the casualty not to move.
- (2) For a back injury, place padding under the natural arch of the casualty's back. Roll or fold the padding to conform to the shape of the arch.
- (3) For a neck injury, place a roll of cloth under the casualty's neck and immobilize the neck by putting boots (filled with dirt, sand, etc.) on both sides of the head. Rocks can be used, if necessary, on the sides of the casualty's head provided they are padded.

After immobilizing the casualty, check his arms and legs for open or closed fractures.

An open fracture is a broken bone that breaks (pierces) the overlying skin.

- (1) Look for bleeding.
- (2) Look for bone sticking through the skin.
- (3) Ask a conscious casualty to tell you where there is pain or tenderness or which areas cannot be moved.

A closed fracture is a broken bone that does not break the overlying skin. Look for:

- (a) Swelling.
- (b) Discoloration.
- (c) Deformity.
- (d) Unusual body position.

- (e) Presence, quality, and rate of distal pulses beyond the suspected fracture site.

If no fracture or massive wound is found, continue your evaluation.

If a fracture is found, perform first aid for the fracture (Lesson 12, Perform First Aid for a Suspected Fracture).

### **3-9. CHECK FOR BURNS**

Burns often cause extreme pain, scarring, or even death. Proper treatment will minimize further injury.

The source of the burn (electricity, etc.) must be eliminated before any evaluation or treatment of the casualty can occur.

Checking for burns involves checking for singed clothing, and for reddened, blistered, or charred skin.

If no burns are found, continue your evaluation.

If burns are found, stop the evaluation and begin treatment (Lesson 14, Perform First Aid for Burns).

### **3-10. CHECK FOR HEAT INJURY**

If the casualty has been working in a hot environment or has been working hard, check for signs and symptoms of heat cramps (painful contractions of the limbs or abdomen and heavy perspiration), heat exhaustion (heavy perspiration, pale and clammy skin, weakness or faintness, and dizziness), and heatstroke (little or no perspiration, hot and flushed skin, nausea, mental confusion, convulsions, and possible unconsciousness).

If no heat injury is present, continue your evaluation.

If the casualty has a heat injury begin first aid for the injury (Lesson, Perform First Aid for a Heat Injury).

### **3-11. CHECK FOR COLD INJURY**

If the casualty has been exposed to freezing weather, check for blanched skin, yellowish or waxy-looking skin, numb areas, and frozen (solid feeling) tissue.  
If no cold injury is present, continue your evaluation.

If a cold injury is found begin first aid for a cold injury (Lesson, Perform First Aid for Cold Injuries).

### **3-12. CHECK FOR HEAD INJURY**

Usually, serious skull fractures and brain injuries occur together; however, it is possible to receive a serious brain injury without a skull fracture. The brain is a very delicate organ. When it is injured, the casualty may exhibit a number of signs and/or symptoms.

Check the casualty for unequal pupils, fluid leaking from the ears or nose, mental confusion (cannot tell you the date when asked, etc.), slurred speech, recent unconsciousness, loss of memory, dizziness or difficulty in walking, nausea, sleepiness, and twitching or convulsions.

If no head injury is found, continue your evaluation.

If the casualty has a suspected concussion, position the casualty in a sitting position, on his side, or on his stomach with his head turned to one side.

If the casualty is having convulsions, support his head and neck and maintain an open airway.

Have a casualty with a closed head injury evaluated by medical personnel even if the casualty seems to recover.

Continue to watch for signs that would require: performance of mouth-to-mouth resuscitation (lesson 6, Perform Mouth-to-Mouth Resuscitation), treatment for shock (lesson 11, Perform First Aid To Prevent or Control Shock), or control of bleeding (lesson 7, Perform First Aid for Bleeding of an Extremity).

If the casualty has an open head wound, begin first aid for a head wound (lesson 10, Perform First Aid for an Open Head Wound).

### **3-13. SEEK MEDICAL AID**

If the military situation requires the soldier to stay on duty if able and his injuries permit him to do so, have him seek medical care (usually the combat medic) when practical.

When the situation permits, you should seek medical aid for the soldier as soon as possible. Do not interrupt treatment. If possible, send a second person to find medical aid. If no one else is available to seek medical aid, you may need to carry the casualty (litter or manual carry) to a location where he can receive medical care after first aid is given.

### **3-14. MONITOR THE CASUALTY**



A casualty must be monitored throughout the evaluation process for life-threatening conditions. For example, a casualty who is breathing when you begin your check may suddenly stop breathing. Anytime a life-threatening condition is detected, stop your evaluation and treat the life-threatening condition.

Some conditions may require time to properly evaluate. If you put a field dressing on a bleeding wound on the casualty's leg, for example, you must continue to monitor the injury in case additional measures (pressure dressing or tourniquet) are needed to control bleeding. You can proceed with your evaluation of the casualty while continuing to monitor the wound for bleeding.

At times, you may complete your evaluation and buddy-aid treatment and be waiting until the casualty can be safely evacuated. Continue to check his breathing and take proper measures should his airway need to be opened and/or he needs mouth-to-mouth resuscitation.

Whenever possible, have the casualty evaluated by a combat medic or other qualified medical personnel.

## PRACTICE EXERCISES: LESSON 3

### Evaluate a Casualty

**INSTRUCTIONS:** Answer the following exercises by circling the letter of the response that best answers the question or best completes the sentence. Refer back to the lesson text, if needed. After you have answered all of the exercises, check your answers against the "Solutions to Exercises" in the Appendix. For each exercise answered incorrectly, reread the lesson material referenced.

1. In general, buddy-aid procedures involve stopping severe bleeding, restoring breathing, and controlling shock. In which order should these actions be performed?
  - a. Stop severe bleeding, control shock, restore breathing.
  - b. Control shock, restore breathing, stop severe bleeding.
  - c. Restore breathing, stop severe bleeding, control shock.
  - d. Stop severe bleeding, restore breathing, control shock.
  - e. Restore breathing, control shock, stop severe bleeding.
  - f. Control shock, stop severe bleeding, restore breathing.
  
2. Your area has been attacked with nerve agents. You see a fellow soldier in full MOPP (chemical agent protection) gear lying on his back. What should be your first action when evaluating the soldier?
  - a. Check for bleeding.
  - b. Administer nerve agent antidote.
  - c. Ask the soldier if he is injured.
  - d. Remove his mask and check his pulse.

3. Which of the following would be treated first?
  - a. A concussion.
  - b. A closed fracture of the leg.
  - c. An open fracture of the leg.
  - d. An amputation of the forearm.
  
4. A casualty with burns on his arms and chest and a possible spinal fracture is lying next to a burning vehicle, which could explode. What should you do?
  - a. Move the casualty to safety; then dress the burns; then immobilize the casualty's spine.
  - b. Move the casualty to safety; then immobilize the casualty's spine; then dress the burns.
  - c. Immobilize the casualty's spine; then dress the burns; then seek medical help.
  - d. Dress the burns; then move the casualty to safety; then immobilize the casualty's spine.
  - e. Go to seek medical help at once.
  
5. A soldier tells you that he was knocked out by an explosion, but says that he is fine now. However, the soldier staggers when he walks and has slurred speech. When you ask him to tell you the date, he simply has a blank stare. The soldier is probably suffering from:
  - a. A concussion.
  - b. Heat exhaustion.
  - c. A bruised spinal cord.
  - d. An open chest wound.

6. Which of the following is true?
- a. All casualties should be evacuated to an aid post or aid station as soon as possible.
  - b. A soldier should return to his combat mission if the military situation requires his return and he is able to perform his combat duties.
  - c. No casualty should be evacuated to an aid post or aid station unless he has been seen by a combat medic.
7. You have found an unconscious soldier and have determined that he is breathing. Which of the following is true?
- a. You do not need to check his breathing again.
  - b. You should monitor his breathing as long as he is unconscious in case he should require mouth-to-mouth resuscitation.

Check your answers

THIS PAGE INTENTIONALLY LEFT BLANK

**LESSON 4**  
**PERFORM FIRST AID FOR A NERVE AGENT INJURY**  
**(TASK 081-831-1044)**

**TASK:**

Identify procedures for performing self and buddy first aid for a nerve agent injury.

**CONDITIONS:**

Given multiple-choice questions pertaining to nerve agent poisoning and decontamination.

**STANDARD:**

Score 70 or more points on a 100-point comprehensive examination.

**REFERENCES:**

FM 3-4, NBC Protection.

FM 21-11, First Aid for Soldiers

FM 8-285, Treatment of Chemical Agent Casualties and Conventional Military Chemical Injuries.

**NOTE:** Some of the task titles and information have changed and are not reflected in FM 21-11 and STP 21-1-SMCT. Refer to the Army Training Support Center, Common Core Task internet site at <http://www.atsc.army.mil/dld/comcor/comcore.htm> for up-to-date task information.

**NOTE:** The proponent for the following listed tasks is the U.S. Army Chemical School. Tasks: 031-503-1013, Decontaminate Yourself and Individual Equipment Using Chemical Decontamination Kits; 031-503-1015, Protect Yourself from NBC Injury/Contamination with the Appropriate Mission-Oriented Protective Posture (MOPP) Gear; 031-503-1019, React to a Chemical or Biological Hazard or Attack; 031-503-1035, Protect Yourself from Chemical/Biological Contamination Using Your Assigned Protective Mask. The above tasks are referred to throughout this lesson.

## **SECTION I**

### **ADMINISTER NERVE AGENT ANTIDOTE TO SELF (SELF-AID)**

#### **4-1. INTRODUCTION**

Chemical agents are intended for use in military operations. They are designed to kill or incapacitate personnel due to the chemical effects of the agent. Chemical agents may be inhaled, ingested when food or water contaminated by the agent is consumed, or absorbed when the agent comes into contact with the skin or eyes. Nerve agents are among the deadliest chemical agents. They can be delivered by artillery shell, mortar shell, rocket, aircraft bomb, spray, or land mine. In general, nerve agents are colorless, odorless, and tasteless.

Your protective mask and protective clothing provide good protection from all chemical agents. The M258A1 or M291 Skin Decontamination Kits are used to remove liquid chemical agents from your exposed skin. The M295 Individual Equipment Decontamination Kit is used to decontaminate your personal equipment. The M259A1 kit can also be used to decontaminate equipment. For more information, refer to task 031-503-1013, Decontaminate Yourself and Individual Equipment Using Chemical Decontamination Kits. Medications contained in the Mark I nerve agent antidote kit help to counteract nerve agent poisoning. The effects of the antidote can be enhanced by taking pyridostigmine bromide tablets at least one hour prior to being exposed to the nerve agent.

#### **4-2. TAKE PYRIDOSTIGMINE BROMIDE PRETREATMENT TABLETS**

You will be issued the Nerve Agent Pyridostigmine Pretreatment (NAPP) Tablet Set when the corps/division/wing command determines there is a need. The instructions on the proper use of pyridostigmine will be provided at time of issue. Additionally, instructions are on the tablet set. Although the pyridostigmine itself does not provide protection against nerve agents, it does enhance the efficiency of the medications contained in the Mark I nerve agent antidote set.

FIGURE 4-1. NERVE AGENT PYRIDOSTIGMINE PRETREATMENT TABLET SET (NAPP).

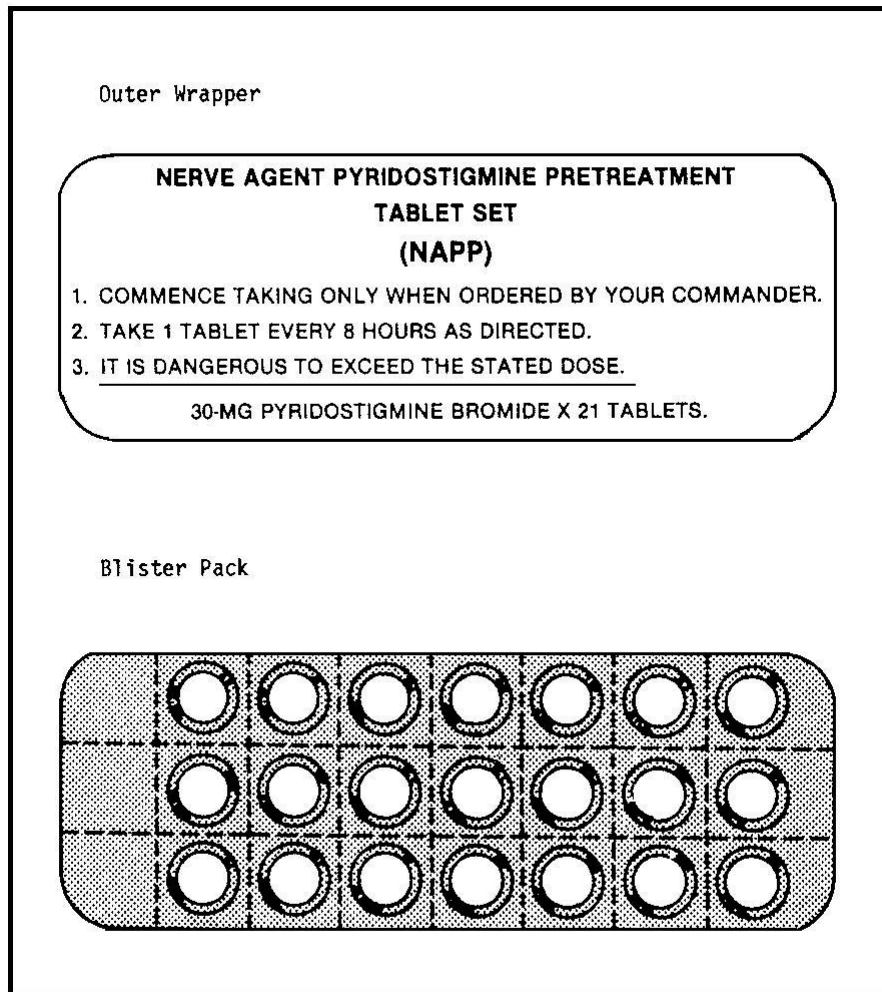

The Nerve Agent Pyridostigmine Pretreatment Tablet Set (fig 4-1) contains the pretreatment medication to be taken within 8 hours prior to exposure to nerve agents.

The NAPP consists of a blister pack containing 21 tablets. Each tablet contains 30 mg pyridostigmine bromide. Each blister pack contains enough tablets for 7 days. Take one tablet by mouth, with sufficient water to assist in swallowing the medication, every 8 hours as directed by your commander. If a dose is missed, do not make it up. Do not take two tablets at one time because of a missed dose--merely start again with one tablet every 8 hours. Taking two tablets at one time could result in adverse side effects. Taking more than one tablet at a time DOES NOT provide additional protection--in fact, it may be more hazardous if there is exposure to a nerve agent.

You are initially issued one NAPP when the chemical protective ensemble is expected to be opened for use. You are responsible for carrying the NAPP and safeguarding it against loss. Service members will secure the blister pack in the sleeve or breast



pocket of the chemical protective ensemble (or in another part of the ensemble, as directed by local standing operating procedure (SOP)).

When the order to take pyridostigmine pretreatment has been given, it should be taken as directed even though the protective mask is worn.

### **Signs and Symptoms of Pyridostigmine Bromide Overdose, Adverse Reactions, and Contraindications**

Although no detrimental effects are expected at the recommended dosage, depending on the length of time and the amount of medication taken as well as individual physiologic variations, some individuals may have contraindications for taking pyridostigmine bromide while others may experience adverse reactions.

Signs and symptoms of overdose, adverse reactions, or side effects are:

- Abdominal cramps.
- Nausea and vomiting.
- Diarrhea.
- Blurring of vision, miosis.
- Increased bronchial secretions.
- Cardiac arrhythmias, hypertension.
- Weakness, muscle cramps, and muscular twitching.
- Skin rash.

Since pyridostigmine bromide may increase bronchial secretions and aggravate bronchiolar constriction, caution should be used in its administration to personnel with bronchial asthma.

If you have any of the above signs/symptoms, consult unit medical personnel as soon as possible.

### 4-3. IDENTIFY WHEN PROTECTIVE MEASURES ARE TO BE INITIATED

Your best protection against nerve agents and other chemical agents is your protective mask. You should immediately mask when:

- You are commanded to mask.
- Someone gives a chemical agent warning either by yelling, "Gas!" or by giving hand and arm signals.

**FIGURE 4-2. CHEMICAL AGENT WARNING SIGNAL**

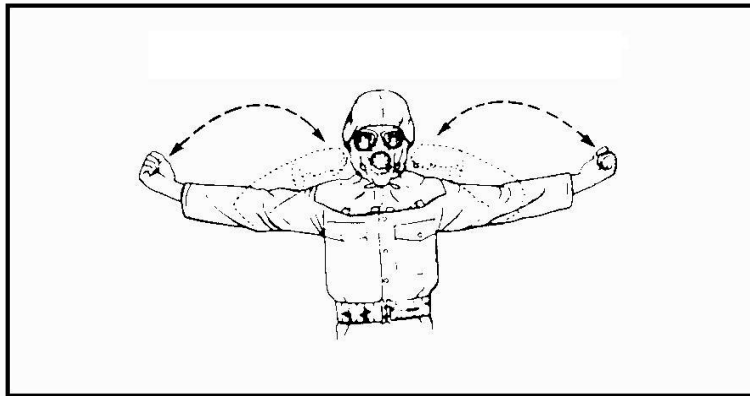

- You detect the presence of a chemical agent using M8 paper, M9 paper, or other device.
- Your position is hit by a concentration of artillery, mortar, or rocket fire, or by aircraft bombs.
- Your position is under attack by aircraft spray.
- Smoke or mist of an unknown source is present or approaching.
- A suspicious liquid is present.
- You are entering an area known to be or suspected of being contaminated with a toxic chemical.
- You notice signs and symptoms of nerve agent poisoning in yourself or in others.
- You note inappropriate laughter, unusual behavior, slurred speech, unusual restlessness, dizziness, stumbling, or sudden feelings of depression in yourself or in others. (These signs and symptoms may be caused by an

incapacitating agent. Incapacitating agents may be combined with a chemical agent in order to interfere with a soldier's ability to take protective actions against the chemical agent.)

- Soldiers suddenly collapse without evident cause.

#### **4-4. IDENTIFY EARLY SIGNS AND SYMPTOMS OF NERVE AGENT POISONING**

Nerve agents are absorbed rapidly and the effects are felt immediately. Signs and symptoms of nerve agent poisoning are divided into two groups--early and severe. A person with early (mild) symptoms is capable of administering first aid to himself (self-aid). A person with severe symptoms is not capable of helping himself and must rely on others to administer first aid (buddy-aid). The number and severity of symptoms that are caused by nerve agent poisoning depend upon the amount of nerve agent absorbed by the body. Early signs and symptoms of nerve agent poisoning include:

- An unexplained runny nose.
- A sudden headache.
- Sudden drooling.
- Tightness in the chest or difficulty in breathing.
- Muscular twitching around exposed skin.
- Stomach cramps.
- Nausea.
- Vision difficulties (reduced vision).

#### **4-5. PUT ON YOUR PROTECTIVE MASK**

In case of chemical attack, your first action should be to hold your breath and put on your protective mask immediately. If you are having signs or symptoms of nerve agent poisoning and are not masked, put on your protective mask before injecting yourself with nerve agent antidote.

Put on your protective mask (see task 031-503-1035, Protect Yourself from Chemical/Biological Contamination Using Your Assigned Protective Mask).

Give the alarm by yelling, "Gas!" or by using hand signals (see task 031-503-1019, React to Chemical or Biological Hazard or Attack).

#### 4-6. SELECT INJECTION SITE

The nerve agent antidotes need to be injected into a large muscle. In most individuals, the thigh muscle is used. If a person is very thin, however, the injection should be given in the buttocks.

##### Thigh

If you are right-handed, select a site on your right thigh. If you are left-handed, select a site on your left thigh. The injection site should be in the outer part of the thigh. It is important that the injections be given into a large muscle area. The site should be at

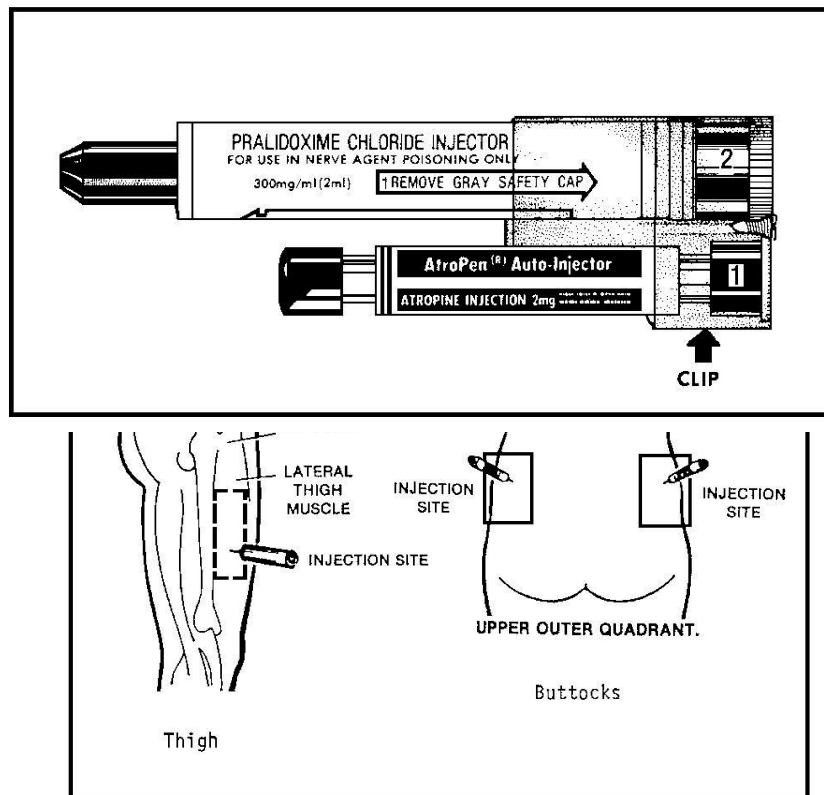

least one hand's width below the hip joint and at least one hand's width above the knee. Choose a site that is away from buttons, zippers, and objects being carried in your pockets.

FIGURE 4-3. INJECTION SITES

##### Buttocks

If you are right-handed, select a site on the upper, outer quadrant of your right buttocks. If you are left-handed, select a site on the upper, outer quadrant of your left

buttocks. The upper, outer part of the buttocks is used to avoid hitting a major nerve or artery. Hitting the nerve could result in paralyzing the leg. The site should be free of objects in your pocket which could be hit by the needle.

#### **4-7. ADMINISTER ONE NERVE AGENT ANTIDOTE KIT**

Administer a Mark I nerve agent antidote kit (NAAK) only after you mask and only if you are having signs and symptoms of nerve agent poisoning. You should have three Mark I kits in the inside pocket of your M17 mask carrier. In the case of the M40 series carrier, there is no room for the Mark I kits and SOP dictates the storage location, usually in the battle dress uniform (BDU). In freezing temperatures, carry the kits where they will be protected from the cold. The Mark I kit has two automatic injectors (autoinjectors). The large autoinjector contains pralidoxime chloride (2-PAM chloride). The smaller autoinjector contains atropine. Procedures for administering the antidotes follow.

#### **FIGURE 4-4. MARK I NERVE AGENT ANTIDOTE KIT**

##### **Administer Atropine**

Remove one Mark I kit from your mask carrier (or other location as specified by local SOP).

Hold the kit with your nondominant hand by the plastic clip with the larger (2-PAM chloride) autoinjector on top. Hold the set at eye level in front of you so that you can see the autoinjectors.

Grasp the body of the smaller (atropine) autoinjector with the thumb and first two fingers of your dominant hand. Do not cover the green (needle) end of the autoinjector with your fingers or hand. Touching the green end may cause the autoinjector to function when you remove it from the clip.

Pull the autoinjector out of the clip with a smooth motion (upon removal the injector is automatically armed.) If the autoinjector accidentally functions, obtain another Mark I kit. Nerve agent antidote must be administered into a large muscle in order to be effective quickly. Administering antidote into a finger or hand is not adequate.

Hold the autoinjector with your thumb and two fingers (pencil writing position).

**FIGURE 4-5. REMOVING THE ATROPINE AUTOINJECTOR**

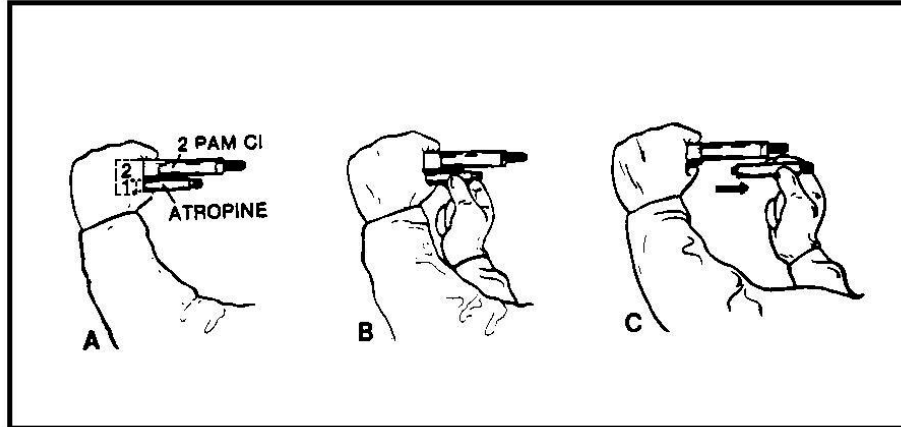

The autoinjector should be held at a 90° angle to your body. Place the green (needle) end of the autoinjector against the thigh (or buttocks) muscle. Make sure that the needle will not hit anything in your pocket when it functions. If your jacket is covering the injection site, lift the bottom of the jacket before giving yourself the injection.

Press the green end of the autoinjector against the injection site using firm, even pressure until it functions (needle is activated). The needle will penetrate through your clothing and into the muscle. The antidote will be injected automatically. Do not use a jabbing motion to activate the needle. A jabbing motion is not necessary and may cause the autoinjector to function improperly.

**FIGURE 4-6. ADMINISTERING AN INJECTION**

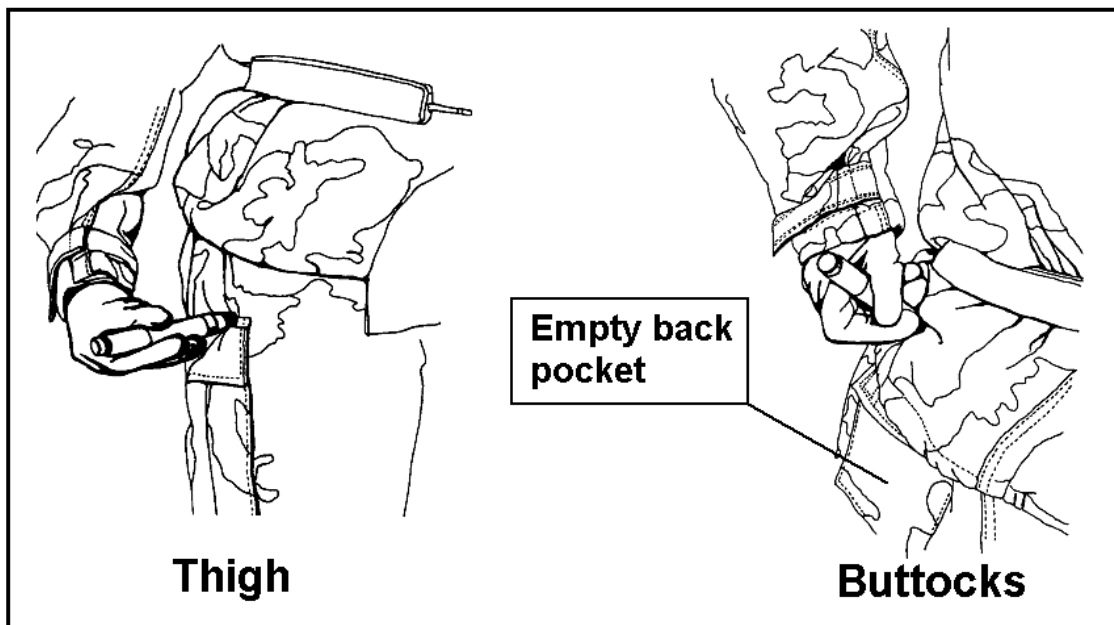

Hold the autoinjector in place for at least ten seconds after the needle has functioned. The seconds can be estimated by counting "one thousand and one, one thousand and two, one thousand and three, one thousand and four, one thousand and five, one thousand and six, one thousand seven, one thousand and eight, one thousand and nine, one thousand and ten." This time is needed to ensure that all of the antidote has been injected.

Carefully remove the atropine autoinjector by pulling it straight out.

Place the used autoinjector between two fingers of the hand holding the remaining autoinjector and clip. The green (needle) end should point away from your hand.

### Administer 2-PAM Chloride

Grasp the body of the 2-PAM chloride autoinjector (the large autoinjector remaining in the clip) with the thumb and two fingers of your right hand. Do not cover the black (needle) end of the autoinjector with your fingers or hand.

Pull the autoinjector out of the clip with a smooth motion. If you accidentally activate the needle while removing the autoinjector, obtain another Mark I kit and administer the new 2-PAM chloride autoinjector.

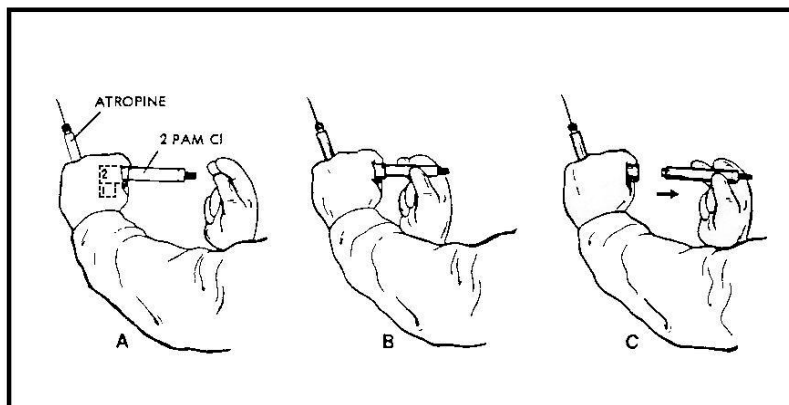

**FIGURE 4-7. REMOVING THE 2-PAM AUTOINJECTOR**

Place the black (needle) end of the autoinjector against your thigh (or buttocks) muscle.

Using firm, even pressure, press the black end of the autoinjector against the injection site until the needle functions. Use the same procedure as used with the atropine autoinjector.

Hold the autoinjector in place for at least ten seconds, then carefully remove the 2-PAM chloride autoinjector by pulling it straight out.

## Secure Used Autoinjectors

Drop the plastic clip. Do not drop the autoinjectors.

Lift a pocket flap on your protective jacket and push the needle of the used 2-PAM chloride autoinjector through the flap. (The flap is penetrated from the back so that the needle will be away from your body.)

Bend the needle down to form a hook.

### WARNING

**If you are wearing protective gloves, take care to avoid puncturing or tearing them while bending the needle.**

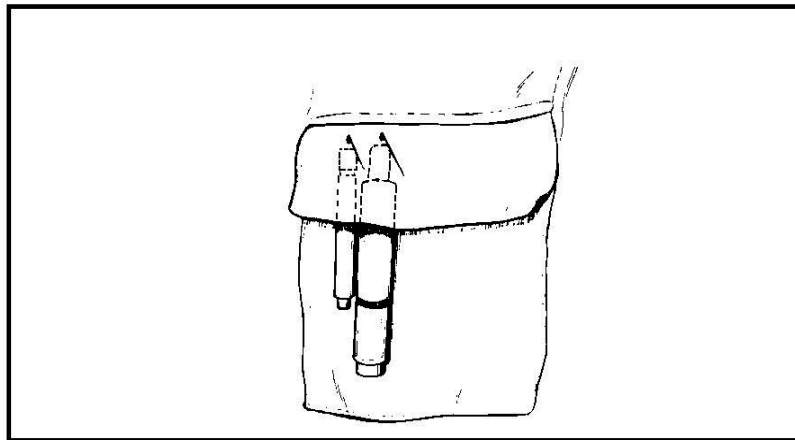

Repeat the penetration and bending process with the expended atropine autoinjector.

**FIGURE 4-8. USED AUTOINJECTORS (ONE SET) ATTACHED TO POCKET FLAP**

**(NOTE:** The expended autoinjectors are secured to your clothing in case you require medical help. Attaching both used autoinjectors to your outer clothing will inform medical personnel that nerve agent antidote has been administered and the amount that has been administered.)



#### 4-8. DECONTAMINATE YOUR SKIN

Refer to task 031-503-1013, "Decontaminate Yourself and Individual Equipment Using Chemical Decontamination Kits."

FIGURE 4-9. M258A1 DECONTAMINATION KIT

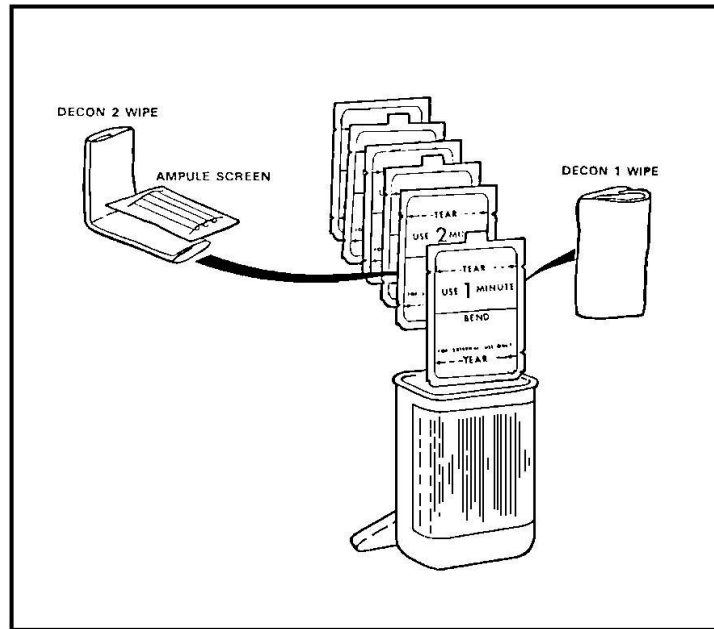

FIGURE 4-10. M291 DECONTAMINATION KIT



After administering the first Mark I and decontaminating your skin, up-grade MOPP.

If you can walk and are not confused (you know who you are and where you are), you will probably not need additional antidote.

### **WARNING**

**If your heart is beating very fast and your mouth is very dry about five to ten minutes after administering the antidotes, you have already given yourself enough antidote.**

**Do not resume taking pyridostigmine bromide tablets after administering a Mark I kit unless you have received clearance from medical personnel.**

Seek buddy-aid or medical aid for **additional injections**.

## **SECTION II**

### **ADMINISTER FIRST AID TO A NERVE AGENT CASUALTY (BUDDY-AID)**

#### **4-10. INTRODUCTION**

A soldier showing signs of severe nerve agent poisoning will not be able to help himself. Unless he receives help, he will probably die. However, you should put on your own protective mask and perform needed self-aid procedures before giving buddy-aid. You cannot help the casualty if you are also overcome by the nerve agent.

Buddy-aid will be required when a soldier is totally and immediately incapacitated prior to being able to apply self-aid. All three sets of nerve agent antidote and the CANA need to be given by a buddy.

Buddy-aid may also be required for a soldier who attempts to counter the nerve agent by self-aid but becomes incapacitated after administering one set of the antidote. Before initiating buddy-aid, a buddy should determine if one set of injectors has already been used so that **no more than three sets** of the antidote are administered.

#### **4-11. IDENTIFY SIGNS OF SEVERE NERVE AGENT POISONING**

A casualty may or may not have signs and symptoms of mild nerve agent poisoning prior to the appearance of the signs of severe nerve agent poisoning. Signs of severe nerve agent poisoning include:

- Strange and confused behavior.
- Gurgling sounds while breathing.
- Severely pinpointed pupils.
- Red eyes with tears present.
- Vomiting.
- Severe muscular twitching.
- Loss of bladder and bowel control.
- Convulsions.
- Unconsciousness.

#### **4-12. MASK THE CASUALTY**

The casualty may have been unable to put on his protective mask before he was overcome by the nerve agent. If so, check his mask to make sure that it is on properly. If the casualty has not masked himself, then you must mask him using the following procedures.

Approach the casualty. If the casualty is moving or flailing about on the ground, approach him from the area of his head and left shoulder. This will help to protect you from accidental injury.

If the casualty is not lying on his back, you must roll the casualty onto his back with his face up. Do this by squatting next to the casualty, grasping the casualty's clothing at the far shoulder and hip, and rolling him toward you in a gentle, even manner.

#### **WARNING**

**Do not kneel when administering aid to a chemical agent casualty. If you press your knee against the contaminated ground, you may force the chemical agent into or through your protective clothing.**

**Kneeling on a contaminated area will greatly reduce the protection time afforded by your protective clothing.**

Place yourself near the casualty's head, face his feet, and squat behind his left shoulder.

Open the casualty's protective mask carrier and remove his protective mask.

Hold the mask so that the lenses are facing you, your thumbs are on the outside of the cheek pouches of the mask, and your fingers are on the inside of the cheek pouches.

**FIGURE 4-11. MASKING A CASUALTY**

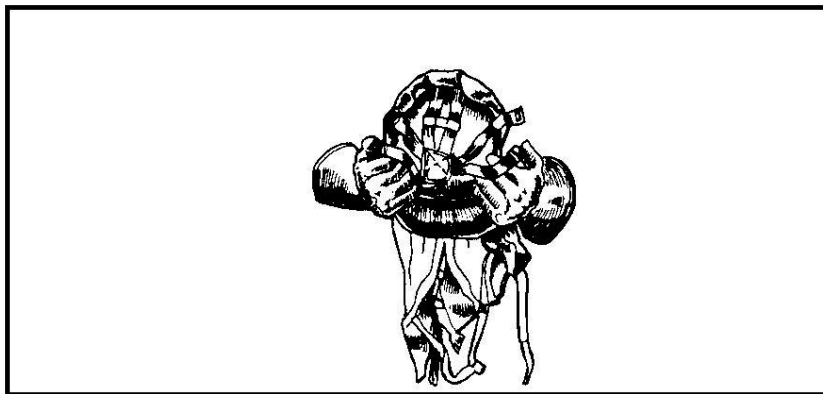

Spread the mask open and position it on the casualty's chin.

Put your thumbs through the two bottom straps of the head harness.

Cup the casualty's head with the fingers of both hands and lift his head slightly.

Slide the head harness over the casualty's head by moving your thumbs toward the back of the casualty's head and down behind his ears.

Make sure that the two bottom straps of the head harness are placed below the casualty's ears and the head pad is centered in the middle of the back of his head.

The head harness should not need to be adjusted. If the straps do need to be tightened, tighten them using short, firm jerks.

Check the mask to ensure that it is completely sealed on the casualty's face. If the casualty is conscious and can follow instructions, have him clear his mask (cover the outlet valve and voicemitter and blow hard, then cover the inlet valves and inhale). If the casualty is unconscious, cover the mask's inlet valves. The mask will collapse if it is properly fitted and sealed. If it does not collapse, reseal the mask. (NOTE: If the soldier is unconscious and not breathing, you cannot be sure that the mask has a good seal.)

Pull the protective hood over the casualty's head, neck, and shoulders. Information on masking is contained in task 031-503-1035, "Protect Yourself from Chemical/Biological Contamination Using Your Assigned Protective Mask."

#### 4-13. ADMINISTER NERVE AGENT ANTIDOTE KITS

After the casualty is masked, position the casualty on his/her right side (similar to the swimmer position) with the head slanted down so that the casualty will not roll back over. If vomiting occurs, the matter will be caught in the mask. Determine if the soldier has self-administered any antidote. Begin administering injections of atropine and 2-PAM chloride. The casualty may be administered a total of **three** Mark I antidote kits without medical attention.

##### Select Injection Site

If the casualty's thigh muscle is large enough, give the injections in his thigh. If the casualty is very thin, give the injection in the large muscle of his buttocks.

Thigh. If the injections are to be given in the casualty's thigh, position yourself near the casualty's thigh. The injection site should be on the outer part of the casualty's upper thigh. The injection site should be at least one hand's width below the hip joint and at least one-hand's width above the knee.

FIGURE 4-12, INJECTING A CASUALTY'S THIGH

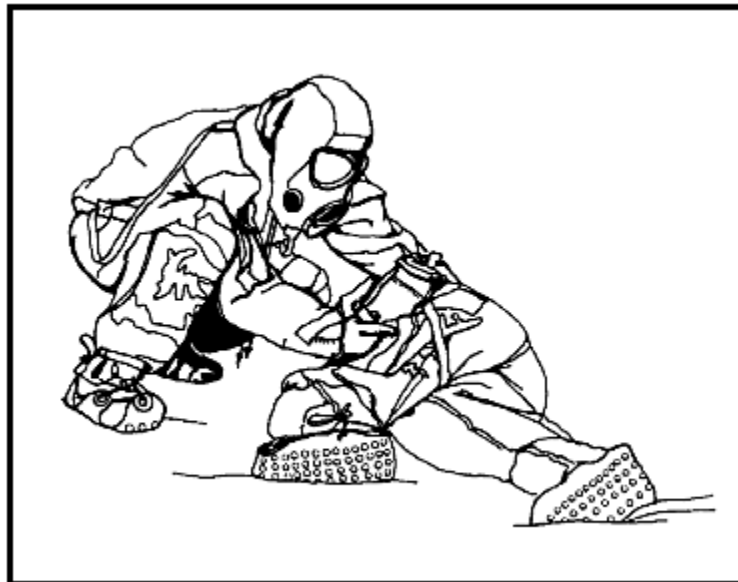

Buttocks. If the injection is to be given in the casualty's buttocks, roll the casualty onto his side and position yourself at his hip. The injection site should be in the upper, outer quadrant of the casualty's upper buttocks when casualty is on his side. The upper,

outer quadrant is used to avoid hitting the major nerve in the buttocks. If the casualty's jacket is covering the injection site, lift the bottom of the jacket.

**FIGURE 4-13. INJECTING THE CASUALTY'S BUTTOCKS**



### **Administering Atropine**

Remove one Mark I nerve agent antidote kit from the inside pocket of the casualty's mask carrier. (NOTE: If the temperature is near or below freezing, the casualty may be carrying the autoinjectors in another location.)

**CAUTION:** Use the casualty's Mark I kits rather than your own. You will need your kits if you begin to have signs and symptoms of nerve agent poisoning.

Hold the kit by the clip in your nondominant hand so that it is in front of your body and at eye level. The larger 2-PAM chloride autoinjector should be on top.

Use your free hand to ensure that the injection site is free from buttons or other obstructions that could be hit by the needle. If the mask carrier or any other equipment is covering the injection site, move the equipment away from the site.

**FIGURE 4-14. REMOVING THE ATROPINE AUTOINJECTOR**

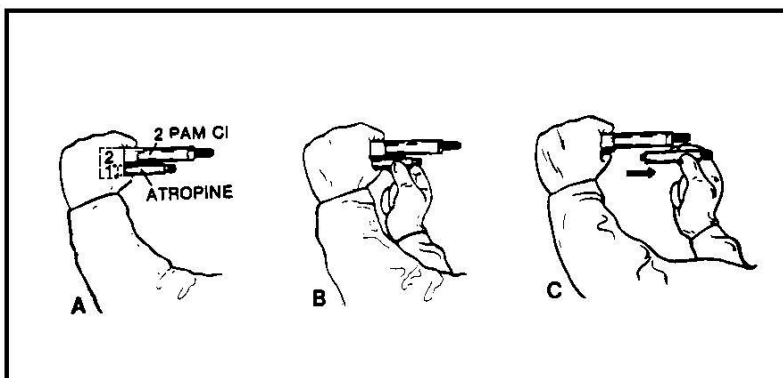

Grasp the smaller (atropine) autoinjector with the thumb and two fingers of your dominant hand.

Pull the atropine autoinjector out of the clip with a smooth motion. Do not cover or hold the green (needle) end of the autoinjector. If you do, the needle may function.

Hold the autoinjector with the thumb and two fingers of your dominant hand and place the green (needle) end of the autoinjector against and at a 90° angle to the injection site.

Apply firm even pressure to the autoinjector until the needle functions, penetrates the casualty's clothing, and injects the medication into the casualty's muscle. Do not use a jabbing motion to inject the antidote into the muscle.

Hold the autoinjector in place for at least ten seconds; then pull the autoinjector out of the casualty's body.

Place the used atropine autoinjector between two fingers of the hand holding the clip. Point the needle away from your hand. Make sure that the needle does not puncture or tear your protective gloves.

### **Administer 2-PAM Chloride**

Grasp the remaining 2-PAM chloride autoinjector with the thumb and two fingers of your free hand.

Pull the autoinjector out of the clip in a smooth motion. Do not touch or cover the black (needle) end of the autoinjector.

Hold the autoinjector with the thumb and two fingers of your dominant hand and place the black end of the autoinjector against the casualty's thigh (or buttocks) at a 90° angle.

**FIGURE 4-15. REMOVING THE 2-PAM CHLORIDE AUTOINJECTOR**

Apply firm, even pressure until the needle functions. Do not use a jabbing motion.

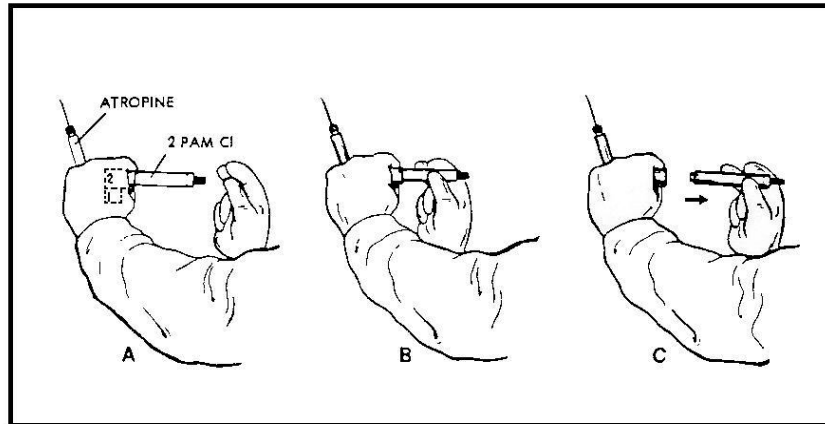

Hold the autoinjector in place for at least ten seconds; then pull out the autoinjector.

Drop the empty plastic clip without dropping the autoinjectors.

Lay the used injectors on the casualty's side.

#### **Administer Additional Antidote**

**CAUTION** If the casualty has already administered one kit to himself, only administer two additional kits. The casualty should not receive more than three sets of injections without being seen by medical personnel or combat lifesaver. (A combat lifesaver is a nonmedical soldier who has been trained in certain medical procedures. He can determine if the casualty needs additional atropine and can administer the injections if they are needed.)

Administer the second and third Mark I kits using the same procedures as for the first kit. After the administering of the third kit of autoinjectors, a CANA injection should be given (para. 4-14).

The autoinjectors are administered one kit after the other until all three kits have been administered. There is no waiting period between kits.

If the casualty does not have three Mark I kits, search the immediate area for used and unused autoinjectors. The casualty may have already given himself injections or have been trying to give himself an injection and dropped the autoinjectors. Be sure to check the casualty's pocket flap for the presence of used autoinjectors.

#### **4-14 ADMINISTER CANA INJECTION**

CANA is a convulsant antidote for nerve agents. CANA is **NOT** for use as self-aid.



FIGURE 4-16, CANA INJECTOR



Preparing to administer the CANA injection consists of the following steps:

- (1) Tear open the protective plastic packet and remove the injector.
- (2) Grasp the injector with the needle (black) end extending beyond the thumb and index finger.
- (3) With the other hand, pull the safety cap off the injector base to arm the injector.
- (4) Place the black end of the injector against the casualty's injection site.

Administer the CANA injection following the same procedure used for the atropine and 2-PAM CI injections.

- The injector is now armed.
  - Do not touch the black (needle) end.
  - Holding or covering the black (needle) end may result in accidentally injecting yourself.
- (1) Position the black end of the CANA injection against the injection site (thigh or buttocks)--
    - On the casualty's outer thigh muscle or--
    - On the upper, outer portion of the casualty's buttocks.
  - (2) Apply firm, even pressure (not a jabbing motion) on the injector to activate the needle. This causes the needle to penetrate both the casualty's clothing and muscle. Using a jabbing motion may result in an improper injection or injury to the thigh or buttocks.
  - (3) Hold the injector firmly in place for at least 10 seconds. The 10 seconds can be estimated by counting "one thousand and one, one thousand and two," and so forth.

## Secure Used Autoinjectors

Attach all used autoinjectors (one at a time) to the casualty's outer clothing, usually the left pocket flap of his protective outer garment. Push the needle of the autoinjector through the pocket flap and bend the needle to form a hook. Repeat the procedure with all remaining autoinjectors. Be careful not to puncture your gloves with the needles. (The used autoinjectors will tell medical personnel how much medication the soldier has received. This information will help them determine what additional care is needed.)

FIGURE 4-17. SECURED USED INJECTORS

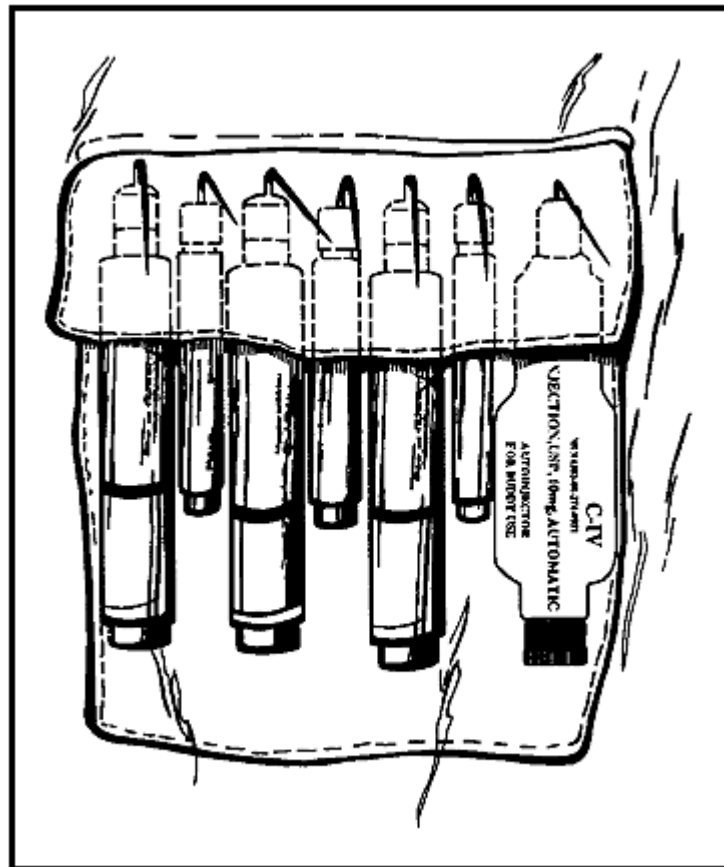

## 4-15. DECONTAMINATE THE CASUALTY'S EXPOSED SKIN

After the casualty has been administered a total of three Mark I kits and the CANA, use the casualty's M258A1 or M291 skin decontamination kit to decontaminate the casualty's skin that was exposed to the nerve agent.

Refer to task 031-503-1013, "Decontaminate Yourself and Individual Equipment Using Chemical Decontaminat Kits" for more information on the various kit procedures. The procedures you follow for your personal decontamination generally apply to a

casualty's decontamination. Procedures are a little more complicated when it involves the area under the casualty's mask and whether the casualty is conscious or not.

Have the casualty hold his breath.

### **WARNING**

**If the casualty cannot hold his breath, do not decontaminate his face. Proceed to decontaminate other exposed skin areas.**

---

Lift the casualty's mask to expose the lower part of his face.

Quickly wipe the exposed area of his face and the interior surface of the mask that comes into contact with his face.

Replace the mask.

Tell the casualty to resume breathing.

Seek help (usually a combat medic) for the casualty. If your mission allows, evacuate the casualty to an aid post or collection point where he can receive additional care and be evacuated to a field medical treatment facility (aid station). Evacuation procedures are discussed in Lesson 16.

## PRACTICE EXERCISE LESSON 4

### Perform First Aid For a Nerve Agent Injury

**INSTRUCTIONS:** Answer the following exercises by circling the letter of the response that best answers the question or best completes the sentence. Refer to the lesson text, if needed. After you have answered all of the exercises, check your answers against the "Solutions to Exercises" at Appendix A. For each exercise answered incorrectly, reread the lesson material referenced.

1. Which of the following statements is/are true?
  - a. Pyridostigmine bromide tablets are so effective, atropine and 2-PAM chloride are no longer used.
  - b. The proper dosage of pyridostigmine bromide tablets is one tablet every four hours when awake.
  - c. Once started, you should continue to take the pyridostigmine bromide tablets until you are directed to discontinue the medication.
  - d. All three of the above statements are true.
2. Your unit was ordered to take pyridostigmine tablets in anticipation of a possible chemical agent attack. You began taking the medication, but accidentally skipped a dose. Should you take two tablets at once to "catch up" on the dosage?
  - a. Yes.
  - b. No.
3. An aircraft has released a spray of fine mist. What should you do first?
  - a. Inject yourself with three kits of atropine and 2-PAM chloride autoinjectors.
  - b. Inject yourself with one kit of atropine and 2-PAM chloride autoinjectors.
  - c. Put on your protective mask.
  - d. Take a pyridostigmine bromide tablet.

4. Which of the following is not a symptom of nerve agent poisoning?
- Dry mouth.
  - Runny nose.
  - Trouble seeing.
  - Tight feeling in your chest.
5. If you are right-handed and of average body build, you should give yourself injections using the Mark I NAAK autoinjectors in your:
- Left buttocks.
  - Left thigh.
  - Right buttocks.
  - Right thigh.
6. If your thighs are very thin, you should inject yourself with the Mark I autoinjectors in the \_\_\_\_\_ part of your buttocks.
- Lower, inner
  - Lower, outer
  - Upper, inner
  - Upper, outer
7. You should administer Mark I nerve agent antidote injections to yourself you have symptoms of nerve agent poisoning.
- Before.
  - After.

8. When giving yourself injections with Mark I NAAK autoinjectors, you should leave the needle in place for at least \_\_\_\_\_ seconds to ensure that all of the medication has been injected.

- a. Five.
- b. Ten.
- c. Fifteen.
- d. Twenty.

9. How should you remove an atropine autoinjector from the nerve agent antidote set?

- a. Use your thumb and two fingers to grasp the green end of the autoinjector and pull the autoinjector out of the clip with a quick, jerking motion.
- b. Use your thumb and two fingers to grasp the body of the autoinjector and pull the autoinjector out of the clip with a quick, jerking motion.
- c. Using your thumb and two fingers to grasp the green end of the autoinjector and pull the autoinjector out of the clip with a smooth motion.
- d. Use your thumb and two fingers to grasp the body of the autoinjector and pull the autoinjector out of the clip with a smooth motion.

10. You have been exposed to a nerve agent. You are removing an atropine autoinjector from the clip when the needle accidentally functions and injects antidote into your hand. What should you do?

- a. Administer the 2-PAM chloride injection. The atropine injection in the hand is sufficient even if it was more painful.
- b. Get another nerve agent antidote kit and begin again.

11. After giving yourself the first NAAP injector kit, what is your next action?

- a. Administer the second kit immediately.
- b. Wait one minute and administer a second NAAP injector kit.
- c. Wait 10 minutes and administer a second NAAP injector kit.
- d. Seek buddy or medical aid for additional NAAP kit injections.

12. Which of the following statements is/are correct?

- a. Always administer at least two Mark I kits even if the signs and symptoms of nerve agent poisoning are no longer present after you administer the first kit.
  - b. You should not administer more than one Mark I kit to yourself.
  - c. Once the signs and symptoms of nerve agent poisoning subside, they will not return.
  - d. All of the above are correct.
13. A soldier in combat is showing signs of severe nerve agent poisoning. You should assume that he \_\_\_\_\_ administer self-aid to himself.
- a. Can.
  - b. Cannot.
14. Signs and symptoms of mild nerve agent poisoning \_\_\_\_\_ precede the signs of severe nerve agent poisoning.
- a. Always.
  - b. May or may not.
15. Which of the following is not a sign of severe nerve agent poisoning? \_\_\_\_\_
- a. Convulsions.
  - b. Strange behavior.
  - c. Vomiting.
  - d. Dilated pupils.

16. During combat, you and a fellow soldier are in a foxhole. You have put on your protective mask and protective clothing. The other soldier, however, has removed his protective mask to smoke a cigarette. Suddenly, he begins to have severe muscular twitching and other signs of severe nerve agent poisoning. The soldier in the next foxhole gives the "gas" warning. What should you do now?
- Give yourself an injection of atropine and an injection of 2-PAM chloride. Then help the soldier.
  - Give the soldier an injection of atropine and an injection of 2-PAM chloride. Then put his protective mask on him.
  - Put the soldier's protective mask on him. Then give him injections of atropine and 2-PAM chloride.
  - Quickly stomp out the cigarette that the soldier dropped. Then give the soldier injections of atropine and 2-PAM chloride.
17. When administering buddy-aid to a nerve agent casualty, you should be in:
- A squatting position.
  - A kneeling position.
  - A standing position.
18. What site should you normally use to inject a casualty with Mark I autoinjectors?
- Buttocks.
  - Hip.
  - Thigh.
  - Arm.



19. Which one of the following is proper when administering atropine and 2-PAM chloride injections to a nerve agent casualty?
- a. Always give the injections in the thigh after removing clothing covering the area.
  - b. Always give the injections in the buttocks after removing clothing in the area.
  - c. Allow the needle to puncture the casualty's clothing over the thigh or buttocks.
  - d. Allow the needle end of the autoinjector to puncture the main nerve in the buttocks for better effectiveness.
20. You are going to give your buddy injections of atropine and 2-PAM chloride. You should use the autoinjectors carried in \_\_\_\_\_ mask carrier.
- a. The casualty's.
  - b. Your.
21. You have just given a soldier an injection of atropine and an injection of 2-PAM chloride. What should you do with the used autoinjectors?
- a. Leave the plastic clip, atropine autoinjector, and 2-PAM chloride autoinjector on the ground.
  - b. Put the plastic clip in the pocket of the soldier's protective clothing and leave the autoinjectors on the ground.
  - c. Drop the plastic clip onto the ground and place the used autoinjectors on the soldier's side.
  - d. Put the plastic clip in the pocket of the soldier's protective clothing and bury the used autoinjectors.
  - e. Drop the plastic clip onto the ground and place the used autoinjectors in the soldier's protective mask carrier.

22. A casualty should not receive more than \_\_\_\_\_ Mark I kits unless he has been seen by a medical person such as the combat medic or by a combat lifesaver.
- a. Five.
  - b. Four.
  - c. Three.
  - d. Two.
23. How many NAAP kits are administered before giving the CANA injection?
- a. One.
  - b. Two.
  - c. Three.
  - d. Four.
24. What is a CANA injection used for?
- a. Bacterial antidote.
  - b. Convulsant antidote.
  - c. Chemical agent antidote.
  - d. Viral antidote.

Check your answers

THIS PAGE INTENTIONALLY LEFT BLANK

## LESSON 5

### PERFORM FIRST AID TO CLEAR AN OBJECT STUCK IN THE THROAT OF A CONSCIOUS CASUALTY (TASK 081-831-1003)

#### **TASK:**

Identify procedures for aiding a conscious person with an upper airway obstruction.

#### **CONDITIONS:**

Given multiple-choice questions pertaining to recognizing and removing an upper airway obstruction from a conscious person.

#### **STANDARD:**

Score 70 or more points on a 100-point comprehensive examination.

#### **REFERENCES:**

STP 21-1-SMCT, Soldier's Manual of Common Tasks: Skill Level 1.  
FM 21-11, First Aid for Soldiers

**NOTE:** Some of the task titles and information have changed and are not reflected in FM 21-11 and STP 21-1-SMCT. Refer to the Army Training Support Center, Common Core Task internet site at: <http://www.atsc.army.mil/dld/comcor/comcore.htm> for up-to-date task information.

#### **5-1. INTRODUCTION**

An upper airway obstruction (blockage) occurs when a piece of food or some other object enters the person's trachea (windpipe). When a person has suffered a facial injury, blockage may be caused by blood clots or loose teeth that have become lodged in the person's throat. Blockage may also occur when the contents of the stomach are regurgitated (vomited) and some of the vomitus is inhaled.

The blockage must be removed and full breathing restored. A blockage which greatly reduces the amount of air which can be inhaled and exhaled or which stops all air exchange can quickly lead to unconsciousness and death.

## 5-2. RECOGNIZE A PERSON WITH AN AIRWAY OBSTRUCTION

A person with an airway obstruction will automatically begin to cough or at least try to cough. In addition, he will probably clutch his throat. This clutching action is natural, but it has also been adopted as the universal distress signal for choking. This sign alerts other people that the problem is an airway obstruction rather than another problem such as a heart attack or nausea.

FIGURE 5-1. UNIVERSAL DISTRESS SIGNAL FOR CHOKING



## 5-3. EVALUATE THE BLOCKAGE

### Partial Blockage With Good Air Exchange

If the person with an obstruction can speak or cough forcefully, he is said to have a partial blockage with good air exchange. (A partial blockage means that the airway is not completely blocked and air can still get to and from the person's lungs. Good air exchange indicates that the person can still inhale and exhale enough air to carry on all life processes.) A person may have good air exchange even though he makes a wheezing sound between coughs.

### Partial Blockage With Poor Air Exchange

A partial blockage with poor air exchange is indicated by a weak cough, high-pitched noises (like crowing) while inhaling, and signs of shock (bluish tint of the fingernail beds and the lips). A person with poor air exchange is not inhaling sufficient air to continue carrying on all life processes. If the person is not helped, he will probably become unconscious and die.

**CAUTION:** If you cannot decide whether a conscious casualty has good or poor air exchange, tell him to speak to you. If he does not speak, assume he has poor air exchange.

## **Complete Blockage**

If the person's airway is completely blocked, he can neither speak, breathe, nor cough at all (no air exchange occurring) and may be clutching his or her neck. Quick action is needed to clear the airway.

## **5-4. DETERMINE WHAT ACTIONS ARE NEEDED**

### **Partial Blockage With Good Air Exchange**

If the person has good air exchange, encourage him to continue his efforts to cough up the obstruction. Do not interfere with his efforts. Do not leave the person since "good" air exchange can rapidly deteriorate to "poor" air exchange or complete blockage, either of which can result in unconsciousness and death. Be prepared to administer manual thrusts should his condition worsen.

### **Partial Blockage With Poor Air Exchange/Complete Blockage**

If the person has poor air exchange or a complete blockage, call for help and begin administering manual (abdominal or chest) thrusts. If possible, send someone to seek medical help.

Abdominal Thrusts. If manual thrusts are required, abdominal thrusts are normally used to expel whatever is blocking the airway.

Chest Thrusts. If the person has abdominal injuries, is noticeably pregnant, or has a waist that is too large to encircle, chest thrusts are used instead of abdominal thrusts.

**CAUTION:** The manual thrusts presented in this lesson are used with a conscious casualty who is sitting or standing. If the casualty becomes unconscious or is lying down, start rescue breathing (see Lesson 6, Mouth-to-Mouth Resuscitation, task 081-831-1042).

## **WARNING**

**Back blows are no longer used to dislodge an airway obstruction in an adult.**

## 5-5. ADMINISTER ABDOMINAL THRUSTS

A manual thrust acts like a strong cough. Each thrust is delivered with the intent of dislodging and expelling the object causing the blockage. The following procedures

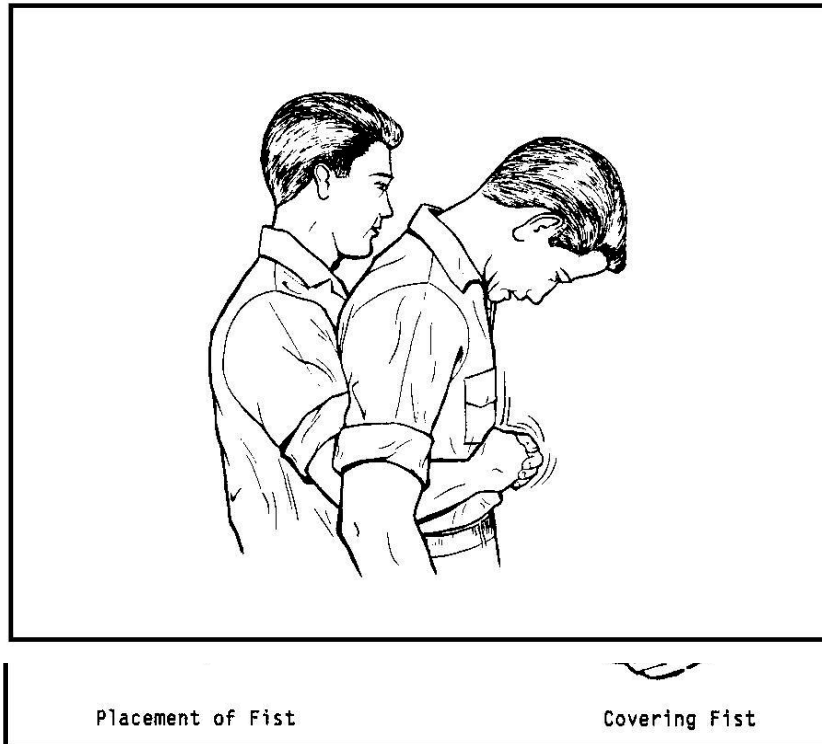

are used to administer abdominal thrusts to a casualty who is conscious and is either standing up or sitting.

**FIGURE 5-2. HAND PLACEMENT FOR ADMINISTERING AN ABDOMINAL THRUST**

Stand behind the casualty and wrap your arms around his waist.

Make a fist with one hand and place it slightly above the casualty's navel (belt buckle) and well below the tip of the casualty's breastbone. (The xiphoid process is the pointed bone at the bottom of the breastbone.) Make sure that your fist is not resting on any ribs. The thumb side of your fist should be against the casualty's abdomen.

### **WARNING**

**A thrust delivered directly to the xiphoid process or ribs can result in damage to breastbone, ribs, and internal organs such as the lungs and heart.**

Grasp your fist with your other hand.

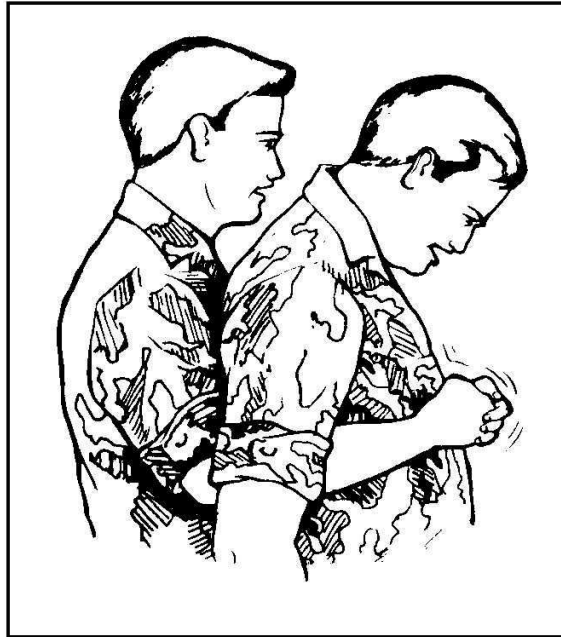

Thrust using a quick inward and upward motion, then relax the hold.

Continue administering abdominal thrusts until the obstruction is expelled or the casualty becomes unconscious. If the casualty loses consciousness, call for help, lay the casualty on his back, perform a finger sweep, and start rescue breathing (see Lesson 6, Mouth-to-Mouth Resuscitation, task 081-831-1042).

**FIGURE 5-3. ADMINISTERING AN ABDOMINAL THRUST (STANDING CASUALTY)**

## **5-6. ADMINISTER CHEST THRUSTS**

Chest thrusts are used for a standing or sitting conscious casualty if the casualty is noticeably pregnant or has abdominal injuries or if your arms will not reach around his waist.

Stand behind the casualty, place your arms under his armpits, and encircle his chest.

Make a fist with one hand and place it on the middle portion of the casualty's breastbone (sternum). The fist must be **above** the xiphoid process. The thumb side of your fist should be next to the chest.

### **WARNING**



**A thrust delivered directly to the xiphoid process or ribs can result in damage to breastbone, ribs, and internal organs such as the lungs and heart.**

Grasp your fist with your other hand.

**FIGURE 5-4. ADMINISTERING A CHEST THRUST (STANDING CASUALTY)**

Thrust inward so that the sternum is depressed about 1 to 2 inches; then relax the hold.

**CAUTION:** If the casualty is a child (8 years old or less) instead of an adult, the sternum should be depressed 1 to 1½ inches.

Continue administering chest until the obstruction is expelled or the casualty becomes unconscious. If the casualty loses consciousness, call for help, lay the casualty on his back, perform a finger sweep, and start rescue breathing (see Lesson 6, Perform Mouth-to-Mouth Resuscitation, task 081-831-1042).

## PRACTICE EXERCISES: LESSON 5

### Perform First Aid to Clear an Object Stuck in the Throat of a Conscious Casualty

**INSTRUCTIONS:** Answer the following exercises by circling the letter of the response that best answers the question or best completes the sentence. Refer to the lesson text, if needed. After you have answered all of the exercises check your answers against the "Solutions to Exercises" at Appendix A. For each exercise answered incorrectly, reread the lesson material referenced.

1. You walk into a room and see that the only other person in the room is standing with a scared look on his face. When he sees you, he quickly places his hand around the front part of his throat but doesn't say anything. What is happening?
  - a. The person is telling you that he is feeling faint.
  - b. The person is telling you that he is choking.
  - c. The person is telling you that he is in shock.
  - d. The person is telling you that he has laryngitis and can't talk.
2. Before giving manual thrusts to a choking casualty, you should:
  - a. Determine if the casualty has good, poor, or no air exchange.
  - b. Check the casualty's pulse.
  - c. Slap the casualty on his back.
3. You are going to help a choking casualty cough up an object in his throat using manual thrusts. When is the chest thrust preferred over the abdominal thrust?
  - a. When you cannot reach around the casualty's waist.
  - b. When the casualty is noticeably pregnant.
  - c. When the casualty is lying down.
  - d. Choices a and b above.
  - e. Choices a, b, and c above.
4. A person with partial airway blockage and poor air exchange is treated the same as a person with:

- a. Complete airway blockage.
  - b. Partial airway blockage and good air exchange.
5. You have placed your hands to give an abdominal thrust. The thrust is delivered using a:
- a. Quick inward and downward motion.
  - b. Slow, steady inward and downward motion.
  - c. Quick inward and upward motion.
  - d. Slow, steady inward and upward motion.
6. When performing a chest thrust, your hands should be centered:
- a. Over the uppermost portion of the casualty's breastbone.
  - b. Over the middle of the casualty's breastbone.
  - c. Over the casualty's xiphoid process.
  - d. Between the casualty's waist and rib cage.

Check your answers

**LESSON 6**  
**PERFORM MOUTH-TO-MOUTH RESUSCITATION**  
**(TASK 081-833-1042)**

**TASK:**

Identify procedures for opening the airway and performing rescue breathing (mouth-to-mouth or mouth-to-nose resuscitation) on a casualty who is not breathing.

**CONDITIONS:**

Given multiple-choice questions pertaining to restoring breathing to a casualty.

**STANDARD:**

Score 70 or more points on a 100-point comprehensive examination.

**REFERENCES:**

STP 21-1-SMCT, Soldier's Manual of Common Tasks: Skill Level 1.  
FM 21-11, First Aid for Soldiers.

**NOTE:** Some of the task titles and information have changed and are not reflected in FM 21-11 and STP 21-1-SMCT. For up-to-date task information, refer to the Army Training Support Center, Common Core Task internet site at:  
<http://www.atsc.army.mil/dld/comcor/comcore.htm>.

**6-1. INTRODUCTION**

The following procedures are used to restore respiration (breathing) to an unconscious casualty who is not breathing. These procedures are also used for a casualty who becomes unconscious (passes out or faints) while you are attempting to remove an upper airway blockage. The modified abdominal and chest thrusts can be used with a conscious casualty who is lying on his back.

**WARNING**

**Do not perform mouth-to-mouth resuscitation in a chemical environment.**

## 6-2. CHECK FOR RESPONSIVENESS

If you come upon a person who appears to be unconscious, check for responsiveness by gently shaking the person's shoulder and calling out, "Are you okay?" If the casualty does not respond, assume that mouth-to-mouth resuscitation is needed.

If possible, send someone to get medical help.

**CAUTION:** If you come upon a casualty who is in a dangerous area (under hostile fire, near a burning vehicle, etc.), remove the casualty (and yourself) from the danger before beginning mouth-to-mouth resuscitation.

## 6-3. POSITION THE CASUALTY FOR MOUTH-TO-MOUTH RESUSCITATION

If the casualty is not lying on his back, position the casualty face up on a firm surface.

**CAUTION:** The casualty should be carefully rolled as a unit so that his body does not twist. If a spinal injury is suspected and assistance is available, support the casualty's head and neck while one (or more) helpers gently turn the casualty's trunk and legs.

Straighten the casualty's legs. Take the casualty's arm that is nearest to you. Move it so that it is straight and above his head. Repeat the procedure with the other arm.

Kneel beside the casualty with your knees near his shoulders (leave space to roll the body). Place one hand behind the head and neck for support. With your other hand, grasp the casualty under the far arm (armpit area).

Roll the casualty toward you using a steady and even pull. The head and neck should stay in line with the back.

Return the casualty's arms to his sides. Straighten the casualty's legs. Reposition yourself so that you are now kneeling at the level of the casualty's shoulders.

## 6-4. OPEN THE CASUALTY'S AIRWAY

Many times an unconscious casualty's tongue may be blocking his airway. The muscles of the tongue relax when a person loses consciousness. The tongue may slide to the back of the mouth and cover the opening to the trachea (windpipe). Moving the tongue away from the trachea may result in the casualty resuming breathing on his own. Even if the casualty has not stopped breathing, the procedures for opening the airway will allow him to breathe easier.

The two preferred methods of opening the casualty's airway are the head-tilt/chin-lift method and the jaw thrust method. The jaw thrust method is used if you suspect that the casualty has suffered a neck injury or severe head injury (deformed-look, major wounds, etc.). The jaw thrust keeps movement of the neck to a minimum.

### Head-Tilt/Chin-Lift

**CAUTION:** Do not use the head-tilt/chin-lift method if a spinal or neck injury is suspected.

Kneel at the side of the casualty's head.

Place one of your hands on the casualty's forehead and apply firm, backward pressure with your palm. This will cause the casualty's head to tilt back.

Place the fingertips of your other hand under the bony part of the casualty's lower jaw and lift to bring the chin forward. The fingertips should not press deeply into the soft tissues under the chin since the pressure could make breathing difficult. Use your fingertips, not your thumb, to lift the chin.

**FIGURE 6-1. HEAD-TILT/CHIN-LIFT**

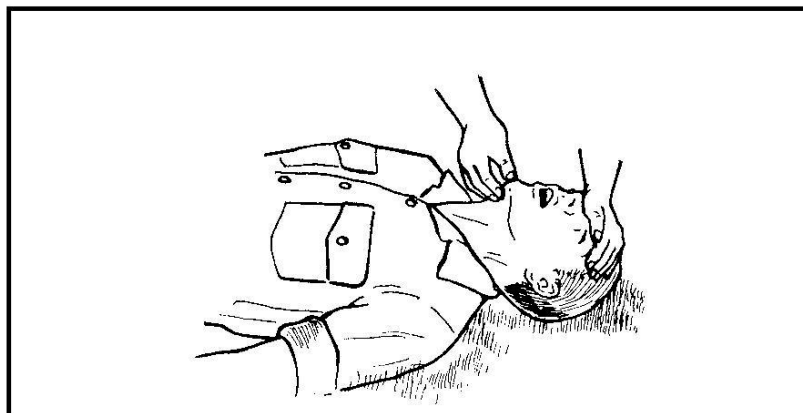

Lift the chin forward until the upper and lower teeth are almost brought together. The mouth should not be closed as this may block the airway. If needed, the thumb may be used to depress the casualty's lower lip slightly to keep his mouth open.

### Jaw Thrust

Kneel at the top of the casualty's head (looking toward the casualty's feet).

Rest your elbows on the ground or floor.

**FIGURE 6-2. JAW THRUST**

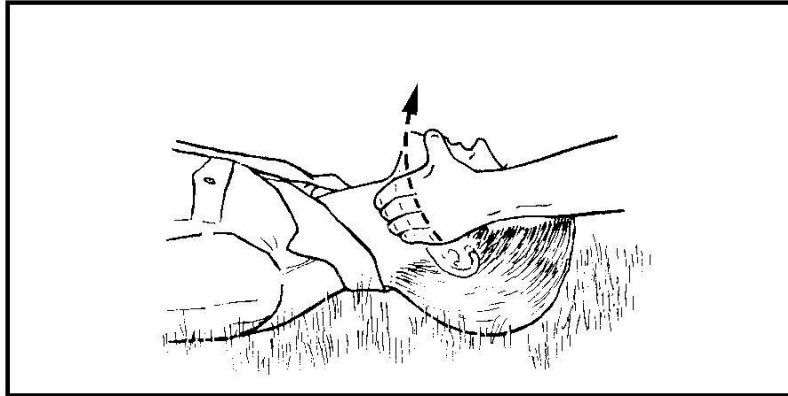

Place one hand on each side of the casualty's head and place the tips of the index and middle fingers under the angles of the casualty's lower jaw. Place your thumbs on the jaw just below the level of the teeth.

Raise your fingertips to lift the jaw forward (upward). This action will also cause the casualty's head to tilt backward somewhat.

If the casualty's lips are still closed after the jaw has been moved forward, use your thumbs to retract the lower lip and allow air to enter the casualty's mouth.

#### **6-5. CHECK FOR BREATHING**

Place your ear over the casualty's mouth and nose with your face toward the casualty's chest. Maintain the open airway (head-tilt/chin-lift or jaw thrust) during your check.

Look for the rise and fall of the casualty's chest and abdomen.

Listen for sounds of breathing.

Feel for his breath on the side of your face.

If the casualty is breathing and has good air exchange, keep his airway open and proceed to look for life-threatening injuries (massive bleeding, etc.). If he is not breathing or breathing weakly, start mouth-to-mouth resuscitation. The examination process should not take more than five seconds.

**FIGURE 6-3. CHECKING FOR BREATHING WHILE OPEN AIRWAY  
(HEAD-TILT/CHIN-LIFT)**



## **6-6. INITIATE MOUTH-TO-MOUTH RESUSCITATION**

### **Maintain Open Airway**

Keep the casualty's airway open during the rescue breathing process. Keeping the casualty's lower jaw forward prevents the tongue from blocking the airway.

### **Close Casualty's Nose**

If you are using the head-tilt/chin-lift, use the thumb and index finger of your hand on the casualty's forehead to gently pinch the casualty's nose closed. Let the same hand, pinching the nose closed, exert pressure on the casualty's forehead to maintain the backward head tilt and maintain an open airway. With the other hand, lift the chin while keeping your fingertips on the bony part of the lower jaw near the chin.

If you are using the jaw thrust technique (due to head, neck, spinal injury), close the casualty's nostrils by placing your cheek tightly against them. Do **not** tilt the casualty's head backward or side-to-side.

### **Administer Two Full Breaths**

Open your mouth wide and take a deep breath.

Place your mouth over the casualty's mouth. Make sure that your mouth forms a good seal so that air will not escape when you blow air into the casualty's mouth. Maintaining the open airway will keep the casualty's mouth open slightly.

Blow into the casualty's mouth. As you blow, observe the casualty's chest. If air is getting into the casualty's lungs, his chest will rise.



**FIGURE 6-4. ADMINISTERING MOUTH-TO-MOUTH RESUSCITATION  
(HEAD-TILT/CHIN-LIFT)**

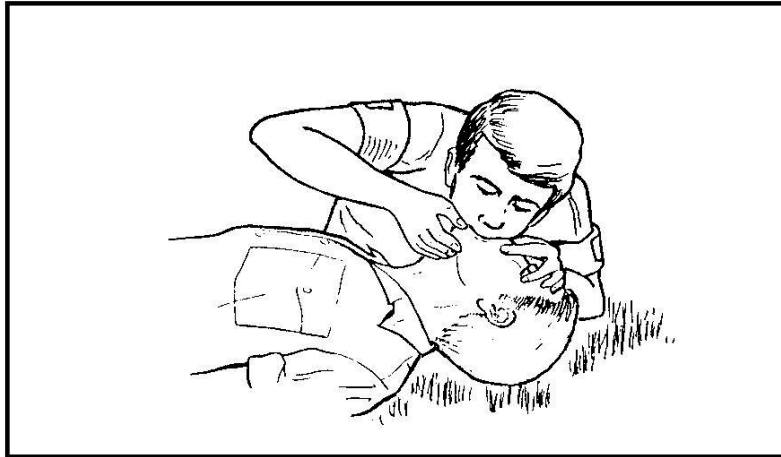

After blowing into the casualty's mouth, quickly break the seal and take another deep breath. Seal your mouth over the casualty's mouth again and blow. Administering the two breaths (ventilations) should take about two to three seconds.

Break the seal over the casualty's mouth and release his nose. This will allow the casualty's body to exhale.

**FIGURE 6-5. ADMINISTERING MOUTH-TO-NOSE RESUSCITATION  
(HEAD-TILT/CHIN-LIFT)**

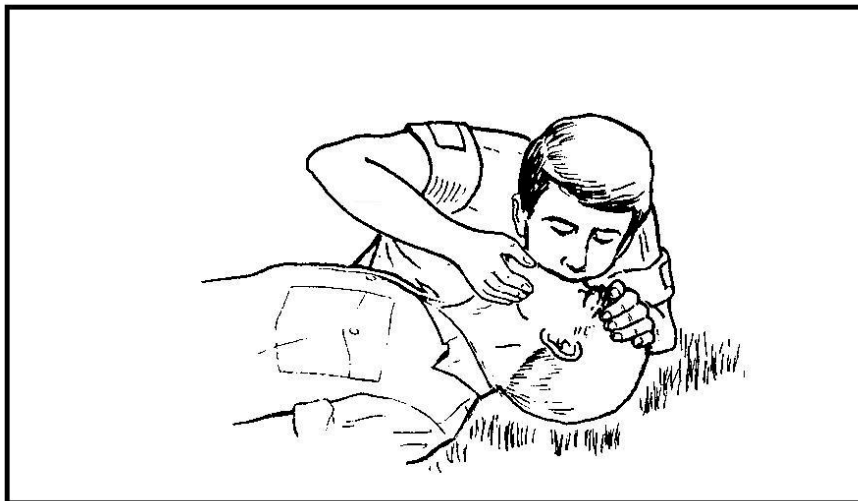

**CAUTION:** If you cannot seal off the casualty's nose or if the casualty has injuries to his mouth area that prevent you from administering mouth-to-mouth resuscitation, administer mouth-to-nose resuscitation. Close the casualty's mouth, seal your mouth over the casualty's nose, and blow two breaths into his nostrils.

### **Evaluate Effectiveness of the Ventilations**

If the casualty begins breathing again on his own, look for injuries. Then evacuate the casualty to a medical treatment facility. Do not leave the casualty alone since his breathing may stop again. The casualty may still require help to keep his airway open.

If air goes in and out of the casualty's lungs but he does not start breathing on his own, check his pulse. (Pulse beats mean that the heart is still pumping blood.)

You will normally check for a pulse using one of the two major arteries in the neck. One artery is in the groove on the left side of the windpipe; the other is in the groove on the right side of the windpipe. The grooves are created by the windpipe (trachea) and the large strap muscles of the neck. The arteries are called the carotid (kah rot' id) arteries; therefore, the pulse taken using either artery is called the carotid pulse. Either artery may be used to check the casualty's pulse.

Continue to maintain the casualty's airway. If the head-tilt/chin-lift method is being used, keep one hand pressing on the casualty's forehead.

Use the index and middle fingers of your free hand to feel for the artery in the groove next to the casualty's Adam's apple (larynx).

**FIGURE 6-6. FEELING FOR CAROTID PULSE**

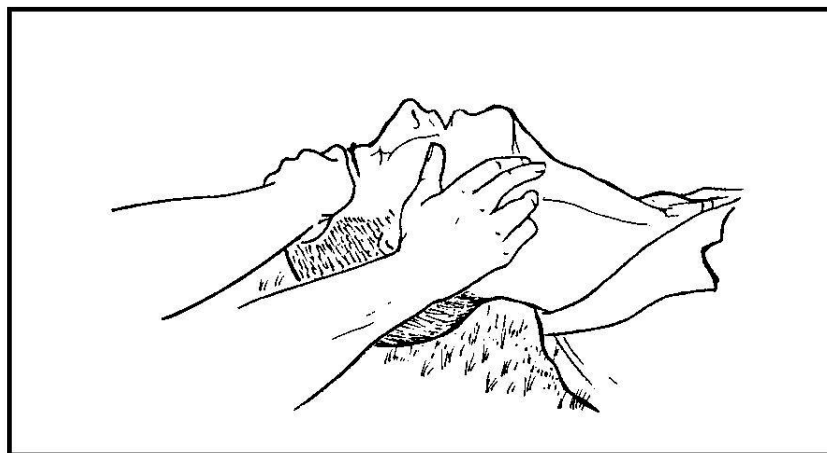

Once the artery is located, press on the pulse area gently with your two fingers for five to ten seconds and feel for a pulse. Look for signs of spontaneous breathing (rising and falling of the casualty's chest, etc.) while checking the pulse.

**CAUTION:** Do not use your thumb to feel for the casualty's pulse. If you use your thumb, you may feel the pulse in your thumb instead of the casualty's pulse.

Evaluate the situation and perform needed actions.

If the casualty has no pulse seek medical help immediately. If a casualty is without a pulse (heartbeat) for more than six minutes, he probably cannot be revived.

If the casualty has a pulse but is not breathing on his own, continue mouth-to-mouth resuscitation.

If the casualty resumes breathing on his own, check for bleeding and other injuries. Continue to monitor the casualty's breathing and be prepared to resume mouth-to-mouth resuscitation if needed. (NOTE: If a casualty is breathing on his own, he will also have a pulse.)

If the casualty's chest did not rise and fall, then fresh air is not getting into his lungs. Try to open the casualty's airway more. (If the head-tilt/chin-lift method is being used, lift the chin more. If the jaw thrust method is being used, tilt the head backward slightly.) Then administer two full breaths again. If the casualty's chest still does not rise, a foreign object is probably blocking his airway. Administer finger sweeps (see Perform Finger Sweep) and manual thrusts (see Perform Abdominal Thrusts or Perform Chest Thrusts) as needed in order to unblock his airway. Once the airway is unblocked, administer two full breaths again and reevaluate.

## **6-7. PERFORM FINGER SWEEP, IF NEEDED**

If you can see a foreign object in an unconscious casualty's mouth or if you strongly suspect the presence of a foreign object in an unconscious casualty's mouth, a finger sweep should be performed.

### **WARNING**

**Do not use the finger sweep technique if the casualty is conscious. The finger sweep can trigger the casualty's "gag reflex" and cause him to vomit.**

Open the casualty's mouth. If the casualty's mouth does not open readily, cross your finger and thumb and push his teeth apart. Lift the casualty's jaw using the tongue-jaw lift. Grasp the casualty's tongue and lower jaw between your thumb and fingers and lift the jaw. Moving the tongue and jaw makes foreign objects easier to locate.

Look inside the casualty's mouth to see if you can locate the obstruction.

Insert the index finger of your free hand down along the inside of the casualty's cheek to the base of his tongue.

Sweep the throat with a "hooking" motion. Many foreign objects can be dislodged by using a hooking action when moving your finger from the side of the casualty's mouth toward the center. You may need to push the object to the side of the casualty's throat before you can secure the object to be removed.

**CAUTION:** Take care to avoid forcing the object deeper into the casualty's airway.

Pull the object out of the casualty's throat.

Remove the object with your fingers.

Try to ventilate the casualty again (mouth-to-mouth or mouth-to-nose) and check for breathing.

If the casualty is breathing on his own, treat any major injuries and evacuate the casualty.

If the casualty's chest rises and falls but he does not breathe on his own, check the casualty's pulse.

If you are unable to ventilate the casualty (chest does not rise), perform manual thrusts (see Perform Abdominal Thrusts or Perform Chest Thrusts).

FIGURE 6-7. PERFORMING A FINGER SWEEP

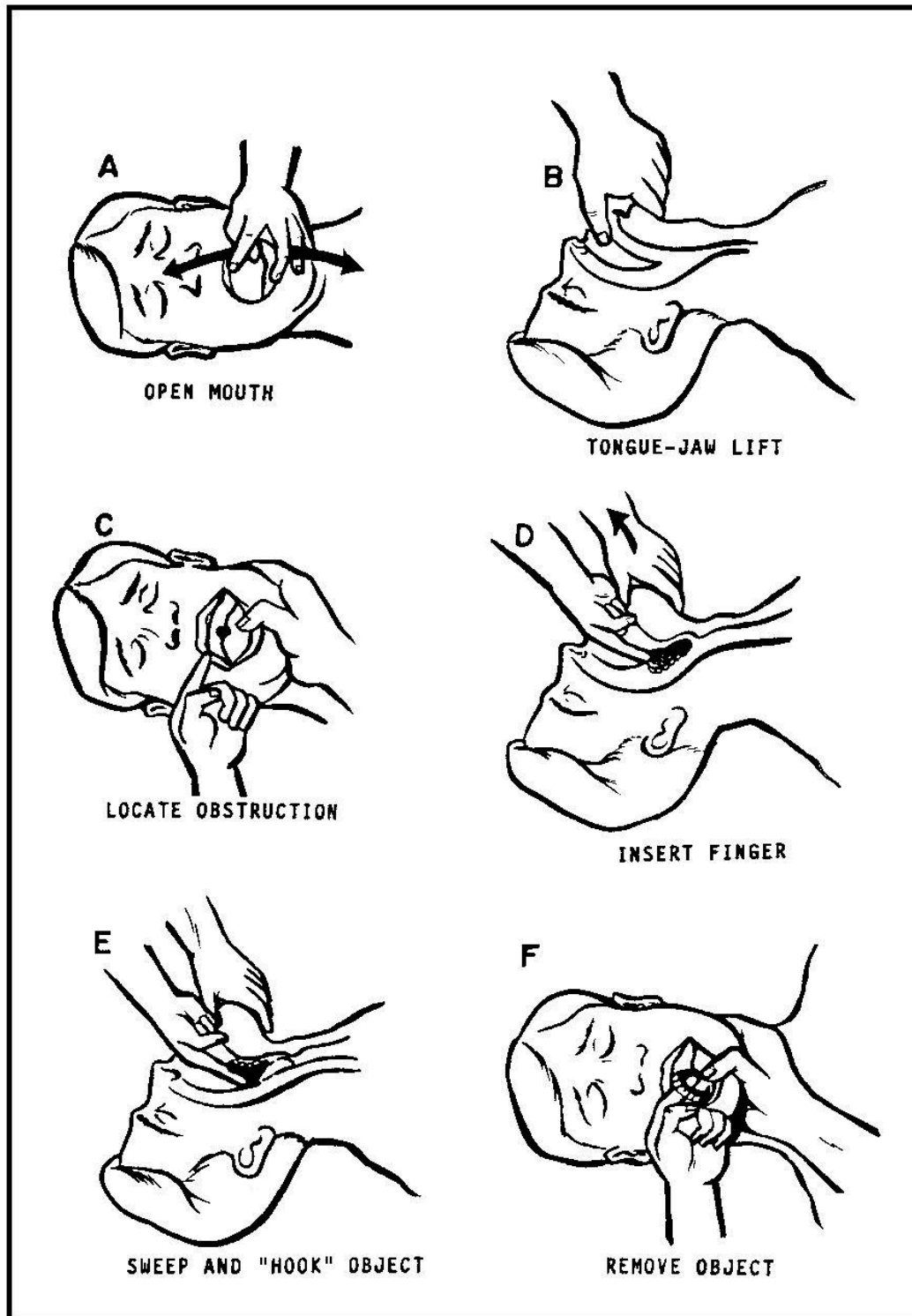

## 6-8. PERFORM ABDOMINAL THRUSTS, IF NEEDED

FIGURE 6-8. ADMINISTERING AN ABDOMINAL THRUST  
(CASUALTY IN SUPINE POSITION)

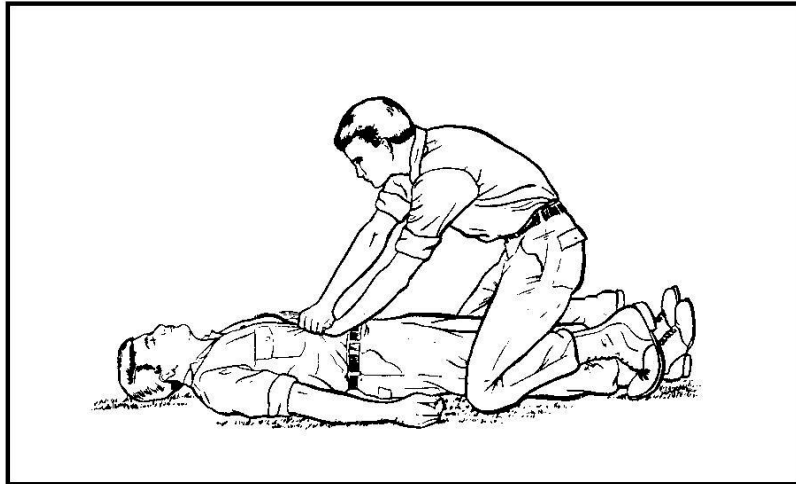

A manual thrust acts like an artificial cough. Each thrust is performed with the intent of dislodging the obstruction without having to perform additional thrusts. The abdominal thrust is usually the preferred method of administering a manual thrust.

### WARNING

**If the casualty has an abdominal wound, is noticeably pregnant, or is extremely overweight, use the chest thrust method.**

Kneel astride the casualty's thighs.

Place the heel of one hand against the middle of the casualty's abdomen. The heel should be slightly above the navel (belt buckle) and well below the tip of the breastbone (xiphoid process) with your fingers pointing toward the casualty's head. Do not make your hand into a fist.

Place the heel of your other hand on top of the heel of the hand on the casualty's abdomen.

Press into the abdomen using a quick forward (inward) and upward thrust. The thrust can be delivered by locking your elbows and shifting your body weight forward.

Release the pressure on the casualty's abdomen (shift your body weight backward).

Quickly evaluate the effectiveness of the thrust.

If the obstruction has been dislodged, perform a finger sweep to remove the obstruction, administer two full breaths, and evaluate their effectiveness.

If the obstruction was not dislodged, administer additional thrusts (up to five). If the obstruction is not expelled, call for help again. Then repeat the procedures for initiating resuscitation, perform a finger sweep, and administer abdominal thrusts again. Continue until the object is expelled and the casualty's airway is open (chest rises during ventilations).

**CAUTION:** If the casualty vomits, turn him onto his side and use a quick finger sweep to remove vomitus from his mouth.

## 6-9. PERFORM CHEST THRUSTS, IF NEEDED

The chest thrust is used to remove an airway obstruction in an unconscious casualty if the casualty has an abdominal wound, is noticeably pregnant, or is extremely overweight.

Kneel close beside the casualty's chest.

Locate the lower edge of the casualty's rib cage.

**FIGURE 6-9. LOCATING COMPRESSION SITE FOR CHEST THRUST**

Run the fingers of one hand (usually your dominant hand) along the lower edge of the

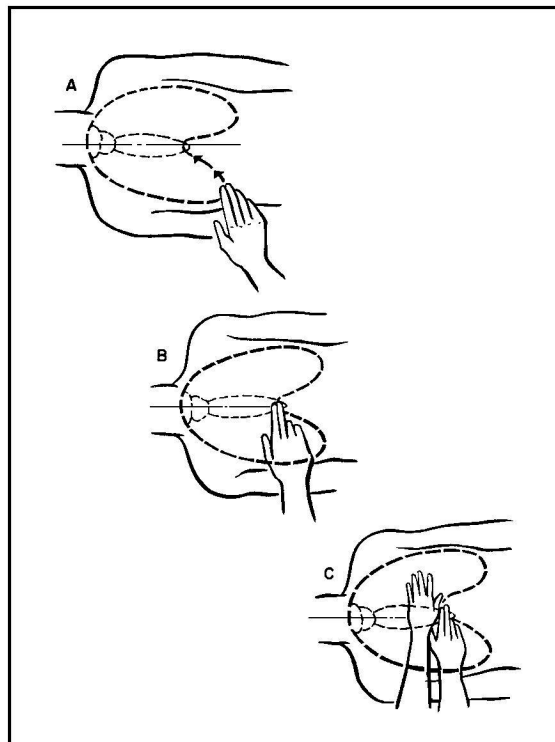

rib cage until you come to the notch where the rib meets the breastbone at the middle of the casualty's chest.

Place your middle finger on the notch. Then place your index finger next to your middle finger. Your index finger should now be on the lower end of the casualty's breastbone. (NOTE: This step assumes that your index finger is closer to the casualty's head than your middle finger. If not, put your index finger on the notch and your middle finger on the breastbone.) Place the heel of your other hand next to your two fingers and over the casualty's breastbone. Do not form a fist. The heel of your hand is on the compression site.

**CAUTION:** Make sure that your heel is on the breastbone and not resting on the ribs.

Remove your fingers from the notch area and place that hand on top of the hand on the compression site. Either extend or interlace your fingers.

Straighten your arms and lock your elbows. Position your shoulders directly above your hands.

**FIGURE 6-10. ADMINISTERING A CHEST THRUST  
(CASUALTY IN SUPINE POSITION)**

Using the weight of your body, apply enough pressure straight down to depress the

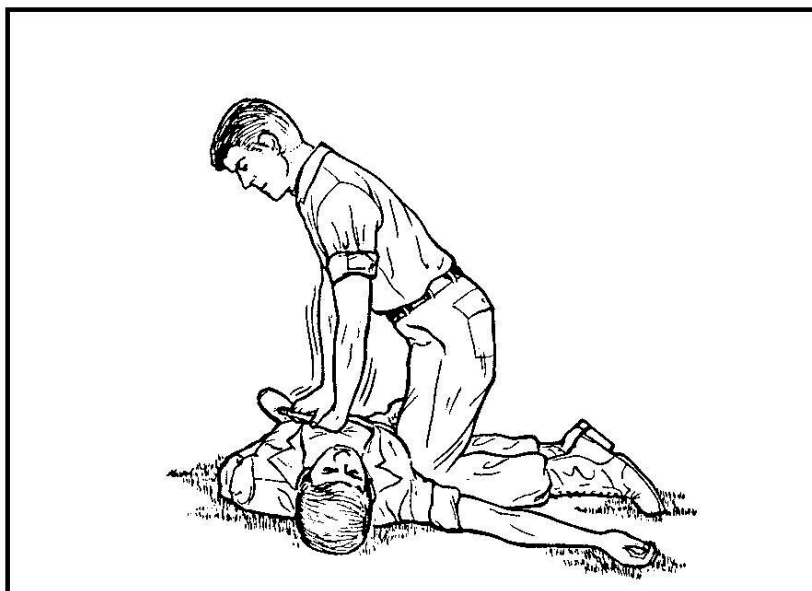

casualty's breastbone 1 to 2 inches.

**CAUTION:** Do not bend your elbows, rock, or allow your shoulders to sag while delivering the thrust. If the thrust is not delivered properly, it will lose some of its effectiveness and could result in additional injury.



Release the pressure by shifting the weight of your body from your arms. Do not remove your hands from the compression site. If you remove your hands from the site, repeat the procedures for locating the compression site. Delivering a thrust at the wrong compression site can injure the casualty.

Quickly evaluate the effectiveness of the thrust.

If the obstruction has been dislodged, perform a finger sweep to remove the obstruction, administer two full breaths, and evaluate their effectiveness.

If the obstruction was not dislodged, administer additional chest thrusts (up to five). If the obstruction is not expelled, call for help again. Then repeat the procedures for initiating resuscitation, perform a finger sweep, and administer chest thrusts again. Continue until the object is expelled and the casualty's airway is open (chest rises during ventilations).

## **6-10. CONTINUE MOUTH-TO-MOUTH RESUSCITATION**

Open the casualty's airway.

Take a breath.

Close the casualty's nostrils.

Seal your mouth over the casualty's mouth.

**CAUTION:** If the casualty has face injuries that prevent you from administering mouth-to-mouth resuscitation, close his mouth, seal your mouth over his nose, and administer mouth-to-nose resuscitation.

Blow the breath into the casualty's lungs. Observe the rising of the casualty's chest to ensure that the ventilation is effective.

Break your seal over the casualty's mouth and release his nose. Observe the casualty's chest fall and listen for exhalation.

**CAUTION:** If the chest does not rise and fall, reposition his airway (tilt head back more or lift jaw more) and try again until the chest rises and falls.

Repeat mouth-to-mouth (or mouth-to-nose) ventilations at the rate of about 10 to 12 ventilations per minute. Observe the chest to make sure that it is rising and falling.

After about one minute (12 ventilations), stop ventilating the casualty and check the casualty's carotid pulse. Observe the casualty's chest for spontaneous breathing

(breathing on his own without your help) as you feel for the pulse. The procedure should take 3 to 5 seconds.

Evaluate the situation and determine needed action.

If the casualty has no pulse and you are not qualified to administer CPR, seek medical aid for the casualty. If you are qualified to administer CPR, administer CPR and send someone to seek medical help.

If the casualty has a pulse and is breathing on his own, check for other injuries while continuing to monitor the casualty's breathing and pulse.

If the casualty has a pulse but is not breathing on his own, continue to administer mouth-to-mouth (or mouth-to-nose) resuscitation at the rate 10 to 12 ventilations per minute. Check the casualty's pulse after every 12 ventilations to ensure that his heart is still beating. When checking the casualty's pulse, also observe the casualty's chest to see if he is breathing on his own. Continue administering rescue breathing until spontaneous breathing occurs, you are relieved, you must seek medical help, or you are too exhausted to continue.

#### **6-11. MONITOR THE CASUALTY**

Once you have established that the casualty is breathing on his own (breathing spontaneously), continue to monitor the casualty's breathing. Ensure that the casualty's airway remains open. If breathing difficulties arise, call for help and repeat the steps for clearing the airway and performing rescue breathing, as needed.

## PRACTICE EXERCISES: LESSON 6

### Perform Mouth-To-Mouth Resuscitation

**INSTRUCTIONS:** Answer the following exercises by circling the letter of the response that best answers the question or best completes the sentence. Refer to the lesson text, if needed. After you have answered all of the exercises, check your answers against the "Solutions to Exercises" at the Appendix. For each exercise answered incorrectly, reread the lesson material referenced.

1. A person has an obstructed airway. You are preparing to administer abdominal thrusts to the person while he is standing. Suddenly he passes out. What should you do?
  - a. Administer abdominal thrusts while holding the person in a standing position.
  - b. Administer chest thrusts while holding the person in a standing position.
  - c. Lay the person on his back; then administer abdominal thrusts.
  - d. Lay the person in a prone (on his chest) position; then administer back blows.
  
2. While jogging in the park early one morning, you come upon a person lying on the grass who is apparently unconscious. What should be your first action in rendering aid to this person?
  - a. Check his pulse.
  - b. Call out "Are you okay?"
  - c. Begin administering abdominal thrusts.
  - d. Open his airway.
  - e. Perform a finger sweep of his mouth.
  
3. Which of the following methods of opening the airway is preferred if you believe that the casualty has an injured neck?
  - a. Head-tilt/chin-lift.
  - b. Head-tilt/neck-lift.
  - c. Jaw thrust.

4. In the head-tilt/chin-lift method of opening a casualty's airway, one hand is used to press on his forehead. How is the thumb on the opposite hand used?
  - a. Lifts the casualty's chin by hooking the thumb under the casualty's jaw.
  - b. Keeps the casualty's lower lip depressed, if needed.
  - c. Hooks over the casualty's bottom teeth to ensure a good grip on the casualty's chin.
  - d. Presses against the casualty's nose to seal off his nostrils.
5. When performing the head-tilt/chin-lift method of opening a casualty's airway, you \_\_\_\_\_ allow your fingers to press deeply in the soft tissues under the chin.
  - a. Should.
  - b. Should not.
6. When you check for breathing, you should:
  - a. Watch the casualty's chest.
  - b. Listen for sounds of breathing.
  - c. Be aware of any exhaled breath blowing against your face.
  - d. Do all of the above.
7. In which of the following cases would mouth-to-nose ventilations probably be preferred to mouth-to-mouth ventilations?
  - a. Casualty is pregnant.
  - b. Casualty has a broken arm.
  - c. Casualty has a broken jaw and cheek injuries.
  - d. Casualty has suffered a blow to the back of the head.

8. You find an unconscious person who does not appear to be breathing. After using the head-tilt/chin-lift method of opening an airway, he begins to breathe normally without rescue breathing being administered. What should you do now?
  - a. Help keep the person's airway open and check for injuries.
  - b. Begin rescue breathing.
  - c. Turn the person onto his chest.
  - d. Begin cardiopulmonary resuscitation.
  
9. Which of the following is a correct location for checking the casualty's pulse while performing rescue breathing?
  - a. Over the casualty's Adam's apple.
  - b. The groove to the right of the casualty's Adam's apple.
  - c. The groove to the left of the casualty's Adam's apple.
  - d. Choices b and c above.
  - e. Choices a, b, and c above.
  
10. You are beginning to provide care to an unconscious casualty and have just tried to initiate mouth-to-mouth resuscitation, but the casualty's chest does not rise and fall. What should you do next?
  - a. Leave the casualty and seek medical help.
  - b. Perform a finger sweep of the casualty's mouth.
  - c. Slap the casualty on the back between his shoulder blades.
  - d. Open the casualty's airway more and try to administer two breaths again.
  
11. When helping a person with an airway obstruction, finger sweeps are used:
  - a. Only if the casualty is conscious.
  - b. Only if the casualty is unconscious.

12. You are preparing to administer an abdominal thrust to a casualty lying on his back. How should you position your hands?
- The heel of one hand should be placed midway between the casualty's navel and his groin. The other hand should be on his forehead.
  - Form a fist with one hand and place it on the casualty's navel. Form a fist with the other hand and place it on the casualty's abdomen just above the first fist. The thumb of one fist should be touching the index finger of the other fist.
  - The heel of one hand should be placed slightly above the casualty's navel. The other hand should be on top of the first hand.
  - Form a fist with one hand and place it on the notch where the lower edge of the casualty's rib cage meets the breastbone. Then wrap your other hand around the fist.
13. When delivering a chest thrust to an unconscious casualty, the casualty's breastbone should be pushed straight down about:
- One-half inch.
  - Two inches.
  - Three inches.
  - Four inches.
14. You are going to administer chest thrusts to an unconscious casualty. How should your hands be placed?
- The heel of one hand should be on the lower half of the breastbone but above the notch where the lower ribs meet the breastbone. The other hand should be on top of the first hand.
  - Form a fist with one hand and put it in the middle of the breastbone. Wrap the other hand around the fist.
  - The heel of one hand should be slightly below the notch where the lower ribs meet the breastbone. The other hand should be on top of the first hand.
  - The heel of one hand should be just below the middle of the breastbone. The heel of the other hand should be just above the middle of the breastbone.

15. You are administering mouth-to-nose resuscitation. You should administer about:
- One breath every minute.
  - Five breaths every minute.
  - Twelve breaths every minute.
  - Sixty breaths every minute.
16. You are administering rescue breathing. You have checked the casualty's pulse and found that his heart is still beating. When do you check his pulse again?
- After each breath.
  - After every six breaths.
  - After every twelve breaths.
  - Only after his heart stops beating.
17. Once you have restored breathing to a casualty, you:
- Do not have to worry any more about his breathing.
  - Should monitor his breathing in case you need to perform rescue breathing again.

Check your answers

## LESSON 7

### PERFORM FIRST AID FOR BLEEDING OF AN EXTREMITY (TASK 081-831-1032)

#### TASK:

Identify procedures for applying a field dressing, a pressure dressing, or a tourniquet to a bleeding extremity.

#### CONDITIONS:

Given multiple-choice examination items pertaining to controlling bleeding.

#### STANDARD:

Score 70 or more points on a 100-point comprehensive examination.

#### REFERENCES:

STP 21-1-SMCT, Soldiers Manual of Common Tasks: Skill Level 1.  
FM 21-11, First Aid for Soldiers.

**NOTE:** Some of the task titles and information have changed and are not reflected in FM 21-11 and STP 21-1-SMCT. Refer to the Army Training Support Center, Common Core Task internet site at: <http://www.atsc.army.mil/dld/comcor/comcore.htm> for up-to-date task information.

#### 7-1. INTRODUCTION

A casualty who is losing blood rapidly (hemorrhaging) may die unless the bleeding is stopped. Bleeding from an extremity (arm or leg) can usually be controlled by applying a dressing and bandage, applying manual pressure, elevating the injured limb, and (if necessary) applying a pressure dressing. If these methods do not control the bleeding, a tourniquet may be required. (NOTE: The procedures in this lesson are used to control bleeding from an upper arm, forearm, thigh, or lower leg. Bleeding from the head or trunk is discussed in other lessons.)

A dressing is the material that is placed directly over the wound. The dressing absorbs some of the blood and helps to cause a clot to form. The clot helps to "plug" the wound and stop the bleeding. The dressing also helps to prevent further contamination of the wound and provides protection to the injured area.

A bandage is the material used to hold (secure) the dressing in place so the dressing will not slip off the wound. The ends of the bandage are called the "tails."



Each soldier is issued a field dressing, which is carried in a plastic case (individual field first aid case). The field dressing consists of a sterile (germ-free) white pad of dressing with a bandage (usually olive-drab in color) already attached to the dressing pad. The dressing and bandage combination is wrapped in paper and then sealed in a plastic envelope. The field dressing is also called the field first aid dressing and the combat dressing.

**FIGURE 7-1. FIELD DRESSING WITH CASE**

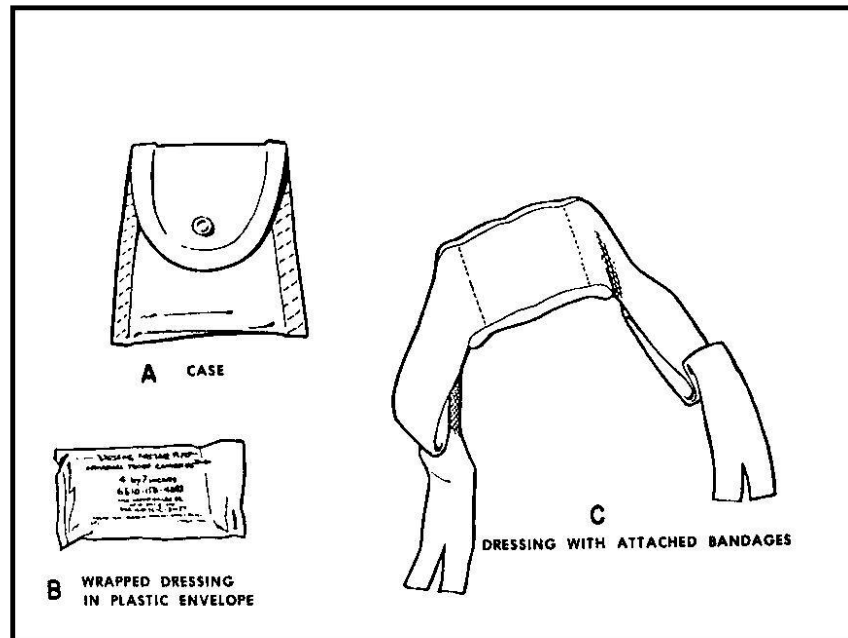

## 7-2. EXPOSE THE WOUND

### WARNING

**If you are in a chemical environment, do not expose the wound.  
Place the dressing over the wound and protective clothing.**

Expose the wound by tearing, cutting, and/or lifting the casualty's clothing and other material away from the wound. The entire wound area is exposed so that you can see the full extent of the injury. If clothing is stuck to the wound area, do not try to remove that part of the clothing from the wound. Do not try to remove objects from the wound.

Avoid causing additional damage to the wound.

If the wound was caused by a bullet, shrapnel, or other projectile, look for both an entry wound and an exit wound.

## 7-3. APPLY AND SECURE FIELD DRESSING

After you have exposed the wound, remove the field dressing from the casualty's first aid case. (You need to keep your field dressing in case you are injured.)

Tear the plastic envelope and remove its contents.

Twist the paper wrapper until it breaks or tear it open.

Grasp the folded bandages/tails with both hands.

**FIGURE 7-2. APPLYING AND SECURING A FIELD DRESSING**

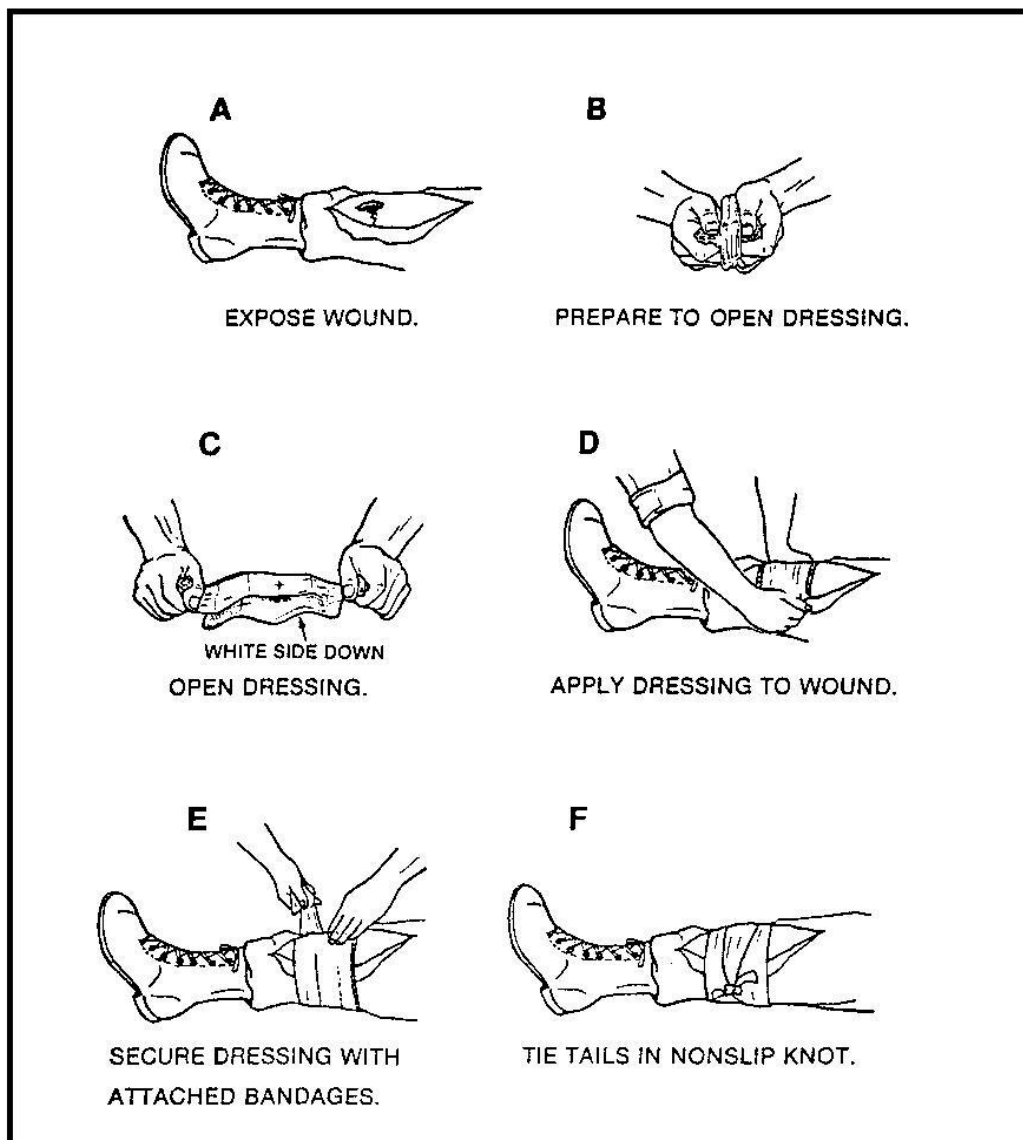

Pull on the tails so that the dressing opens and flattens.

**CAUTION:** Do not touch the white sterile side of the dressing.

Place the dressing over the wound. Remember, the white side of the dressing goes next to the wound.

Use one hand to hold the dressing in place. If the casualty is conscious, you can have him hold the dressing in place while you secure it.

Wrap one of the bandages around the injured limb with your free hand. As you wrap, cover one of the exposed sides of the dressing with the bandage. (The bandage can usually be wrapped around the limb more than once.) Bring the tail back over the dressing.

Wrap the other bandage around the injured limb in the opposite direction. As you wrap, cover the remaining exposed side of the dressing with the bandage. Bring the tail back to the dressing.

Tie the tails into a nonslip knot over the outer edge of the dressing, not over the wound itself. (Tying the knot over the wound could cause additional injury to the wound site.) The tails should be tight enough so that the dressing will not slip, but not tight enough to interfere with blood circulation.

Check the circulation below (distal to) the bandage. If the skin below the bandage becomes cool to the touch, bluish, or numb, the bandage may be too tight and interfering with circulation. Loosen and retie the tails, then check the circulation again. If circulation is not restored, evacuate the casualty as soon as possible.

**CAUTION:** Do not remove the dressing from the wound. Removing the dressing would interfere with any clot which had begun to form.

#### 7-4. APPLY MANUAL PRESSURE

FIGURE 7-3. APPLYING MANUAL PRESSURE

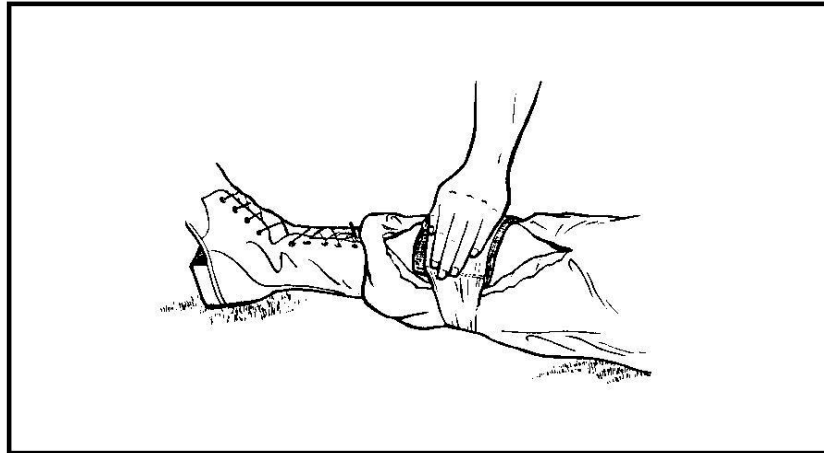

Apply direct pressure over the dressing with your hand. This pressure will help to compress the damaged blood vessels and control the bleeding. Maintain this pressure for five to ten minutes. If the casualty is conscious and can follow instructions, you can have him apply the manual pressure himself.

#### 7-5. ELEVATE THE WOUND

FIGURE 7-4. ELEVATING THE WOUND

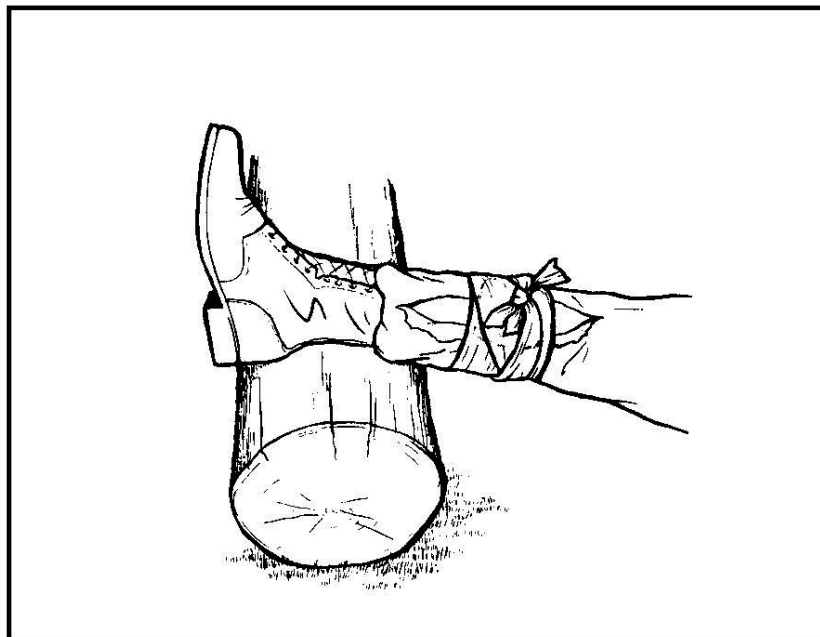

## WARNING

**Examine the injured extremity for fractures (visible broken bone, deformity of the limb, etc.). If a fracture is suspected, do not elevate the wound until the limb has been splinted (Lesson 12).**

Elevate the injured limb above the level of the casualty's heart. Elevating the limb will help to decrease the bleeding. For example, an injured leg can be raised by placing the foot on a pack, log, rock, or other object. An injured forearm can be elevated by placing the forearm on the casualty's chest if he is lying on his back or by having the casualty place his arm on top of his head if he is sitting up. Elevating the injured limb and applying manual pressure should be done at the same time when no fracture is involved.

### 7-6. APPLY A PRESSURE DRESSING

If blood continues to seep from the dressing even after you secure the dressing, apply manual pressure, and elevate the wound (if applicable), then a pressure dressing is needed to help stop the bleeding. The objective of applying a pressure dressing is to stop bleeding, not to stop all blood circulation below the wound. (Stopping all blood circulation would endanger the body tissue located below the bandage since these tissues would not receive the oxygen and nutrients carried by the blood.)

## WARNING

**A pressure dressing is applied only to a wound on an extremity.**

Place a wad of material on top of the dressing and directly over the wound. The wad can be made by folding a rag, material torn from clothing, or any other bulky material.

**CAUTION:** The field dressing is not removed; the bandages are not loosened and retied. Moving the dressing would interfere with any clot which had begun to form.

Place a bandage over the wad of padding and wrap the bandage tightly around the wound. The bandage can be a triangular bandage folded into a cravat (see figure 7-6), handkerchief, sock, strip of cloth torn from a shirt, or other similar material. Narrow materials like shoestrings are not used since they are likely to damage blood vessels and nerve tissue.

Tie the ends of the bandage to secure the padding. A nonslip knot should be tied directly over the wound. The bandage should be tight enough so that only the tip of one finger can be inserted under the bandage. Do not tie the bandage so tight that it cuts off all blood circulation.

FIGURE 7-5. APPLYING A PRESSURE DRESSING

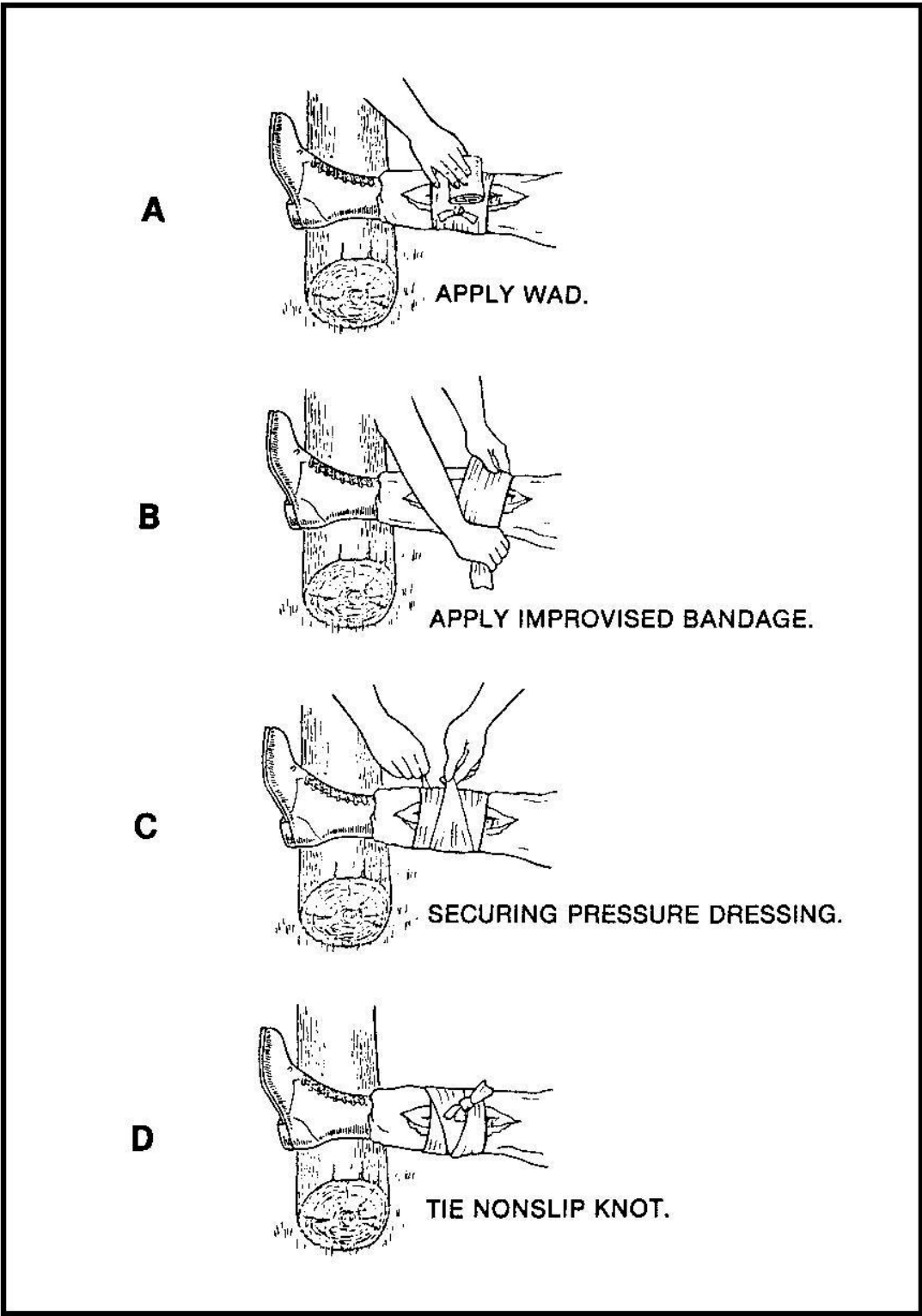

Tie the ends of the bandage to secure the padding. A nonslip knot should be tied directly over the wound. The bandage should be tight enough so that only the tip of one finger can be inserted under the bandage. Do not tie the bandage so tight that it cuts off all blood circulation.

Check the circulation below the pressure dressing. If the skin below the bandage becomes cool to the touch, bluish, or numb, the pressure dressing may be too tight. If so, loosen and retie the tails. If circulation is not restored, evacuate the casualty as soon as possible. (The pressure dressing can be loosened and retied without disturbing the blood clot forming under the field dressing.)

Apply manual pressure over the pressure dressing.

If use of a pressure dressing controls the bleeding, proceed to check the casualty for other injuries. If the wound continues to bleed profusely, apply a tourniquet.

## **7-7. TOURNIQUET**

A tourniquet is placed around an arm (upper arm or forearm) or leg (thigh or lower leg) in order to stop the flow of the blood below the tourniquet. It is used only when the amount of blood being lost endangers the casualty's life and the bleeding cannot be stopped by the application of a field dressing, manual pressure, elevation, and pressure dressing.

### **WARNING**

**A tourniquet is applied only to an upper arm, forearm, thigh, or lower leg. It is not used for wounds to the head, neck, or trunk or for a wound on the hand or foot.**

## **7-8. GATHER MATERIALS FOR MAKING A TOURNIQUET**

### **Tourniquet Band**

You will need a band of strong, pliable material which is at least two inches wide when folded. A folded muslin bandage (usually called a cravat), a folded handkerchief, or a folded strip of clothing will do. Do not use wire or shoestrings for a tourniquet band. A two-inch wide tourniquet will protect the tissue beneath the tourniquet when it is tightened. If a very narrow tourniquet is used, the nerves and blood vessels beneath the tourniquet may be seriously damaged.

FIGURE 7-6. FOLDING A MUSLIN BANDAGE OR A SQUARE OF MATERIAL INTO A TOURNIQUET BAND

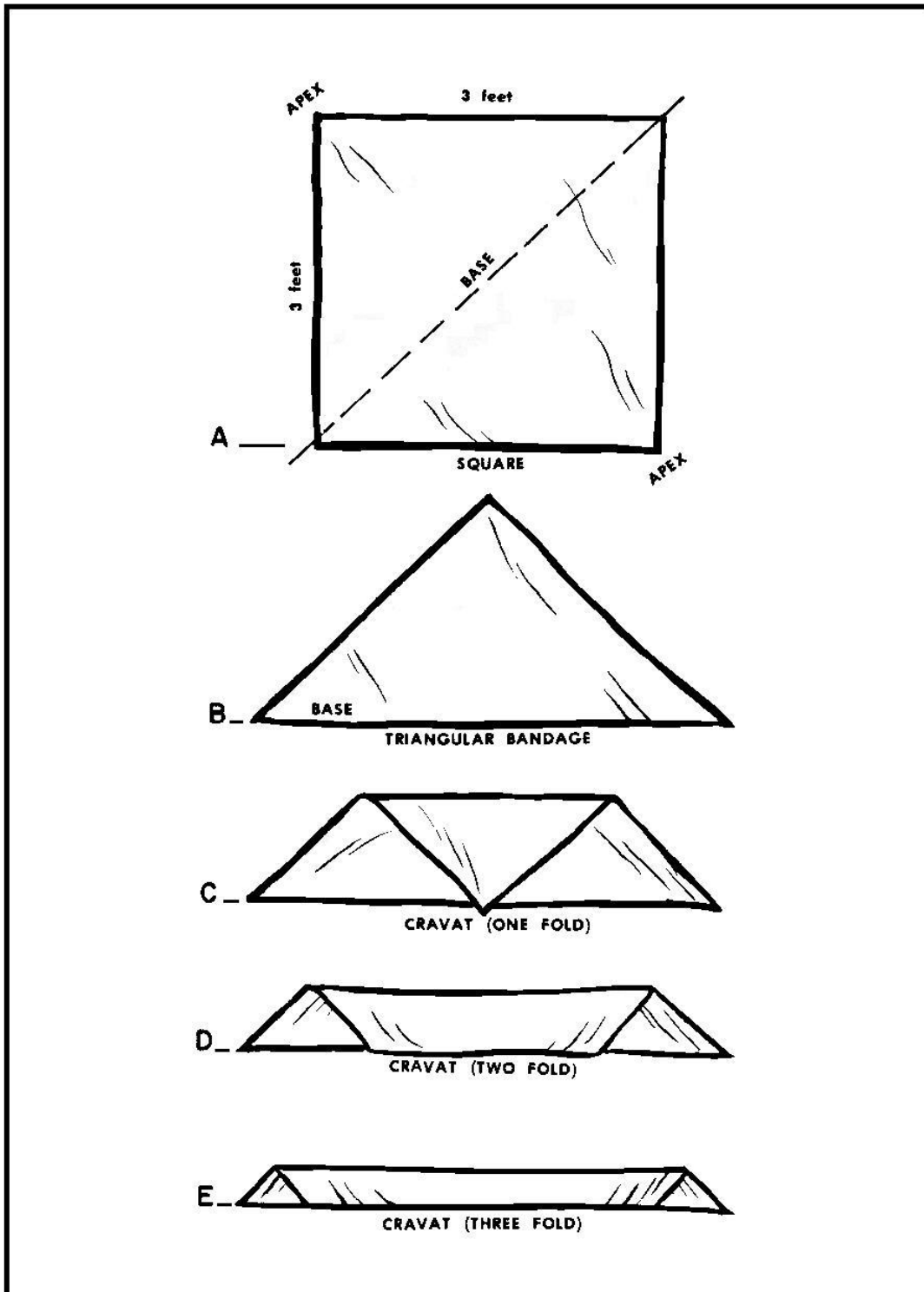



## **Rigid Object**

A rigid object, usually a stick, is needed to tighten the tourniquet.

## **Securing Materials**

Material is needed to secure the rigid object once the tourniquet has been tightened. A piece of cloth such as is used for the tourniquet will do. If the tourniquet band is long enough, the tails can be used to secure the rigid object.

## **Padding**

Padding is placed between the limb and the tourniquet band to protect the skin from being pinched and twisted when the band is tightened. Soft, smooth material should be used for padding. The casualty's shirt sleeve or trouser leg can be used as padding.

## **7-9. APPLY A TOURNIQUET TO A WOUND**

### **WARNING**

**A tourniquet is used only when the amount of blood being lost endangers the casualty's life and all other methods of controlling the bleeding have failed. Since the tourniquet will stop blood circulation, the body tissues below (distal to) the tourniquet will not receive oxygen and nutrients. The limb part located below the tourniquet may need to be amputated when the casualty reaches a medical treatment facility.**

The tourniquet should be placed two to four inches above the edge of the wound (between the wound and the heart). If the wound is just below the elbow or knee, the tourniquet should be placed above the joint and as close to the joint as possible. Do not place the tourniquet over the elbow or knee.

Place padding around the limb where the tourniquet will be applied. If the casualty's shirt sleeve or pants leg is covering the tourniquet site, smooth the shirt or pants material and apply the tourniquet over the clothing.

Place the tourniquet band material around the tourniquet site.

Tie the band with a half knot. (A half knot is the same as the first part of tying a shoe.)

Place the rigid object on top of the half knot.

Tie a full knot over the rigid object.

Twist the rigid object either clockwise or counterclockwise until the tourniquet is tight and the bright red bleeding has stopped. (Bright red blood is from a severed artery. Darker blood is from a vein. Dark blood may continue to ooze even after the tourniquet has been properly applied.)

Wrap the tails of the tourniquet band around the end of the rigid object so the rigid object will not untwist.

Wrap the tails around the limb (arm or leg) and tie the tails so that the rigid object stays secure.

If the rigid object cannot be secured with the tails of the tourniquet band, wrap a piece of material around the limb below the tourniquet, wrap the material around one end of the rigid object so that the tourniquet will not unwind, and tie the tails of the material in a nonslip knot. (NOTE: The rigid object is secured below the tourniquet so the securing material will not interfere with blood circulation above the tourniquet.)

**FIGURE 7-7. APPLYING A TOURNIQUET**

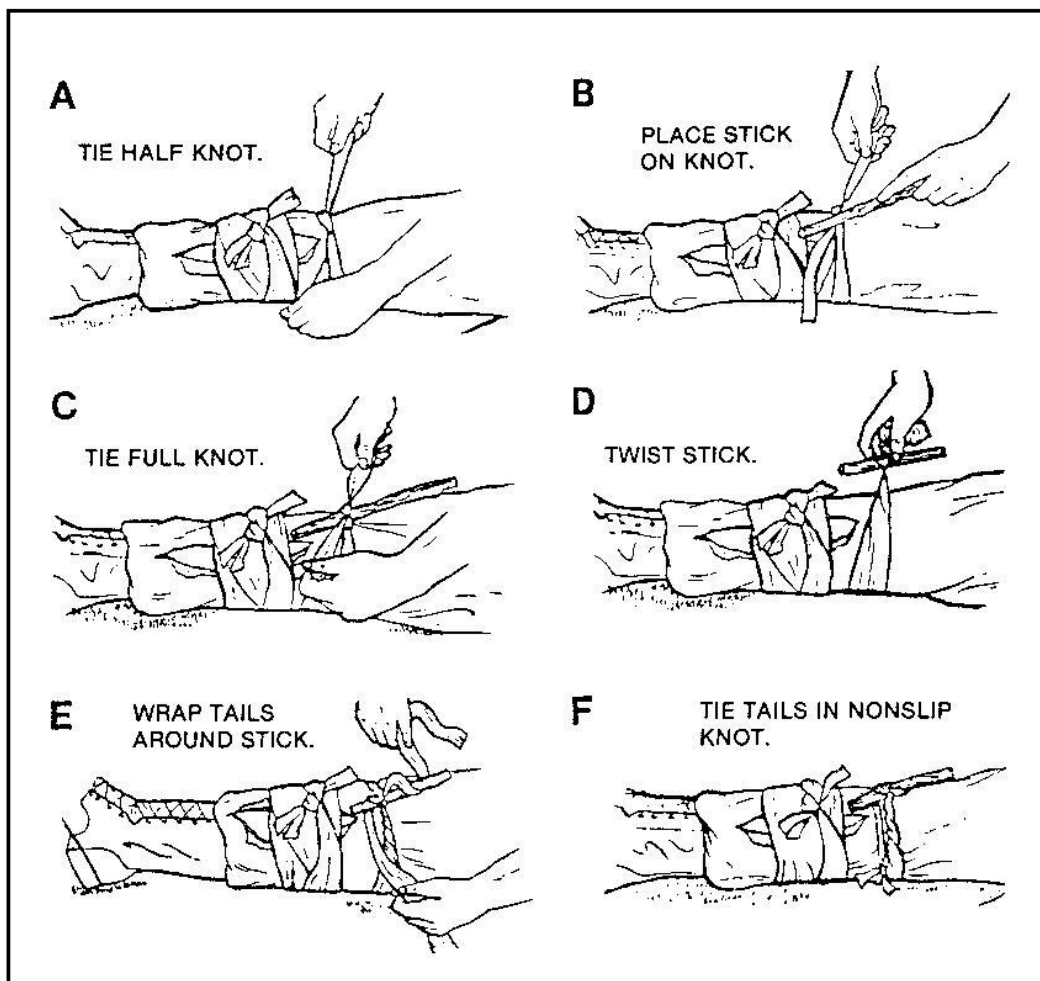

## WARNING

**Do not loosen the tourniquet once it is in place and has stopped the blood flow. If it is loosened, the wound will start to bleed again. The additional blood loss may cause the casualty to go into shock, which could be fatal. A tourniquet should only be loosened by medical personnel.**

### 7-10. APPLY A TOURNIQUET TO AN AMPUTATION

An upper arm, forearm, thigh, or lower leg that has been completely severed (amputated) requires a tourniquet. A tourniquet is to be applied to an arm or leg that has been amputated even if the stump is not bleeding. The absence of blood is due to the body's normal defenses (constriction of blood vessels), but the stump will begin to bleed profusely when the blood vessels relax.

## WARNING

**Bleeding from the amputation of part of a hand or part of a foot can be controlled through pressure dressing, manual pressure, and elevation and does not require the application of a tourniquet.**

The tourniquet should be applied two to four inches above the edge of the amputation. If the limb has been amputated just below the knee or elbow, apply the tourniquet just above the joint. Do not attempt to control the bleeding by applying field and pressure dressings prior to applying the tourniquet.

If possible, place padding around the tourniquet site.

Place the tourniquet band around the tourniquet site. Use the rigid object to tighten the band and stop the blood flow. Then secure the rigid object to prevent the tourniquet from loosening. The procedures are the same as given in the previous paragraphs.

After the tourniquet has been applied, place a dressing made of soft, absorbent material over the end of the stump and secure the dressing with bandages. The dressing will help prevent additional contamination of the wound and will help to protect the wound from additional injury.

If possible, locate and save the severed body part. When the casualty is evacuated, transport the body part with the casualty.

**CAUTION:** Make sure that the severed body part is kept out of the casualty's sight both before and during the evacuation.

## 7-11. MARK THE CASUALTY

Write a "T" on the casualty's forehead using a pen, the casualty's blood, mud, or other substance. The "T" alerts medical personnel that a tourniquet has been applied. Also include the time and date the tourniquet was applied, if possible. This information is important to medical personnel who treat the casualty.

**CAUTION:** Do not cover the tourniquet. Leave the tourniquet in full view so it can be located quickly by medical personnel.

## PRACTICE EXERCISES: LESSON 7

### Perform First Aid for Bleeding of An Extremity

**INSTRUCTIONS:** Answer the following exercises by circling the letter of the response that best answers the question or best completes the sentence. Refer to the lesson text, if needed. After you have answered all of the exercises, check your answers against the "Solutions to Exercises" at the Appendix. For each exercise answered incorrectly, reread the lesson material referenced.

1. The material placed on the wound to absorb the blood is called the \_\_\_\_\_; the material which is used to keep the first pad of material from slipping off the wound is called the \_\_\_\_\_.
  - a. Bandage; dressing.
  - b. Dressing; bandage.
  
2. A casualty is bleeding from a wound in the leg. In which of the following cases would you not remove the trouser material from the wound area?

---

  - a. The material is stuck to the wound.
  - b. Nerve agents are being used in your area.
  - c. The wound was caused by a bullet.
  - d. Choices a and b above.
  - e. Choices a, b, and c above.
  
3. When applying a field dressing to a casualty's wound, remove the field dressing from \_\_\_\_\_ field first aid case and apply the field dressing to the wound with the white side of the field dressing facing \_\_\_\_\_ the wound.
  - a. The casualty's; toward.
  - b. The casualty's; away from.
  - c. Your; toward.
  - d. Your; away from.

4. A casualty has a gash on his forearm. You have applied a field dressing to the wound. What must you do before elevating the wound?

---

  - a. Apply manual pressure.
  - b. Apply a second field dressing.
  - c. Check the arm for fractures.
  - d. Apply a pressure dressing.
  - e. Remove the field dressing.
5. When applying manual pressure to a dressed wound, your hand should apply pressure:
  - a. Directly over the wound.
  - b. Two to four inches above the wound.
  - c. Two to four inches below the wound.
  - d. To the artery at the primary joint located above (proximal to) the wound.
6. A pressure dressing is applied:
  - a. Two to four inches above the field dressing.
  - b. On top of the field dressing.
  - c. Two to four inches below the field dressing.
7. Which of the following statements is true?
  - a. The function of a field dressing is to stop all blood flow below the wound.
  - b. The function of a pressure dressing is to stop all blood flow below the wound.
  - c. The tails of a field dressing should be tied in a nonslip knot directly over the site of the wound.
  - d. The tails of a pressure dressing should be tied in a nonslip knot directly over the site of the wound.

8. A casualty is bleeding from a wound on his forehead. You have applied a field dressing, but the wound is still bleeding. Should you apply a pressure dressing to the wound?
  - a. Yes.
  - b. No.
  
9. You are going to apply a tourniquet band made from folded material. The band should be a least \_\_\_\_\_ wide.
  - a. ½ inch.
  - b. 1 inch.
  - c. 1½ inches.
  - d. 2 inches.
  
10. Which one of the following would be preferred for a tourniquet band?
  - a. A wire that is 36 inches long.
  - b. A bootlace.
  - c. A very strong rubber band.
  - d. A square of cloth about 36 inches on each side.
  
11. If the amputation site is about one inch below the knee or elbow joint, the tourniquet is applied:
  - a. Between the wound and the joint.
  - b. Directly over the joint.
  - c. Immediately above the joint.
  - d. Four to six inches above the joint.

12. Which one of the following statements is true?
- a. A tourniquet should be loose enough so that you can slip two fingers under the tourniquet.
  - b. A tourniquet should be loose enough so that you can slip the tip of one finger under the tourniquet.
  - c. A tourniquet is to be tightened until the bright red bleeding has stopped. Darker blood that oozes from the wound can be ignored.
  - d. A tourniquet is to be tightened until both the bright red bleeding and the darker venous bleeding have stopped completely.
13. Once you have tightened the tourniquet, you must:
- a. Check the casualty's carotid pulse.
  - b. Secure the rigid object so that the tourniquet does not unwind.
  - c. Apply a field dressing over the rigid object.
  - d. Remove the rigid object and tie the tails in a nonslip knot.
14. Should padding be placed between the tourniquet band and the casualty's limb?
- a. Yes.
  - b. No.
15. The lower part of the casualty's arm has been amputated. You have applied a tourniquet. How is the stump treated?
- a. The stump is dressed and bandaged.
  - b. The stump is left exposed to facilitate drainage.
16. Once the tourniquet has been applied, should it be covered with a blanket, poncho, or similar material?
- a. Yes.
  - b. No.
17. You have applied a tourniquet to a casualty's left leg. Which one of the following is a proper method of marking the casualty?



- a. Write a "T" on the casualty's forehead.
- b. Write a "T" on the dressing over the stump.
- c. Write "LL" on the casualty's forehead.
- d. Write "LL" on the dressing over the stump.
- e. Write your initials on the casualty's chest.

Check your answers

**LESSON 8**  
**PERFORM FIRST AID FOR AN OPEN CHEST WOUND**  
**(TASK 081-831-1026)**

**TASK:**

Identify procedures for performing first aid on a casualty with an open chest wound.

**CONDITION:**

Given multiple-choice examination items pertaining to chest wounds.

**STANDARD:**

Score 70 or more points on a 100-point comprehensive examination.

**REFERENCES:**

STP 21-1-SMCT, Soldier's Manual of Common Tasks: Skill Level 1.  
FM 21-11, First Aid for Soldiers.

**NOTE:** Some of the task titles and information have changed and are not reflected in FM 21-11 and STP 21-1-SMCT. Refer to the Army Training Support Center, Common Core Task internet site at: <http://www.atsc.army.mil/dld/comcor/comcore.htm> for up-to-date task information.

**8-1. INTRODUCTION**

**FIGURE 8-1. EFFECTS OF AN OPEN CHEST WOUND**

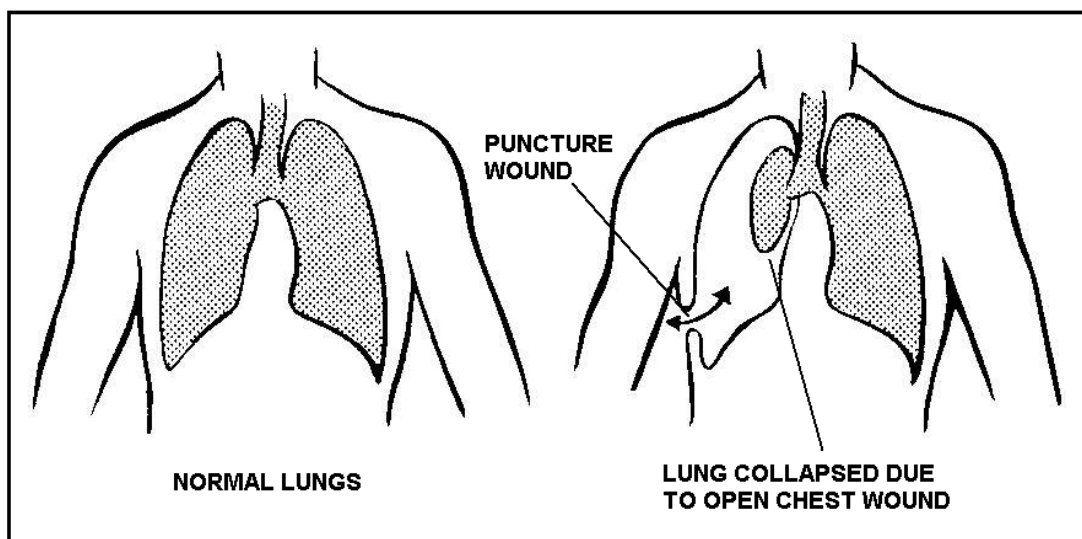

The body has two lungs. Each lung is enclosed in an airtight area within the chest. If an object punctures the chest wall and allows air to get into this area, the lung begins to collapse (not expand fully). In order for both lungs to collapse, both sides of the chest would have to be punctured. Figure 8-1 depicts a lung completely collapsed, but the lung of the casualty you treat may not be completely collapsed. Any degree of collapse, however, interferes with the casualty's ability to inhale a sufficient amount of air.

## **8-2. IDENTIFY SIGNS AND SYMPTOMS OF AN OPEN CHEST WOUND**

An open chest wound can be caused by the chest wall being penetrated by a bullet, knife blade, shrapnel, or other object. If you are not sure if a chest wound has penetrated the chest wall completely, treat the wound as though it were an open chest wound. Some of the signs and symptoms of an open chest wound are given below.

Sucking sound coming from chest wound. (When a casualty with an open chest wound breathes, air goes in and out of the wound. This air sometimes causes a "sucking" sound. Because of this distinct sound, an open chest wound is often called a "sucking chest wound.")

Frothy blood. (The air going in and out of an open chest wound causes bubbles in the blood coming from the wound.)

Pain in the shoulder or chest area which increases with breathing.

Shortness of breath or other difficulty in breathing.

Chest not rising normally when the casualty inhales.

Blood coughed up.

Bluish tint to lips, inside of mouth, fingertips, or nailbeds. (The color change is caused by the decreased amount of oxygen in the blood.)

Rapid and weak heartbeat.

## **8-3. SEAL AND DRESS AN OPEN CHEST WOUND**

Since air can pass through a dressing, you must seal an open chest wound to stop air from entering the chest and collapsing the lung.

## **Locate Chest Wound(s)**

Check for entry and exit wounds. Look for a pool of blood under the casualty's back and use your hand to feel for wounds. If there is more than one open chest wound, treat the more serious (largest, heaviest bleeding) wound first.

## **Expose the Wound**

### **WARNING**

**If you are in a chemical environment, seal and dress the wound without exposing the wound.**

Expose the area around the open chest wound by removing, cutting, or tearing the clothing covering the wound. If clothing is stuck to the wound, do not try to remove the stuck clothing as this may cause additional pain and injury. Cut or tear around the stuck clothing. Do not try to clean the wound.

## **Open Field Dressing Wrapper**

Tear open one end of the plastic wrapper of the casualty's field dressing. Remove the inner packet (the field dressing wrapped in paper) and put it aside. Continue to tear around the edges of the plastic wrapper until a flat surface is created. This plastic wrapper will be used to make an airtight seal which will keep air from entering the chest cavity through the wound. If there is both an entry wound and an exit wound, the plastic wrapper can be torn to make two seals if the wounds are not too large. The edges of the sealing material should extend at least two inches beyond the edges of the wound.

**CAUTION:** Avoid touching the inside surface of the plastic wrapper. The inner surface will be applied directly to the wound and should be kept as free from contamination as possible.

## **Have Casualty Exhale**

Tell the casualty to exhale (breathe out) as much as possible and hold his breath. This forces some of the air out of the chest wound. The more air that can be forced out of the chest before the wound is sealed, the better the casualty will be able to breathe after the wound is sealed.

If the casualty is unconscious or cannot hold his breath, watch his chest. Place the wrapper over the wound after his chest falls but before it rises.

## Place Wrapper Over Wound

### WARNING

**If an object is protruding from the chest wound, do not try to remove the object. Place airtight material around the object to form as airtight a seal as possible without dislodging or removing the protruding object. Improvise bulky dressing from the cleanest material available and place the dressing around the object to stabilize the object. Apply improvised bandages to hold the sealing material and dressings in place. Do not wrap the bandages around the protruding object.**

Place the inside surface of the plastic wrapper (the side without printing) directly over the hole in the chest to seal the wound.

Check the plastic wrapper to ensure that it extends two inches or more beyond the wound edges in all directions. If the wrapper does not have a two-inch margin, it may not form an airtight seal and may even be sucked into the wound. If the wrapper is not large enough or is torn, use foil, a poncho, cellophane, or similar material to form the airtight seal.

### Apply Casualty's Field Dressing

Remove the field dressing from the paper wrapper and prepare it for use. If the casualty is able, he can hold the plastic wrapper (or other sealing material) in place while you prepare the field dressing for use. If the casualty cannot help you, then you must keep the sealing material in place while you are preparing to dress the wound.

Place the white side of the dressing directly over the plastic wrapper. Maintain pressure on the dressing so that the plastic wrapper will not slip. Once the dressing is in place, the casualty can resume breathing normally.

### Secure Dressing

Secure the field dressing using the attached bandages. The field dressing must be tight enough to ensure that the plastic wrapper (or other sealing material) will not slip. If the casualty is able, have him hold the dressing in place while you secure it. If he cannot help you, then you must hold the dressing in place while securing it.

FIGURE 8-2. SEALING AND DRESSING AN OPEN CHEST WOUND

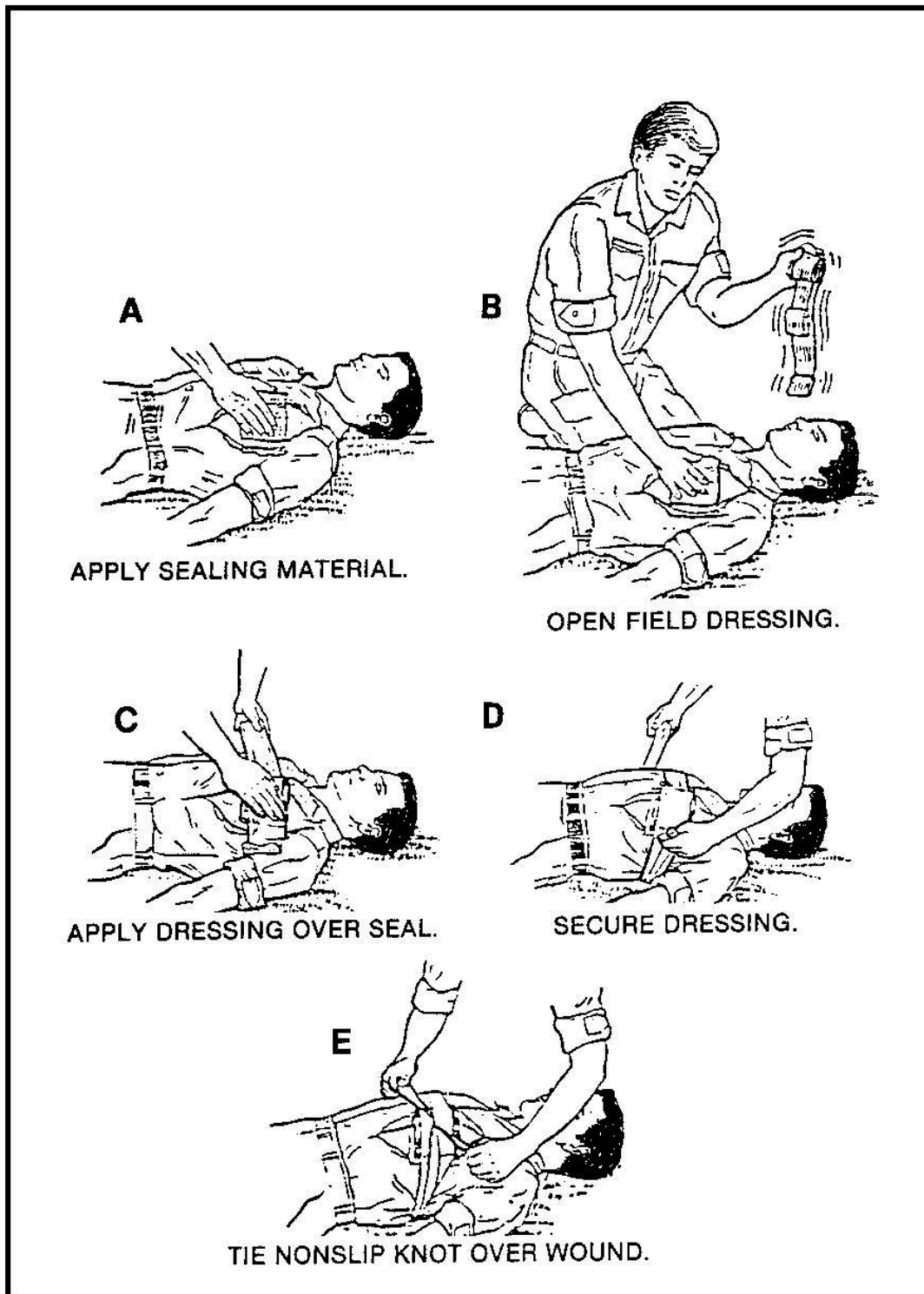

Grasp one tail, slide it under and around the casualty and bring it back over the dressing.

Wrap the other tail around the casualty in the opposite direction and bring it back over the dressing.

Tell the casualty to exhale and hold his breath. If the casualty is unconscious or cannot hold his breath, tie the knot after his chest falls and before the chest rises.

Tighten the tails and tie them with a nonslip knot over the center of the dressing. The knot will provide additional pressure over the wound and will help to keep the seal airtight.

Have the casualty resume normal breathing.

### **WARNING**

**If the plastic wrapper (or other sealing materials) slips while the dressing is being applied and secured, the airtight seal may be lost. Remove the dressing and sealing material, reseal the wound, replace the dressing, and secure the dressing.**

### **Seal and Dress Other Open Chest Wounds**

If there is more than one open chest wound (an entry and exit wound, for example), seal and dress the other wound(s). Improvise the dressing from the cleanest material available and use a bandage torn from a shirt or other material to keep the airtight seal and dressing in place.

### **Apply Manual Pressure**

If practical, apply direct manual pressure over the dressing for five to ten minutes. The pressure caused by your hand will help to control the bleeding.

#### 8-4. POSITION A CASUALTY WITH AN OPEN CHEST WOUND

FIGURE 8-3. CASUALTY WITH DRESSED OPEN CHEST WOUND

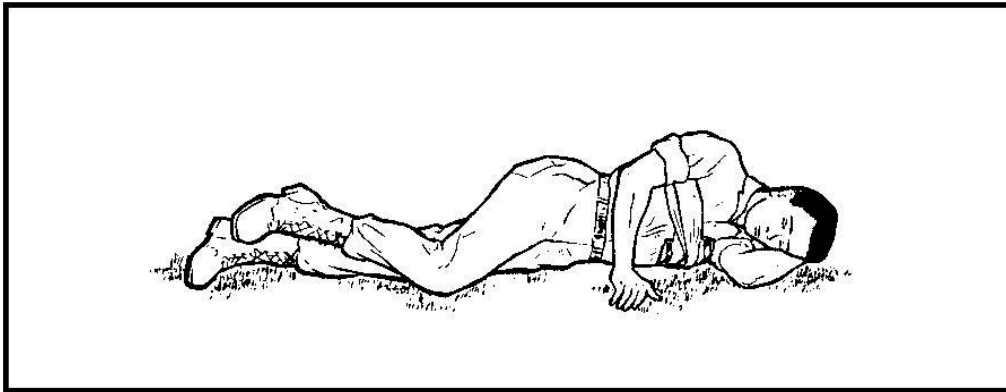

Have the casualty lie on his side with the injured side next to the ground. This position places additional pressure on the injured side and acts somewhat like a splint. This "splinting" action helps to reduce pain. If the casualty were to lie on his uninjured side, the pressure would hamper his breathing.

The casualty may wish to sit up. If he can breathe easier when sitting up than when lying on his side, allow him to sit up with his back leaning against a tree, wall, or other support. If he tires of sitting up, have him lie on his injured side again.

#### 8-5. MONITOR A CASUALTY WITH AN OPEN CHEST WOUND

Seek medical help. If possible, send someone else after help while you stay with the casualty.

Monitor the casualty's breathing. Rescue breathing may be needed.

Evacuate the casualty as soon as practical.

#### WARNING

**Air may still be able to enter the chest cavity even though the external wound was sealed and dressed. This air can cause a life-threatening condition called tension pneumothorax. If the casualty's condition worsens (increased difficulty in breathing, shortness of breath, bluish tint to skin, restlessness, etc.), lift the sealing material from the wound in order to let the air escape. Then reseal the wound and make it airtight again.**



## PRACTICE EXERCISES: LESSON 8

### Perform First Aid For An Open Chest Wound

**INSTRUCTIONS:** Answer the following exercises by circling the letter of the response that best answers the question or best completes the sentence. Refer to the lesson text, if needed. After you have answered all of the exercises, check your answers against the "Solutions to Exercises" at Appendix A. For each exercise answered incorrectly, reread the lesson material referenced.

1. Which of the following is a sign of an open chest wound?
  - a. Blood being coughed up.
  - b. Sucking sound coming from a chest wound.
  - c. Bluish tint to the casualty's lips.
  - d. Shortness of breath.
  - e. All of the above.
2. The primary purpose of putting the plastic wrapper over an open chest wound is to:
  - a. Prevent infection.
  - b. Reduce blood loss.
  - c. Prevent air from going in the wound.
  - d. Keep the dressing from having direct contact with the wound.
3. What size of material should be used for making the airtight seal?
  - a. Four inches by six inches.
  - b. The distance between the edge of the sealing material and the edge of the wound should be two or more inches.
  - c. The sealing material should be the same size as the wound.

4. You are treating a casualty with a sucking chest wound. You should have him \_\_\_\_\_ and hold his breath when you put the plastic wrapper over the wound. You should have him \_\_\_\_\_ and hold his breath when you tie the tails of the field dressing in a knot.
- Inhale; inhale.
  - Inhale; exhale.
  - Exhale; inhale.
  - Exhale; exhale.
5. Which of the following is the correct procedure for securing the dressing applied to an open chest wound?
- Both tails are taken around the casualty's body and back to the dressing. The knot is then tied in the center of the dressing.
  - Both tails are taken behind the casualty. The knot is then tied directly over his spine.
  - Both tails are taken around the body until they are at a point directly opposite the wound site. The knot is then tied.
  - Both tails are taken around the casualty's body and back to the dressing. The knot is then tied at the edge of the dressing.
6. You have dressed an open chest wound. How can the casualty now be positioned?
- Either sitting up or lying on his uninjured side.
  - Either sitting up or lying on his injured side.
  - Lying on his uninjured side only.
  - Lying on his injured side only.

7. You have given buddy-aid to a casualty with an open chest wound. His breathing had improved, but is now getting worse. He is short of breath, his lips are turning blue, and he is becoming very restless. What can you do to help the casualty?
- a. Nothing, the casualty's reactions are normal.
  - b. Place a pressure dressing over the wound.
  - c. Administer abdominal thrusts.
  - d. Lift the sealing material from the wound, let the air escape from the chest cavity, and then make the wound airtight again.

Check your answers

**LESSON 9**  
**PERFORM FIRST AID FOR AN OPEN ABDOMINAL WOUND**  
**(TASK 081-831-1025)**

**TASK:**

Identify the procedures for administering first aid to a casualty with an open abdominal wound.

**CONDITIONS:**

Given multiple-choice examination items pertaining to abdominal wounds.

**STANDARD:**

Score 70 or more points on a 100-point comprehensive examination.

**REFERENCES:**

STP 21-1-SMCT, Soldiers Manual of Common Tasks: Skill Level 1.  
FM 21-11, First Aid for Soldiers.

**NOTE:** Some of the task titles and information have changed and are not reflected in FM 21-11 and STP 21-1-SMCT. Refer to the Army Training Support Center, Common Core Task internet site at: <http://www.atsc.army.mil/dld/comcor/comcore.htm> for up-to-date task information.

**9-1. INTRODUCTION**

The body's abdominal cavity contains organs such as the stomach, small intestine, large intestine, liver, kidneys, and spleen. Several large arteries and veins are also located in the abdominal cavity. An object that punctures the muscular abdominal wall can injure one or more organs, cause severe bleeding, and cause infection which could spread to the organs within the cavity.

An open abdominal wound can be caused by the muscular abdominal wall being penetrated by a bullet, by a stab from a knife, by an object blown from an explosion, or by falling on a sharp object.

**9-2. POSITION A CASUALTY WITH AN OPEN ABDOMINAL WOUND**

Position the casualty on his back with his knees up (flexed). This position helps to prevent further exposure of the abdominal organs, lessen pain, and control shock.

**FIGURE 9-1. CASUALTY IN KNEES-UP POSITION**

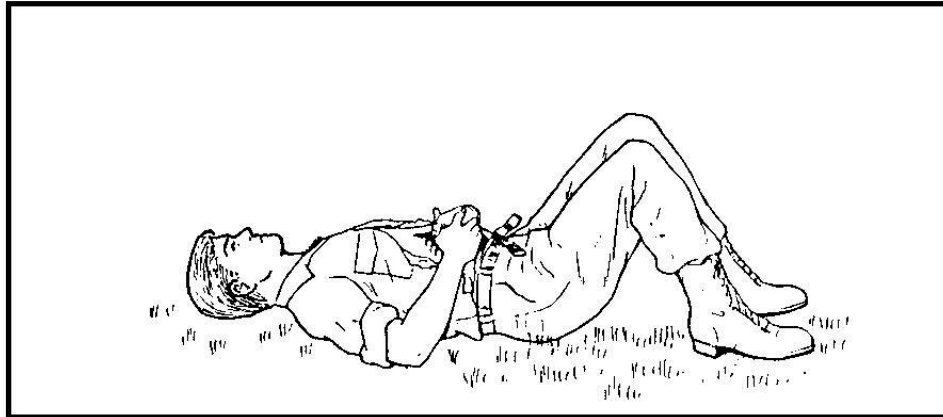

### **9-3. DRESS AN OPEN ABDOMINAL WOUND**

#### **Locate Abdominal Wound(s)**

Check the casualty's abdominal region for wounds. If more than one open abdominal wound is found, treat the more serious wound (largest, most blood loss, etc.) first.

#### **Expose the Wound**

#### **WARNING**

**If you are in a chemical environment, dress the wound without exposing the wound.**

Expose the area around the open abdominal wound by removing, cutting, or tearing the clothing covering the wound. If clothing is stuck to the wound, do not try to remove the stuck clothing as this may cause additional pain and injury. Cut or tear around the stuck clothing. Do not try to probe, clean, or remove foreign objects from the wound.

#### **Position Dislodged Organs, If Applicable**

Sometimes, part of an intestine or other organ is forced out through the wound. If an organ is outside the body, do not try to push the organ back into the body. Do not touch the exposed organ with your hands. If the organ is lying on the ground, use a field dressing or other clean, dry material to gently pick up the organ and place the organ on top of the casualty's abdomen.

## Place Dressing Over Wound

### WARNING

**If a foreign object is protruding from the wound, do not attempt to remove the object. Improvise bulky dressings from the cleanest material available and build up the area around the object in order to stabilize the object. Secure the dressing with improvised bandages.**

Open the casualty's field dressing and place the white side of the dressing over the wound and any protruding organs. If the field dressing is too small to cover the wound and any protruding organs or if the dressing is not available, use the cleanest materials available as a dressing. Clothing, part of a blanket, or similar materials may be used.

### Secure the Dressing

Hold the dressing with one hand to keep it from slipping.

Grasp one tail and slide it under the casualty.

Reach down on the other side of the casualty, grasp the tail under the casualty, and pull.

Bring the tail up the casualty's side, over the dressing, and to the other side.

Wrap the other tail in the opposite direction (down the side, under the back, and up the side).

Tie the tails in a nonslip knot on the casualty's side away from the wound. Do not tie the knots over the wound site.

**CAUTION:** The bandages should be tight enough to keep the dressing from slipping, but should not be tight enough to place pressure on the wound. The primary purpose of the dressing is to protect the wound from further contamination, not to control the bleeding through pressure. Pressure could cause additional damage to the organs of the abdominal cavity.

**FIGURE 9-2. DRESSING AN OPEN ABDOMINAL WOUND**

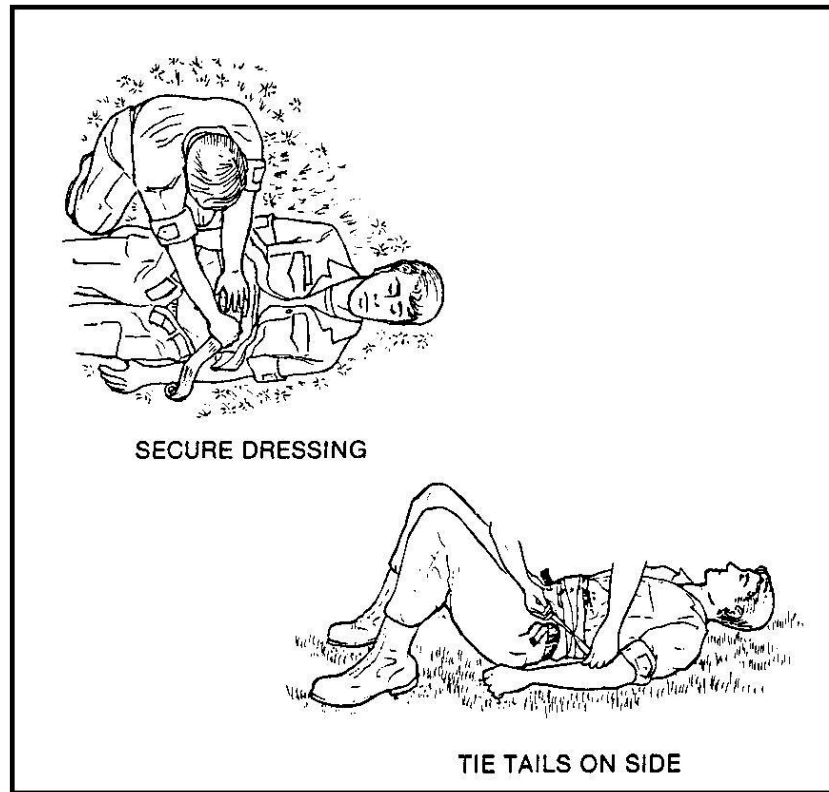

### **Dress Other Abdominal Wound(s)**

If other abdominal wounds are present (both entry and exit wounds are present, for example), dress and bandage the wounds.

### **Reinforce Dressings**

If the situation allows and materials are available, reinforce the dressings by covering them with cravats, strips torn from a T-shirt, or other strips of cloth. The improvised bandages will provide additional support and protection. Tie the tails of the reinforcement bandages on the opposite side of the field dressing knot. The reinforcing material should be tight enough to help keep the dressing from slipping, but loose enough to prevent additional pressure to the wound.

**CAUTION:** Do not tie any knots over the wound site.

#### **9-4. MONITOR A CASUALTY WITH AN OPEN ABDOMINAL WOUND**

Keep the casualty in the knees-up position.

Get medical help for the casualty as soon as possible. Buddy-aid methods cannot control internal bleeding (blood flowing into the abdominal cavity instead of flowing out of the wound). The risks of serious infection and damage to internal organs are also present. If possible, send someone else to get medical help while you treat the wound.

**CAUTION:** Do not give the casualty anything to eat or drink. If the casualty complains of thirst, moisten his lips with a damp cloth.

Be ready to administer rescue breathing should it become necessary.

If you must leave the casualty, tell him to stay on his back and keep his knees up.



## PRACTICAL EXERCISES: LESSON 9

### Perform First Aid For An Open Abdominal Wound

**INSTRUCTIONS:** Answer the following exercises by circling the letter of the response that best answers the question or best completes the sentence. Refer to the lesson text, if needed. After you have answered all of the exercises, check your answers against the "Solutions to Exercises" in the Appendix. For each exercise answered incorrectly, reread the lesson material referenced.

1. How should a casualty with an open abdominal wound be positioned while the wound is being dressed and bandaged?
  - a. Flat on his back.
  - b. On his back with his head and shoulders raised.
  - c. On his back with his feet elevated higher than the level of his heart.
  - d. On his back with his knees raised.
  - e. On his side with the injured side down.
  
2. A casualty has both an entry and an exit wound in his abdominal region. Which wound should you treat first?
  - a. The entry wound.
  - b. The exit wound.
  - c. The more serious wound.

3. You are giving buddy-aid to a casualty with an open abdominal wound. A loop of intestine has come out of the wound and is lying on the ground. The casualty is lying on his back. What should you do?
  - a. Use your bare hands to gently place the loop of intestine on the casualty's abdomen.
  - b. Use a clean dressing or cloth to gently place the loop of intestine on the casualty's abdomen.
  - c. Use your bare hands to gently push the loop of intestine back into the abdominal cavity.
  - d. Use a clean dressing or cloth to gently push the loop of intestine back into the abdominal cavity.
  
4. When securing the dressing over an open abdominal wound, the tails should be tied:
  - a. Over the wound.
  - b. On the casualty's side away from the wound.
  - c. Over the casualty's spine.
  
5. When securing the dressing, the bandages should be tied:
  - a. Loose enough to avoid putting pressure on the wound but tight enough to keep the dressing in place.
  - b. Tight enough to control the bleeding but not tight enough to stop blood circulation.
  - c. As tightly as possible.
  
6. If you reinforce the abdominal dressings, where should you tie the knots of the reinforcing bandages?
  - a. Directly over the wound.
  - b. At the same place the tails of the field dressing was tied.
  - c. On the casualty's side opposite the side that the field dressings tails were tied.

7. You have dressed and bandaged an open abdominal wound. The casualty says that he is hungry and thirsty. What should you do?
- a. Give the casualty something to eat and drink.
  - b. Give the casualty something to drink, but nothing to eat.
  - c. Give the casualty some fruit that will help to satisfy both his hunger and his thirst.
  - d. Moisten the casualty's lips, but do not give him anything to eat or drink.

Check your answers

**LESSON 10**  
**PERFORM FIRST AID FOR AN OPEN HEAD WOUND**  
**(TASK 081-831-1033)**

**TASK:**

Identify the procedures for administering first aid to a casualty with an open or closed head wound.

**CONDITIONS:**

Given multiple-choice examination items pertaining to head wounds.

**STANDARD:**

Score 70 or more points on a 100-point comprehensive examination.

**REFERENCES:**

STP 21-1-SMCT, Soldiers Manual of Common Tasks: Skill Level 1.  
FM 21-11, First Aid for Soldiers.

**NOTE:** Some of the task titles and information have changed and are not reflected in FM 21-11 and STP 21-1-SMCT. Refer to the Army Training Support Center, Common Core Task internet site at: <http://www.atsc.army.mil/dld/comcor/comcore.htm> for up-to-date task information.

**10-1. INTRODUCTION**

A head injury may be the only injury (such as a single blow to the head) or it may be combined with other injuries (such as head and body injuries caused by an explosion).

A head injury may consist of a cut or bruise of the scalp, a concussion, a fracture of the skull with injury to the brain, or a combination of these injuries.

**10-2. IDENTIFY SIGNS AND SYMPTOMS OF OPEN AND CLOSED HEAD INJURIES**

Head injuries can be either open (skin broken) or closed (skin not broken). Either type of injury can be severe and life-threatening. Bleeding from the scalp, visible skull fracture, and visible brain tissue are signs of an open head injury. The following signs and symptoms are also indications of a head injury, even if no open wound is present.

Deformity of the head.

Clear or bloody fluid leaking from the nose or ears.

"Black eyes."

Loss of consciousness (either current or recent unconsciousness).

Headache.

Vision problems.

Difficulty in breathing.

Convulsions.

Twitching.

Bruising behind one or both ears.

Staggering or dizziness.

Slurred speech.

Paralysis.

Nausea or vomiting.

Drowsiness.

Mental confusion.

### **10-3. DETERMINE LEVEL OF CONCIIOUSNESS**

To determine the level of consciousness and whether mental confusion is present, test the casualty's mental clarity by asking him to tell you his name, where he is, and the date. Incorrect responses, inability to answer, or changes in responses are symptoms of a head injury. Complete this check every 15 minutes and report the casualty's responses or lack of response to medical personnel when they arrive.

### **10-4. POSITION A CASUALTY WITH A HEAD INJURY**

A casualty with signs and symptoms of head injury other than minor wounds is presumed to have a severe head injury. When possible, avoid moving the casualty since he may also have a fractured neck. If you suspect that the casualty has a

fractured neck, tell the casualty not to move and immobilize his head using the procedures given in lesson 12.

### WARNING

**If you need to turn a casualty onto his side and you suspect that he may have a spinal injury, do not move the casualty by yourself. Have one person roll the casualty gently onto his side while another person provides support for the casualty's head and neck.**

FIGURE 10-1. CASUALTY POSITIONED ON HIS SIDE

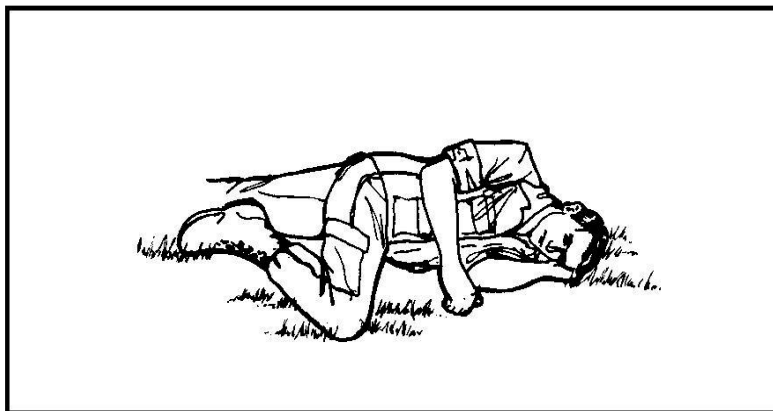

If the casualty is choking, nauseous, vomiting, or bleeding from his mouth, position the casualty on his side in order to promote drainage and to maintain an open airway. Place the casualty on the side opposite that of the wound (wound away from the ground).

If the casualty is having convulsions (involuntary muscle movements such as uncontrolled jerking or shaking), ease him to the ground and gently support his head and neck. Do not try to forcefully hold his arms and legs if they are jerking. Trying to "pin down" jerking limbs will probably cause additional injury. A casualty with convulsions presents a two-fold task in that you must treat his injuries and you must also keep him from accidentally hurting himself.

If the casualty is conscious, does not have a severe head or spinal injury, and other injuries do not prohibit his sitting up, have the casualty sit up. The casualty should have a tree, wall, or other stable object to lean against if possible.

If the casualty is conscious, does not have a severe head or spinal injury, is not accumulating drainage in his throat, and is not able to sit up, elevate his head slightly.

### 10-5. EXPOSE THE WOUND

Remove the casualty's helmet if he is still wearing it.

If the casualty is wearing a mask and hood and the "all clear" (safe from chemical agents) signal has been given, remove the casualty's mask and hood.

### **WARNING**

**If the casualty is wearing a mask and hood and the "all clear" signal has not been given, do not remove the casualty's mask and hood or attempt to dress the wound. If the mask or hood has been breached, repair the breach with tape or wet cloth stuffing if possible.**

### **10-6. APPLY A DRESSING TO A WOUND ON THE HEAD**

Obtain the casualty's field dressing. If the casualty's field dressing is lost or has already been used, improvise a dressing and bandages from the cleanest materials available.

Remove the dressing from the wrappers.

Grasp a tail in each hand and hold the dressing directly over the wound with the white side of the dressing toward the wound.

Pull the dressing open and place the white side of the dressing directly over the wound.

### **WARNING**

**Do not attempt to clean the wound or attempt to push any brain matter back into the head.**

**If an object is protruding from the wound, do not attempt to remove the object. Improvise bulky dressings from the cleanest material available and build up the area around the object to support and stabilize the object. Secure the dressing with improvised bandages.**

Secure the dressing with the attached bandages using the appropriate procedures given in the following paragraphs.

**CAUTION:** Apply the dressing and bandage so as to not interfere with the casualty's vision or hearing unless the eye or ear is injured. Avoid putting pressure on the wound. The dressing should be adequate to control the bleeding. Do not apply a pressure dressing to a head wound.

#### 10-7. SECURE A DRESSING TO THE FOREHEAD

Place one hand on the dressing to keep it from slipping. (You may have the casualty hold the dressing in place if he is able.)

Wrap one tail horizontally around the casualty's head and bring it back across the dressing. Angle the bandage so that it will cover the top or bottom edge of the dressing.

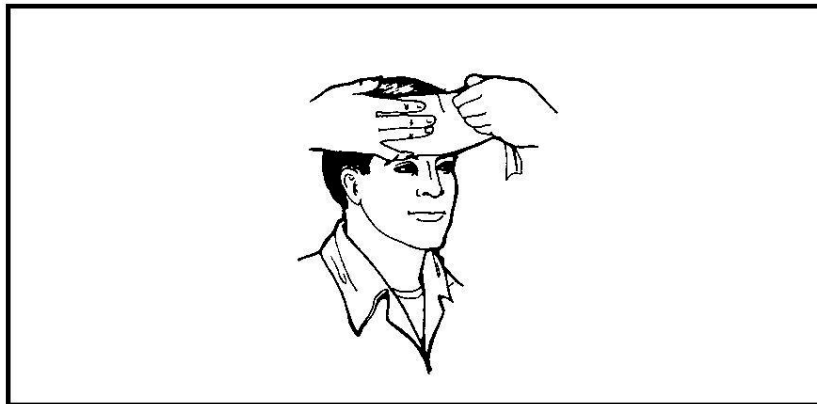

FIGURE 10-2. WRAPPING TAIL HORIZONTALLY AROUND HEAD

Wrap the second tail around the casualty's head in the opposite direction.

Bring it back across the dressing angled so that it will cover the other edge of the dressing (either top or bottom).

Continue to wrap the bandage around the head again until it meets the first tail.

Tie the tails in a nonslip knot on the side of the head.

**CAUTION:** The bandages should be tight enough so the dressing will not slip but not tight enough to place undue pressure on the wound.



**FIGURE 10-3. TYING TAILS ON THE SIDE OF THE HEAD**



Tuck in any excess tails. Tucking in excess material will keep the ends of the tail from possibly catching on an object or accidentally hitting the casualty in the eye.

**(NOTE:** The same general procedures are also used to secure the bandage to a wound to the back of the head.)

#### **10-8. SECURE A DRESSING TO THE TOP OF THE HEAD**

Place one hand on top of the dressing to hold it in place.

Grasp the near tail with the other hand.

Bring the tail down in front of the ear, under the chin, up in front of the opposite ear, over the dressing, and to a point just above and in front of the first ear (about a one and one-fourth circle).

**FIGURE 10-4. BRINGING TAIL UNDER CHIN**

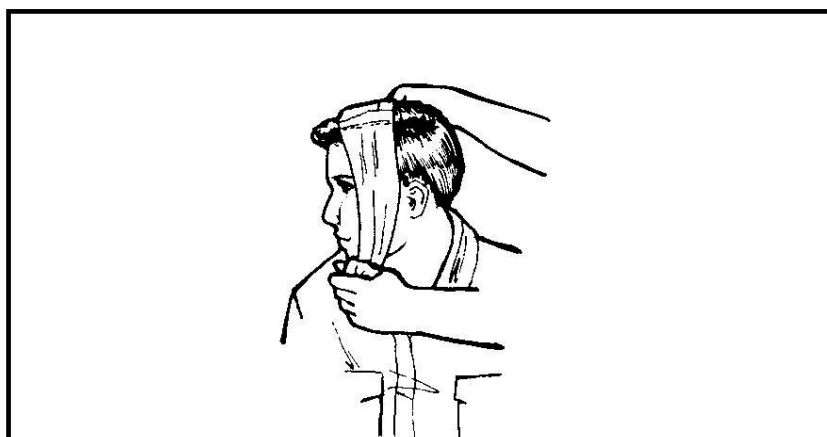

**CAUTION:** When passing a tail under the chin, make sure that the tail remains wide and close to the front of the chin. This will keep the bandage from choking the casualty.

Remove your hand from the dressing and grasp the other (free) tail.

Bring that tail down the opposite side of the face in front of the ear, under the chin, and up until it meets the first tail (about a three-fourths circle).

Cross the tails so that each makes a 90° turn. The cross should be made slightly above and in front of the ear (Figure 10-5).

Bring one tail across the casualty's forehead in front of the opposite ear (about a half circle). The tail should be above the casualty's eyebrows.

Bring the other tail back above the ear, low behind the head at the base of the skull, and up to a point above and in front of the opposite ear (about a half circle) where it meets the other tail. (Bringing the tail across at the base of the skull helps to keep the bandage from slipping.)

**FIGURE 10-5. CROSSING THE TAILS**

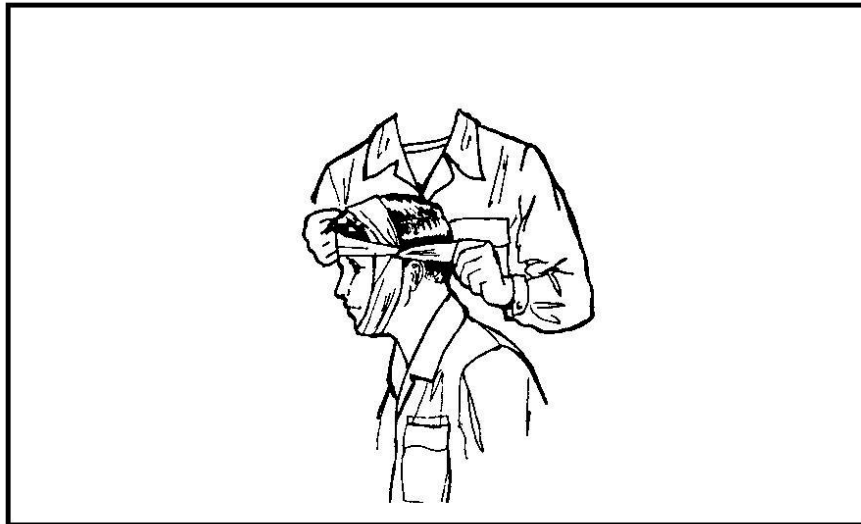

**FIGURE 10-6. TYING TAILS (INJURY TO TOP OF HEAD)**

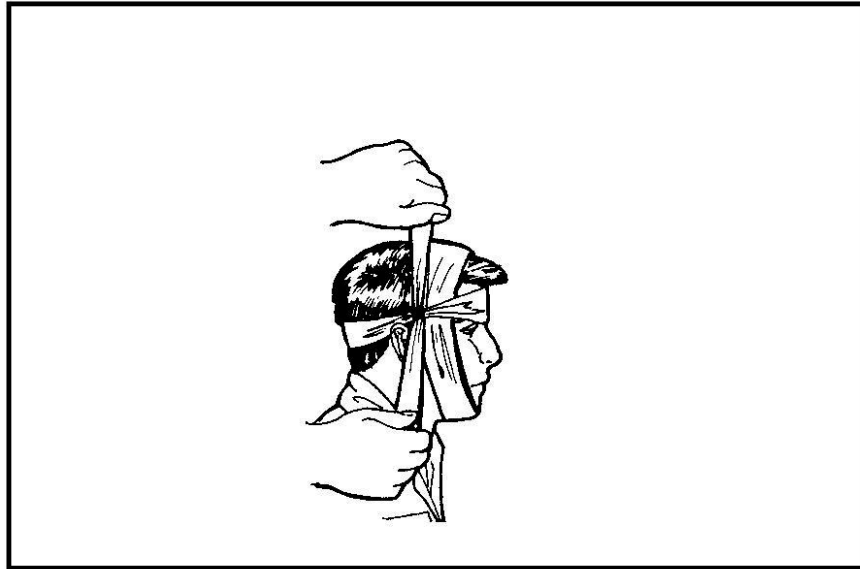

Tie the tails in a nonslip knot in front of and above the ear.

Tuck in the excess material from the tails.

#### **10-9. SECURE A DRESSING TO THE CHEEK**

Place one hand on top of the dressing to hold it in place. If the casualty is able, you can have the casualty hold the dressing in place while you secure it.

Bring the top (uppermost) tail over the top of the head, down in front of the ear, under the chin, up the side of the face, and over the dressing to a point just above the ear (a full circle). Do not cover the ear if it can be avoided. Covering the ear will decrease the casualty's ability to hear.

Bring the other (bottom) tail down, under the chin, up the side of the face, in front of the ear, and over the top of the head until it meets the first tail (almost a full circle).

**FIGURE 10-7. BRINGING SECOND TAIL AROUND TO MEET FIRST TAIL**

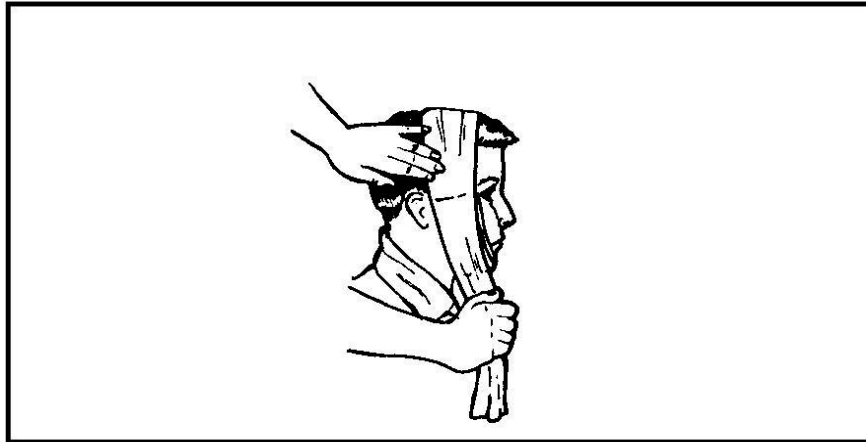

Cross the two tails. The tails are crossed just above the ear on the injured side of the face.

**FIGURE 10-8. CROSSING THE TAILS**

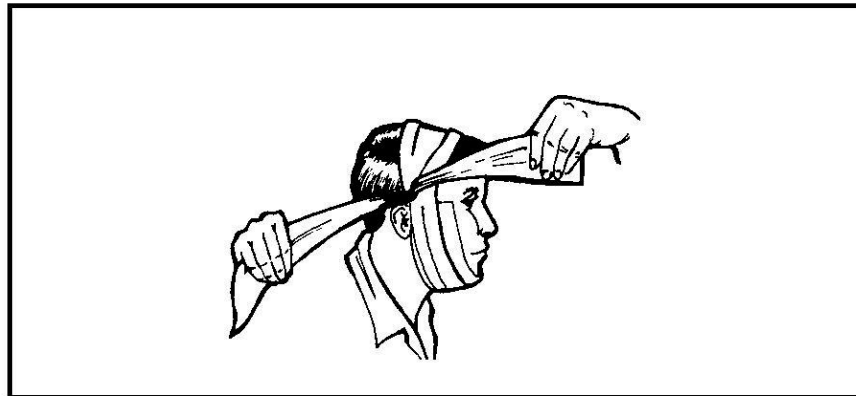

Bring one tail across the forehead (above the eyebrows) to a point just in front of the opposite ear (the ear on the uninjured side of the face).

Bring the other tail above the ear, low behind the back of the head at the base of the skull, and above the other ear until it meets the first tail.

Tie the tails in a nonslip knot just above and in front of the ear on the uninjured side of the head.

Tuck in the ends of the tails.

**FIGURE 10-9. TAILS TIED IN NONSLIP KNOT AND ENDS TUCKED**



**CAUTION:** If fluid is coming from the casualty's ear, put a field dressing or clean cloth over the ear to protect the ear and absorb the drainage. Secure the dressing with bandages and have the casualty evaluated by medical personnel as soon as practical.

**(NOTE:** A dressing applied to an open wound on the side of the casualty's head is secured using the same general procedures.)

#### **10-10. MONITOR A CASUALTY WITH A HEAD INJURY**

A casualty with a serious head wound (brain tissue visible, fractured skull, deformity of the head, or fluid leaking from an ear) or who does not regain consciousness should be examined by medical personnel and evacuated as soon as possible.

Any person with a head injury should be evaluated by medical personnel (medic, physician assistant, etc.) even if evacuation is not needed.

If you remain with the casualty, check his level of consciousness every 15 minutes. Have him tell you his name, where he is, and the date. If the casualty falls asleep, wake the casualty to check his level of consciousness. Note any changes from earlier observations.

Do not give the casualty anything to eat or drink. Eating or drinking may cause him to vomit.

## PRACTICE EXERCISES: LESSON 10

### Perform First Aid For An Open Head Wound

**INSTRUCTIONS:** Answer the following exercises by circling the letter of the response that best answers the question or best completes the sentence. Refer to the lesson text, if needed. After you have answered all of the exercises, check your answers against the "Solutions to Exercises" in the Appendix. For each exercise answered incorrectly, reread the lesson material referenced.

1. Which of the following is a sign of a closed head injury?
  - a. Black eyes.
  - b. Clear fluid leaking from an ear.
  - c. Slurred speech.
  - d. Convulsions.
  - e. All of the above.
  
2. There has been an explosion and you were thrown to the ground and dazed. A soldier in your squad comes to you, checks you over quickly, and asks, "What is your name? What is today's date? Where are we? What is happening?"
  - a. The soldier is showing signs of mental confusion and has probably suffered a head injury.
  - b. The soldier wants you to talk so he can check you for a sucking chest wound.
  - c. The soldier is checking you for symptoms of a head injury.
  - d. The soldier is showing signs of suffering a nervous breakdown.

3. A person is having convulsions (arms and legs jerking) after suffering a fall. How can you help this person?
  - a. Put the casualty against a tree and tie him to the tree.
  - b. Help the casualty to lie down and gently support his head.
  - c. Get help and pin the casualty's limbs down.
  - d. Do not attempt to assist the casualty yourself. A medical person who can administer an appropriate tranquilizer to the casualty is needed.
  
4. Which of the following is true concerning tying the nonslip knot of a field dressing applied to an open wound on the forehead?
  - a. The tails are tied on the side of the casualty's head.
  - b. The tails are tied at the center of the dressing directly over the wound.
  - c. The tails are tied at the base of the casualty's skull.
  - d. The tails are tied wherever they happen to cross.
  
5. When applying the field dressing to a casualty with an open wound on the top of his head, you should bring the tails down \_\_\_\_\_ the casualty's ear, pass the tail under his chin \_\_\_\_\_, and bring the tail up the opposite side.
  - a. In front of; as close to the throat as possible.
  - b. Behind; as close to the throat as possible.
  - c. Over; as close to the throat as possible.
  - d. Behind; close to the front of the chin.
  - e. In front of; close to the front of the chin.
  - f. Over; close to the front of the chin.

6. A soldier has fallen off of a ladder. He is conscious and does not seem to have any fractures or open wounds. He does, however, have some bloody fluid draining from his left ear. What should you do?
  - a. Cover the left ear with a dressing or clean cloth and seek medical help.
  - b. Apply a pressure dressing to the left ear and seek medical help.
  - c. Have the person lie on his left side and maintain the position until the drainage stops; then apply a dressing to the left ear.
  
7. You are staying with a casualty who has suffered a head injury. You should check his level of consciousness every:
  - a. 5 minutes.
  - b. 15 minutes.
  - c. 30 minutes.
  - d. 60 minutes.
  - e. Time the casualty wakes up.

Check your answers



THIS PAGE INTENTIONALLY LEFT BLANK

**LESSON 11**  
**PERFORM FIRST AID TO PREVENT OR CONTROL SHOCK**  
**(TASK 081-831-1005)**

**TASK:**

Identify the procedures for preventing/controlling shock.

**CONDITIONS:**

Given multiple-choice examination items pertaining to shock.

**STANDARD:**

Score 70 or more points on a 100-point comprehensive examination.

**REFERENCES:**

STP 21-1-SMCT, Soldiers Manual of Common Tasks: Skill Level 1.  
FM 21-11, First Aid for Soldiers.

**NOTE:** Some of the task titles and information have changed and are not reflected in FM 21-11 and STP 21-1-SMCT. Refer to the Army Training Support Center, Common Core Task internet site at: <http://www.atsc.army.mil/dld/comcor/comcore.htm> for up-to-date task information.

**11-1. INTRODUCTION**

Shock occurs when the tissues or organs of the body do not receive enough oxygen and nutrients from the blood circulatory system. There are several causes of shock. On the battlefield, low blood volume (hypovolemic) shock will be the primary type of shock treated by buddy-aid. Hypovolemic shock is usually caused by severe bleeding, but it can also be caused by a severe loss of body fluids from other causes (vomiting, diarrhea, excessive sweating, severe burns, etc.). Other types of shock can be caused by infections; by allergic reactions to drugs, food, or insect bites; and by heart failure. Shock, if not properly treated, can result in death.

When treating a casualty, assume that shock is present or will occur shortly. By waiting until actual signs/symptoms of shock are noticeable, the rescuer may jeopardize the casualty's life.

## **11-2. IDENTIFY THE SIGNS AND SYMPTOMS OF SHOCK**

Signs and symptoms of shock include the following:

Sweaty but cool (clammy) skin.

Pale skin color.

Blotchy or bluish skin, especially around the mouth.

Rapid or severe bleeding.

Nausea/vomiting.

Anxiety. (Anxiety causes the heart to beat faster, thus increasing the rate of blood circulation and the rate of blood loss. Anxiety can increase as the casualty's condition worsens. He may become restless, agitated, and may even become violent and fight the people around him.)

Mental confusion. (Mental confusion is especially dangerous because the casualty may not comprehend his surroundings and may expose himself and others to danger needlessly.)

Increased breathing rate.

Unusual thirst.

## **11-3. POSITION THE CASUALTY TO PREVENT/CONTROL SHOCK**

Shock is a life-threatening condition. Once you have ensured that the casualty is breathing and have controlled any major bleeding, dressed any major wounds, and splinted any major fractures, you must take measures to prevent shock if it is not present or to control shock if it is present. The procedures for preventing shock are the same as the procedures for controlling (treating) shock.

### **Normal Shock Position**

Most casualties should be placed in the normal shock position described below.

**FIGURE 11-1. NORMAL POSITIONING OF CASUALTY TO CONTROL SHOCK**

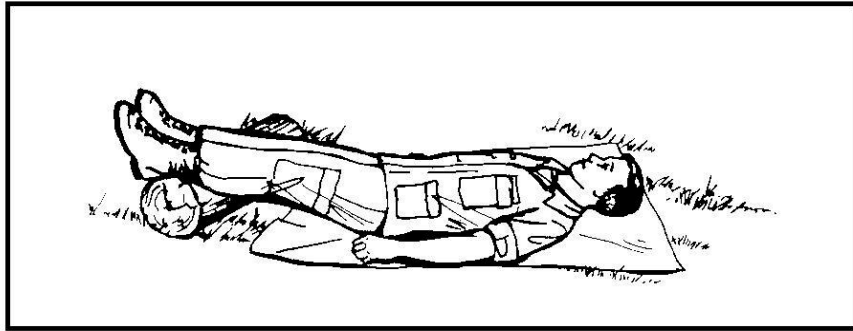

Move the casualty to cover if it is available and the situation permits.

Position the casualty on his back. If possible, place a poncho or blanket under the casualty to protect him from the temperature or dampness of the ground.

Elevate the casualty's legs so that his feet are slightly higher than the level of his heart. (This helps the blood in the veins of his legs to return to his heart.)

### **WARNING**

**Do not elevate the legs until all leg fractures have been splinted.**

Place a small log, field pack, box, rolled field jacket, or other stable object under the casualty's feet or ankles in order to maintain the elevation.

### **Shock Positions for Special Injuries**

Certain casualties are not placed in the normal position for shock. Proper positioning of casualties with special injuries is discussed below.

Suspected Fracture of the Spine. Do not move a casualty with a suspected spinal fracture. Do not elevate his legs. Immobilize his head, neck, and back if possible.

Open Abdominal Wound. Place the casualty on his back with his knees flexed.

Open Chest Wound. If the casualty wishes to sit up, help him to sit. If possible, have him sit with his back to a wall, tree, or other support. If the casualty wishes to lie down, position him so that he is lying on his injured side.

Heart Attack. Allow the casualty to sit up with his back to a wall or other support if he wants to do so. Otherwise, position the casualty on his side.

Head Wound. Treat a major head wound as though a spinal injury is present. A casualty with a minor head wound should be allowed to sit up if there is no bleeding into the mouth. If the casualty has bleeding into the mouth or if he does not want to sit

up, position him on his side with his head turned so that the blood can drain from his mouth. Position him with his wound up.

---

Unconsciousness. Position an unconscious casualty on his side with his head turned so that any fluids can drain from his mouth. If the casualty vomits, perform a finger sweep to clear his airway before he can inhale the vomitus.

**FIGURE 11-2. UNCONSCIOUS CASUALTY POSITIONED ON HIS SIDE**

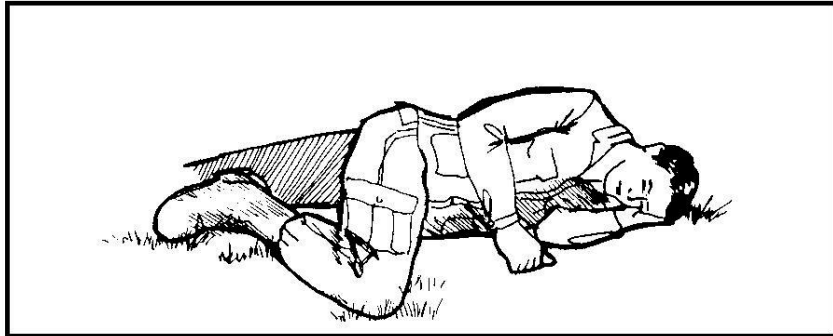

#### **11-4. TAKE ADDITIONAL MEASURES TO PREVENT/CONTROL SHOCK**

Additional actions for preventing or controlling hypovolemic shock are given below.

##### **Reassure the Casualty**

Keep the casualty calm. Tell the casualty that you are helping him. Be confident in your ability to help the casualty and have a "take charge" attitude. Your words and actions can do much to reassure the casualty and reduce his anxiety. Be careful of any comments that you make regarding the casualty's condition since unguarded comments could increase the casualty's anxiety.

##### **Loosen the Casualty's Clothing**

Loosen the casualty's clothing at his neck, waist, feet, or anywhere that it may be binding. Tight clothing can interfere with blood circulation.

#### **WARNING**

**Do not loosen or remove the casualty's clothing in a chemical environment.**

## Keep the Casualty From Being Too Warm or Too Cool

In warm weather, keep the casualty in the shade. If natural shade is not available, erect an improvised shade using a poncho and sticks or other available materials. Fan him if needed. (Fanning promotes the evaporation of perspiration and cools the casualty.)

In cool weather, cover the casualty with a blanket, poncho, or other available materials to keep him warm and dry. Place cover under the casualty to prevent chilling due to contact with cold or wet ground. (Note: Dress and bandage any serious burns before covering them.)

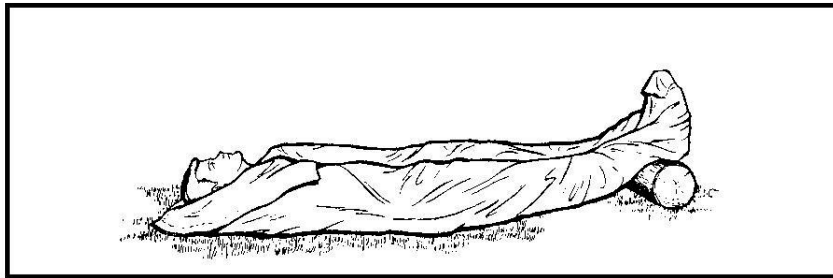

FIGURE 11-3. CASUALTY BEING TREATED FOR SHOCK IN COOL WEATHER

## Seek Aid

Send another person to get a combat medic or combat lifesaver. If you cannot send someone, complete your treatment of the casualty. If you must go to get help (casualty cannot be moved due to a spinal injury, for example), reassure the casualty by telling him that you are going to get medical aid and will return. Turn the casualty's head to one side before you leave. This will help to keep the casualty from choking on his own vomitus should he vomit. Do **not** give the casualty food or water.

## Evacuate the Casualty

If additional help is not available, evacuate the casualty if practical.

**CAUTION:** A casualty with a spinal fracture should only be evacuated by medical personnel.

## PRACTICE EXERCISES: LESSON 11

### Perform First Aid To Prevent or Control Shock

**INSTRUCTIONS:** Answer the following exercises by circling the letter of the response that best answers the question or best completes the sentence. Refer to the lesson text, if needed. After you have answered all of the exercises, check your answers against the "Solutions to Exercises" in the Appendix. For each exercise answered incorrectly, reread the lesson material referenced.

1. Which one of the following is most likely to result in hypovolemic shock?

- a. Lack of sleep.
- b. Stress caused by combat.
- c. Cold, dry weather.
- d. Rapid and severe blood loss.

2. Which of the following is not a sign or symptom of shock?

---

- a. Anxiety.
- b. Hot, dry skin.
- c. Confused state of mind.
- d. Rapid breathing.

3. Which of the following statement(s) is/are true?

- a. Splint any leg fracture before elevating the casualty's legs.
- b. Shock is a serious, but not life-threatening, condition.
- c. All casualties should be placed in the same position for preventing/controlling shock.
- d. All of the above are true.

4. Which one of the following is not a proper treatment for shock if the casualty has an open abdominal wound?
- a. Loosen binding clothing.
  - b. Elevate the casualty's feet above the level of his heart.
  - c. Cover the casualty with a poncho if he is cold.
  - d. Talk to the casualty.
5. You must leave a casualty alone in order to seek medical help. How should you position the casualty's head?
- a. Have his face toward the ground with his head supported by both upper arms.
  - b. Have his face straight up.
  - c. Turn his head to one side.

Check your answers



THIS PAGE INTENTIONALLY LEFT BLANK

**LESSON 12**  
**PERFORM FIRST AID FOR A SUSPECTED FRACTURE**  
**(TASK 081-831-1034)**

**TASK:**

Identify the procedures for identifying and immobilizing a suspected fracture of the spine, arm, or leg.

**CONDITIONS:**

Given multiple-choice examination items pertaining to treating fractures.

**STANDARD:**

Score 70 or more points on a 100-point comprehensive examination.

**REFERENCES:**

STP 21-1-SMCT, Soldiers Manual of Common Tasks: Skill Level 1.  
FM 21-11, First Aid for Soldiers.

**NOTE:** Some of the task titles and information have changed and are not reflected in FM 21-11 and STP 21-1-SMCT. Refer to the Army Training Support Center, Common Core Task internet site at: <http://www.atsc.army.mil/dld/comcor/comcore.htm> for up-to-date task information.

**12-1. INTRODUCTION**

A fracture is a break in a bone. A fracture can cause discomfort, disability, and even death.

**FIGURE 12-1. EXAMPLES OF FRACTURES**

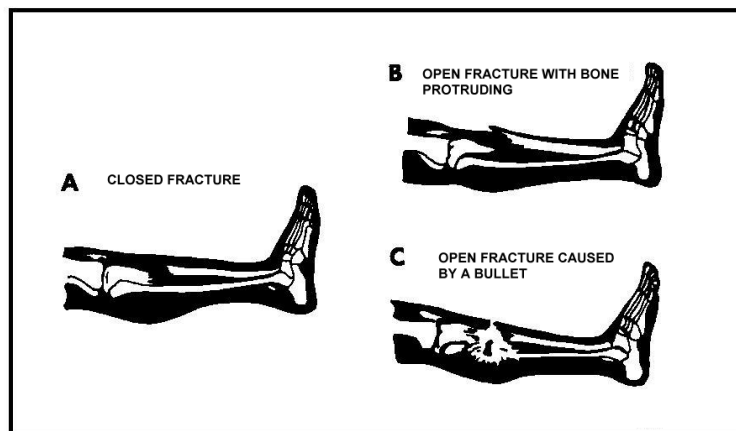

A closed fracture is a break in the bone without a break in the skin. Even though the skin is not cut or broken, the tissue beneath the skin may be damaged.

An open fracture is a break in the bone with a break in the overlying skin as well. The break in the skin may be caused by the sharp end of the broken bone or by a foreign object such as a bullet penetrating the skin. Open fractures are especially serious due to the danger of infection.

A dislocation occurs when the bones comprising a joint (elbow, knee, wrist, etc.) are forced out of their proper positions. A sprain results when a joint is twisted beyond its normal limits of motion and the connecting tissues around the joint tear. A dislocation or sprain can produce signs and symptoms similar to those of a fracture and should be treated as a fracture of the joint.

## 12-2. IDENTIFY SIGNS AND SYMPTOMS OF A FRACTURED SPINE

FIGURE 12-2. SPINAL COLUMN

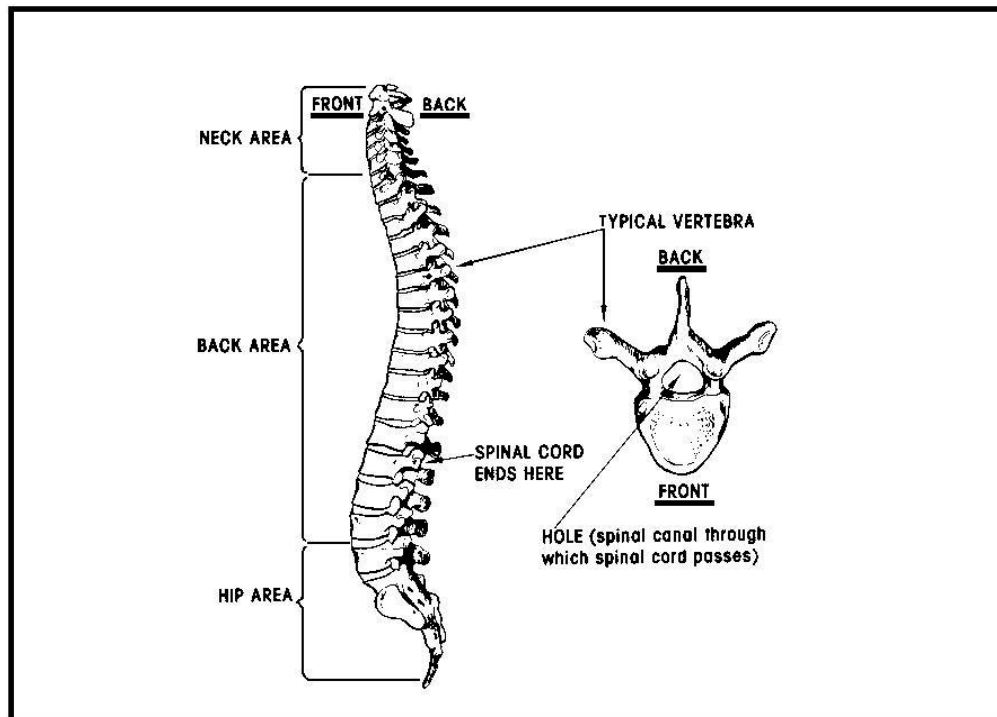

The spinal column (also called the backbone or spine) consists of a series of bones called vertebrae. The top seven vertebrae are the bones of the neck. The spinal column surrounds and protects the spinal cord. The spinal cord consists of nerves which carry impulses between the brain and the rest of the body. If the spinal cord is severed (cut completely), the muscles controlled by the portion of the spinal cord

below the cut will not function. Always check for a spinal injury if the casualty has suffered a fall or has been hit in the back.

Signs and symptoms of an injured spine include:

Pain or tenderness of the neck or back.

Cut or bruise on the neck or back.

Inability to move part of the body (paralysis), especially the legs.

Lack of feeling in a body part. (Touch the casualty's arms and legs and ask if he feels your hand.)

Loss of bladder and/or bowel control.

Head or back in an unusual position.

### **12-3. IMMOBILIZE A FRACTURED SPINE**

Treat any casualty which you think may have a spinal injury as though you were certain that he had a fractured spine.

#### **WARNING**

**Do not move a casualty with a suspected fracture of the spine unless it is necessary to move the casualty from an immediate life-threatening danger (fire, etc.). Moving the casualty could cause additional danger to the spinal cord which could result in permanent paralysis or even death. Do not attempt to straighten the casualty's head or back if it is in an abnormal position.**

Tell the casualty to keep still. Any movement could cause additional injury.

Send someone to get medical help.

If the casualty is lying on his stomach, keep him from moving until medical help arrives. If the casualty is lying on his back, use padding to help immobilize his back, neck, and head as described in the following pages.

Roll or fold padding (such as a blanket) so that it conforms to the shape of the arch of his back. Then carefully slide the padding under the arch of his back. This padding will help to support and immobilize his back.

Slide a roll of cloth under the casualty's neck to help support and immobilize his neck.

**FIGURE 12-3. PADDING PLACED UNDER BACK AND NECK**

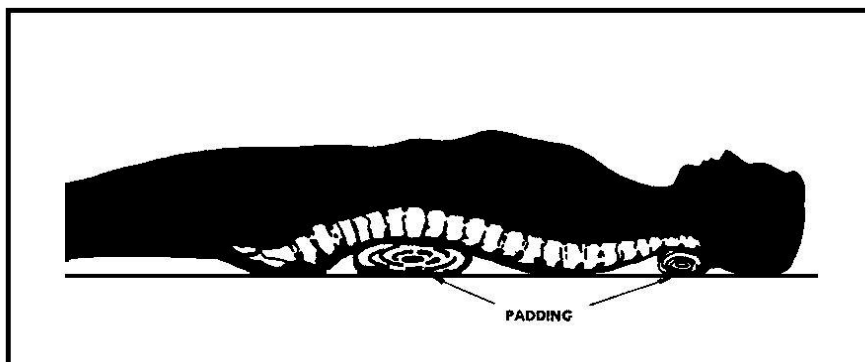

Place padded rocks, small padded logs, or filled boots on each side of the casualty's head to keep it from moving.

**FIGURE 12-4. IMMOBILIZING THE HEAD WITH BOOTS**



To Prepare filled boots:

Remove the casualty's boots.

**WARNING**

**Do not remove the casualty's boots if you are in a chemical environment.**

Fill the boots almost to the top with sand or small rocks.

Place material (strip of clothing, sock, etc.) on top of the sand or rocks to keep the sand or rocks from falling out.

Tie the top of the boots to keep the material from coming out.

Place the boots around the casualty's head.

#### **12-4. IDENTIFY SIGNS AND SYMPTOMS OF A FRACTURED ARM OR LEG**

Some of the signs and symptoms of a fractured arm or leg are given below.

Bone sticking through the skin.

Feeling what appears to be a break in the bone.

Pain, tenderness, swelling, and/or bruises at a particular location. (The site of the tenderness or bruise is probably the site of the fracture.)

Arm or leg in an abnormal position (looks deformed).

Difficulty in moving an arm or leg. (NOTE: Do not have the casualty attempt to move the injured arm or leg to test this symptom. Rely upon what the casualty tells you.)

Massive injury to an arm or leg. (Even if the arm or leg is not broken, the pain caused by the wound may be lessened if the arm or leg is splinted after it has been dressed and bandaged.)

"Snapping" sound heard by the casualty at the time of the injury.

#### **12-5. PREPARE THE CASUALTY PRIOR TO SPLINTING**

Once you have located the site of the fracture, you must splint the injured arm or leg. (A splint is a rigid object or objects secured to the injured limb so as to prevent the broken bone from moving. If the fractured bone is not splinted, the sharp end of the broken bone could move and injure surrounding muscles, blood vessels, and nerves.) Before applying the splint, however, you should prepare the casualty.

##### **Reassure Casualty**

Tell the casualty that you are taking care of him. If you must leave the casualty to locate a rigid object or securing materials, be sure to tell him that you will return quickly. Talk to the casualty even if he appears to be unconscious.

## Loosen Clothing

### WARNING

**Do not remove or loosen any of the casualty's protective clothing if you are in a chemical environment.**

Loosen any clothing that is tight or which binds the casualty. Boots should not be removed unless they are needed to immobilize an injured neck or there is bleeding from the foot.

## Remove Jewelry

Remove any jewelry that is on the casualty's injured limb and put the jewelry into his pocket. Jewelry is removed because the limb may swell and cause the jewelry to interfere with blood circulation. Be sure to tell the casualty what you are doing and why.

## Check Circulation Below Fracture

Evaluate the casualty's blood circulation in the limb below the fracture site. A person with poor circulation should be evacuated as soon as possible after the limb is splinted. A quick evacuation will help to prevent the loss of the limb.

Numbness. If the area feels numb or tingling to the casualty, the area probably has poor circulation.

Color. In a light-skinned person, a pale, white, or bluish-gray skin color indicates poor circulation. To check the circulation in a dark-skinned individual, press on a nail on the injured limb and the corresponding nail on the uninjured arm or leg. Release both nails at the same time. If the color returns to the nail bed of the uninjured limb faster than it returns to the nail bed of the injured limb, the casualty probably has poor circulation in the injured limb.

Temperature. Place your hand on the area beneath the injury. Then place your hand on the corresponding area on the uninjured arm or leg. If the skin of the injured limb is cooler than the skin on the uninjured limb, the casualty probably has poor circulation in the injured limb.

## Dress Wounds

Dress any open wounds on the injured limb before applying the splint. If a bone is sticking out, do not attempt to push the bone back under the skin. Apply the dressing over the bone and the wound. Do not attempt to straighten or realign the injured limb.

## 12-6. PREPARE THE SPLINT

### Gather Materials

Gather the materials you will need to make the splint. You will need something to use as the rigid object, padding, and securing material to keep the splint from slipping.

Rigid Object. Tree branches, poles, boards, sticks, unloaded rifles, or other rigid objects can be used. Normally, two rigid objects (one for each side of the limb) are used. The rigid objects should be fairly straight and be long enough to extend beyond the joint above the fracture site and beyond the joint below the fracture site. Even the casualty's own body can be used when other materials are not available. His chest can be used to immobilize a fractured arm and an uninjured leg can be used to immobilize a fractured leg.

Padding. Blankets, jackets, ponchos, extra clothing, shelter halves, or leafy plants can be used to pad the splint. In some cases, you may have to use the casualty's trouser leg or shirt sleeve as padding. Padding is necessary to keep the rigid object from rubbing against the skin on the injured limb.

Securing Materials. Rigid objects can be secured with strips of clothing, belts, pistol belts, bandoleers, cravats, or similar materials. Cravats are preferred when possible. Narrow materials such as wire and cord should not be used to secure the rigid object in place since they could interfere with blood circulation. The steps for making cravats are summarized below.

- Cut or tear a square about three feet on each side from pliable material such as a shirt or sheet.
- Fold the square along the diagonal so that it is triangular in shape.
- Cut or tear along the fold so that two triangles are formed. (Each triangle becomes a cravat.)
- Fold top of the triangle down until the tip of the triangle touches the base (longest side).
- Continue to fold until the cravat is of the correct size.

### Position the Rigid Objects

Place the rigid objects so that one is on each side of the injured limb. When possible, position the rigid objects so that the joint above the fracture and the joint below the fracture can be immobilized. If the fracture is in the lower leg, for example, the splint should extend above the knee and below the ankle. (Note: If a forearm is fractured, the wrist is usually immobilized by the splint and the elbow is usually immobilized by a sling and swathe.) Make sure that the ends of the rigid objects are not pressing



against a sensitive area such as the armpit or groin. Pressure on these areas can interfere with blood circulation.

### **Apply Padding**

Place padding between the rigid objects and the body part to be splinted. The padding helps to prevent excessive pressure on the limb which could interfere with blood circulation. Extra padding should be used at bony body areas such as the elbow, wrist, knee, or ankle and extra-sensitive areas such as the groin and armpit.

## **12-7. APPLY THE SPLINT**

Position the securing materials. Push the securing material (cravat, etc.) under natural body curvatures, such as the knee. Then gently move the securing material up or down the limb until the material is in proper position.

Place securing material under the limb both above and below the fracture site. If possible, place two cravats above the fracture site and two cravats below the fracture site (above the upper joint, between the upper joint and the fracture, between the fracture and the lower joint, and below the lower joint.)

**CAUTION:** Do not place securing material directly under the suspected fracture site. The pressure caused by the securing material when it is tightened could cause additional injury to the fracture site.

Place the padded rigid objects on the securing materials and against the injured limb.

### **WARNING**

**Do not try to straighten or reposition the fractured limb. Splint the limb in the position you find it. Move the limb as little as possible while applying and securing the splint.**

Wrap the securing materials around the rigid objects and limb so that the rigid objects immobilize the limb. Tie the ends (tails) of each securing cravat in a nonslip knot on the outer rigid object and away from the casualty. (The knots are tied on the outer rather than the inner rigid object to make loosening and retying the cravats easier should that procedure become necessary.) The securing material should be tight enough to hold the rigid objects securely in place, but not tight enough to interfere with blood circulation.

**FIGURE 12-5. SINGLE-BOARD SPLINT APPLIED TO A FRACTURED WRIST**

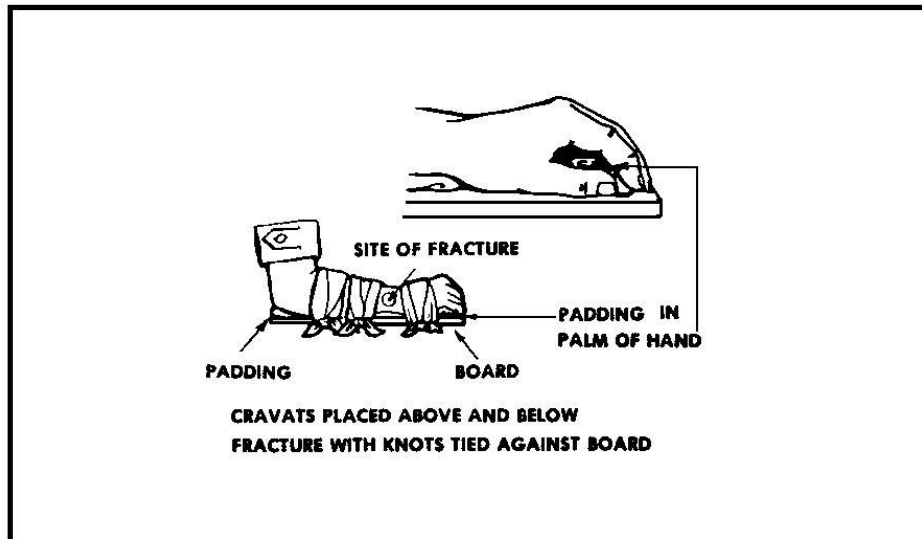

**FIGURE 12-6. SPLINT APPLIED TO A FRACTURED FOREARM**

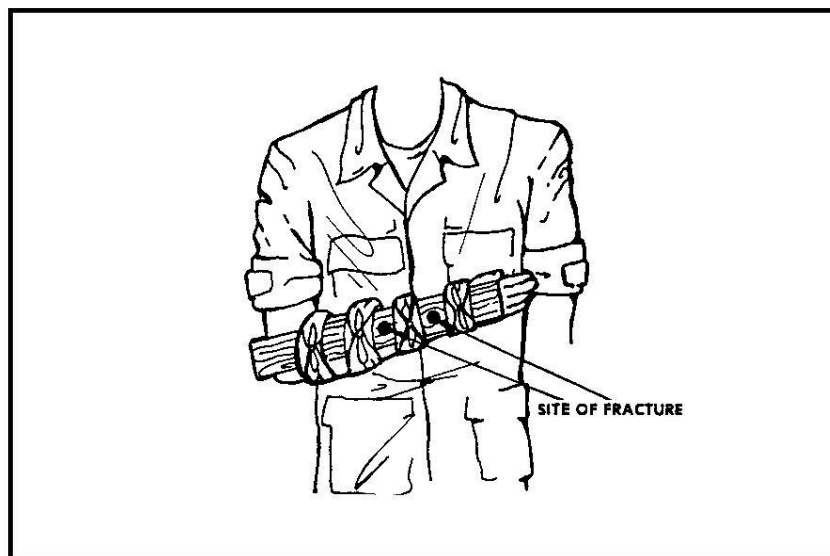

FIGURE 12-7. SPLINT APPLIED TO A FRACTURED ELBOW

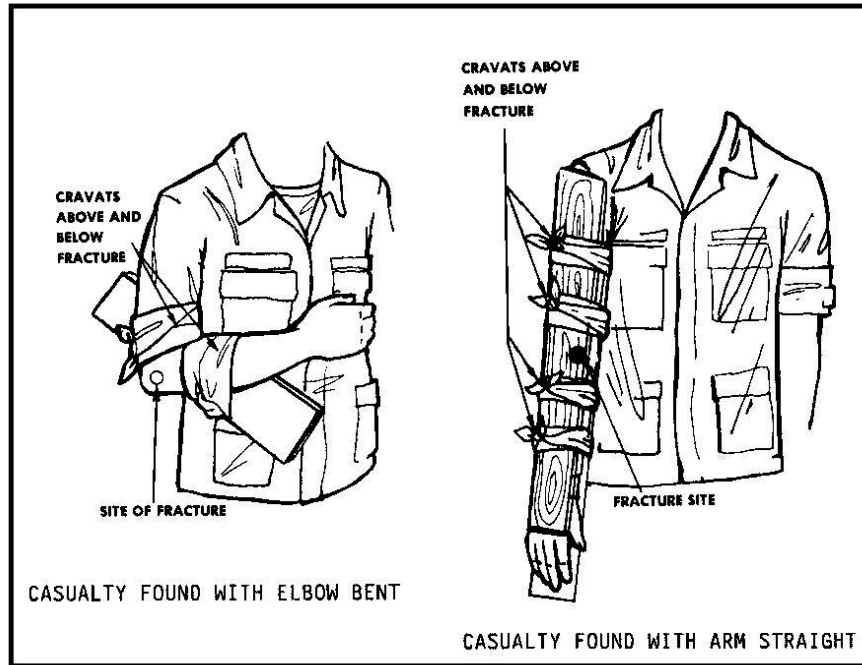
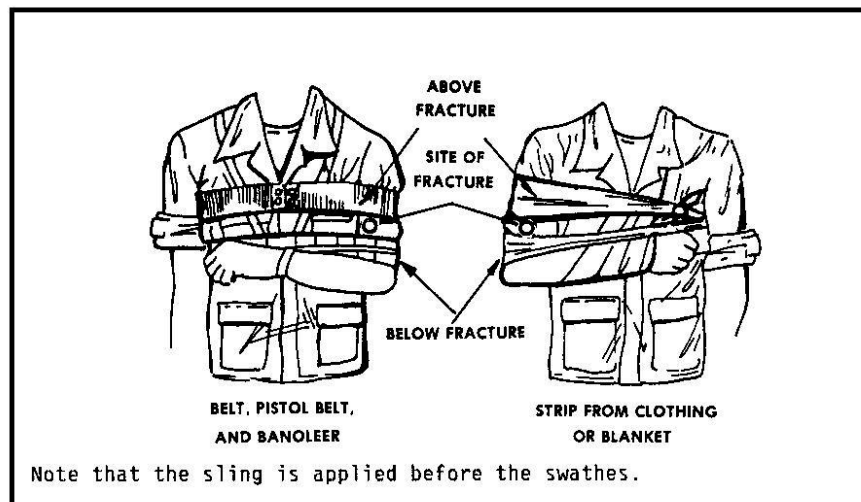
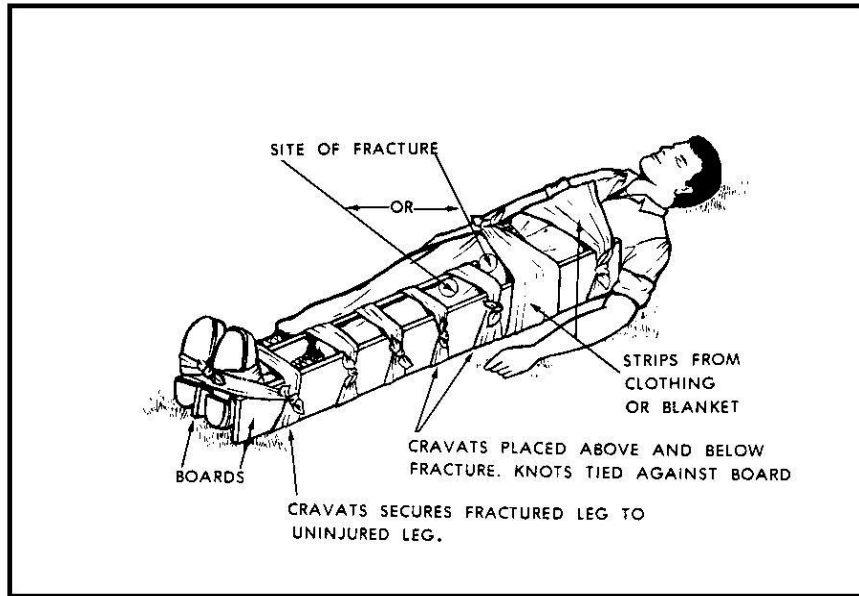

FIGURE 12-8. CHEST USED AS SPLINT FOR AN UPPER ARM FRACTURE



**FIGURE 12-9. SPLINT APPLIED TO A FRACTURE OF THE UPPER LEG (THIGH)**



**FIGURE 12-10. SPLINT APPLIED TO A FRACTURED KNEE (BENT)**

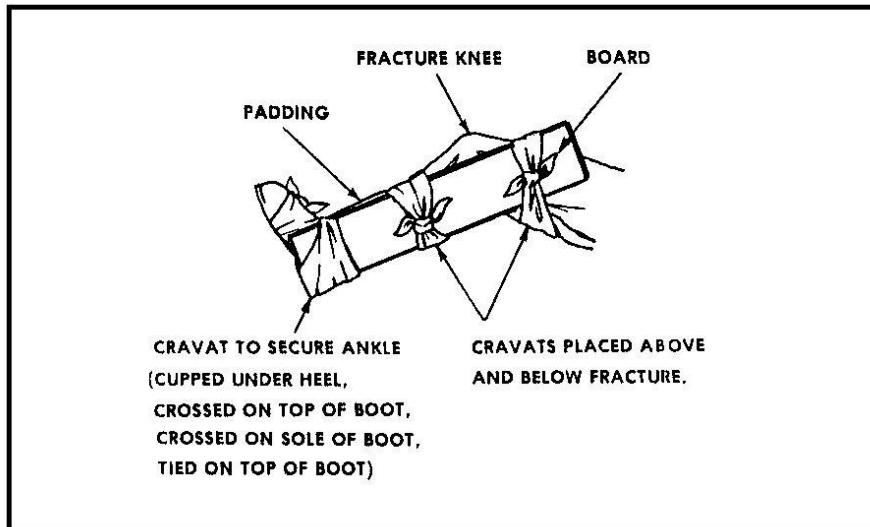

**FIGURE 12-11. UNINJURED LEG USED AS A SPLINT**

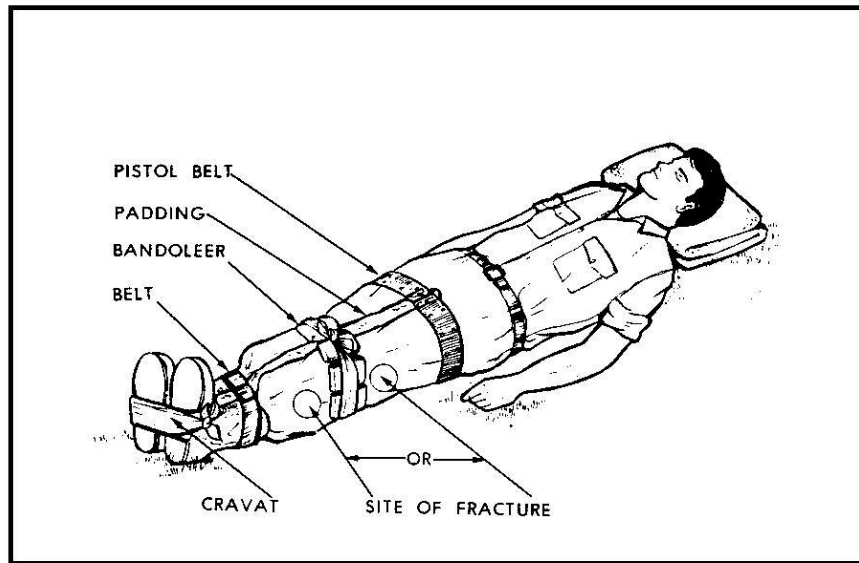

Observe the limb below the cravats for signs of impaired circulation as you secure the splints. After the splint has been secured, recheck the limb's circulation to ensure that the cravats or rigid objects have not interfered with blood circulation. Check the color and temperature of the limb and ask the casualty how the limb feels. If your check before splinting the fracture showed normal circulation and your check now shows poor circulation (bluish skin, slow return of color to nail bed, coolness, or a numb or tingling sensation in the limb), take the following measures to restore circulation.

- Loosen the securing strips/cravats.
- If the end of the rigid object is pressing against the casualty's body (especially under the arm or inside the thigh), reposition the rigid object and/or add padding.
- Retie the securing materials using nonslip knots on the outer rigid object. Make sure that the securing materials keep the rigid objects from slipping, but are not tight enough to interfere with blood circulation.
- Recheck the circulation. If the limb still has poor circulation, evacuate the casualty as soon as possible.

## **12-8. APPLY A SLING TO A FRACTURED ARM**

A sling can be used to support an injured arm with a fractured forearm, wrist, or hand. When the upper arm is fractured, a sling can be used to help immobilize the forearm and elbow. Apply and secure padded rigid objects to immobilize the fracture before

applying the sling. (NOTE: If the chest is to be used as the rigid object, apply the sling before securing the upper arm to the chest with swathes.)

A sling can be made using a triangular bandage, strips of torn material, or the casualty's shirt or jacket.

### Triangular Bandage Sling

A triangular bandage sling can be made from any available nonstretching material such as a muslin bandage, fatigue shirt, trousers, poncho, blanket, or shelter-half.

FIGURE 12-12. APPLYING A TRIANGULAR BANDAGE SLING

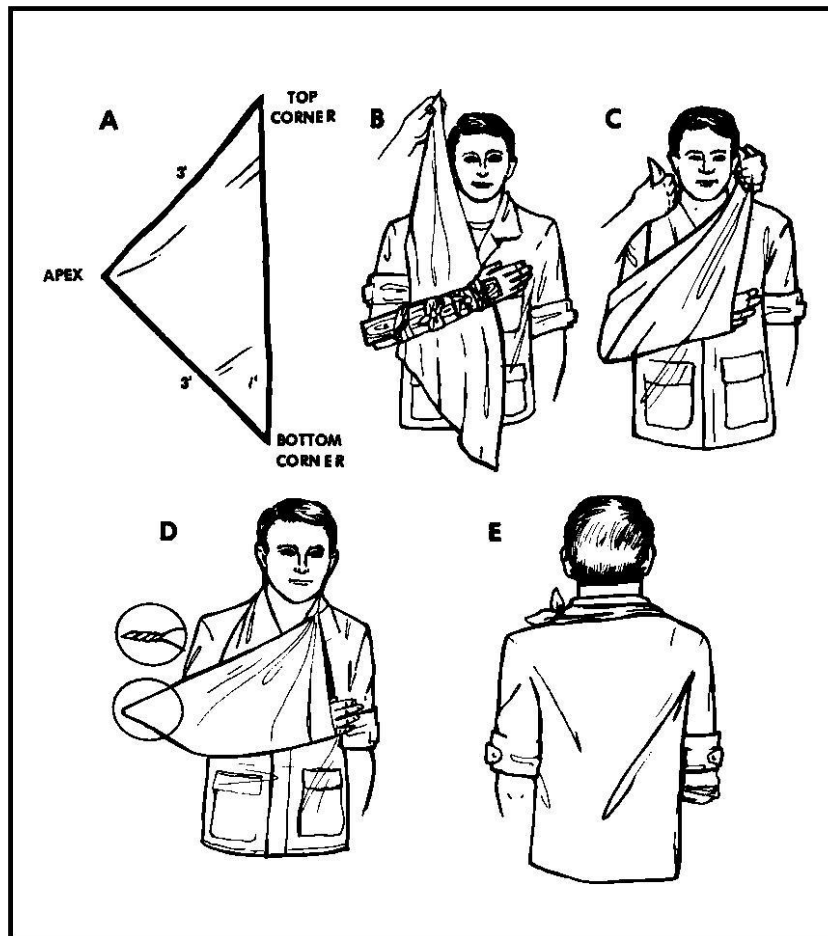

Cut or tear the material into a triangular shape (same as making a cravat).

Insert the material under the injured arm so that the arm is in the center of the material, the apex of the sling is beyond the elbow, and the top corner of the material is over the shoulder of the injured side.

Position the forearm so that the hand is slightly higher than the elbow (at about a 10 degree angle).

Bring the lower portion of the material over the injured arm so that the bottom corner goes over the shoulder of the uninjured side.

Bring the top corner behind the casualty's neck.

Tie the two corners together so that the knot will not slip. The knot should fit into the "hollow" at the side of the neck on the uninjured side. (If the right arm is fractured, for example, tie the knot so that it will rest in the hollow on the left side of his neck.)

Twist the apex of the sling and tuck it in at the elbow. (The corner can also be secured using a safety pin.) This secures the elbow and keeps the forearm from slipping out of the sling.

### **Jacket Flap Sling**

Position the forearm on the casualty's chest with the hand positioned slightly higher than the elbow.

Undo the jacket so that the lower portion (flap) can be brought over the arm to form a sling.

Bring the flap up over the forearm to the pocket area. Position the elbow so that it is inside the sling and will not slip out of the sling.

Push a stick or other rigid object through the flap and the upper portion of the jacket so the flap will not slip.

**FIGURE 12-13. BDU JACKET FLAP SLING**

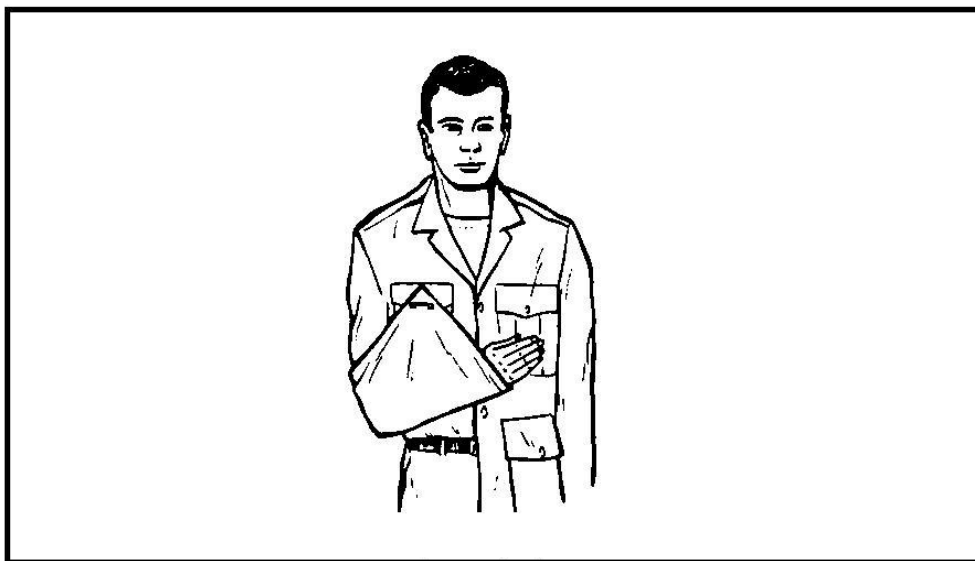

## 12-9. APPLY A SWATHE TO A FRACTURED ARM

A swathe is a band or wrapping used to further immobilize an arm once the fracture has been splinted. A large strip of cloth, blanket strip, pistol belt, trouser belt, bandoleer, or other material can be used as a swathe. The swathe should be three to six inches wide.

FIGURE 12-14. SWATHES

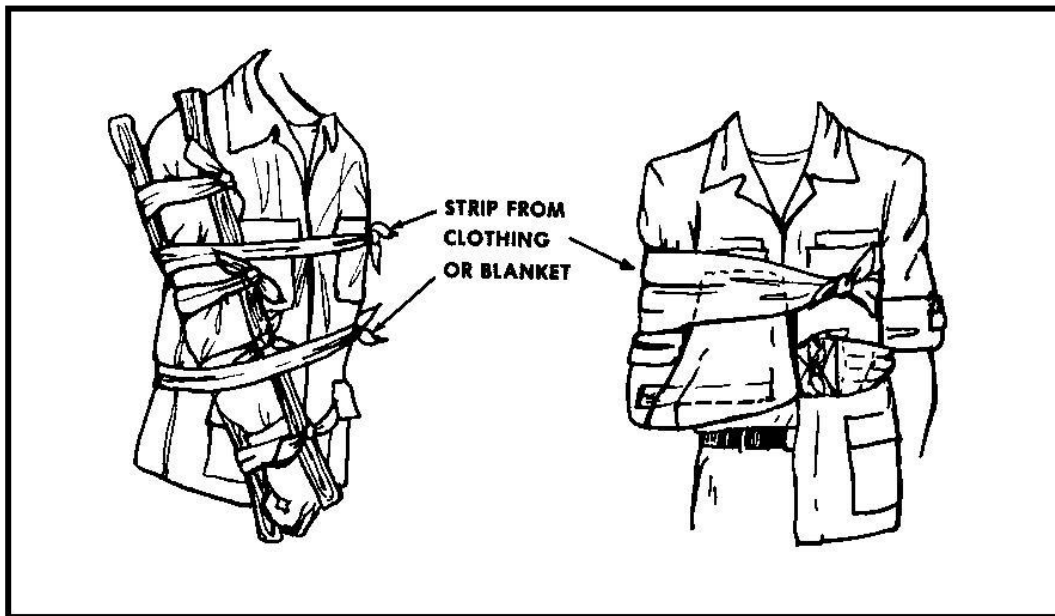

Place one end of the swathe at the breast pocket nearest the uninjured arm.

Wrap the swathe across the sling (if used), around the upper arm on the injured side, behind the casualty's back, under the uninjured arm, and back to the breast pocket.

Tie the two ends in a nonslip knot.

When possible, apply two swathes.

When swathes are used to immobilize a splinted arm without a sling, a swathe is applied above the fracture site and another swathe is applied below the fracture site.

**CAUTION:** Do not apply a swathe on top of the fracture site. The pressure of the swathe could cause additional damage to the nerves and blood vessels around the broken bone.



## PRACTICE EXERCISES: LESSON 12

### Perform First Aid For a Suspected Fracture

**INSTRUCTIONS:** Answer the following exercises by circling the letter of the response that best answers the question or best completes the sentence. Refer to the lesson text, if needed. After you have answered all of the exercises, check your answers against the "Solutions to Exercises" in the Appendix. For each exercise answered incorrectly, reread the lesson material referenced.

1. A fracture of the spinal column is especially dangerous because:
  - a. The nerves located in the spinal column may be damaged.
  - b. The artery located in the spinal column may be damaged.
  - c. The vein located in the spinal column may be damaged.
  - d. The muscles surrounding the spinal column may be damaged.
  
2. You find a soldier lying face down (prone). The soldier is conscious and tells you that he thinks he has injured his back. What should you do?
  - a. Turn him onto his back, place a cloth roll under the arch of his back, and immobilize his head using boots or padded rocks.
  - b. Place several strips of cloth on the ground parallel to one another, then place a board over and perpendicular to the strips. Place padding on the board where the arches of the casualty's neck and back will be. Turn the casualty over so that his spine rests on the board and secure the board using the strips of cloth.
  - c. Tell the casualty to keep still and not move. Send someone to obtain medical help.
  - d. Have another soldier hold the casualty's feet. Put your arms under the casualty's arms and pull until his back is in proper alignment. Then send the other soldier to get medical help.

3. A soldier has fallen and you suspect that he has broken his leg. A fellow soldier says, "Difficulty in moving the limb is a sign of a fracture. Ask him to raise his leg as high as he can." What should you do?
  - a. Ignore the suggestion since difficulty in moving the injured limb is not a sign of a fracture.
  - b. Ask the casualty how his leg feels, but do not ask him to move his leg.
  - c. Gently lift the casualty's leg and check for numbness.
  - d. Tell the casualty to raise his injured leg as high as he can.
  - e. Tell the casualty to raise both legs as high as he can and see if he can lift the injured leg as high as the uninjured leg.
  
4. Which of the following should not be used as a rigid object in splinting a fractured leg?
  - a. A tree limb.
  - b. A loaded rifle.
  - c. The casualty's uninjured leg.
  - d. Broken tent pole.
  
5. You are splinting a broken leg. Which one of the following areas requires extra padding?
  - a. Middle of the upper leg (thigh).
  - b. Middle of the lower leg (calf).
  - c. Knee.
  - d. Site of the fracture.

6. Which of the following, if any, is not a proper procedure prior to splinting a fractured arm?
- Reassure the casualty.
  - Remove rings from the hand of the injured arm.
  - Dress any open wounds that will be covered by the splint.
  - Straighten the limb if it is in an abnormal position.
  - All of the above are proper procedures that should be performed before applying the splint.
7. Of the actions given below, which action(s) should you perform in administering buddy-aid to a casualty with a fractured forearm?
- Secure the rigid objects both above and below the fracture.
  - Push any broken bones back under the skin before applying splints.
  - Apply a sling to the forearm before applying tree limbs to splint the forearm.
  - All of the above are correct buddy-aid procedures.
8. You have splinted a casualty's upper arm. Before you applied the splint, he had good circulation below the fracture. Now he has poor circulation. What should you do?
- Loosen the cravats securing the splint.
  - Tighten the cravats directly over the fracture site.
  - Apply a cravat directly over the fracture site.
  - Apply a tourniquet above the fracture site.

9. You have successfully splinted the casualty's forearm. What else should you do to help immobilize the forearm?
- a. Place the forearm in a sling with the casualty's hand slightly lower than the level of his elbow.
  - b. Place the forearm in a sling with the casualty's hand slightly higher than the level of his elbow.
  - c. Let the forearm hang straight down and use strips of cloth to secure the upper arm to the chest wall.
  - d. Apply a tourniquet above the splint.
  - e. Apply a tourniquet below the fracture site.
10. Consider the following illustration showing a casualty with a fractured left forearm. Where should the knot tying the two ends of the sling be located?

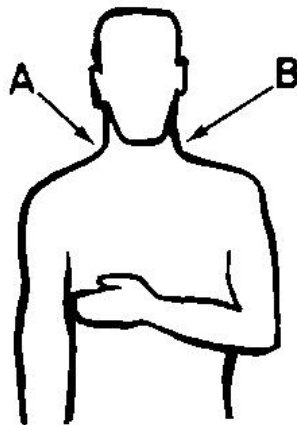

- a. On the side of the neck at point A.
- b. Behind the neck halfway between point A and point B.
- c. On the side of the neck at point B.
- d. In front of the neck halfway between point A and point B.

11. Which of the following is a proper procedure for applying a swathe to a fractured forearm once a sling has been applied?
- a. The swathe should cover the fracture site.
  - b. The knot of the swathe should be tied just above the fracture site.
  - c. The material used to make the swathe should be folded until it is one to two inches wide.
  - d. The swathe should go under the uninjured arm so the uninjured arm will not be restricted by the swathe.

Check your answers

**LESSON 13**  
**PERFORM FIRST AID FOR BURNS**  
**(TASK 081-831-1007)**

**TASK:**

Identify the proper procedures for treating a casualty with burns.

**CONDITIONS:**

Given multiple-choice examination items pertaining to burns.

**STANDARD:**

Score 70 or more points on a 100-point comprehensive examination.

**REFERENCES:**

STP 21-1-SMCT, Soldiers Manual of Common Tasks: Skill Level 1.  
FM 21-11, First Aid for Soldiers.

**NOTE:** Some of the task titles and information have changed and are not reflected in FM 21-11 and STP 21-1-SMCT. Refer to the Army Training Support Center, Common Core Task internet site at: <http://www.atsc.army.mil/dld/comcor/comcore.htm> for up-to-date task information.

**13-1. INTRODUCTION**

This lesson is basically divided into two major events--stop the casualty from suffering additional burns and treating existing burns. When you first discover the burn casualty, you should eliminate the source of the burn in order to protect both the casualty and yourself.

Once the casualty has been protected from further burns, take measures to ensure the casualty is breathing, stop major bleeding, and control shock. Exactly when the burn wound is treated depends upon the seriousness of the injury and upon other injuries which the casualty suffered. A burn with serious bleeding should be treated quickly. If a burned area is on a fractured limb, the burn should be dressed and bandaged before the limb is splinted. Minor burns on a casualty with a life-threatening injury may not need to be treated until the casualty is seen by medical personnel at the medical treatment facility.

## 13-2. CLASSIFY BURN AS TO TYPE

Burns can be classified by their cause. Burns can be thermal, electrical, chemical, or radiant.

### Thermal Burns

Thermal burns are caused by heat. They can be caused by coming into contact with a flame, a hot object, a hot liquid, hot gas (such as steam), or the fireball from a nuclear explosion.

### Electrical Burns

Electrical burns are caused by an electrical current passing through the body. They can be caused by coming into contact or near contact with a charged ("live") electrical wire or lightning. Electrical burns can be deceiving. It may appear that the burn is not serious because only a small area of skin is burned. In reality, however, a great deal of damage may have been done to the casualty's body. Electrical burns involve both an entry burn where the current entered the body and exit burn where the current left the body. An exit burn may appear on any part of the body and can be in a quite different location from the entry burn. The sole of the foot is a common location for the exit burn.

### Chemical Burns

Chemical burns are caused by contact with either liquid or dry chemicals such as ammonia, caustic soda, quick-lime, or white phosphorus (WP). Blisters caused by a blister agent are actually burns.

### Radiant Energy Burns

Radiant energy injuries are caused by bright visible light (such as lasers and electric welding arcs) or other forms of light energy that are not visible (such as ultraviolet light, infrared light, microwaves, and radar waves). The primary danger is to the eyes.

Laser Beam. A person who looks directly into a laser (light amplification by stimulated emission of radiation) beam can receive damage to the retina at the back of his eye.

Laser burns cause an immediate decrease in his ability to see, but are not painful.

Welding Arcs. A person who looks directly at a welding arc can receive burns on the surface of his eye which result in severe pain and sensitivity to light. The pain and sensitivity to light may last until the burn has healed two or three days later. Mild symptoms may appear even if the person did not look directly at the welding arc.

### 13-3. PUT OUT FLAMES

FIGURE13-1. SMOTHERING FLAMES

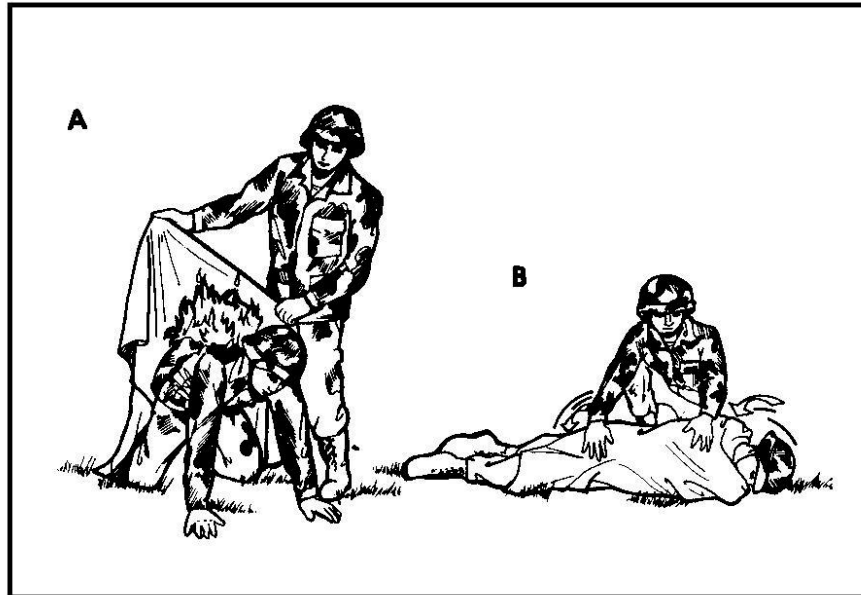

If the casualty's clothing is on fire, cover the casualty with a large piece of nonsynthetic material such as a blanket and roll the casualty on the ground until the flames are smothered. If nonsynthetic material cannot be obtained quickly, get the casualty to the ground and have him roll on the flame until it goes out.

**CAUTION:** Do not use synthetic materials such as nylon and rayon because they may melt and cause additional injury.

### 13-4. REMOVE A CASUALTY FROM ELECTRICAL CURRENT

If the casualty is still in contact with the source of the electrical current (lying on a "live" electrical wire, for example), separate the casualty from the source of the current before administering buddy-aid. Assume that any electrical wire is live (carrying electrical current) and can be a danger to yourself as well as to the casualty.

#### **WARNING**

**Do not touch the electrical wire with your hands. Do not touch the casualty as long as he is in contact with the wire since the current can pass from the wire and through the casualty to you. Either way, you could become a casualty yourself.**



## Stop the Current

If the electrical current can be turned off quickly (such as flipping a switch), turn off the current first. However, if it will take more time to turn off the current than to separate the casualty and the source of the current, cut off the electrical current after you have separated the casualty and have administered buddy-aid.

## Separate Casualty and Current

Remove Source of Current from Casualty. Loop a dry rope, dry clothing, or other material which will not conduct electricity under the casualty's body and lift the casualty from the wire. Have a second person use a wooden limb or other long, nonconducting object to move the wire a good distance from the casualty. Gently lower the casualty to the ground after the wire has been removed.

**FIGURE 13-2. REMOVING AN ELECTRICAL WIRE FROM UNDER A CASUALTY**



Remove Casualty from Current. If you cannot remove the source of the current from the casualty, then remove the casualty from the source of the current. Use nonconductive material to push or drag the casualty from the current source. Do not touch the casualty during the process.

### **WARNING**

**When separating the casualty from an electrical wire, assume that the wire is still charged even if you think you turned off the source of the current. You may have flipped the wrong switch.**

## Check for Breathing

Electrical shock often renders the casualty unconscious and causes difficulties in breathing and heartbeat. Check the casualty's respirations after you have separated him from the current. Administer rescue breathing to the casualty if needed.

### **WARNING**

**Never attempt to administer rescue breathing until the wire has been removed.**

## **13-5. REMOVE CHEMICALS THAT CAUSE BURNS**

Chemicals that attack the skin should be removed as soon as possible.

### **Liquid Chemicals**

Pour as much water as possible over the burned area. (This is commonly called "flushing" the area.) Use water from a canteen, Lyster bag, or water trailer if it is available. If a sufficient amount of water is not available, use any fluid that is drinkable (potable) to flush the area. When flushing an affected eye, ensure it is lower than the other eye to prevent contaminants from entering the good eye.

### **Dry Chemicals**

Use a clean dry cloth to brush off loose particles of the dry chemical. Take care to avoid getting the particles on your body. After brushing off the particles, if a large quantity of water is available, flush the area with as much water or other drinkable liquid as possible. Small amounts of water applied to a dry chemical may cause a chemical reaction transforming the dry chemical into an active burning substance.

### **WARNING**

**Do not flush dry lime unless water or other drinkable fluid is available in large amounts. When combined with water, the lime changes into an active burning substance.**

### **White Phosphorus**

White phosphorus is used in marking rounds and grenades. It begins to give off heat and light when exposed to air. Quickly smother the flame with water and cover the area with wet materials or mud. The wet material or mud will keep air from getting to the white phosphorus and thus keep the particles from burning. Keep the materials covering the phosphorus wet. If the materials dry out and air reaches the phosphorus, the phosphorus will start to burn again.

## **WARNING**

**Do not use grease or oil on the white phosphorus burn. Grease or oil may cause the body to absorb the poisonous white phosphorus particles.**

Get medical help or evacuate the casualty. Appropriate medical personnel can remove the phosphorus particles from the casualty's flesh. Do not attempt to remove the particles yourself.

### **Fallout**

Burns caused by radioactive particles sticking to the casualty's skin are treated in the same manner as regular dry chemical burns.

### **Chemicals in the Eye**

Chemicals can destroy the tissues of the eye. The eye must be flushed with water as quickly as possible.

Position the casualty's head so that the eye to be flushed is lower than the other eye. This keeps chemicals from the eye being flushed from flowing into the other eye.

Hold the casualty's eyelid open.

Pour the water gently into the eye. Pour from the inner edge of the eye (end closest to the nose) to the outer edge.

Continue to flush the eye with water for at least 20 minutes.

### **13-6. TREAT RADIANT ENERGY (LASER) BURNS OF THE EYE**

A radiant energy burn to the eye will affect the casualty's vision. Keep the casualty from looking at the light source. There is no buddy-aid treatment for radiant energy burn other than to protect the eyes from additional exposure to the radiant energy source and to keep the casualty out of bright sunlight.

The casualty's eyes do not need to be bandaged. The casualty, however, may feel more comfortable if a cloth or loose bandage is placed over his eyes if he does not need to walk or continue to perform his mission.

Evacuate the casualty when the mission allows so he can be examined by medical personnel.

### **13-7. TREAT SKIN BURNS**

## **Expose Burned Area(s)**

Cut and gently lift away any clothing covering the burned area. Do not pull clothing over the burned area. Leave any piece of clothing that sticks to the burned area in place.

### **WARNING**

**If you are in a chemical environment, do not expose the wound. Apply the dressing over the casualty's clothing.**

## **Dress and Bandage Burned Area(s)**

Apply a field dressing over the burn wound and secure the dressing using the attached tails. The dressing will help to prevent additional contamination. The tails should be tight enough to hold the dressing in place, but not so tight as to put undue pressure on the injury.

If you do not have a field dressing available or if the burned area is too big to be covered by the dressing, use the cleanest material available to cover the burned area. Secure the material with strips of cloth.

An electrical burn casualty will have an entry and an exit wound. Dress both wounds. The sole of the foot is a common location of exit wounds.

Do not try to clean the burned area before applying the dressing.

Do not apply any grease, ointments, or medications to the burned area.

Do not break any blisters that have formed.

Do not place any dressings over the face or genitalia.

If the burn is caused by white phosphorus, keep the dressing wet.

If the casualty is wearing jewelry on a burned arm or hand and the jewelry can be removed easily, remove the jewelry and put it in his pocket. Burns often cause the limbs to swell and the jewelry may have to be cut off later if it is not removed now. Tell the casualty what you are doing and why.

## **Check for Shock**

Fluid lost through burns is a cause of shock. Take appropriate measures to prevent shock (Lesson 11) if they have not already been started. If the casualty is not in shock and is not nauseated, you can give him small amounts of cool water to drink. Stop

administering the water if the casualty feels as though he may vomit or if signs or symptoms of shock develop.

### **Get Medical Help**

Seek medical help for the casualty or evacuate the casualty, if practical. Casualties with serious burns should be seen by medical personnel as soon as practical.

## PRACTICE EXERCISES: LESSON 13

### Perform First Aid For Burns

**INSTRUCTIONS:** Answer the following exercises by circling the letter of the response that best answers the question or best completes the sentence. Refer to the lesson text, if needed. After you have answered all of the exercises, check your answers against the "Solutions to Exercises" at Appendix A. For each exercise answered incorrectly, reread the lesson material referenced.

1. A person who looks directly into a laser beam may suffer a \_\_\_\_\_ burn.
  - a. Chemical.
  - b. Electrical.
  - c. Radiant.
  - d. Thermal.
  
2. A soldier has seen a sudden bright light. He has a sudden decrease in his vision, but has no pain. He has probably:
  - a. Looked into a laser beam.
  - b. Seen a welding arc.
  - c. Been exposed to white phosphorus.
  - d. Been exposed to radioactive fallout.
  
3. The back of a fellow soldier's shirt has caught on fire. You should:
  - a. Roll him on the ground until the flames go out.
  - b. Have him lie on his back until the flames go out.
  - c. Have him lie on his stomach until the flames go out.
  - d. Have him stand up while you put the flames out with your hands.

4. You have come upon a person lying across a "live" electrical wire. Which of the following is true?
- a. You can safely touch either the person or the wire since the wire is grounded.
  - b. You can safely touch the wire but not the person since the person is absorbing the electrical current.
  - c. You can safely touch the person but not the wire since the wire is not grounded.
  - d. You cannot safely touch either the person or the wire.
5. A casualty has a chemical burn caused by white phosphorus. You have flushed the area with water and have put out the flames. Which of the following procedures should you perform next?
- a. Use a knife to cut the particles out of the casualty's skin.
  - b. Cover the wound with wet cloths or mud.
  - c. Cover the wound with grease or oil.
  - d. Leave the wound exposed to the air.
  - e. Either b or c above.
6. A chemical splashed into a soldier's right eye and he is in pain from the burning sensation. You should immediately:
- a. Place a dressing on the eye.
  - b. Turn his head so that his right eye is lower than the left eye and flush the right eye with water.
  - c. Turn his head so that his right eye is higher than the left eye and flush the right eye with water.
  - d. Put oil or grease on the inside surface of the eyelid and leave the eye exposed to the air.

7. Treatment for radiant energy burn to the eyes includes:
- Applying ointment to the eye.
  - Flushing his eyes with water.
  - Protecting the casualty's eyes from bright sunlight.
  - Putting wet dressings over his eyes.
8. You are in a chemically contaminated area. You come upon a person with a serious thermal burn to the side of his arm. What should you do?
- Expose the burned area by removing any protective clothing covering the area. Apply an ointment or grease to the burned area. Dress and bandage the burned area.
  - Expose the burned area by removing any protective clothing covering the area. Dress and bandage the burned area. Do not apply any ointment or grease to the burned area before dressing the burned area.
  - Apply an ointment or grease to the burned area. Dress and bandage the burned area. Do not expose the burned area.
  - Dress and bandage the burned area. Do not expose the burned area. Do not apply an ointment or grease to the burned area.
  - Leave the burned area exposed to the air. Do not apply any ointment or grease to the burned area. Do not dress and bandage the wound.

Check your answers



THIS PAGE INTENTIONALLY LEFT BLANK

**LESSON 14**  
**PERFORM FIRST AID FOR HEAT INJURIES**  
**(TASK 081-831-1008)**

**TASK:**

Identify heat injuries (heat cramps, heat exhaustion, and heatstroke) and the proper treatment for each.

**CONDITIONS:**

Given multiple-choice examination items pertaining to heat injuries.

**STANDARD:**

Score 70 or more points on a 100-point comprehensive examination.

**REFERENCES:**

STP 21-1-SMCT, Soldier's Manual of Common Tasks: Skill Level 1.  
FM 21-11, First Aid for Soldiers.

**NOTE:** Some of the task titles and information have changed and are not reflected in FM 21-11 and STP 21-1-SMCT. Refer to the Army Training Support Center, Common Core Task internet site at: <http://www.atsc.army.mil/dld/comcor/comcore.htm> for up-to-date task information.

**14-1. INTRODUCTION**

Heat injuries usually occur during hot weather or when a person is working near equipment that produces heat. The body perspires in order to cool itself. If the water and the salt lost through perspiration are not adequately replaced, heat injuries can result. Even a healthy person can suffer heat injury. Heat injuries can be painful and, in some cases, fatal. The three principal types of heat injuries are heat cramps, heat exhaustion, and heatstroke.

## **14-2. IDENTIFY SIGNS AND SYMPTOMS OF HEAT CRAMPS**

Heat cramps are painful muscle spasms (contractions) caused by loss of water and salt from the body, usually through perspiration. Signs and symptoms of heat cramps include:

- Grasping or massaging an arm or leg.
- Bending over in an effort to relieve the pain of an abdominal cramp.
- Skin wet with perspiration.
- Unusual thirst.

## **14-3. IDENTIFY SIGNS AND SYMPTOMS OF HEAT EXHAUSTION**

Heat exhaustion is more serious than heat cramps. It is primarily caused by the body losing water, usually through perspiration, without the water being adequately replaced. Heat exhaustion usually occurs in otherwise fit individuals who are involved in extreme physical exertion in a hot environment. The signs and symptoms of heat exhaustion are very similar to those of shock. The signs and symptoms can be divided into two groups—the most common signs and symptoms and those which are less likely to occur.

### **Common Signs and Symptoms of Heat Exhaustion**

- Profuse sweating with pale, moist, cool skin.
- Weakness or faintness.
- Dizziness.
- Headache.
- Loss of appetite.

### **Other Signs and Symptoms of Heat Exhaustion**

- Heat cramps.
- Nausea (with or without vomiting).
- Chills ("gooseflesh").

- Rapid breathing.
- Urge to defecate.
- Tingling in hands or feet.
- Mental confusion.

#### **14-4. IDENTIFY SIGNS AND SYMPTOMS OF HEATSTROKE**

Heatstroke (also called sunstroke) usually occurs in people who work in a very hot, humid environment for a prolonged period of time. In heatstroke, the body's cooling mechanisms (perspiration, etc.) fail and the body's internal (core) temperature increases to dangerous levels. If the casualty's body temperature is not lowered quickly, death may result. The following are signs and symptoms of heatstroke.

- Lack of normal perspiration.
- Skin that is hot and flushed.
- Headache.
- Dizziness.
- Mental confusion.
- Stomach pains.
- Weakness.
- Nausea.
- Seizures.
- Rapid breathing.
- Sudden loss of consciousness.

#### **WARNING**

**A soldier who is not perspiring or perspiring very little while other soldiers performing the same work are perspiring freely is in danger of being a heatstroke casualty. Take buddy-aid measures immediately.**

#### **14-5. TREAT HEAT CRAMPS**

Move the casualty to a cool shaded area to rest. If there is no shade, improvise a shade using ponchos, blankets, or other available materials.

Loosen the casualty's clothing around his neck and waist and loosen his boots.

#### **WARNING**

**Do not loosen the casualty's clothing if you are in a chemical environment.**

Have the casualty slowly drink one quart (one canteen) of cool water. (Drinking the water too rapidly may cause the casualty to vomit, thus losing even more fluids.)

Seek medical help if the cramps continue. If medical help is not available, evacuate the casualty to a medical treatment facility.

#### **14-6. TREAT HEAT EXHAUSTION**

Move the casualty to a cool shaded area to rest. If there is no shade, improvise a shade using ponchos, blankets, or other available materials.

Have the casualty lie on his back.

Loosen or remove the casualty's clothing around his neck and waist and loosen his boots.

#### **WARNING**

**Do not loosen or remove clothing or pour water over the casualty if you are in a chemical environment.**

Pour water over the casualty and fan him in order to cool his body faster.

Have the casualty slowly drink at least a canteen (one quart) of cool water.

Elevate the casualty's feet above the level of his heart (put a log or other supporting object under his feet or ankles).

Monitor the casualty. When possible, seek medical aid.

If possible, the casualty should not participate in strenuous activity for the remainder of the day.

#### **14-7. TREAT HEATSTROKE**

Heatstroke is a **medical emergency**. The casualty could die if he is not treated in time. If possible, send someone to get medical help while you work with the casualty.

**CAUTION:** Do not leave the casualty alone in order to seek medical aid as long as you can continue cooling effects.

Move the casualty to a cool, shaded area or improvise a shade.

Have the casualty lie down and elevate his legs.

Loosen or remove the casualty's outer garments.

### **WARNING**

**Do not loosen or remove clothing or pour water over the casualty if you are in a chemical environment.**

The preferred method is to spray or pour cool water over the casualty.

Fan the casualty to increase the rate of evaporation and thus cool the casualty faster.

Massage the casualty's arms and legs with cool water. Massaging his arms and legs help to increase the blood circulation in his limbs. Increased blood circulation will result in the body being able to give off more heat, thus cooling the body.

Have the casualty slowly drink one quart of cool water if he is able.

Monitor the casualty's breathing. Administer mouth-to-mouth resuscitation (Lesson 6) if needed.

Evacuate the casualty as soon as possible. Perform measures to cool the casualty's body while he is being evacuated.

### **WARNING**

**Do not delay evacuation in order to start cooling measures. Perform cooling measures en route to the medical treatment facility.**

## PRACTICE EXERCISES: LESSON 14

### Perform First Aid For Heat Injuries

**INSTRUCTIONS:** Answer the following exercises by circling the letter of the response that best answers the question or best completes the sentence. Refer to the lesson text, if needed. After you have answered all of the exercises, check your answers against the "Solutions to Exercises" in the Appendix. For each exercise answered incorrectly, reread the lesson material referenced.

1. A soldier has been marching in a hot climate for several hours. He has not been drinking water even though he has been perspiring heavily. Suddenly, he yells in pain and grasps his leg. He is probably suffering from:
  - a. Heat cramps.
  - b. Heat exhaustion.
  - c. Heatstroke.
  - d. Sunstroke.
  
2. A soldier is performing hard work in a hot climate. Suddenly, he stops work. You notice that he is perspiring heavily and looks pale. He tells you that he feels dizzy and may faint. He is probably suffering from:
  - a. Heat cramps.
  - b. Heat exhaustion.
  - c. Heatstroke.
  - d. Indigestion.
  
3. Lack of perspiration is a sign of:
  - a. Heat cramps.
  - b. Heat exhaustion.
  - c. Heatstroke.

4. What is different in treating a heat injury casualty in a chemical environment rather than a nonchemical environment?
  - a. In a chemical environment, you do not loosen the casualty's clothing.
  - b. In a chemical environment, you do not have the casualty to lie down.
  - c. In a chemical environment, you do not elevate the casualty's legs.
  
5. A person suffering from heat injury should drink at least \_\_\_\_\_ of cool water if possible.
  - a. One pint.
  - b. One quart.
  - c. One gallon.
  - d. One and one-half gallons.
  
6. Which of the following is a life-threatening condition requiring immediate treatment?
  - a. Heat cramps.
  - b. Heat exhaustion.
  - c. Heatstroke.
  
7. Which of the following is/are proper procedures for treating heatstroke in a nonchemical environment?
  - a. Move the casualty to a shaded area.
  - b. Elevate the casualty's legs.
  - c. Pour water on the casualty.
  - d. Evacuate the casualty.
  - e. All of the above.

Check your answers



THIS PAGE INTENTIONALLY LEFT BLANK

**LESSON 15**  
**PERFORM FIRST AID FOR COLD INJURIES**  
**(TASK 081-831-1045)**

**TASK:**

Identify the type of cold injury and the treatment for each.

**CONDITIONS:**

Given multiple-choice examination items pertaining to cold injuries.

**STANDARD:**

Score 70 or more points on a 100-point comprehensive examination.

**REFERENCES:**

STP 21-1-SMCT, Soldier's Manual of Common Tasks: Skill Level 1.  
FM 21-11, First Aid for Soldiers.

**NOTE:** Some of the task titles and information have changed and are not reflected in FM 21-11 and STP 21-1-SMCT. Refer to the Army Training Support Center, Common Core Task internet site at: <http://www.atsc.army.mil/dld/comcor/comcore.htm> for up-to-date task information.

**15-1. INTRODUCTION**

Cold injuries are most likely to occur when an unprepared individual is exposed to winter temperatures. The cold weather and the type of combat operation in which the individual is involved impact on whether he or she is likely to be injured and to what extent. Clothing, physical condition, and mental makeup also are determining factors. However, cold injuries can usually be prevented. Well-disciplined and well-trained individuals can be protected even in the most adverse circumstances. The extent of the cold injury depends upon duration of exposure and adequacy of protection. Individuals with a history of cold injury are more likely to suffer cold injuries. The body parts most easily affected by cold are the cheeks, nose, ears, chin, forehead, wrists, hands, and feet. Proper treatment and management depend upon accurate diagnosis.

## **15-2. IDENTIFY SIGNS AND SYMPTOMS OF CHILBLAIN/FROSTNIP**

Chilblain is caused by repeated prolonged exposure of bare skin at temperature from 60°F to 32°F, or 20°F for acclimated, dry, unwashed skin. Signs and symptoms are the following:

- a. Redness or pallor of affected areas (fingers, nose, ears).
- b. Hot, tender, itching skin.
- c. Absence of pain (numb).
- d. May have ulcerated or bleeding lesions.

## **15-3. IDENTIFY SIGNS AND SYMPTOMS OF FROSTBITE**

Frostbite is the injury of tissue caused from exposure to cold, usually below 32°F depending on the windchill factor, duration of exposure, and adequacy of protection. Frostbite usually occurs in the cheeks, nose, ears, chin, forehead, fingers, hands, wrists, toes, or feet. These areas are more likely to be exposed to cold conditions. These areas also have poorer blood circulation than other parts of the body, and blood carries warmth as well as nutrients.

### **Superficial frostbite**

Superficial frostbite primarily involves injury to the skin and the tissue just beneath the skin. Signs and symptoms of superficial frostbite, listed in the order in which they would appear with increased exposure and time, include:

A tingling sensation, followed by numbness.

A sudden blanching (whitening) of the affected area.

A reddish (in light-skinned individuals) or grayish (in dark-skinned individuals) area on the skin. If the temperature is above freezing, this condition is called chilblain.

### **Deep frostbite**

Deep frostbite occurs when the tissues below the skin freeze. This may include the tissues of the muscles and bones. The blanching and numbness of superficial frostbite always precede the development of deep frostbite. If not properly treated, frostbite can result in the loss of fingers, toes, hands, or feet. It can also result in gangrene--a life-threatening condition. Signs and symptoms of deep frostbite include:

Blisters and sloughing (flaking in large sheets) of affected skin (may occur 24 to 36 hours after exposure).

Swelling or tender areas.

Loss of previous feeling of pain in the affected area.

Pale, yellowish, waxy-looking skin.

Frozen area feels solid or wooden to the touch.

The above frostbite signs and symptoms are applicable to the face, hands, and feet. Deep frostbite is a very serious injury that requires immediate first aid and subsequent medical treatment to avoid or minimize loss of body parts.

#### **15-4, IDENTIFY SIGNS AND SYMPTOMS OF IMMERSION FOOT/TRENCH FOOT**

Immersion foot and trench foot are injuries that result from fairly long exposure of the feet to wet conditions at temperatures from approximately 50°F to 32°F. Inactive feet in damp or wet socks and boots or tightly laced boots which impair circulation are even more susceptible to injury. Trench foot occurred frequently during WWI. Soldiers stood in cold, wet, muddy trenches for extended periods of time awaiting the order to move. Signs and symptoms are as follows:

##### **Early stages/first phase of immersion foot**

The affected area feels cold.

The affected area feels numb and painless.

The pulse is diminished/absent in the affected area.

##### **Later stages/advanced Immersion foot**

The limbs feel hot and burning.

There are shooting pains in the affected area.

The affected area is pale with a bluish cast.

The pulse strength is decreased.

Some other signs that may follow are: blisters, swelling, redness, heat hemorrhages, and gangrene.

#### **15-5. IDENTIFY SIGNS AND SYMPTOMS OF SNOWBLINDNESS**

Snowblindness is the effect that glare from an ice field or snow field has on the eyes. It is more likely to occur in hazy, cloudy weather than when the sun is shining. Glare from the sun will normally cause an individual to instinctively protect his eyes. Signs and symptoms are as follows:

Scratchy feeling in the eyes, as if from sand or dirt.

Watery eyes.

Redness in the eyes.

The casualty may have a headache.

Increased pain with exposure to light.

## **15-6. IDENTIFY SIGNS AND SYMPTOMS OF HYPOTHERMIA**

The destructive influence of cold on the body is called hypothermia (general cooling). This means the body loses heat faster than it can produce it. Hypothermia and frostbite may occur at the same time with exposure to below-freezing temperatures. Hypothermia may occur from exposure to temperatures above freezing, especially from immersion in cold water, wet-cold conditions, or from the effect of wind. Physical exhaustion and insufficient food intake may also increase the risk of hypothermia. Signs and symptoms are given below.

### **WARNING**

**With generalized hypothermia, the entire body has cooled with the core temperature below 95°F. This is a medical emergency.**

**Mild hypothermia (body temperature 90° to 95°F).**

**(NOTE:** Reference to temperatures is made to give you an idea of what is taking place in the body of the casualty.)

Hypothermia should be suspected in any chronically ill person who is found in an environment of less than 50°F.

The casualty is conscious, but usually apathetic or lethargic.

The casualty is shivering.

The skin is pale, cold.

The casualty speaks with slurred speech.

The casualty has poor muscle coordination.

There is a faint pulse.

**Severe hypothermia (body temperature 90°F or lower).**

The casualty's breathing is slow and shallow.

There is irregular heart action.

The pulse is weaker or even absent.

The casualty appears to be in a stupor or is unconscious.

The skin is ice cold.

The casualty's muscles are rigid.

The eyes are glassy.

**15-7. IDENTIFY SIGNS AND SYMPTOMS OF DEHYDRATION (COLD WEATHER)**

Dehydration (cold weather) occurs when the body loses too much fluid, salt, and minerals. When individuals engage in any strenuous exercises or activities, an excessive amount of fluid and salt is lost through sweat. The danger of dehydration is that it is as prevalent in cold regions as it is in hot regions. In cold weather, it is extremely difficult to realize that this condition exists. Signs and symptoms the casualty may exhibit are given below.

The mouth, tongue, and throat are parched and dry.

Swallowing is difficult.

Nausea and dizziness may be present.

The casualty may faint.

There is a feeling of being tired and weak.

There may be muscle cramps, especially in the legs.

The casualty may have difficulty focusing his eyes.

**15-8. TREAT CHILBLAIN/FROSTNIP**

Chilblain is treated by warming the injured body part. Blow warm air on the part or place the body part in contact with a warm object, such as a caregiver's hands or the

casualty's body. If the hands are affected, the casualty can cross his arms and place his hands under his armpits.

Once the body part is rewarmed, protect it from further cold exposure.

## **15-9. TREAT FROSTBITE**

Frostbite is treated by rewarming the affected area slowly and protecting the affected area from refreezing. Move the casualty to the most protected area available and perform the following warming procedures.

**(NOTE:** These rewarming procedures can also be used to treat yourself if you begin to develop cold injury.)

### **WARNING**

**Do not thaw (warm) the casualty's foot (feet) or other seriously frozen areas if he must walk or travel to receive medical help. Thawing the feet and then forcing the casualty to walk on them will cause additional pain and injury. Do not thaw the feet if they will probably refreeze before the casualty can reach a medical treatment facility.**

#### **Face**

Cover the frostbitten area on the casualty's face with your bare hands. Leave your hands in place until the pain in the frostbitten area stops and the color returns to the area.

Cover the casualty with blankets or other dry material to keep him warm and to avoid additional injuries from the cold. Give him warm, nonalcoholic liquids to drink, if available.

Have the casualty seek medical personnel for further evaluation when the opportunity presents itself.

#### **Hand**

Remove jewelry from the affected hand and put it in the casualty's pocket. Loosen constricting clothing to help restore circulation.

Open the casualty's field jacket and shirt.

Place the casualty's frostbitten hand(s) under the armpits (right hand under left armpit; left hand under right armpit).

Close the casualty's clothing to prevent additional exposure to the cold.

Cover the casualty with blankets or other dry material to keep him warm and to avoid additional injuries from the cold.

Give the casualty warm, nonalcoholic liquids to drink, if available.

Tell the casualty to seek medical aid for further evaluation.

## **Feet**

Loosen constricting clothing to help restore circulation.

Remove the boot and sock from the frostbitten foot.

Have another soldier (yourself if no other soldier is available) undo his clothing so that the casualty's foot (or feet) can be placed next to the soldier's abdomen.

Place the casualty's frostbitten foot (or feet) against the abdomen of the second soldier.

Close the second soldier's clothing as much as possible in order to provide additional warmth to the foot (feet) and to protect the second soldier's body from the cold.

Cover the casualty with blankets or other dry material to keep him warm and to avoid additional injuries from the cold.

Give him warm, nonalcoholic liquids to drink, if available.

The casualty should exercise as much as possible while avoiding trauma to the injured part.

Evacuate the casualty to a medical treatment facility if deep frostbite has occurred. If possible, use a litter or other means to evacuate the casualty that will not require him to stand or walk. Any frostbite should be evaluated by medical personnel as soon as practical.

## **Actions to avoid in treating frostbite.**

A well-meaning person can perform certain procedures which can result in harming the person he is trying to help. You should be familiar with these rules.

Snow. Do not rub the frostbitten area with snow or ice. Snow or ice will increase heat loss.

Soaking. Do not soak the frostbitten area. Hot or cold soaks can damage tissue.



Extreme Heat. Do not expose the frostbitten area to extreme heat, such as a fire. Burns can result since the casualty will not be able to judge heat accurately.

Massaging. Do not rub or massage the frostbitten area. Manipulation can cause damage to the tissue.

Alcohol. Do not give the casualty alcoholic beverages. Alcohol causes the blood vessels near the surface to enlarge which results in heat loss.

Tobacco. Do not give the casualty tobacco products. Tobacco promotes heat loss.

Ointments. Do not apply ointment to the affected area. The moisture in the ointment can freeze and cause additional damage to the affected area.

### **15-10. TREAT IMMERSION FOOT/TRENCH FOOT**

Gradually rewarm by exposing to warm air. Do not apply heat or ice. Do not moisten or massage the foot.

Protect affected parts from trauma.

Dry the feet thoroughly and avoid walking.

Elevate the affected part.

Seek medical treatment (evacuate the casualty).

### **15-11. TREAT SNOW BLINDNESS**

Cover the casualty's eyes with a dark cloth.

Seek medical treatment (evacuate the casualty).

## 15-12. TREAT FOR HYPOTHERMIA.

### WARNING

**Hypothermia is a medical emergency. Prompt medical treatment is necessary. The casualty should be evacuated to a medical treatment facility immediately.**

#### **Mild hypothermia.**

Rewarm the body evenly using a heat source such as a campfire or another soldier's body. Merely placing the casualty in a sleeping bag or covering with a blanket is not enough since the casualty is unable to generate sufficient body heat on his own.

Keep the casualty dry and protected from the elements.

Have a conscious casualty drink warm liquids gradually.

Seek medical treatment immediately.

#### **Severe hypothermia.**

Stabilize the temperature by using heat sources such as: camp fire, electric blankets, hot water bottle, etc. The object is to warm the body evenly and quickly.

**CAUTION:** Rewarming a severely hypothermic casualty is extremely dangerous in the field due to the great possibility of such complications as rewarming shock and disturbance in the rhythm of the heartbeat.

Attempt to avoid further heat loss by using blankets, sleeping bags, etc. Remove wet clothing before covering the soldier with blankets or using a sleeping bag. Move the casualty to a place of warmth, if possible.

Evacuate the casualty to the nearest medical treatment facility as soon as possible.

**CAUTION:** Continue to monitor the casualty for life-threatening conditions.

## 15-13. TREAT DEHYDRATION (COLD WEATHER)

Keep the casualty warm.

Loosen the casualty's clothes to improve circulation.

Give the casualty fluids for fluid replacement. (Medical personnel will determine the need for salt replacement.)

Have the casualty rest.

Seek medical assistance.

## PRACTICE EXERCISES: LESSON 15

### Perform First Aid For Cold Injuries

**INSTRUCTIONS:** Answer the following exercises by circling the letter of the response that best answers the question or best completes the sentence. Refer back to the lesson text, if needed. After you have answered all of the exercises, check your answers against the "Solutions to Exercises" in the Appendix. For each exercise answered incorrectly, reread the lesson material referenced.

1. Which of the following is a sign of superficial frostbite?
  - a. Severe muscle cramps in the affected area.
  - b. A tingling feeling which goes away shortly.
  - c. Blisters on the affected area.
  - d. Frozen (wooden) flesh.
  
2. Which of the following statements is true?
  - a. Frostbite is a serious condition that can result in loss of life.
  - b. Frostbite usually begins in an area where there is a large supply of blood and large muscle groups.
  - c. Frostbite can occur when the air temperature is above freezing.
  - d. Once a person has had frostbite, he is less likely to have it again.
  - e. All of the above are true.

3. A soldier has frostbitten toes. How can you rewarm the frostbitten area?
  - a. Soak the casualty's bare foot in hot water.
  - b. Soak the foot in cool water to which ice or snow has been added.
  - c. Put the casualty's bare foot against your abdomen and cover the foot with clothing.
  - d. Put a dry sock on the casualty's foot and put the foot as close as possible to a roaring fire.
  - e. All of the above are acceptable methods of treating frostbite.
  
4. A soldier with deep frostbite of the foot must walk through snow and freezing weather in order to reach medical help. How should his foot be treated?
  - a. The foot should be thawed; then the casualty should put on dry socks and boots and begin walking.
  - b. The foot should not be thawed until the casualty reaches medical help.
  - c. The foot should be thawed, then packed in snow in order to refreeze the foot before he begins his walk.

Check your answers

**LESSON 16**  
**TRANSPORT A CASUALTY**  
**(TASK 081-831-1046)**

**TASK:**

Identify the appropriate one-man carry and/or how to perform the carry.

**CONDITIONS:**

Given multiple-choice examination items pertaining to evacuation.

**STANDARD:**

Score 70 or more points on a 100-point comprehensive examination.

**REFERENCES:**

STP 21-1-SMCT, Soldier's Manual of Common Tasks: Skill Level 1.  
FM 21-11, First Aid for Soldiers.

**NOTE:** Some of the task titles and information have changed and are not reflected in FM 21-11 and STP 21-1-SMCT. Refer to the Army Training Support Center, Common Core Task internet site at: <http://www.atsc.army.mil/dld/comcor/comcore.htm> for up-to-date task information.

**16-1. INTRODUCTION**

After evaluating the casualty's illness or injury and administering first aid, you may need to decide the most effective means of transporting a casualty. Casualties moved by manual carries must be carefully and correctly handled; otherwise, moving the casualty could result in additional injury. Manual carries are often used to transport casualties in tactical situations. Your choice of which type of carry to use depends upon the seriousness of the illness or injury, the weight of the casualty, the strength of the carrier(s), and the distance to be traveled. Using a two-man carry benefits the casualty and the bearers by spreading the load. Improvised litters are the preferred method when the distance may be too far for manual carries or the casualty has an injury that may be aggravated by manual transportation. These litters are for emergency measures and must be replaced by a standard litter at the first opportunity.

## SECTION I. ONE-MAN CARRIES

### 16-2. CHOOSE THE APPROPRIATE METHOD TO MOVE A CASUALTY ON THE BATTLEFIELD

If you need to move (evacuate) a casualty to an aid station or collection point, you must decide which evacuation method is appropriate. The following are general rules. (The rules are listed in order of most likely to be used to less likely to be used in a frontline combat situation.)

**CAUTION;** Do not transport a casualty with a suspected fracture of the neck or back unless a life-threatening hazard is in the immediate area. Wait until medical personnel arrive.

If no other help is available, use an appropriate one-man carry to move the casualty.

If a litter cannot be used (no time, no materials) and another person is available to help carry the casualty, use an appropriate two-man manual carry to move the casualty.

If a standard litter is not available and if the time, materials, and litter bearers are available, construct and use an improvised litter. A door, ladder, cot, bench, chair, or similar objects can be used as an improvised litter.

If the casualty is to be moved, use a standard litter if one can be obtained and two or more litter bearers (including yourself, if applicable) are available. A litter allows a casualty to be moved a greater distance than do manual carries. Also, a casualty is less likely to aggravate existing injuries or to suffer additional injuries if a litter is used.

If possible, use a vehicle to transport the casualty.

### 16-3. CHOOSE AN APPROPRIATE ONE-MAN CARRY

Manual carries are tiring to the bearer. Choose an appropriate carry based upon the casualty's condition, the nature of the casualty's injury, the military situation, the distance to be covered, the weight of the casualty, your strength and endurance, and obstacles that will be encountered.

The fireman's carry is usually used to quickly move an unconscious or disabled casualty for a moderate or long distance. This carry leaves one of the bearer's arms free to carry a rifle, move around obstacles, and so forth.

The support carry is used only with a conscious casualty who can walk or at least hop on one leg. The carry can be used for a long distance until the casualty tires.

The arms carry is generally used to move a conscious or unconscious casualty for a short distance.

The saddleback carry is only used for a conscious casualty who can put his arm(s) around your neck. It is generally used to carry a casualty for a moderate or long distance.

The pack-strap carry is generally used to carry a conscious or unconscious casualty for a moderate distance. This carry is not used if the casualty has a broken arm.

The pistol-belt carry is generally used to carry a conscious or unconscious casualty for a long distance. It is the preferred carry if you must use your rifle, climb banks, or move over obstacles since the carry leaves both of your hands free.

The pistol-belt drag is generally used to move a conscious or unconscious casualty for a short distance. This carry is primarily used when the rescuer must keep very close to the ground, such as during combat.

The neck drag is generally used to move a conscious or unconscious casualty for a short distance. This carry allows the rescuer to stay close to the ground, but not as close as the pistol-belt drag. The carry can be used when moving behind a low wall, under a vehicle, or through a culvert. The neck drag is not used if the casualty has a broken arm.

The cradle drop drag is generally used to move a conscious or unconscious casualty up or down steps or to quickly move a casualty from a life-threatening situation (fire, etc.).

#### **16-4. POSITION A CASUALTY**

Some one-man carries require the casualty to be lying on his abdomen (prone position); other carries/drag require him to be lying on his back (supine position). To turn the casualty either to the prone or supine position, follow these steps.

Kneel at the casualty's uninjured side.



**FIGURE 16-1. TURNING A CASUALTY ONTO HIS ABDOMEN**

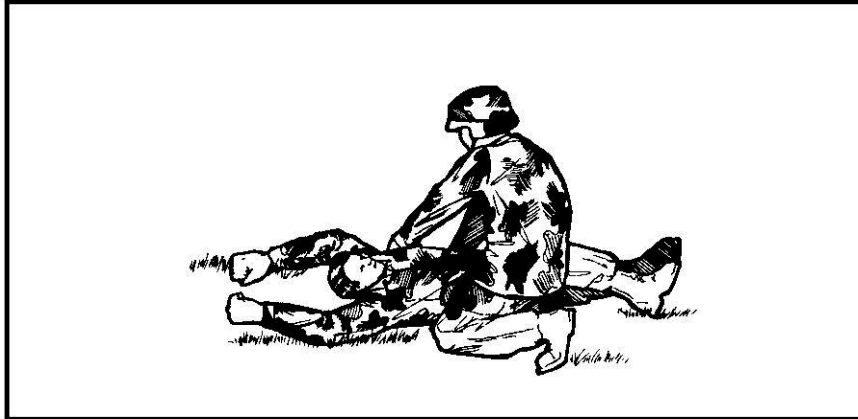

**WARNING**

**If you are in a chemical environment, squat--do not kneel on the ground.**

Place the casualty's arms above his head.

Cross his far ankle over the near one.

Grasp the casualty's clothing at his far shoulder and hip.

Gently pull so that the casualty rolls toward you. Continue until the casualty is on his abdomen or back.

Place the casualty's arms at his sides and straighten his legs.

**16-5. RAISE A CASUALTY TO A STANDING POSITION**

Some one-man carries require that the casualty be raised to a standing position. If the casualty is conscious, you may be able to simply assist him in standing up. If the casualty is unconscious, however, you may need to raise him to a standing position without his help. Usually a casualty is raised from the prone position; therefore, it may be necessary to turn him onto his abdomen. The alternate method is used only if you believe that this method will be safer for the casualty due to the location of his injuries.

**Regular method.**

Position the casualty in a prone position.

Straddle the casualty, slip your hands under his chest, and lock your hands together. Lift the casualty and begin walking backwards until he is on his knees.

Continue walking backwards until his legs are straight and his knees are locked.

Walk forward and bring the casualty to a standing position. Keep the casualty tilted slightly backwards so his knees will remain locked. If his knees do not remain locked, walk backward until they lock and then move forward until the casualty is in the standing position.

Grasp one of the casualty's wrists and raise his arm. Use your other arm to hold the casualty erect.

**FIGURE 16-2. RAISING A CASUALTY TO HIS FEET (REGULAR METHOD)**

Move under the casualty's arm to his front, replace his arm, and hold the casualty

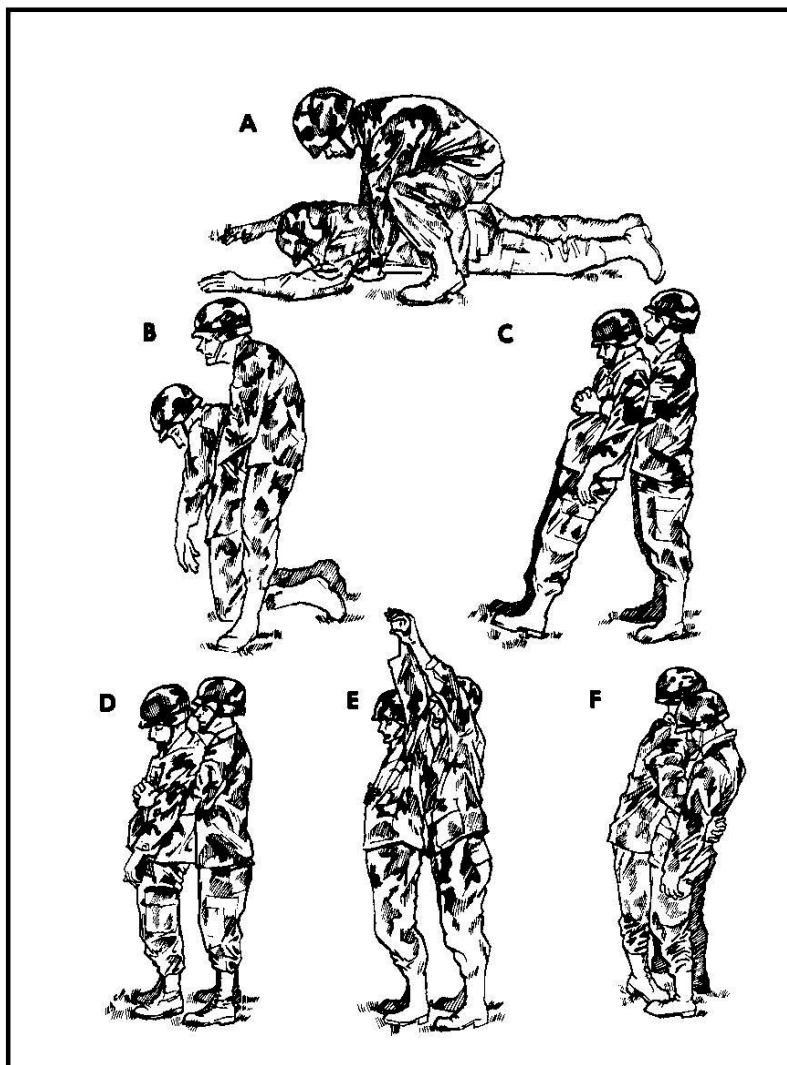

around his waist.

Place your foot between the casualty's feet and spread them so that his feet are about six to eight inches apart.

### **Alternate method**

Position the casualty in a prone position.

Kneel on one knee at the casualty's head.

Put your hands under his armpits, down his sides, and across his back.

Rise, lifting the casualty to his knees.

**CAUTION:** Keep the casualty's head from snapping back and injuring his neck.

Lower your arms, secure a hold on the casualty, and raise him to a standing position with his knees locked.

Put your arms around the casualty's waist and tilt his body slightly backward to keep his knees from buckling.

Place your foot between his feet and spread them so that they are about six to eight inches apart.

FIGURE 16-3. RAISING A CASUALTY TO HIS FEET (ALTERNATE METHOD)

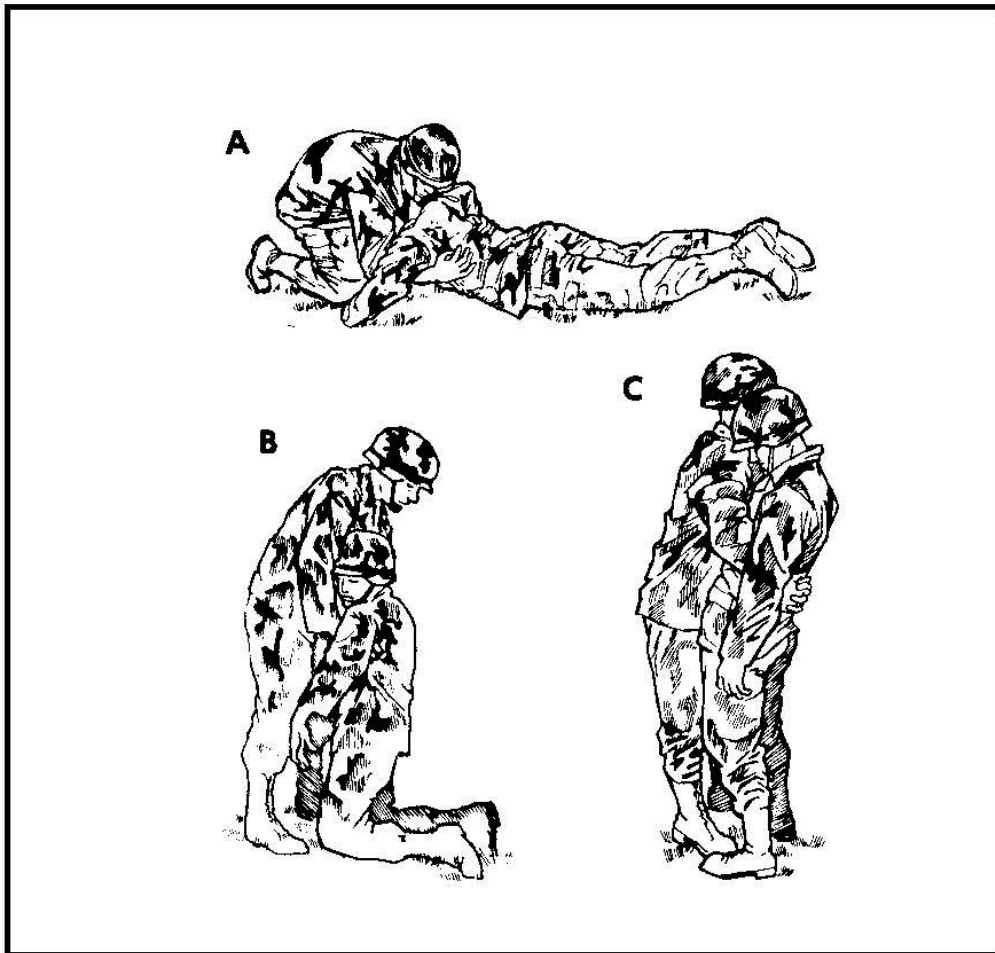

#### 16-6. PERFORM THE FIREMAN'S CARRY

Raise the casualty to a standing position.

Grasp the casualty's wrist and lift his arm over his head while continuing to support the casualty with your other arm.

**CAUTION:** If the casualty has an injured arm, grasp the wrist of the uninjured arm.

Bend at the waist and kneel, pulling the casualty over your shoulder. At the same time, slip your arm from his waist, pass the arm between the casualty's legs, and grasp behind the casualty's knee.

**FIGURE 16-4. PERFORMING THE FIREMAN'S CARRY**

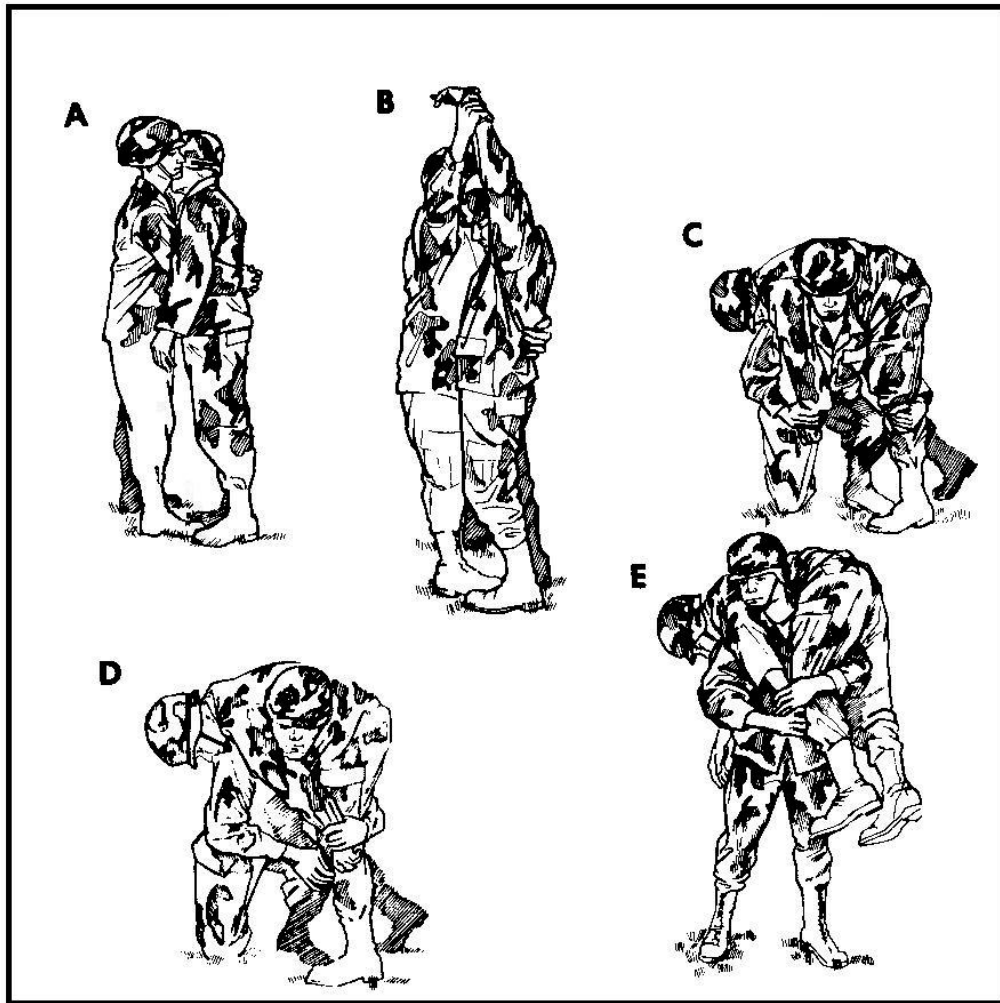

Move the hand grasping the casualty's wrist to the hand at the casualty's knee.

Grasp the casualty's wrist with the hand at the casualty's knee, freeing your other hand.

Place your free hand on your knee and slowly rise to a standing position. Use the hand on your knee to help you rise without straining your back.

Adjust the casualty's body so his weight is distributed comfortably.

Move forward, carrying the casualty.

## 16-7. PERFORM THE SUPPORT CARRY

FIGURE 16-5. SUPPORT CARRY



Position the casualty in a sitting position.

Bend down at the casualty's side so that you are facing in the same direction as the casualty.

**CAUTION:** If the casualty has an injured leg, position yourself so that the injured leg is next to you.

Bring the casualty's near arm over your shoulder and grasp his wrist with your hand that is away from the casualty.

Put your near arm around the casualty's waist.

Stand up, helping the casualty to rise to a standing position also.

Assist the casualty to walk or hop on one leg. Adjust your walking motion as needed to help the casualty maintain his balance.

## 16-8. PERFORM THE ARMS CARRY

Raise the casualty to a standing position.

Slide one of your arms under the casualty's arm, behind his back, and under his other arm.

Move to the casualty's side, bend down, and place your other arm behind the casualty's knees.

Lift the casualty from the ground and stand erect.

Carry the casualty high on your chest to lessen fatigue.

**FIGURE 16-6. ARMS CARRY**

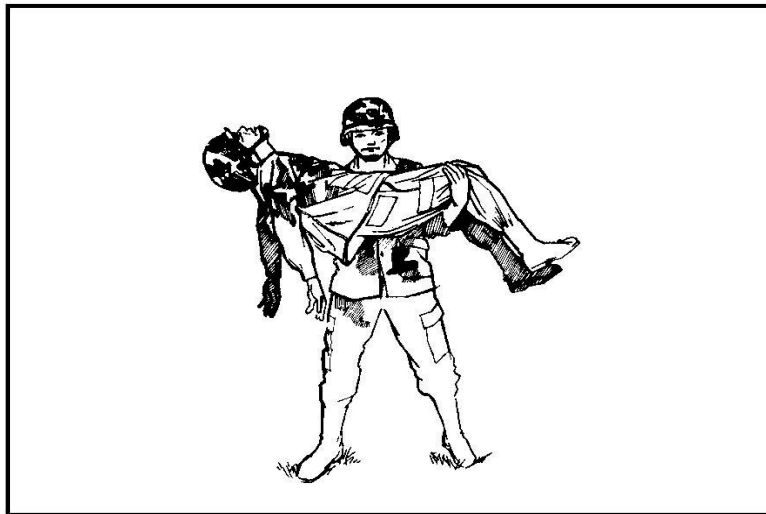

### **16-9. PERFORM THE SADDLEBACK CARRY**

**FIGURE 16-7. SADDLEBACK CARRY**



Raise the casualty to a standing position. (Since the casualty is conscious, he may be able to rise with assistance.)

Grasp the casualty's wrist and lift his arm over his head while continuing to support the casualty with your other arm.

Turn so that your back is to his front and bring his arm over your shoulder. Support the casualty's waist with your other arm, if needed.

Have the casualty put his other arm around your neck. If possible, he should grasp one of his wrists with his other hand.

Stoop and move your arms back and around the outside of the casualty's thighs.

Bring your hands inside of his thighs to your sides, lifting the casualty's thighs.

Stand up and clasp your hands together in front of you.

Adjust the casualty's weight to make the weight distribution more comfortable and walk forward.

## 16-10. PERFORM THE PACK-STRAP CARRY

FIGURE 16-8. PERFORMING THE PACK-STRAP CARRY

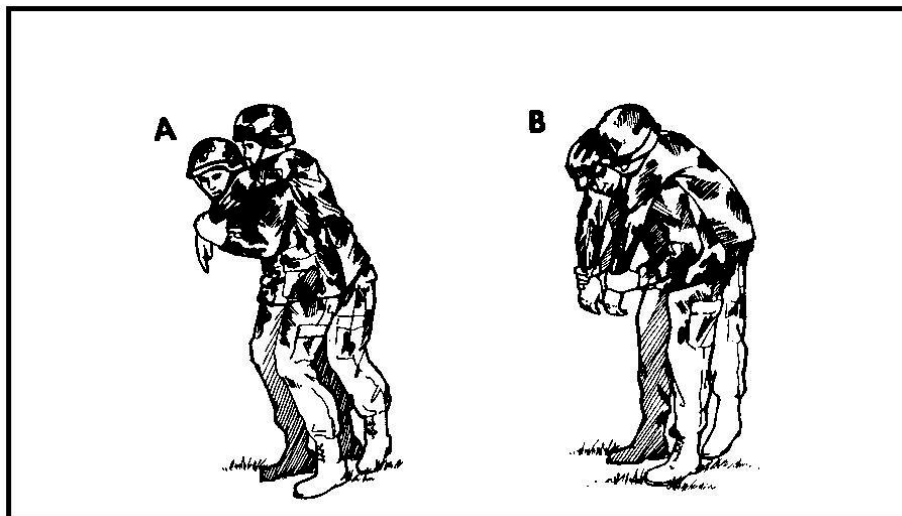

Raise the casualty to a standing position.

Grasp one of the casualty's wrists and lift his arm above his head while continuing to support the casualty's waist with your other arm.



Turn and bring the casualty's raised arm over your shoulder as you turn so that your

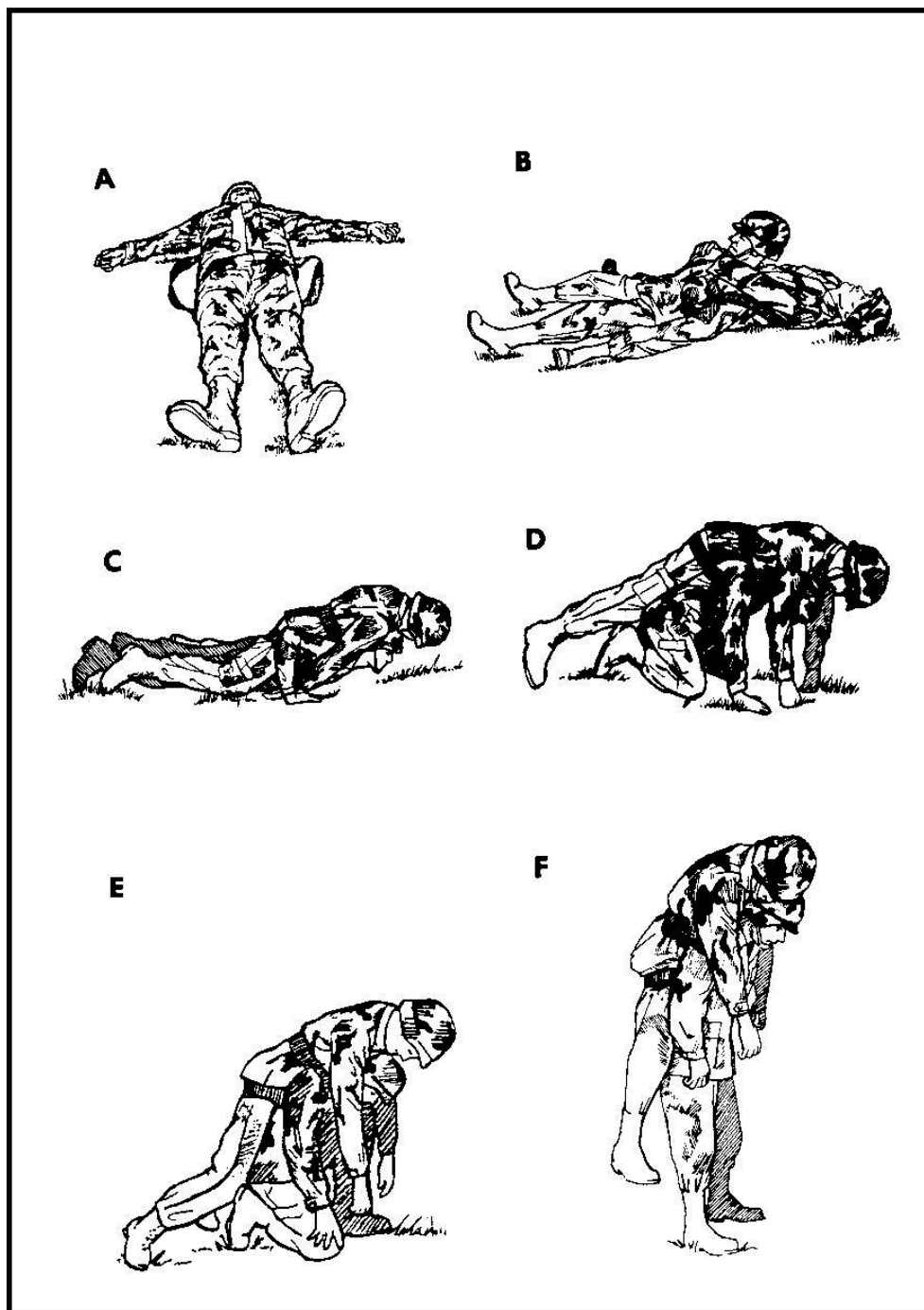

back is to the casualty's front. Bend your knees somewhat so that your shoulder fits under his arm.

Release his waist, grasp his other wrist, and bring that arm over your other shoulder.

**CAUTION:** Hold both wrists so that his hands are in a palms down position (palms toward your abdomen). Twisting his hands could result in injury to the casualty's wrists, elbows, or shoulders when he is lifted and carried.

Bend forward and hoist the casualty as high on your back as possible so that his weight is resting on your back.

Walk forward, keeping bent so that the casualty's weight is balanced on your back and his feet are not dragging.

### **16-11. PERFORM THE PISTOL-BELT CARRY**

Form the sling by joining two fully-extended pistol belts together to form one large loop. If pistol belts are not available, use any material which will not break and which will not cut or bind the casualty (one rifle strap, two cravat bandages, etc.) to make the sling.

Position the casualty on his back.

Slip the sling under the casualty so that top part of the loop is under his lower back, the bottom part of the loop is under his thighs, the belt buckles are centered behind the casualty, and a loop end extends from each side.

Move the casualty's legs apart and lie between them on your back.

Thrust your arms through the loop ends. Adjust the sling so that the loop ends fit over your shoulders.

Grasp the casualty's wrist and his trouser leg on his injured side.

Roll toward the casualty's uninjured side and onto your abdomen. (Both you and the casualty are now in a prone position.)

Release the casualty's wrist and leg and push yourself up until you are on your knees.

Rise to a kneeling position and place your hands on your knees for support.

Rise to your feet. Lean forward to balance the casualty's weight.

#### **FIGURE 16-9. PERFORMING THE PISTOL-BELT CARRY**

Adjust the casualty's weight to a more comfortable position, if needed, and walk forward. Your hands are free to carry a rifle or other objects, climb obstacles, etc.

- If the casualty is unconscious and you do not have to carry anything in your hands, you can grasp his wrists (palms down) to help balance him easier while you are walking.
- If the casualty is conscious, have him put his arms around your neck.

## **16-12. PERFORM THE PISTOL-BELT DRAG**

Extend two pistol belts to their full length and join them together to make one large loop. Other materials, such as a rifle sling or two cravats, can be used if pistol belts are not available. In some cases, three pistol belts may be needed.

Position the casualty on his back.

Slip one end of the loop across the casualty's chest, under his armpits, and under his shoulders.

Twist the remainder of the loop to form a figure 8. Adjust the loops so that the buckles cross in the center of the figure 8.

Lie on your side facing the casualty. You should be lying in the same direction as the casualty. Support yourself on your elbow.

Slip the arm on which you are resting through the top loop of the figure 8 and bring the loop over your shoulder.

Turn onto your abdomen. The sling is now across your chest and the loop is on the shoulder away from the casualty. This far shoulder will support his weight. Having the sling under your chest will help to keep the casualty from slipping out of the loop.

Crawl, dragging the casualty with you.

**FIGURE 16-10. PERFORMING THE PISTOL-BELT DRAG**

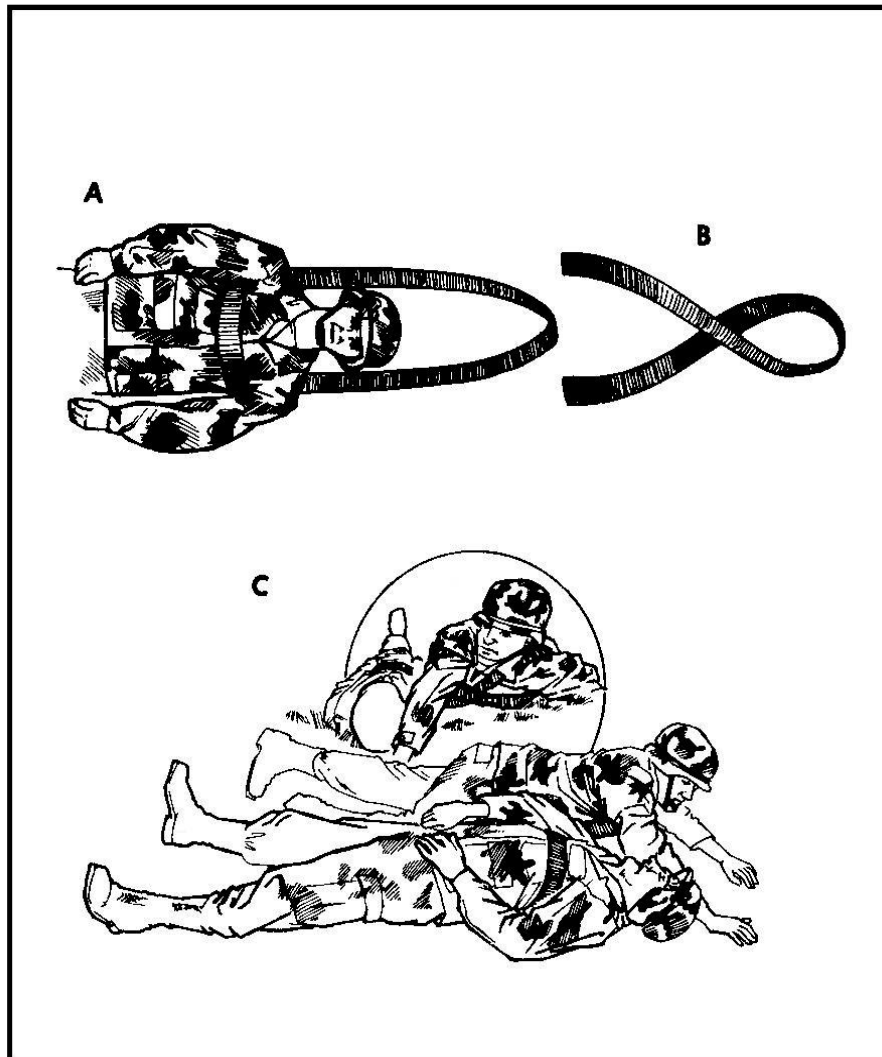

**16-13. PERFORM THE NECK DRAG**

Tie the casualty's hands together with material that will not cut his wrists, such as the casualty's field dressing or a cravat. Do not tie the materials tight enough to interfere with blood circulation. If the casualty is conscious, have him interlock his fingers.

Face the casualty's head and straddle his hips on your knees.

Loop the casualty's arms around your neck.

FIGURE 16-11. NECK DRAG

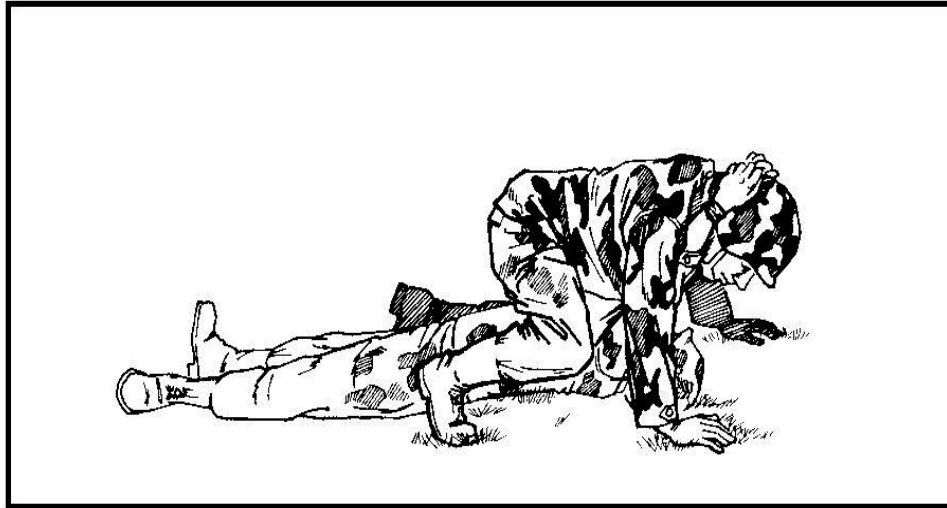

Crawl forward on your hands and knees, dragging the casualty beneath you.

**CAUTION:** If the casualty is unconscious, keep his head from dragging on the ground.

#### 16-14. PERFORM THE CRADLE DROP DRAG

Position the casualty on his back.

Kneel at the casualty's head.

Slide your hands (palms up) under his shoulders and grasp the clothing under his armpits.

Partially rise so that the casualty is pulled to a semisitting position. Support his head on one of your arms. If possible, bring your elbows together and use both forearms to support the head.

Rise to a stooped position and drag the soldier backward.

**CAUTION:** If you are going down steps, walk down them carefully going backward. Support the soldier's head and shoulders, letting his hips and legs drop from step to step.

FIGURE 16-12. PERFORMING THE CRADLE DROP DRAG

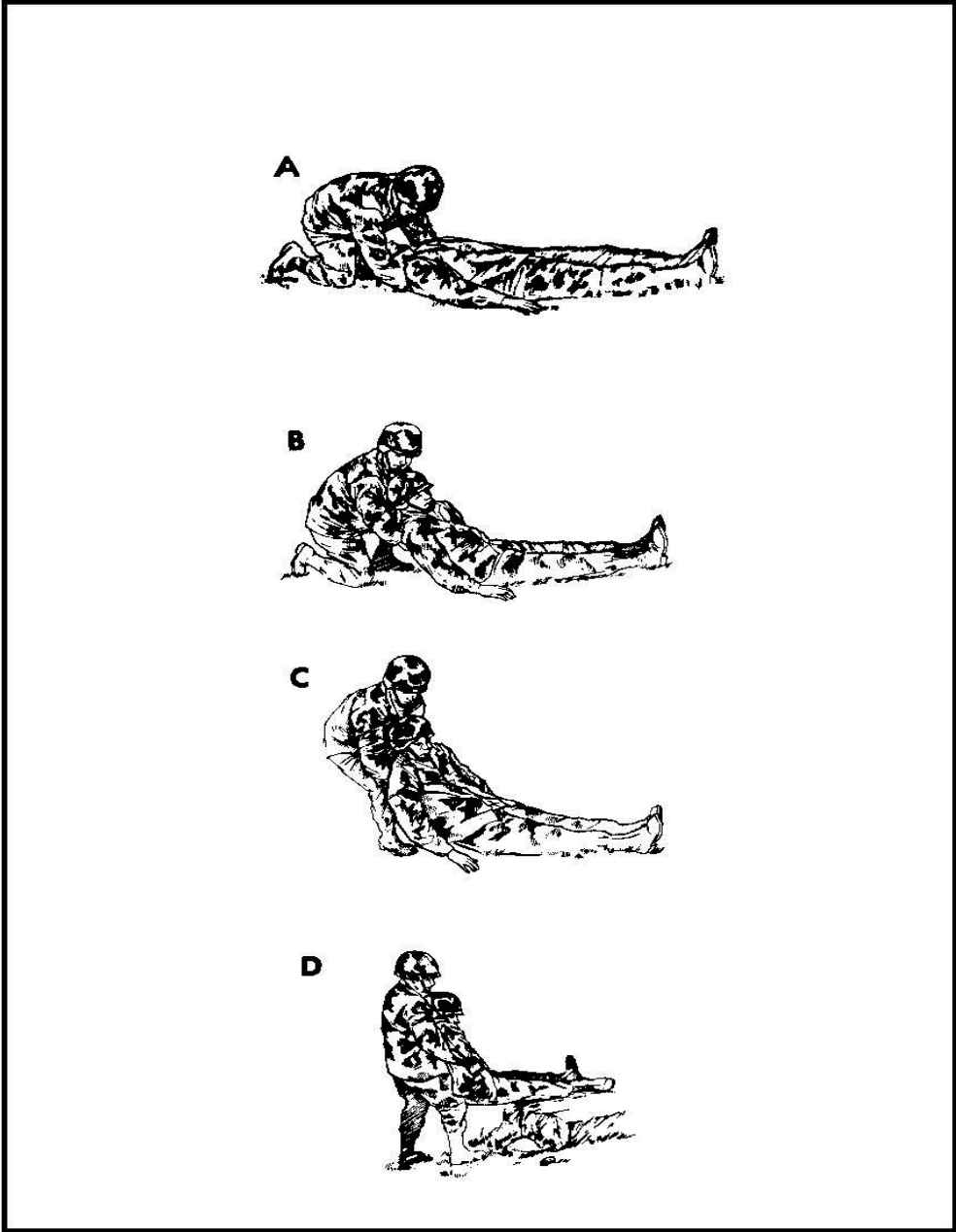

## SECTION II. TWO MAN CARRIES

### 16-15. MOVE A CASUALTY USING THE TWO-MAN FORE-AND-AFT CARRY

Sometimes, a litter is not available and cannot be improvised. In such cases, manual carries may be used to evacuate the injured soldier. A two-man manual carry is usually preferred over a one-man manual carry. The two-man fore-and-aft carry can be used to move a conscious or unconscious casualty. It is not as tiring as other carries; therefore, it is usually the preferred two-man carry for moving a casualty for a long distance.

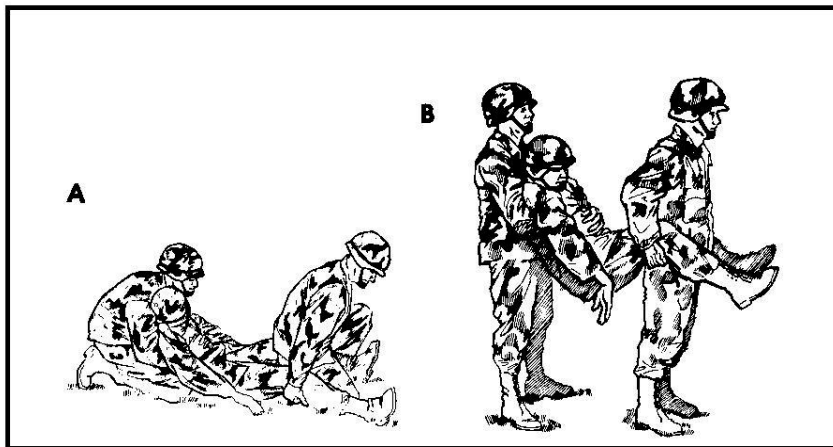

FIGURE 16-13. TWO-MAN FORE-AND-AFT CARRY

Position the casualty on his back with his arms by his sides.

The taller of the two bearers kneels at the casualty's head and faces toward the casualty's feet. He then slides his hands under the casualty's arms and across the casualty's chest. Then he locks his hands together over the casualty's chest.

The second bearer spreads the casualty's legs and kneels between the casualty's legs with his back to the casualty's head. He then reaches down and places his hands under the casualty's knees.

Both bearers rise together and lift the casualty.

Bearers walk forward with the casualty.

#### **Modified Two-Man Fore-and-Aft Carry (for placing casualty on litter).**

Bearer #1 kneels behind the casualty's head and slips his arms under the casualty's arms.

Bearer #2 spreads the casualty's legs apart and squats or kneels between the casualty's legs while facing Bearer #1.

Both bearers rise in unison upon the leader's command.

Bearers move the casualty over the litter.

Bearers lower the casualty onto the litter in unison upon the leader's command.

**FIGURE 16-14. LIFTING A CASUALTY USING THE MODIFIED TWO-MAN FORE-AND-AFT CARRY**

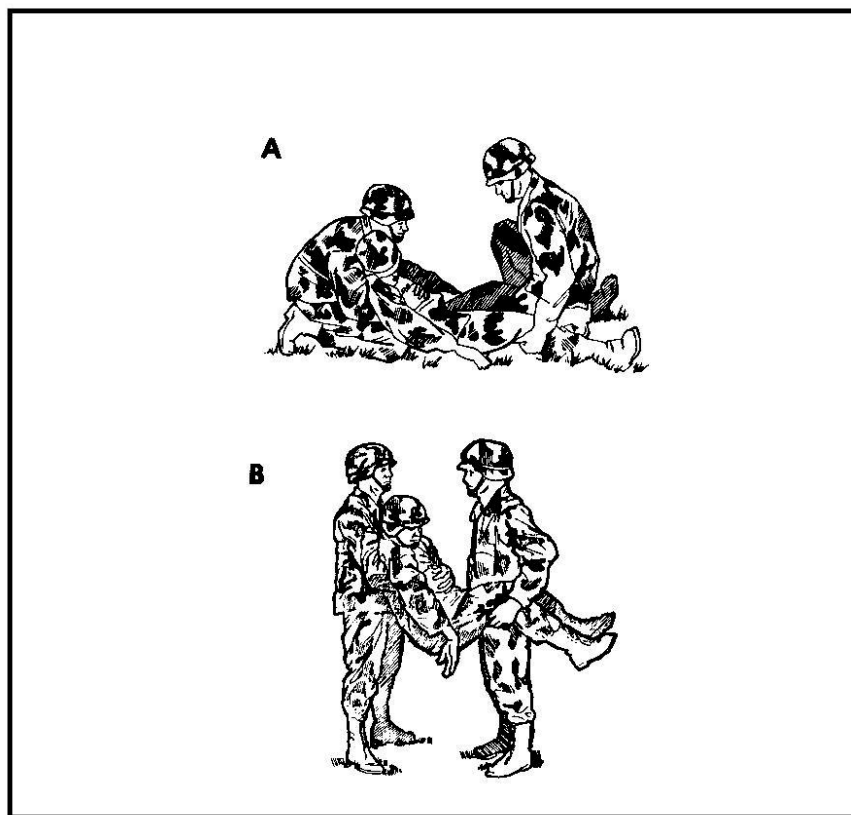

**16-16. MOVE A CASUALTY USING THE TWO-MAN SUPPORT CARRY**

The two-man support carry can be used to transport either a conscious or an unconscious casualty. It is especially useful if the casualty is conscious and needs assistance walking.



**FIGURE 16-15. TWO-MAN SUPPORT CARRY**

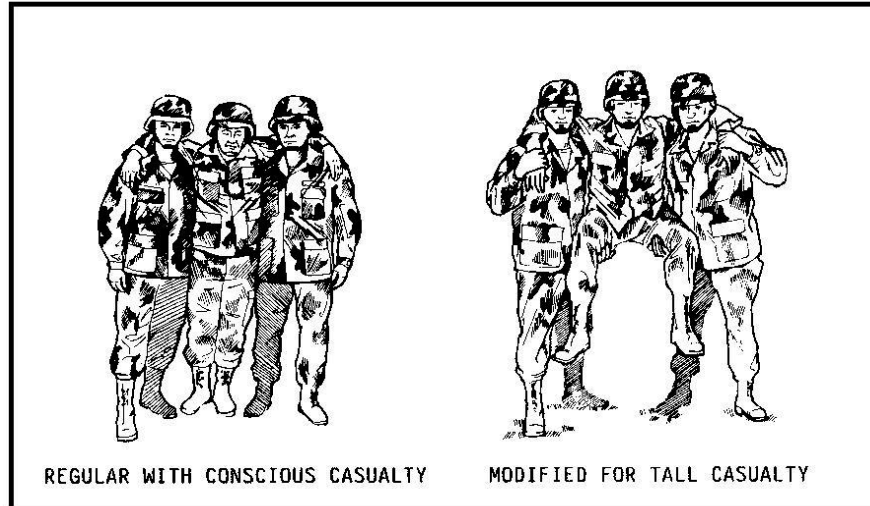

Bearers kneel on each side of the casualty and face so that the casualty will also be facing the same direction.

Each bearer takes the casualty's nearest arm, brings it around his neck, and grasps the casualty's wrist in his outside hand.

Each bearer puts his other arm (the arm that is nearest the casualty) around the casualty's waist.

Both bearers rise in unison, lifting the casualty. If the casualty is conscious, he can help the bearers lift his weight and may be able to walk with assistance. The arms around the casualty's waist should support most of the weight.

**CAUTION:** If the casualty is unconscious, the bearers should not release the casualty's wrists.

Bearers walk forward with the casualty.

If the casualty is taller than the bearers, the bearers can remove their arms from around the casualty's waist and use them to lift and support the casualty's thighs. This will keep to the casualty's feet from dragging.

### **16-17. MOVE A CASUALTY USING THE TWO-MAN ARMS CARRY**

The two-man arms carry can be used to move a conscious or unconscious casualty for a moderate distance.

**FIGURE 16-16. LIFTING A CASUALTY USING THE TWO-MAN ARMS CARRY**

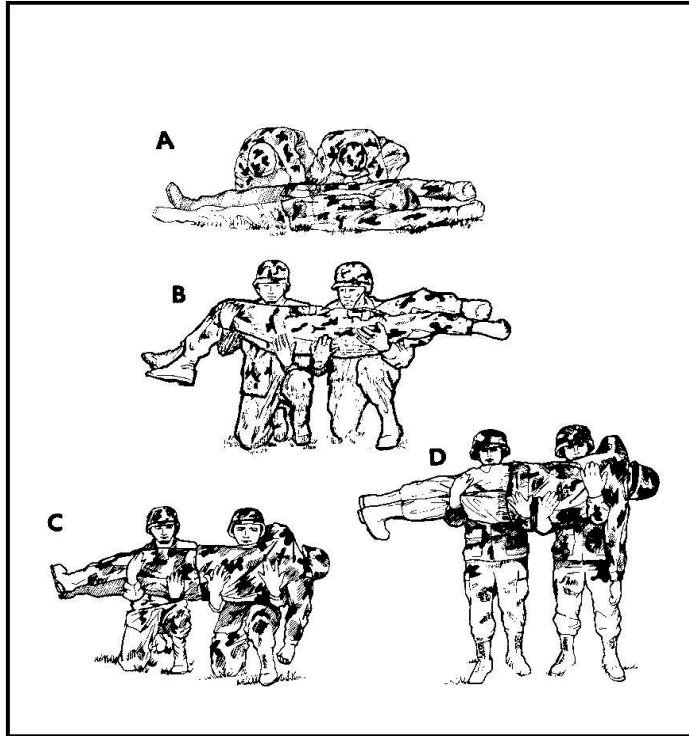

Position the casualty on his back and place his arms above his head.

Both bearers position themselves on the same side of the casualty--one at the casualty's chest and one at his thighs.

Both bearers kneel on one knee.

The bearer at the casualty's chest slips one arm beneath the shoulders and the other arm beneath his waist.

The bearer at the casualty's thighs slips one arm beneath the casualty's hips and the other arm beneath his knees.

Both bearers shift their weight backward in unison and lift the casualty to knee level, keeping the casualty as level as possible.

Both bearers bring the casualty's front close to their chests.

Both bearers rise to their feet in unison.

Bearers move forward carrying the casualty high on their chest. (This lessens fatigue while transporting the casualty.)

**CAUTION:** More than two bearers may be required if the casualty is heavy or if the casualty's head or legs need additional support. If a casualty with a back or neck injury has to be moved by manual carry, a four-man arms carry is used. A third bearer supports the casualty's head and a fourth supports his legs. The casualty's body is kept as level as possible and all movements are done in unison to keep the casualty's body in alignment.

**Modified Two-Man Arms Carry (for placing casualty on litter).**

Two litter bearers position themselves on the same side of the casualty (opposite side from litter) and kneel on one knee.

Bearer #1 slips his arms under the casualty's back and waist.

Bearer #2 slips his hands under the casualty's hips and knees.

Both bearers lift in unison upon command from the leader.

Bearers move the casualty over the litter or have another bearer push the litter under the casualty.

Bearers lower the casualty onto the litter in unison upon the leader's command.

**FIGURE 16-17. LIFTING A CASUALTY USING THE MODIFIED TWO-MAN ARMS CARRY**

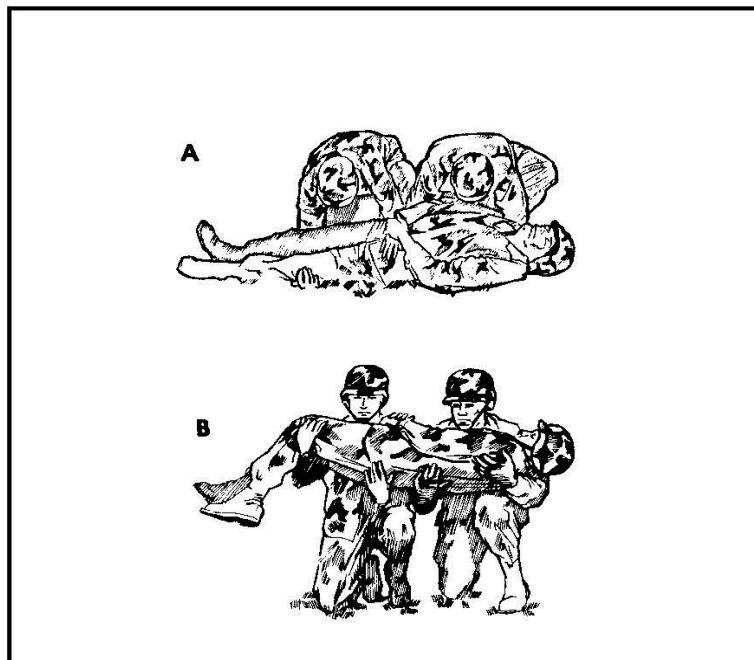

**16-18. MOVE A CASUALTY USING THE TWO-HAND SEAT CARRY**

The two-hand seat carry can be used to move a conscious or unconscious casualty for a short distance.

**FIGURE 16-18. TWO-HAND SEAT CARRY**

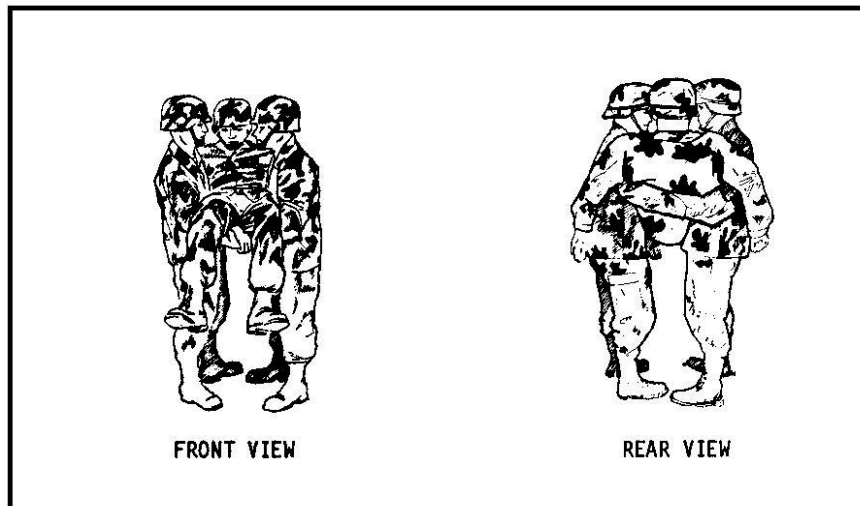

Position the casualty on his back.

Bearers position themselves on opposite sides of the casualty's hips and knee.

Each bearer passes one arm under the casualty's back and the other arm under the casualty's thigh.

Bearers grasp each other's wrists securely.

Both bearers rise in unison, lifting the casualty.

Bearers move forward, carrying the casualty.

#### **16-19. MOVE A CASUALTY USING THE FOUR-HAND SEAT CARRY**

The four-hand seat carry is only used to carry a conscious casualty that can help support himself while he is being carried. This carry is especially useful in transporting a person with a head or foot injury for a moderate distance.

**FIGURE 16-19. FOUR-HAND SEAT CARRY**

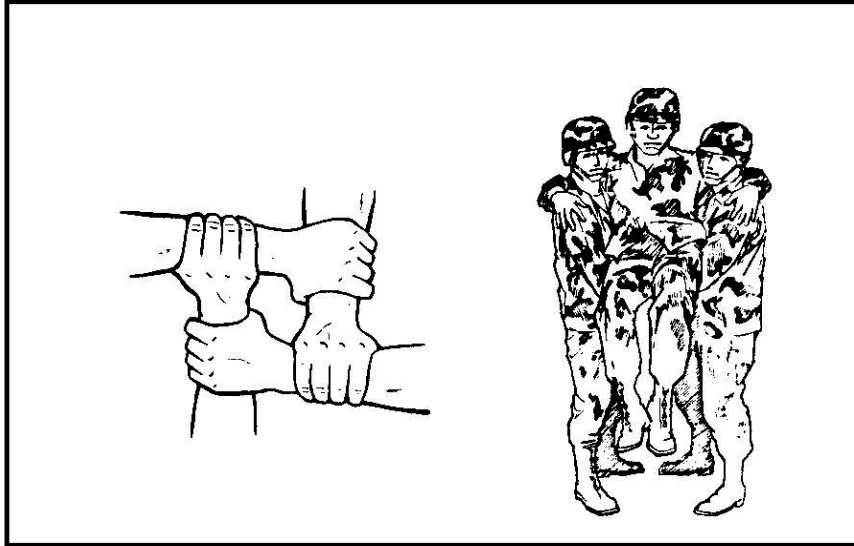

Both bearers position themselves behind the casualty.

Bearers face each other. Each bearer grasps his own left wrist with his right hand, and grasps the other bearer's right wrist with his left hand. This forms the seat for the casualty.

Casualty stands on his own or another soldier helps the casualty to a standing position.

Both bearers lower their bodies so that the seat is about even with the casualty's knees.

Casualty sits on the bearers' forearms and places his arms around the bearers' shoulders for balance and support.

Bearers stand erect in unison, lifting the casualty.

Bearers move forward.

### SECTION III. LITTER CARRY

#### 16-20. MAKE AN IMPROVISED POLE AND PONCHO LITTER

An improvised litter can be made using two tent poles and a poncho. Variations of this litter include using straight tree limbs or other rigid objects for the poles. When the casualty is placed on the litter, his weight will hold the litter together.

FIGURE 16-20. CONSTRUCTING AN IMPROVISED POLE AND PONCHO LITTER

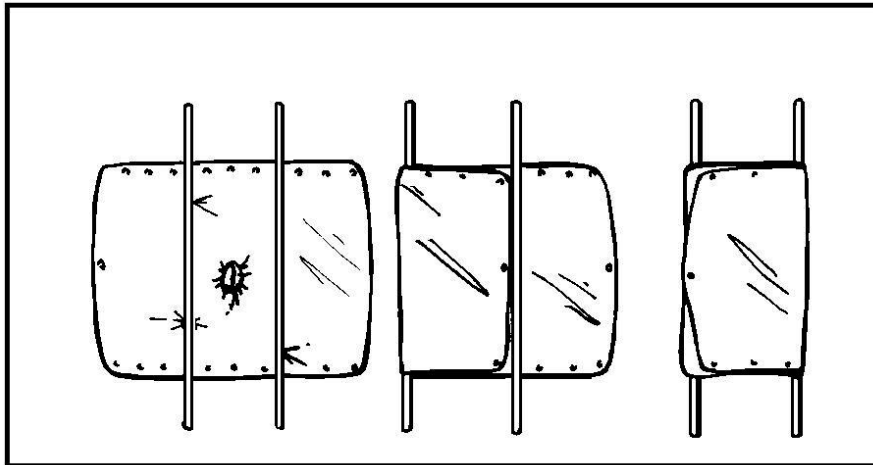

Open the poncho and lay it flat on the ground.

Lay two poles lengthwise across the poncho so that the poncho is divided into thirds.

Reach in and pull the hood toward you and lay it flat on the poncho. Make sure that the draw strings are not hanging out of the hole.

Fold one outer third of the poncho over the pole.

Fold the other outer third of the poncho over its pole.

#### 16-21. MAKE AN IMPROVISED POLE AND JACKET LITTER

An improvised litter can be made using two tent poles and two or three field jackets. Tree limbs or other straight, rigid objects can be used instead of the poles. Heavy shirts or other jackets can be used instead of field jackets.

**FIGURE 16-21. POLE AND JACKET IMPROVISED LITTER**

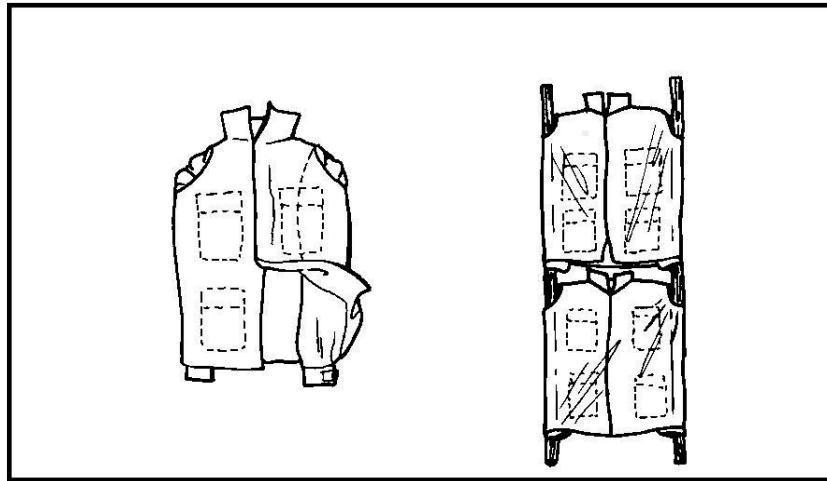

Close (zip or button) the jackets (or other garments).

Turn the garments inside out, but leave the sleeves inside. (Turning the garments inside out puts buttons and zippers inside and keeps them from getting snagged on bushes or other obstacles.)

Pass the poles through the sleeves.

### **16-22. MAKE AN IMPROVISED POLE AND SACK LITTER**

An improvised litter can be made using two tent poles or similar rigid objects and two empty heavy-fabric sacks such as potato sacks.

**FIGURE 16-22. POLE AND SACK IMPROVISED LITTER**

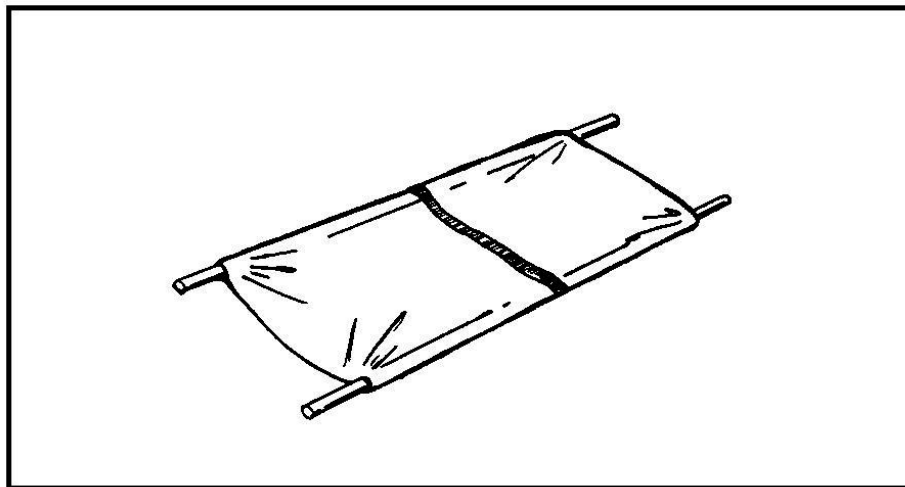

Cut holes in the two corners of the closed end of each sack.

Place the sacks lengthwise so that the open ends of the sacks are facing each other.

Slide the poles or limbs through the holes.

Overlap the open ends of the sacks about three inches to provide extra strength in the middle of the litter.

### **16-23. MAKE AN IMPROVISED BLANKET LITTER**

An improvised litter can be made using only a blanket or similar material. The blanket is laid on the ground. Two opposite edges of the blanket are then rolled toward the middle. When the casualty is placed on the blanket, the rolled edges of the blanket are used as grips. Four or more litter bearers should be used when transporting a casualty using the blanket litter.

**FIGURE 16-23. BLANKET LITTER**

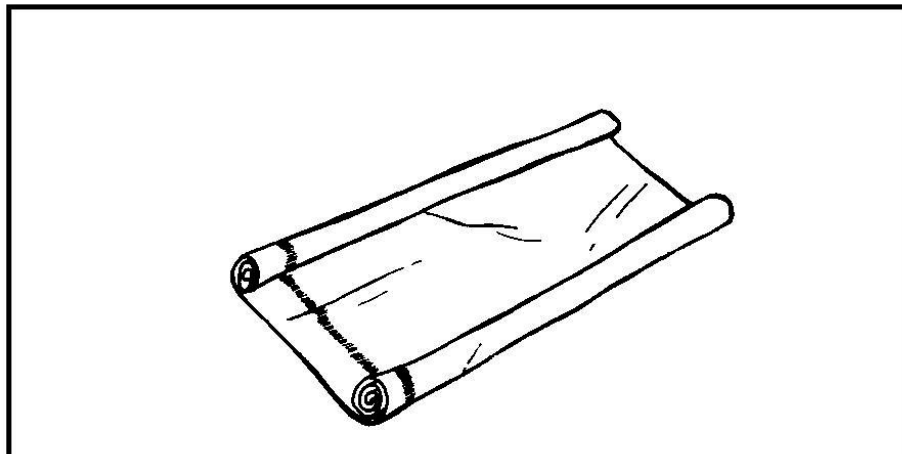

### **16-24. EVACUATE A CASUALTY BY LITTER**

Care must be used when placing the casualty on the litter in order to avoid causing additional injury to the casualty. A modified two-man arms carry or modified two-man fore-and-aft carry is usually used to place the casualty onto the litter. Normally, four soldiers are used to transport the litter. The litter team, however, can be composed of more or fewer members based upon the military situation and the distance and terrain to be covered.



## General Rules

Explain the Procedure to the Casualty. If the casualty is conscious, tell him what you are going to do. The explanation will help to calm his fears and will help you to get his cooperation.

Walk Around the Casualty. Walk around the casualty rather than stepping over him. If you step over the casualty, he may flinch or tighten his muscles and aggravate his injuries. In addition, mud or other debris may fall from your boots into his eyes or wounds.

Perform Necessary Measures Before Transporting. Make sure the casualty is breathing properly, open wounds have been dressed and bandaged, and fractures have been splinted before transporting the casualty.

Have One Person in Charge. One person must give the instructions to the remainder of the team so actions will be performed in unison.

## Position Litter

Position the casualty on his back with his arms at his sides. Place the litter (standard or improvised) near and parallel to the casualty.

FIGURE 16-24. LITTER PLACED PARALLEL TO CASUALTY

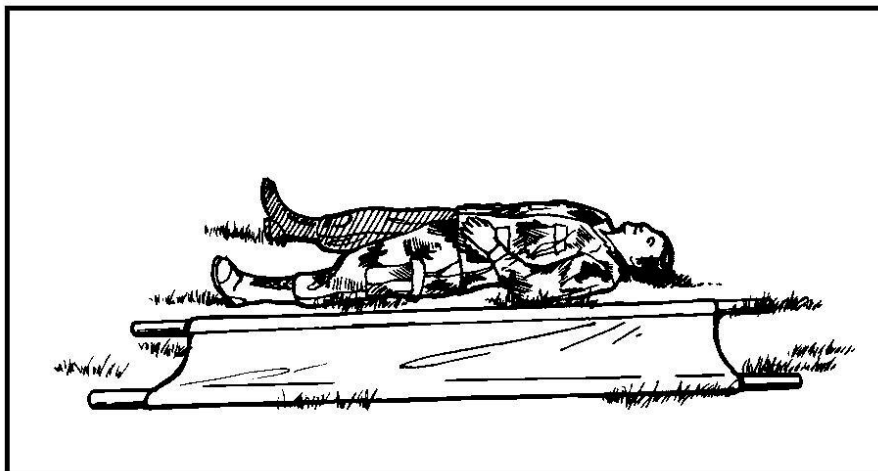

## Place Casualty On the Litter

Modified Two-Man Fore-and-Aft Carry (see paragraph 16-15).

Modified Two-Man Arms Carry (see paragraph 16-17).

## Lift Litter

If there are four litter bearers, each bearer positions himself at one of the handles, faces so that the casualty will be carried feet first, and kneels on one knee (the knee nearest the litter). The leader of the litter team should position himself at the handle nearest the casualty's right shoulder and direct the other bearers. This position allows the leader to monitor the casualty during the evacuation.

Upon command of the leader, the four litter bearers lift the litter in unison and move the casualty to the aid station or collection point.

**(NOTE:** Additional information concerning evacuation by litter can be found in Field Manual 8-10-6, Medical Evacuation In A Theater Of Operations Tactics, Techniques, And Procedures.)

**FIGURE 16-25. LIFTING A LITTER**

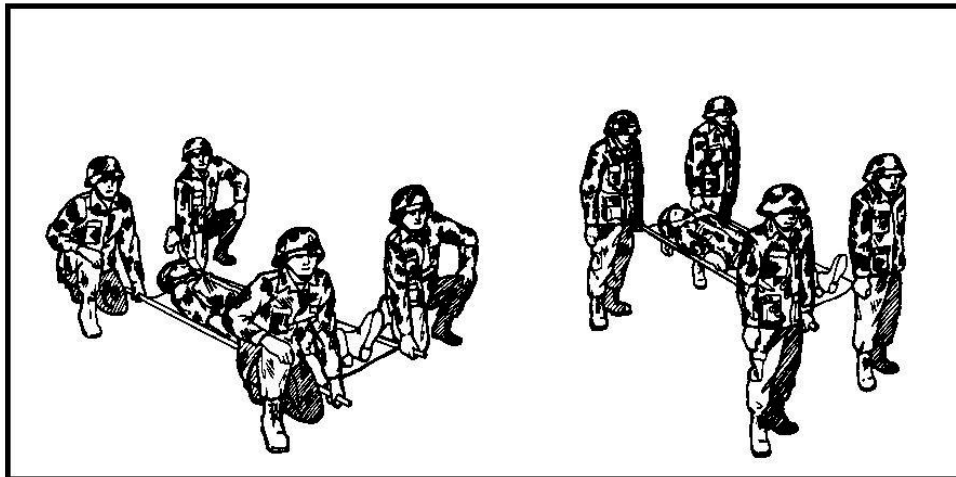

## PRACTICE EXERCISES: LESSON 16

### Transport A Casualty

**INSTRUCTIONS:** Follow the special instructions for exercise 2, exercises 11 through 18, and exercises 23 through 27. Answer the other exercises by circling the letter of the response that best answers the question or best completes the sentence. Refer to the lesson text, if needed. After you have answered all of the exercises, check your answers against the "Solutions to Exercises" in the Appendix. For each exercise answered incorrectly, reread the lesson material referenced.

1. Of the following, which is usually the preferred method of transporting an injured soldier?
  - a. Litter.
  - b. One-man carry.
  - c. Two-man carry.

**SPECIAL INSTRUCTIONS FOR ITEM 2.** Answer the three questions for each carry. If the answer is yes, write "Y" in the appropriate block. If the answer is no, write "N" in the block.

2.	Can carry be used with an unconscious casualty?	Can carry be used if the casualty has a fractured arm?	Is the carry normally used for more than a short distance?
Arms Carry			
Cradle Drop Drag			
Fireman's Carry			
Neck Drag			
Pack-Strap Carry			
Pistol-Belt Carry			
Pistol-Belt Drag			
Saddleback Carry			
Support Carry			

3. Which one of the following carries should not be used to transport an unconscious casualty?
- a. Arms carry.
  - b. Pack-strap carry.
  - c. Pistol-belt carry.
  - d. Saddleback carry.
4. You must move an unconscious soldier for a short distance. You need to keep both the soldier and yourself as close as possible to the ground in order to keep from being seen by the enemy. Which of the following carries/drag should you use?
- a. Fireman's carry.
  - b. Four-hand seat carry.
  - c. Neck drag.
  - d. Pistol-belt drag.
5. Of the following one-man carries, which one is usually preferred for moving an unconscious or disabled casualty for a moderate distance?
- a. Arms carry.
  - b. Fireman's carry.
  - c. Saddleback carry.
  - d. Support carry.

6. Which one of the following one-man carries requires that the casualty be able to walk or to hop on one leg?
- a. Fireman's carry.
  - b. Neck drag.
  - c. Saddleback carry.
  - d. Support carry.
7. You want to move a heatstroke casualty to a shady area a few feet away. Which one of the following carries/drag should you use?
- a. Cradle drop drag.
  - b. Neck drag.
  - c. Pistol-belt carry.
  - d. Saddleback carry.
8. You must carry a casualty for a long distance. Also, you want to have your hands free to climb a steep embankment. What carry should you use?
- a. Arms carry.
  - b. Pack-strap carry.
  - c. Pistol-belt carry.
  - d. Saddleback carry.

9. A casualty is lying on his back. He has a dressed wound on his left side. In order to turn him onto his abdomen, you should:

- a. Kneel at his left side, grab his far shoulder and hip, and pull so that the casualty rolls onto his front.
- b. Kneel at his right side, grab his far shoulder and hip, and pull so that the casualty rolls onto his front.
- c. Kneel at his right side, grab his near shoulder and hip, and push so that the casualty rolls onto his front.
- d. Kneel at his left side, grab his near shoulder and hip, and push so that the casualty rolls onto his front.

10. Before raising an unconscious casualty to a standing position, you should position the casualty on his:

- a. Abdomen.
- b. Back.

SPECIAL INSTRUCTIONS FOR EXERCISES 11 THROUGH 18. Identify the one-man carries listed below by writing the letter of the illustration below in the blank next to the proper name.

11. \_\_\_\_\_ Fireman's carry.

12. \_\_\_\_\_ Support carry.

13. \_\_\_\_\_ Arm carry.

14. \_\_\_\_\_ Pack-strap carry.

15. \_\_\_\_\_ Saddleback carry.

16. \_\_\_\_\_ Pistol-belt carry.

17. \_\_\_\_\_ Pistol-belt drag.

18. \_\_\_\_\_ Neck drag.

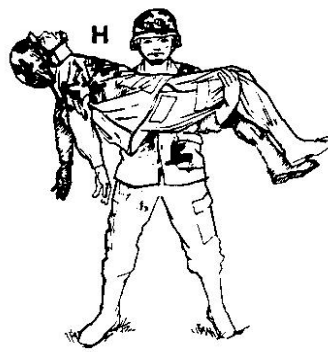
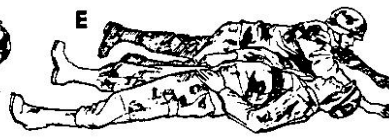

19. You are moving an injured soldier using the pack-strap carry. The casualty's hands should be positioned so that the:
- Palms are up.
  - Palms are down.
  - Palms are facing each other.
  - Backs of the hands are facing each other.
20. What one-man carry is used to move an unconscious casualty down a flight of stairs?
- Cradle drop drag.
  - Neck drag.
  - Pistol-belt drag.
  - Support carry.
21. You and another soldier are going to evacuate a casualty using a fore-and-aft carry. The other soldier is several inches taller than you. Will the height difference affect the carry?
- Yes, you should support the casualty's arms.
  - Yes, you should support the casualty's legs.
  - No.
22. You are going to move a casualty using the two-man support carry. The casualty is taller than you are and is unconscious. How will this probably affect the way you perform the carry?
- You will hold on to the wrist of the casualty's arm that is around your neck.
  - You will remove your arm from around the casualty's waist and use it to lift and support the casualty's thigh.
  - You will tie the casualty's hands together.
  - You will perform both response a and b.
  - You will perform both response b and c.



SPECIAL INSTRUCTIONS FOR EXERCISES 23 THROUGH 27. Identify the two-man carries shown below by writing the letter of the illustration in the blank next to its proper name.

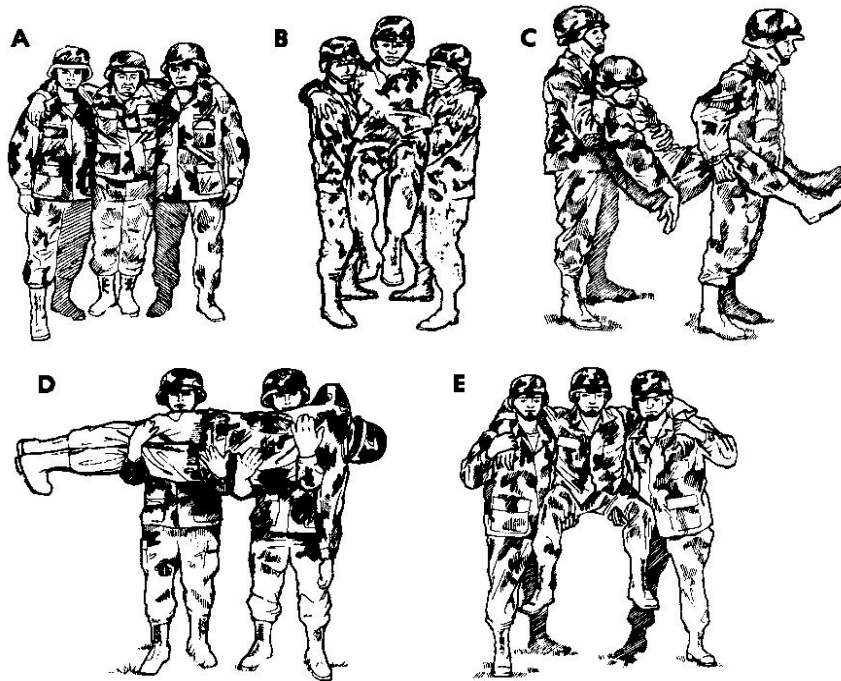

23. \_\_\_\_\_ Two-man fore-and-aft carry.
24. \_\_\_\_\_ Two-man support carry, regular.
25. \_\_\_\_\_ Two-man support carry, tall casualty.
26. \_\_\_\_\_ Two-man arm carry.
27. \_\_\_\_\_ Four-hand seat carry.

28. The two-hand seat carry is used:
  - a. Only with a conscious casualty.
  - b. Only with an unconscious casualty.
  - c. To move a casualty for long distance.
  - d. To move a casualty for a short distance.

29. Which of the following carries is used only with a conscious casualty?

- a. Four-hand seat carry.
- b. Two-man arms carry.
- c. Two-man fore-and-aft carry.
- d. Two-hand seat carry.
- e. Two-man support carry.

30. You are making an improvised litter using a poncho and two straight tree limbs. You are at the stage shown below (side view). What should you do next?

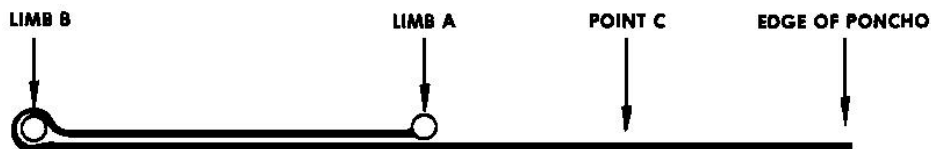

- a. Fold the poncho at Point C so that the edge of the poncho will rest next to Limb A.
  - b. Fold the poncho over Limb A so that the edge of the poncho is next to Limb B.
  - c. Bring Limb B over Limb A so that Limb B will rest at the edge of the poncho.
31. When preparing field jackets for a pole and jacket improvised litter, you should close the jackets and:
- a. Turn them inside out with the sleeves on the outside of the body of the jackets.
  - b. Tie the ends of the sleeves with a double knot.
  - c. Turn them inside out with one sleeve on the outside and one sleeve on the inside of the body of the jackets.
  - d. Turn them inside out with the sleeves inside the body of the jackets.

32. You are constructing a pole and sack improvised litter. You have cut the corners of the closed ends of the sacks. How should the sacks be positioned on the pole?
- a. Both open ends should be toward the casualty's head.
  - b. The closed ends of the sacks should be together.
  - c. The open ends of the sacks should be together.
  - d. Both closed ends should be toward the casualty's head.
33. A soldier says, "All improvised litters require two rigid objects such as tent poles or tree limbs." Is he correct?
- a. The above statement is true.
  - b. The above statement is false.
34. A casualty is being evacuated by litter. There are three litter bearers in addition to yourself. You are going to direct the other three bearers. Where should you position yourself?
- a. Near the casualty's right shoulder.
  - b. Near the casualty's left shoulder.
  - c. Near the casualty's right foot.
  - d. Near the casualty's left foot.

Check your answers

**APPENDIX  
ANSWERS TO PRACTICE EXERCISES**

**ANSWERS TO PRACTICE EXERCISES: LESSON 2**

**Practice Individual Preventive Medicine Countermeasures**

**PMMS for protection against cold injuries.**

1. d (para. 2-2)
2. a (para. 2-2)
3. b (para. 2-2)
4. c (para. 2-2)
5. a (para. 2-2)
6. e (para. 2-2)
7. c (para. 2-2)
8. b (para. 2-2)

**PMMs for protection against heat injuries**

9. a (para. 2-3)
10. d (para. 2-3)
11. d (para. 2-3)
12. c (para. 2-3)
13. b (para. 2-3)

**PMMs for protection against arthropod bites and arthropod-borne diseases.**

14. d (para. 2-4)
15. b (para. 2-4)
16. a (para. 2-4)
17. a (para. 2-4)
18. a (para. 2-4)
19. c (para. 2-4)
20. c (para. 2-4)
21. b (para. 2-4)

**ANSWERS TO PRACTICE EXERCISES: LESSON 2 (Continued)**

**PMMs for protection against water-borne and food-borne diseases.**

- 22. c (para.2-5)
- 23. b (para.2-5)
- 24. b (para.2-5)
- 25. c (para.2-5)
- 26. b (para.2-5)
- 27. d (para.2-5)
- 28. b (para.2-5)
- 29. c (para.2-5)

**PMMs for protection against hearing loss**

- 30. d (para. 2-6)

**PMMs for Prevention of skin infections**

- 31. d (para. 2-7)

**PMMs for care of the feet.**

- 32. c (para. 2-8)

**PMMs for oral hygiene.**

- 33. a (para. 2-9)

**PMMs for protection against respiratory diseases.**

- 34. b (para. 2-10)

**PMMs to follow for protection against sexually transmitted diseases.**

- 35. c (para. 2-11)
- 36. c (para. 2-11)
- 37. a (para. 2-11)
- 38. a (para. 2-11)
- 39. a (para. 2-11)
- 40. a (para. 2-11)

**ANSWERS TO PRACTICE EXERCISES: LESSON 2 (Continued)**

**PMMs for human waste disposal.**

41. b. (para. 2-12)

**PMMs for prevention of tobacco use injuries.**

42. a. (para. 13)

43. c. (para. 13)

**ANSWERS TO PRACTICE EXERCISES: LESSON 3**

**Evaluate a Casualty**

1. c (para. 3-1)
2. c (para. 3-4)
3. d (para. 3-6)
4. b (para. 3-3, 3-8, 3-9)
5. a (para. 3-12)
6. b (para. 3-13)
7. b (para. 3-14)

**ANSWERS TO PRACTICE EXERCISES: LESSON 4**

**Perform First Aid for Nerve Agent Injury**

1. c (para. 4-2)
2. b (para. 4-2)
3. c (para. 4-3, 4-4)
4. a (para. 4-4)
5. d (para. 4-6)
6. d (para. 4-6)
7. b (para. 4-7)
8. b (para. 4-7)
9. d (para. 4-7)
10. b (para. 4-7)

**ANSWERS TO PRACTICE EXERCISES: LESSON 4 (Continued)**

11. d (para. 4-9)
12. b (para. 4-9)
13. b (para. 4-10)
14. b (para. 4-11)
15. c (paras. 4-12, 4-13)
16. d (para. 4-11)
17. a (para. 4-12)
18. c (para. 4-13)
19. c (para. 4-13)
20. a (para. 4-13)
21. c (para. 4-13)
22. c (para. 4-13)
23. c (para. 4-13)
24. b (para. 4-14)

#### **ANSWERS TO PRACTICE EXERCISES: LESSON 5**

##### **Perform First Aid to Clear an Object Stuck in the Throat of a Conscious Casualty**

1. b (para. 5-2)
2. a (para. 5-3)
3. d (para. 5-4)
4. a (para. 5-4)
5. c (para. 5-5)
6. b (para. 5-6)

#### **ANSWERS TO PRACTICE EXERCISES: LESSON 6**

##### **Perform Mouth-to-Mouth Resuscitation**

1. c (paras. 6-1, 6-3)
2. b (para. 6-2)

#### **ANSWERS TO PRACTICE EXERCISES: LESSON 6 (Continued)**

3. c (para. 6-4)

- 4 b (para. 6-4)
- 5 b (para. 6-4)
- 6 d (para. 6-5)
- 7 c (para. 6-6)
8. a (para. 6-5)
9. d (para. 6-6)
10. d (para. 6-6)
11. b (para. 6-7)
12. c (para. 6-8)
- 13 b (para. 6-9)
- 14 a (para. 6-9)
- 15 c (para. 6-10)
16. c (para. 6-10)
17. b (para. 6-11)

**ANSWERS TO PRACTICE EXERCISES: LESSON 7**

**Perform First Aid for Bleeding of an Extremity**

1. b (para. 7-1)
2. d (para. 7-2)
3. a (para. 7-3)
4. c (para. 7-5)
5. a (para. 7-4)
6. b (para. 7-6)
7. d (para. 7-6)
8. b (para. 7-6)
9. d (para. 7-8)
10. d (para. 7-8 & fig. 7-6)

**ANSWERS TO PRACTICE EXERCISES: LESSON 7 (Continued)**

11. c (para. 7-9)
12. c (para. 7-9)



- 13. b (para. 7-9)
- 14. a (para. 7-9)
- 15. a (para. 7-10)
- 16. b (para. 7-11.)
- 17. a (para. 7-11)

**ANSWERS TO PRACTICAL EXERCISES: LESSON 8**

**Perform First Aid for an Open Chest Wound**

- 1. e (para. 8-2)
- 2. c (para. 8-3)
- 3. b (para. 8-3)
- 4. d (para. 8-3)
- 5. a (para. 8-3)
- 6. b (para. 8-4)
- 7. d (para. 8-5)

**ANSWERS TO PRACTICE EXERCISES: LESSON 9**

**Perform First Aid for an Open Abdominal Wound**

- 1. d (para. 9-2)
- 2. c (para. 9-3)
- 3. b (para. 9-3)
- 4. b (para. 9-3)
- 5. a (para. 9-3)
- 6. c (para. 9-3)
- 7. d (para. 9-4)

## **ANSWERS TO PRACTICE EXERCISES: LESSON 10**

### **Perform First Aid for an Open Head Wound**

1. e (para. 10-2)
2. c (para. 10-3)
3. b (para. 10-4)
4. a (para. 10-7)
5. e (para. 10-8)
6. a (para. 10-9)
7. b (para. 10-10)

## **ANSWERS TO PRACTICE EXERCISES: LESSON 11**

### **Perform First Aid to Prevent or Control Shock**

1. d (para. 11-1)
2. b (para. 11-2)
3. a (para. 11-3)
4. b (para. 11-3)
5. c (para. 11-4)

## **ANSWERS TO PRACTICE EXERCISES: LESSON 12**

### **Perform First Aid for a Suspected Fracture**

1. a (para. 12-2)
2. c (para. 12-3)
3. b (para. 12-4)
4. b (para. 12-6)
5. c (para. 12-6)
6. d (paras. 12-6, 12-7)
7. a (para. 12-7)
8. a (para. 12-7)
9. b (para. 12-8)

## **ANSWERS TO PRACTICE EXERCISES: LESSON 12 (Continued)**

- 10. a (para. 12-8)
- 11. d (para. 12-9)

**ANSWERS TO PRACTICE EXERCISES: LESSON 13**

**Perform First Aid for Burns**

- 1. c (para. 13-2)
- 2. a (para. 13-2)
- 3. a (para. 13-3)
- 4. d (para. 13-4)
- 5. b (para. 13-5)
- 6. b (para. 13-5)
- 7. c (para. 13-6)
- 8. d (para. 13-7)

**ANSWERS TO PRACTICE EXERCISES: LESSON 14**

**Perform First Aid for Heat Injuries**

- 1. a (para. 14-2)
- 2. b (para. 14-3)
- 3. c (para. 14-4)
- 4. a (para. 14-5, 14-6, 14-7)
- 5. b (para. 14-5, 14-6, 14-7)
- 6. c (para. 14-7)
- 7. e (para. 14-7)

## ANSWERS TO PRACTICE EXERCISES: LESSON 15

### Perform First Aid for Cold Injuries

1. b (para. 15-3)
2. a (para. 15-3)
3. c (para. 15-8)
4. b (para. 15-8)

## ANSWERS TO PRACTICE EXERCISES: LESSON 16

### Transport a Casualty

1. a (para. 16-2)
2. (para. 16-3)

	Can carry be used with an unconscious casualty?	Can carry be used if the casualty has a fractured arm?	Is the carry normally used for more than a short distance?
Arms Carry	Y	Y	N
Cradle Drop Drag	Y	Y	N
Fireman's Carry	Y	Y*	Y
Neck Drag	Y	N	N
Pack-Strap Carry	Y	N	Y
Pistol-Belt Carry	Y	Y	Y
Pistol-Belt Drag	Y	Y	N
Saddleback Carry	N	Y*	Y
Support Carry	N	Y*	Y

\*Not used if both arms are fractured.

**ANSWERS TO PRACTICE EXERCISES: LESSON 16 (Continued)**

3. d (para. 16-3)
4. d (para. 16-3)
5. b (para. 16-3)
6. d (para. 16-3)
7. a (para. 16-3)
8. c (para. 16-3)
9. b (para. 16-4)
10. a (para. 16-5)
11. c (para. 16-6)
12. a (para. 16-7)
13. h (para. 16-8)
14. f (para. 16-8)
15. b para. 16-9)
16. g para. 16-10)
17. e para. 16-11)
18. d para. 16-12)
19. b para. 16-13)
20. a (para. 16-13 and 16-14)
21. b (para. 16-15)
22. d (para. 16-16)
23. c (para. 16-15)
24. a (para. 16-16)
25. e (para. 16-16)
26. d (para. 16-17)
27. b (para. 16-19)
28. d (para. 16-18)
29. a (para. 16-19)

**ANSWERS TO PRACTICE EXERCISES: LESSON 16 (Continued)**

- 30. b (para. 16-20)
- 31. d (para. 16-21)
- 32. c (para. 16-22)
- 33. b (para. 16-23)
- 34. a (para. 16-24)

THIS PAGE INTENTIONALLY LEFT BLANK