



Saskatchewan  
Education

Northern  
Division

# Saskatchewan Trapper Training Manual



August 1990



This document contains  
recycled paper.

---

## **Saskatchewan Trapper Training Manual**

Saskatchewan Education  
Northern Division  
Revised August 1990

---

---

## **Acknowledgements**

We would like to give special thanks to Don Bird, William Eninew, and Saskatchewan Parks and Renewable Resources for their assistance in the revision of this manual.

The information in this manual was collected from wildlife textbooks and trapper's manuals that have been used in Saskatchewan and in various areas in Canada. We wish to thank all contributors for the material provided.

---

# Table of Contents

	Page
History of the Fur Trade .....	1
Winter Travel .....	2
Dressing for Cold Weather .....	2
Hypothermia .....	2
Travel and Ice Conditions .....	3
New Ice .....	3
Spring Ice .....	3
Falling In .....	3
Firearm Safety .....	4
Humane Trapping .....	5
Rules for the Good Trapper .....	7
Humane Trapping Do and Don't Chart .....	8
Killing Snares .....	21
Kill-type Traps .....	22
Proper Strike Location .....	23
Choosing the Right Size of Conibear Trap .....	24
Setting the Trigger .....	25
Safety Tool for Setting Conibear Traps .....	27
Capture Device Selection Chart .....	28
Live-caught Animals .....	34
Ways of Releasing Animals .....	35
Animal Diseases .....	36
Rabies .....	36
Tularaemia .....	36
Mange .....	36
Lures .....	37
Purpose .....	37
Animal Glands .....	37
Preparing and Using Lures .....	38
Lure Use Chart .....	41
Treating Traps and Snares .....	42
Traps .....	42
Precautions .....	42
Cleaning .....	42
Boiling .....	42
Dyeing .....	42
Waxing .....	43

Handling and Storage .....	43
Snares .....	43
Boiling .....	43
Handling and Storage .....	43
<b>Making Snares .....</b>	<b>44</b>
Snare Construction .....	45
Details of Figure 8 Construction .....	46
Snare Making Chart .....	47
<b>Sets .....</b>	<b>48</b>
Blind Trail Set .....	48
Land Animal Set .....	49
Running Pole Set .....	50
Bait Set .....	51
Bait Used on Cubby Set .....	52
Cubby Set .....	53
Scent Post Set .....	54
Dirt Hole Set .....	55
Under Ice Set .....	56
<b>Animal Biographies .....</b>	<b>57</b>
Beaver .....	57
Lynx .....	58
Muskrat .....	59
Red Fox .....	60
Wolf .....	61
Marten .....	62
Coyote .....	63
Mink .....	64
Otter .....	65
<b>Marketing Options and Strategies .....</b>	<b>66</b>
Options .....	66
Terms Used to Describe Raw Fur .....	70
Fur Quality .....	72
Grading Furs .....	74
Fur Handling .....	76
Pelts .....	78
Skinning and Marketing Information .....	80
Proper Method for Preparing Raw Pelts for Market .....	81
Cased Fur Drying Boards .....	82
Patterns for Pelt Stretching .....	83
Use of Master Beaver Template .....	84
<b>Tax and the Trapper .....</b>	<b>85</b>
<b>Resources .....</b>	<b>86</b>

---

## History of Fur Trade

Fur trade was very important in the development of Canada and northern Saskatchewan. The fur trade caused many changes in northern Saskatchewan. Settlements were built up around trading posts, missionaries came with the traders to bring their religion, the economy changed. Traders established fur trade routes and trading posts were built along these routes. Indians began trading furs for exciting new goods such as guns, knives, blankets, beads, cloth, pots, axes, needles. Some trappers became **middlemen** meeting other trappers on their way to the trading posts and trading with them. Men from Scotland, England and France began trading and living in the north. Some traders brought alcohol when they came to trade. They also brought European diseases such as smallpox which brought death to many northerners.

At the beginning of the fur trade there were no controls on trade. An area could be trapped out very quickly. Trappers then moved farther out from settlements and into new areas. When traders sold their fur they paid a tax to the government of New France.

The early 1800's brought changes to the fur trade. The Hudson's Bay Company and the Northwest Company, who had fought each other for control of the fur trade, amalgamated in 1821. There was also a change in European fashion. The popular fur felt hats, made of beaver fur, were no longer fashionable. They were being replaced by silks from China. Fur coats were promoted and the fur trade was able to continue.

Today trappers are still important to the fashion industry and until recently the Hudson's Bay Company still played a major role in collecting furs from the trapper. Fur quality is still maintained through the grading of pelts. Conservation practices are in effect so areas won't get trapped out. Fur trade is regulated by registered trap lines, trapping zones, licensing of trappers and fur buyers, restriction of harvest seasons, and quotas on some species. These regulations are enforced. There are also trappers' associations which put forward and protect the interests of trappers and the trapping industry.

---

# Winter Travel

## Dressing for Cold Weather

- Always wear woollen clothing - slacks, toque, underwear, shirt. Wool is the only thing that will keep you warm when you are wet.
- Always wear a toque (wool is best). Your body can lose as much as 80% of its heat through an uncovered head. Baseball caps are not windproof and they do not cover your ears.
- Wear good leather boots with rubber bottoms and good felt liners.
- Windproof jacket and pants, such as a snowmobile suit, stop the cold wind from going through your clothes.
- Always carry a spare set of dry woollen or cotton clothing packed inside a double plastic bag inside your pack.
- **Always** carry a sharp knife.
- Always carry a waterproof container of matches in your pocket (not in your pack).
- Carry some energy giving snack food, such as chocolate, raisins or peanuts.

## Hypothermia

Hypothermia is a condition which occurs when a person's body begins to lose heat through exposure to cool air and water. A person with hypothermia will shiver, have slurred speech, poor muscle control, and feel sleepy. They may not be able to think clearly.

If you feel hypothermia coming:

- cover your head and neck
- get out of the wind
- build a fire
- put on dry clothes
- eat some energy-giving food
- drink hot liquids such as tea, coffee
- wrap up in blankets or a sleeping bag.

Do not drink alcohol. It will speed up hypothermia.

Do not eat snow unless it is heated.

If your body is in danger of freezing, it will go through the following stages:

- can't stop shivering
- can't speak clearly
- muscles won't work the way you want them to
- can't walk straight
- feel sleepy
- forget things
- thinking doesn't make sense
- want to lie down and go to sleep
- become unconscious and die.

## Travel & Ice Conditions

Each year trappers lose their lives going through thin ice on their snowmobiles. Check the ice when you travel in new areas. Know the places that have moving water (mouth of rivers and creeks).

### New Ice

- carry an axe to test the ice
- stay away from ice with moving water under it
- stay clear of places that you know were the last to freeze
- watch for thin ice around beaver lodges
- never trust new ice until you test it
- three inches of ice is safe for 1 person\*
- seven and one-half inches of ice is necessary for a snow machine\*

\* Ontario Safety League in Alberta Advanced Education, Forestry, Lands & Wildlife [1987] *Trapping and Conservation Manual 1987*, p.500.

### Spring Ice

- 24" of candle ice may support 1 person  
travel on candle ice is recommended in early morning after a clear night which will usually



---

# Firearm Safety

Be safe, not sorry! Safety rules must be followed at all times to make sure a firearm accident does not occur.

1. Treat every firearm as if it were loaded. Never take anyone else's word. Always check for yourself.
2. Control the muzzle of your firearm. Keep the barrel pointed in a safe direction. Never point a firearm at any person, including yourself. Insist that your hunting buddies do the same.
3. Be sure of your target and what is behind your target. Positively identify your target as legal game before you fire. Check to be sure that the area behind your target is clear of people, livestock, buildings, roads.
4. Never shoot a rifle at water or a hard flat surface. The bullet could ricochet.
5. Only point a firearm at things you want to shoot. Never use a gun scope as binoculars.
6. Never climb a tree or cross a fence with a loaded firearm.
7. Store firearms and ammunition separately. Always store firearms under lock and key out of children's reach. When a firearm is not being used it must be unloaded with the action open. Use a gun case to carry a firearm to and from the hunting area.
8. Be sure the barrel and action of your gun are clear of all obstructions. If you fall while carrying a firearm or accidentally set it down barrel first, open the action, unload the firearm then make sure the barrel is not plugged with mud, dirt, snow.
9. Unload the firearm when it's not in use. As soon as you are finished shooting unload your firearm. Always unload your firearm before you put it in your vehicle.
10. Avoid alcoholic beverages. Never use alcoholic beverages or other drugs before or during a hunt. Drugs can change your sense of judgement and lead to accidents.

# Humane Trapping

Why should I trap humanely?

What is humane trapping?

Where is the best spot for my sets?

How can I tell if an animal has died humanely?

What trap should I use?

How can I release an animal unharmed?

What are the rules for good trapping?

What are the best sets to use?



How can I avoid capturing unwanted animals?

How can I be sure my snares are humane?

How can I kill a trapped animal humanely?

---

## Humane Trapping

There are groups of people that concern themselves with the welfare of animals. Some of these groups of people would like to see trapping stopped.

Some of the extreme groups are:

- Green Peace
- Animal Liberation
- Animal Rights

The not so extreme groups that are not against trapping, but want trappers to trap in a humane way are:

- World Wildlife Fund
- S.P.C.A.

The groups that are on the side of the trapper are:

- Fur Institute of Canada
- Trappers Associations - S.T.A., O.T.A., M.T.A.
- Brown Peace
- Federal & Provincial Governments

If trappers are willing to use the humane trapping way, then groups like the World Wildlife Fund and S.P.C.A. will be on the side of the trapper.

At this time it is very important that trappers use humane trapping ways because there are many people that are not sure whose side they want to go on. So if the humane trapping way is used, then many people will see the trapper as a respectable person.

The trapper is the one who decides if trapping will keep on or if trapping will be stopped.

If you, the trapper, change to humane trapping, there are many people on your side, right now, to help you.

---

## Rules for the Good Trapper

Saskatchewan Trappers' Association (STA) recommends these rules. Every trapper should:

1. try to be as humane as possible in his trapping.
2. make sets which do not trap unwanted animals.
3. handle furs carefully - they'll bring a higher price.
4. use underwater sets wherever possible. Hold and drown shore sets should have locks and slide wires and be set in deep enough water.
5. use a short chain on foothold traps when attached to a solid anchor and set on land.
6. use anchor traps or snares that are strong enough to hold bigger animals that may be caught.
7. check leg hold traps everyday.
8. use proper releasing and killing methods.
9. after skinning an animal throw it in the bush for other animals to eat.
10. respect the rights and property of others.
11. report diseased animals to the resource officer.
12. co-operate with trapper organizations and resource officers.

## Humane Trapping - Do's & Don't Chart

General

Humane Practice	Reasons For	Inhumane Practice	Reason Against
Purchase and use of devices made of the finest materials, best design and construction.	This will help to ensure a humane capture as the device will function properly and consistently.	Don't use home made devices (except for properly made snares) or alter commercially manufactured devices in any manner, unless you are sure the alteration improves the humaneness of the device.	It is very difficult to manufacture devices which will have a consistent temper and quality of steel or to successfully test them. Some alterations may make a device inhumane.
Select the proper type of device to be used in an appropriate set for the target species.	A careful selection of these items is the first step towards ensuring a humane capture. <b>Note:</b> refer to the capture device selection chart and the sets illustrated in this manual.	Don't mismatch the device or the set to the target animal.	This will greatly reduce the probability of a humane capture.
Maintain capture devices in good working condition.	Properly maintained capture devices will function more efficiently and help to ensure a humane capture.	Don't use damaged or badly corroded devices.	Devices weakened by corrosion or damage may not kill or hold an animal properly, resulting in possible crippling, escape or slower death.
Make sets in the most likely and appropriate locations to capture the animal intended.	Using your knowledge of the animal's habitat, habits and food source prepare a set specifically for that animal.	Don't set capture devices at improper locations.	This may result in the capture of unwanted animals. Inflicting pain or death on these animals, when it can be prevented, is inhumane.

## Humane Trapping - Do's & Don't Chart

### General

Humane Practice	Reasons For	Inhumane Practice	Reason Against
Use the proper lure or bait for the target animal.	This helps to avoid attracting non-target species and reduces the number of unwanted captures.	Don't use improper lure (i.e. garbage, burnt meat, diseased carcasses).	This may attract non-target animals and/or cause the spreading of disease.
Use materials in the construction of the sets which avoid attracting non-target animals.	This helps to avoid the capture of non-target animals.	Don't use materials in the construction of the set which attract non-target animals.	The capture of unwanted animals results in unnecessary killing and is a waste of time and effort.
Use sets which control the animal's approach into the capture device, as much as possible.	This will help to ensure that the animal is guided into the capture device from the best direction and correct angle so as to result in a humane capture.	Don't make sets in which the animal's approach is obstructed in some way or which does not control it's approach into the capture device.	This will allow the animal to approach the capture device from the wrong direction and/or incorrect angle which may result in an inhumane capture.
Be sure all sets are flagged and their number and locations recorded on a map.	This ensures that the trapper knows how many sets he has made and that they can all be found. This is essential in order for sets to be checked and adjusted regularly. When sets are properly marked, they can be found by a partner if the trapper himself is unable to attend them for some reason.	Do not make sets without flagging them or recording their number and location on a map.	Unmarked sets may be difficult to find, especially after a snowfall; also a trapper may forget exactly how many were set out.  It is also very difficult for a second person to check them if the trapper himself cannot do it for some reason. Untended sets may result in inhumane captures. Unrecorded sets may be overlooked at the end of the season. This can result in serious over-harvest and waste.

## Humane Trapping - Do's & Don't Chart

### Foot Holding Traps - Land Sets

Humane Practice	Reasons For	Inhumane Practice	Reason Against
Use the proper size trap for the target species.	The animal will be caught behind the foot pads, reducing the chance of escape. There will be less likelihood of causing unnecessary injury.	Don't use over-sized or under-sized traps for the target species.	When the trap is too large for the animal, the strike location will be higher on the leg. The additional power of the trap increases the likelihood of damage to the trapped animal and its pain and suffering is increased. When the trap is too small, the animal may only be caught by the toe, increasing the chance of escape with a damaged foot.
Use standard steel jawed foothold traps in kill sets only.	New, improved foothold traps are available for use as holding devices.	Don't use foothold traps in sets which suspend the animal in the air.	This will result in the animal hanging by its trapped foot, causing unnecessary pain and suffering.

## Humane Trapping - Do's & Don't Chart

### Foot Holding Traps - Land Sets

Humane Practice	Reasons For	Inhumane Practice	Reason Against
Use standard steel jawed foothold traps as killing devices when making can type sets for weasels or squirrels.	This is a humane way of harvesting these species.	Don't allow more than 1/4" of space between the inside of the container and the top of the closed trap jaws, when making can type sets which use a foothold trap as a killing device.	When too much space is allowed the animal's body will not be kept between the trap jaws where it would be humanely killed. Instead, it may be only injured or held, increasing suffering.
Check holding sets daily (preferably early in the morning).	When these sets are checked frequently, it will allow less time for a trapped animal to suffer pain or stress. (Most animals are caught at night or early in the morning.)	Don't leave hold type trap sets unchecked for more than 24 hours.	When these sets are not checked frequently, it will allow more time for the animal to suffer pain and stress. The law states that any holding device set on land must be checked within 72 hours.
Use a trap chain no longer than 12" and equipped with a shock absorber when the trap is solidly staked.	This will help to prevent injury or damage to the trapped animal.	Don't use a long chain, or one without a shock absorber on a solidly staked chain.	This allows the trapped animal to lunge further with greater force, possibly causing broken bones, dislocations or escape with possible injury.
Use a trap with a center-mounted chain.	The animal's foot will stay in the centre of the trap jaws. This will help avoid unnecessary injury.	Don't use a trap with a side- or end-mounted chain.	When the chain is end-mounted, the pulling action of the animal will cause the trapped foot to slide along the jaws and be pinched in the corner. The likelihood of cutting and restriction of circulation are increased. When the chain is side-mounted, it will cause a bending or whipping action on the trapped foot when the animal pulls. This increases the probability of breaking its bones.



## Humane Trapping - Do's & Don't Chart

### Foot Holding Traps - Land Sets

Humane Practice	Reasons For	Inhumane Practice	Reason Against
Use a trap with a swivel at each end of the chain.	This allows the trap and foot to move freely together, preventing unnecessary injury.	Don't use a trap without swivels in the chain.	The chain may become twisted, kinked and rigid due to the animal's struggling. The foot may then rotate between the trap jaws, resulting in chafing and cutting.
Set foothold traps with jaws across the animal's expected line of approach.	This will cause the trap jaws to close across the front and back of the foot, behind the pads, where there is more natural padding. This will help to prevent injury or escape.	Don't set the jaws parallel to the animal's expected line of approach.	This increases the chance of the animal's foot being caught in the corner of the jaws and the trap jaws will strike the sides of the foot where less natural padding occurs, causing increased pain and suffering.
Adjust the trap pan tension to fit the weight of the target species.	This will help prevent the capture of smaller, non-target animals.	Don't set a trap that has the pan tension improperly adjusted for the target species.	This allows small, non-target animals to be captured when the trap pan tension is too light.
Tailor the trap pan size to the foot size of the target species.	A trap pan of the correct size will ensure that the animal's foot is well placed in the centre of the trap when it is triggered. This will help prevent injury.	Don't set a trap with a pan which has not been tailored to the foot size of the target species.	When the space between the trap jaws and the pan is too small, the animal's foot may contact the trap jaw and pan at the same time. This can result in a poor catch, escape or total miss. A poor catch may result in unnecessary injury.

## Humane Trapping - Do's & Don't Chart

### Foot Holding Traps - Land Sets

Humane Practice	Reasons For	Inhumane Practice	Reason Against
Use a trap with padded jaws, where it is necessary to set a foothold trap as a holding device on land. Limit its use to harvesting furbearers of the cat and dog families.	In many areas, there is no alternative capture device for these intelligent and long-legged species. The padded jaw cushions the blow to the foot, reduces the chance of cutting the skin, and reduces circulation loss.	Don't use foothold traps as holding devices on land, for animals other than the furbearers of the dog and cat families. Foothold traps with teeth or other unapproved attachments must not be used.	These devices cause unnecessary suffering to the animal. There are kill-type devices, suitable for all other furbearers, which ensure a humane capture.
Adequately secure the trap to a strong stake or to a drag of sufficient weight and strength to hold the largest potential catch.	This ensures that the trapper will be able to quickly locate and dispatch the captured animal.	Don't inadequately fasten the trap to a poor stake or drag.	When the trapper is unable to locate the trapped animal within a reasonable time, it will experience unnecessary pain and stress.
Allow sufficient space between traps, in sets where more than 1 trap is used.	This will avoid the unnecessary suffering caused by multiple trapping of the animal. One trap is sufficient to hold the animal.	Don't place traps too close together at sets, where more than 1 trap is used.	This can cause unnecessary pain if the animal is caught in more than 1 trap.

## Humane Trapping - Do's & Don't Chart

### Foot Holding Traps - Drowning Sets

Humane Practice	Reasons For	Inhumane Practice	Reason Against
Use an uninked slide wire or cable of sufficient size and strength and use a proper one-way lock on slide wire sets.	This will ensure that the trap is smoothly guided to the anchor. The animal will not be able to return to the surface and will drown quickly.	Don't use a slide wire set without a lock or with wire or cable which is weak, kinked, corroded, frayed, or otherwise damaged.	A weak cable may break and allow the animal to escape with the trap still attached. A kinked cable may prevent the trapped animal from diving. A cable with no lock will allow the animal to repeatedly surface or regain land. In any of these situations, the animal will not die humanely.
Use an adequate anchor immersed in a sufficient depth of water.	This will ensure that the animal will die quickly as it cannot regain the surface to breathe.	Don't use an anchor or insufficient weight or place it where the water is too shallow.	The trapped animal will be able to repeatedly surface and breathe, extending its time to death and thereby causing unnecessary suffering.
Use foothold drowning sets for beaver and muskrat only.	These species will dive when caught, resulting in drowning.	Don't use foothold drowning sets for mink or otter.	Mink don't often dive when captured. Both mink and otter can be caught more humanely in a kill-type trap.

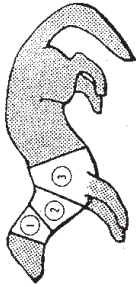

## Humane Trapping - Do's & Don't Chart

### Kill-Type Traps

Humane Practice	Reasons For	Inhumane Practice	Reason Against
Use the proper size of trap for the target species.	The animal is more likely to be hit in Strike Zone 1 for a humane kill.	Don't set a trap of improper size for the target species.	When the trap is too small, the killing bar may hit the animal in front of Strike Zone 1. It may escape in an injured condition or be held inhumanely. When too large a trap is used, the killing bar may over-reach Strike Zone 3. This will result in an inhumane capture.
Take into account the approach situation and the trap size, then adjust the trigger and dog to fit the target species.	This fine tuning of the capture device will help ensure a hit in Strike Zone 1, quickly killing the target animal.	Don't carelessly adjust the trigger and dog.	This may cause a hit outside Strike Zones 1 to 3, resulting in an inhumane capture.
Set the trap so that it is free to close while maintaining it's original function.	This will allow the full killing power of the trap to be applied, in a predictable strike zone, to cause a humane capture.	Don't allow anything to obstruct or interfere with the operation of the trap, or to change its original position.	This will reduce the killing power or alter the strike location and result in an inhumane capture.
Use kill-type traps in kill sets only.	Kill-type traps are designed to catch and kill the animal quickly and humanely.	Don't use kill-type traps in a footholding set.	The trap is not designed for this purpose. The large frame, combined with the powerful striking and clamping force, will result in a hit high on the leg, with an impact which may break the bone, causing unnecessary suffering.
Use only a scented lure on the trigger of traps set on land.	This will attract only target furbearers.	Don't attach meat baits on the trigger of traps set on land.	This may attract and capture birds or other non-target animals.

## Humane Trapping - Do's & Don't Chart

### Kill-Type Traps

Humane Practice	Reasons For	Inhumane Practice	Reason Against
Use underwater sets for beaver, muskrat and otter.	Kill-type traps, set properly underwater, ensure a humane death. If the set doesn't work properly and the animal is not killed immediately, it will still drown quickly.	Don't use land sets for beaver and otter.	These species can be effectively taken underwater which is more likely to result in a humane capture.
Use only kill-type trap sets for the following furbearers: fisher, marten, mink, raccoon, badger, wolverine, otter, skunk and weasel.	Kill-type traps make the animal unconscious and ensure a quick death. Kill-type traps and/or sets are effective for these species, because of their short legs and their habit of searching in holes for food.	Don't use footholding devices or snares for fisher, marten, mink, badger, wolverine, otter, skunk, weasel and raccoon.	There are more efficient and humane capture devices readily available for these species.
Disengage and position all safety catches so they will not interfere with the operation of the trap, after the set is completed.	The trap will operate as intended and result in a humane capture.	Don't leave any safety catches in place or improperly positioned after the set is completed.	When one safety catch is left in place and the trap is triggered, only the force of one spring will be employed and only half the killing power applied. If the safety catches are poorly positioned after being disengaged, they may interfere with the operation of the springs or killing bars, reducing the killing power and resulting in an inhumane capture.
Adequately secure the trap to an object which is strong enough to hold the largest potential catch.	This ensures that the trapper will be able to quickly locate the animal.	Don't inadequately attach the trap to an object which is strong enough to hold the largest potential catch.	When a larger animal than intended is trapped or the trap doesn't work properly, the animal may be able to escape with the trap attached.

## Humane Trapping - Do's & Don't Chart

### Killing Snares

Humane Practice	Reasons For	Inhumane Practice	Reason Against
Use snare cable or wire of the proper thickness for the target species.	This will help ensure a humane capture. The snare will be sufficiently strong and will close as quickly and tightly as possible.	Don't use snare cable or wire of incorrect thickness for the target species.	When the cable or wire is too thick, the tightening effect will be lessened. When the cable or wire is too thin, it may break, releasing a possibly injured animal.
Use snare wire or cable that is flexible.	This will ensure that the snare loop will close easily and tightly, resulting in a quick death.	Don't use snare cable or wire that is stiff.	When the snare cable or wire is stiff, it is more difficult for the animal to close the loop quickly and tightly; this may result in a slower death.
Use only new good quality snare wire, cable Figure 8 and ferrules.	The quality new items are reliable and will help to ensure an efficient capture.	Don't reuse cable, wire, ferrules, Figure 8's or damaged locks.	It is difficult to tell how many times items have been used. These used metal parts become kinked, fatigued, corroded. The snare may not close quickly and tightly and it may break, allowing the animal to escape with the snare attached.
Use a well-designed snare lock matched to the cable size.	A reliable snare lock will close quickly and maintain constant tightening pressure, resulting in a quick death.	Don't use snares without a lock or with an inferior lock.	When there is no locking device or if the lock is a poor one, the snare may not close tightly or may not maintain a steady tightening pressure, resulting in escape or an inhumane death.

## Humane Trapping - Do's & Don't Chart

### Killing Snares

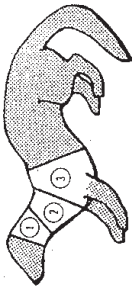

Humane Practice	Reasons For	Inhumane Practice	Reason Against
Use a good quality, well-designed ferrule, matched to the cable size and crimp them well (squirrel snares excepted).	This will help to ensure a humane capture as the snare will not come apart under stress. Note: The best quality ferrules are made of a magnesium alloy which is soft enough to crush down, yet hard enough to hold tight.	Do not use snares without proper ferrules, or crimp them inadequately (squirrel snares excepted).	The snare may come apart under stress, resulting in the escape of the animal, possibly injured, or with the snare attached.
Use the correct material and construction when making a Figure 8.	The snare is more easily adjusted and will close more readily, resulting in a catch close behind the ears (Zone 1). The strength of the Figure 8 will be adequate to hold the target furbearer.	Don't use a snare for any furbearer in the dog and cat families without a Figure 8, or one made of incorrect material and/or construction.	The snare may not close as quickly or tightly as it should, or it may break. This may result in a prolonged death or escape with possible injury.
Correctly assemble all the necessary components of a killing snare in the proper order.	This will produce a consistent, finished product which is required to ensure the humane death of a captured animal.	When making a snare don't mismatch or omit any snare components.	An improperly constructed snare can be a very inhumane device.
Secure the snare to a solid anchor of sufficient strength to hold the largest potential catch.	The animal's own momentum and pull against a solid anchor causes the snare to close tightly.	Don't attach snares to drags or to a flexible or inadequate anchor.	When the anchor is not solid, the tightening power of the snare is reduced and will result in a less humane capture.

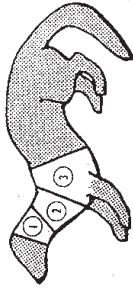

## Humane Trapping - Do's & Don't Chart

### Killing Snares

Humane Practice	Reasons For	Inhumane Practice	Reason Against
Be sure the bottom of the snare loop is the proper height off the surface for the target species.	This will help to ensure that the snare closes around the neck, close behind the ears (Zone 1), resulting in a humane death.	Don't set the snare too low.	When it is too low, the animal may step through the loop, causing it to close behind the front legs and around the chest or the waist. The result of this will be an inhumane capture.
Place snare sets on narrow trails in thicker brush where large game animals do not normally travel.	This will help to avoid capturing game animals.	Don't set snares on game trails.	The likelihood of capturing game animals such as deer and moose is too great and it is not necessary or desirable to take this risk in the harvesting of furbearers.
Place the running pole at the proper angle when making squirrel snare sets.	The squirrel will die quickly as it will not be able to climb back on the pole.	Don't place the running pole at too steep an angle, when making squirrel snare sets.	The snared squirrel may be able to climb back on the pole, prolonging the time to death.
Use stainless steel wire for squirrel snares (use Williams 16 pound test steel fishing line).	Stainless steel is stronger and more flexible than brass, with the added benefit of a smaller diameter and therefore, a better constricting effect.	Don't use brass or other wire for squirrel snares.	In addition to being weaker, brass wire does not slide across itself as smoothly as stainless steel and this causes resistance to the loop closing tightly. It is also thicker, with a less constricting effect. Burnt strands of snare cable may be unevenly tempered and brittle spots may break, allowing the squirrel to escape with the snare attached.



## Humane Trapping - Do's & Don't Chart

### Killing Snares

Humane Practice	Reasons For	Inhumane Practice	Reason Against
Set snares more than 24" above the ground when making squirrel snare sets.	This will ensure that the squirrel will be freely suspended and will die quickly.	Don't place any snare less than 24" above the ground when making squirrel snare sets.	This may allow the squirrel to touch the ground and support itself, prolonging the time to death.
Use a simple knot for making the eye for the loop on a squirrel snare.	This will allow the whole loop of the snare to close tightly to ensure a humane death.	Don't twist the wire around itself when making the eye for the loop on a squirrel snare.	This will cause a stiff section on the loop which will prevent the snare from closing tightly, resulting in an inhumane capture.
Place the eye of the snare along the top half of the loop, when setting squirrel snares.	The snared squirrel is most likely to come to rest with the eye of the snare behind its head. This position renders the most humane death.	Don't place the eye of the snare along the bottom half of the loop when setting squirrel snares.	The snared squirrel may be suspended with the eye of the snare under its chin where it can grasp the wire with its front feet and therefore prolong its death.
Check and adjust snare sets frequently ( especially after a heavy snowfall or freezing rain).	This will ensure that the snare is still properly set and is in operating condition. If an animal has been captured and the snare has not worked properly, the trapper will be able to deal with the situation without unnecessary delay.	Do not leave snare sets unchecked for a long period of time (especially after a heavy snow fall or rain).	When there is a heavy snow fall, the snare may be disturbed or the approach height changed. When there is rain, the snare may freeze up. A passing animal may also disturb the set. If the set is disturbed in any way, it may not work properly and result in an inhumane capture.

## Killing Snares

- Use snare cable or wire of the right size (thickness) for the size of animal you want to catch.
- Set snares more than 24" above the ground when making squirrel sets.
- Use stainless steel cable for snares.
- Use only **new** good snare wire, cable Figure 8 and crimps.
- If you make up your own snares with locks, make sure the snare lock is the right size for the wire thickness.
- If you make your own snares, make sure that you use the right sized fasteners (crimps) for the wire size and that you squeeze them good and tight.
- Attach the snare to a solid anchor that will hold the largest animal that could be caught.
- Be sure the bottom of the snare loop is the right height off the ground for the animals you want to catch.
- Place snare sets on narrow trails in thicker brush where large game animals do not normally travel.
- Check and adjust snare sets every day ( especially after a heavy snowfall or freezing rain).
- Use stainless steel wire for squirrel snares (use Williams 16 pound test steel fishing line).
- Place the eye of the snare along the top half of the loop, when setting squirrel snares.
- Place the running pole at the proper angle when making squirrel snare sets.

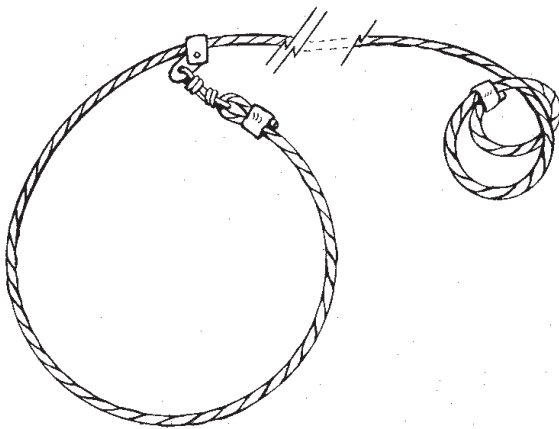

LAND SET

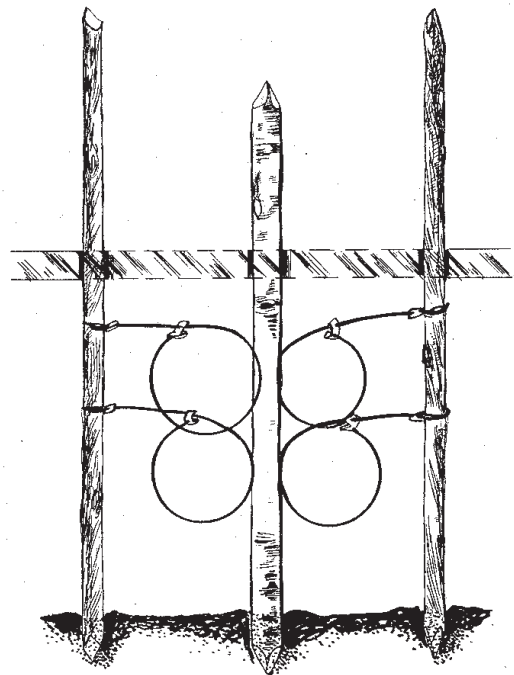

UNDERWATER SET

## Kill-Type Traps

Adjust the trigger and dog to fit the animal you want to catch.

Use the proper size of trap for the animal you want to catch.

Use only kill-type trap sets for the following fur bearers: fisher, marten, mink, raccoon, badger, wolverine, otter, skunk, and weasels.

Use conibear traps in kill sets only.

After the trap is set, remove all safety catches so the trap will close freely.

Use only a scented lure on the trigger of traps set on land.

Set the trap so that it will close without hitting anything.

Use underwater sets for beaver, muskrat, and otter.

Attach the trap to something that will hold the largest animal that might be caught.

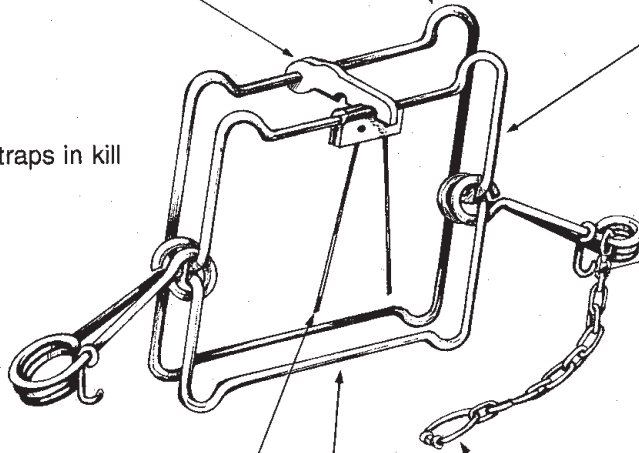

## Proper Strike Location

For killing traps to be humane and effective, it is important that the jaws strike the animal from top and bottom in a vital location and with maximum striking and clamping force.

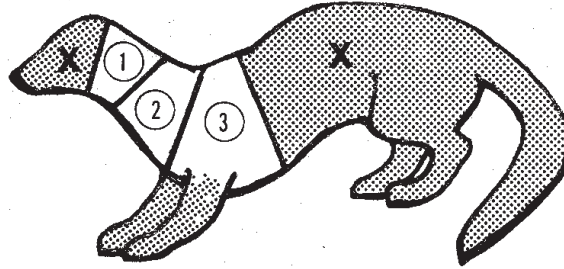

- Strike Zone 1** animal becomes unconscious almost instantly and death is quick.
- Strike Zone 2** rapid death but animal is less likely to be unconscious immediately.
- Strike Zone 3** rapid death but animal is less likely to be immediately unconscious and chance that the animal may not stay unconscious.
- Strike Zone X** a slow death and inhumane capture.

The most humane strike area is the area just behind the ears to the upper rib cage. Every humane trapper should try and strike in zone 1. This way the full force of the strike kills the animal quickly.

If a trap is set carelessly the animal may get too far into the trap resulting in a poor strike location or a double strike. In a double strike the killing bar cannot hit with as much force. The bar striking the abdomen, a thicker part of the animal, will keep the second set of killing bars from clamping down with a full force. Therefore, it will not be as effective as a single strike.

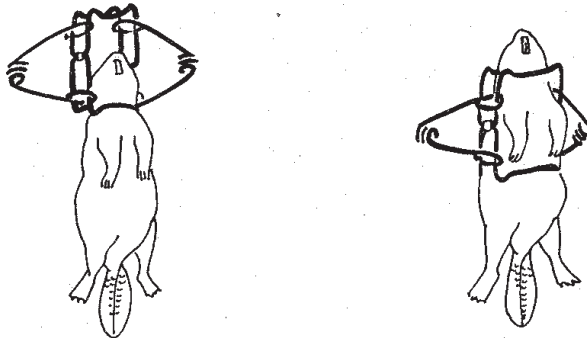

Right

Wrong

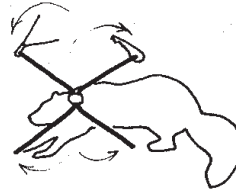
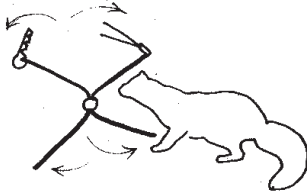
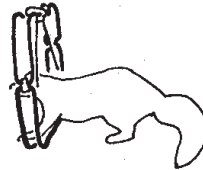
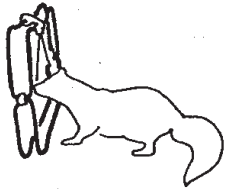
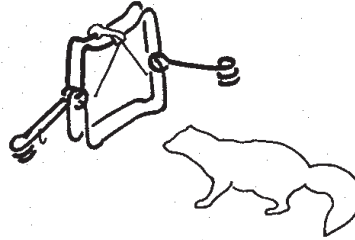
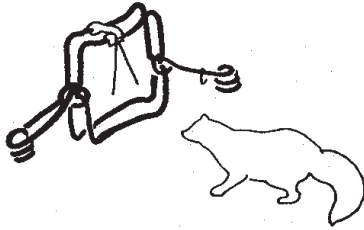

### Choosing the Right Size Conibear Trap

<u>No. 110</u>	<u>No. 120</u>	<u>No. 220</u>	<u>No. 330</u>
muskrat	muskrat	muskrat	marten
weasel	mink	fisher	otter
squirrel	marten	otter	beaver
	skunk	beaver	lynx
		lynx	wolverine

---

## Setting the Trigger

The trigger form and shape is also very important in obtaining an effective and humane strike. There are a variety of triggers available which can be purchased for repair or replacement purposes. Triggers may be adjusted to improve their effectiveness. Longer trigger prongs will cause the trigger to trip more easily.

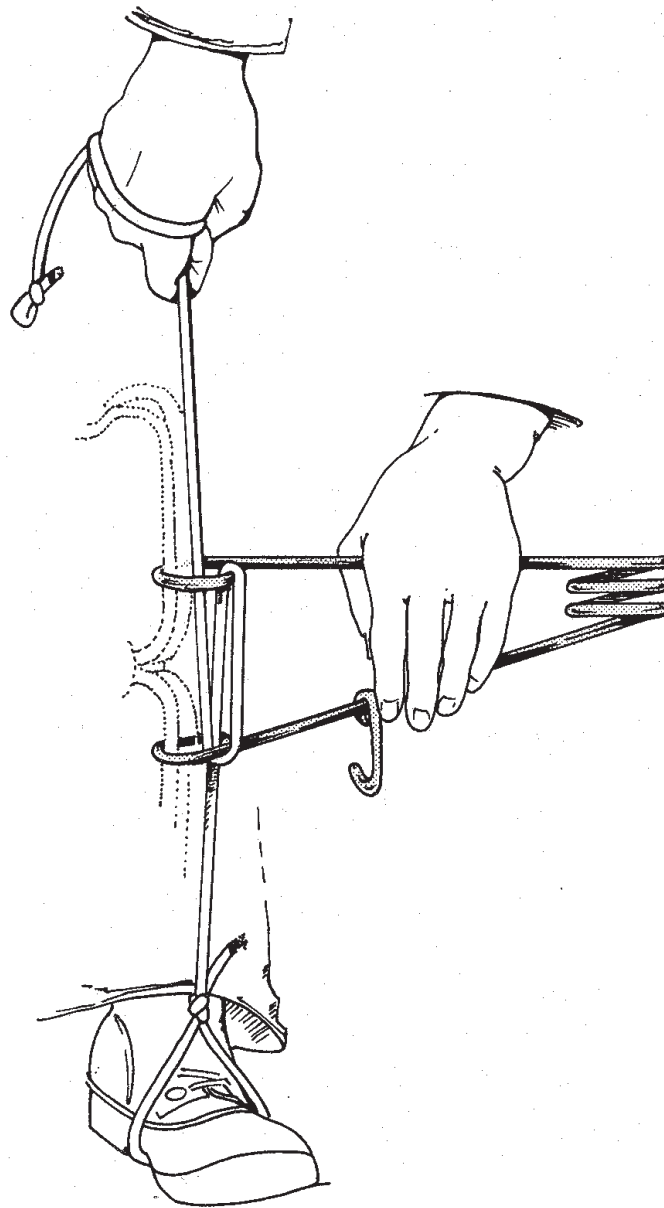

Setting the trigger:

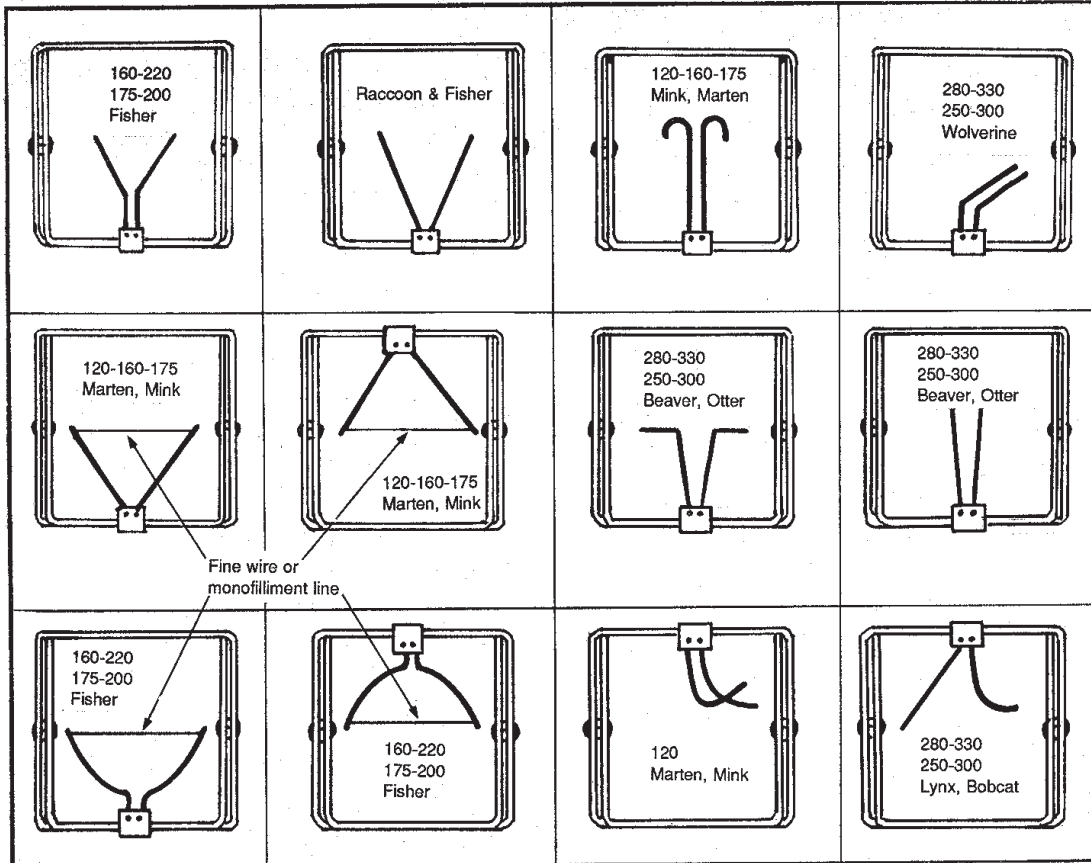

Remember:

- The sooner the approaching animal touches the trigger, the farther forward the jaws will close on the animal.
- The later the animal touches the trigger when entering the trap, the farther back the jaws close on the animal.

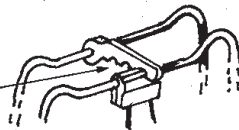

Ways to set the trigger:

- The **dog** has three notches - setting the trap to the outermost notch will cause the jaws to close more quickly and farther forward on the animal.
- A baited trigger will catch an animal that has stopped to eat the bait. The unbaited trigger will catch a moving animal.
- There are many ways you can bend and set the trigger to make sure the trap jaws will strike behind the head.

## Safety Tool for Setting Conibear Traps



For #330 Conibear



For #220 Conibear



For #110 Conibear

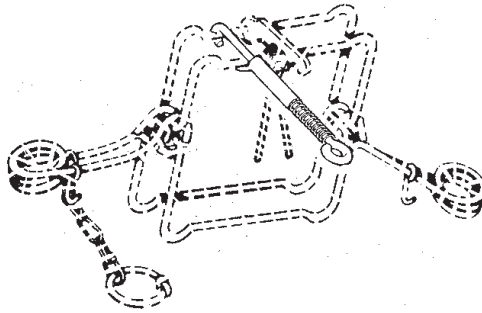

Safety devices and safety catches should always be used when setting traps.

### Rules to Remember:

1. Trap should always be the right size for the animal that you want to catch so that the jaws of the trap will close just behind the head.
2. Jaws of trap should close from top to bottom **not** from side to side.



3. Do not set the trap right against anything, like a tree or a log, because when an animal springs the trap, the trap will push away from the tree and close on the animal's lower back.





## Capture Device Selection Chart

SPECIES	RECOMMENDED				ALTERNATIVE			
	Type	Size	Make	Number	Type	Size	Make	Number
Fisher	Kill-type (double spring)	6" - 7" jaw spread	Victor Conibear	#160, #220				
			Northwoods	#175, #200				
* Fox	Kill snare (with Nor-loc or Alberta lock)	10" loop	X	1/16" airplane type cable				
			Victor	#1 1/2	Foothold (offset jaw - coil spring)	5 3/8" - 5 3/4" jaw spread	Victor	#175, #2
	Foothold (padded jaw) coil spring	4 7/8" jaw spread			Foothold (offset jaw - long spring)	4 3/4" jaw spread	Northwoods	#2
							Victor	#1 1/2
							Northwoods	#1 1/2

\* The potential for footsnares and power snares for fox is recognized by FPCHT, 1981.

# Capture Device Selection Chart



SPECIES	RECOMMENDED				ALTERNATIVE			
	Type	Size	Make	Number	Type	Size	Make	Number
Muskrat	Kill- type (under water)	6" - 7" jaw opening	Victor Conibear	#160, #220	Kill- type under water fixed position	4 ½" jaw opening	Victor Conibear	#110
			Northwoods	#150, #175, #200			Northwoods	#100
	Kill- type (double spring) (on land or on float)	4 ½" - 6 ½" jaw opening	Victor Conibear	#120, #160	Foothold (long spring) drown set only	4" - 4 ¾" jaw spread	Victor	#1, #1 ½
			Northwoods	#120, #175			Northwoods	#1, #1 ½
Otter	Kill- type (double spring) under water	7" - 8" jaw opening	X	X	Foothold (coil spring) drown set only	4 ¾" - 5" jaw spread	Victor	#1 ½
							Submarine (underwater set only)	4" cone opening
				#220, #280	Kill- type (double spring) under water	10" jaw opening	Victor Conibear	#330
		Northwoods	#200, #250	Northwoods			#300	



### Capture Device Selection Chart

SPECIES	RECOMMENDED				ALTERNATIVE			
	Type	Size	Make	Number	Type	Size	Make	Number
Coyote *	Killing snare (with Nor-loc or Alberta lock)	14" loop	X	3/32 airplane cable				
	Foothold coil spring (padded jaw)	5 3/8" jaw spread	Victor	#3	Foothold (coil spring offset jaw)	5 1/2" - 6 1/2" jaw spread	Victor	#2, #3
					Foothold (long spring - offset jaw)	5 1/2" - 6" jaw spread	Victor	#3
							Northwoods	#2, #3
							Northwoods	#2 1/2

\* Potential for footsnares and power snares for coyote is recognized by the Federal Provincial Committee for Humane Trapping (FPCHT), 1981

# Capture Device - Selection Chart



SPECIES	RECOMMENDED			Number
	Type	Size	Make	
Beaver	Kill-type (double spring)	8" - 10" jaw opening	Victor Conibear	#280, #330
			Northwoods	#250, #300
	Kill snare (drowning set)	8" - 10" loop	Montgomery Body Gripping	#280, #330
			steel cable	7 gauge
Mink	Foothold (drowning set)	5 1/2" - 7 1/4" jaw spread	Victor long spring	#3
			Montgomery coil spring	3SJ, 4SJ (SJ = square jaw)
	Kill-type (double spring)	4 1/2"	Northwoods	#1 3/4, #2, #3
			Victor Conibear	#120
Foothold (drowning set)	4 3/4" - 6"	Northwoods	#120, #175	
		Montgomery body gripping	#120	
		Victor long spring	1 1/2	
		Victor coil spring	1 1/2	
Foothold (drowning set)		Victor Stoploss	1, 1 1/2	
		Montgomery coil spring	1 1/2 round jaw	
		Northwoods	#3	

## Capture Device - Selection Chart



SPECIES	RECOMMENDED			
	Type	Size	Make	Number
Marten	Kill-type (double spring)	4½" - 6½"	Victor Conibear	#120, #126, #160
			Northwoods	#120, #175
			Montgomery body gripping	#120
Weasel	Foothold (double long spring) kill set only	5 7/8" - 6" jaw spread	Victor	#4
			Northwoods	#3
			Victor Conibear	#110
Wolf	Kill-type (single spring)	4½"	Montgomery body gripping	#110
			Victor long spring (kill type set)	1½
			Newhouse	#4½
	Kill snare with lock	20" or more	Galvanized	3/32 aircraft cable

## Capture Device - Selection Chart



SPECIES	RECOMMENDED			
	Type	Size	Make	Number
Bear	Foot snare (with foot snare spring)	12" - 14" loop	Galvanized	3/16" aircraft type cable
Lynx	Kill type (double spring)	8" - 10" jaw opening	Victor Conibear	#280, #330
			Northwoods	#250, #300
			Montgomery body gripping	#280, #330
	Kill snare	8" - 10" loop	steel cable	7 gauge

---

## Live-caught Animals

Live-caught animals which the trapper wants to keep should be killed in a quick and humane way.

### Shooting

The animal should be shot in the head with a .22 gun. The shot should be placed in the centre of an imaginary "X" between the eyes and ears, as shown below:

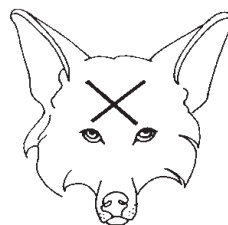

### Hitting

You must give a quick hard hit crosswise at the back of the head (behind the ears). Use a solid green stick 1" - 1½" thick. If the animal is just about out of the trap, it is best to shoot it not hit it.



### Drowning

Live animals taken in cage type traps can be killed by putting the trap in water until the animal is drowned.

### Conibear

Another way of killing a live caught animal is to put a kill-type trap of the right size in front of the cage doorway. Then open the door and hide a little ways off to let the animal go into the trap.

### Making Sure

Make sure that the animal is dead by touching the eye or mouth with a stick or similar object and watch for movement. If there is no movement or breathing, the animal is probably dead.

### Release

There are times when a trapper should release live caught animals that are not injured:

- animal has unprime or out-of-season fur
- if the area is almost trapped out
- when you don't want the animal

---

## Ways of Releasing Animals

### Using a Forked Stick



- the stick should be long enough and strong enough to do the job
- the forked end should pin the animal's head to the ground away from the trap
- open the trap with your foot
- if the animal is caught in a snare, the snare lock should be released

### Using a Noose Pole

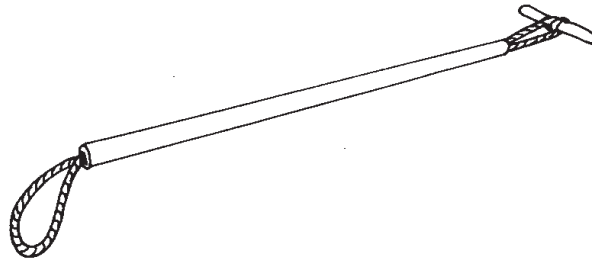

- use a green stick that is long enough and strong enough
- the loop should be put over the animal's neck or jaws and tightened by twisting the pole or pulling the rope tight without hurting the animal
- then the trap or snare is taken off the animal

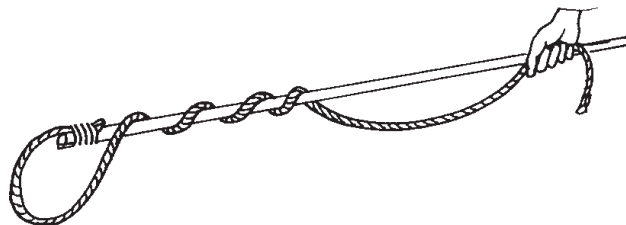



---

## **Animal Diseases**

Occasionally wildlife will have diseases, some of which can be passed on to humans. To prevent this certain precautions should be taken:

- avoid handling animals suspect of rabies
- tape and bandage all cuts and bruises
- wear rubber gloves while skinning animals
- wash thoroughly after handling animal carcasses
- keep knives and work area clean
- if any sickness lasts for a long time see a doctor and tell him you are a trapper and have been handling certain animals

### **Rabies**

In Saskatchewan rabies is found mostly in skunks. Many infected animals may become aggressive and lose their fear of humans. The disease is passed on through contact with saliva. Humans can get it from an animal bite or if a diseased animal's saliva comes in contact with wounds or scratches. It is not a good idea to handle animals that you suspect have rabies.

### **Tularaemia**

Tularaemia can be found in beaver, muskrat, squirrels and rabbits. Trappers and other humans that handle wild furbearers have a chance of getting the disease. Humans get tularaemia from handling diseased carcasses, eating improperly cooked meats or drinking contaminated water. Animals usually get it from water which has been contaminated with the carcasses of diseased animals. Diseased animals usually have small white spots in their liver, spleen, and lymph nodes. Spleen and lymph nodes may be swollen.

### **Mange**

Mange is a condition found in foxes, coyotes, and wolves. Tiny mites burrow and tunnel in the skin causing inflammation and itching. Fluid may weep onto the skin surface and there may be a thickening of the skin and hair loss. Animals scratch and chew infected areas. Animals are thin with little or no fat. Humans may get infected from handling infested animals or through contact with objects that infected animals may have rubbed.

---

## Lures

### Purpose

Lures are used to attract animals to a particular set. The animal will come to investigate what he smells. Lures are necessary to some sets and they make others more effective.

Lures include:

- scents
  - gland scents
  - curiosity scents
  - food scents
- baits
  - fresh bait
  - tainted bait
- urine
- visual



### Animal Glands

Webster's dictionary describes a gland as "an organ for secreting a substance or substances to be used in, or eliminated from the body". The most well known of the animal glands is the beaver castor. This gland is located in both male and female, under the pelt, between the hind legs. After skinning the beaver, with the animal on its back, you can feel these glands on both sides of the vent. Care should be taken so that castors are cleaned of fat and meat. If pulled slowly, while steadily cutting away the tissue, the castors will remain together and should be dried by hanging over a wire in a dry place. Twist them to prevent the liquid from running out. The oil sac is next to the castor, but much more fragile. Great care must be taken or a hole will be put in the sac.

Both these glands are used for lure making, with the castors being more valuable for both lure making and sale. The castors should be well dried and shipped in a well-packed cardboard box or burlap bags. Do not put in plastic bags or the castors will mildew and be worthless. The castors are well worth saving.

Muskrat glands are also important. Only the male muskrat has these glands, and they are valuable only in the spring when they are filled with liquid. These glands will normally be attached to the pelt, and are easily removed. Lay these glands on a wooden stretching board in an airy place, turning them over several times while they are drying. They are a pleasant, sweet smelling gland. These glands are a good lure for use the following spring by themselves, for muskrats, or mixed with other glands for various fur bearers.

The weasel family anal glands have a nasty odour, so be careful in removing these. It is best to cut too much out, rather than cut into the glands. Mink, marten, fisher, and otter anal glands are used in lure making, and mink musk can be used by itself.

---

Lynx, fox, and wolf glands are not as bad smelling, and it is best to leave some of the intestine attached to preserve the musk.

Bear gall is valuable in lure making, and is found attached to the bear's liver. It is a long, dark coloured gland. With a sharp knife, it is cut free of the liver and dried just like beaver castors.

Skunk glands are located, as on all members of the weasel family, on each side of the vent or rectum. Set the skunk straddling a wide mouth jar, with the glands over the mouth of the jar. Carefully slit the glands, one at a time. Use your knife blade to put a little pressure on the side of the gland. A hypodermic syringe can also be used to remove the liquid from the gland.

To save these glands, they should be put up in clean glass bottles and preserved with a light covering of pure canning salt. Only put one kind of gland into each jar and label the jar.

## Preparing and Using Lures

Lures can make a set more effective if they are used properly, but they will not make a poor set better. Too much scent can scare off animals rather than attract them. Scents usually are more effective than baits. They last longer, the odour carries farther, and they create more curiosity in the animal being attracted. There are many commercial lures available. Some of these are good but others are not. It is a good idea to test a lure or scent to see how effective it is. It is also good practice to vary the lure or scent used at every other trap location especially for foxes, wolves, and coyotes.

Beaver castor makes a good base for any scent mixture as it holds odour for a long time, but even by itself, it will attract most animals including other beaver. The mixture of the beaver castor and the beaver oil gland is a good lure for the marten and lynx. Beaver castors taken from pregnant spring time female beaver are weaker than that from other beaver. Beaver flesh is a good bait to use because of its fatty consistency which holds odour even in cold weather.

Meat can be tainted for use as bait by placing it in a glass jar or can and burying it in the ground for seven to ten days; cover it with about four inches of dirt. Borax powder added to the bait will prevent it from spoiling any further after it has been tainted to the desired amount.

Livers of the animal to be attracted, rotted for the summer months, are particularly good for lynx and fox. After the livers are rotted, you may add a variety of ingredients, such as beaver castor, muskrat glands, or to give it greater cold weather drawing power, add skunk musk.

Rot lynx livers in a jar all summer. Take a pint of this rotted liver and add six drops of aniseed, six drops of valerian, a small bit of powdered catnip, and six drops of lynx urine. Throw in about five tablespoons of powdered lynx droppings and one finely chopped beaver castor. Mix well.

To use this lure, put a bit of it on a ball of grass, tie it to a stick with a string that has been soaked in beaver oil and place it at the back of the cubby in an upright position. This will lure lynx into a pen set with either snare or trap.

---

Another very good lynx lure is a mixture of beaver castor, muskrat musk, and black poplar buds, picked just before they open in the spring.

A lure made with the sexual organs and urine from a female fox, wolf, or coyote during the mating season should be allowed to age for a year and should never be used at a set with bait.

Mink musk and honey also attracts some animals. To prepare this lure take the musk glands from several mink and press the musk into 1 pound of liquid honey or place the entire gland into 1 pound of warmed liquid honey. The warm honey will help to release the musk from the whole glands. Stir the honey to make sure the musk is well mixed in.

Fish oil is not only an important part of many lure formulas, but is also a very effective caller when used alone. Pure fish oil is especially attractive to raccoons, mink, skunks, and foxes. Making a good supply of fish oil is another summer preparation for fall and winter trapping.

Any fatty fish will make good fish oil. Cut fish into chunks and put them into a heavy glass gallon jar. Add enough water to cover the chunks. Lay a flat piece of glass over the top, with a rock to hold down the glass, allowing the gases to escape and at the same time preventing flies from entering the jar. Keep the jar in full sun at all times and away from cats and dogs. A good place for the fish oil jar is on the roof of a small building.

As the solids break down, oil will begin to appear on the surface. After several weeks of sun rendering, several inches of clear yellow-to-amber coloured oil will have risen to the top. Pour off or siphon the oil into a clear bottle. Put your gallon jar back in the sun. It is quite likely that several additional ounces can be had within a few weeks. See diagram p.40.

Try pure fish oil for taking the above named animals. Use about 20 drops at a set. Fish oil may also be used with other lures and baits.

An excellent fox lure is lard cracklings. This is the fatty tissue of pork or beef from which the lard has been rendered. After making the set, scatter a few cracklings around in such a manner that the fox must cross and recross the trap while getting the lure.

A very good coyote lure can be made as follows: five pounds (2.25 kg) rotted meat, 20 drops tonquin (Asiatic) musk, enough glycerine to make a paste. This is especially good in the winter months. By adding fish oil and coyote urine, you will have a lure good the year round. (Asiatic musk is now made synthetically and can be ordered from drug stores.)

Fish oil with beaver castor makes an attractive lure for fisher. Fisher are generally trapped in pens and a rabbit makes good bait. Another good fisher lure is: 1 pint fish oil, muskrat musk (two glands), 10 drops oil or aniseed, 10 drops asafetida.

A wolf, coyote, and fox lure can be made from four ground up beaver castors, four (springtime) muskrat glands, six drops of aniseed oil, around half a drop of skunk gland, a good handful of powdered wild catnip, mink glands (about two if small ones), a few blades of green grass, around four deer glands (from the legs) and about five pounds of meat (deer or similar).

The meat is ground up or chopped into chunks. Put this into a wooden or glass container big enough to hold four gallons. Break or grind the glands and mix them with the catnip and add to meat. If it doesn't mix well, add just enough clean fresh water to cover. This should then be put aside, covered with a screen, and left to work for the summer. Check it once in a while to see it doesn't get too dry. When it has settled into a well-mixed mass, it can be put into jars where it will keep for a long time. A bit of this lure will bring coyotes, foxes and wolves straight in, and will attract other animals as well.

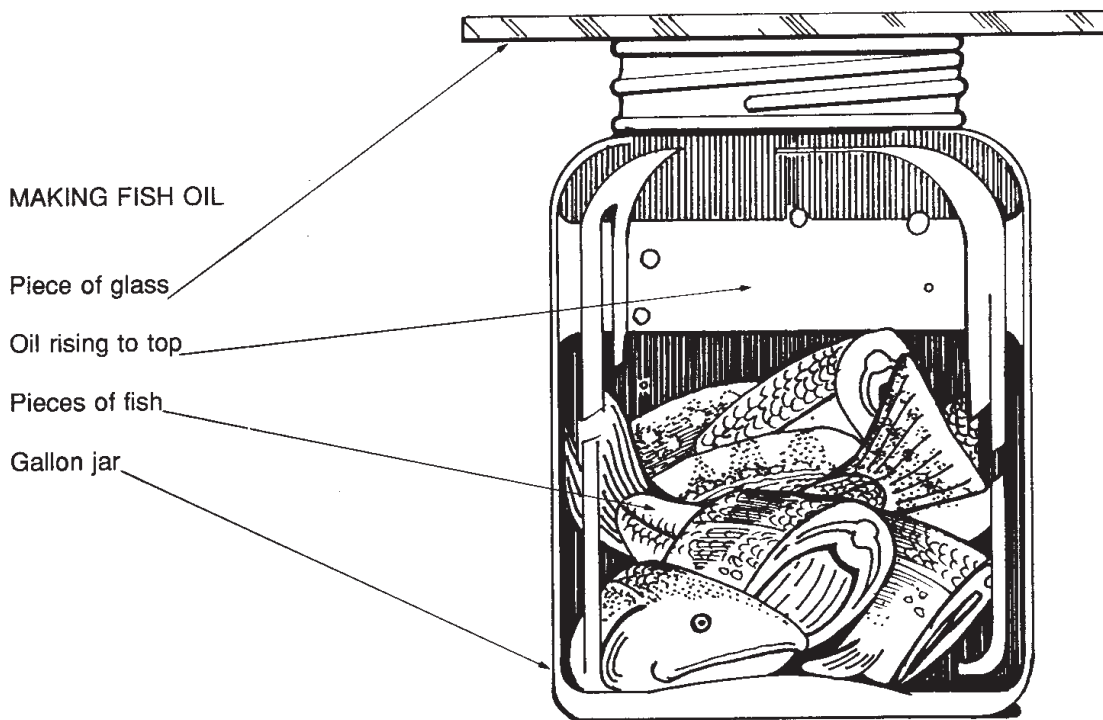

## Lure Use Chart

ANIMAL	BAITS	SCENTS	URINE	VISUAL
Beaver	green aspen, willow, birch	beaver castor, or beaver oil glands	--	partially peeled sticks behind trap
Muskrat	carrot, parsnip, apple or orange peel, cattail or lily pad root, sweet flag, bullrush or other marsh plants	musk glands from muskrat	--	<ul style="list-style-type: none"> <li>floating objects near frequented area</li> <li>sight of bait</li> <li>light from hole in the ice</li> </ul>
Mink	fresh fish, fresh muskrat or beaver flesh	fish oil scent, mink gland scent, beaver castor scent, muskrat musk scent	--	<ul style="list-style-type: none"> <li>dangling wing near box set</li> <li>the dark hole in the box usually attracts the animal</li> </ul>
Otter	fresh fish	fish oil scent, otter gland scent	--	<ul style="list-style-type: none"> <li>whole fish or artificial fish at trap</li> </ul>
Marten	squirrel, rabbit, beaver flesh, raspberry jam	marten glands, beaver castor	--	<ul style="list-style-type: none"> <li>dark hole in box attracts animals (usually to investigate)</li> </ul>
Fisher	beaver meat	fisher gland scent, beaver castor, anise, rat musk	--	<ul style="list-style-type: none"> <li>attracted to dark holes - box set</li> </ul>
Fox, wolf, coyote	beaver meat (tainted or fresh), entrails	fish oil, gland lures, skunk oil	urine from animal you are trapping	<ul style="list-style-type: none"> <li>attracted to almost any unusual but natural looking feature near a trail (e.g. part tuft of grass, dirt holes)</li> </ul>
Lynx, bobcat	fish, beaver meat, rabbit	anise, catnip scent, fish oil, beaver castor and other scent glands	--	<ul style="list-style-type: none"> <li>wing or other object which twirls in the wind</li> <li>grass ball</li> <li>dark enclosed area (e.g. cubby)</li> </ul>
Weasel	rabbit, squirrel, beaver meat	gland scent from weasel	--	<ul style="list-style-type: none"> <li>dark hole in box set</li> </ul>
Badger	woodchuck or other rodent meat, beaver meat, tainted or fresh	gland scent from badger	--	<ul style="list-style-type: none"> <li>dirt holes</li> </ul>
Raccoon	beaver meat, fish, sweet corn	fish oil	--	<ul style="list-style-type: none"> <li>dark hole in box set</li> <li>wing, feather or other object which flutters in the wind</li> </ul>

---

# Treating Traps and Snares

## Traps

Treating traps is a good idea because:

- it protects the traps from rust
- it deodorizes the trap making it more difficult for animals to discover
- adds natural odour so animals won't become suspicious

## Precautions

- wear gloves to protect hands from hot wax and water
- to deodorize gloves put in a trap treating solution for a few minutes
- wear eye protection
- body grip type traps should be cleaned and dyed
- if the traps are waxed, the wax must be removed from the notches in the trigger, dog and jaw where the dog catches when the trap is set

## Cleaning

- use wire brush, sandpaper and steel wool to remove all rust, dirt, and blood from the trap

Cleaning will stop corrosion and expose the trap surface so it will be ready to take on the dye

## Boiling

- place the trap chain ring between the jaws of the trap and put in water containing 1 tablespoon household lye per two gallons of water or 1 tablespoon wood ash per gallon water
- boil until traps are clean (15 - 30 minutes)
- put traps in pail of plain boiling water to rinse off the lye

Boiling removes the last traces of oil and other materials from the trap and starts to remove odours.

## Dyeing

- into a container put 4 oz. logwood crystals or powder per gallon water
- tree bark can be boiled with the traps rather than using logwood crystals

Dye protects traps from corrosion and darkens the trap color. It also masks any scent on the traps.

---

## **Waxing**

- use a good grade of commercial trap wax
- melt wax in a separate container
- you may add a small piece of spruce (size of a pea) to the wax
- when wax is very hot (smoking) use a stiff wire hook to remove traps from boiling dye
- allow moisture to evaporate from hot trap then dip in hot wax or apply wax with a brush (moisture on a trap placed in hot wax may cause an explosion)

Waxing provides a thin coating to protect trap from rust. It also makes traps close faster. Spruce gum toughens the wax. Wax prevents traps from picking up unwanted odours.

## **Handling & Storage**

- do not handle traps with bare hands or anything which may leave an odour on them
- hang traps in a dry place where there are no odours

Undesirable odours may keep animals away from the traps.

## **Snares**

- reduces light reflection so snare will not be so easy to see
- removes unwanted odours which may keep animal away from the snare
- leaves natural odour on snare so animal will not be suspicious

## **Boiling**

- put material natural to area such as bark, moss, plant leaves or spruce needles into water with the snares
- boil 15-20 minutes until solution has the colour of tea
- if oil scum is present add water until the scum overflows the container

Boiling will remove foreign odours and replace them with natural odours. Oil scum on the surface of the boiling water will contaminate the snares when they are removed.

## **Handling & Storage**

- remove snares from water and dry thoroughly
- handle snares with a strong wire hook or descented gloves
- hang in a dry place free of undesirable odours



---

## **Making Snares**

For a snare to work well it must be constructed from good quality material and be put together carefully. The basic snare is made up of a cable, lock, figure 8 and ferrule. Make sure each part of the snare is the correct size and strength.

All the snares you will need for the season should be made and treated ahead of time. If you are making a lot of snares, a ferrule crimper and a good pair of cable cutters would be a good buy. The lock is the only part of the snare which should be reused. Lay the length of snare wire on a flat surface and make sure it lays flat before you make the snare. This will keep the wire (cable) from twisting.

## Snare Construction

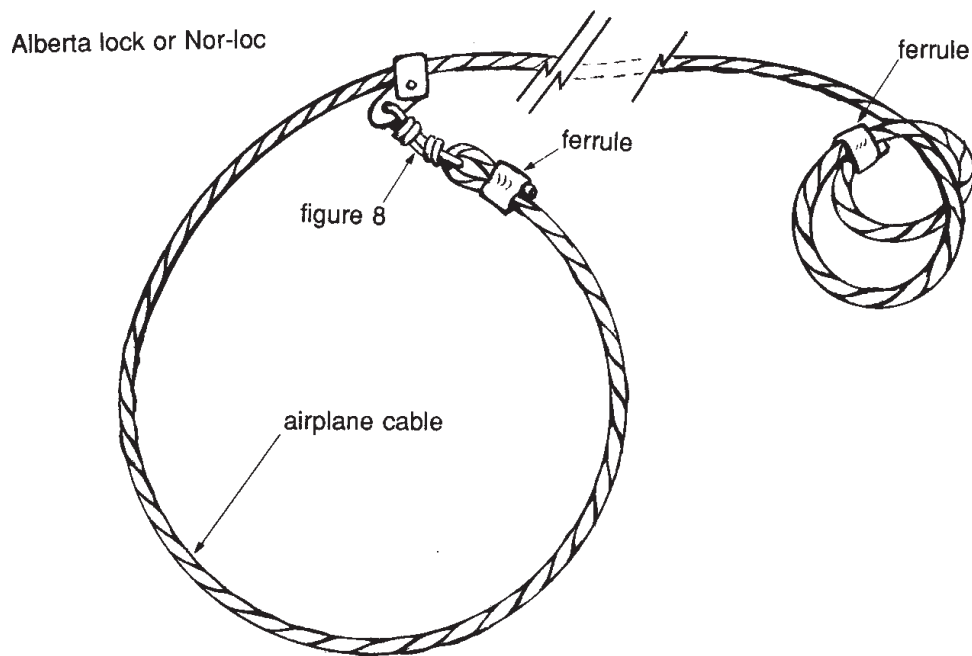

## Details of Figure 8 Construction

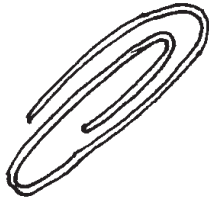

Correct wire cut to length

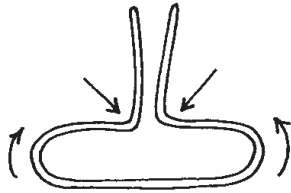

Starting to bend the wire

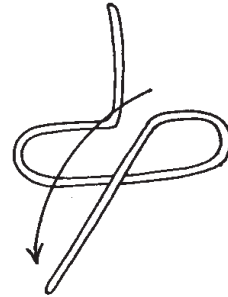

One end of Figure 8 bent down to make one end

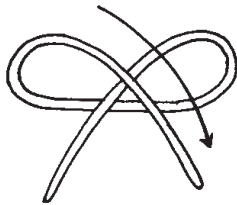

Both ends of wire bent down to start forming the Figure 8

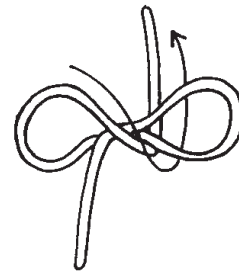

Forming centre of Figure 8 prior to winding the ends of wire around Figure 8

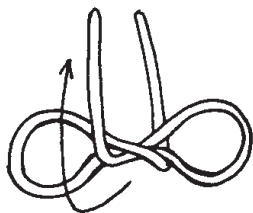

Winding the wire around the Figure 8 to make the final form

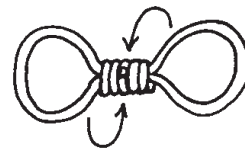

Finished Figure 8

# Snare Making Chart



Animal	Cable Material	Cable Length	Lock	Figure 8 Size	Ferrule Size	Loop Size	Bottom of Snare Loop to Ground in Inches
Wolf	3/32" airplane cable	100 inches 10-12" for toggle	med. or large Nor-loc or Alberta lock	14 gauge galvanized wire - Figure 8 2½" - 3" long	3/32" aluminum	20" or more	14" - 16" from ground
Coyote	3/32" airplane cable	67 inches	med. Nor-loc or Alberta lock	16 gauge galvanized wire - Figure 8 2½" long	2/32" aluminum	14 inches	12" from ground
Fox	1/16" airplane cable	44 inches	small Nor-loc or Alberta lock	18 gauge galvanized wire - Figure 8 2" long	1/16" aluminum	10 inches	8" from ground
Lynx	1/16" airplane cable	44 inches	small Nor-loc or Alberta lock	18 gauge galvanized wire	1/16" aluminum	8" - 10"	12" from ground
Squirrel	16 lb. test Williams Monel steel wire	18 inches	nil	---	---	1 ¾" no larger	¾" - 1" from pole
Beaver	7 gauge steel cable	36" plus double 18 ga. tail wire	Adams beaver lock	18 gauge galvanized wire - Figure 8 2" long	1/16" aluminum (if used)	8" - 10"	3" from ground in bottom of run under water

# Sets

## Blind Trail Set

### Coyote and Wolf

Completed set shows the trap imbedded in the hard pack of the trail. The grapple hook and drag are bedded by shoving them into the loose snow beside the trail. (Leave no sign of disturbance at the set)

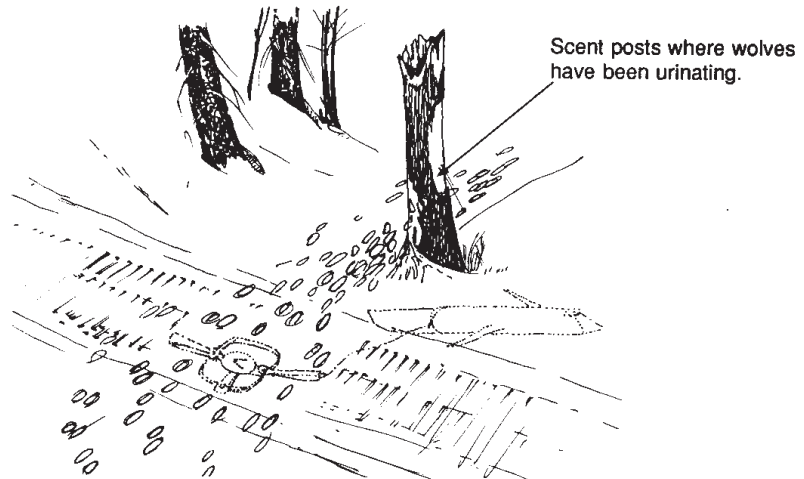

Tissue paper over trap pan.

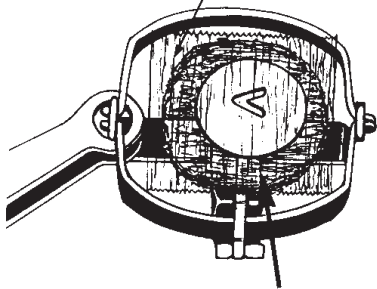

Polyester fibre padding under trap pan (will not take on moisture).



Old meat cleaver or axe to cut hole in hard snow, wrapped in milk carton which can be used to scoop loose snow onto the set.

Snowmobile trail, showing wolf tracks in the lowest part of the trail (they usually travel in lowest part of trail).

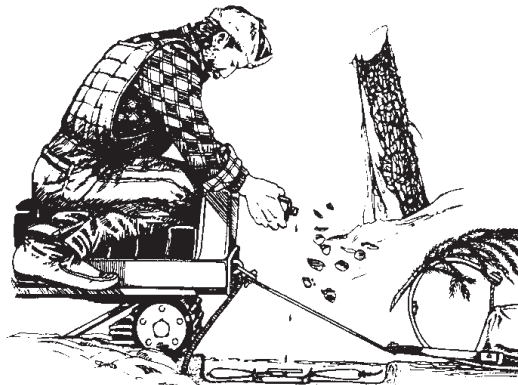

Detail of trap being bedded in the trail. Set made from the back of the snowmobile, covered with loose snow brought from a distance from the set so as to not disturb the site. The snowmobile is driven over the set after it is made.

---

## Land Animal Set

### Wolf Snare Set

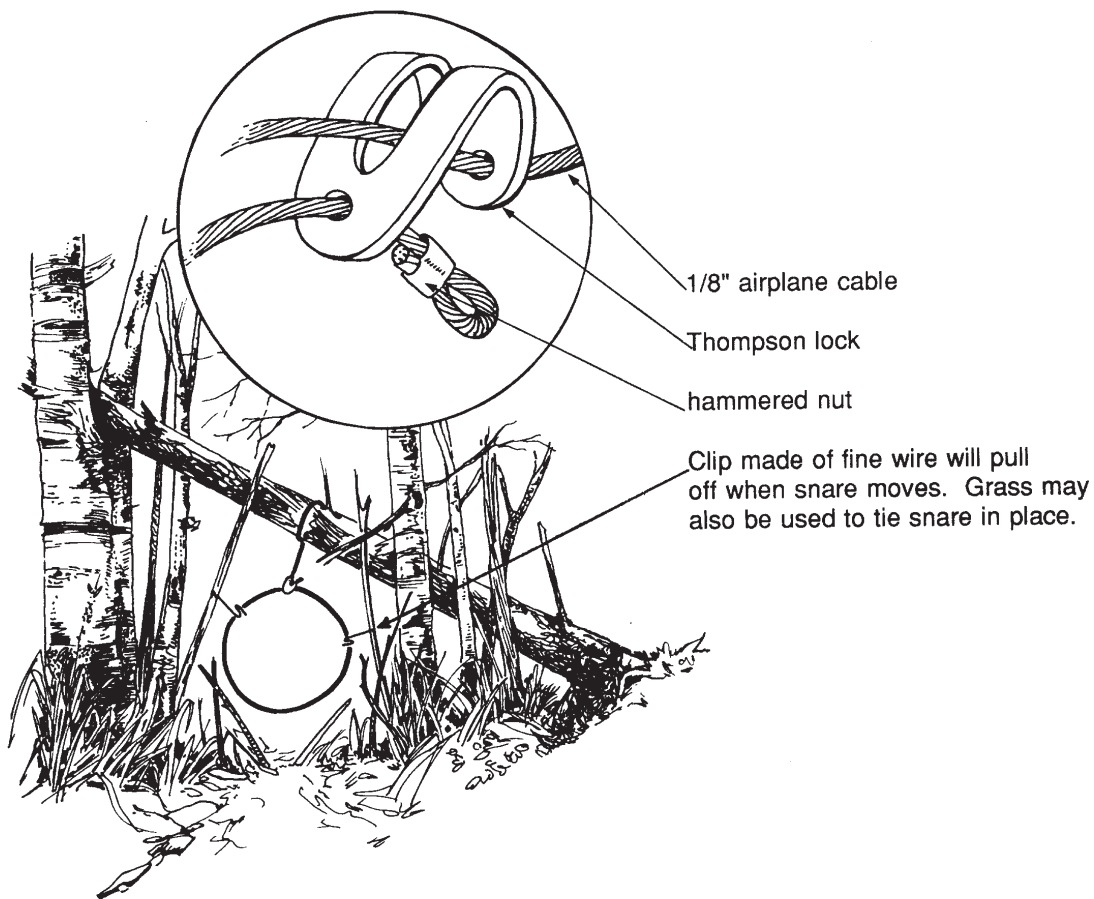

Wolves are not bothered by grasses holding the snare in place. Snare loop is 12" from ground.

Remember, the purpose of a snare is to catch an animal around the neck. Flank and foot catches are not the sign of good snaring practices. Watch your loop size - 12" in diameter is about right.

Also remember that wolf snares have to be boiled to remove all oil.

## Running Pole Set

### Marten, Fisher

Use 6" or 7" body grip trap for fisher

Use 4½" - 6" trap for marten.

Note: Fine wire between trigger wires on the trap, to assist in more sure catch just behind the skull for a quick kill.

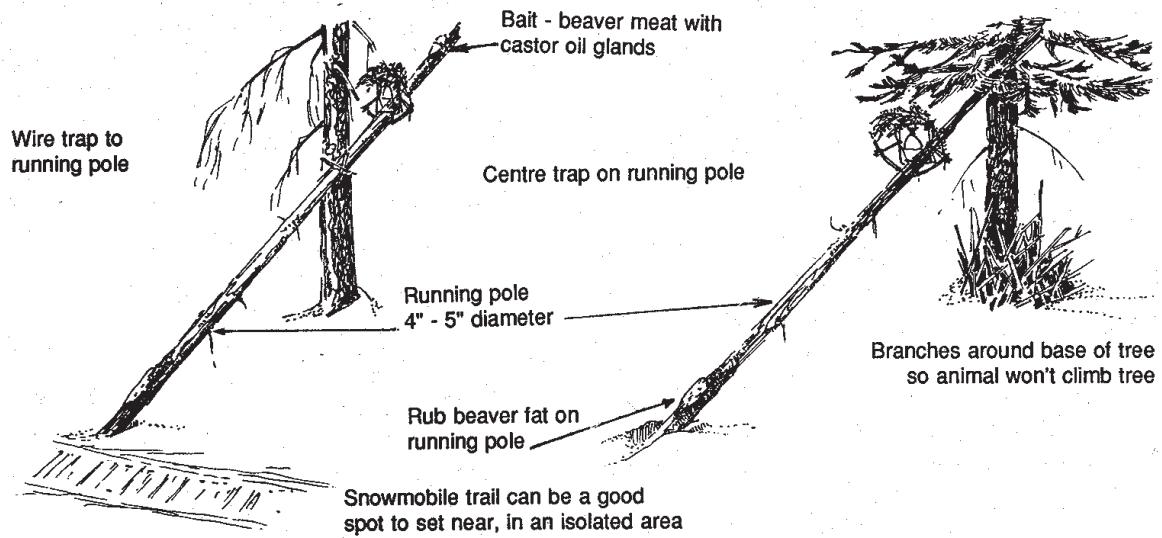
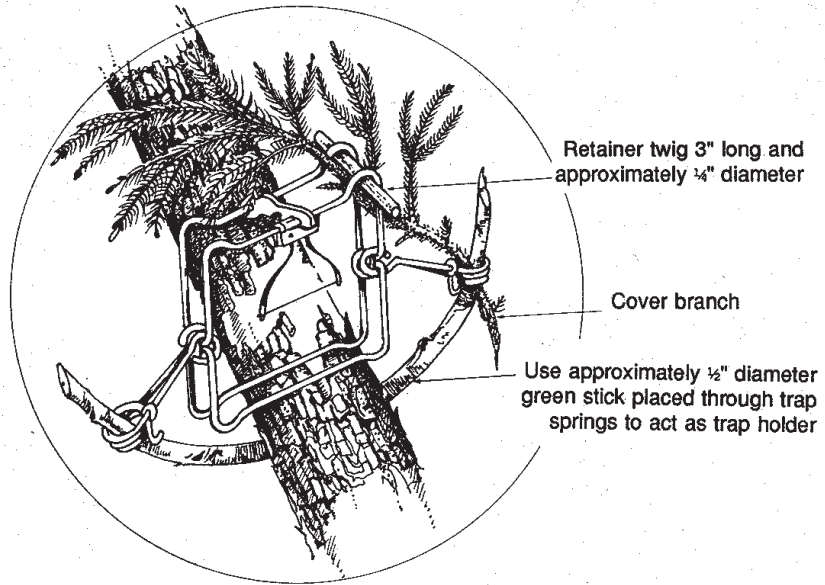

## Bait Sets

### Muskrat, Beaver and Otter

Use trap with 8" - 10" jaw opening for beaver.  
Use trap with 7" - 10" jaw opening for otter.  
Use trap with 6" - 7" jaw opening for muskrat.

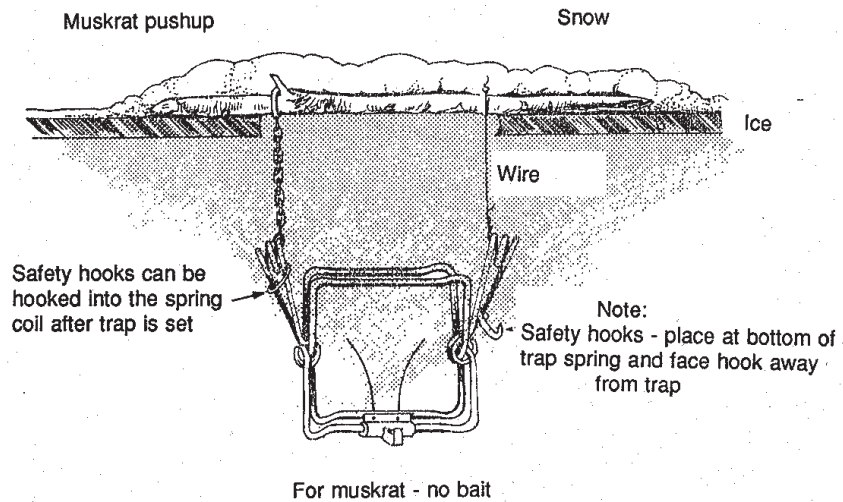

For beaver: tie small green twigs or green aspen stick inside the trap opening on opposite jaws of the trap

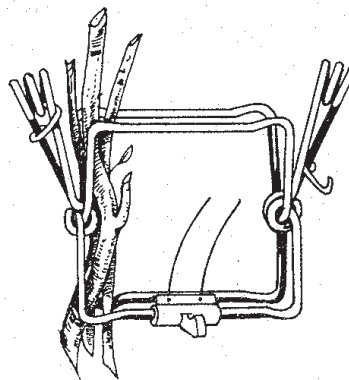
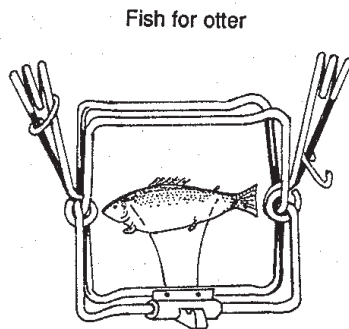



---

## Bait Sets

### Bait Used on Cubby Sets

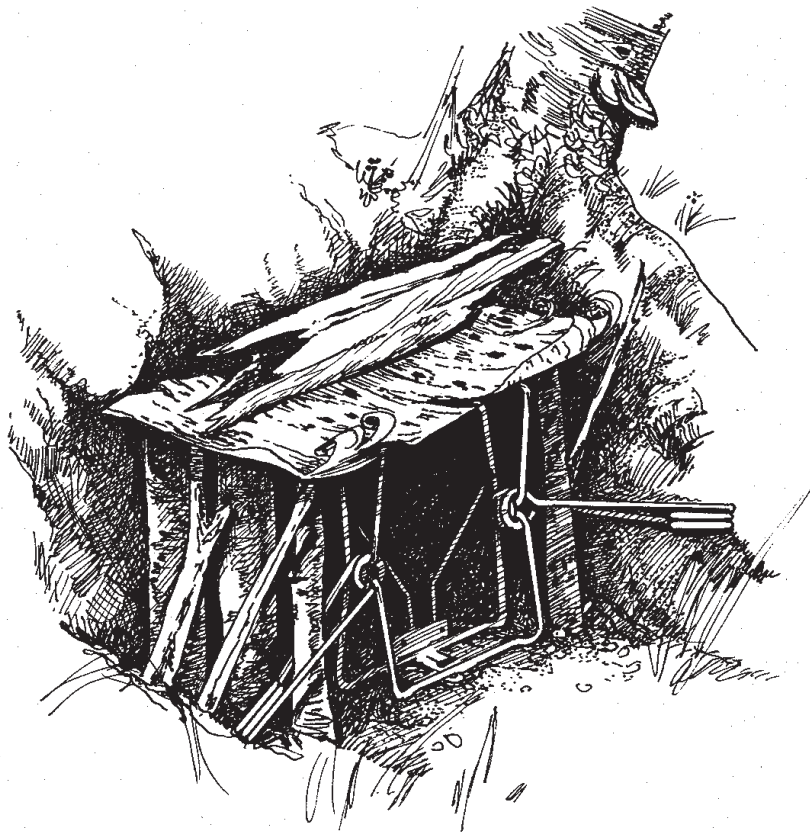

Cubby set for marten and fisher

## Cubby Set

Lynx

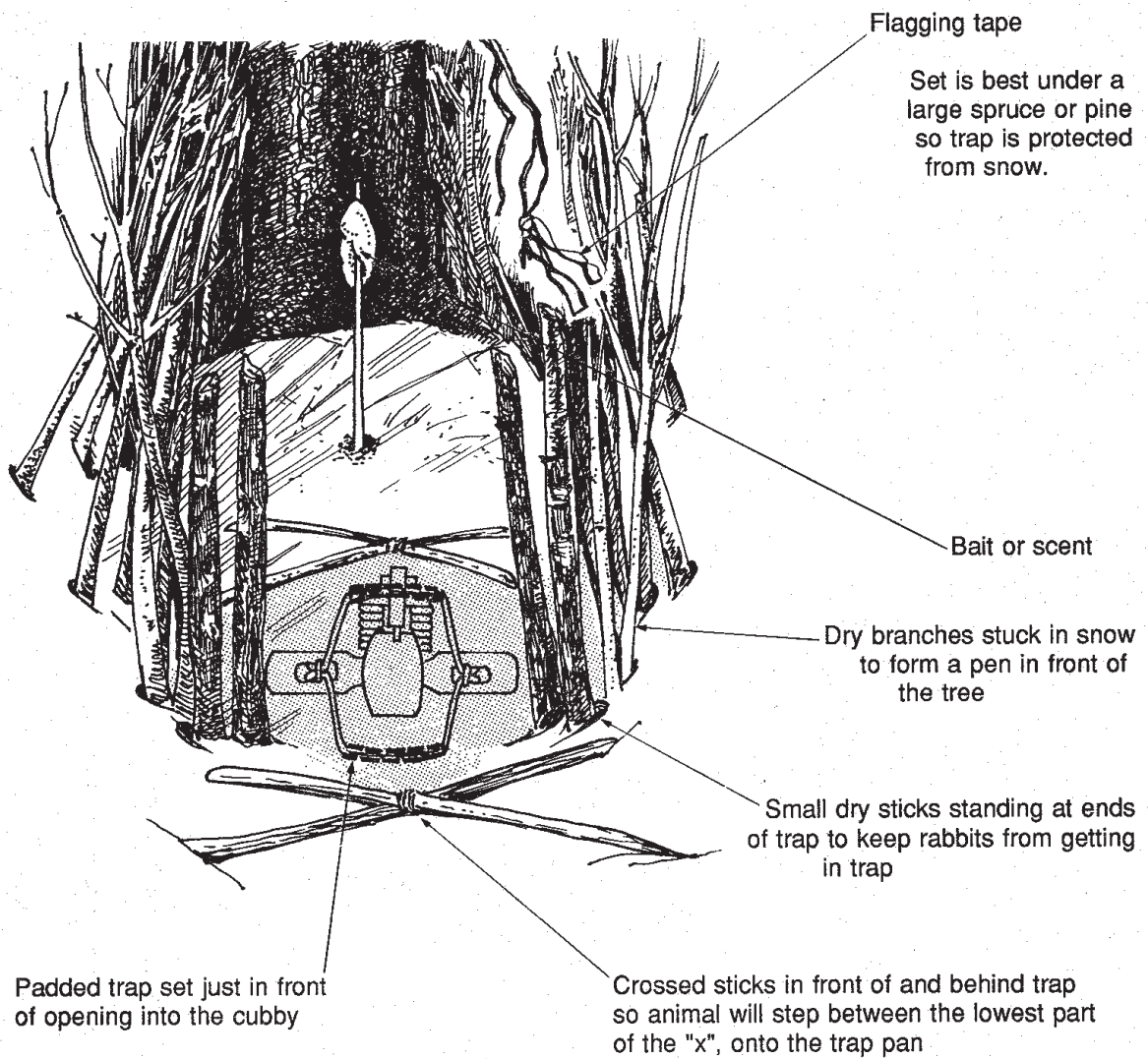

Set may be made using a snare or kill-type trap.

## Scent Post Set

### Side View

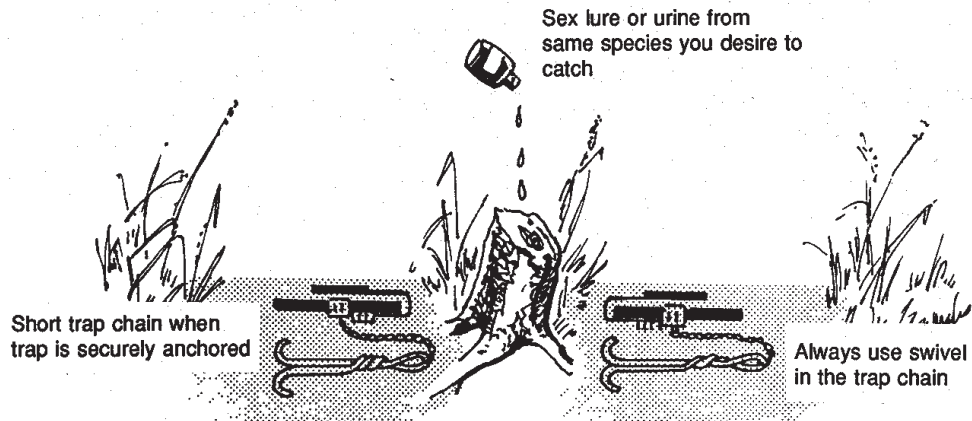

### Top View

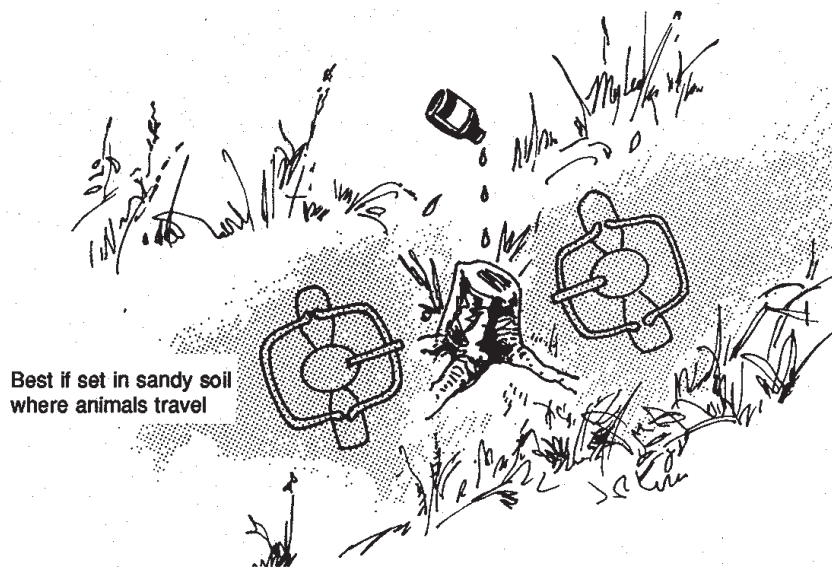

Traps should be covered with 1/2" of fine dirt.  
Traps should be boiled, treated, waxed and have no human scent left on them.

# Dirt Hole Set

## Fox, Coyote, Wolf and Bobcat

Note: Always approach and leave the set from the same direction.

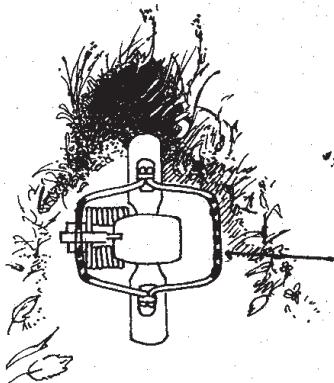

Padded trap with shock absorber spring in the chain

For coyote trap pan should be 8" - 9" in front of the hole and 3" - 4" to one side

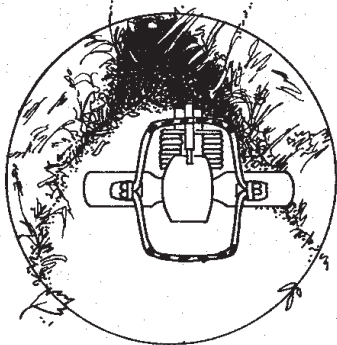

Alternate trap placement

When making a dirt hole set for bobcat the hole should be larger than for the dog family (approximately 4" in diameter)

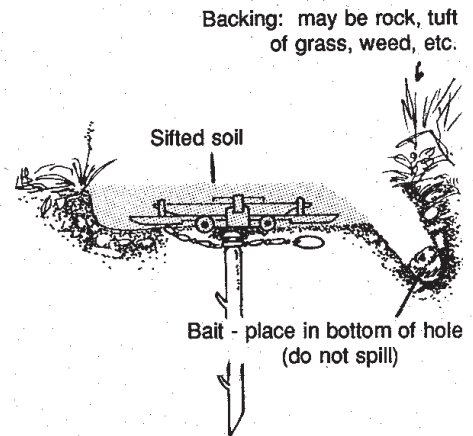

Backing: may be rock, tuft of grass, weed, etc.

Sifted soil

Bait - place in bottom of hole (do not spill)

1. Make sure trap is firmly bedded and will not move if animal steps on trap jaw.
2. Sprinkle urine of intended species over trap and area of trap bed.

Flagging tape

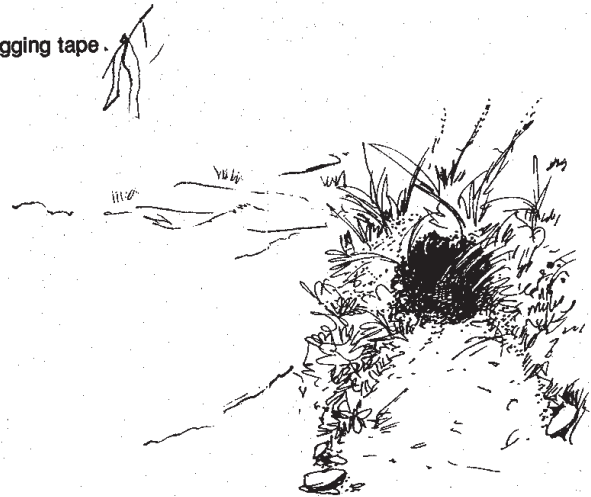

Completed set

## Under Ice Set

### Muskrat

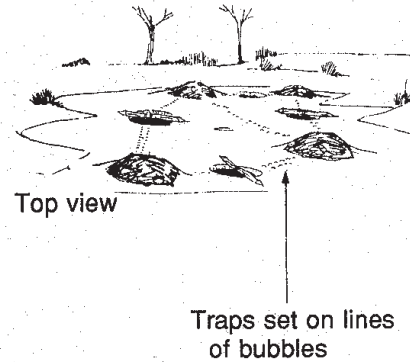
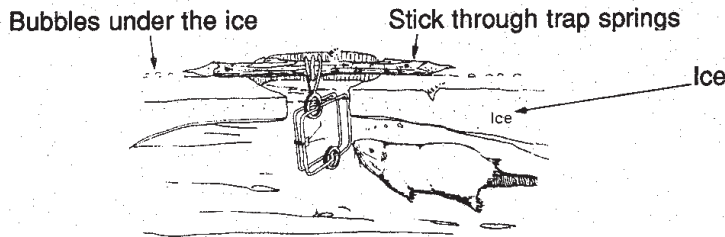

This set is mainly used shortly after freeze-up, when ice is just thick enough to walk on and before snowfall. The trap is set on the muskrat runs shown by the paths of bubbles under the ice. It is set directly across the path with the top jaw just under the ice and the trigger on the bottom jaw. The muskrat swims through it, following his normal run.

Muskrat runs are easily seen by the lines of bubbles they leave under the ice in their travels.

This is a useful set in the fall, when muskrats are most active.

### Muskrat house or pushup

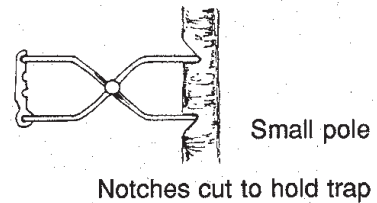
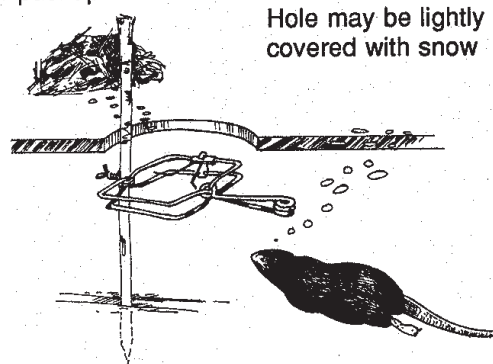

This set is mainly used in late season when weather is warming up. A hole is made 3' - 4' from muskrat house or pushup. The trap is attached to a pole and set flat in the hole at the bottom of the ice. The muskrat will see the hole and swim up toward it, passing through the trap.

---

## Animal Biographies

### Beaver



Beaver are found throughout northern Saskatchewan. They live on lakes, rivers, and smaller bodies of water. They breed during the months of January to March. They live from five to seven years of age. Beaver are found where there are poplar, willow, and water plants. They build houses on shores of lakes and rivers. In the fall, if you see poplar trees in the beaver's feed pile, they are doing well. If you see spruce or other types of trees, then the beaver is not doing well and some may die during winter.

Beaver build houses out of sticks and mud. They leave the middle, top part of the house open for an air vent. This may be used for an escape if water freezes below the house during winter. Beaver pelts are prime from mid-December to mid-February. There is as much danger in not trapping beaver as trapping too many. If there are too many beaver they will destroy the trees along the shore and then not have the good feed that they need to stay healthy.

---

## Lynx



The lynx is a shy, curious animal and can be easily caught by the trapper. They breed during the months of January to March and have 1 to 4 kittens about 60 days later. The lynx will live from 10 to 20 years.

The lynx likes forest areas away from man. They live on rabbits, spruce hens, water birds, mice, and fish. They hunt on the ground but will climb trees and jump down on their prey. The lynx will travel up to 50 miles when looking for food, but usually stays in an area of five miles or less.

The lynx population goes in cycle with the rabbit population. When there aren't many rabbits the lynx will travel a long way to find food. Lynx are found where there are rabbits and will eat up to 170 rabbits a year.

## Muskrat



Muskrats live in or near water. They have up to three litters a year and average eight to 12 young. The muskrat is a very busy animal and can be seen day or night. They build their houses on the edge of water, out of cattails, reeds and other grasses. They live on plants, frogs, clams, and sometimes fish. Changes in water levels in lakes and rivers are hard on the muskrat population.



---

## Red Fox



The red fox was imported in 1650 from Europe for sport hunting and has since mixed with the North American grey fox making the varieties we have today. The fur is generally one of three types: red, silver, or cross fox, and it is usually in prime about mid-winter. Foxes can breed at about 10 months (in January or February) giving litters of 1 to 12 pups. The adult foxes like open areas with some trees and underbrush (forest edges) and often live in deserted skunk or groundhog dens adding tunnels for emergency escape. A fox's territory is generally 1 to 3 square miles and they travel and hunt mostly at night, staying in their own territory during the day. Fox populations follow a pattern that means higher numbers every 3 or 4 years. This also means more occurrence of rabies. A fox with a strong skunky smell or with porcupine quills stuck in it may have rabies and should be handled with gloves.

## Wolf



The wolf is about the size of a large German Shepherd dog weighing about 60 to 90 pounds. It walks and runs with its tail straight back and its ears are rounded (this is different from a coyote). Wolf packs contain only one breeding pair of wolves, mating from February to mid-March and having litters of about 5 pups. Wolves prefer forested hilly areas, fairly close to water and far away from man. The den can be a hollow log, cave or sheltered spot under a tangle of roots. Wolves will eat what ever is available, preferring beaver, caribou, moose, and deer. The wolf's territory varies from 15 to 30 square miles and about 50 to 90 square miles in the winter. Wolf populations, like coyotes, get smaller when food is scarce.

---

## Marten



Marten breed by the time they are a year old, in July or August, and usually have about 3 kits (babies). They like large, forested areas and stay away from open burns. They generally eat birds, insects, and other small animals. A marten is a keen and curious hunter checking out every hole and crevice as they go. The young marten especially are easily trapped. This trapping of young marten is best because it leaves the breeding adults to produce more kits.

---

## Coyote



Coyotes are not as common in the northern forests as they are in the south. They are a little bigger than a full grown fox and are often mistaken for wolves though the coyote runs with his tail pointed downwards and a wolf runs with his tail straight out. The greyish brown fur is in prime from late November until February. They breed from January to March, having litters of 4 to 6 pups and living to the age of 9. Coyotes like living near communities and along forest edges in deserted dens, under stumps or in abandoned buildings. They will feed on almost anything from small animals such as mice and rabbits to vegetable and plant matter. They mostly hunt alone or with a mate at night. Their howling and barking can be heard from far away. Coyote numbers increase when there is lots of food. When food is scarce, the pups often die before they are one year old. The coyote's main enemy is man.

---

## Mink



Mink mate during late February to late March and have an average of 4 kits (young), around April or May. The young that survive live from 3 to 6 years. Mink like streams and lakes where there is dense forest and undergrowth. They live on fish, crayfish, clams, mice, frogs, muskrats, rabbits, and birds.

Full grown mink stay in a small area of approximately 1 square mile for females and 2 to 3 square miles for males. It is best to trap mink further away from water because more males will be caught. The females will be left for breeding.

---

## Otter



River otter are very common in northern Saskatchewan. They mate during March or April just after they have their young. Otters average 2 or 3 pups and will live from 10 to 20 years.

The otter lives close to water and lives on fish, crayfish, water birds, and muskrats. They live on old beaver houses and dens in the bank or a lake or river. The otter will travel a long way when hunting and have toilet stops. Look for these signs as they roll around in the grass at these places.

---

# Marketing Options and Strategies

## Options

It is generally to the trapper's advantage to explore the marketing options available to him before committing his furs for sale. Knowing what options are available and what advantages and disadvantages are involved with each will help the trapper to select the best option to meet his needs.

The two most common ways of marketing furs is to sell them either to a local buyer or to send them directly to an auction house or receiving depot.

The local buyer offers the convenience of being readily available and offering quick payment to the trapper. The trapper also has the choice of either accepting the offer or going elsewhere. But the local buyer is an independent businessman and, like any businessman, must make a profit from the furs he sells.

The auction houses have the advantage of offering such services as drumming (which may up the grade of a pelt), having expert and standardized grading, access to a wider range of buyers, and competitive bidding. The trapper also receives a written record of his sales and grades. A service fee or selling commission is charged when pelts are auctioned and there will be a delay in receiving full payment. It may also involve shipping the furs.

As a rule, fur should be taken when most prime and sold or shipped to market as soon as possible. In this way, the fur will fit into the grading lots easily, rather than being of different primeness, and having to be sold as a small separate batch.

Most of the best sales occur from December to February, as this is when the greatest quantity of prime pelts are available and the greatest number of buyers are present to bid on the fur.

Trappers can market their furs by any of the following methods:

1. Pelts may be sold to a licensed Saskatchewan resident fur dealer. Fur dealers and fur auctions can only receive fur from licensed trappers. Please insure that you give the dealer your fur conservation area number indicating the wildlife zone(s) where fur was taken.
2. Pelts may be sold to any of the following auction companies outside Saskatchewan provided an Export Permit is obtained from a Saskatchewan Parks and Renewable Resources office and fur royalties are paid.

Dominion Soudack Fur Auction Sales  
589 Henry Avenue  
Winnipeg, Manitoba R3A 0V1

---

Edmonton Fur Auction Sales Ltd.  
10261 - 108th Street  
Edmonton, Alberta T5J 1L6

Hudson Bay Company  
International Fur Sales Centre  
65 Skyway Avenue  
Rexdale, Ontario M9W 6C7

North Bay Fur Sales  
123 River Street West  
Prince Albert, Saskatchewan S6V 2Z1

Western Canadian Raw Fur Auction Sales Ltd.  
303A West Pender Street  
Vancouver, British Columbia V6B 1T3

3. Persons shipping wolf, lynx, bobcat, or otter pelts to a foreign country must obtain a Provincial Export Permit and an Endangered Species Export Permit. These permits are available from any Resources office free of charge. Any Saskatchewan fur leaving the province must have the fur royalties paid.
  
4. If a person wishes to keep a pelt for a trophy, a permit clearing the pelt for that purpose will be issued when the royalties are paid.





Saskatchewan  
Parks and  
Renewable  
Resources

# Fur Export Permit and Royalty Receipt

39041

Carrier's Copy

Permission is hereby granted to

Province of origin

Of

To

Maintain in possession

or to export

from Saskatchewan the raw furs or pelts described on this form to:

Consignee

Address

General receipt number

Trappers licence number

Fur dealers licence number

Declaration tag number

**Out of Province fur**  
(No royalty payable but  
declaration tag from  
Province of origin must  
be attached to duplicate  
or green copy of this permit.)

Province of origin

Number of packages

This is a receipt for payment of

\$

Issued at

Date

Signed

For Deputy Minister

Saskatchewan Parks and Renewable Resources

or F.C.A. W.M.Z.	Number of fur pelts	Royalty rate @	Royalty dues	Wild Species
			\$	Arctic Fox
			\$	Badger
			\$	Bear
			\$	Beaver
			\$	Bobcat
			\$	Coyote
			\$	Fisher
			\$	Fox, Cross
			\$	Fox, Red
			\$	Fox, Silver
			\$	Lynx
			\$	Marten
			\$	Mink
			\$	Muskrat
			\$	Otter
		Nil	\$	Rabbit, Bush
		Nil	\$	Rabbit, Jack
			\$	Raccoon
		Nil	\$	Skunk
			\$	Squirrel
			\$	Weasel
			\$	Wolf, Timber
			\$	Wolverine
			\$	Other

**Total Royalty** ➔ \$

Ranch fur

No. of pelts	Royalty	Species
	Nil	
	Nil	



Saskatchewan  
Parks and  
Renewable Resources  
**Declaration Tag**  
Wildlife Act (Saskatchewan)

Shipped: By Express, Weight of Package ..... lbs.  
By Mail, Date of Shipment ..... 19.....

I hereby declare that the statement on the reverse side of this tag giving number and kind of Raw Fur Pelts contained in the parcel or receptacle to which this statement is attached is correct and that I have complied with the requirements of The Wild Life Act (Saskatchewan) and the royalty under the said Act has been paid.

Signature of Shipper .....  
Address .....  
Witness ..... License No. ....  
Export Permit No. ....

**No 5195 E**

Tear off along this line



Saskatchewan  
Parks and  
Renewable Resources  
**Declaration Stub**  
Wildlife Act (Saskatchewan)

Shipped from ..... Date .....  
Name of Shipper .....  
License No. ....  
Export Permit No. ....  
Shipped to .....  
Address .....  
Signature of Collector .....

**Inside Stub**  
Fill out both sides and place inside each package of Furs exported.

**No 5195 E**



Badger	Mink
Bear	Muskrat
Beaver	Otter
Coyote	Rabbit Jack
Fisher	Rabbit Bush & Others
Fox, Blue	Raccoon
Fox, Cross	Skunk
Fox, Red	Squirrel
Fox, Silver or Black	Weasel or Ermine
Fox, White	Wild Cat
	Wolf, Timber
Hides	Wolverine
Lynx	
Marten	

**Inside Stub**

This Bundle contains as follows:—

Badger	Mink
Bear	Muskrat
Beaver	Otter
Coyote	Rabbit Jack
Fisher	Rabbit Bush & Others
Fox, Blue	Raccoon
Fox, Cross	Skunk
Fox, Red	Squirrel
Fox, Silver or Black	Weasel or Ermine
Fox, White	Wild Cat
	Wolf, Timber
Hides	Wolverine
Lynx	
Marten	

This Stub Declaration Tag properly filled out must be placed inside each package of Furs exported.

---

## Terms Used to Describe Raw Fur

- Badly Sewn** This results when jagged pelts or bloodstained portions of a considerable size are sewn together.
- Boardy** Refers to a condition in raw fur where leather is stiff, generally in springy pelts. Noticeable on the back of the neck of the pelt, mainly lynx and fisher.
- Burnt** This condition occurs when a pelt can be cracked open owing to quick drying by fire, hot sun, or by grease burn. The pelt will seldom survive the dressing process and thus, is usually worthless.
- Clean** For weasel or muskrat, means seasonable skins free of damage. A percentage of slightly shot skins in squirrel is allowed.
- Clipped or Sheared** This condition occurs when guard hair and/or underfur is missing, caused by knife or other cuts, or where the fur has been eaten away by mice, shrews, etc.
- Density** This refers to densely packed underfur which is more important than depth. Dense underfur is usually accompanied by at least an adequate amount of depth to make a good skin.
- Depth** This describes the length of fur.
- Drowned** This condition of the pelt occurs when animals are trapped in water and can bring about a taint condition. Usually occurs when animals are left too long in the water.
- Flat** This refers to guard hair lying flat on the back, due to lack of underfur.
- Flow** This condition refers to life-like appearance in fur when handled.
- Hairslip** Hair falling out of the pelt as a result of damage to hair roots or the fur being left too long on the carcass and spoiling.
- Heavy** Refers either to the weight of the fur or, as in the case of muskrat, the thickness of leather and fur.
- Immature** This condition refers to pelts taken too early, showing less than the full growth of underfur and guard hair.
- Loose (open) Flank** Shortage of guard hair along flanks, indicative of overprime pelt.
- Loose** This occurs when top hair is coming away from the skin, owing to exposed roots in early caught pelts, or by the seasonal loss of guard hair (shedding) in case of late-taken coyote, fox, lynx, wolf, etc.

---

<b>Low</b>	This refers to under-developed underfur.
<b>Over-Stretched</b>	Refers to pelts that are stretched too wide, or too long and narrow. Over-stretched pelts may result in a larger size but will lose quality.
<b>Oxidation</b>	The natural process by which all organic material, including fur, ages due to exposure to light and air. It usually shows itself by a darkening or reddening colour. Modern tanning slows the process, making the change in colour more natural.
<b>Prime Pelt</b>	The leather side is clear and white or very slightly blue, usually soft, pliable and slightly greasy - the underfur is dense and deep, completely covered with guard hair. The overall appearance is glossy and the fur full of life and flow to the touch. Unless damaged, prime pelts are usually graded as 1 and No. 2's. Prime pelts are taken in season only.
<b>Rough</b>	This condition occurs when guard hair and underfur are fully developed in foxes; rough can refer to heavy but rubbed skins.
<b>Rubbed</b>	This condition usually occurs when a pelt is overdeveloped and going out of prime results in guard hair missing in places, thus exposing the underfur.
<b>Singed</b>	A condition that can occur in two ways: <ul style="list-style-type: none"> <li>• Pelts that become singed because they are literally burnt or singed in the fur by fire or sun;</li> <li>• A seasonal occurrence frequently in late-caught pelts. Most often evident with mink and otter.</li> </ul>
<b>Snared</b>	This is caused when the fur is rubbed off down to the pelt by a wire snare. Can often be readily visible on the leather side.
<b>Springy</b>	This usually occurs in late-caught pelts that appear lifeless or have faded underfur and often is a rather hard or dry pelt. The guard hair may be rubbed, brittle, incomplete, or singed. Can be indicated by black markings on the leather.
<b>Stain</b>	Pelt discolouration mainly noticeable in polar bear and white fox. Depreciates value of fur.
<b>Tainted</b>	This is the worst form of damage. When slight - can be difficult to detect. It causes slipping of guard hair and underfur and is usually indicated by a discoloured or transparent patch on the pelt side. It can be caused by rotting of the pelt surface when an animal is left too long in the trap. The fur comes away in quantities from the affected area and a bad odour is evident.
<b>Unprime Pelt</b>	Occurs when the fur is coming into prime or leaving the prime condition.

---

---

### **Early Caught Skins**

- Pelt - blue, greasy, and pliable
- Fur - low or flat in centre
- Neck - low or flat
- Complete looking
- Fur at its best for colour

### **Late Caught Skins**

- Hard and/or dry pelt, often veined or spotty
- Faded or poor colour, open and weak in appearance, or rubbed
- Dry and lifeless fur

Unprime pelts are usually graded as seconds. The leather of very late caught skins is often blotchy or black, especially in mink and otter. They are graded as thirds and fourths.

## **Fur Quality**

During the late summer or early fall, fur bearers shed their coat of summer fur and begin to grow a new coat of longer, thicker, winter fur. In the early stages of growth, the roots of the hair are deeply imbedded in the leather and a pelt taken at this time of year (known as under prime) will appear dark or bluish on the skin side as a result of the roots showing through.

As the hair grows towards prime, the roots move further up into the leather and a fully prime pelt then has a clean, pale appearance on the flesh side. Eventually, the hair roots reach close to the outer surface of the hide and fall or slip out. This is called an over prime pelt. Buyers prefer pelts which are just slightly under prime, as otherwise it is difficult to gauge whether there will be shedding or not.

The time of priming will vary from species to species, from one zone to another and from year to year. Also, the trapper cannot rely solely upon the season dates given in the provincial regulations to gauge primeness because the dates given are made broad enough to include these variations.

The use of the Prime Pelt Chart which follows will help the trapper to estimate the best time to harvest each species of furbearer. A good practice is to begin by trapping one animal and checking the primeness. If it is not ready, then wait and try again a bit later. When an animal is secured which is of the right primeness, begin your trapping seriously.

## Prime Pelt Quality Fur Schedule

season only.

<b>Rough</b>	This condition occurs when guard hair and underfur are fully developed in foxes; rough can refer to heavy but rubbed skins.
<b>Rubbed</b>	This condition usually occurs when a pelt is overdeveloped and going out of prime results in guard hair missing in places, thus exposing the underfur.
<b>Singed</b>	A condition that can occur in two ways: <ul style="list-style-type: none"><li>• Pelts that become singed because they are literally burnt or singed in the fur by fire or sun;</li><li>• A seasonal occurrence frequently in late-caught pelts. Most often evident with mink and otter.</li></ul>
<b>Snared</b>	This is caused when the fur is rubbed off down to the pelt by a wire snare. Can often be readily visible on the leather side.
<b>Springy</b>	This usually occurs in late-caught pelts that appear lifeless or have faded underfur and often is a rather hard or dry pelt. The guard hair may be rubbed, brittle, incomplete, or singed. Can be indicated by black markings on the leather.
<b>Stain</b>	Pelt discolouration mainly noticeable in polar bear and white fox. Depreciates value of

---

## Grading Furs

The trapper should learn the basics of fur grading so that he knows what the buyers want in a pelt and what things to avoid. He can then estimate the quality and value of his pelts and know if he is being given a fair deal.

When grading a pelt you first measure the size, then examine the colour and natural quality of the fur. The density of thickness of the fur is very important as is the completeness of the fur. A complete fur has all the guard hairs present and they are not clipped or rubbed. After the primeness of a pelt is checked it is fixed into a grade.

The overall appearance of the pelt is taken into account. The pelt will be examined for natural damages and for damages that result from poor handling. If any damages such as cuts or bite marks are found the pelt is given a lower grade according to the type, extent, and location of the damage.

To get the best possible value, it is important to trap animals when they are as close to prime as possible and to handle them well.

## Grading Descriptions

### Sizes

XXXL, 0	<i>Supers, Jumbo</i>
XXL, 1	<i>Extra, Extra Large</i>
XL, 2	<i>Extra Large</i>
L, Lge, 3	<i>Large</i>
LM, Lge Med. 4	<i>Large Medium</i>
M, Med. 5	<i>Medium</i>
S, Sm. 6	<i>Small</i>
CUB 7	<i>Cub</i>
XSM	<i>Kits</i>
AVG	<i>Average</i>

### Grades

1 & No. 2	<i>Best Quality, Select</i>
I-II	<i>Very Good Quality</i>
SL	<i>Good Quality with Slight Imperfections</i>
SEC	<i>Good Quality, Slightly Weak</i>
II	<i>Fair Quality</i>
II ORD	<i>Slight Weaker than Fair</i>
LO II	<i>Poor Quality</i>
III	<i>Very Poor Quality</i>
IV	<i>Extremely Poor Quality and Badly Damaged</i>
E	<i>Early</i>
SP	<i>Springy</i>
SHEDDER	<i>Late Caught</i>

### Other

BD	<i>Bad</i>
CSD	<i>Cased</i>
CLN	<i>Clean</i>
CR	<i>Course</i>
DGD	<i>Damaged</i>
DSD	<i>Dressed</i>
FLS	<i>Falls</i>
FL	<i>Flat</i>
GC	<i>Good Colours</i>
GD	<i>Good</i>
GW	<i>Good Weight</i>
GRS	<i>Greasy</i>
GRZ	<i>Grizzly</i>
HY	<i>Heavy</i>
HO	<i>Hair Out</i>
LO	<i>Leather Out</i>
LT	<i>Light (Weight)</i>
OC	<i>Ordinary Colours</i>
OP	<i>Open</i>
ORD	<i>Ordinary</i>
OW	<i>Ordinary Weight</i>
PT	<i>Part</i>
PC	<i>Poor Colour</i>
PR	<i>Poor</i>
RB	<i>Rubbed</i>
SH	<i>Semi Heavy</i>
SL	<i>Slight (damaged, off colour)</i>
SLDGD	<i>Slight Damaged</i>
SGD	<i>Singed</i>
SMTH	<i>Smooth</i>
SO	<i>Slight Off</i>
SS	<i>Slight Singed</i>
STL	<i>Stale</i>
WK	<i>Weak</i>
WTR	<i>Winter</i>
WLY	<i>Woolly</i>

### Sections:

AB	<i>Alberta</i>	NC	<i>North Central</i>
ARTC	<i>Arctic</i>	ON	<i>Ontario</i>
BC	<i>British Columbia</i>	SK	<i>Saskatchewan</i>
MB	<i>Manitoba</i>	USA	<i>United States</i>
MKR	<i>MacKenzie River</i>	W	<i>Western</i>
N	<i>Northern</i>	WA	<i>Western Arctic</i>
NA	<i>Northern Alberta</i>	Y	<i>Yukon</i>



---

## Fur Handling

### Pre Skinning Care

#### Removal From Trap

- if the animal is frozen, care must be taken to prevent damage to the pelt (trap may have to be removed after thawing)
- in freezing weather, if the animal is wet, the trap should be removed immediately and the fur dried as much as possible

#### Transporting the Carcass

- be sure fur is protected by enclosing the carcass in a sack or tarp or by placing some form of padding around it to prevent rubbing or freezing against a cold wet surface or another carcass.
- be sure carcass is sufficiently thawed prior to skinning
- on all pelts that are handled cased and fur in, the fur should be dry before they are skinned and put on the drying boards

### Skinning

Animals should be skinned as soon as possible after capture. If this is not done, the animal should be frozen. However, it should not be kept frozen for a prolonged period of time as freezing tends to dehydrate the pelt. Once an animal is thawed, it should not be refrozen.

### Fleshing

A flesher is used to remove excess fat and flesh from the entire pelt.

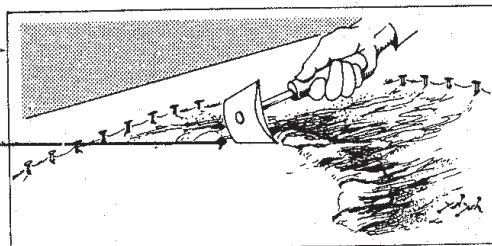

### Forming and Turning

The pelt is formed on a board and turned if required.

---

## Finishing

### Cleaning

Wash and rinse, use warm water and dish soap or shampoo (anything you would use on your own hair) to remove any blood or other foreign material. Then rinse in warm water to remove any soap film or dirt. Clean fur is very important - if fur is not clean, it can even damage other fur during shipment.

### Sewing

Use a cutting edge, a suture needle (available from your veterinarian), or a three-sided gloves needle, fine, strong thread and a lock-type stitch when sewing most pelts.

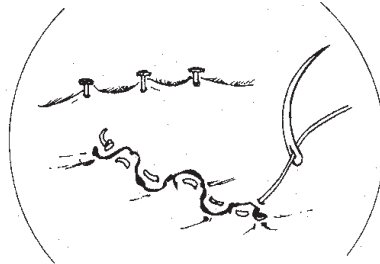

### Drying

Dry in a moderately warm (55 - 65 degrees F) location, away from direct heat.

### Storage

Pelts should be stored in a cool dry place.

Open pelts should be piled flat, leather to leather and fur to fur to keep oil off the fur. A piece of plywood should be placed on top and weighed down if necessary, to prevent the pelts from rolling up (i.e. a beaver forming board is ideal for beaver and badger).

It is preferable to hang other pelts by the nose to allow air circulation.

---

## Pelts

There are three basic styles or forms of handling pelts for the fur market. They are as follows:

### Open Pelt

- Beaver, bear

With this style, the pelt is split lengthwise down the centre of the belly and spread out flat or open to dry. Buyers expect these pelts to be prepared in this way and want to be able to see both the skin and fur sides of the pelt.

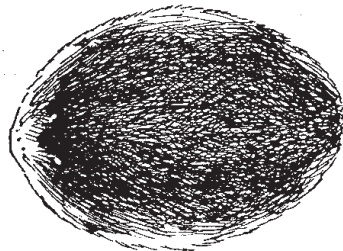

### Cased Pelt (Fur In)

- Mink, muskrat, squirrel, weasel, otter

In skinning an animal in the cased (fur in) style, a cut is made across the hind legs and vent and the pelt is peeled off the animal inside out, in the same manner you would use in removing a sock. The pelt is dried and sold as is, without turning or splitting the pelt open. Tails on the mink, fisher and otter are split to the tip, spread apart and dried. Be sure to have a viewing window on the mink belly (see illustration).

Buyers want the fur inside to protect these furs from grease or singeing. This is the traditional style for these pelts and buyers become suspicious if they are handled differently.

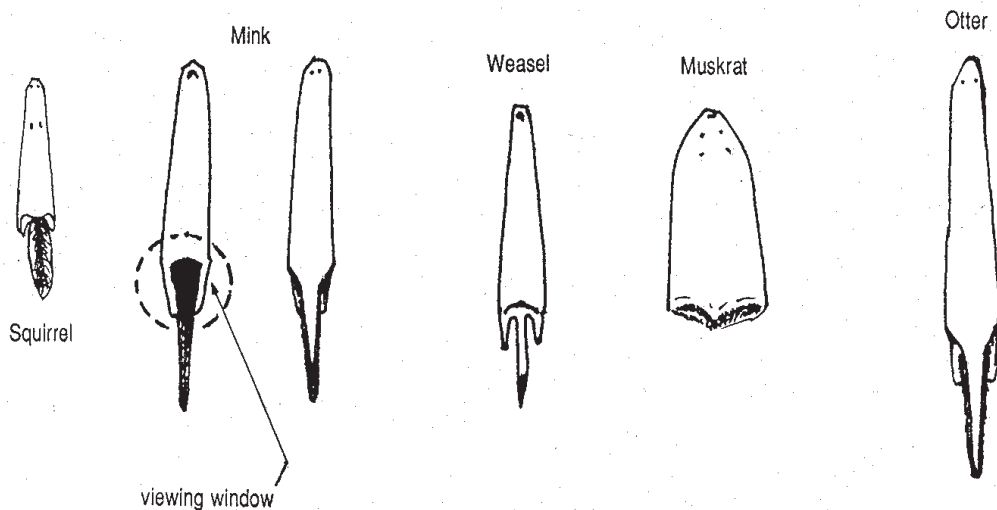

### Cased Pelt (Fur Out)

- Wolf, coyote, fox, lynx, marten, wolverine, fisher

The cased pelt (fur out) is skinned in the same manner as the cased pelt (fur in). The only difference is that the pelt is put on the forming board, fur side in, and is partially dried. The pelt is then removed from the board and turned fur side out, after which it is put back on the form to complete the drying process. The pelt is traditionally marketed fur out. The animals prepared in this way generally have long belly fur which the buyer wants to carefully examine for quality and colour or for rubbing and other damage. Important: Be sure to skin out the ears and dry properly.

It is important for trappers to strive for consistency in the style and manner of handling. Pelts which are not done to pattern are a nuisance for buyers to handle and generally bring a much lower price.

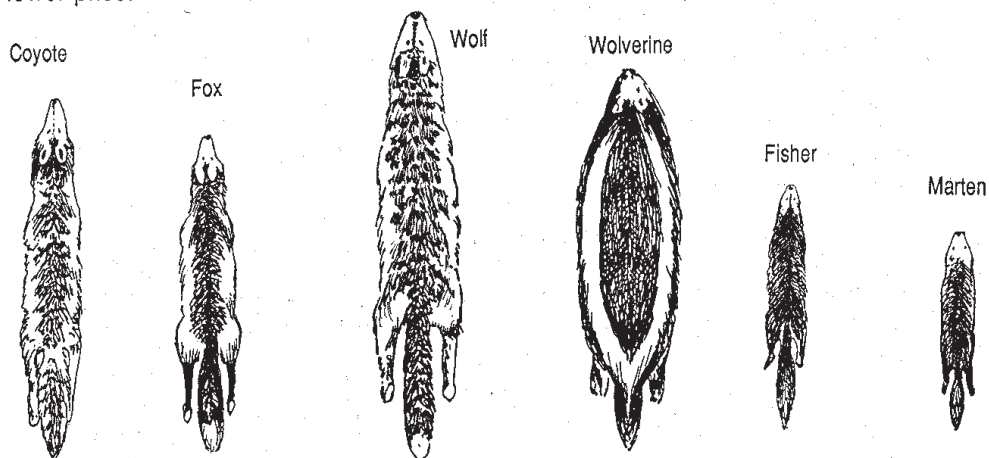

---

## Skinning and Marketing Information

Bear	Skin square or open, leave claws on. Be sure to flesh out and dry the ears.
Beaver	Skin and form open and flat, sew or nail all leg holes.
Wolf	Skin and form cased, fur out. Leave claws on if pelt is of good quality suitable for a rug. Be sure to flesh out and dry the ears.
Wolverine	Skin and form cased, fur out. Leave claws on.
Coyote	Skin and form cased, fur out. Do not leave claws on.
Lynx	Skin and form cased, fur out. Do not leave claws on.
Bobcat	Skin and form cased, fur out. Do not leave claws on.
Fox	Skin and form cased, fur out. Do not leave claws on.
Fisher	Skin and form cased, fur out. Do not leave claws on. Be sure tail is split and dried like a mink or otter.
Marten	Skin and form cased, fur out. Do not leave claws on.
Mink	Skin and form cased, fur in. Do not leave claws on.
Weasel	Skin and form cased, fur in. Do not leave claws on.
Squirrel	Skin and form cased, fur in. Do not leave claws on.
Otter	Skin and form cased, fur in. Do not leave claws on.
Muskrat	Skin and form cased, fur in. Do not leave claws on.
Badger	Skin square or open. Do not leave claws on.
Raccoon	Skin and form cased, fur in. Do not leave claws on.
Skunk	Skin and form cased, fur in. Do not leave claws on.

The tails should be open on all pelts, except squirrel and weasel, to allow for proper drying and prevention of hair slip. Beaver tails are not left on the pelt. All pelts should be clean, free of excess fat and flesh and all unwanted holes or cuts should be sewn carefully prior to drying. Furs should be carefully brushed or combed prior to selling or shipping.

## Proper Method for Preparing Raw Pelts for Market



Coyote



Fox



Wolf



Wolverine



Beaver



Fisher



Marten



Lynx



Mink



Weasel



Muskrat



Otter



Squirrel

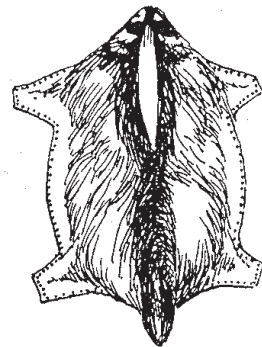

Badger

## Cased Fur Drying Boards

When individual drying boards have been cut to size and shape, the edges must be sloped on both sides with a plane, draw-knife, hand axe or knife. The cross-section of the drying board on this page shows the approximate proper shape of the sloped edge of the form all round. When completely shaped, the entire board should then be sanded smooth.

The illustrations show two different models of drying boards having slightly different methods of easing the pelt tensions for easy removal of the dried pelt. The three piece "a" type can be used on a wider range of pelt sizes than the "b" type solid drying board, but it is more complicated to build.

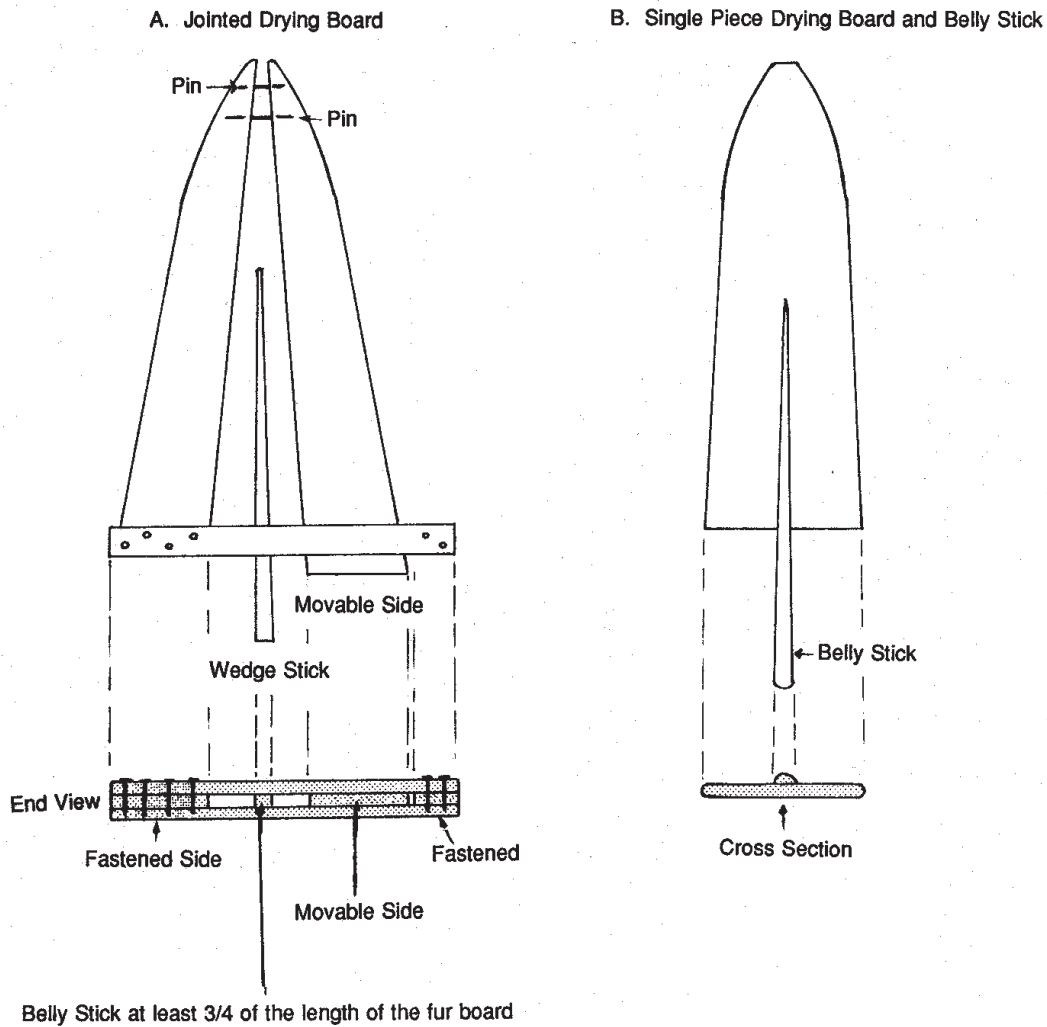

## Patterns for Pelt Stretching

- A. Total measurement
- B. Length from nose to measurement C
- C. Width at tail section
- D. Shoulder to nose length
- E. Shoulder width

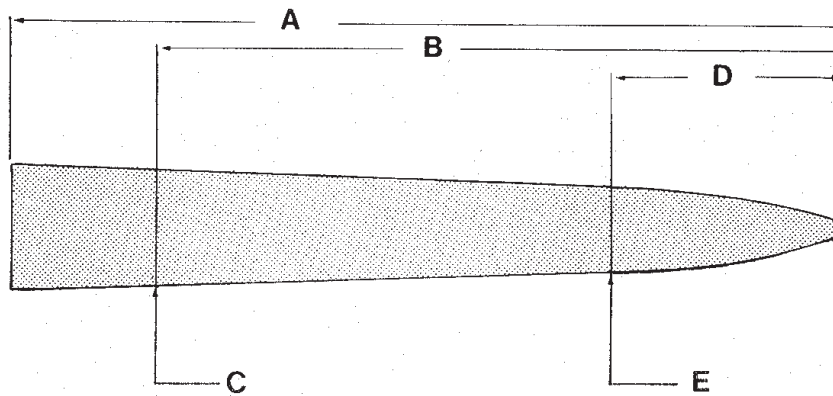

	A	B	C	D	E
Wolf	92"	80"	18"	20"	12"
Coyote	72"	60"	13"	15"	9"
Lynx, large	72"	60"	8"	12"	6"
Lynx, small	60"	48"	7"	10"	5"
Fox	55"	45"	7"	11"	5"
Fisher, male or large	52"	42"	8"	10"	6"
Fisher, female or small	52"	42"	7"	10"	5"
Skunk, large	44"	36"	6"	8"	5"
Marten	40"	30"	4½"	8½"	3¼"
Mink, male or large	40"	30"	4"	8"	3"
Mink, female or small	40"	30"	3½"	8"	2½"
Weasel, extra large	22"	18"	2½"	5"	1¾"
Weasel, large	18"	15"	2"	4"	1½"
Weasel, small	16"	12"	1¾"	3"	1¼"
Squirrel	16"	12"	2½"	3½"	2¼"



## Proper Method for Preparing Raw Pelts for Market



Coyote



Fox



Wolf



Wolverine



Beaver



Fisher



Marten



Lynx



Mink



Weasel



Muskrat



Otter



Squirrel

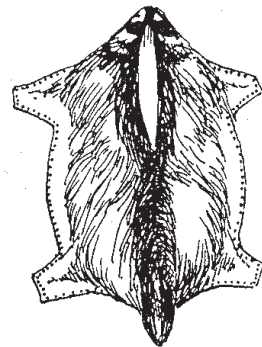

Badger

---

# Tax and the Trapper

## Income Tax

Income tax can be calculated two ways:

**Cash Method:** income is reported when received and expenses reported when paid;

**Accrual Method:** income is reported when earned and expenses reported when they occur, whether or not they have been paid.

The method chosen must be on a year-to-year basis.

An individual's tax year ends December 31, therefore you are required to report all your income earned for the year up until December 31. Trappers may choose a taxation year which is different from the calendar year.

The Income Tax Act requires you to keep proper records of your earnings and expenses. You must keep receipts to support your expenses. If receipts aren't kept, the tax department may not allow the expenses. A bank account is helpful to keep a record of business transactions.

## Deductions

Generally all assets purchased or built costing \$200 or more should be capitalized and depreciation taken on annual rates. Assets such as buildings, equipment, boats, vehicles, ski-doo's, chain saws, and outboard motors can be considered. New assets purchased are eligible for an investment tax credit. This credit is a deduction from the federal tax payable.

If you hire another person and pay him an hourly wage or a salary, you must deduct CPP, UIC and income taxes and send them to the tax department. You have to get an employer number and prepare T-4's at the end of each calendar year for your employees. You can pay your wife a reasonable salary. Deductions, except UIC, must be withheld. This is an accepted way of income splitting and should be used. Children can be placed on the payroll also. They can earn a certain amount each year before reducing your claim as dependents for tax purposes.

If you have a workroom in your home a reasonable amount of expenses incurred can be used against your business income. You can claim a portion of insurance, taxes, heat and power, telephone, and repairs.

You may claim all expenses connected with the operation of your trapline. These include gas, oil, repairs and maintenance of vehicles and snowmobiles while they are being used on your trapline. Insurance and license fees for equipment used on the trapline can be claimed in the same percentage as their use. Costs of trapping supplies such as knives, scrapers, boards, traps may be claimed. Repairs and maintenance, including the cost of heat and light for your trapline cabin may be claimed. Membership fees in trapping organizations and costs of trapper's license may be claimed. Expenses related to attendance at one convention each year may be claimed.

---

## Resources

Alberta Advanced Education, Forestry, Lands and Wildlife (1987). *Trapping and Conservation Manual*; 5th Edition

Runge, Wayne and Henry, David. *Wild Furbearers of Saskatchewan*. Saskatchewan Parks, Recreation and Culture.

Saskatchewan Parks and Renewable Resources. *Saskatchewan Trapper Education Manual*.

Saskatchewan Parks and Renewable Resources (1985). *Handbook of Diseases of Saskatchewan Wildlife*

Tymchak, Michael and Dalby, Lois (1975). *Fur, Fights and Finance*. La Ronge: Academic Education, Department of Northern Saskatchewan.