

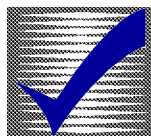

HOW-TO BOOKLET #3084

BROKEN WINDOWS



TOOL & MATERIAL CHECKLIST

- Glass
- Glazing Points
- Spring Clips
- Screwdriver
- Brush
- Tape Measure
- Glazing Compound
- Putty Knife
- Steel Wool/Sandpaper
- Finish Paint for Window Trim
- Gloves
- Plastic Gasket
- Pliers
- Paint/Linseed Oil
- Wiping Cloths

Read This Entire How-To Booklet for Specific Tools and Materials Not Noted in This Basics Listed Above.

Broken windows are like spilled milk. Both are a reality of life and both can be replaced easily within most budgets. Certain types of glass are costly, however—thermal glass, for example.

Glass used in home construction is manufactured in six different types in a price range from moderate to very expensive and in sizes almost unlimited for standard replacement in windows and doors. Single strength glass is standard for windows and doors; double strength glass is the same—but is a bit stronger.

Tempered glass, the best buy for patio doors and screen/storm combination doors, will not shatter into jagged pieces when broken, thus providing a very important safety feature. In fact, in many areas tempered glass is required by local building codes.

Safety glass is similar to tempered glass and should be considered for windows and doors subjected to heavy people traffic. Some types of safety glass have small wires embedded in the glass for strength.

Insulation glass, or thermal glass, is generally found in patio doors or other installations where large areas of glass are used. You can tell an insulation glass installation by looking carefully around the edge of a window or door. You'll see a metal strip dividing the sections of glass. It's this "double glass" with a thin layer of air space between surfaces that gives the glass its insulation or "thermal" quality. When one pane of this double-pane is broken, the entire section of glass usually must be replaced. Hence the cost.

Specialty glass includes tinted glass, frosted glass and glass blocks—products which are very expensive and are used as special accents. This glass may have to be special ordered, which adds to the price.

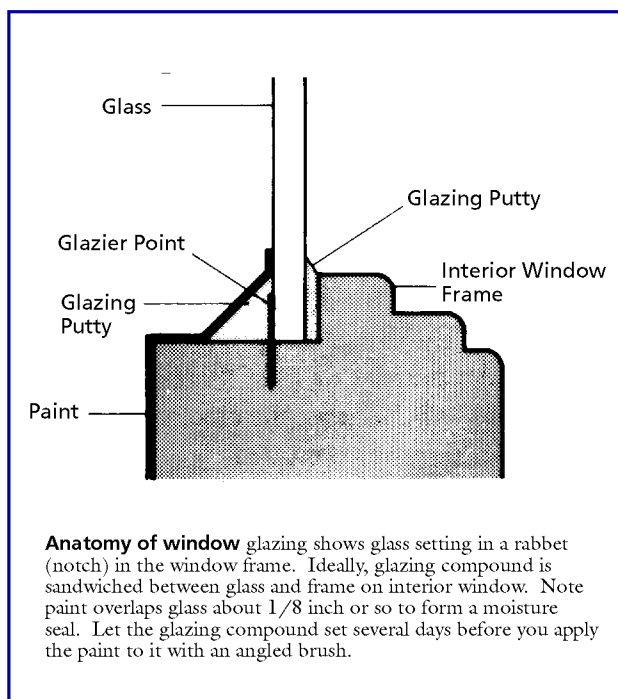

When buying replacement glass, we recommend that you take a piece of the broken glass to the store. With this sample the store can quickly determine the type of glass you need.

Be sure to measure carefully the exact size of the pane you need. Do not guess. Trimming bits of glass to fit can be a very difficult job—and expensive when the glass breaks.

CAUTION: When working with glass be sure to wear heavy gloves to protect your hands. If the replacement will be above your head, also wear safety glasses to protect your eyes from tiny pieces and chips of glass. If you will cut glass, we recommend that you wear both gloves and safety glasses.

GLASS IN WOODEN FRAMES

On a scale of 1 to 10, glass supported by wooden frames probably would rank No. 1 in ease of replacement. Here are the steps to take:

1 If the glass is completely broken where you can grab onto it with a gloved hand, remove the glass by simply pulling it up and out of the glazing compound that holds it in the window mullions or frame.

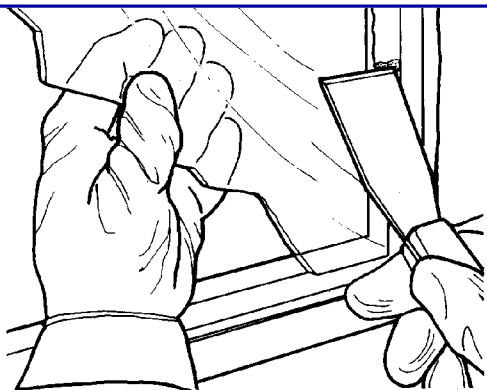

Remove glass and glazing compound (or putty) from the window. Sometimes the glass and glazing can be coaxed out at the same time. Wear heavy gloves for this project.

If the glass is just cracked, do not break it out of the frame; you could damage the frame by doing so. Instead, with a putty knife remove the glazing around the glass, as detailed in Step 2.

2 Remove the glazing from the frame, starting at about center of the frame and working toward the corners. Use a putty knife for this, trying to work the edge of the knife between the frame and the glazing compound. Once started, you should be able to almost “flip” the glazing compound out of its niche.

Most of the glazier’s points that hold the glass in the frame will come out with the glazing compound. If not, use the edge of the putty knife to work the points out of the wood. You may be able to pull them out with pliers, but be careful. You don’t want to damage the frames.

3 When the frame is free of glass, glazing, and glazier’s points, measure the distance between the top and bottom frame and the sides of it. Measure twice. The replacement glass must fit fairly tight in the frame, but shouldn’t be a push fit. You must have a little space between the

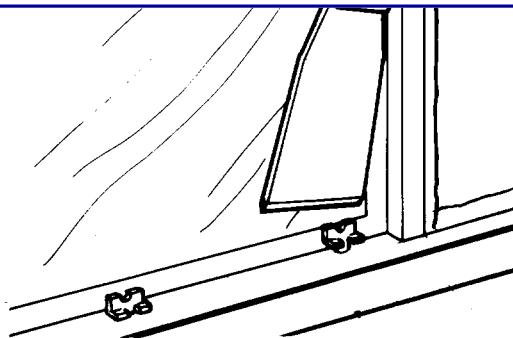

Press glazier’s points into frame with a glazing tool usually supplied with points. Or use a putty knife as illustrated here. The trick is to push straight down, not at an angle. Prime frame with paint or linseed oil after the rabbit is cleaned.

edges of the glass and the frame for a slight expansion and contraction of the wood. About 1/16-inch, on four sides is about right.

Some glass is held in windows and doors with small strips of molding instead of glazing compound. In this construction pry out the molding—very carefully, with the tip of a putty knife or a stiff-bladed scraper.

If the molding is stubborn and you have room to insert the blades of two putty knives between the molding and the frame, use this trick: Insert both blades. Then insert the tip of a screwdriver between the blades and twist the handle of the screwdriver. The torque created by the screwdriver will pop the molding and the blades of the putty knives will protect the wood from damage. When the molding is off, pull any nails with pliers from the underside of the molding. Pull the nail heads right on through the wood. This way you won’t split the molding so it can be used again.

4 With linseed oil or a daub of paint, coat the window frame in which the glass will go. This will help protect the raw wood from moisture damage.

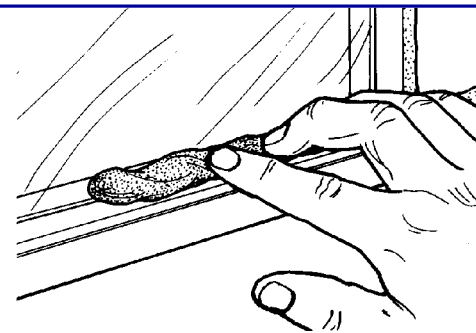

String out glazing in a rope shape and then press it into the window frame as this illustration shows. Then, with a putty knife, “bevel” the glazing into a 45-degree angle.

- 5 Fit the new glass in the frame.
- 6 Press in glazier's points around the glass into the wood. Space the points every inch or so. A metal glazing tool is usually furnished in the points' package. If not, use the tip of a putty knife to sink the points. But be very careful: easy does it.
- 7 Glaze the glass, using glazing compound. We've found the best way to handle glazing is to remove it from its container and wad it into a ball. Then, with you fingers, kneed it out into a roundish and long configuration—like a length of fat string.

With your fingers, press the fat string of glazing into the frame so the glazing rests on the frame and the glass. Holding a putty knife at about a 45-degree angle, press down on the glazing at a corner of the frame, and pull the knife across the glazing to the corner of the frame, maintaining the angle. Press down hard on the blade of the knife. You may want to extend your index finger down the blade to increase the pressure. Don't stop from corner to corner: one swipe. When finished, the glazing should be firmly packed in the frame with about half of the glazing on the glass and half in the frame. Let the job set for a week or so and then paint the window and glazing. Run about 1/8-inch of paint onto the glass to seal the glazing.

GLASS IN METAL CASEMENT WINDOWS

Casement windows are operated by a crank or via a lever-like length of metal that opens and closes the window. The glass panes in most casements are held in the frames with small wire clips; glazing compound fills the frames around the glass—just like on wooden windows. The procedure for replacing broken glass in casements is almost the very same as for wooden windows with a couple of minor exceptions.

- 1 Remove the broken glass.
- 2 Remove the glazing compound and the spring clips, using a putty knife and pliers, if needed. The little spring clips fit into holes in the metal frame. Usually, the clips pull right out, although you may have to give them some encouragement with pliers.
- 3 Measure the window frame—top to bottom and side-to-side—for the replacement glass. The new pane should be approximately 1/16 to 1/8-inch smaller on all four sides than the frame into which it will go.
- 4 Clean the frame, using steel wool or medium grit sandpaper to remove any glazing residue or rust from the metal. Then give the frame a coat of rust-preventative paint to protect the metal.
- 5 When the paint has dried, insert the replacement glass and secure it with the spring clips. Just press the clips into the little holes and position. Chances are that you will need several new spring clips because of rusting or damage when you removed the old ones.
- 6 Glaze the window, following the same procedures as for glass in wooden frames detailed before. Paint.

GLASS IN PLASTIC GASKETS

Horizontal sliding glass windows and some vertical sliders in combination with screens have metal frames—usually aluminum—with plastic-like inserts that hold the glass in the frames. These windows almost always have just one large piece of glass. If the window is separated into multiple panes, chances are that the “frames” are phony plastic or wood inserts that lay on the glass to give the appearance of multi-panes. You can remove the inserts by snapping them out of the metal (or sometimes wooden) framing material.

There are two types of gaskets. One type is fashioned to fit the edge of the glass; the glass rides in a groove, i.e., the plastic gasket. With the other type, the glass fits into the metal frame and the gasket material forms a seal between the glass and the frame.

In order to replace the glass, the frame or sash has to be removed from the window (sometimes a door). To do this, you slide the sash to a keyed opening along the edge of the track of the window and lift the sash up and out of the window channel.

Once out, you'll notice that the sash frame is held together with tiny screws driven into the top and bottom rails. Or, you may find tiny pins holding the frames together at the corner joints.

Remove just one screw (or pin) from the sash and pull the frame apart slightly. This should permit enough room to remove the old glass from the gasket or the gasket seal from the frame. If not, you'll have to disassemble another corner—maybe all four.

Once apart, remove all broken glass in the frame channel or groove and the gasket. Inspect the gasket for wear and tear; you may need to replace the gasket when you install the new glass.

Measure the window frame for the glass replacement. The new glass should be approximately 1/32 inch smaller than this measurement to fit properly into the groove or channel. Also, as a rule of thumb, if your measurement is 12 X 16 inches, buy single strength glass for the replacement. If the measurement is more than this, buy double strength glass. You need the extra strength for safety.

Insert the replacement glass in the groove in the plastic gasket, insert it into the frame (sash) of the window, and replace the screws or pins. If a glazing gasket is used, put the replacement glass in the sash and then press the gasket into the sash around the glass. Reassemble the frame with screws or pins.

A LITTLE MAINTENANCE, PLEASE

While you have the sash out of the window frame, we recommend that you take the opportunity and do some maintenance on the window (door).

With a vacuum or brush, clean out the window channel. Coat the channel with paste wax and buff the wax with a cloth. If the channel is really dirty, first clean the area with a vacuum or cloth. Then buff the channel with fine steel wool. Clean away the residue; wax and buff the channel.

If the channel is bent, you sometimes can straighten it with a rubber hammer. Place a block of wood in the channel where the window slides. Then tap the metal lightly with the rubber hammer to straighten.

If the weatherstripping on the window is shot, you can buy replacement weatherstripping and install it with a screwdriver, per instructions on the package.

GLASS IN JALOUSIE WINDOWS

Jalousie windows are made up of a series of glass slats that may be opened and closed via a crank operator (usually) along one side of the window area.

The glass slats are held in position in the assembly with tiny metal tabs that usually are simply bent over to hold the glass in position. The tabs may be located on just one side of the frame; the other side is “fixed,” i.e., the glass slat slides into this opening first.

To replace a glass slat, you have to bend the little metal tab on the frame. With pliers, bend the tab out and down so the glass slips out and in. Install the new glass and bend the tabs over again to secure it.

GLASS IN STORM WINDOWS

Storm windows in construction are very similar to sliding glass windows in that the glass is held into a metal (usually aluminum) frame with a plastic gasket.

To replace the glass, remove the screws or pins at the corners of the metal frame and pull the frame apart. The glass may go into a “channel” of the gasket, or the glass may fit into the frame and the gasket is pushed down and tight against the frame and the glass.

If the storm window is wooden, the glass usually is held in a groove in the frame (a rabbet cut) with glazier’s points and glazing compound. The procedures for replacing the glass would be identical to those detailed in wooden windows above.

INSULATING GLASS WINDOWS

As mentioned earlier, these windows and often sliding glass doors (patios), have two panes of glass separated by a metal channel which forms an air space between the glass. It is the same principle as putting storm windows over regular windows to create a dead air space, and, therefore, create a “thermal” window.

Often, only one pane of an insulated window breaks or becomes damaged in another way. Unfortunately, the entire unit must be replaced and this is costly. (In some construction, the builder may have created an insulated window by installing two panes of glass separated by a wooden strip. Here, only one pane of damaged glass would have to be removed and replaced since the window is not “laminated” as such.)

Since this window unit is so costly and usually very heavy in weight, we strongly suggest that you have a professional make repairs. If the window does not set correctly in its framework, a torque or twist can develop across the glass, breaking the glass again.

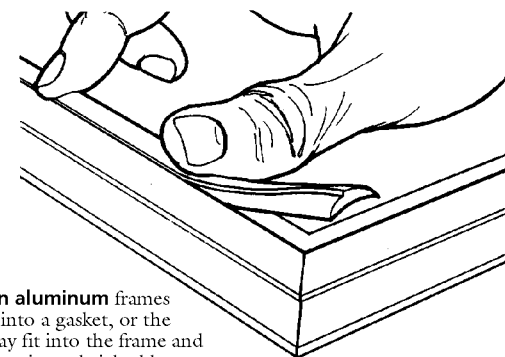

Glass in aluminum frames may fit into a gasket, or the glass may fit into the frame and the gasket is sandwiched between the frame and glass.

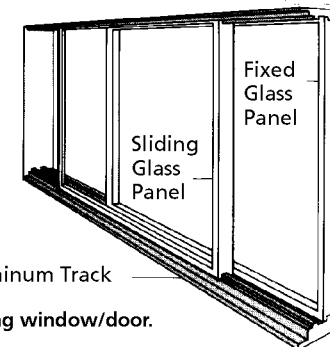

Anatomy of a sliding window/door.

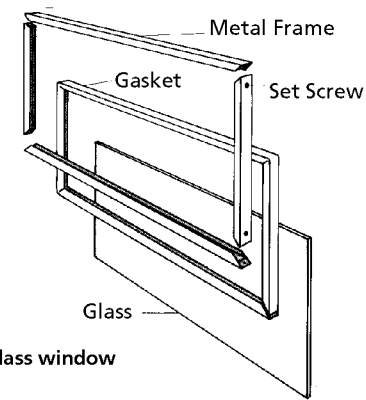

Anatomy of a fixed glass window