

FULL AUTO



Semi-Auto MAC 10 Modification Manual

1/1
2/1
3/1
4/1

21031001010101

NOTICE

The modification of any firearm to fire fully automatic is illegal without prior approval of the BATF. Also, the manufacture of a part or group of parts that, when installed in a firearm makes it automatic, is illegal without prior approval of the BATF.

Please be advised that the publishing of this book is for academic purposes only. The publisher assumes no responsibility or liability for the improper or illegal modification of a firearm.

Table Of Contents

Introduction	1
Full vs. Semi-Auto Function	3
Conversion Methods	21

Introduction

The "MAC 10" was designed by Gordon Ingram and bears the genius of the man. It is simple, compact, versatile, reliable and deadly.

The first production was undertaken by Col. Mitchell Wer-Bell via his company Military Armament Corporation; hence the abbreviation MAC. With the demise of M.A.C., R.P.B. Industries, Inc., purchased the company and at their bankruptcy, Wayne Daniel purchased R.P.B. and has kept the name, continuing to operate as such.

Quite candidly, the early MAC products are the most favorable as the quality control was more intensive. Not all present production guns function as flawlessly "out of the box" as did the M.A.C. products. The M.A.C. guns command a much better price as they are, indeed, collectors' items.

The Ingram system was, is and shall be, a machine pistol, designed for hip shooting and clandestine operations. Attempts to "sandbag" or "machine rest" test the weapon are undue. The gun was never designed to perform match functions. The sights exist to attach a carrying sling! The author could only suggest the use of the sights with a 16" carbine version of the gun, and then with stock and bipod. However, he has fired *many times* at ranges from 30 to 60 feet in the prone position with a selective fire Ingram in semi-auto and achieved 10 round groups of not more than 6". The weapon can be successfully "point fired".

FULL AUTO III

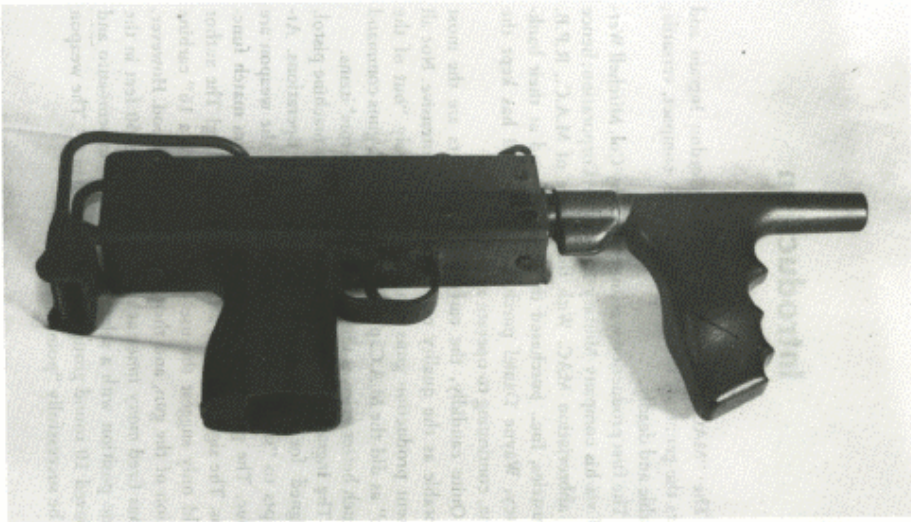

Pre-1972 MAC 10 from the author's collection. Note cast, position-adjustable hand grip.

2

Full vs. Semi-Auto Function

To convert a semi-automatic Ingram to fire fully automatic, it is essential to understand the function of both the full auto and the semi-auto models. The difference is amazingly simple and you will be taken through the steps of the function, somewhat laboriously only to educate you.

FULL AUTO FUNCTION:

Cock the bolt open until it latches.

If the weapon is on safe, with the bolt cocked, release the safety.

Pull the trigger.

The bolt will travel forward, stripping a round from the magazine. It pushes the round into the chamber simultaneously igniting the primer. The front left side of the bolt lightly touches the trip, but due to the selector on full auto the trip does not disengage the disconnect on the trigger from the sear.

The bolt is driven to the rear where the ejector rod expels the spent cartridge and reaches its most rearward movement against the buffer pad in the recoil assembly.

The stored energy of the compressed recoil spring now drives the bolt forward again to repeat the cycle until the shooter's finger is released.

DIFFERENCES IN CYCLING:

With the weapon in semi-auto or with the semi-auto only models, the bolt ignites the cartridge and at the same time

3

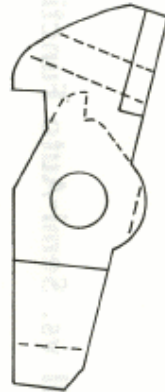

SEAR

The sear is a small, curved component that is mounted on the trigger guard. It is responsible for holding the trigger in the cocked position until the trigger is pulled. The sear is made of steel and is hardened for wear resistance.

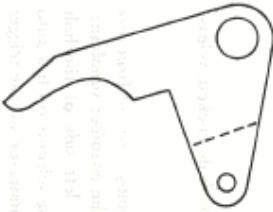

TRIGGER

The trigger is the main component that is pulled by the shooter. It is made of steel and is hardened for wear resistance. The trigger is mounted on the trigger guard and is connected to the trigger mechanism.



TRIP

DISCONNECTOR



TRIGGER MECHANISM PARTS

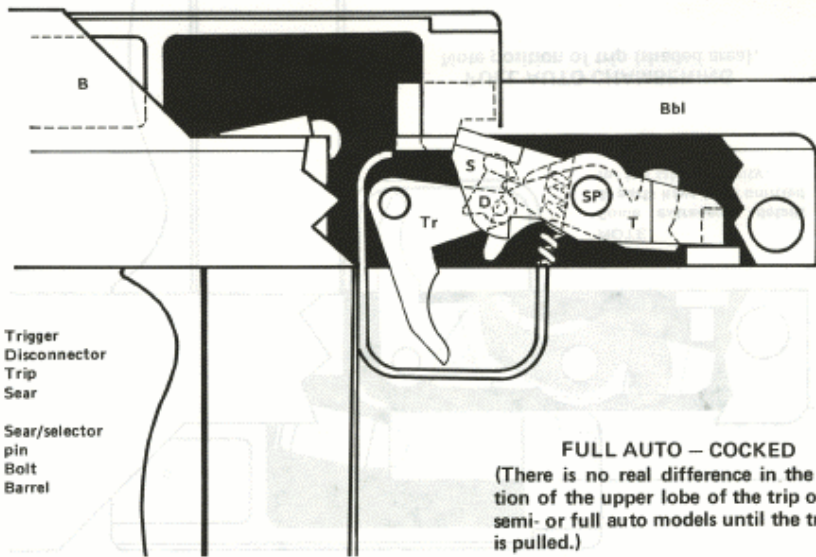

- T: Trigger
- D: Disconnector
- T: Trip
- S: Sear
- SP: Sear/selector pin
- B: Bolt
- BBl: Barrel

FULL AUTO - COCKED
 (There is no real difference in the position of the upper lobe of the trip on the semi- or full auto models until the trigger is pulled.)

6

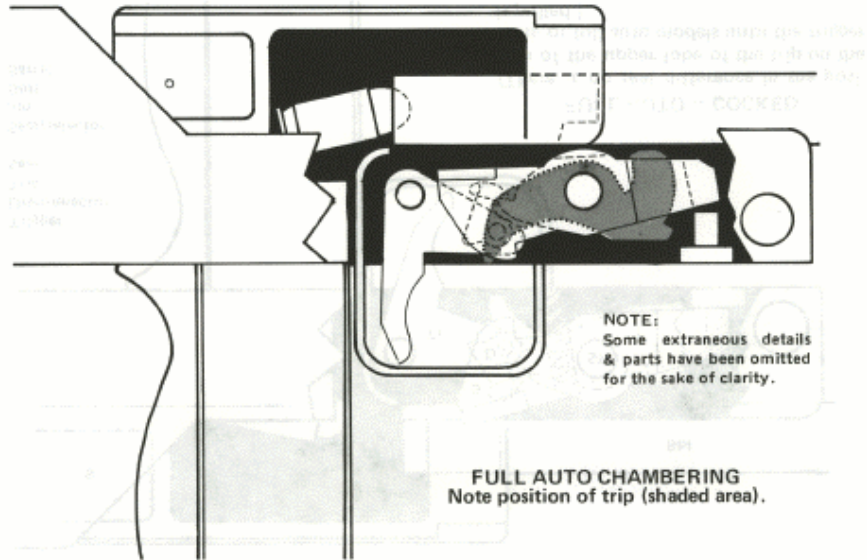

7

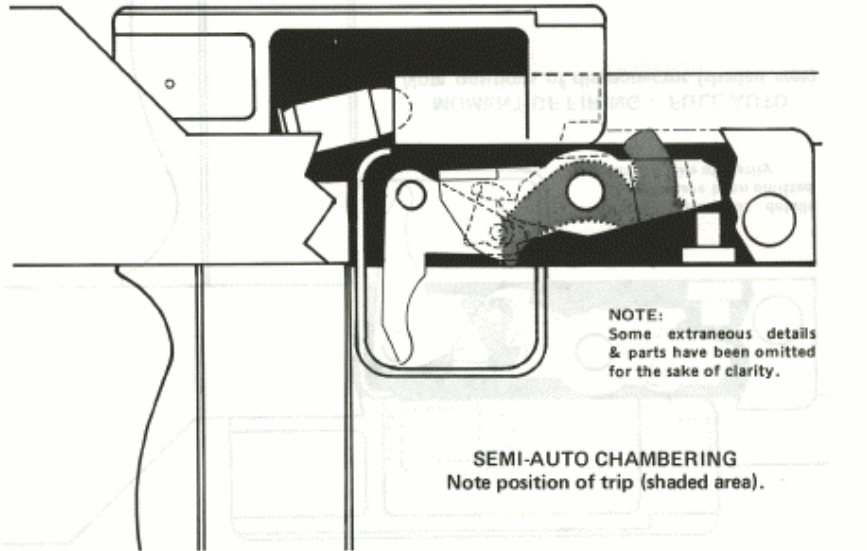

8

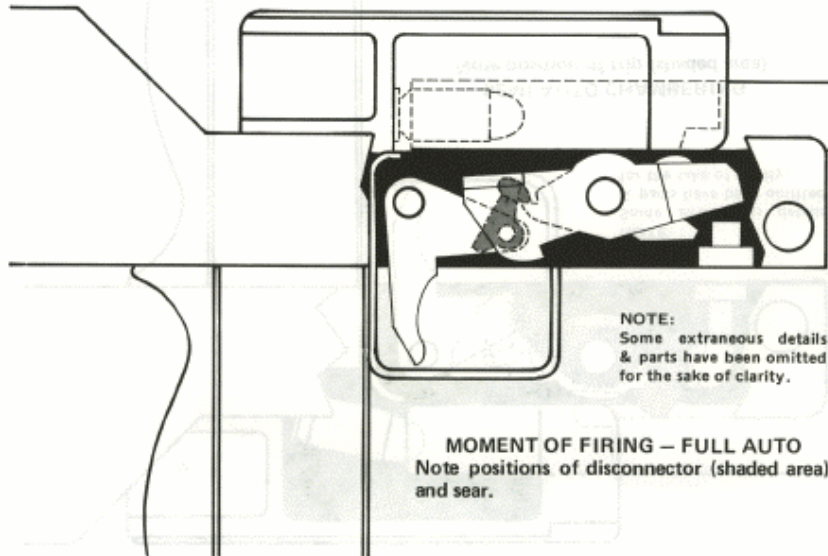

9

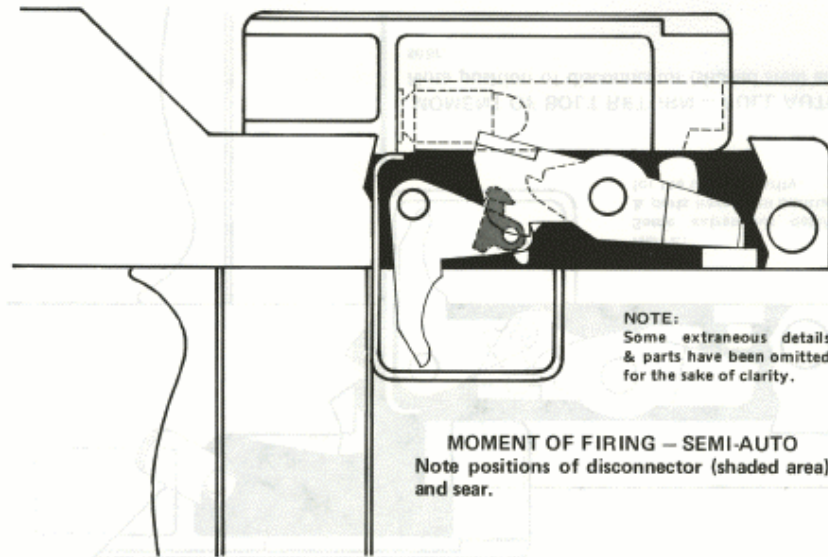

10

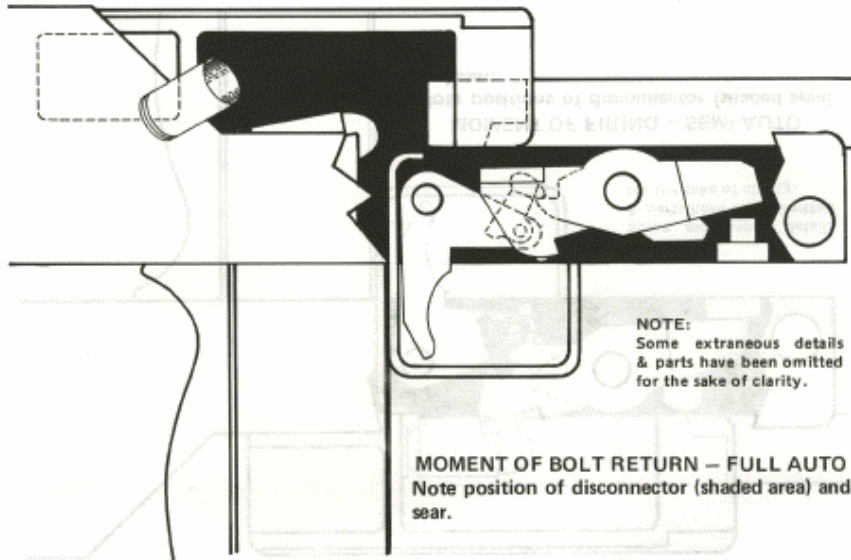

11

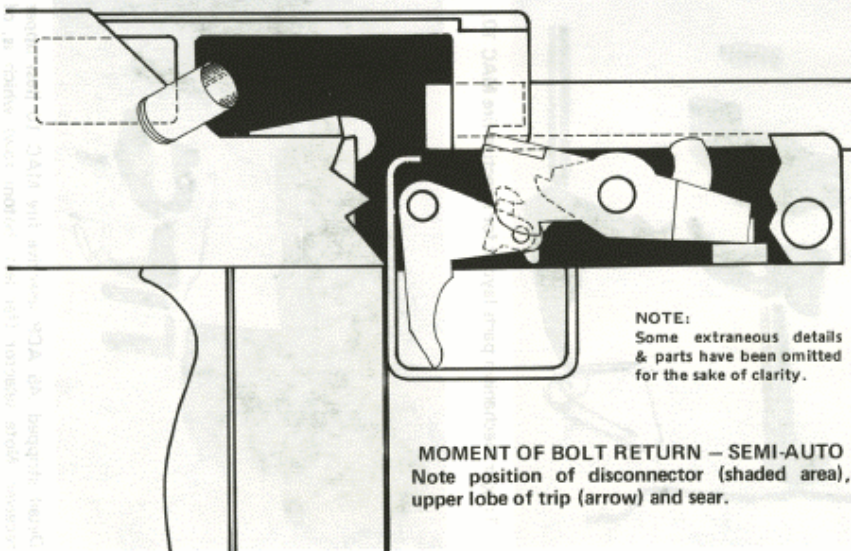

11 OF MAC 10

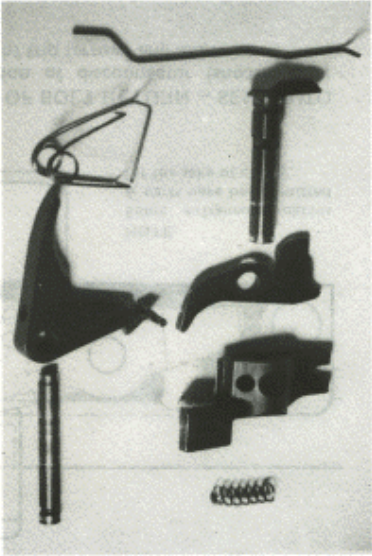

Trigger mechanism parts layout for selective fire MAC 10.



Detail stripped .45 ACP selective fire MAC 10 (less upper receiver. Note selector (far left, bottom row) which is, of course, non-existent in semi-auto model.

12

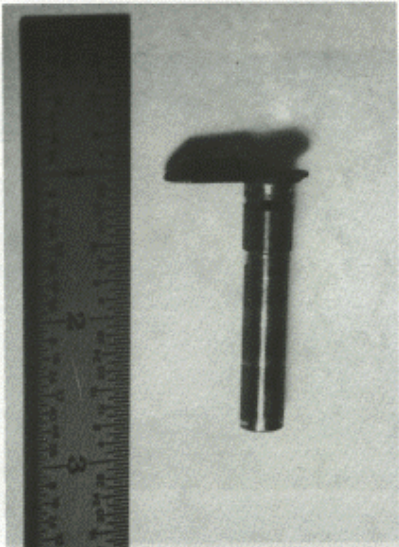

Selector for full auto MAC 10 in semi-auto position.

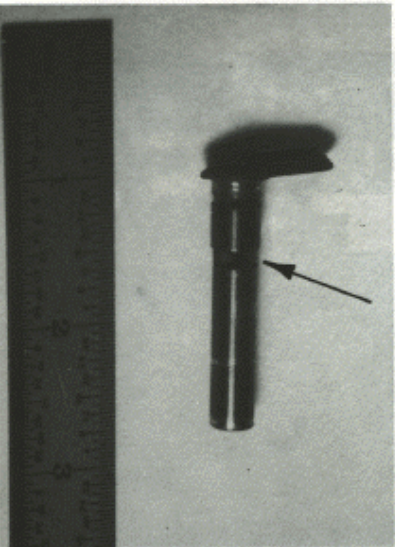

Selector in full auto position. Note appearance of the trip slot (arrow).

13

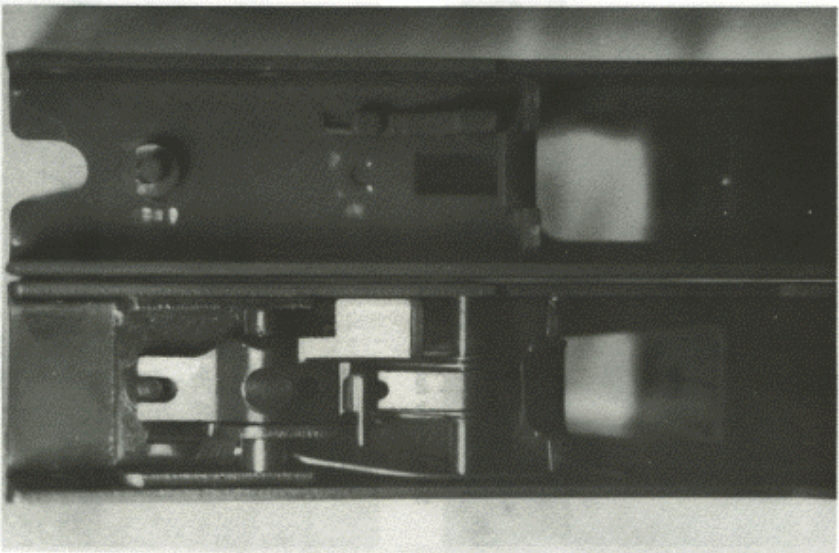

Stripped full auto .45 lower receiver at left, semi-auto 9mm on right. Note feed ramp and semi-auto carriage differences.

14

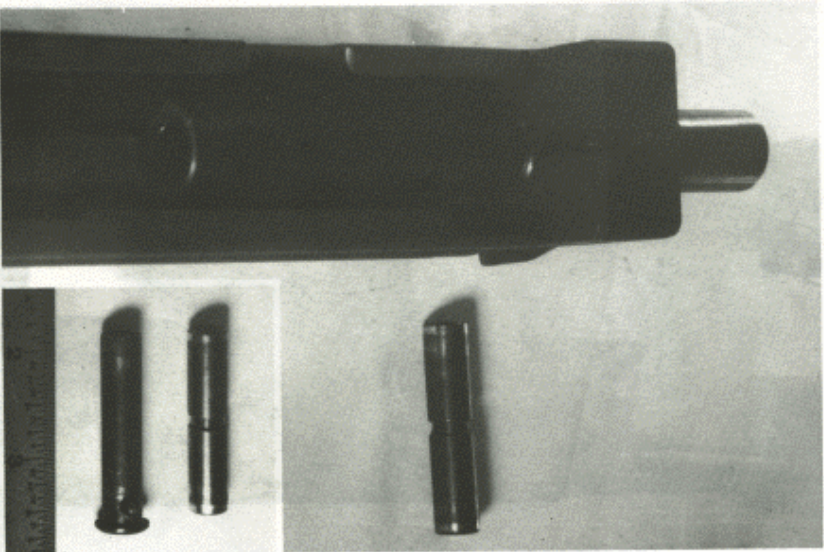

The pre-1972 MAC connector system is shown in the full page photo above. In the inset, this far superior connector is shown above the newer style currently used.

(Bright Stock)

15

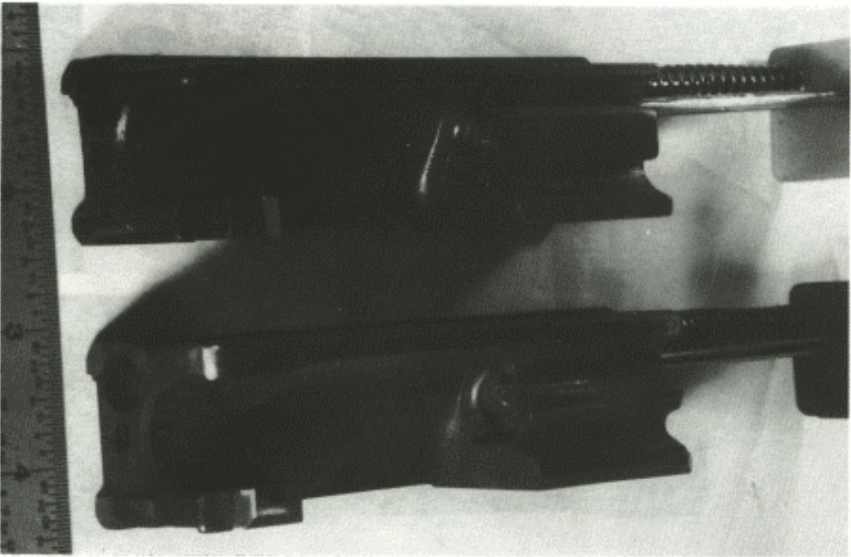

9mm MAC bolt (left) is shown for comparison with .45 ACP bolt (right).

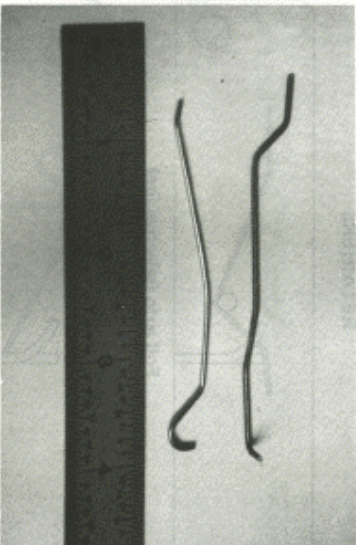

The selective fire version of the retainer spring is shown at the top, while the lower retainer is for the semi-auto model.

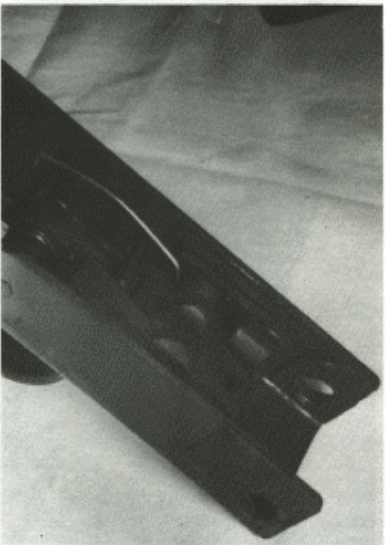

The semi-auto retainer spring mounting position is shown in the above photo. Note differences in retainer spring shapes in top photo.

RETAINERS

Full auto (selective fire)



Semi-auto

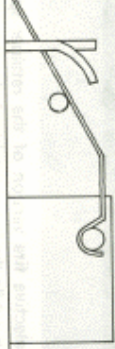

contacts the upper "lobe" of the trip, which in turn releases the disconnecter from the sear it is holding down. The sear, driven by the compressed sear spring, now returns to the "stop" position.

The difference in the selective fire version is that a slot in the selector lever allows the trip to fall below any strong contact with the bolt in its forward-most travel, allowing fully automatic function. The semi-auto model, of course, has no provision for such selection.

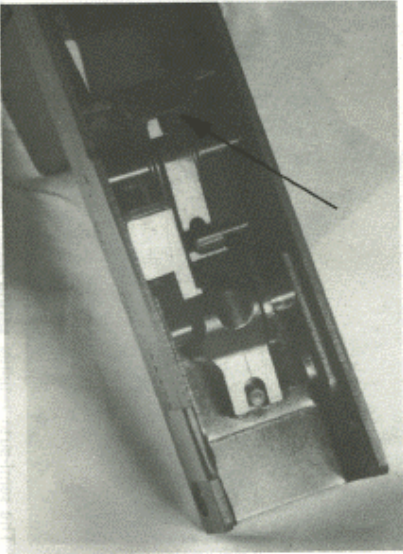

Trigger mechanism of semi-auto MAC 10 located in lower receiver. Note the 9mm feed ramp (arrow).



Conversion Methods

There are 7 different methods of converting a semi-auto Ingram to full auto function. However, there is only *one* (1) reasonable means of converting a semi-auto to *selective* fire, that is, changing back and forth from semi- to full auto without disassembly of the weapon.

First, we will cover the "crisis methods" of full auto conversion.

The first "crisis method" is the trip modification. Using a hacksaw or Moto Tool and its separating disk cutter, slice away the upper contact lobe of the trip (Figure 1). The weapon will now function fully auto *only*. While it may be difficult to convince authorities that the gun got caught in a hand saw, in a time of civil distress close area denial (the true purpose of this weapon) is most certain.



Figure 1
TRIP MODIFICATION

The second "crisis method" is modification of the disconnecter.

It is important here to pay close attention to measurement (Figure 2). The disconnecter activation bar is cut, clipped or broken just before it contacts the trip. A small groove is cut or filed for the trigger spring finger to keep it against the remaining piece of activation bar (Figure 2).

Please be advised that the weapon will also only function fully automatic. However, it may be easier to convince whoever that it "broke".

Fortunately, the disconnecter can be replaced if paranoia persists (more easily on the 9mm than the .45 ACP, which requires some cutting). The trip, however, is held captive in the semi-auto model by the "semi-automatic carriage", an extra piece of metal placed in that system to prevent removal of parts for conversion. It is this piece of metal that the BATE relies upon to insure that the function of the weapon will remain semi-automatic. (It can be removed by drilling out the welds in the bottom of the lower receiver.)

The next method is borderline between being premeditated and crisis conversion. It only requires a grinder or hacksaw and vision:

Remove the bolt from the weapon and turn it upside down. Look at the muzzle end on the right side (Figure 3). The shiny long spot is where it contacts the trip (see photo at top of page 24), disabling the disconnecter. Add 1/8" to the shiny spot (approximately 5/8" overall) and remove the entire distance for a depth of approximately 5/32". Removing even more won't matter. It may speed up the cycle, though however unnoticeably!

This method is favored by the most cautious, as extra bolts are not very difficult to obtain and at the time of this writing will vary in price from \$60.00 to \$100.00. The bolt

- S - Sear
- T - Trip
- D - Disconnecter
- Tr - Trigger
- P - Pins

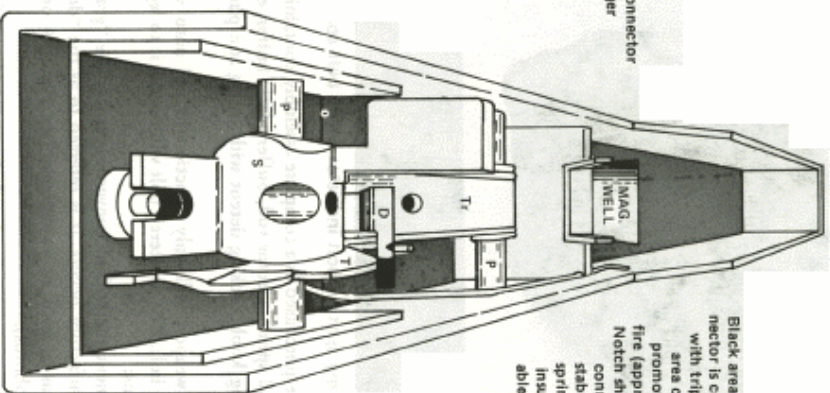

Black area on disconnecter is contact area with trip (T) and is area cut away to promote full auto fire (approx. 5/32"). Notch shown in disconnecter is to stabilize trigger spring finger to insure dependable operation.

Figure 2
DISCONNECTOR MODIFICATION

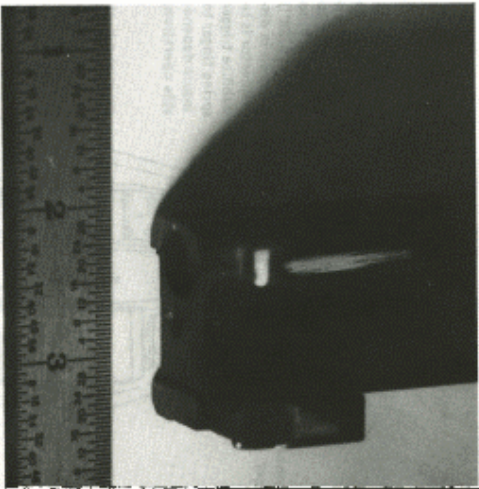

Worn, shiny spot on bolt indicates where bolt contact should be purchased as a complete assembly containing rod, recoil spring, ejector rod, buffer plate, buffer, cocking knob, locking detent with spring and pin 3).

The weapon will only function in full auto when modified bolt. The unaltered bolt will restore it to legal auto status;

The next method of conversion enters the "gray" as remanufacture occurs. It is referred to as the "do-it-yourself" method as a favor to its designer (see Figure 4 or accompanying photos).

The lower receiver is placed on a solid block of wood and an anvil with the trigger guard area pressed tightly against the square edge. A 1/4" cold chisel or sharpened screw

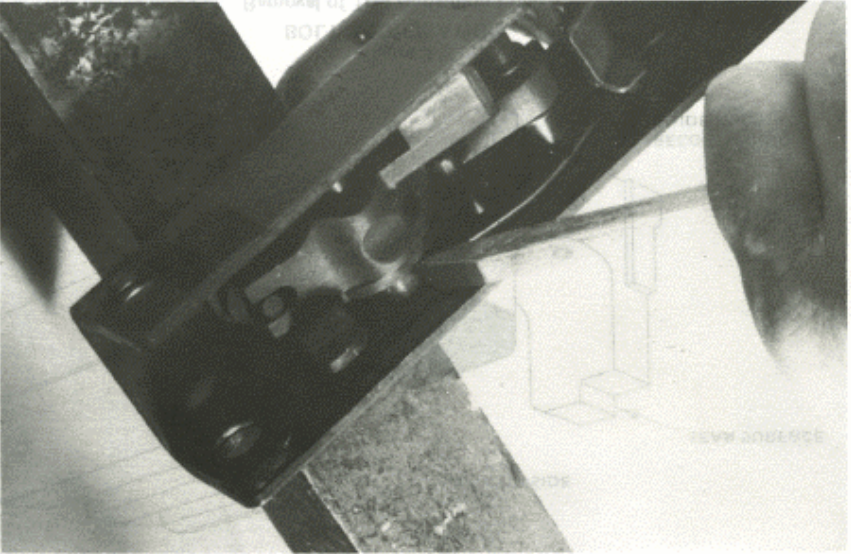

Splitting the bushing for the "doctored" method of converting the semi-auto MAC 10 to full auto.

26

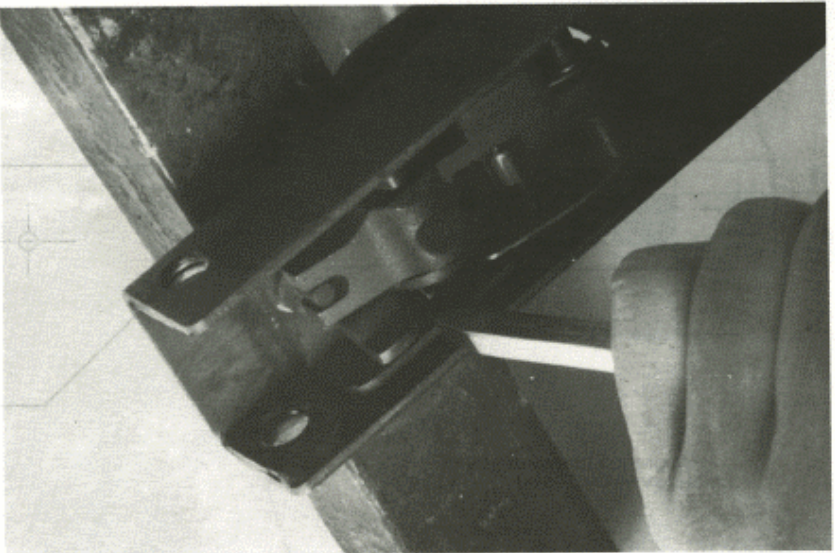

Cutting clearance for upper lobe of the trip so that it can be moved against the outside flange, out of the path of the bolt as illustrated in Figure 4 and described on page 29.

27

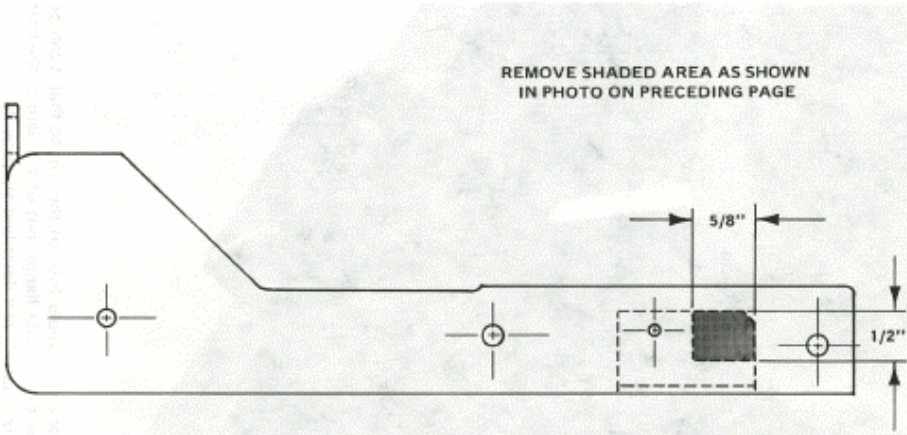

Figure 4
"DOCTORED" METHOD SEMI-AUTO CARRIAGE CUT



Figure 5
UPPER RECEIVER CLEARANCE CUT

of suitably hard metal is used to slice through the bushing surrounding the trip retaining pin. The severed bushing is then pried out of the assembly.

The retainer spring holding the trigger pin in place will determine the position of the trip.

The same cold chisel can be used to cut a relief in the semi-auto carriage as shown in Figure 4, or any electric or air driven hand tool such as a Moto Tool can be used. This relief must be as deep as the bottom shoulder of the upper lobe of the trip. Next, cut an appropriate clearance in the upper receiver as shown in Figure 5. This cut is in the bottom left side of the receiver and is for the upper lobe of the trip so the bolt may clear it. Cut the metal down flush with the inside dimension of the upper receiver.

The retainer spring is now positioned to hold the trip out of the way of the bolt as it travels forward. A piece of spiral notebook wire, carefully rewound, or a light gauge spring between the trip and the sear may assist in keeping the trip to the left. A *slowing* in cyclic rate may occur.

The last "gray area" modification is one of the author's own design, and there is a patent pending on it.

Though it is not entirely necessary to remove the trigger/disconnector assembly, it greatly aids production. The 9mm

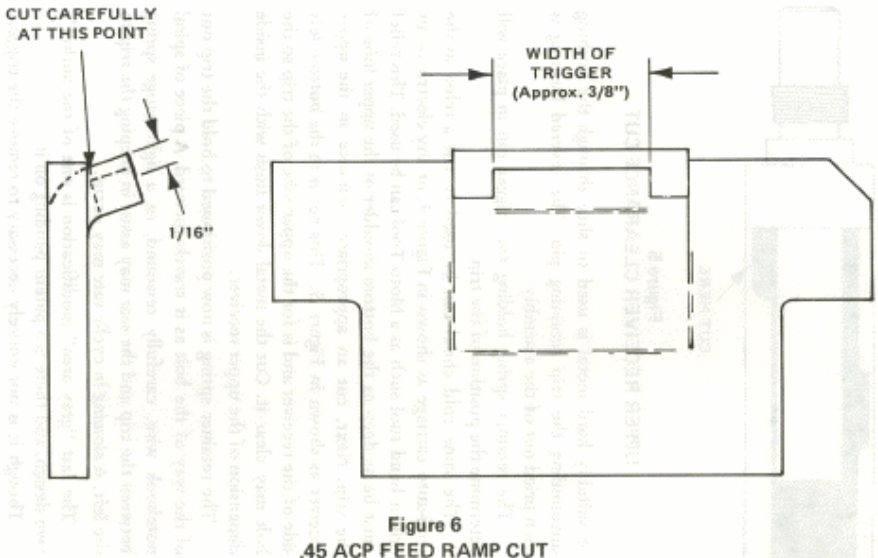

Figure 6
 .45 ACP FEED RAMP CUT

models will not be a problem. However, the underside of the feed ramp on the .45's will usually require that an area be cut for a relief to remove the trigger assembly (Figure 6). Care must be taken not to cut through the upper surface of the feed ramp. Then, with the trigger pin removed, depress the sear by hand, pull the front nose of the trigger up over the sear engagement surface area and push it up and out of the lower receiver.

Using a Moto Tool with separating disk or a hacksaw, remove the right side area of the disconnecter (opposite of the trip activation bar) even with the side of the stem connecting to the trigger. A touch of cold blue will restore the color to match the original finish. Touch up the underside of the feed ramp as well.

Secure the trigger in a vise and mark a center line midway between the yoke and the leading edge. Punch with a center punch, then drill a No. 36 hole (a 1/8" drill can also be used) 3/16" to 1/4" deep. Tap the hole with a No. 6-32 tap. This hole will accommodate the same size electrical screw which is normally used to secure a switch or outlet to a fixture box.

After removing most of the cotton from a Q-Tip, dip it in cold blue and run it into the newly tapped hole to match the original finish. With care, the finished product will appear to be factory original. However, as yet you have done nothing that will make the weapon fire other than in semi-auto mode.

Replace the trigger/disconnector assembly in the lower receiver of the gun. It may be necessary to depress the spring-loaded safety a bit to get the trigger pin in place.

Next on the agenda is construction of the auto sear itself. The material required is simply a piece of common 1/8" flat stock. Place it in a vise and, using a hacksaw, cut out a piece as shown in Figure 7. Dimensions are roughly 3/8" wide x 1" long. The stem portion is as wide as it is thick.

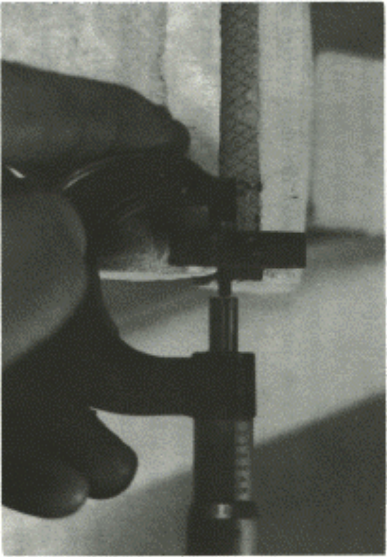

Measure before cutting the right side area of the disconnect. Note the micrometer reading of .600".

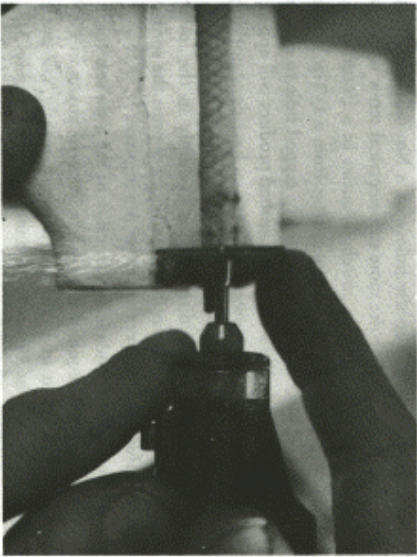

Cut the disconnect as described in the text.

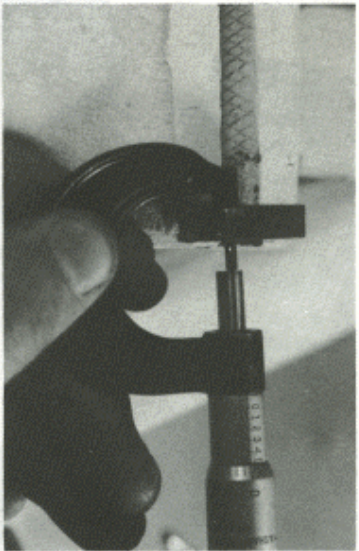

After cutting, the micrometer reading should be .500".

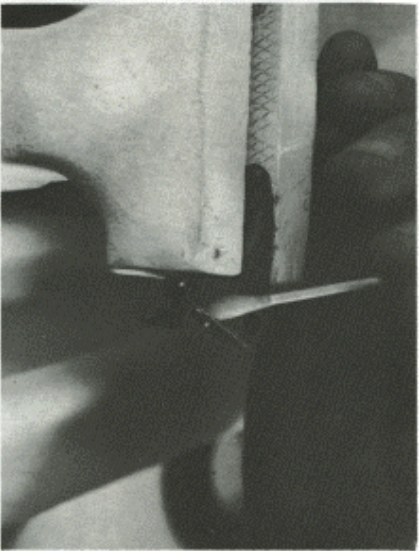

Use cold blueing to match the original color on the disconnect after cutting. The cut in the feed ramp should also be touched up.

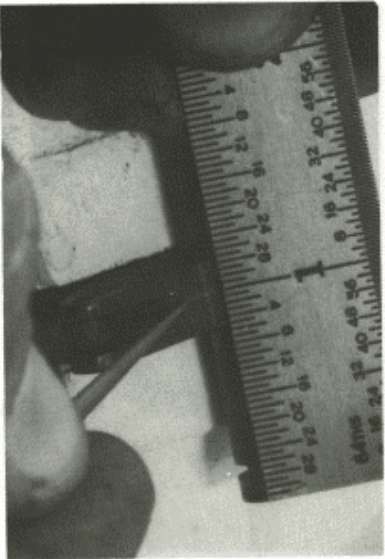

Mark center line for drilling on trigger, midway between the yoke and the leading edge.

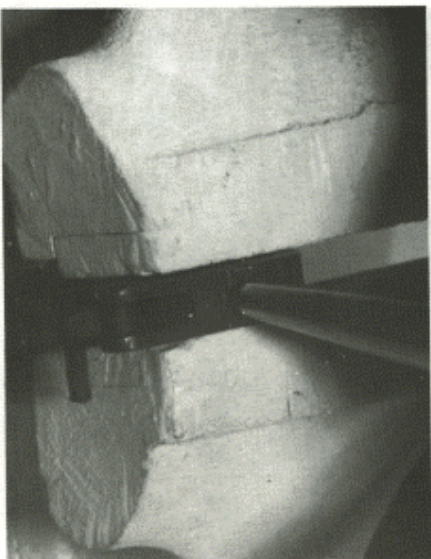

Punch mounting hole location with center punch.

34

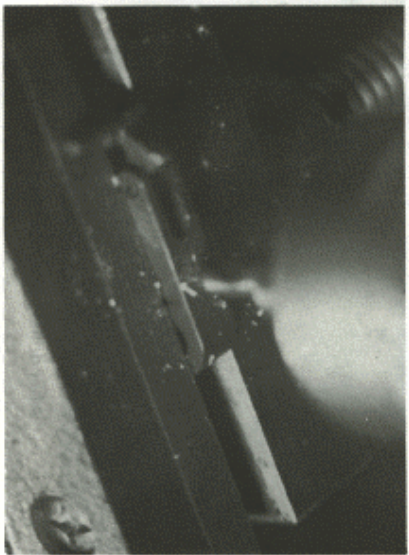

Index mounting hole.

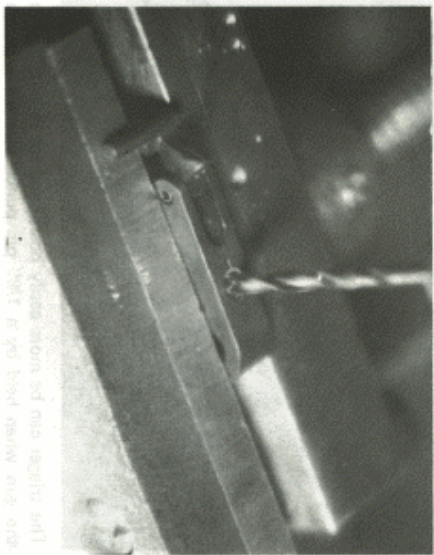

Drill mounting hole.

35

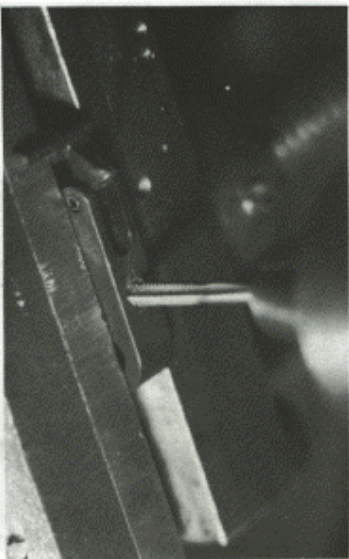

After drilling, tap mounting hole.



The trigger can be more easily positioned for re-installing in the gun when held by a 1/8" pin punch inserted into the auto sear mounting hole.

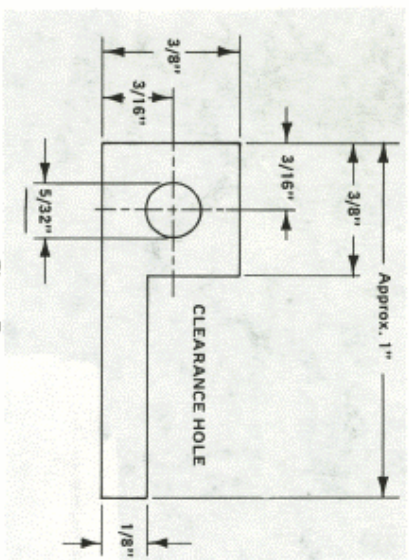
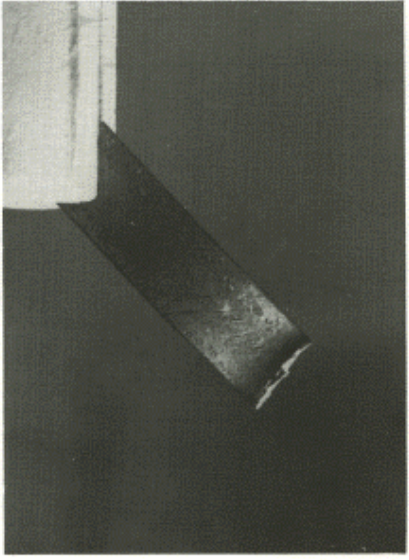

Figure 7
AUTO SEAR CUT FROM 1/8" FLAT STOCK

However, it can be narrowed to fit the clearance cut in the disconnecter. The bends in the stem of the unit are necessary to adjust to the rise of the sear shelf on the sear unit itself. A rule of thumb is that the bend should raise the reach of the stem approximately its own width, or roughly 1/8". If the bend rise is made higher, there is no problem. The unit will still work. Simply bend the forward area of the stem downward more. It is important to observe when installing the auto sear screw that it doesn't pull the sear out of its normally released position. The bolt must lock open in the cocked position.

Drilling the auto sear for the mounting screw is best accomplished prior to bending the stem, especially when using a drill press vise and drill press. A No. 3 indexing bit will countersink the hole adequately. The shoulders of the bit should just break the surface of the metal. Recutting the

FULL AUTO III



The beginnings of an auto sear. Any 1/8" thick flat stock will do as long as there is enough material from which to cut the auto sear.

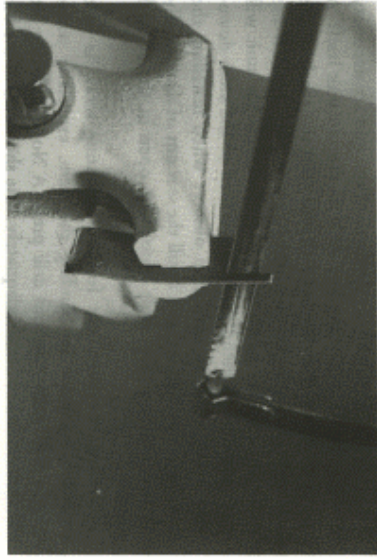

The stem should be cut into the blank first.

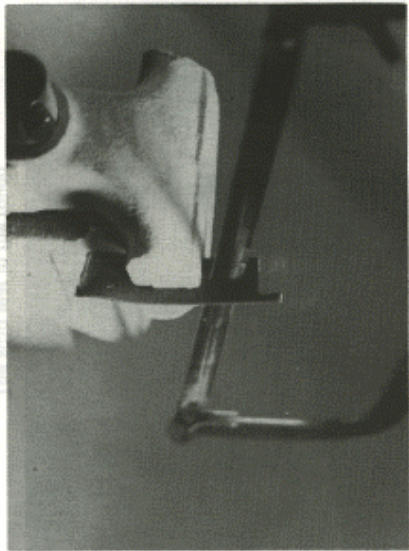

The second cut is for the body width.

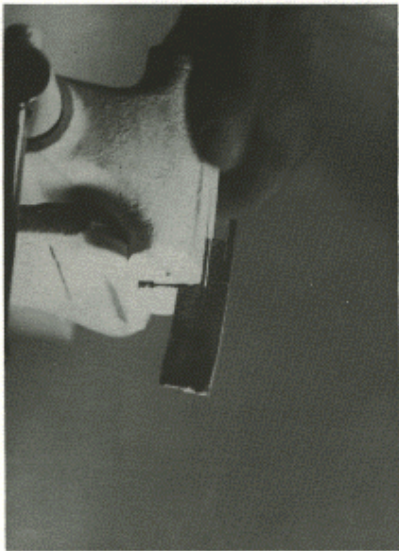

With the stem and body width cuts completed, the auto sear blank is cut to length (arrow).

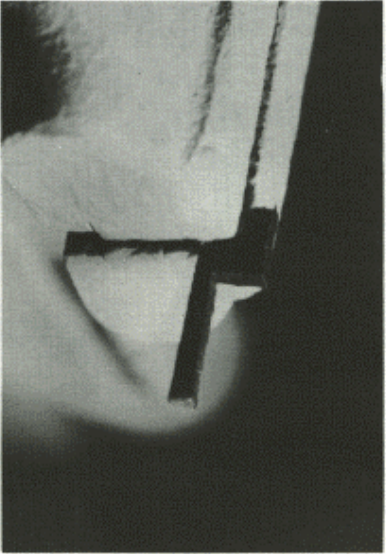

The auto sear in the rough.

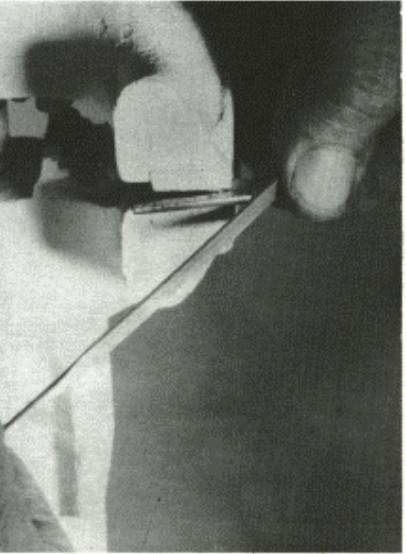

Smooth out the cuts and round off the edges of the auto sear with a fine toothed file.

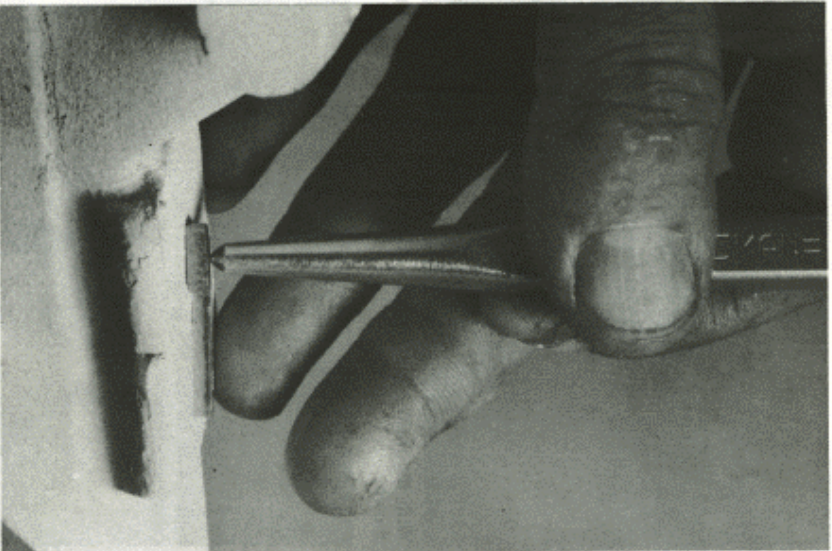

Center punch the auto sear for the mounting hole. Dimensions are given in Figure 7 on page 37. After drilling hole, counter-sink for head of electrical screw.

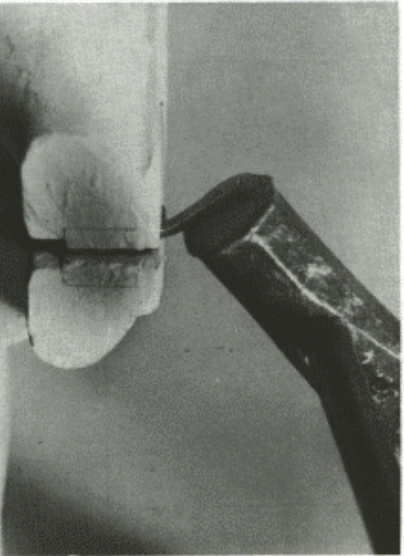

With the main body clamped into a vise, bend the stem as shown.

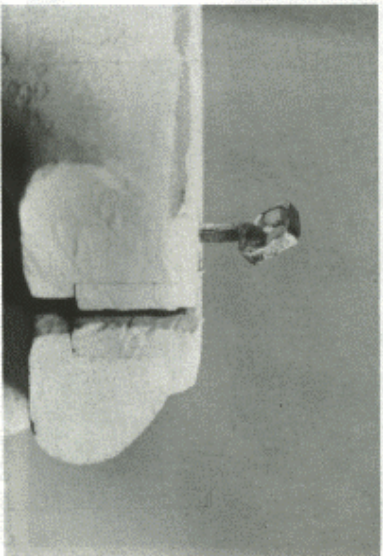

With the end of the stem clamped into the vise, the auto sear is ready for the second bend.

42



Auto sear after the second bend in it has been made. Except for trimming the stem to fit (see text) and bluing, it is finished.

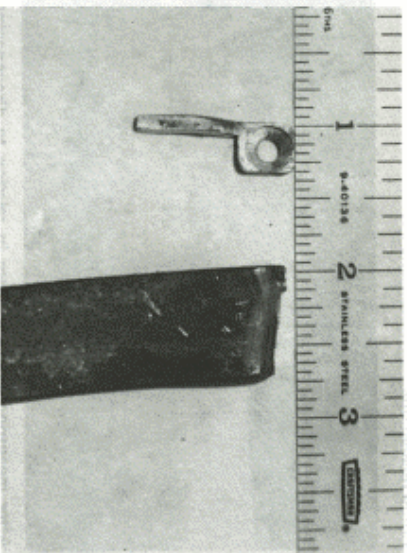

Finished auto sear with original rough stock.

43

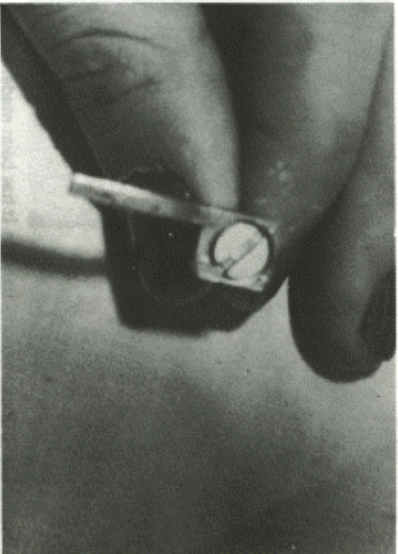

Note flat headed screw used to attach auto sear to trigger. It is imperative that a flat headed screw be used, and not a round headed one.



After measuring length of stem in relation to disconnector contact surface on secondary sear, trim stem to proper length.

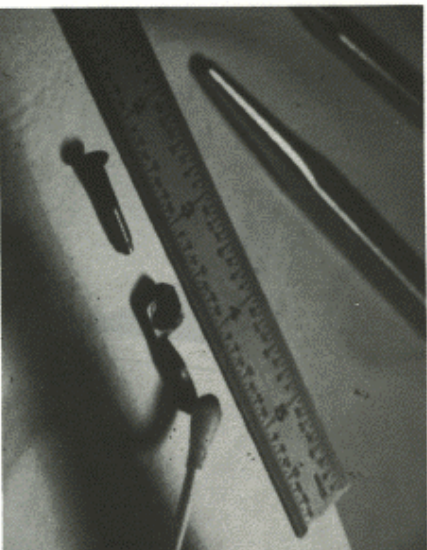

Although not essential, it is advisable to blue both the auto sear and its mounting screw. In addition to helping protect the metal, bluing will give a "factory original" appearance to the untrained eye. The screw shown above will be shortened before installation of the auto sear.

countersink with a 5/16" or 11/32" drill bit puts a nice finishing touch at approximately the same angle as the head of the electrical screw to be used.

It is vital that the mounting screw hole be countersunk in the auto sear, as what you are now doing is cutting a clearance for the barrel. It is also critical to use a flat headed screw such as the electrical screw described. A round headed screw could possibly cause the trigger assembly to wedge/jam against the bottom of the barrel until all ammo is exhausted. Of course, this only takes 1 1/2 to 2 seconds!

After forming the auto sear, mount it to the trigger as shown in Figure 8. Mark the stem where it reaches the back

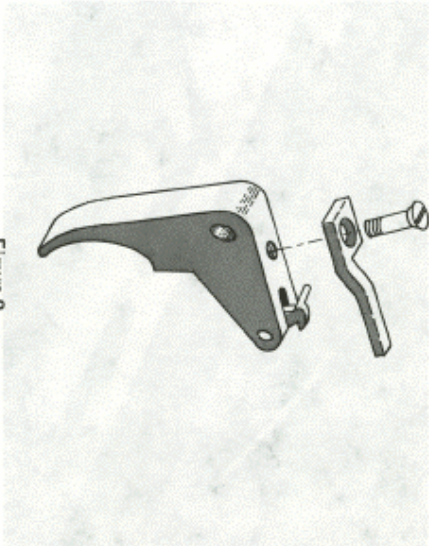

Figure 8
MOUNTING THE AUTO SEAR TO THE TRIGGER

of the disconnect contact point on the secondary sear, then remove the auto sear and trim to length. This is important to insure that the trigger does not jam the weapon just as the wrong mounting screw might do. Polish the auto sear lightly with 200 to 300 grit emery cloth. When it appears totally silver, drop it in the cold bluing solution for a color match.

One little extra touch for storage is to drill and tap a 6/32" hole approximately 3/8" behind the magazine well, in the center of the receiver. Be careful not to drill through the plastic grip! When not in the full auto configuration the sear can be carried completely out of sight *right inside the gun!* (With practice, it takes less than 20 seconds to disassemble the gun, install the auto sear and reassemble the gun.)

What shall be covered next is plain and simple, *total breach* of the law, entirely premeditated. Actual accomplish-

ment of the following procedure is a direct violation of Federal law, and as such makes you liable for illegal manufacture of an automatic weapon. This could result in a maximum \$10,000 fine and 10 years in prison, unless compounded also by possession! Although the actual conversion is illegal without prior BATF approval, the *knowledge* of how to do it is perfectly legal, to be stored away "just in case".

Total breach is the act of converting a semi-auto Ingram model to selective fire, just like the original MAC products. The main talent that it takes to accomplish this is the ability to measure, add and subtract. It also helps to know how to read a machinist's drawing, as one is included for both the MAC 10 and 11 (portion dealing with auto sear hole placement) in this chapter.

Dial vernier calipers are best for measuring, although any accurate measuring instrument is sufficient. Remember that center to center measurement of holes requires measuring outside to outside, then subtracting half the diameter of each pin.

It is not at all necessary to have a machinist's drawing to properly locate the selector lever. Remove the upper receiver from the lower, then replace the front receiver pin with a piece of 3/8" round stock polished slightly undersized (.005" to .010" under). A 3/8" drill bit will usually also fit. Measure inside the lower receiver from the front edge of the 3/8" pin to the rear of the bushing surrounding the sear pin between the left side of the receiver and the trip. Subtract from this half of 3/8" (.375" \div 2 = .188") and half of the bushing diameter, which may vary slightly from gun to gun. It usually holds at about the same as the front pin (.375"). You now have the center to center measurement from the front upper receiver pin to the sear pin location. Let's now transpose that to the outside of the receiver.

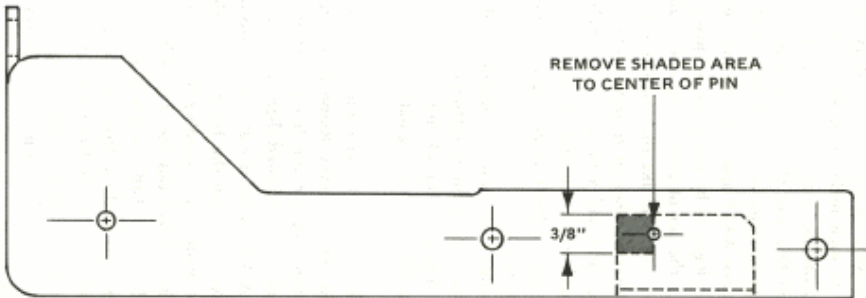

Figure 9
CUTTING SEMI-AUTO CARRIAGE TO ACCOMMODATE FULL AUTO RETAINER

It is easiest to make the transition by subtracting only half of the scar pin diameter from your total measurement, then using the calipers on the outside of the receiver, measure from the front of the upper receiver pin to the distance set on your calipers and scratch a light line through the approximate center of the pin area on the outside of the receiver. We have now established the vertical registry.

Next is horizontal registry. It is accomplished by measuring from the upper edge of the receiver to the top of the bushing. Add 1/2 of the diameter of your original bushing diameter measurement to this reading and once again scratch a light line crossing the last. The intersection is absolute dead center on that scar pin.

Now do the same procedure on the opposite (safety) side of the receiver. Carefully center punch the receiver lightly at both intersections and "pilot" drill the initial holes. *Never, under any circumstances, attempt to drill the entire hole strictly from a center punched mark.* There is just no way that the drill bit will stay on the mark!

It is best to begin with a small indexing drill, preferably a No. 1 or 2. Next drill a 1/16" hole and graduate up 1/16" at a time. The finished dimensions of the actual selector pin are not the same. The hole on the trip side (left) is .345". For those not having a full machine shop at their disposal, the .345" diameter can be finish drilled with an 11/32" drill bit and carefully hand fitted with a Swiss needle round file (it won't take much). The .312" hole on the right side of the receiver is, in fact, 5/16".

Both holes should be step drilled up to 9/32". At this point *stop*. Recheck which side is which and then, when positive, proceed to finished hole sizes. At this point the left side flange of the semi-auto carriage can be cut away laboriously with a single hacksaw blade (with half its width cut

FULL AUTO III

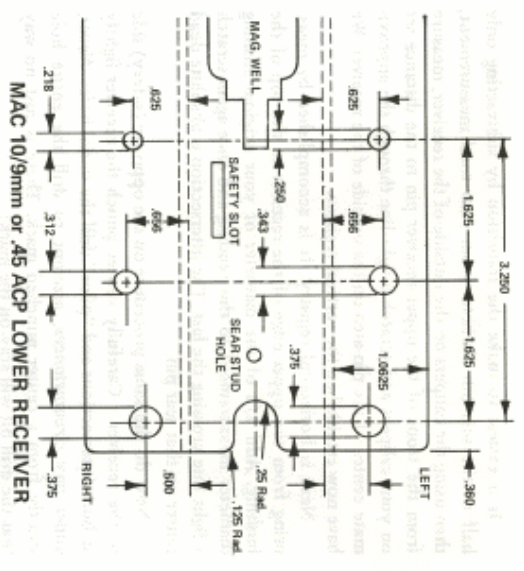

MAC 10/9mm or .45 ACP LOWER RECEIVER

away to make it thinner) wrapped in tape for a handle (Figure 9). Only the trip side of the semi-auto carriage needs to be cut off. This leaves room for the full auto retainer to lock the selector in the chosen position. Failure to install the full auto retainer properly will possibly (probably) cause the selector to vibrate loose and ruin a lot of fun (not to mention the possibility of destroying your operation)!
 It is important to note that the semi-auto retainer mounts opposite of the full auto retainer. The latter must be in place before inserting either the trigger pin or the selector. It mounts under the trigger pin and over the selector (see drawing on page 18). The pressure of the upper receiver on the forward end of the retainer supplies the necessary locking pressure.

MAC 10

The last method of creating a full auto Ingram from a semi-auto is entirely legal, though at best a difficult method. The only equipment needed is a reloading system!
 The bolt of an Ingram can be drawn far enough to the rear to successfully pick up and fire a round without coming into a locked-up cocked position. The bolt is in fact roughly 1.00" (1/8") shy of locking cocked.
 Experimentation will show that "short loaded" ammo will cause the weapon to function upon firing, but not far enough to catch on the sear. Theoretically, ammo can be loaded "short" enough that the gun will function upon firing only far enough to pick up another round, yet not far enough to lock on the released sear. Then a desired burst, say four

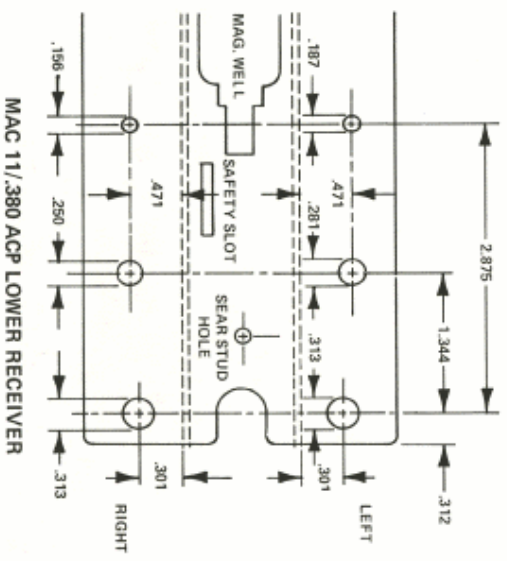

MAC 11/.380 ACP LOWER RECEIVER

rounds, may be placed on top of one properly loaded "hot" round. Upon firing, the gun will run through all five with the "hot" round locking the gun open properly.

The idea is to load the ammo just hot enough that the gun will eject the fired casing, recoil enough to pick up a live round and continue to do so until it picks up the "hot" round and is blown back to lock. A friend experienced this phenomenon with Remington-Peters 125 gr. soft point 9mm ammo. Had he used a different lubrication or polished the bolt, it is possible it would not have occurred. Some of the early MACs, properly polished, would function with sub-sonic 9mm ammo.