

# Expedient Homemade Firearms

## The 9MM Submachine Gun

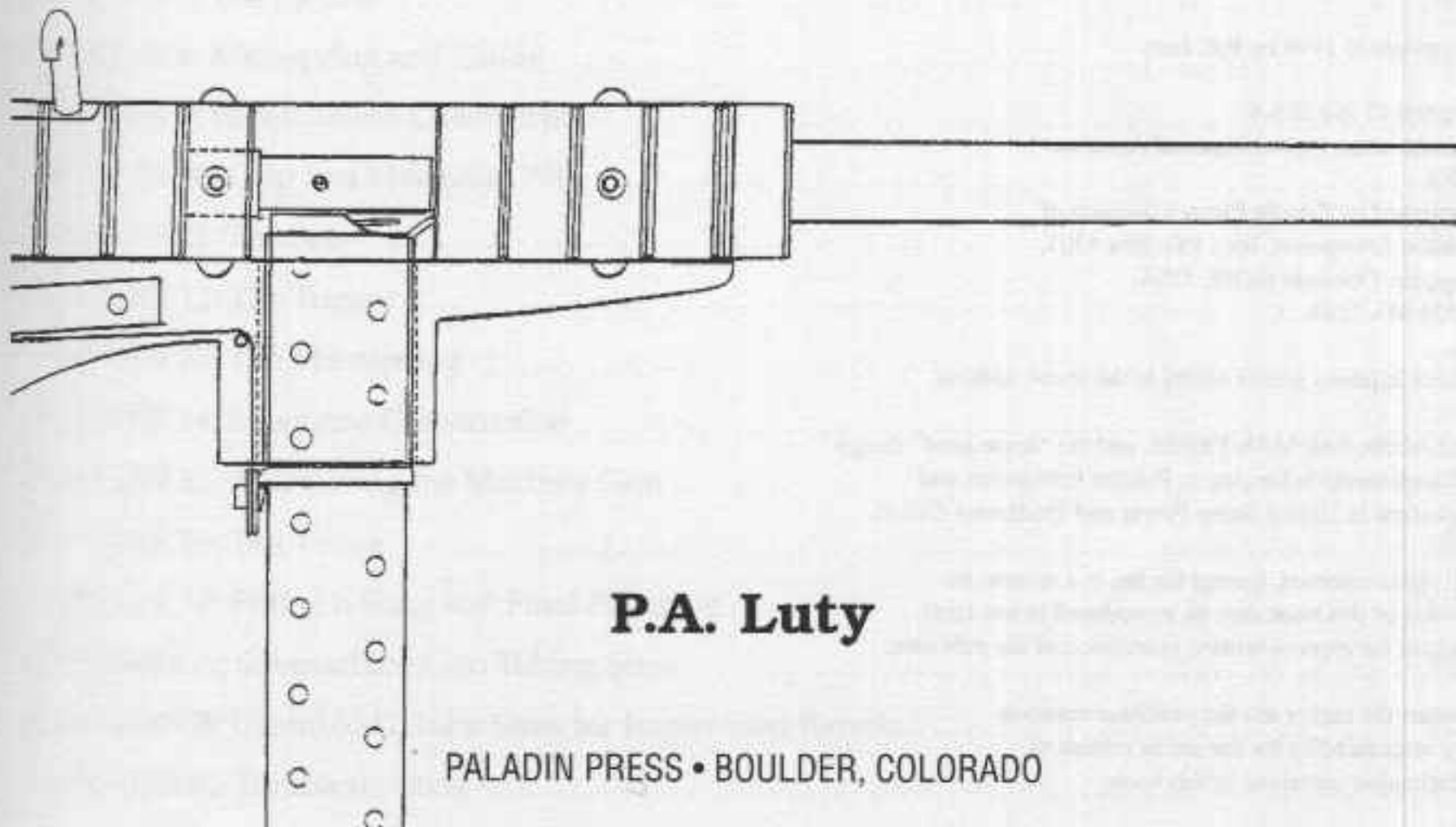

**P.A. Luty**

PALADIN PRESS • BOULDER, COLORADO

I dedicate this book to all who refuse to be helpless subjects of the state.

*Expedient Firearms* was written despite the best efforts of informants and the armed agents of a police state to prevent it.

Let us never succumb to the evil doctrine of the antigun movement and others who would deprive us of our arms and ban books such as this.

The 9mm Submachine Gun

# Expedient Homemade Firearms

## The 9MM Submachine Gun

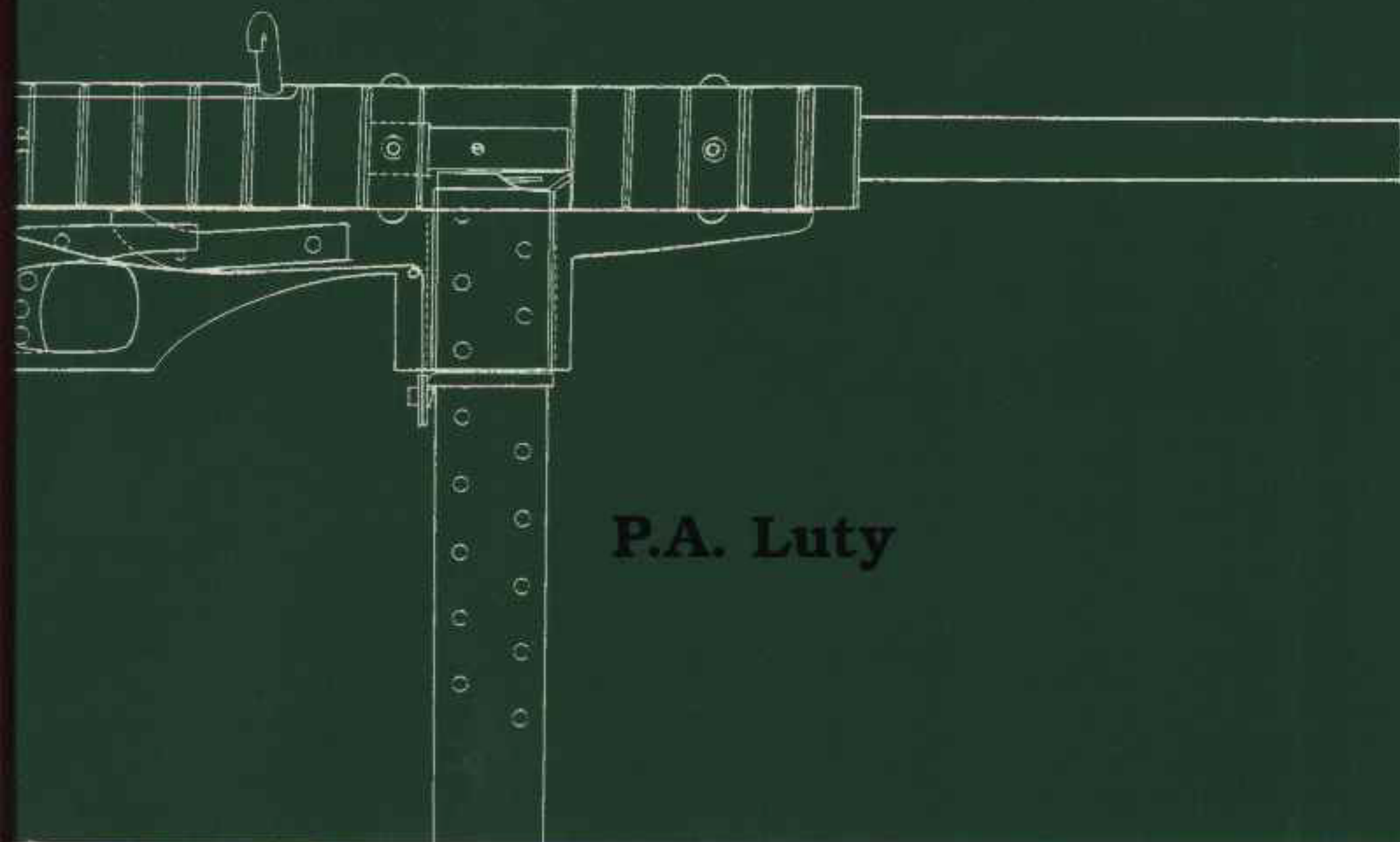

P.A. Luty

# CONTENTS

INTRODUCTION .....	1
CHAPTER 1: Lower Receiver .....	5
CHAPTER 2: Upper Receiver .....	11
CHAPTER 3: Barrel Components .....	17
CHAPTER 4: Chambering the Barrel .....	19
CHAPTER 5: Barrel Assembly .....	23
CHAPTER 6: Breech Block Construction .....	25
CHAPTER 7: The Ejector .....	31
CHAPTER 8: Mainspring and Guide .....	33
CHAPTER 9: Recoil Shield Construction .....	37
CHAPTER 10: Grip and Magazine Well .....	43
CHAPTER 11: The Sear .....	47
CHAPTER 12: The Trigger .....	51
CHAPTER 13: The Mainspring .....	53
CHAPTER 14: Magazine Construction .....	57
CHAPTER 15: Assembling the Machine Gun .....	65
CHAPTER 16: Test-Firing .....	67
CHAPTER 17: Fitting a Sling and Final Finishing .....	69
APPENDIX A: Submachine Gun Tubing Sizes .....	75
APPENDIX B: Useful SMT Tube Sizes for Improvised Barrels .....	77
APPENDIX C: Troubleshooting .....	79

# PREFACE

What is a homemade gun? The answer to that question may seem simple, but the term "homemade" can mean different things to different people, depending on the circumstances. For example, who makes a homemade gun and why? What materials are used and what type of gun can be built? To best illustrate what I mean let us take a brief look at the predicament of one particular gun maker whom we will call Fred.

On the small island off the coast of France where Fred lives, most types of guns are banned—or so tightly controlled that they may as well be banned! This sad state of affairs came about because the police, elitist press, and media in general were frightened of the people—especially the working classes—having access to firearms. The government knew that if the people owned guns, then all power would be in the hands of the people—something that must be avoided at all costs!

Seizing an appropriate opportunity, the antigun propaganda machine swung into action and, over a period of years, successfully brainwashed the majority of citizens into believing that only the police and army should have guns! Gun owners were persecuted by the elitist-owned media and branded as undesirable social elements, misfits, and psychopaths. The propaganda, lies, and misinformation worked, and the gun owner came to be regarded as a criminal and a threat to society. Behind a smokescreen of crime control, antiweapon laws were

passed and guns were banned. Citizens were taught to fear their neighbors so they would have no time to recognize or question the increasing power of the state over the individual. In order to facilitate the mass disarmament of the people, the state needed only create the illusion that an inanimate object, the gun, was responsible for crime (although crime in fact *increased* once guns were banned, because now only the criminals, police, and army had guns).

A convenient precedent had been set, and thus the foundations and doctrine of the totalitarian state were laid. It was then possible for all the requirements and trappings of the police state to be introduced behind the smokescreen of "crime control."

From gun bans to surveillance cameras, the state lulled the citizen into a false sense of security. The people—in many cases willingly—gave up the means of self-defense and self-reliance in the misguided hope of a safer and more secure society. But the people have now become helpless, dependent subjects, and the only security is that enjoyed by the state.

One exception, however, is Fred, our intrepid gunsmith, who has retained a healthy interest in firearms and all the freedom that gun ownership secures. Having had enough of the situation, Fred decides to build his own guns—a semi-automatic pistol, a revolver, and maybe a rifle and shotgun too! Fortunately, Fred has a fully

equipped machine shop, complete with a lathe and milling machine, and is conversant in most aspects of engineering.

He draws up plans and, over the following weeks and months, Fred builds a fine array of firearms, solid and functional. "Oh, how wonderful," he thinks whilst admiring his new guns. "If only everyone were as clever as I am, then everyone could have guns. Oh, well, so much for gun control . . ."

And that is the point of this little story. Although Fred has built a fine selection of "homemade" guns, they are only homemade to him. Anyone else without similar facilities and knowledge could not build such firearms. If Fred decided to write a "how-to" book on homemade guns, it would be an interesting read but would leave many readers frustrated by their not being able to build the guns.

Unfortunately, far too many so-called

"improvised firearms" fall into this category, and supposedly homemade guns end up being too complicated or so crude as to be undesirable. This is not my idea of what the homemade gun should be. The gun that can truly be called homemade is one that can be built by just about anyone, even under adverse social conditions and regardless of available facilities. One word that may best describe this interpretation of the homemade gun is "expedient"; hence the title of this book. In the dictionary there are numerous definitions of the word expedient, depending on the circumstances and context in which it is used. However, when we are talking about manufacturing a certain product, expedient refers to something that is of simple design, easily constructed, and made of readily available materials. Expedience, therefore, should be the overriding consideration when discussing homemade firearms.

# WARNING

Technical data presented here, particularly data on ammunition and on the construction, use, adjustment, and alteration of firearms, inevitably reflects the author's individual beliefs and experiences with particular firearms, equipment, and components under specific circumstances that the reader cannot duplicate exactly. The information in this book should therefore be used for guidance only and approached with great caution. Neither the author, publisher, nor distributors assume any responsibility for the use or misuse of information contained in this book.

In most countries it is against the law to do the following:

1. Manufacture a firearm without an official license from the government.

2. Own a fully automatic weapon.
3. Possess a silencer for a firearm.

In the United States, the appropriate licenses must be secured from (and taxes paid to) the Bureau of Alcohol, Tobacco, and Firearms (BATF) before manufacturing any firearm, taking possession of any fully automatic weapon, or building or owning a silencer for a firearm. Many states and municipalities also restrict firearm ownership and use. Severe penalties are prescribed for violations of these laws.

People who choose to build this 9mm submachine gun do so at their own risk. Neither the author nor the publisher can be responsible for any use or misuse of the information contained in this book. *This material is presented for academic study only.*

# INTRODUCTION

The expedient machine gun discussed herein is a 9mm weapon of straight blowback design. The gun fires from the open bolt and has a magazine capacity of 18 rounds. For our purposes, as stated in the Preface, the true expedient firearm is one that is built from the position that no outside influences, such as machine tools or professional gunsmith materials, are available. For this reason, nearly all major component parts of the weapon, receivers, barrel, breech block, and magazine are constructed from readily available steel tubing, eliminating the need for a lathe.

The gun barrel, for example, is a two-piece tube assembly and is smooth-bore rather than rifled. While the accuracy of the smooth-bore barrel is restricted to relatively close ranges, the ease and speed of assembling the expedient barrel more than compensate for this necessary compromise. The breech block, too, is a two-piece tube assembly of a skeletonized design, eliminating any need for a milling machine.

Manufacturing a gun magazine using the normal method of folding sheet steel around a forming block is a tricky and time-consuming operation. The expedient magazine avoids these problems because it is made from a length of tube that requires only a few small modifications. The magazine is of the single-stack design and holds up to 18 rounds. This is less than the capacity of the commercially

produced twin-stack design, but once again the simplicity of manufacture more than compensates for the slightly reduced capacity.

Certain parts of a machine gun, such as the sear, require the use of hardened steel. However, because the acquisition and heat treatment of specialized steels can be problematic, I have incorporated certain easy-to-obtain substitutes into the gun design that are as close as possible to the correct steel types required. I have not included any sights on the machine gun, since their only purpose would be cosmetic, rather than to make the gun more accurate.

The machine gun is primarily a point-and-fire weapon. The main priorities are reliability and simple functionality—especially on a weapon that must be kept as simple as possible. In short, the list of materials includes only the bare necessities to ensure that the gun will shoot reliably and is as simple as possible to build.

## TOOLS REQUIRED

1. Electric drill or drill press
2. Drill bits, 1.5 mm to 12.5 mm
3. Hacksaw
4. Large files, round, half round, square, and flat



5. Angle grinder
6. Bench grinder
7. Hammer
8. Set square (try square)
9. 13/32" taper pin reamer
10. Taper cutting tool
11. Countersink tool
12. Large vise

Obviously the better selection of tools available, the easier the gun will be to construct. A drill press, for example, while not in the hand tool category, will make drilling holes much quicker and easier, though a good variable-speed hand drill will suffice. It is worth pointing out here that a second-hand drill press is no more expensive than a good quality electric hand drill. If you are considering buying a drill, a drill press will save you a lot of time and effort.

### BUYING MATERIALS

As I mentioned earlier, almost the entire weapon is constructed from steel tubing. The best sources for this material are tube suppliers, who will usually have every conceivable size of tubing in stock, including those required to build the expedient machine gun. Tubing suppliers usually have minimum order charges, which means a full length of tube must be bought in each diameter required for the machine gun. The advantage of buying more tube than required is that a lot of guns can be built at little cost. For small quantities of tubing, engineering and steel fabrication shops are good places to purchase off-cuts at little cost. A list of materials and tube sizes is provided below. To avoid making the list too long, I have left out certain small nuts, bolts, washers, and such, but these are discussed in

the following chapters. I would advise reading the book through before attempting any construction, so as to familiarize yourself with the following sizes and abbreviations. The list is a quick-reference guide only. The tube sizes are given in millimeters, just as they will appear in most catalogs, but inches are also used where appropriate. The exact length of each tube, or the minimum amount necessary, is also supplied but as pointed out earlier, it is wise to buy more tube than required in case of any manufacturing errors. Where appropriate, some materials are marked with an asterisk, which indicates that two or three of that particular product should be bought in case of mistakes during construction.

### TUBING AND MATERIALS REQUIRED

1. **Lower receiver:** 50 x 25 x 2.5 mm rectangular tube (2 x 1"), 14 1/2" length minimum
2. **Upper receiver:** 38.10 x 38.10 mm 16-gauge 1/2"-square tube, 14 1/2" length minimum
3. **Barrel/breech block tube:** 15.88 x 3.25 mm round tube, 18" length minimum
4. **Barrel/block sleeve:** 19.05 x 16-gauge round tube (3/4"), 20" length minimum
5. **Magazine:** 34.93 x 15.88 mm 16-gauge rectangular tube, 10" length minimum
6. **Grip:** 40 x 20 x 2 mm rectangular tube, 10" length minimum
7. 3/4" steel collars (13)
8. 8 mm dia. socket screws (hex-drive, button-head, cap screws), 9.5 mm long (12)
9. 6 mm dia. socket screw, 1 1/8" long (1)
10. 4 mm dia. socket screw, 1 1/8" long (2)

## INTRODUCTION

11. Mudwing washers, 1 1/4" dia. x 8 mm hole (3)\*
12. Mudwing washers, 2" dia. x 8 mm hole\*
13. Hexagon or Allen wrench, 12 mm dia.\*
14. Spring pin (roll pin), 1/2" dia. x 3" long\*
15. Spring steel strip, 24 ga., 1/2" wide x 12" long\*
16. Piano wire, 19 gauge and 20 gauge (buy several rolls)
17. Round steel rod, 7 mm dia. x 6" long
18. 7 mm steel collar (1)
19. Steel plate, 3 x 2" x 3 mm thick
20. Hook bolt (J bolt), 8 mm dia.\*

# LOWER RECEIVER

The first section of the machine gun to be constructed is the lower receiver. The lower receiver accepts the grip, trigger, sear, and magazine. (We will discuss how these parts are made in due course.)

The receiver is cut out using a hacksaw from a length of 50 x 25 x 2.5 mm structural hollow section (SHS) steel tubing. As the name suggests, SHS tube is widely used in the construction of prefabricated buildings and is widely available. Alternatively, 50.80 x 25.40 x 2.64 mm ERW tube can be used. (ERW stands for "electric resistance welded" and refers to the manufacturing process used to make it.) I use the technical terms for both tube sizes, simply because this is how they will be listed in the catalogs of steel tubing manufacturers and suppliers. Both of the above tube sizes are, for all practical purposes, nothing more than standard 2 x 1" rectangular tube with a wall thickness of around 2.5 mm. The 50.80 x 25.40 tube is exactly 2 x 1", while the 50 x 25 tube is obviously slightly smaller on all sides. This slight variation between the two sizes does not matter, and either of the two is fine for construction of the lower receiver.

First, the tube is cut to a length of 14 1/2". The tube must then be washed in warm, soapy water with steel wool or a scouring pad. Once the lower receiver tube is cleaned, it is ready to mark out with the help of the template at the

end of this text. The template is not drawn to scale, so it must be photocopied and enlarged according to the instructions on p. 74, and then cut out as accurately as possible. This is best achieved by laying the template sheet on a flat surface and sliding a sharp X-acto knife or similar tool along the black outline of the template. A ruler can be used to guide the knife more accurately. The three crossed holes are left intact, as they will be needed later to mark the positions of the trigger, sear, and magazine catch. Next, a solid glue stick is used to apply a thin layer of glue to the underside of the template, which is then stuck to the receiver tube (Photo 1). It is important that the top straight edge of the template is level with the top edge of the tubing. The glue is not to permanently attach the template but to tack it securely enough to carry out the next procedure, which is to transfer the template's outline onto the tube. This is done using a scribe or other sharply pointed tool. The shape of the template is marked onto the tubing, with particular attention to the straight lines around the magazine well housing and the contours of the trigger guard. The positions of the three crossed holes I mentioned earlier can now be marked. The point of a punch is placed in the center of the crosses and hit with a hammer in order to transfer the positions of the holes through the template and onto the tube.

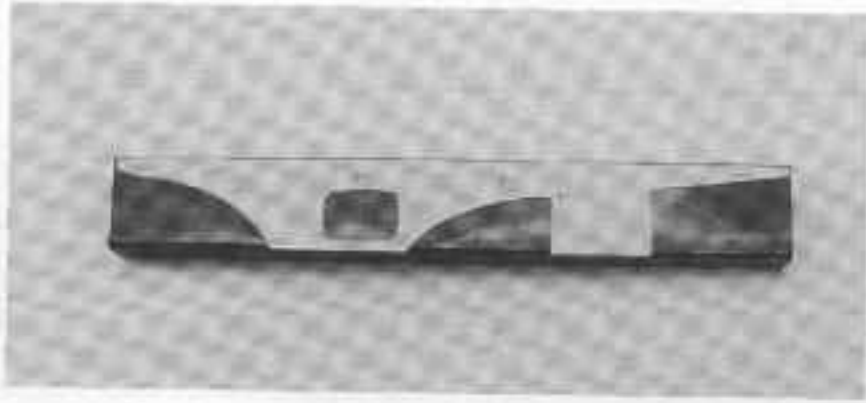

PHOTO 1: Receiver template glued to 2 x 1" rectangular tube.

With this accomplished, the template can be peeled off and discarded. Any glue is cleaned off the receiver tube, which is ready to be cut out and filed to shape.

Initially, the receiver is rough cut from the tube using a hacksaw before it is finally filed to the correct dimensions indicated by the score lines in Figure A. You will see from the drawing that the receiver can be cut from the tube by making five straight saw cuts. Keep in mind that because the receiver is being cut from a rectangular tube, the saw should be held as near to a right angle to the tube wall as possible to ensure that both sides of the receiver are as close to the same size as possible. Once the receiver is cut out it can be filed to shape using a large half-round file to cut the contours of the two curves. First one side of the receiver is filed to shape by following the scored lines, then the receiver is turned around and the opposite side filed, using the shaped side as a guide. Holding the file flat to the receiver while filing will ensure that both sides are nearly identical when finished.

Once the outside contours have been filed to shape, the trigger guard can be cut out. It is not possible to saw out the trigger guard since it is a fully enclosed, integral part of the receiver. Instead, a series of interconnecting holes, 3 mm or 4 mm in diameter, is drilled along the inside edge of the score lines that mark out the contours of the guard (Figure B). The holes should nearly touch each other and are drilled through both sides of the receiver. If a drill press is used then accuracy of the holes is assured, but if an electric hand drill is used, it is important that the drill bit be as near to a right angle to the work piece as possible. This

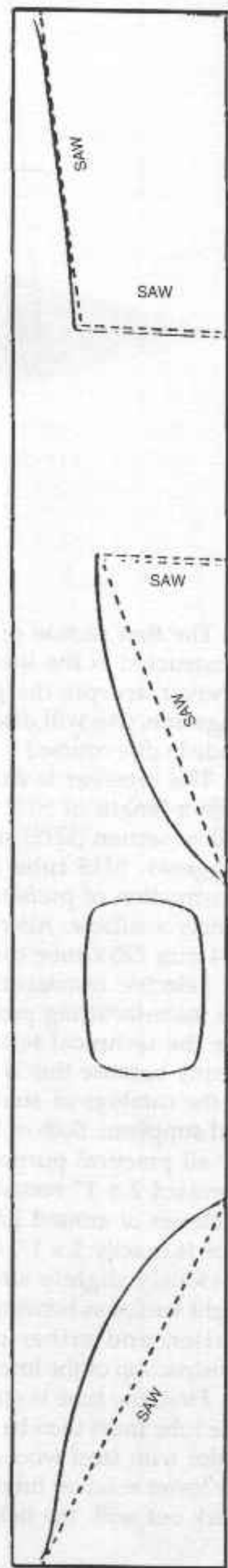

FIGURE A  
FIVE SAW CUT POSITIONS

is to ensure that both sides of the guard are in the same position when finished.

When all the holes are drilled, the unwanted section of steel in the trigger guard is removed using a blunt-ended punch. A short length of steel rod is ideal for this purpose. The punch is placed at the edge of the sections to be removed and hit sharply with a hammer until the unwanted section breaks free and can be removed. The receiver is then turned over and the same procedure carried out on the other side. The inside contours of the guard are now filed to shape by following the score lines in the usual way. A half round file small enough to pass through both sides of the guard is used for this procedure. The inside circumference of the guard should now be sanded to remove any sharp edges. The three holes, the punch marks for which were made earlier, are now drilled. The trigger and magazine catch holes are made using a 4 mm-diameter drill. The sear hole is made using a 6 mm drill, but this hole is first drilled to 2 or 3 mm diameter before the final 6 mm hole is drilled (Photo 2).

Next we must turn our attention to the top side of the receiver and the process of cutting the recesses for the magazine well and sear. Figure C illustrates the positions of the two recesses and their correct sizes. The sear recess is drilled out first with a 9 or 10 mm drill bit before it is finally cut to shape using a square or flat file of suitable size. The sear recess should be as near to the center of the receiver in relation to the receiver walls as possible. The magazine well recess should be cut accurately in accordance with the given measurements because the magazine well, which will be fit



PHOTO 2: Right-side view of lower receiver after it has been filed to shape.

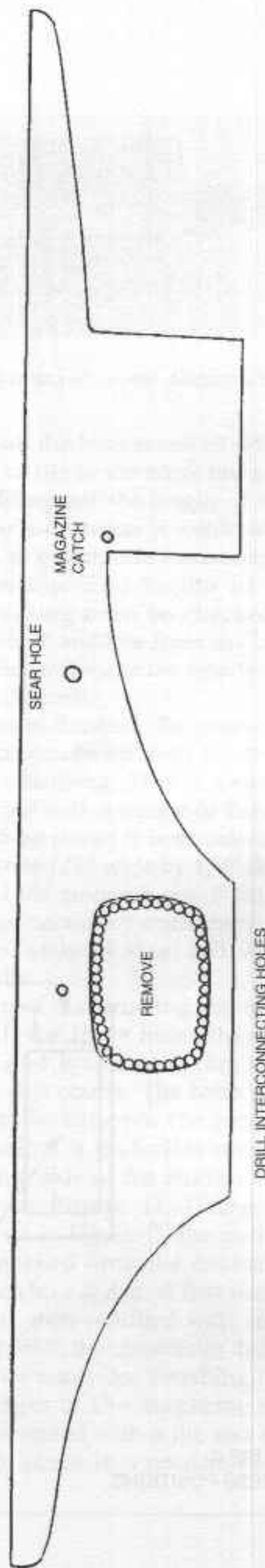

FIGURE B  
CUTTING OUT  
TRIGGER GUARD

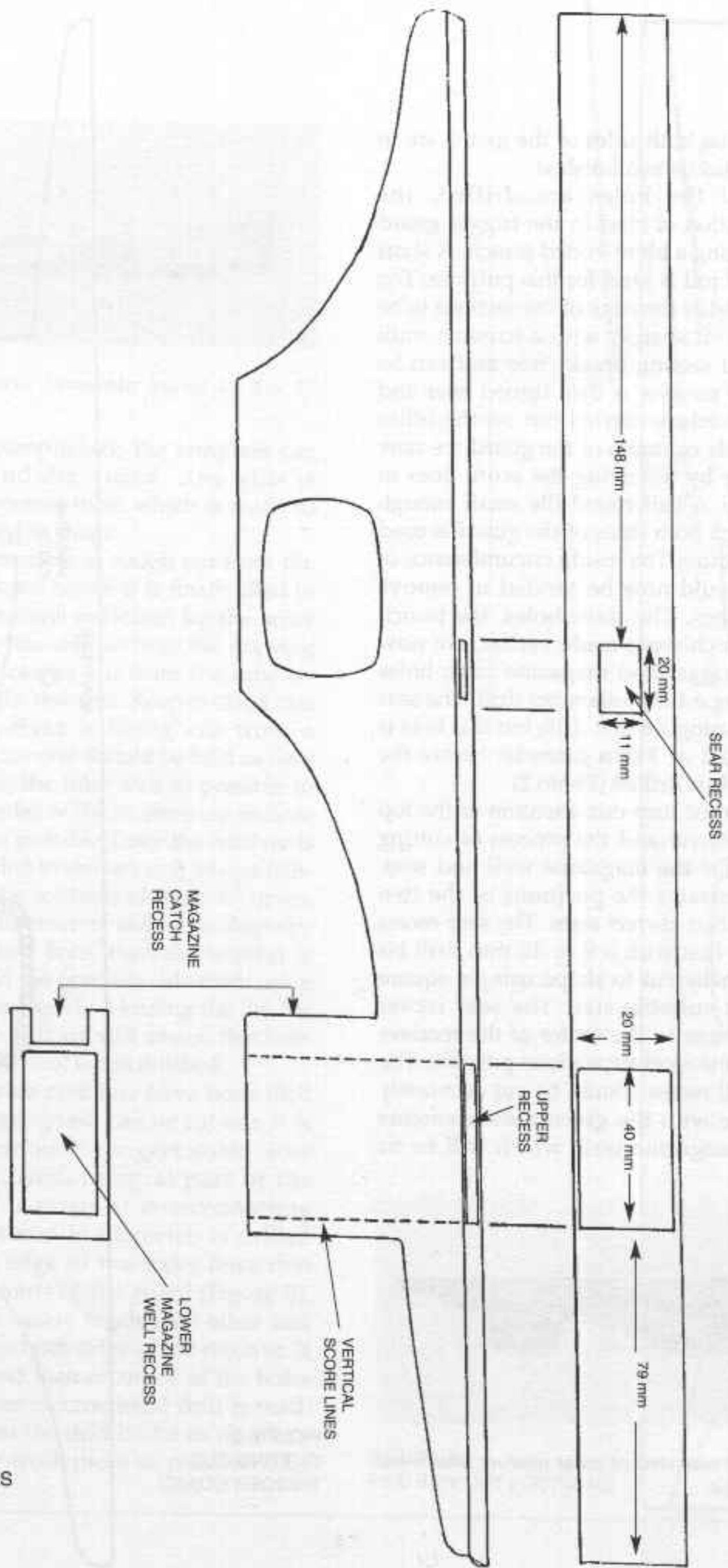

FIGURE C  
RECESS POSITIONS

## LOWER RECEIVER

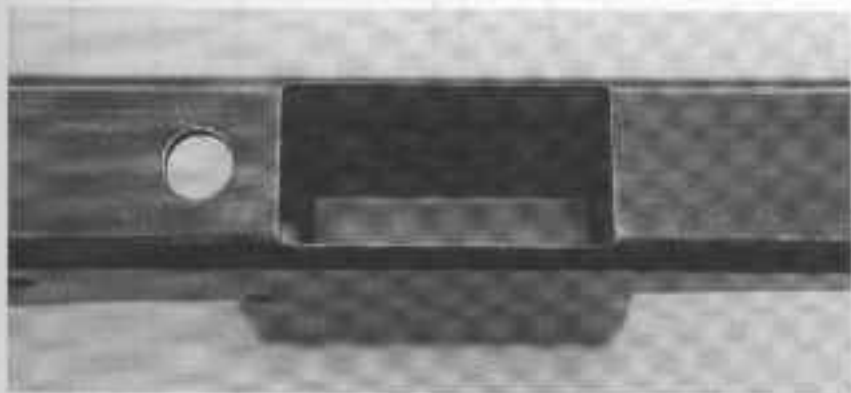

PHOTO 3: Upper magazine well recess.

later, needs to be a close fit inside the magazine well housing. In the positions shown in Figure C, two lines, 40 mm apart, are scored across the top of the receiver using a set square. (I have given the recess width measurement as being 20mm, though it may be slightly less, since the width of the recess is governed by the thickness of the receiver wall.) The recess is cut out in the same manner as the trigger guard, by drilling a series of interconnecting holes 3 or 4 mm in diameter. The holes should be drilled along the inside edge of the two score lines and along the edges of the receiver walls (taking into account the wall thickness of the receiver).

A flat-ended punch is now used to remove the unwanted metal (Photo 3). Because the magazine well passes through the magazine well housing from top to bottom, an identical recess is cut into the underside of the housing. The simplest way of locating the exact position of the lower recess is to score two vertical lines, 40 mm apart, down the side of the magazine well housing. The tops of the two lines must be in alignment with the two upper recess lines. To make the two vertical lines, it is very important that a set square be used to ensure they are at a right angle to the top of the receiver.

The bottom of the two vertical lines now point out the exact position of the lower recess. The two lower recess score lines can now be made across the width of the magazine well housing where the bottom of the two vertical lines indicate they should be. The lower recess can now be cut out using the same method used for the upper recess. A large file can now be passed all the way through the magazine

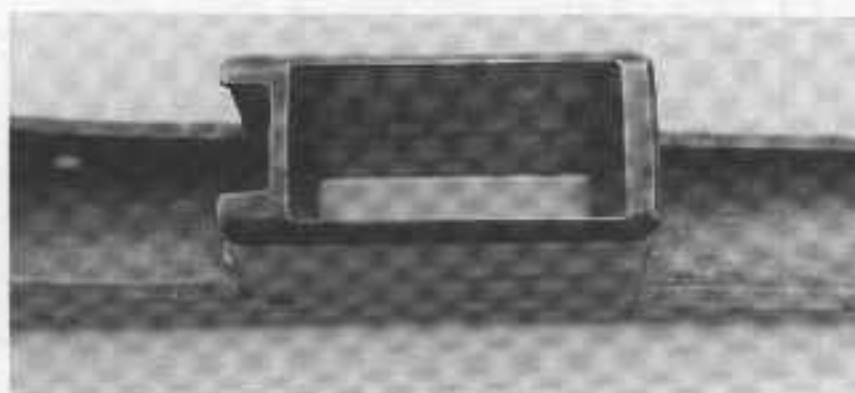

PHOTO 4: Lower magazine well recess. Magazine catch groove shown on left.

well housing and all the burs removed (Photo 4). It is important to file to the score lines and no further when filing out the length of each recess. The width of each recess is restricted by the receiver walls, so getting this measurement wrong is impossible. The inside of the magazine well housing must be checked to ensure that it is smooth and free from any burs, since any such defect will make the insertion of the magazine well difficult.

With both recesses finished, the groove for the magazine catch can be cut into the lower rear section of the housing. This is a simple procedure carried out with a square or flat file. The groove should be cut so it is as central as possible, the groove is 1/2" wide by 1/4" deep. When the depth of the groove is cut, it should be filed as deep as necessary until there is a thin (2 mm or so) strip of steel left in the bottom of the groove.

The final stage of constructing the lower receiver is to drill the three holes that will allow the upper and lower receivers to be bolted together in due course. The holes must be situated centrally between the receiver walls. For this reason, a centerline must be scored down the top side of the receiver from end to end, as in Figure D. Using the measurements given in Figure D, the position of each hole is marked onto the centerline using a punch. Each hole is drilled first using a 2 or 3 mm drill bit, then redrilled with an 8.5 mm drill (Photo 5). With the three holes drilled, the receiver is now ready for finishing. The front and rear edges of the magazine well housing must be rounded with a file and then polished smooth, since this section of the



PHOTO 5: Top side view of finished receiver showing three bolt holes, magazine and sear recesses.

receiver also serves as the foregrip. The inside and outside walls of the receiver must be checked for any burrs or sharp edges, which can be removed as necessary with a file and sandpaper. The sides of the receiver should be polished with a medium-grit paper to give a good, professional finish. Laying a sheet of sandpaper on a flat surface and pushing the receiver back and forth over it will create a very professional finish. The lower receiver is now ready to be bolted to the upper receiver, which is the next section of the machine gun body to be constructed.

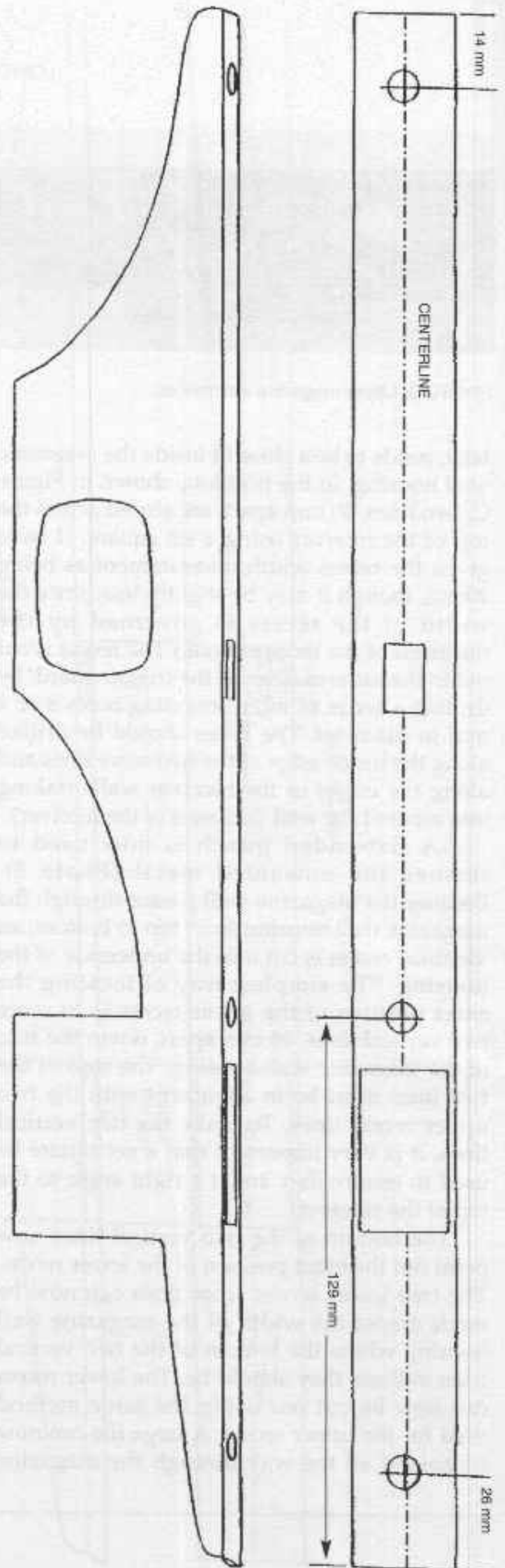

FIGURE D  
LOWER RECEIVER BOLT HOLE POSITIONS



# UPPER RECEIVER

The upper receiver will, in due course, accept the barrel, breech block, and mainspring assembly. It is constructed from a length of 38.10 x 38.10 mm, 16-gauge ERW tubing. The catalogs of most tube manufacturers and suppliers give all measurements in millimeters, making some tube sizes rather difficult to remember. However, a quick look at a ruler will show that 38.10 mm converts to 1 1/2", meaning that the receiver tube is standard 1 1/2"-square tube. The gauge system is usually reserved for the thinner-walled tubing, such as that used for the upper receiver, 16 gauge converting to roughly 1.6 mm. Therefore we require a length of standard 1 1/2"-square 16-gauge tube. First a set square is used to score a line around all four sides of the tube at both ends. This will ensure that each end of the tube is square when cut to a length of 14 1/2". Both the upper and lower receivers are the same length.



PHOTO 6: Upper and lower receivers clamped together with two hose clips.

The tube is temporarily secured to the lower receiver using two large hose clamps. The clips are placed around the ends of both receivers and thoroughly tightened. The lower receiver should run down the middle of the upper receiver with an equal amount of tube visible on either side of the lower receiver. A ruler can be used to measure each side if there is any doubt. This assembly is clamped in a vise, lower receiver facing up. An 8.5 mm drill is inserted through one of the three lower receiver bolt holes and used to drill through the bottom side of the upper receiver tube, as shown in Photo 7. The same procedure is now carried out on the other two bolt holes. Drilling through the three lower receiver holes and into the upper receiver tube ensures that both receivers will be in perfect alignment when finally bolted together. Now, with the two receivers still clamped together, the right side

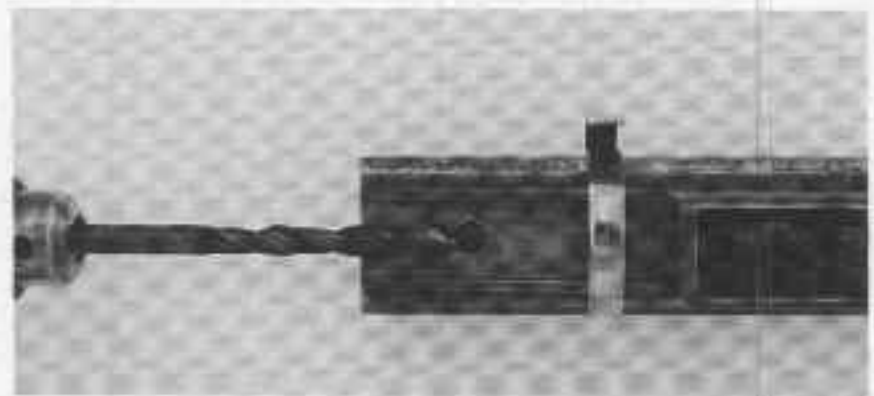

PHOTO 7: Drill through lower receiver bolt holes and into upper receiver tube.

of the upper receiver tube is marked with the letters EP (Ejection Port), as in Figure E. The opposite side (left side) is marked with the letters EH (Ejector Hole.) The bottom side of the tube, where the two receivers join, is marked MW (Magazine Well.) The marking of each side is to ensure that the following recesses are cut into the correct sides of the tube. The hose clips can now be removed and the two receivers separated. The lower receiver can be put to one side, since it will not be required until later. Cutting each recess is a straightforward operation requiring only a drill and file. As with the lower receiver, each recess, with the exception of the sear hole, is cut by making a series of interconnecting holes with a 2- or 3 mm drill bit.

The sear recess is made by first drilling a single 9- or 10 mm hole and then filing to its rectangular shape. The ejector hole, which will eventually accept the ejector, is a single 6 mm-diameter hole drilled in the left side of the receiver in the position shown in Figure F.

A set square should be used to make sure each recess is as accurate as possible. The drawings in Figure F illustrate the size and position of each recess. Following the letter reference marks will ensure that each recess is cut into the correct side of the upper receiver tube.

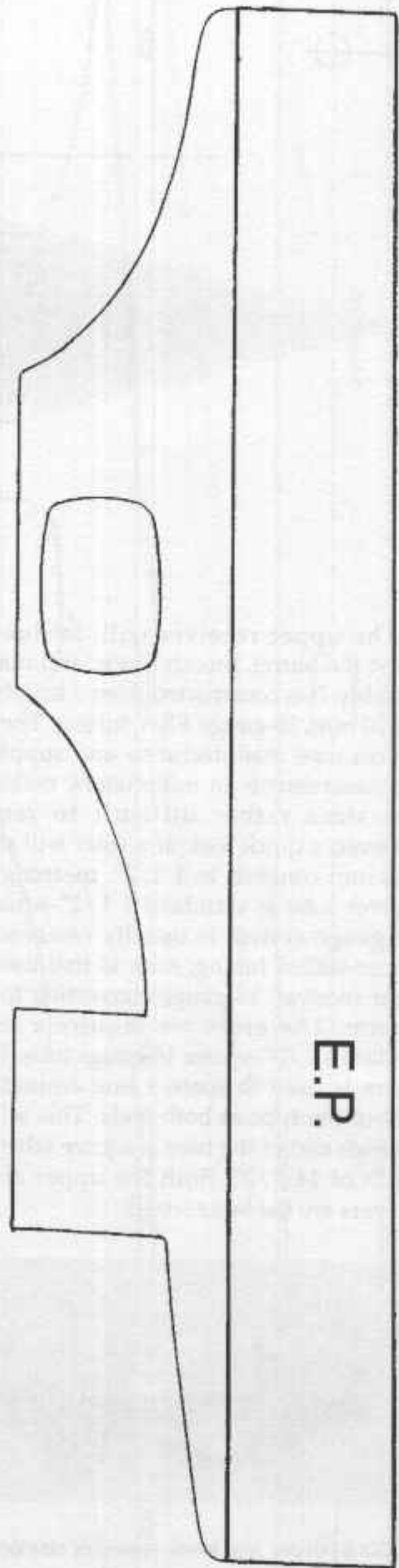

FIGURE E  
RECESS POSITION LETTERS SCRIBED ONTO RIGHT  
SIDE OF UPPER RECEIVER

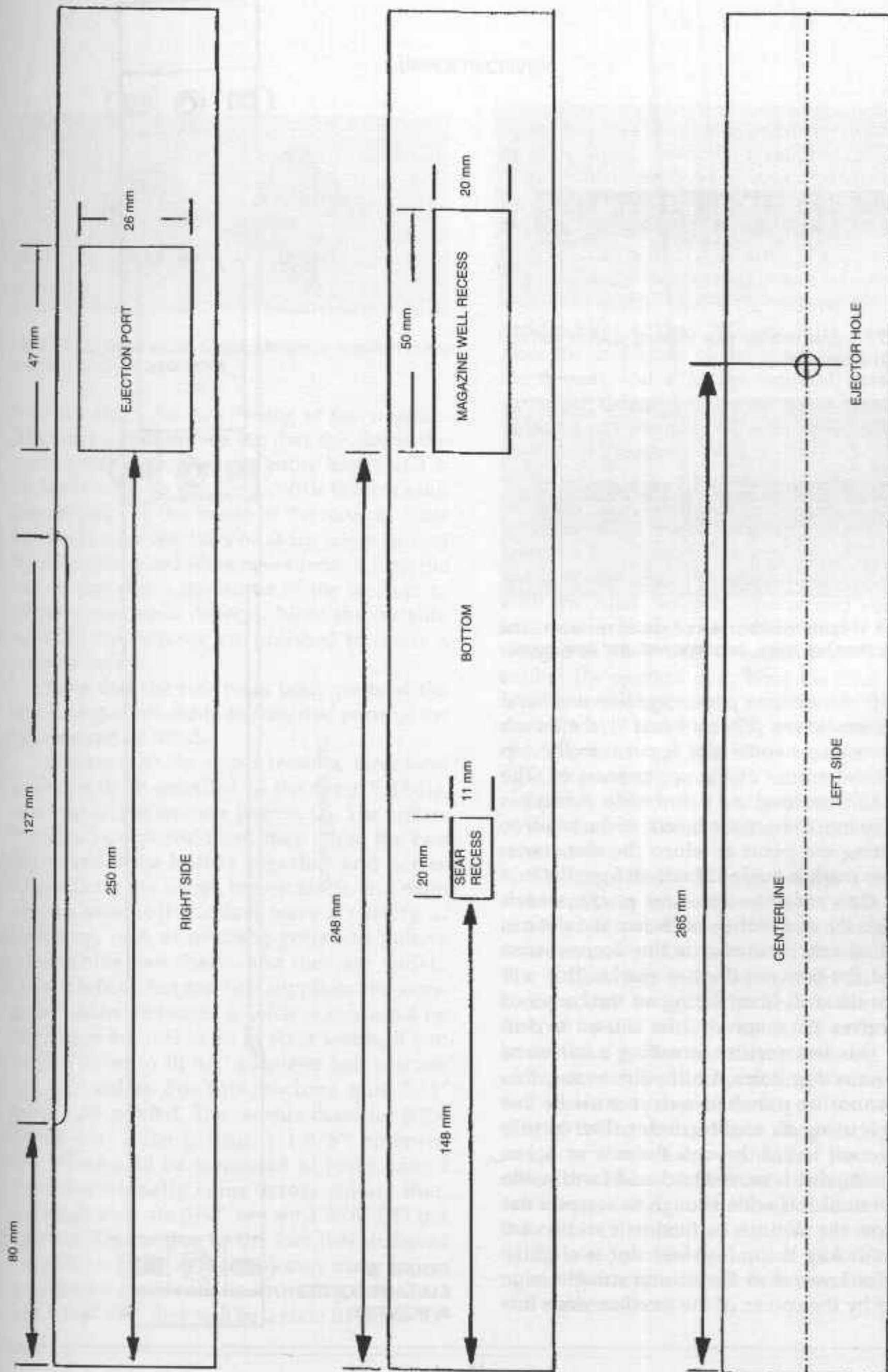

FIGURE F  
UPPER RECEIVER



PHOTO 8: Upper receiver tube showing ejection port and cocking handle slot.



PHOTO 9: Bottom side view of upper receiver tube showing three bolt holes, magazine well, and sear recess.

With the ejection port, magazine well, and sear recess cut out (Photos 8 and 9), the breech block cocking handle slot is cut into the top right-hand corner of the upper receiver. The slot is 127 mm long and 8 mm wide. A mark is made 80 mm in from the breech of the receiver, indicating the point at which the slot starts. Another mark is made 127 mm in from the first mark (towards the ejection port), which indicates the end of the slot. Before the slot can be drilled out, the corner of the receiver must be filed flat between the two marks. This will prevent the drill from sliding off the corner of the receiver. An 8 mm drill bit is used to drill along this flat section, creating a series of interconnecting holes. Unlike the recess, this slot cannot be punched out; it must be cut through using an angle grinder. The cutting disc is used to cut through the row of holes. The cutting disc is moved back and forth inside the slot until it is wide enough to accept a flat file. Now the slot can be filed to a width of 8 mm. It's okay if the finished slot is slightly higher or lower than the natural straight edge created by the corner of the receiver, since this

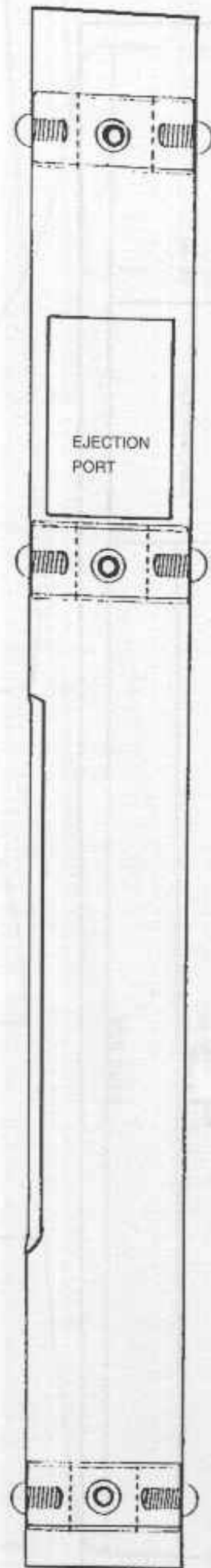

FIGURE G  
COLLARS BOLTED  
IN POSITION



PHOTO 10: Steel collar shown alongside modified collar with four socket screws fitted.

will not affect the functioning of the weapon. The main requirements are that the slot is the same width throughout its entire length and is as horizontal as possible. With the cocking handle slot cut, the inside of the receiver must be checked for any burrs or sharp edges caused by the drilling and filing operations. A long file can be put down the inside of the receiver to remove any such defects. Now the outside walls of the receiver are polished to create a smooth finish.

Now that the two main body parts of the machine gun are made the internal parts of the weapon can be fitted.

Staying with the upper receiver, three steel collars will be installed to the front, middle, and rear of the receiver (Figure G). The collars have two purposes. First, they allow the two receivers to be bolted together and act as retainers for the barrel, breech block, and main spring assembly. Collars have a variety of functions, such as retaining gears and pulleys on machine tool shafts, and they are widely available from nut and bolt suppliers and some good hardware stores. A collar is measured by the size of bar it is to fit; in other words, if you need a collar to fit a 1"-diameter bar, you ask for a 1" collar. For this machine gun, 3/4" collars are needed. The outside diameter (OD) of the 3/4" collar is usually 1 3/8"; however, the OD should be measured to make sure. I have occasionally come across collars that, although they are 3/4", are *not* 1 3/8" OD but smaller. This is due to the fact that different manufacturers of steel collars may make collars to different specifications. Providing the collars are 1 3/8" OD, they will be a slide fit inside the

upper receiver. Also, the length (or thickness) of each collar should be measured, and they should be 17 to 18 mm long. Each collar is fitted with a grub (set) screw, which, when tightened, retains the collar on the bar or tube to which it is fitted (Photo 10). The grub screws should be unscrewed and removed. To retain the collars inside the receiver, 13 dome head socket screws, 9.5 mm long (measure from the underside of the head to the end of the thread), and a tap are required, both with the same thread size as the grub screws. A hexagon or Allen wrench is also required to fit the socket screws.

Now a collar is inserted into the front of the receiver so that the collar grub screw hole lines up with the holes in the underside of the receiver. The collar is secured in place with a socket screw, and the screw is tightened firmly with the Allen wrench. The second collar is inserted into the rear of the receiver and secured in place with a second screw directly behind the ejection port. Now the final collar is fitted to the rear of the receiver and secured as well. All three socket screws must be checked to ensure that they are thoroughly tight to prevent the collars from moving. The collars are now drilled on the other three sides of the receiver so each collar will accept three more screws.

Drilling blindly through the receiver walls and hoping to locate the center of each collar is not good practice, so the position of each collar must be located before drilling begins. The easiest way is by using a set square to score a line around all three sides of the receiver in line with the center of each socket screw fitted earlier and then measuring to the center of each line and punching a mark. This will locate the position of the collars on each side of the receiver. Where the punch marks are, 2- or 3 mm holes are drilled through the other three sides of the three collars. The holes are then redrilled to the final diameter using the correct diameter of drill for the tap size. Each hole can now be tapped and the other nine socket screws (three in each collar) fitted and tightened.

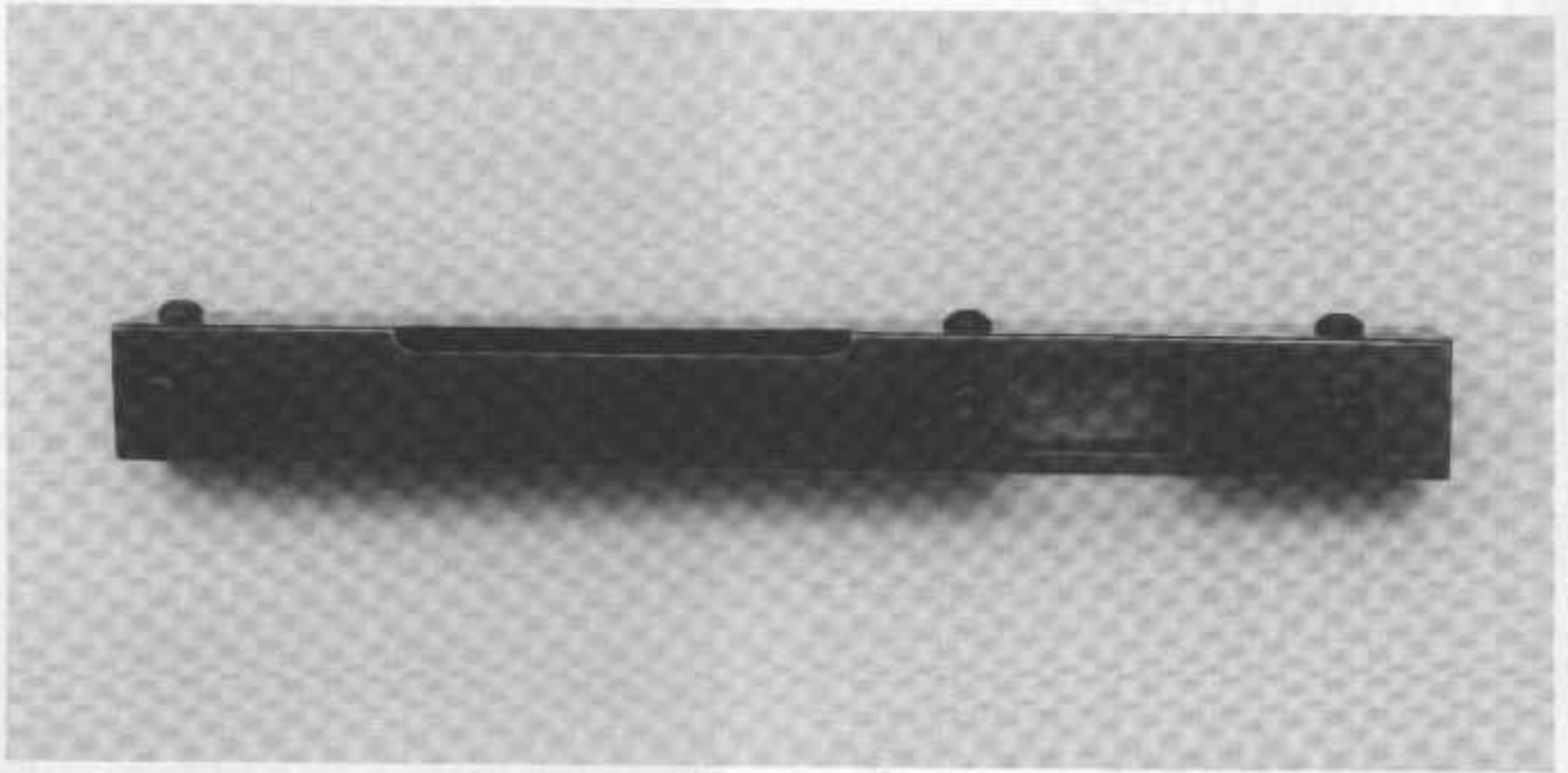

PHOTO 11: Finished upper receiver tube with three collars secured with socket (cap) screws.

If the ends of the screws are visible when you look through the receiver from end to end, the screws must be shortened.

With the collars secured inside the receiver (Photo 11), the barrel, breech block, and mainspring assembly can be assembled and fitted.

# BARREL COMPONENTS

Making a rifled gun barrel would require, at the very least, a lathe and a rifling machine. Relatively few people own a lathe, and even fewer have a barrel rifling machine—not to mention the ability to use them. On any firearm that is truly homemade, the accuracy of the rifled barrel must be compromised for the ease of construction the smooth-bore version offers. While the accuracy of the handgun or rifle is important, the machine gun's inherent firepower means accuracy is of secondary importance. Reliably getting as many bullets to the target as quickly as possible is the main consideration.

Construction of the barrel is a three-part process utilizing two lengths of steel tubing reinforced with five steel collars. The collars are of the same size, namely 3/4", as used in the construction of the upper receiver. The main barrel tube is a 9" length of 15.88 x 3.25 mm seamless mechanical tube. (This is the

practical purposes, 16 mm diameter with a wall thickness of 3.25 mm. I mention this because, unless the OD of the tubing is measured with any micrometer other than one of the fancy digital types, the 15.88 mm will look like 16 mm.)

Seamless mechanical tube (SMT) is used mainly on machine tools and vehicles where a high-strength, thick-walled tube is required. The second tube, which we will call the barrel sleeve, is a 9" length of 19.05 mm x 16-gauge ERW tube. The measurement of 19.05 mm converts to 3/4". This tube is placed over the main barrel, which increases the barrel to 3/4" diameter. This allows the fitting of 3/4" collars onto the barrel assembly.

The collars increase the barrel's breech diameter to 1 3/8", allowing the barrel to be installed in the upper receiver and also act as barrel reinforcements for extra strength. Before the barrel can be assembled, the main

## CHAPTER 4

---

# CHAMBERING THE BARREL

Nearly all cartridges used in automatic and semiautomatic firearms have tapered cases. Because of this, the barrel's chamber must be cut with the same degree of taper as the cartridge case. The purpose of the tapered case and chamber is to make the ejection of the fired cases reliable. At the moment of firing, the spent case moves backwards out of the chamber due to the pressure of gases in the barrel. A cartridge case with straight walls would drag on the inside of the chamber until the case clears the barrel. The tapered case, however, will disengage the chamber wall as soon as it starts on its backward journey, eliminating any significant drag factor. This is because, as the tapered case moves back, even a fraction, it is immediately of a smaller diameter than the chamber and cannot drag on the chamber walls.

If a 9 mm chamber reamer can be acquired, this would be the quickest way of cutting the chamber. However, depending on where and under what regime one lives, this may not be possible. Even when a reamer can be purchased from gunsmiths' supply stores, it is an expensive item. For these reasons, making an improvised reamer may be a necessity. This is, however, a simple task. By modifying a readily available 13/32 (10.3 mm) 1-in-50 taper pin reamer, a perfectly serviceable chamber can be cut (Figure H). Again, reamers are expensive

if purchased new, so always buy secondhand. Because reamers, both straight and tapered, are extensively used in engineering shops, they are widely available secondhand. The best sources are secondhand machinery dealers, where whole boxes of reamers will be found. Many times bankrupt stock items that are in pristine condition can also be purchased at a fraction of the new price. It is also a good idea to look around local engineering shops, where a taper pin reamer can probably be obtained very cheaply. The cutting edges must be sharp and undamaged, though; if in doubt, ask an assistant engineer.

The reamer required will either be stamped with the fractional (of an inch) size of 13/32 or the metric equivalent 10.3 mm. The term "1-in-50" means that the reamer reduces 1 mm in diameter for every 50 mm of length, giving a means of measuring the amount the reamer tapers from end to end. The 13/32 reamer has an overall length of 193 mm. The reamer must be cut down to a length of 87 mm using an angle grinder (Photo 12). The straight shank of the reamer is put in a vice and cut down so it is several millimeters longer than the 87 mm length required. Once cut down, the end of the reamer is placed against a grind wheel as square as possible to the grinding surface. The reamer is rotated with the fingers while it is ground down to the 87 mm length to ensure



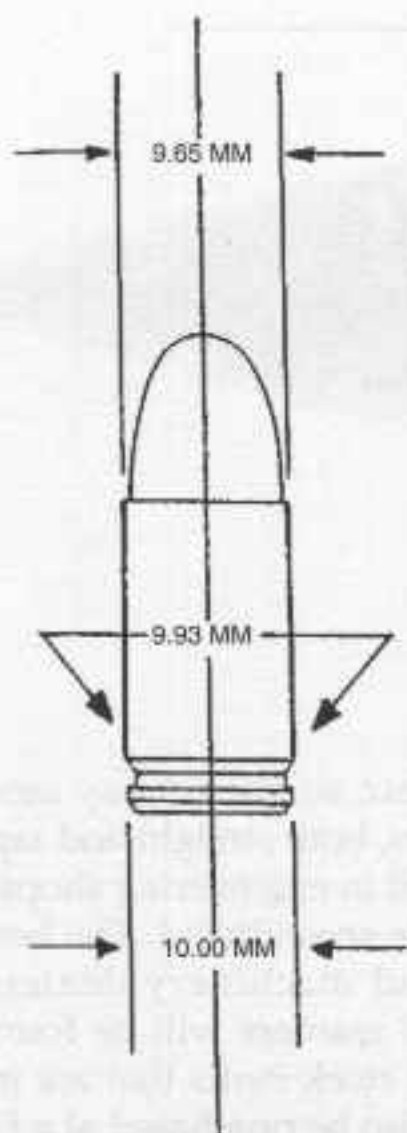

THIS CARTRIDGE CASE TAPERS FROM 9.93 MM TO 9.65 MM. THE BASE OF THE CASE IS 10 MM IN DIAMETER.

FIGURE H  
9 MM CARTRIDGE CASE DIMENSIONS

that the end is as flat as possible. If a drill press is available, the shortened reamer can be put in the drill chuck and the end of the reamer can be ground perfectly onto a flat grit stone. Whichever method is used, the reamer should now be 87 mm long. Note that the reamer can be up to 1 mm longer or shorter than 87 mm, since 1 mm either way will have little impact on the dimensions of the finished chamber. A leading cutting edge must now be ground onto three of the six flutes at the front of the reamer. As shown in Figure I, every other flute must be ground away to allow enough access to sharpen the three remaining.

The tops of the flutes to be removed are

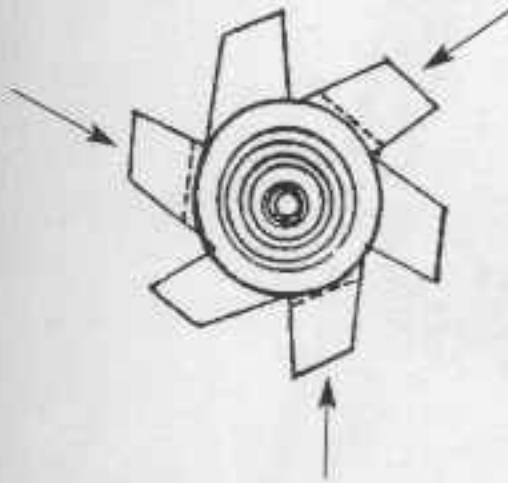

PHOTO 12: Taper pin reamer shown before and after cutting.

touched against a grinding wheel and removed on an angle. Only the top edge of each flute is removed. Now the back edges of the three remaining flutes are carefully sharpened to create three cutters (Photo 13). This procedure should not be overdone. Each of the three cutters should be ground carefully just until sharp and no further. If too much steel is ground away, the cutters will be the wrong shape and will not cut a chamber of the correct dimensions. A bit of care taken when carrying out this operation will result in a reamer as good as anything the professional reamer maker can produce. The reamer is now finished, but before it can be used effectively, a guide assembly must be made. Although I have used this reamer to cut numerous chambers, without the guide, the chamber inevitably ends up being cut oversized due to human error. While the oversized chamber will still allow the weapon to function, it means that the fired cases will also be oversized. This will create problems if the cases are to be reloaded. To assist in the cutting of an accurately sized chamber, a reamer guide is essential. This requires a 2" length of the main barrel tubing (15.88 x 3.25) mentioned earlier. This will be the reamer sleeve. The bore of the sleeve is reamed out using a 10 mm drill to increase its inside diameter. This will allow the chamber reamer to slide inside the sleeve. Alternatively, the bore of the sleeve can be reamed out using an uncut 13/32 taper reamer. The latter method is the most accurate. The reamer is turned until the shank is buried inside the sleeve to its full depth. Then the sleeve is turned around and the other end is

## CHAMBERING THE BARREL

REMOVE THREE FLUTES



GRIND AWAY BACK EDGES

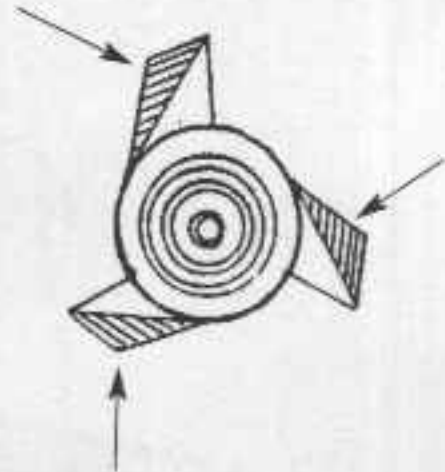
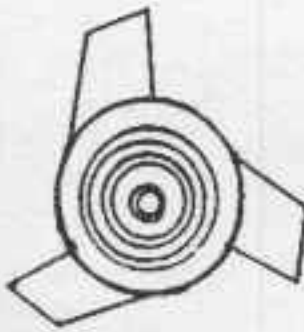

FIGURE 1  
REAMER MODIFICATIONS

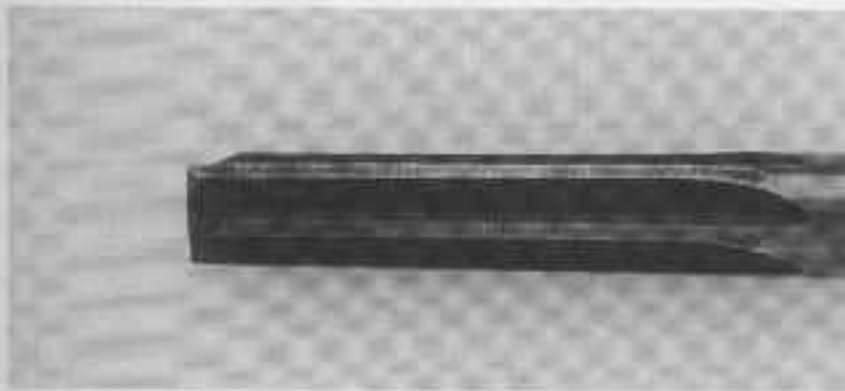

PHOTO 13: Side view of finished reamer. The top flute has been sharpened while the lower flute has been removed.



PHOTO 14: Complete reamer assembly. Sleeve is shown in position with reamer guide alongside.

reamed out until the sleeve is bored all the way through. A hole is drilled through one side of the sleeve about 1/4" from its end. The hole is threaded using a 4 mm-diameter tap and a short screw inserted. The chamber reamer is

slid into the sleeve and adjusted so that the end of the reamer protrudes 15 mm from the front of the sleeve, as in Photo 14.

Now the screw is tightened to prevent the reamer from moving. This measurement should be exact, as it dictates the depth of the chamber. The sleeve increases the diameter of the reamer and allows the fitting of the guide. This is nothing more than a 5" or 6" length of the 19.05 x 16-gauge (3/4") barrel sleeve tubing referred to earlier. The guide is not attached to the reamer assembly but remains a loose, removable attachment. Once the reamer and guide are completed, the barrel can be chambered. The main (15.88 x 3.25) barrel tube is clamped in a vice so that 4" or 5" of the tube protrudes from the side of the vice. The reamer and guide assembly slide over the barrel, as shown in Photo 15. The reamer guide is simply held in place with the left hand while the reamer is turned clockwise with the right. The guide tube prevents the reamer from moving from side to side and ensures that the chamber is cut straight. A small amount of forward pressure must be placed on the reamer while it is being turned so that it will cut into the barrel's bore. When the reamer comes to a stop and cannot cut any deeper, we know the chamber is cut to the correct depth of 15 mm.

The reamer is now removed and any metal shavings blown out of the barrel. Looking into the barrel from the breech will reveal a shallow

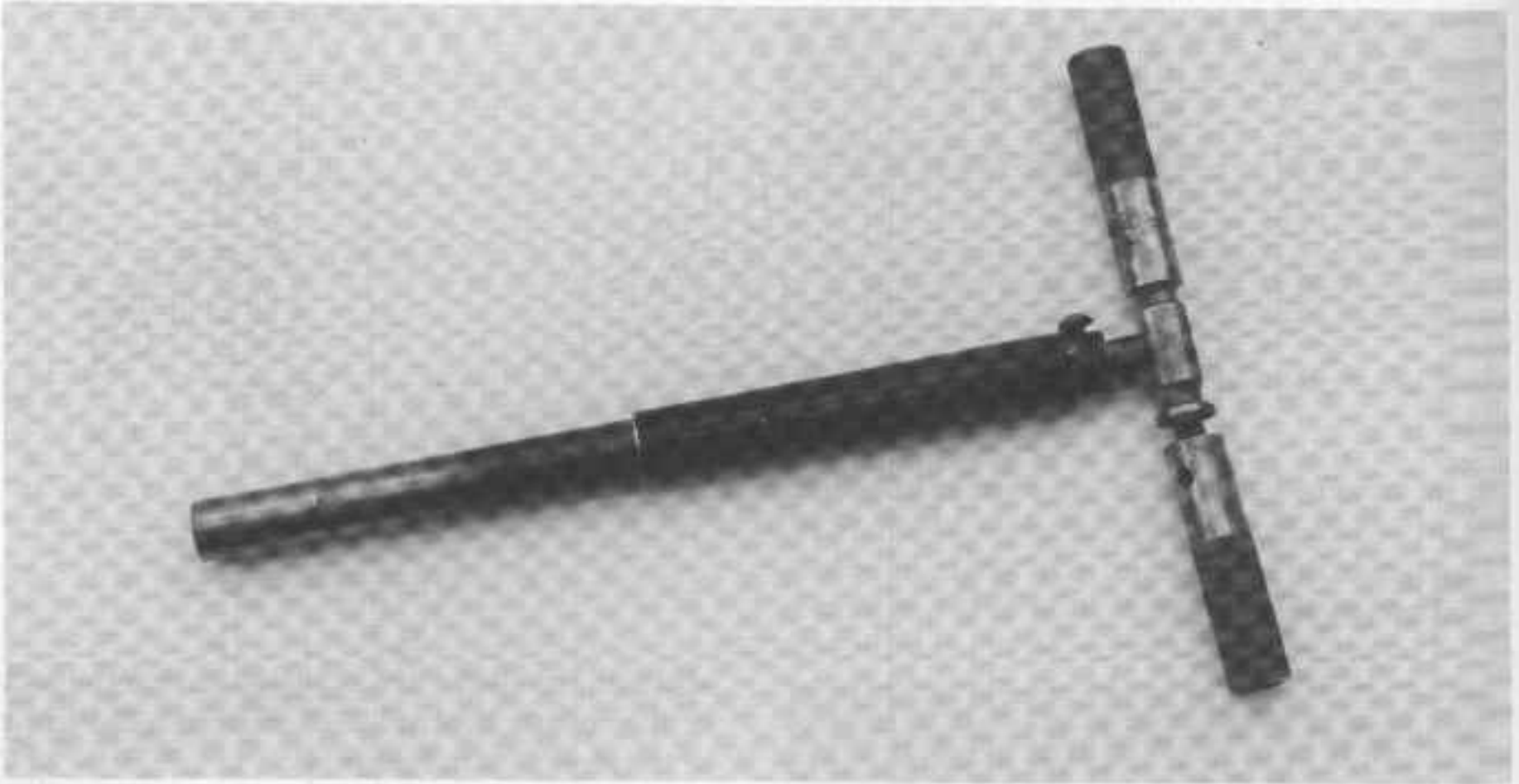

PHOTO 15: Reamer in position over barrel tube.

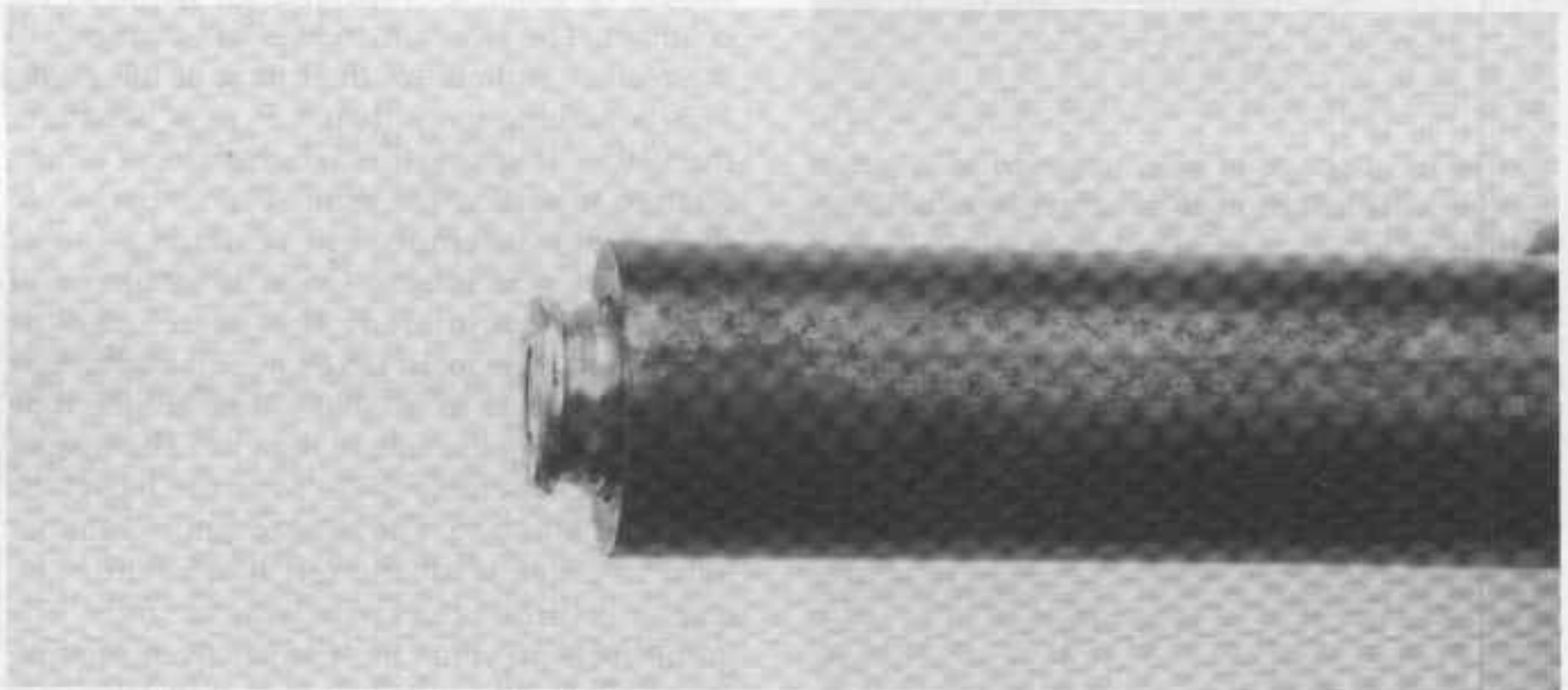

PHOTO 16: The base of the cartridge should protrude 4 mm from the breech face of the barrel.

step, or shoulder, as it is sometimes called, that has been cut into the bottom of the chamber. This step connects with the mouth of the cartridge case and prevents the cartridge from being rammed too far into the barrel when a round is chambered.

It should now be possible to drop a cartridge

into the chamber. The cartridge should slide in under its own weight without any form of assistance and come to a positive stop against the shoulder. With the round chambered, the base of the cartridge should protrude 4 mm from the breech face of the barrel (Photo 16). The reason for this will become apparent later.

## CHAPTER 5

# BARREL ASSEMBLY

Once the chamber has been cut, the barrel can be assembled in minutes.

First barrel and barrel sleeve are washed inside and out and then dried. Some high-strength bearing adhesive retainer of the metal-filled epoxy type (such as J.B. Weld), or of the anaerobic-set, cyanoacrylate type (if there are appreciable voids to fill, the epoxy type is preferable) is applied to 3" or 4" of the barrel at one end. Now the sleeve tube is slid over the barrel until the ends of both tubes are level. The barrel assembly is laid on a level surface for approximately 10 minutes until the adhesive sets.

Any surplus adhesive should be removed from the outside of the barrel with a cloth, and then the five 3/4" collars can be fitted (see Photo 17). It may be necessary to polish the

first 4" of the barrel at the breech to allow the collars to slide on smoothly. Two collars are slid onto the barrel, followed by the retaining collar, which is removed from the upper receiver. Two more collars are fitted after the retainer, and the grub screws of all four collars are tightened to prevent them from moving. The last collar to be fitted should be level with the breech face of the barrel. The barrel-retaining collar remains loose, sandwiched between the two sets of collars. The barrel is now fully assembled, but before it is fitted to the receiver, a countersink cutter is used to bevel the entrance to the chamber (see Photo 18). This helps cartridges feed smoothly into the barrel. The exact width of the bevel is not critical; it should be between 1 and 2 mm wide. A round "ball"-type



PHOTO 17: Barrel fully assembled with all collars fitted.



PHOTO 18: Breech view of barrel. Note bevel around mouth of chamber.

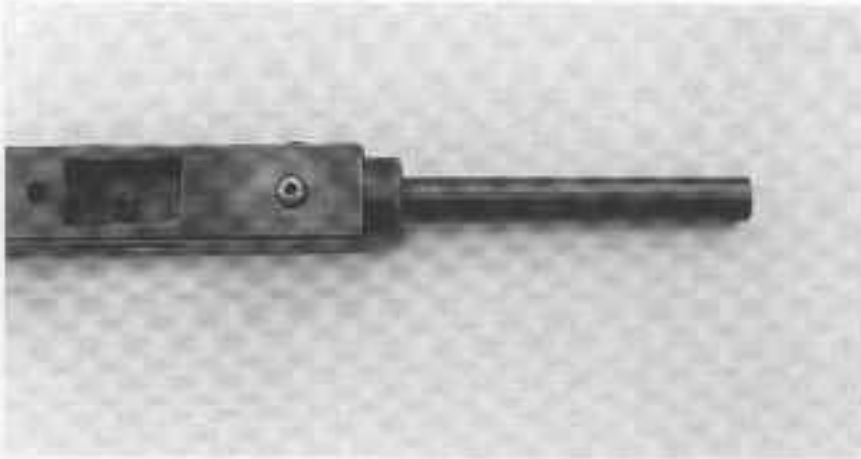

PHOTO 19: Barrel fitted to receiver.

grindstone for use in a hand drill (or a felt polishing tip with abrasive polishing compound) can also be used to create an extra smooth rounded entrance to the chamber. For cosmetic purposes, the countersink cutter can be used to bevel the muzzle for a professional finish. Now the barrel is slid into the front of the upper receiver (Photo 19) and secured in place with the four socket screws. The barrel may have to be rotated to line up the holes in the retaining collar with those in the receiver before the screws can be inserted, since the barrel will only fit on one way.

**NOTE:** Bearing adhesive is an extremely strong liquid retaining compound widely used in the car industry. It only sets when air is excluded, and so is ideal for retaining tight-fitting components such as bearings or bushings onto or inside a tube or bar. The uses are endless, even on the construction of improvised firearms. Its main advantage, though, is its incredible strength and the fact that it takes several minutes to set, allowing ample time for components to be assembled and adjusted. Bearing adhesive, or bearing fit, as it is sometimes

called, is available from nut and bolt suppliers, bearing manufacturers, car accessory shops, and good hardware stores. If high-strength adhesive is unavailable, medium-strength will do the job just as well for the purposes under discussion here.

In the unlikely event that no bearing adhesive is available, or if the barrel sleeve is the wrong gauge and too loose a fit, the barrel assembly can be silver-soldered together. This will require some low-melting-point silver solder and a propane gas torch. The silver solder is available from model engineering shops where model steam engine builders buy their supplies. Propane gas torches are widely available from most good hardware stores.

Some flux powder is mixed with a drop of water until it becomes a thick paste. The paste is applied to the barrel in the same way as the adhesive and the two tubes assembled. The fluxed area is heated with the gas torch until it becomes a light red color. The silver solder is touched to the hot steel in the area to be joined until the solder flows into the joint. The barrel is not quenched but allowed to cool on its own, and then any surplus solder is removed with a file and the area is polished with sandpaper. The barrel assembly should be soldered at the muzzle, since any heating of the breach area should be avoided. There is no danger of overdoing it, since too much solder is far better than not enough.

A thorough lesson in silver-soldering is not possible in the limited space available here, so it is advisable to practice on spare bits of metal first. Silver-soldering is a simple enough operation to master with a small amount of practice. Again, the only requirements are low melting-point silver solder, flux, and a propane torch.

# BREECH BLOCK CONSTRUCTION

With the barrel fitted to the receiver, we can continue to assemble and fit the breech block. I hope you will not be too bored with this chapter, as the construction of the breech block is—with a couple of exceptions—identical to that of the barrel. The breech block is assembled from a 5" length of 15.88 x 3.25 mm tube, a 4 1/4" length of 19.05 x 16-gauge tube, and six 3/4" collars—exactly the same

materials as used to make the barrel, the two exceptions being a 3"-long spring pin and a 2" length of round steel rod. You may not be familiar with spring pins, or "Seloc" pins, as they are sometimes called, so a brief description of them is in order. A spring pin is basically a tube made from spring steel with a slot down its entire length. When the pin is tapped into a hole, the slot allows the pin to

REMOVE TAPER



FLATTEN END



CUT TAPER INSIDE BOTH ENDS



CUT TAPER

FIGURE J  
SPRING PIN MODIFICATIONS



PHOTO 20: A taper is cut at both ends of the spring pin.

shrink slightly in diameter, making the pin a tight fit. Because the pin is of spring steel, it tries to return to its original diameter and so grips the wall of the hole. Unlike a conventional solid pin, the spring pin cannot loosen up and fall out due to wear. Spring pins are widely available from most good hardware stores and come in all diameters and lengths.

For our improvised breech block, a 1/2"-diameter, 3"-long pin is needed. First, as shown in Figure J, the taper must be removed from one end of the pin with a grinder so the end is completely flat. As with the reamer, if a drill press is available, the pin can be placed in the chuck and lowered onto a flat grit stone to ensure that the end is as flat as possible. Now the pin is clamped in a vise and a taper cutter (not a countersink) and electric drill are used to cut a taper onto the inside edge of the flat-ended pin until the very end of the pin has a 1 mm wall thickness. The pin is then turned around and another taper is cut into the other end of the pin until this end has a wall thickness of about 1 mm (Photo 20). This end of the pin should not be flattened, as it must keep its outer taper.

With the pin modified, the firing pin rod can be made and fitted inside the spring pin (see Figure K). The firing pin rod is made from a 2 1/4" length of 8 mm-diameter steel rod. A 2.5 mm hole, 1/2" deep, is drilled in the end of the rod, as close to the center as possible. This hole will eventually accept the firing pin. The rod is adjusted so the top of the firing pin hole is 2.5 mm below the flattened end of the spring pin, as in Photo 21.

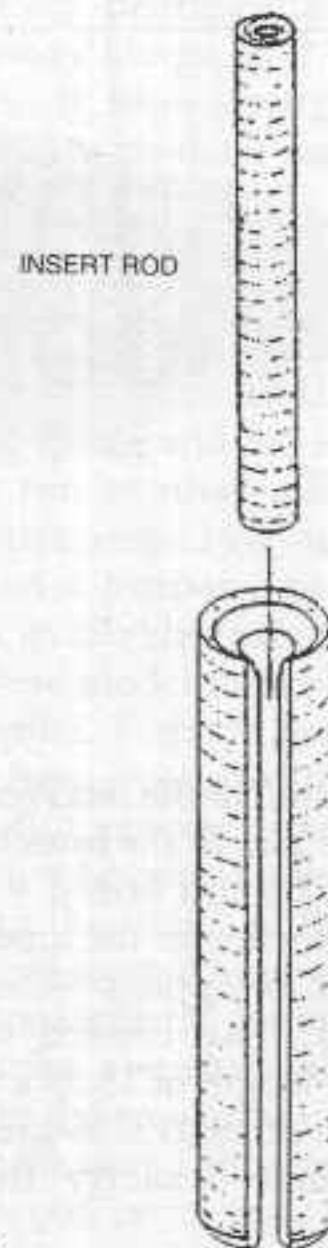

FIGURE K

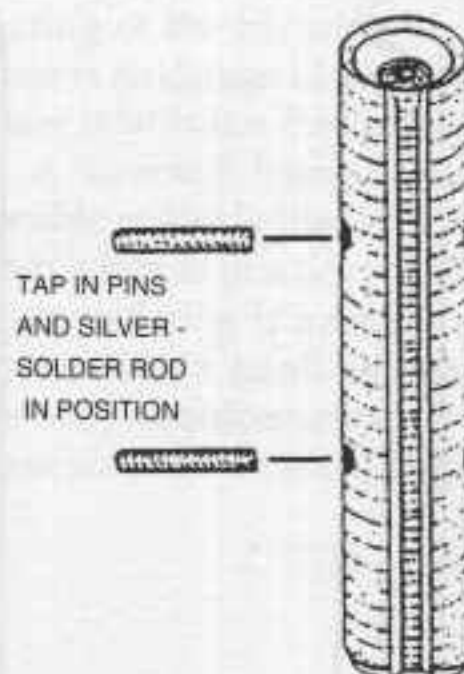

FIGURE L

## BREECH BLOCK CONSTRUCTION

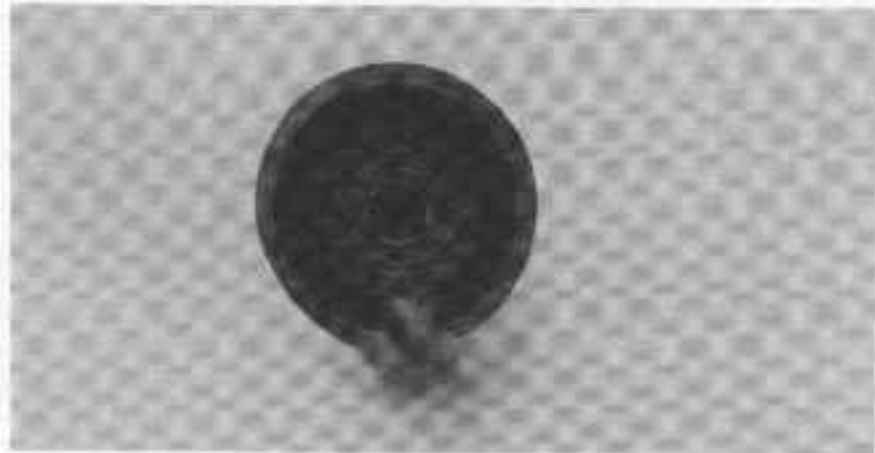
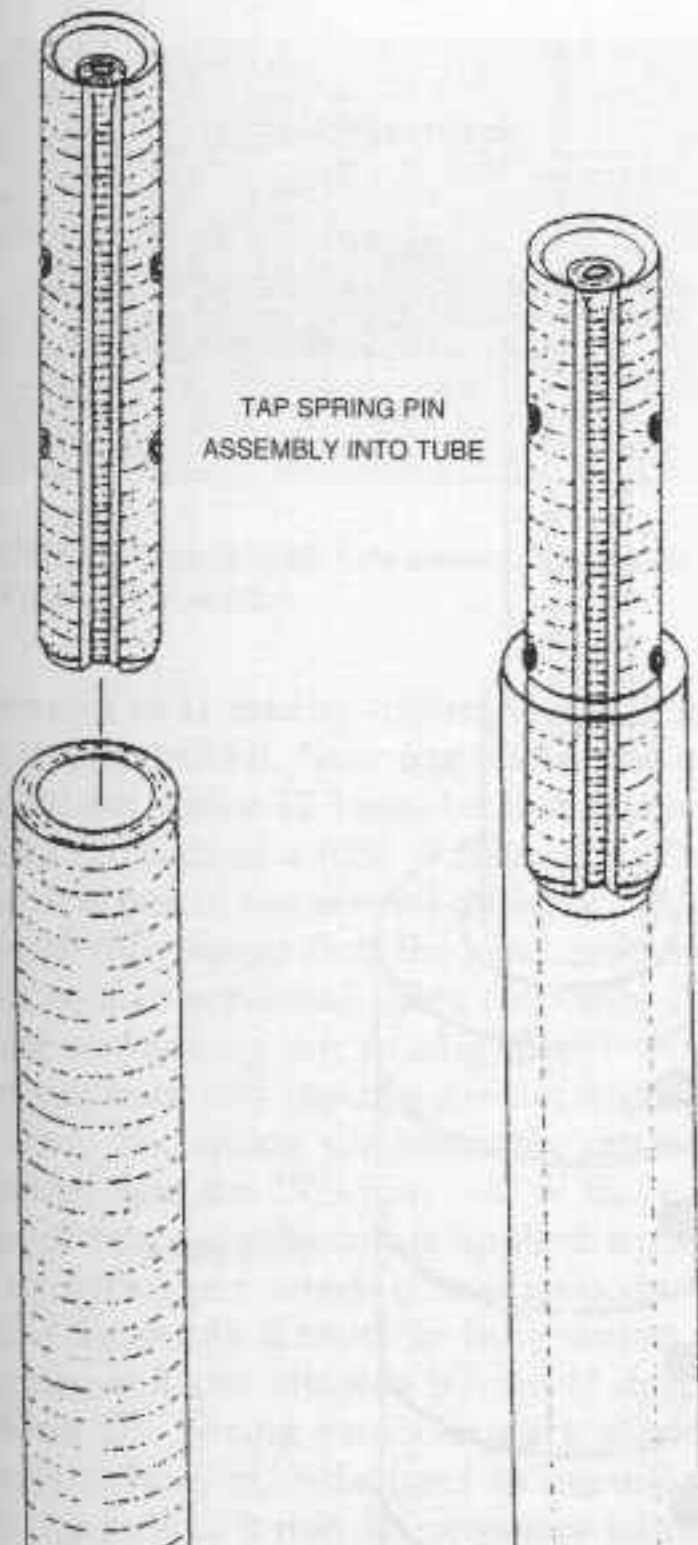

PHOTO 21: Firing pin rod fitted inside spring pin. The top of the rod should be 2.5 mm below the end of the spring pin.



PHOTO 22: The spring pin assembly fully seated in the breech block tube.

softening, it.) These are specially designed for drilling through tough steel and will make any drilling operation easy. If only standard drill bits are available, the spring pin can be softened by



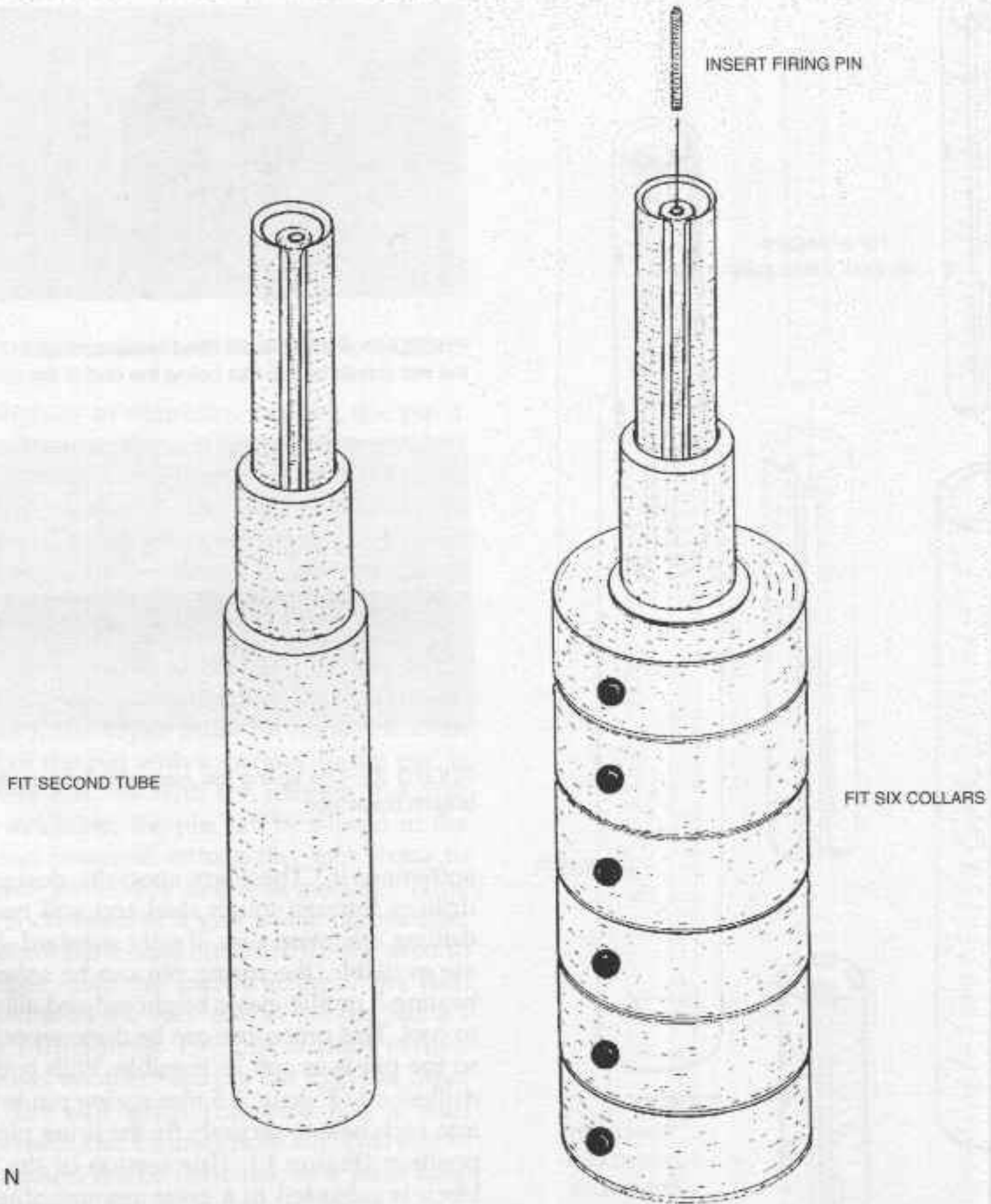

FIGURE N

so of the spring pin assembly is heated with a propane gas torch until the pin glows a bright red color. A stick of low-melting-point silver solder is applied to the top of the rod, and the solder is allowed to flow into the joint between the rod and the inside of the pin. As much solder as possible is allowed to flow into the joint, but not so much that it overflows onto the top of the rod. Don't worry too much if a small amount of solder sticks to the top of the rod,

because the solder will only be a few microns thick and will not interfere with the functioning of the weapon. After the spring pin assembly is allowed to cool, the pin is polished with sandpaper to remove any flux residue.

The firing pin will be fitted later, but for now the pin assembly must be put to one side and construction of the rest of the breech block begun. This requires a 5" length of 15.88 x 3.25 mm tube. The bore of the tube must be

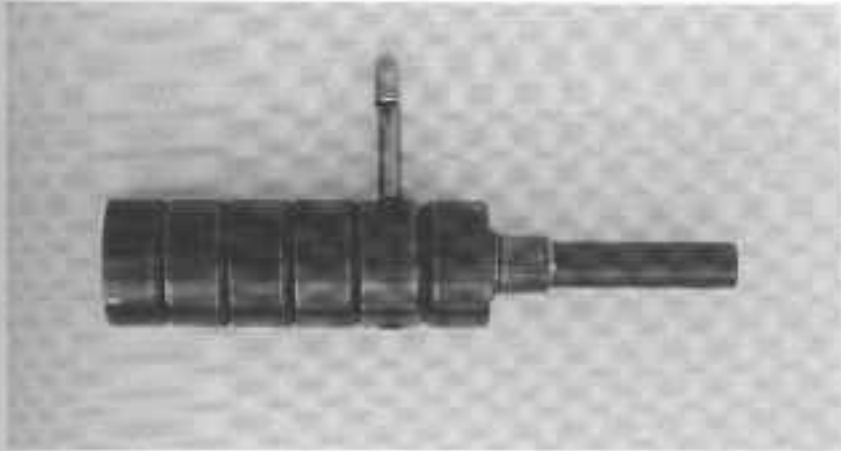

PHOTO 23: Breech block fully assembled with six collars and hook bolt in position.

increased to 11 mm by drilling through it with an 11 mm drill bit. Now one end of the tube is drilled out with a 12.5 mm bit to a depth of 1". When the bore of a tube is reamed out in this way, it is best to use several different drill sizes, each slightly larger than the last, until the final diameter is achieved. This prevents the bit from wandering out of alignment with the original bore and ensures greater accuracy in drilling. The spring pin assembly can now be inserted into the 12.5 mm end of the tube. A coat of bearing adhesive is applied to the end of the spring pin, which is then tapped into the tube (Figure M). It must be fully seated to the maximum depth allowed by the 1"-deep hole (Photo 22). Spring pins can vary slightly in diameter from manufacturer to manufacturer. For this reason, it may be necessary to increase the diameter of the hole to 12.6 or 12.7 mm before the pin can be tapped into position. The diameter of the pin should be measured and the correct drill bit chosen to make sure the pin assembly is a tight tap fit. Alternatively, the pin can be silver-soldered into position, though this is unnecessary providing the correct drill size is used.

Now a 4 1/2" length of 19.05 x 16-gauge tube is placed over the breech block tube and retained with adhesive or silver solder (see Figure N). It's important to check to be sure both tubes are level before the adhesive sets.

As shown in Figure N, six collars are now fitted over the 19.05 mm tube and secured in position by thoroughly tightening each grub screw. Each collar should touch the next, with



PHOTO 24: The ejector slot is deepened using a hacksaw blade.

the last collar being flush with the end of the tube. The second collar from the front of the breech block is now drilled to accept the cocking handle. The collar is removed from the block and the hole drilled through the collar wall opposite the grub screw. The hole should be drilled and tapped using the same drill bit and tap used for the socket screws. The collar is slid back onto the block, but the grub screw is not tightened. A hook bolt, which will serve as the cocking handle can now be screwed into the breech block. (See Photo 23.)

Some of the bolt's thread is removed so it will screw into the block fully. When the bolt is screwed in, the hook should be facing downward. With the cocking handle fitted, we can now turn our attention to the slot in the spring pin. This acts as a convenient channel for the cartridge ejector, which will be fitted in due course. Before the ejector can be fitted, the slot must be deepened slightly by about 1.5 mm. The block is clamped in a vise with the slot facing upward. Three hacksaw blades can be taped together and the blades run back and forth in the slot until the correct depth is achieved.

Alternatively, a large power hacksaw blade can be used for this purpose, which would make the job somewhat easier (Photo 24). These are available from most hardware stores, but you can get one free by sifting through scrap bins at your local engineering shop. The middle section of the blade will be blunt, but the useful 2 or 3" at both ends of the blade will be razor sharp. This is a perfect tool for cutting a narrow slot quickly.



PHOTO 25: Firing pin fitted. The firing pin should not protrude more than 1.5 mm.

If necessary, the slot can be trimmed up later using a small round needle file to create a smooth finish to the bottom of the slot. The firing pin is the last part of the block to be made. This is nothing more than the shank of a 2.5 mm drill bit. The firing pin must be 1 to 1.5 mm longer than the depth of the firing pin hole, so that the pin will protrude from the face of the breech block tapered recess by 1 to 1.5 mm. The pin is cut to length and a slight taper ground onto one end. A drop of bearing adhesive is applied to the other end of the pin and the pin is pushed into the firing pin hole. The pin should be checked to ensure that it is fully seated, as shown in Photo 25, and then the adhesive is left to set. The pin must not protrude more than the maximum 1.5 mm mentioned above (in other words, 1 mm lower than the end of the spring pin.) These measurements are important and must be checked before the pin is finally glued in

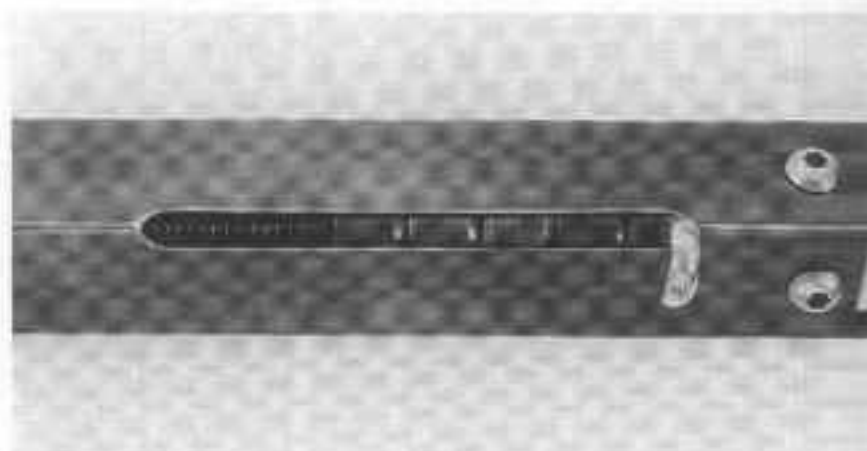

PHOTO 26: The breech block fitted in the receiver. Note how the hook of the cocking handle faces downward.

position. If the pin is too short, it will not fire the cartridge. If it is too long, it will snag on the base of the cartridge as the round travels from magazine to chamber. For these reasons, double-checking to be sure the firing pin is the correct length with its tip smoothly polished is advisable. The breech block is now finished.

The cocking handle is removed and the block slid into the rear of the receiver. The block is turned so the ejector slot is in alignment with the ejector hole in the left wall of the receiver. The block is held in this position and the hole for the cocking handle is turned in line with the slot in the right corner of the receiver. Now the collar grub screw is tightened to prevent any deviation from this position. The block is slid all the way into the receiver and the cocking handle is screwed in (Photo 26). Looking through the ejector hole will confirm that the slot is in alignment.

# THE EJECTOR

Providing no further adjustments are required, the ejector can be fitted. This is a modified screw, 6 mm in diameter, which is mounted to the left side of the receiver through the ejector hole. The front tip of the ejector fits into the slot in the breech block.

As the block recoils rearward upon firing, the ejector connects with the base of the case, flicking it out of the ejection port. A socket screw 6 mm in diameter and 3/4" long is required for the ejector, along with a couple of nuts to fit the screw. The end of the screw is filed evenly on both sides to create a flat blade about 1/4" long. The blade should be thin enough to fit the breech block slot. One edge of the blade is filed on a slight taper to create a pointed edge on the opposite side, as shown in Photo 27.

The breech block is pulled back to allow

access through the ejection port, and the ejector is inserted into the ejector hole (Photo 28). The ejector is turned so the pointed edge is facing the barrel, and the ejector is secured in position with the two nuts. This can be a bit tricky, since the nuts have to be screwed on through the ejection port. The second nut has two purposes: 1) to lock the first nut and prevent it from becoming loose, and 2) to give added support to the ejector. An Allen wrench is ideal for holding the ejector in the correct position while tightening the two nuts with a spanner (open-end or box wrench). The breech block should be slid back and forth to make sure it does not bind on the ejector. The point of the ejector blade should almost scrape the bottom of the slot to ensure that the ejector connects positively with the spent cartridge case.

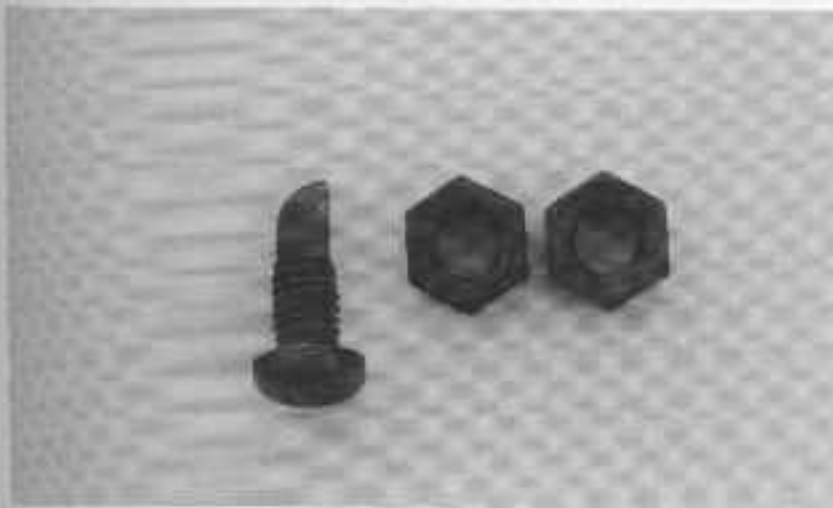

PHOTO 27: The ejector shown with two retaining nuts.



PHOTO 28: The ejector fitted to the receiver as seen through the magazine well recess.

## MAINSRING AND GUIDE

It is practically impossible to find the correct length, diameter, and strength of spring when one is required. The breech block mainspring must be long enough to keep the block closed when in the uncocked position and strong enough to cycle the action reliably. The diameter of the spring is also important, since it must fit into the middle of the hollow breech block. For this reason, it is far easier to make a suitable spring than look for one. To do this, a simple spring-winding machine must be built (see Figure O). The following readily available materials are required:

1. 1 1/2" dia. square tube, 17" long
2. 8 mm dia. all thread, 18" long
3. 6 mm dia. round bar, 18" long
4. 5/8" x 3/16" flat bar, 15" long
5. 8 mm dia. bolt, 3" long
6. 6 mm inside dia. steel collar

The first section of the machine to construct is the base. This is a 17" length of 1 1/2" square tube, although a slightly smaller or larger diameter tube can be used. Two 6 mm holes about 7" apart are drilled in the middle of the tubing. This will allow the machine to be bolted to a bench when finished. An 18" length of "all thread," or "studding," as it is sometimes called, is slid through the tube so 1/2" of thread is visible at each end. Now two 5" lengths of 5/8" x 3/16"

flat bar are cut and both bars clamped together in a vise. Both ends of the bars must be level with each other. A 6 mm hole is drilled through the bars 1/2" from the end. Because both bars were clamped together, the holes will now be in the same place. At the other end of the bars, an 8 mm hole is drilled 3/4" from the bars' end, again through both bars. Now the bars are slid onto the ends of the all thread protruding from the ends of the tube and secured in place with two nuts.

The base of the machine is now complete and the mandrel and winding handle can be assembled (see Photo 29). The mandrel is what the spring is wound around and consists of an 18" length of 6 mm-diameter round steel bar. First a 3 1/2" length of the 5/8" x 3/16" flat bar is cut, and, 1/2" in from each end of the bar, a hole is drilled, one 7 mm diameter, the other 6 mm. The 7 mm hole is tapped and an 8 mm-diameter bolt, 3 1/2" long, is screwed in; this is the winding handle. The same size tap can be used for the handle as was used earlier to fit the collars to the upper receiver. Now a small amount of bearing adhesive is applied to one end of the mandrel bar and the end of the mandrel is inserted into the 6 mm hole in the handle assembly. This assembly is put aside for about 30 minutes to allow the adhesive to set. A washer is slid onto the mandrel, and then the mandrel is inserted through the two mandrel support bars. The mandrel is secured

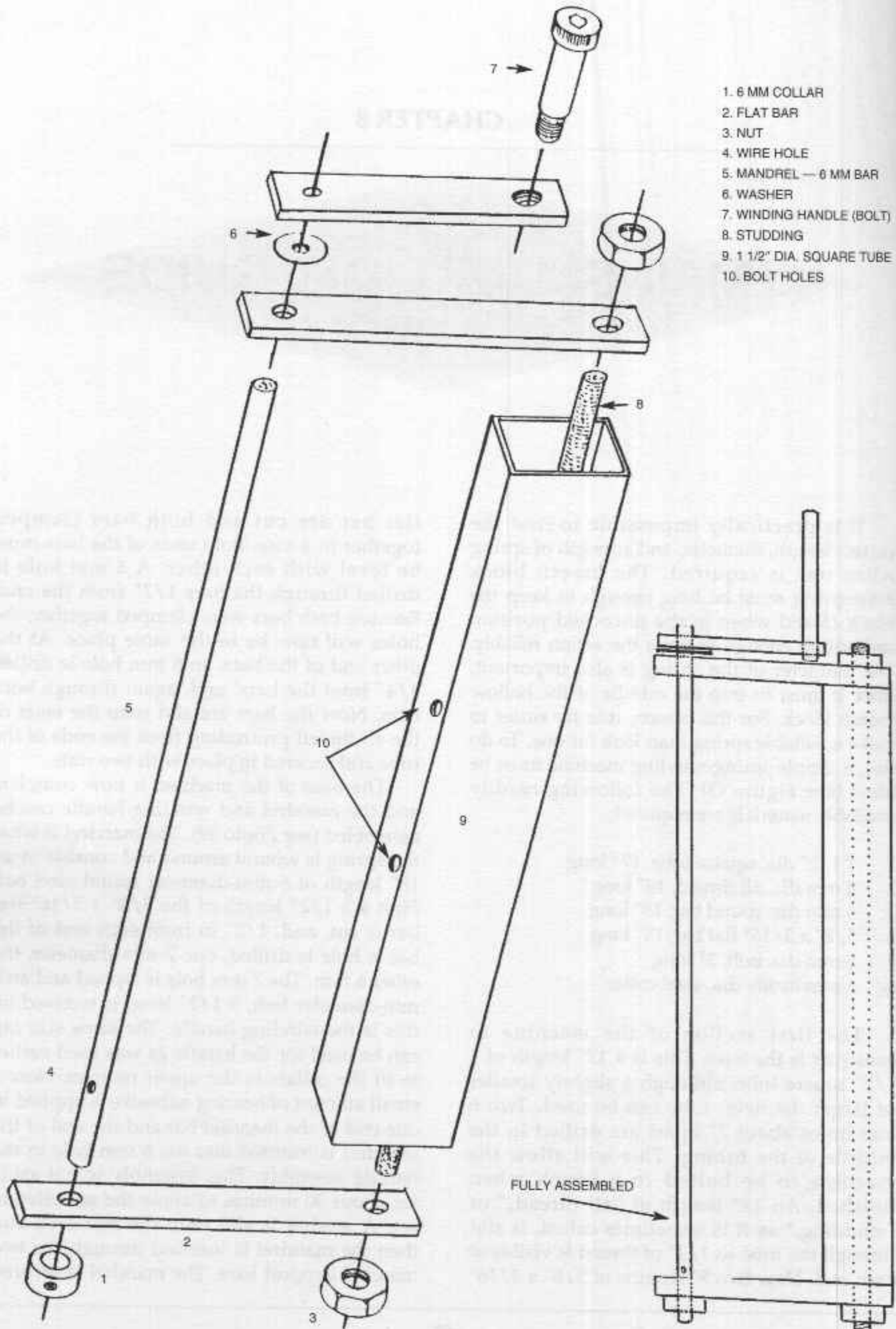

FIGURE O  
 SPRING-WINDING MACHINE

## MAINSRING AND GUIDE

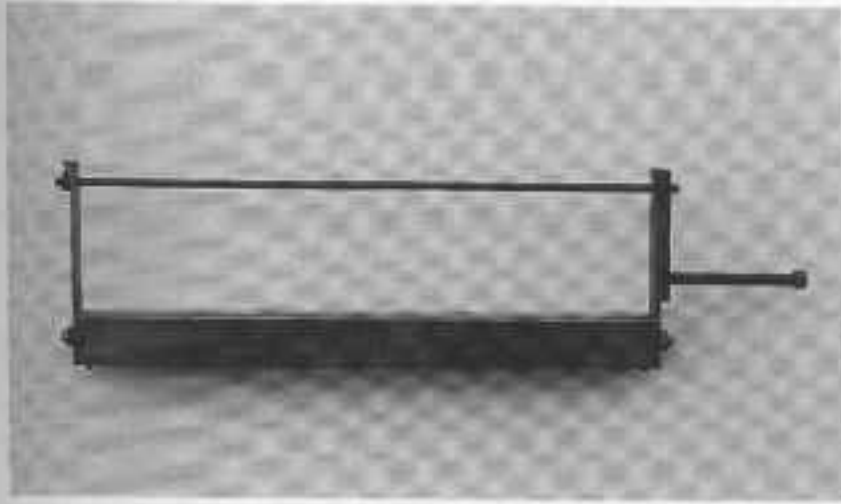

PHOTO 29: The spring winding machine fully assembled.

in place using a 6 mm steel collar. The mandrel should now revolve smoothly when the handle is turned.

Finally, a hole about 1.5 mm in diameter is drilled through the mandrel just inside the support bar at the opposite end to the winding handle.

The spring winder can now be bolted to a bench and the spring can be wound. It must be fixed to the edge of the bench to allow sufficient access to wind it. The mainspring is made from 19-gauge piano wire, or music wire, as it also called. Piano wire is available from good model engineering and music shops and is usually sold in 25' lengths. Depending on the shop, the wire may not be sold by gauge size but by diameter; if this is the case, the wire should be 1 mm in diameter, which is the equivalent of 19 gauge. If 19-gauge wire is not

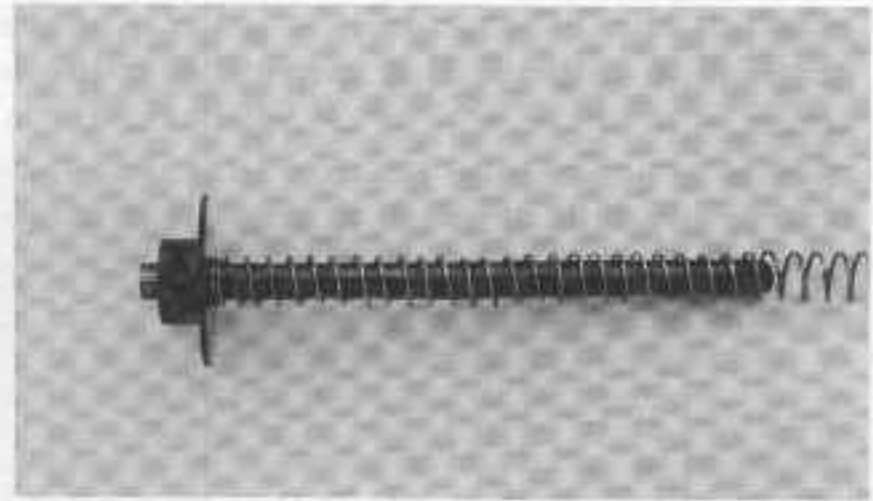

PHOTO 30: The mainspring and guide assembly. Note correct positions of washer and collar.

turn the handle and the left to guide the wire along the mandrel. Approximately a 4 mm gap should exist between each coil. This is achieved by holding the wire on a slight angle while turning the handle. First, the wire is stood on so that it is taut between the floor and machine. Then it is pulled on with the left hand so that it is angled slightly toward the winding handle. The handle is then turned in a clockwise direction such that a gap of about 4 mm is being created between each coil. This gap can be increased or decreased simply by adjusting the wire angle accordingly. The handle is turned until the spring reaches the end of the mandrel. The winding handle will now be under considerable pressure due to the tension of the newly wound spring and will try to spring back in the counterclockwise direction. The handle is held and slowly allowed to wind

mandrel and the mandrel pulled out of the machine to release the spring. Winding a spring is a simple and quick operation, but a practice run may be needed first. For this reason, it would be wise to buy two rolls of wire to ensure ample supply. The mainspring can now be fitted to the guide rod.

The guide consists of three parts—a 4 3/4" length of 7 mm-diameter steel bar, a 7 mm collar, and a 1 1/4" mudwing washer. First, a slight taper is filed onto one end of the 7 mm round

bar to allow the bar to pass freely through the inside of the spring. The collar is slid onto the opposite end of the bar so about 4 mm of bar is visible behind the collar. Now the collar grub screw is tightened and the washer inserted onto the bar's tapered end (Photo 30), followed by the mainspring. If a mudwing washer is not available with a 7 mm hole, an 8 mm hole will do, but the mainspring should not be able to pass through the washer hole. The guide and spring assembly is now finished.





## CHAPTER 9

# RECOIL SHIELD CONSTRUCTION

Before the guide assembly can be installed in the receiver, the last 3/4" collar in the rear of the upper receiver must be modified. We will call this the recoil shield, since it holds the breech block guide and spring in position in

the receiver. A 1 1/4" mudwing washer with an 8 mm hole is bolted onto the recoil shield with two 4 mm-diameter socket screws. The washer is bolted onto the rear face of the shield, so it is important that this side be marked as a reference while it is still in position in the receiver.

First, as in Figure P, the shield is temporarily sandwiched between two 1 1/4" washers by inserting a bolt through the middle of the shield and tightening the assembly together.

Two 3.3 mm-diameter holes are drilled through the shield, taking care not to drill through into any of the four socket screw holes. A 3.3 mm hole is the correct diameter to allow the holes to be tapped using a 4 mm tap. The

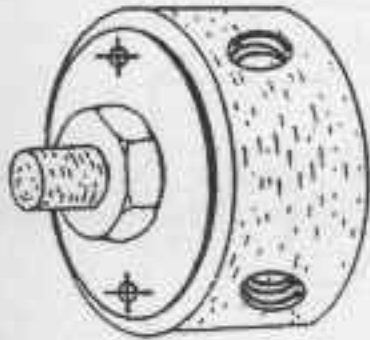

FIGURE P  
RECOIL SHIELD ASSEMBLY

BOLT WASHER TO RECOIL SHIELD

FULLY ASSEMBLED

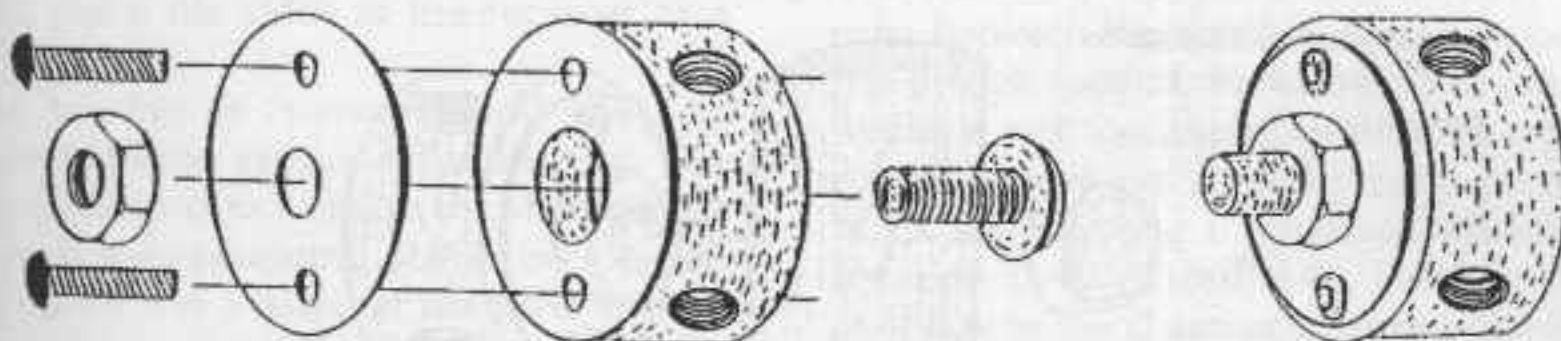

FIGURE Q

two washers are removed from the shield, and then one of the washers is fastened to the shield with the two socket screws. Next, an 8 mm-diameter, 1/2"-long socket screw is inserted through the washer and secured in place with a nut (Figure Q). The design of the weapon calls for a half nut for this purpose, a half nut being half the thickness of a common nut. These are widely available.

The spring guide and recoil shield can now be inserted into the receiver. The breech block is pulled back to the rear of the receiver and held in this position. The front of the spring and guide is slid into the rear of the block, followed by the shield. The spring must be held in the partially compressed position until the tip of the guide has entered the breech block. The recoil shield can now be secured in position with the four socket screws (Photo 31). The rear of the receiver is sealed and finished off, using a 2"-diameter mudwing washer. The washer is slid onto the protruding

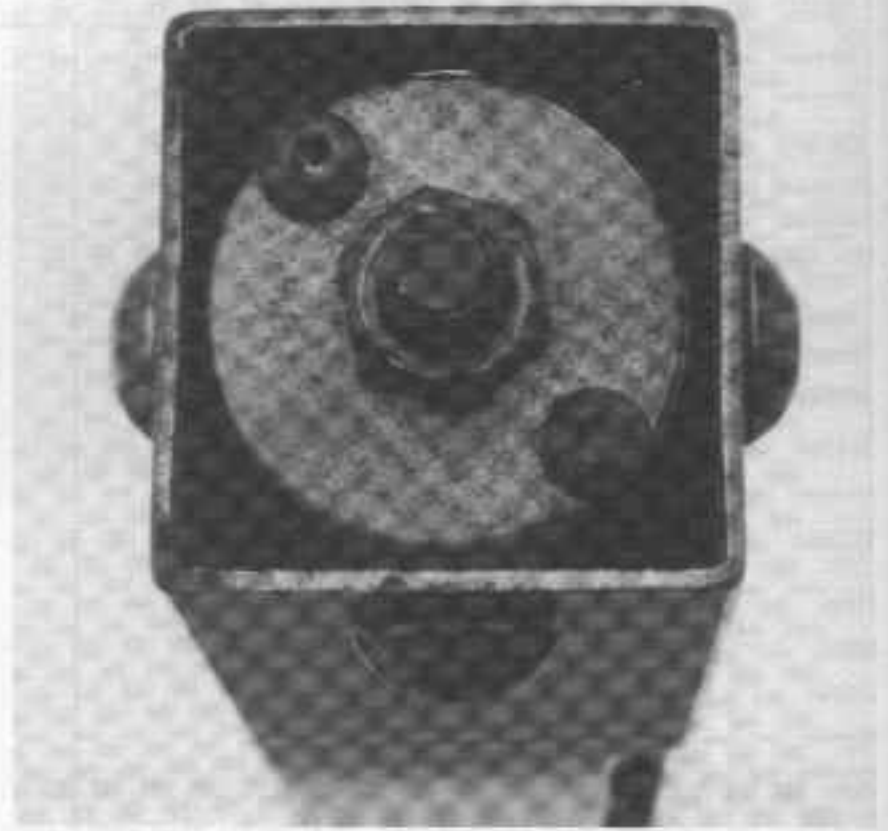
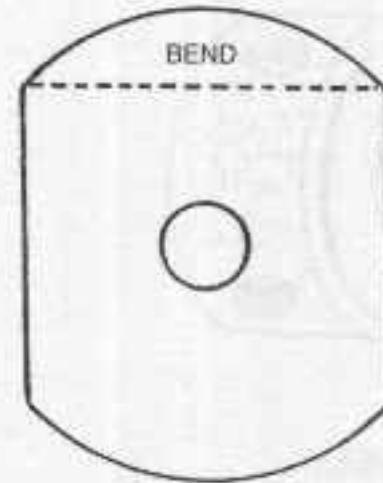
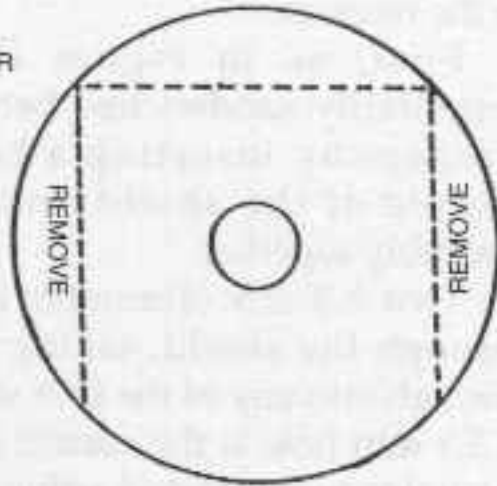

PHOTO 31: Rear view of upper receiver with recoil shield bolted in position.

2"-DIA. MUDWING WASHER



RETAIN MODIFIED WASHER TO SHIELD WITH DOME (ACORN OR CAP) NUT

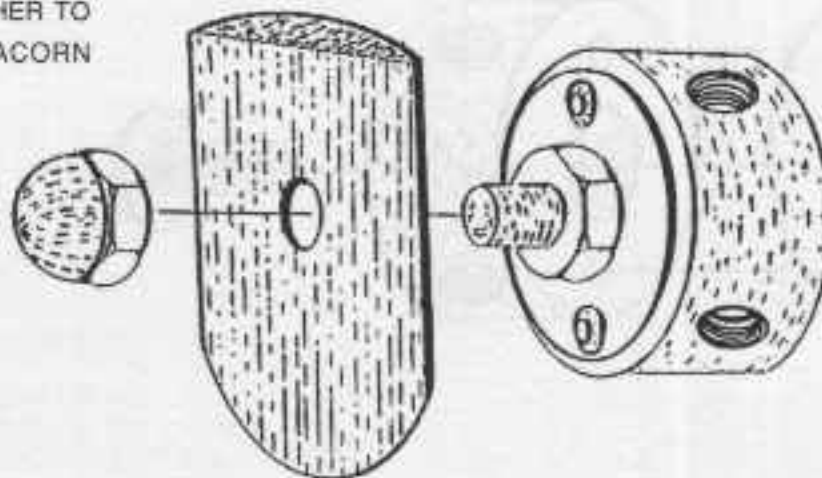

FIGURE R

## RECOIL SHIELD CONSTRUCTION

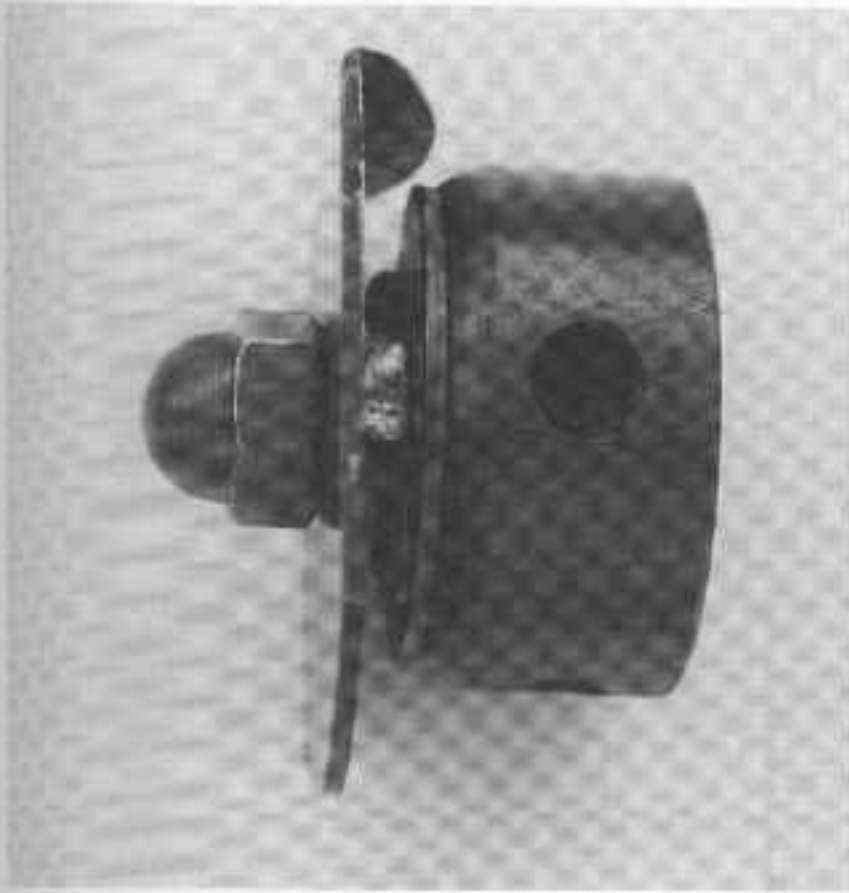

PHOTO 32: Complete recoil shield assembly.



PHOTO 33: Rear view of upper receiver with modified washer (end cap) secured in place with dome nut.



PHOTO 34: Fully assembled upper receiver with all internal parts fitted.

screw and secured in place with a dome nut. A line is scored down both sides and top of the washer, using the sides of the receiver as a guide (Figure R).

The washer is removed and the two marked-out side sections filed away. The washer is clamped in a vise so the vise jaws are level with the remaining score line. A flat-ended punch and a hammer are used to form the top of the washer into a lip. The purpose of the lip is to indicate which way to insert the shield. This makes assembly a much quicker operation. The washer must tighten against the

nut, *not* the rear of the receiver. The washer is polished to remove any sharp edges and secured back into position with the dome nut (Figure S); it is now called the end cap.

The upper section of the machine gun is now complete (Photo 34) and can be tested to make sure the breech block, guide, and spring are operating smoothly. The cocking handle is gripped and the breech block pulled fully to the rear of the receiver to check that the block does not snag or bind on any section of the receiver or guide rod. Any such defects must be rectified or the smooth functioning of the firearm will be jeopardized. With the block in the closed position, a small gap about the thickness of a thin piece of cardboard should exist between the front face of the block and the breech face of the barrel. The exact gap width is not too important, but as a general rule, sufficient gap should exist to prevent the block from hitting the barrels' breech if the weapon is dry-fired (i.e., fired without a cartridge in the chamber). Because the block is assembled from removable collars, the gap can be adjusted if necessary. The gap can be decreased by sliding the stack of collars back, or increased by sliding the collars forward.

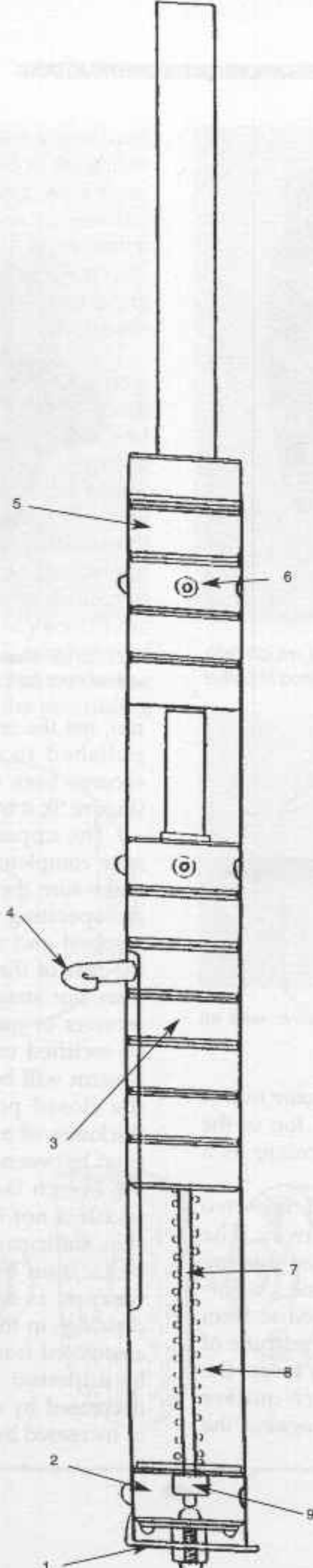

- 1. END CAP
- 2. RECOIL SHIELD
- 3. BREECH BLOCK (BOLT)
- 4. COCKING HANDLE
- 5. BARREL
- 6. BARREL RETAINING COLLAR
- 7. GUIDE ROD
- 8. MAINSPRING
- 9. COLLAR

FIGURE S  
FINISHED UPPER RECEIVER

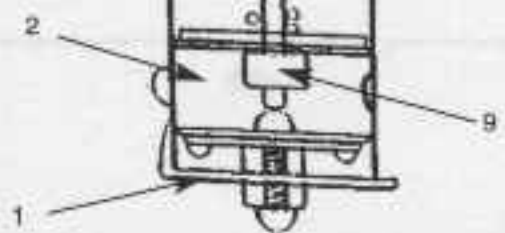

## RECOIL SHIELD CONSTRUCTION

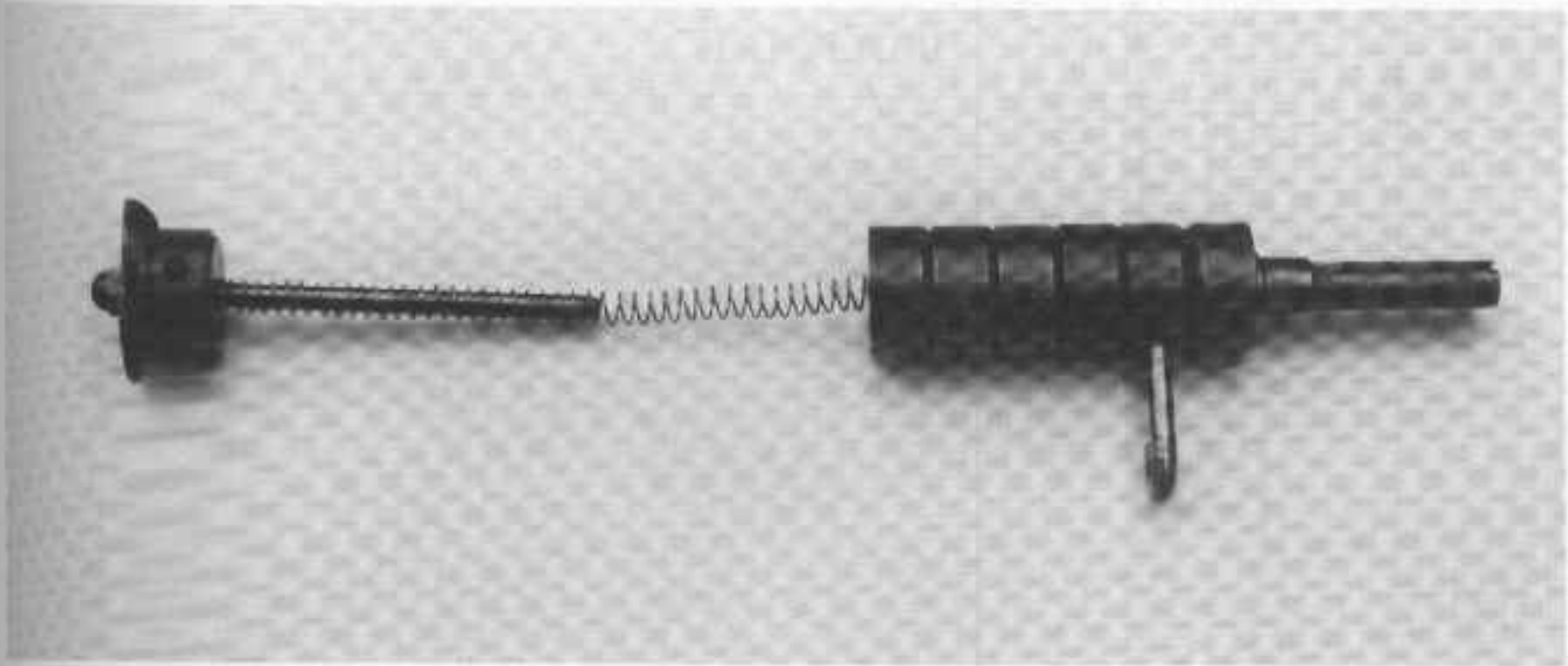

PHOTO 35: The recoil shield, guide, mainspring, and breech block shown in their respective positions.

With any necessary adjustments made, the completed upper receiver can be put to one side. Now the internal working parts can be fitted to the lower receiver.

# GRIP AND MAGAZINE WELL

The pistol grip is fitted first. The grip template must be copied, cut out, and then glued to a length of 40 x 20 mm ERW tube. Preferably the tube should have a wall

thickness of 2 mm, although a lighter gauge can be used.

The template (Figure T) is glued to the tube and the shape of the grip marked; then

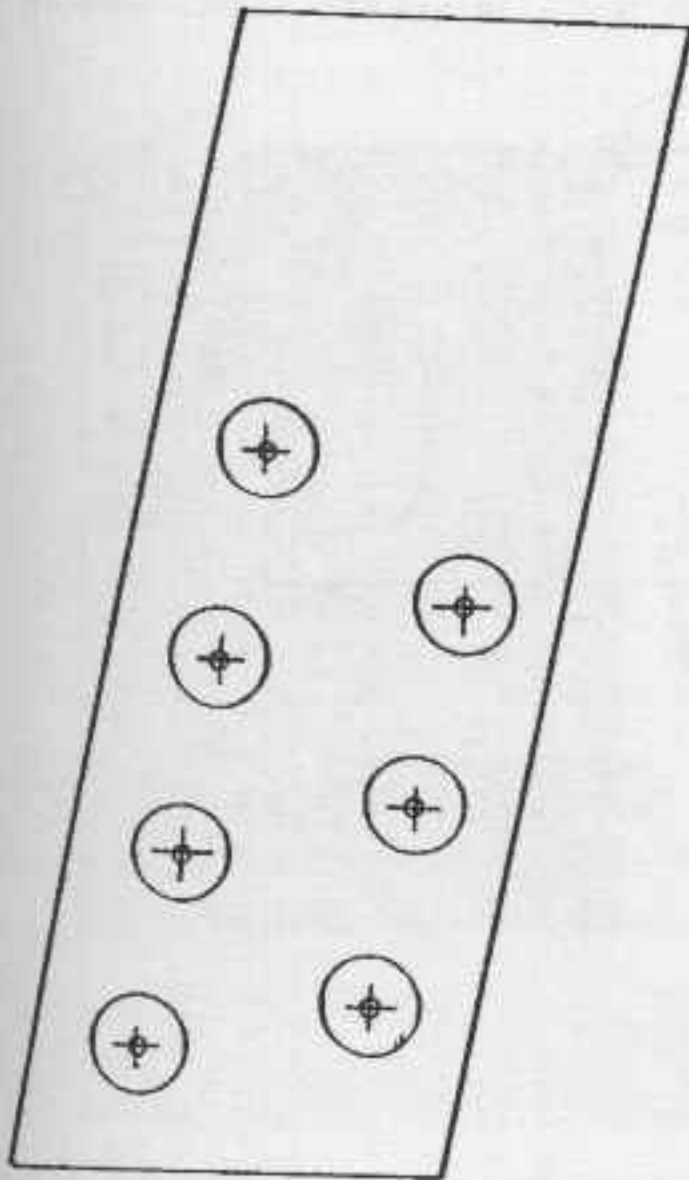

FIGURE T  
GRIP TEMPLATE

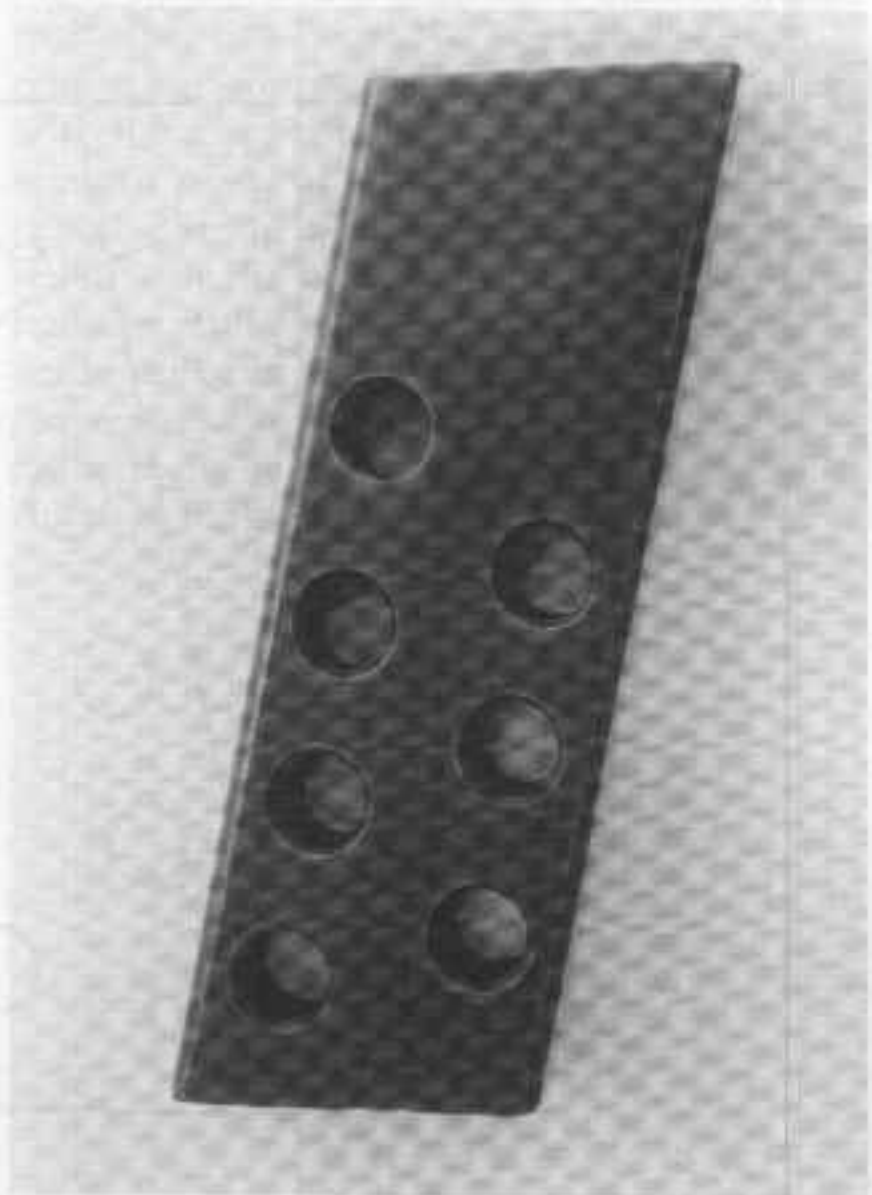

PHOTO 36: The finished pistol grip.

the positions of the seven holes are punch-marked. After the grip is sawed and filed to shape, a 10 mm drill is used to make the holes. Each hole can then be countersunk to enhance the appearance of the grip. (See Photo 36.) Before the grip can be inserted into the receiver, its width may have to be reduced slightly. The easiest way of doing this is to secure a large flat file to a workbench and rub the grip back and forth over the file. The grip should be a close slide fit. With the grip in position, a small gap about 1 to 2 mm should be visible between the top of the grip and the inside top of the receiver. (If a hacksaw blade can be slid into it, the gap is about right.) The grip is now fixed in position by drilling two 4 mm holes through the grip from one side of the receiver to the other. Two 4 mm spring pins, 1" long, are then tapped into the holes to secure the grip in position (Figure U). The position of the holes is not too important, so long as they are drilled just inside the curve of

the receiver. Next the magazine well can be made and fitted.

The magazine well is made from the same 40 x 20 mm tube used for the grip. The wall thickness of the well tube must be 2 mm, since the inside diameter of the tube is as important as the outside measurements. First, the tube is cut to an overall length of 2 5/8", making sure both ends are square. A line is scored across the side of the tube, 3/8" from one end, and this section is removed with a hacksaw. The end section of the tube is left intact, since this will be formed into the cartridge feed ramp. In Figure V, "A" shows the section of tube to be removed, and "B" is the template to which the contour of the feed ramp is bent. With the section "A" removed, the tube is clamped in a vise so that the top of the vise jaws is level with the bottom of the ramp. A hammer and punch are used to bend the ramp to the contour shown in drawing "B." The tube is removed from the vise several times during this

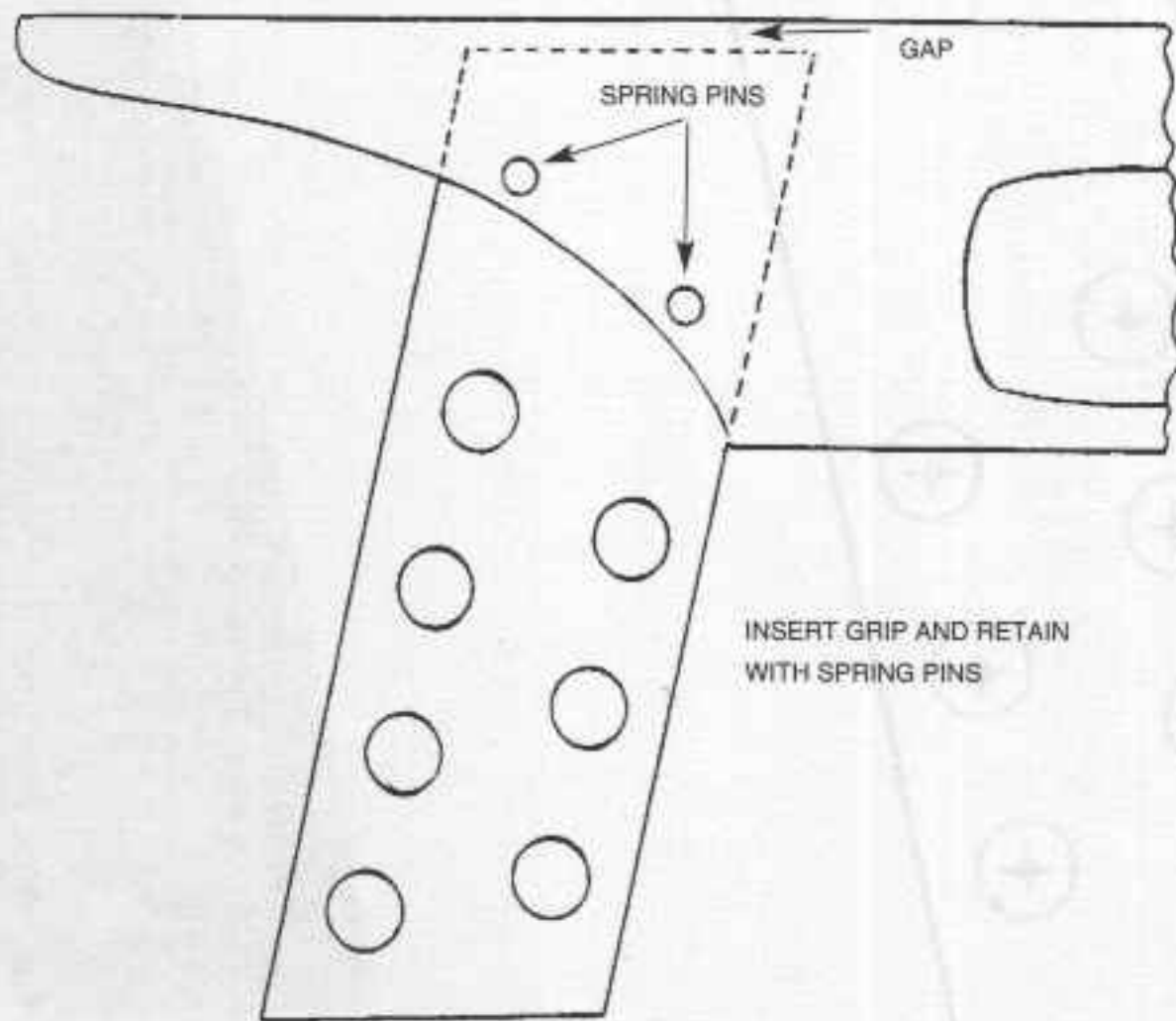

FIGURE U

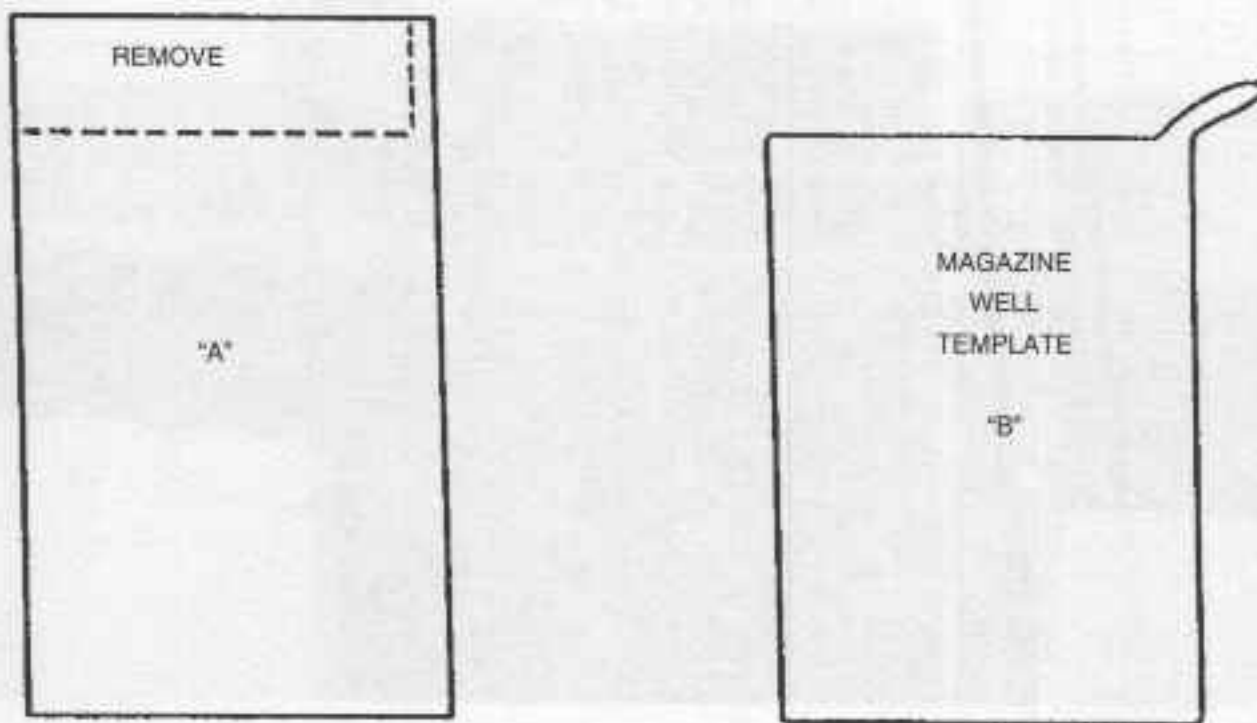

FIGURE V

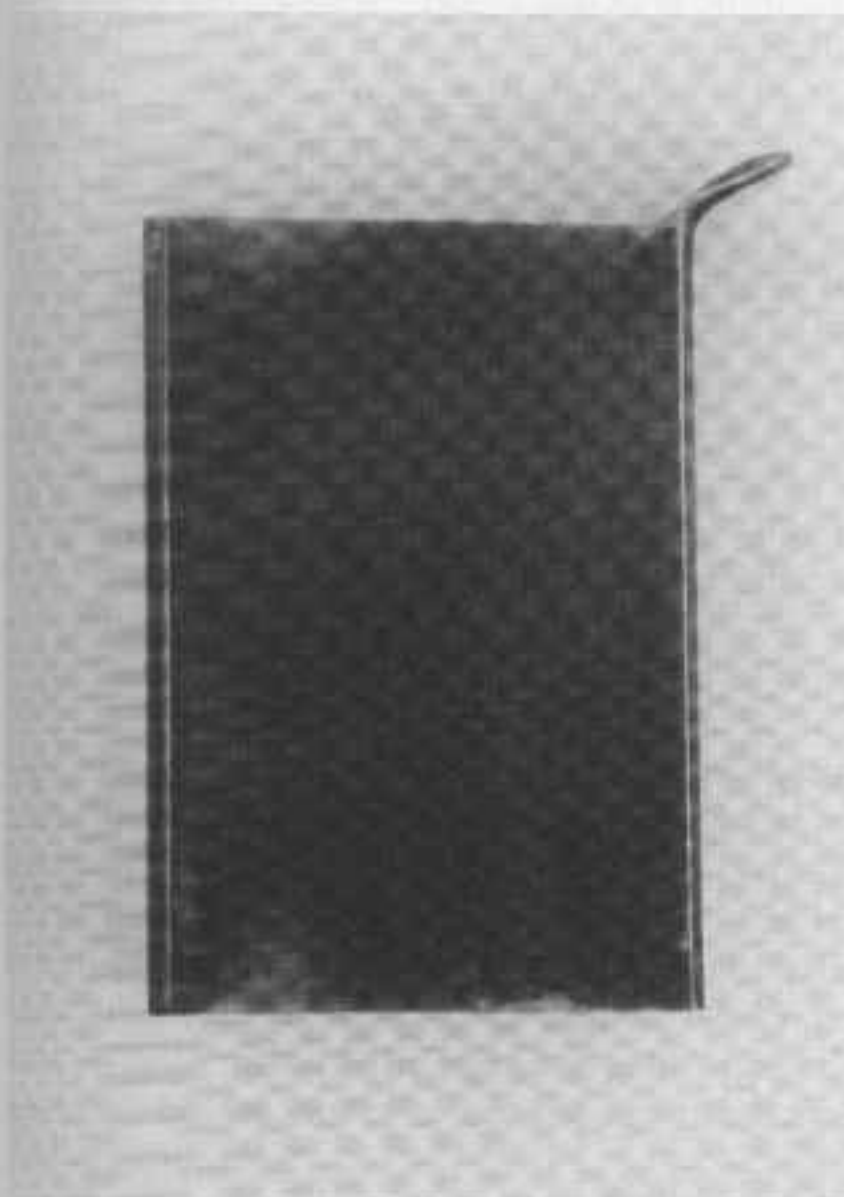

PHOTO 37: The magazine well with feed ramp bent to correct shape.

procedure and checked against the template. There is no need to remove the template from the book or copy it; the tube is simply laid over the template in the book until the two match each other (see Photo 37). The magazine well is now ready to insert into the receiver, but, as with the grip, it may need filing to ensure a smooth push fit. With the well in position (Photo 38), the bottom of the well should be level with the bottom of the magazine well housing. The well will eventually be glued or soldered permanently in place, but it must remain moveable for the time being should any adjustment be required when the weapon is fully assembled.



EXPEDIENT HOMEMADE FIREARMS

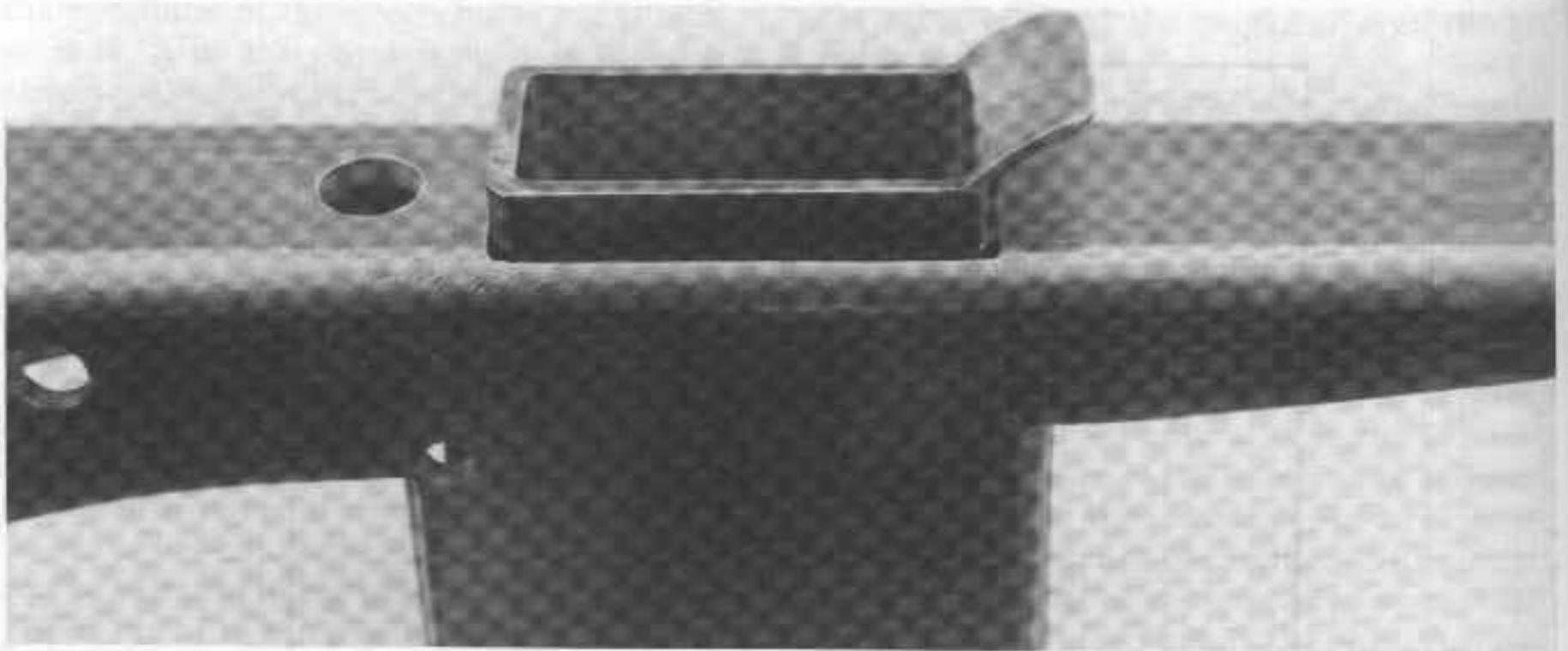

PHOTO 38: The magazine well, fitted in position.

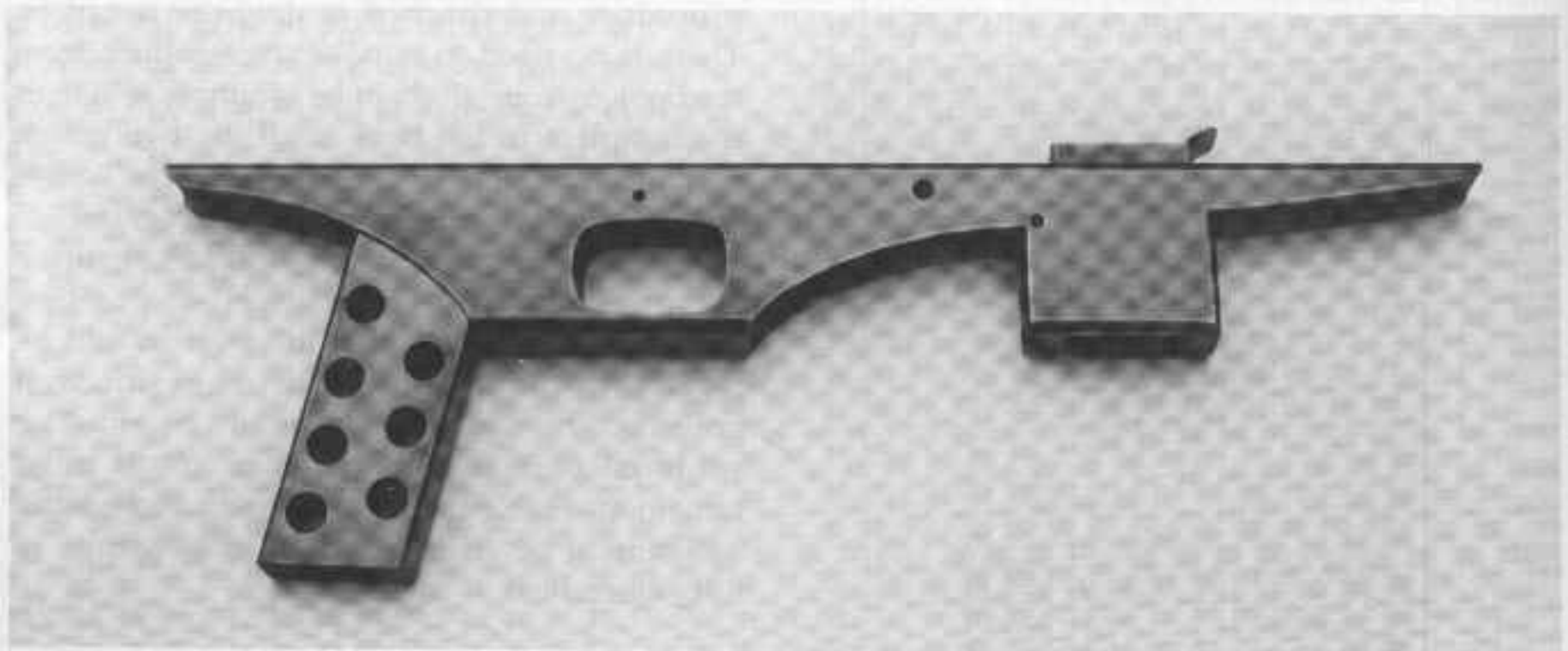

PHOTO 39: Side view of lower receiver with grip and well in position.

CHAPTER 11

---



THE SEAR

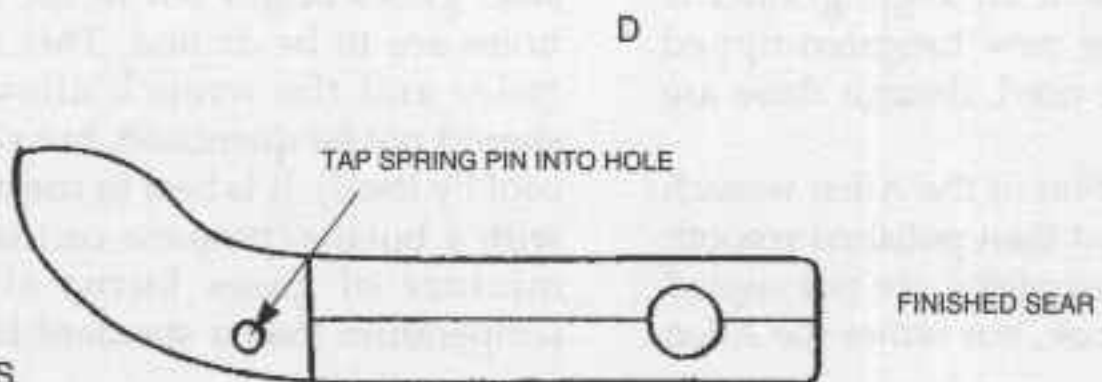
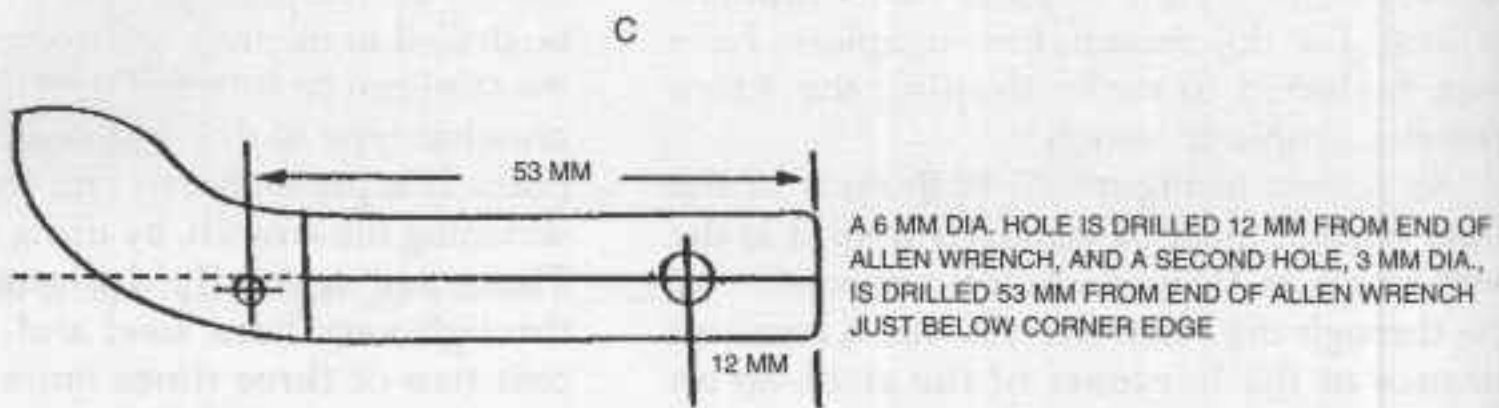
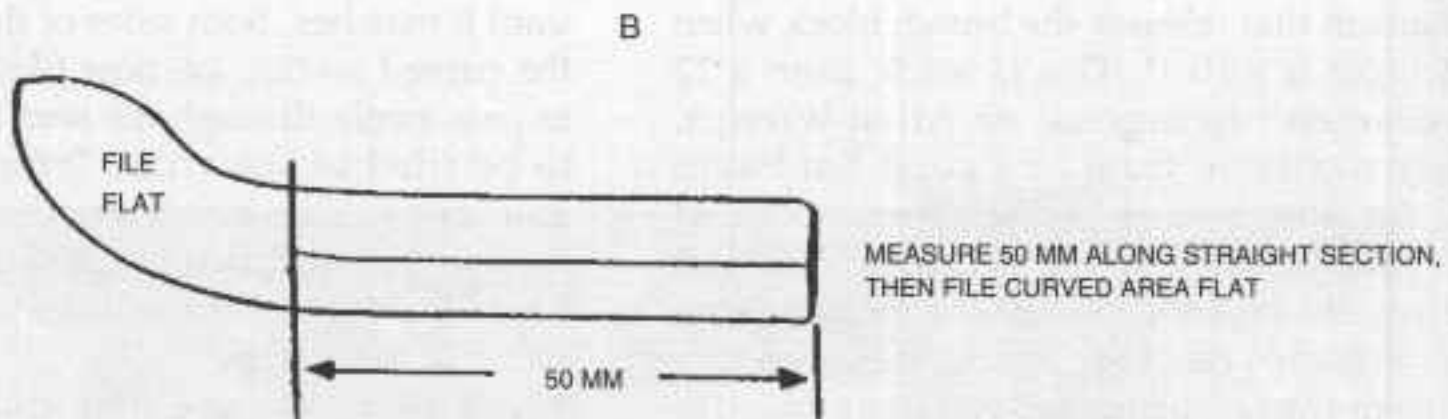
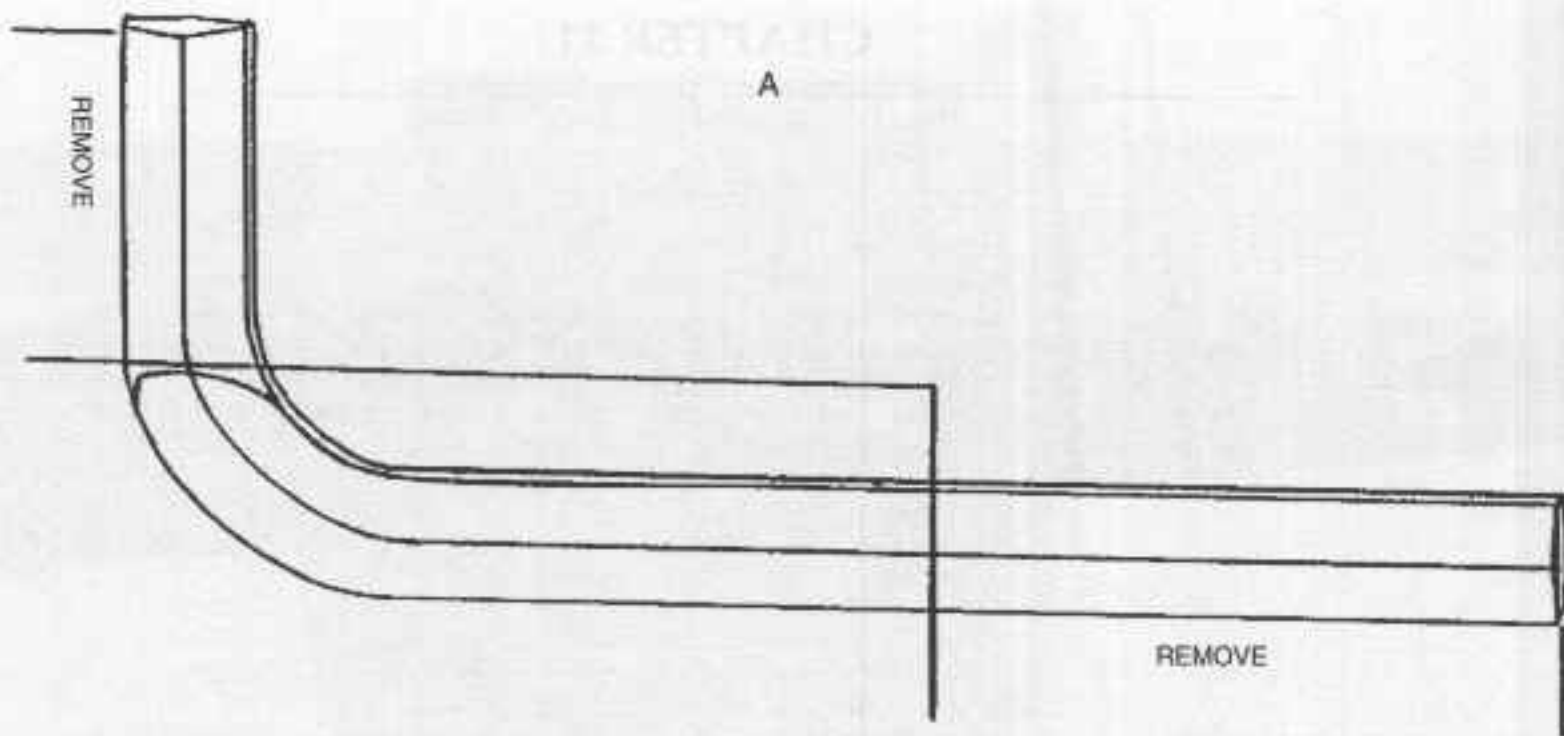

FIGURE W  
SEAR TEMPLATES

## THE SEAR



PHOTO 40: The sear before and after modification. Note the position of the spring pin.



PHOTO 41: Top side view of sear. The pin should protrude the same amount on each side of the sear.

This procedure will soften the wrench sufficiently so that the holes can be drilled using standard bits. Because the Allen wrench is a hexagon, the first hole (sear pivot hole) has to be drilled on an hexagonal corner. This cannot be done because the drill would simply slide off the corner.

Using a round file, a shallow flat area is cut at the point where the hole is to be made. Initially, a 2 mm-diameter hole is drilled 12 mm from the end of the wrench, as shown in Template C, and then the hole is redrilled to its final 6 mm diameter.

The second 3 mm hole is drilled 53 mm from the end of the wrench through the flat area. The hole is situated as shown in Template C, just below the key's corner edge. The exact position of this hole is not too important, so long as it is somewhere near the position shown. Now a 3 mm spring pin, 3/4" long, is tapped through the hole until an even section of pin is visible on either side of the Allen wrench (Photos 40 and 41). The sear is now ready to be fitted inside the receiver with a 1 1/4"-long socket screw. A dome nut is used to retain the screw in position.

## CHAPTER 12

# THE TRIGGER

The trigger is cut from a 3 x 2" section of 3 mm-thick steel plate. A copy of the trigger template (Figure X) is made, carefully cut out, and glued to the steel plate. The shape of the trigger is marked onto the steel and then the position of all the holes punched in the usual way. The trigger is sawed out with a hacksaw and filed to the shape indicated by the score lines. The trigger pivot hole is drilled to a diameter of 4 mm and the other three larger holes to a diameter of 6 mm (Photo 42).

The larger holes are for cosmetic purposes only, and, although they enhance the trigger's appearance, are optional. Each of the three holes can be countersunk on each side to add a professional finish to the trigger. The curved

finger section of the trigger should be rounded and polished smooth to create a comfortable feel when the trigger is pulled.

The trigger is inserted into the guard and secured with a socket screw or bolt (Photo 43). The long leg of the trigger rests on top of the pin protruding from the right side of the sear. When the trigger is pulled the sear is pushed down and out of engagement with the breech block. If the machine gun is to be fired by someone who is left-handed, the trigger can be fitted to the left side of the trigger guard without any additional alterations. A certain amount of hand fitting can be expected to fit the trigger and sear to ensure that both parts operate smoothly.

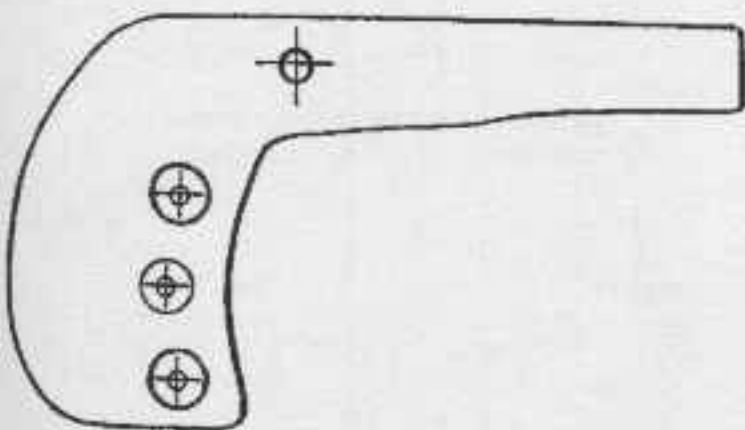

FIGURE X  
TRIGGER TEMPLATE



PHOTO 42: The trigger with all holes drilled.



## CHAPTER 13

# THE MAINSPRING

With the trigger and sear in position, the lower receiver mainspring can be made and fitted. I call this part the mainspring because this single spring operates the trigger and sear as well as acting as the magazine release catch (Photo 44). The spring is made from a 9 1/2" length of 1/2"-wide spring steel strip. As the name suggests, this product is a length of metal made from spring steel, the same material used to wind the coil spring we made earlier. It is available from model engineering shops and used extensively to make flat leaf springs for model steam engines and such.

Many different gauges of spring strip are available, but for the mainspring, 24-gauge is required. The spring steel is cut to a length of 9 1/2" using an angle grinder, or, alternatively, the steel can be bent by hand until it snaps in

two at the required length. Figure Y shows the contour to which the spring is bent. This is done by hand; a hammer or vise could break the spring. Bending the spring back and forth should be avoided, since this will weaken the material also. The spring steel should be bent in one direction only, until it matches the shape of the drawing as closely as possible.

A hole is now drilled through the spring 12 mm from the end. The hole will accept the magazine release catch and should be drilled first to a diameter of 2 mm, then redrilled to a diameter of 6 mm. A 1" mudwing washer with a 6 mm hole is now placed each side of the hole and a short 6 mm-diameter hexagon-head bolt inserted through the assembly. A nut is screwed onto the bolt, but before it is tightened a flat side of the bolt head is positioned horizontally to the length of the spring.

A taper is now filed onto the bolt head and the tapered section polished smooth. This is the magazine release catch. The taper allows the magazine to slide over the bolt head when the magazine is inserted, while the opposite, flat side of the bolt head prevents the magazine from falling out (Photo 45).

The mainspring is now ready to fit into the receiver. The end of the spring is inserted into the gap above the grip, and then the magazine catch is pushed upward and forward into the catch groove. While the catch is held in this

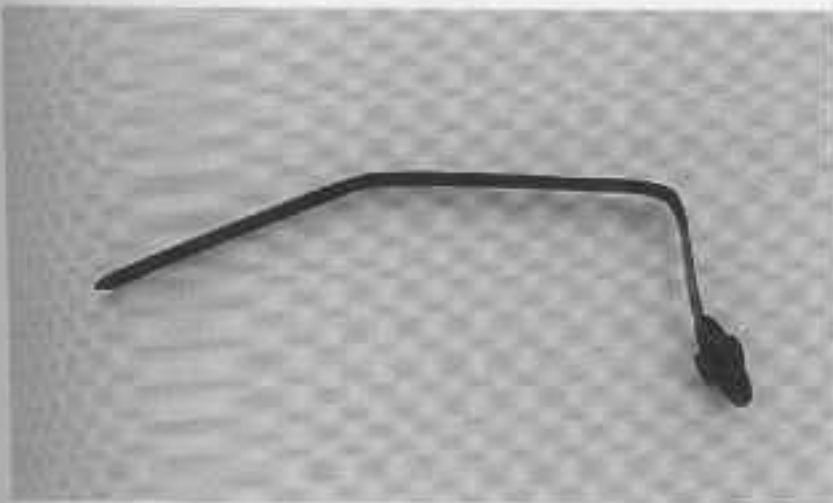

PHOTO 44: The lower receiver mainspring fitted with magazine catch assembly.

EXPEDIENT HOMEMADE FIREARMS

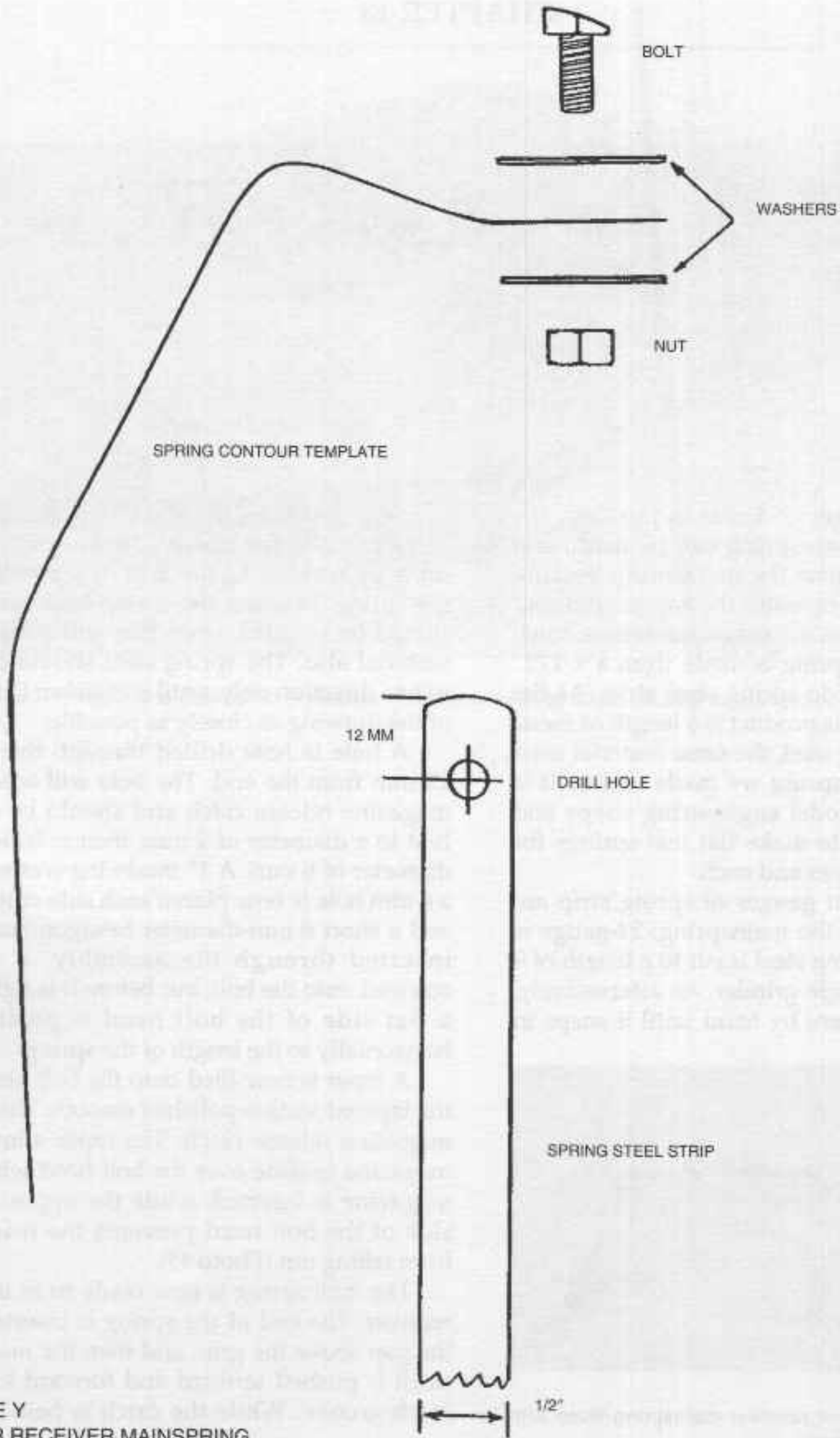

FIGURE Y  
LOWER RECEIVER MAINSPRING



## THE MAINSPRING

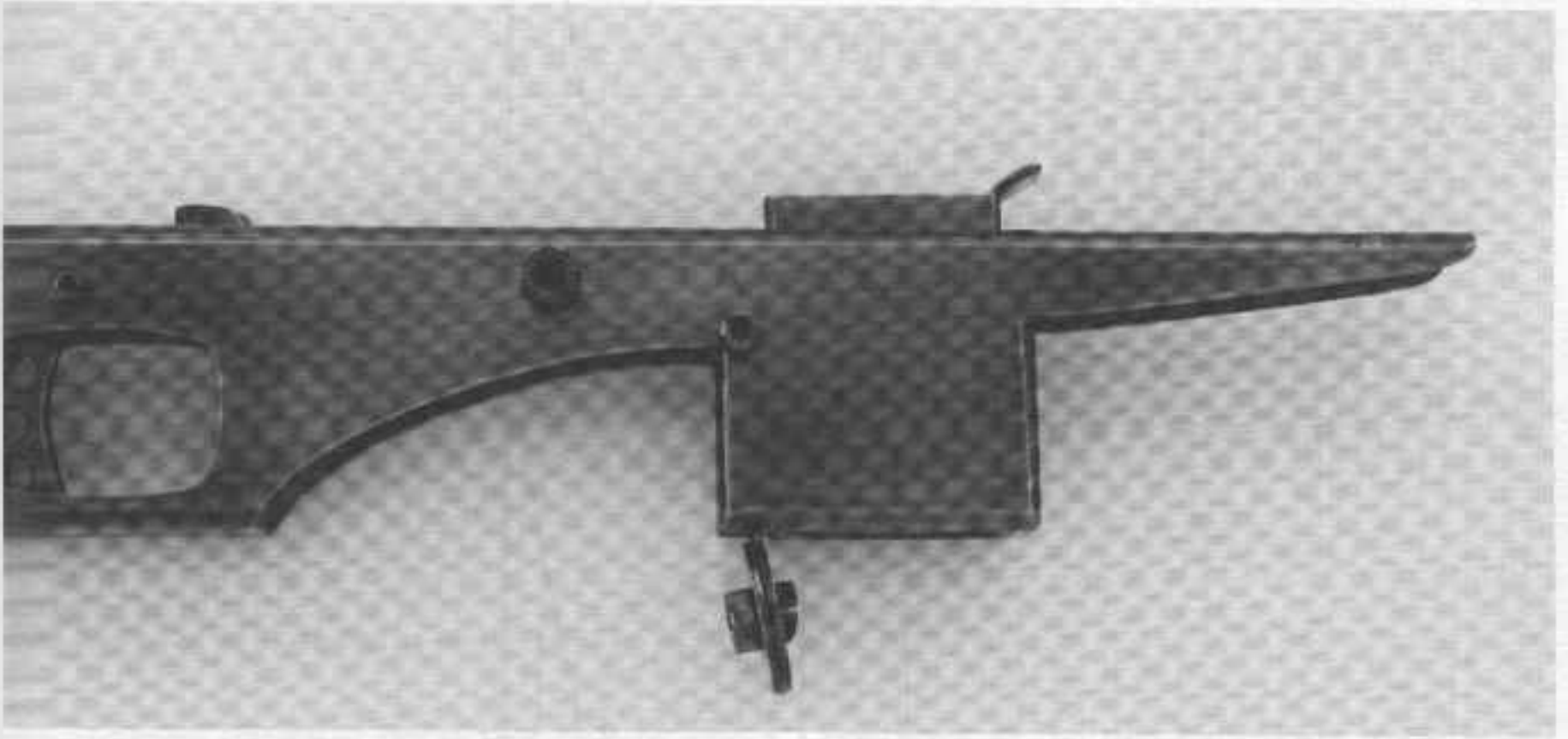

PHOTO 45: The mainspring fitted in position. Note the slight forward angle of the magazine catch.

position, a 4 mm-diameter screw or bolt is inserted into the catch hole and secured with a dome nut. I should point out here that the spring fits over the trigger pivot bolt, effectively hiding the bolt from view.

Sufficient clearance must exist between the side of the trigger leg and the sear, or the two parts will bind. The release catch should be under pressure from the spring resting firmly

against the bottom of the catch groove. Also, there should be a clearance of about 2 mm between the top of the catch washers and the bottom of the magazine well. This is important, because without this gap it will not be possible to operate the catch. Assuming the internal parts of the receiver (Figure Z) are working smoothly, construction of the final section of the machine gun can proceed.

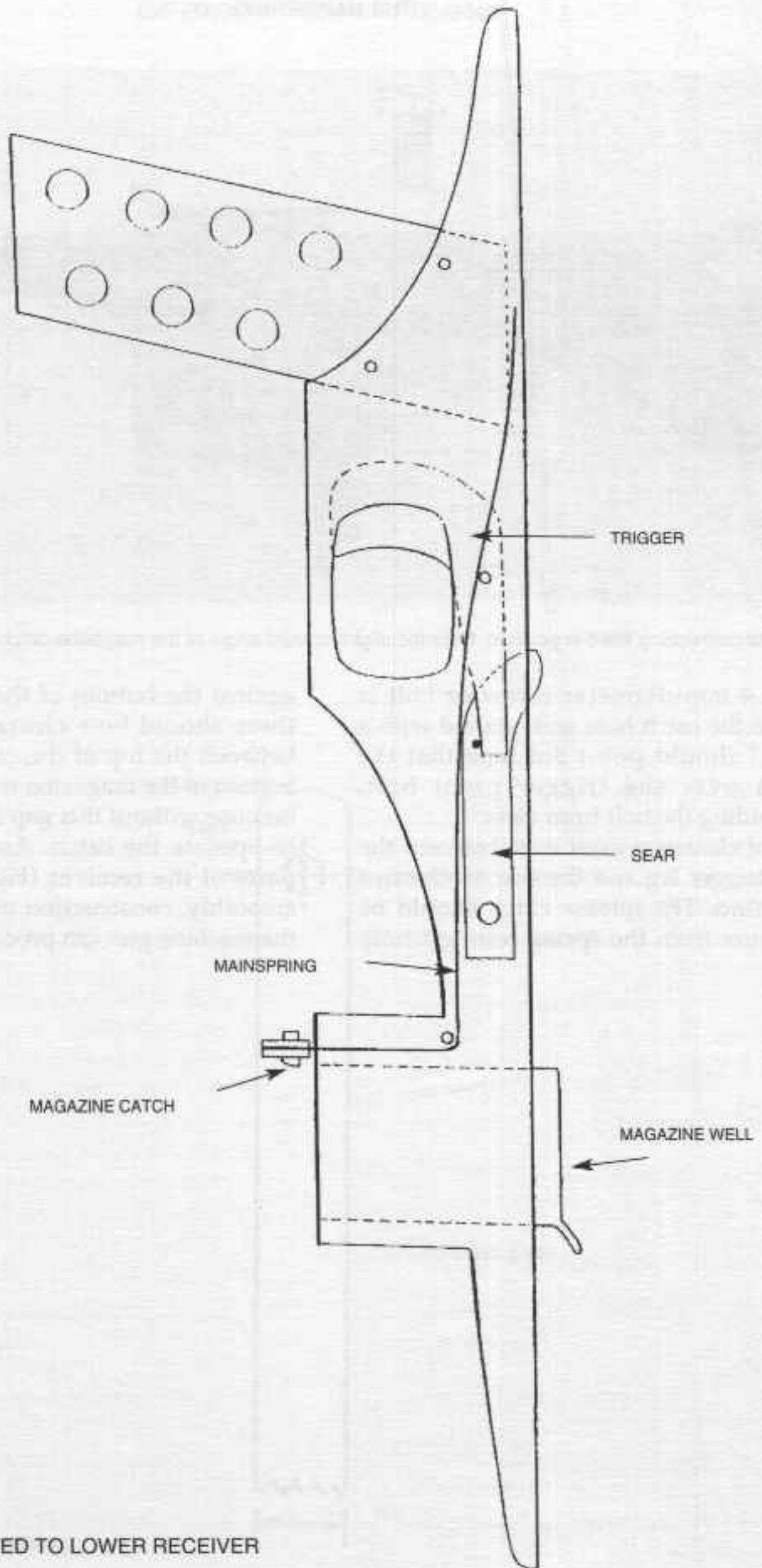

FIGURE Z  
 INTERNAL PARTS FITTED TO LOWER RECEIVER

# MAGAZINE CONSTRUCTION

Probably the most important part of any automatic firearm is the magazine. Without it, the machine gun or semiautomatic can be no more than a single-shot weapon. Making a magazine in the usual way by bending a section of sheet steel around a forming block is a difficult and time-consuming process. We will not discuss this method of construction here, as it is not my idea of an easy-to-make improvised magazine. As with the other major component parts, a perfectly functional magazine can be made from a length of 34.93 x 15.88 mm ERW 16-gauge tubing (i.e., 35 x 16 mm tube). The magazine is of a single-stack design, holding 18 rounds of 9mm ammunition. While this is a lower capacity than the 20 or 25 rounds of most factory-made twin-stack designs, the simplicity of manufacture more than compensates for the reduced firepower. Let's face it—if 18 rounds of fully automatic fire cannot satisfy your requirements, you need a bazooka, not a machine gun!

The tube must be cut to a length of 9", then cleaned and dried. A copy of the magazine template (Figure AA) should be made and, after being cut out carefully, glued to the side of the tube. The only score line needed is the curved section at the top of the template. Now the point of a punch is placed in the center of the 16 crossed holes and hit with a hammer. This will mark the positions of the cartridge counting holes ready for drilling. The

positions of the two base plate holes at the bottom of the template are also marked by the same method. The template is removed and the marked out section at the top of the magazine tube can be removed with a saw and a round or half round file.

A slot is now cut into the rear of the tube, 7 mm deep and as wide as the tube walls will allow. A 5 mm-diameter drill is used to make 16 viewing holes in the position marked earlier. The holes can be drilled through one side only or through both sides of the tube. Alternatively, the holes can be ignored completely, though they are very useful for quick observation as to whether the magazine is full, empty, or anywhere in between. The two base plate holes are drilled through both sides of the tube with a 3 mm bit. Drilling the viewing holes will create a series of burrs on the inside of the tube, and these must be removed. A flat file is inserted inside the tube and used to remove any burrs, so that the inside of the tube is perfectly smooth.

The magazine lips, which hold the cartridges inside the magazine, can now be formed to shape. Before this can be done, a simple forming block must be made (Photo 46), around which the lips are bent. The forming block is made from a 10" length of 1 x 1/2" flat steel bar. One end of this bar must be filed to the contours shown in Figure BB. The simplest way of doing this is to secure a large flat file to

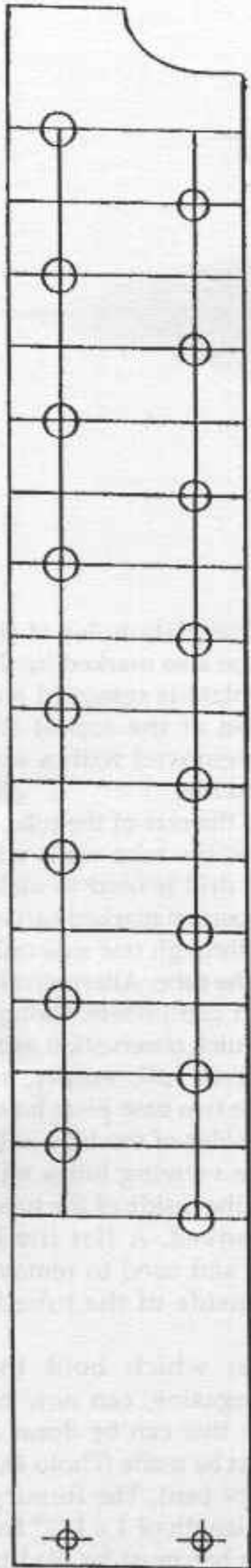

FIGURE AA  
MAGAZINE TEMPLATE

REAR SLOT

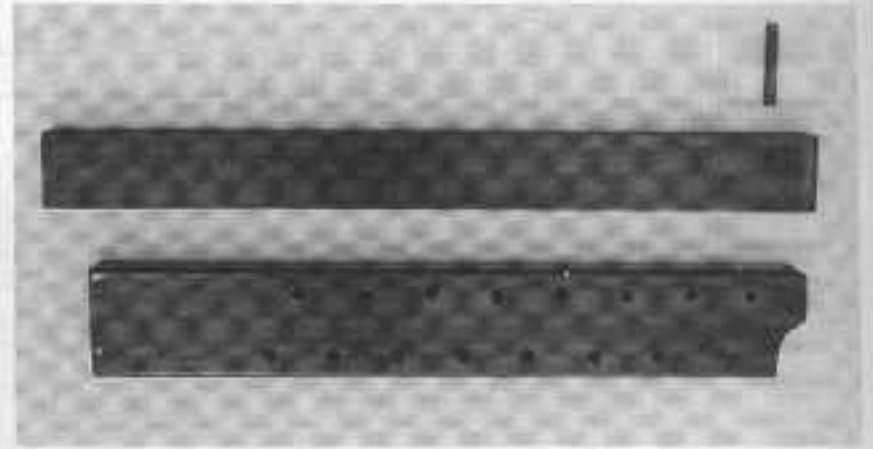

PHOTO 46: The magazine tube with all holes drilled, shown alongside the form block and spring pin.

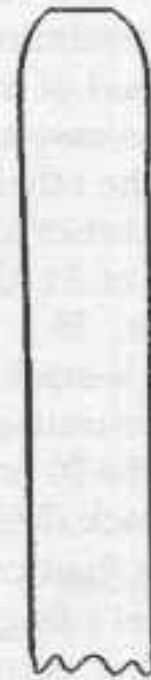

FIGURE BB  
END VIEW OF FORM BLOCK (END OF BLOCK MUST  
BE SHAPED AS CLOSELY AS POSSIBLE TO THE  
CONTOUR SHOWN HERE)

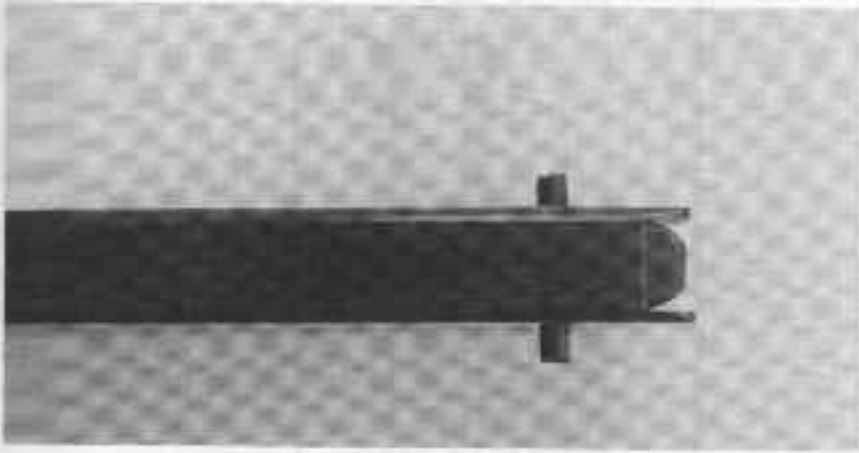

PHOTO 47: Rear view of magazine with block held in position with spring pin.

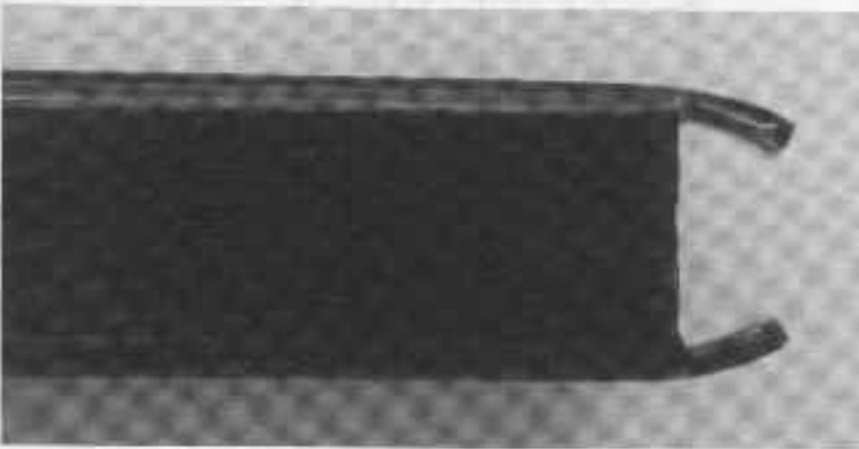

PHOTO 48: Magazine lips after forming.

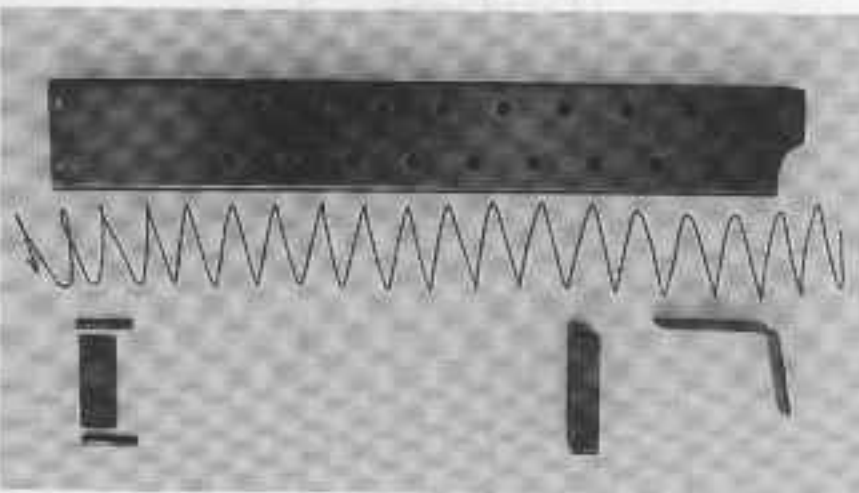

PHOTO 49: The magazine disassembled. The spring, follower, stop, base plate, and pins are shown in their respective positions.

a workbench and scrape the block across the file. This allows far more freedom of movement to file the curvature of the block than having it clamped stationary in a vise.

Once the block contour matches the drawing as closely as possible, the block is inserted inside the tube. It is positioned against the back wall of the tube with the formed end about 1 mm below the top of the

lips. The block is secured in this position by inserting a length of 7 mm-diameter bar into the gap between the block and the inside front of the tube. This should hold the block securely enough in position to allow a 5 mm-diameter hole to be drilled through the first viewing hole and all the way through the block. Now a 5 mm-diameter spring pin is tapped into the hole, and the round steel bar inserted earlier is removed. The spring pin is now holding the block securely inside the magazine tube (Photo 47), and we can proceed to the forming of the lips.

The assembly is clamped firmly in a vise so that only the top inch or so of the tube is visible above the vise jaws. A flat-ended punch, such as a short length of steel rod and a hammer, is required. The punch is placed against the lip along its top edge and tapped with the hammer while being moved back and forth along the length of the lip. After the lip is bent to the contour of the block, the same procedure can be carried out on the opposite lip. With the lips formed to shape (Photo 48), the spring pin and block are removed. If available, a micrometer is inserted into the top of the tube to measure the distance between the lips, which should be 9 mm across. If the gap is less than this, the block must be inserted back into the tube and its bottom end tapped with a hammer. This will drive the block upward and push the lips slowly apart, thus increasing the gap. The magazine tube is now finished, and the internal parts can be made and fitted.

There are three parts to make, all of which are quick and simple: the magazine spring, the follower, and the base plate. They will be constructed in the order in which they are inserted into the magazine (Photo 49).

The first part is the follower, so called because it sits over the magazine spring and follows the stack of cartridges. This is made by simply bending a 2 1/2" length of 1/2" x 16-gauge steel strip to the shape shown in Figure CC. A line is scored 1 1/2" in from one end of the steel strip. The 1 1/2" marked out section is placed in a vise so the vise jaws touch the score line. The 1" protruding section is tapped with a

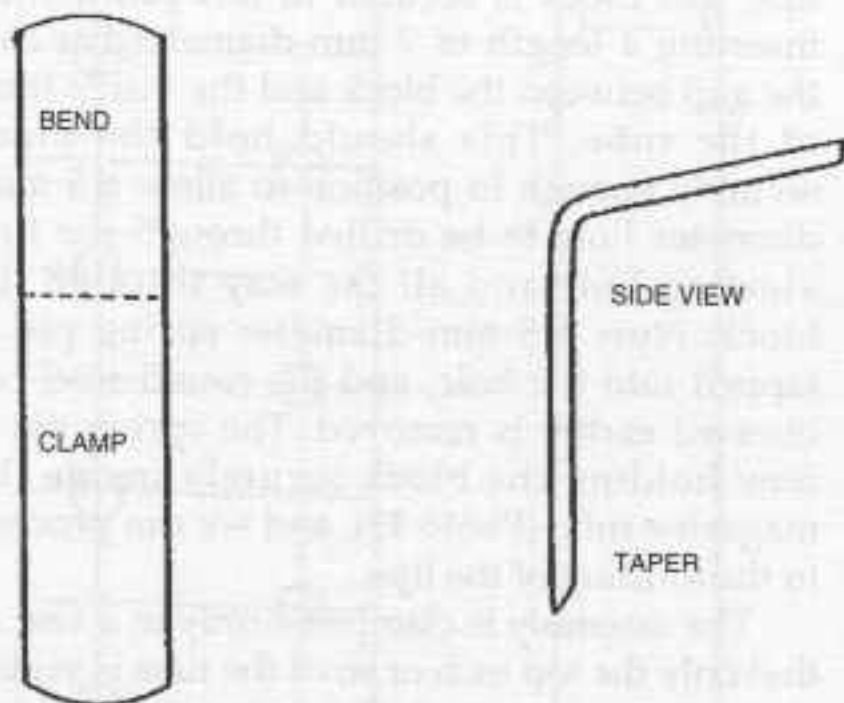

FIGURE CC  
FOLLOWER CONTOURS

hammer until the follower matches the drawing. The sides of the follower may need to be filed slightly to allow it to slide freely into the magazine.

The sharp corners are rounded off at both ends of the follower, and then a slight taper is filed onto the end of the follower's longer leg. The follower can now be inserted into the magazine; it can only fit one way—short leg first. The magazine spring can be made next, but first a simple mandrel must be assembled to wind the spring around (Figure DD). Three steel rods, 14" long and 8 mm in diameter, are required. The rods must be cleaned and then stacked horizontally, one on top of the other, in a vise. Several inches of the rods should protrude from each side of the jaws, and the ends of the three rods must be level with each other. One end of the rod assembly is heated with a gas torch for a length of about 1". The rods should be glowing bright red, and then a self-fluxing brazing rod is applied to the areas to be joined. These areas should be brazed for a length of an inch or so to ensure a strong joint. The opposite end of the rods can now be brazed together in exactly the same way. The mandrel is left in the vise until the rods have cooled completely. The brazed areas are cleaned up with a file if necessary to remove

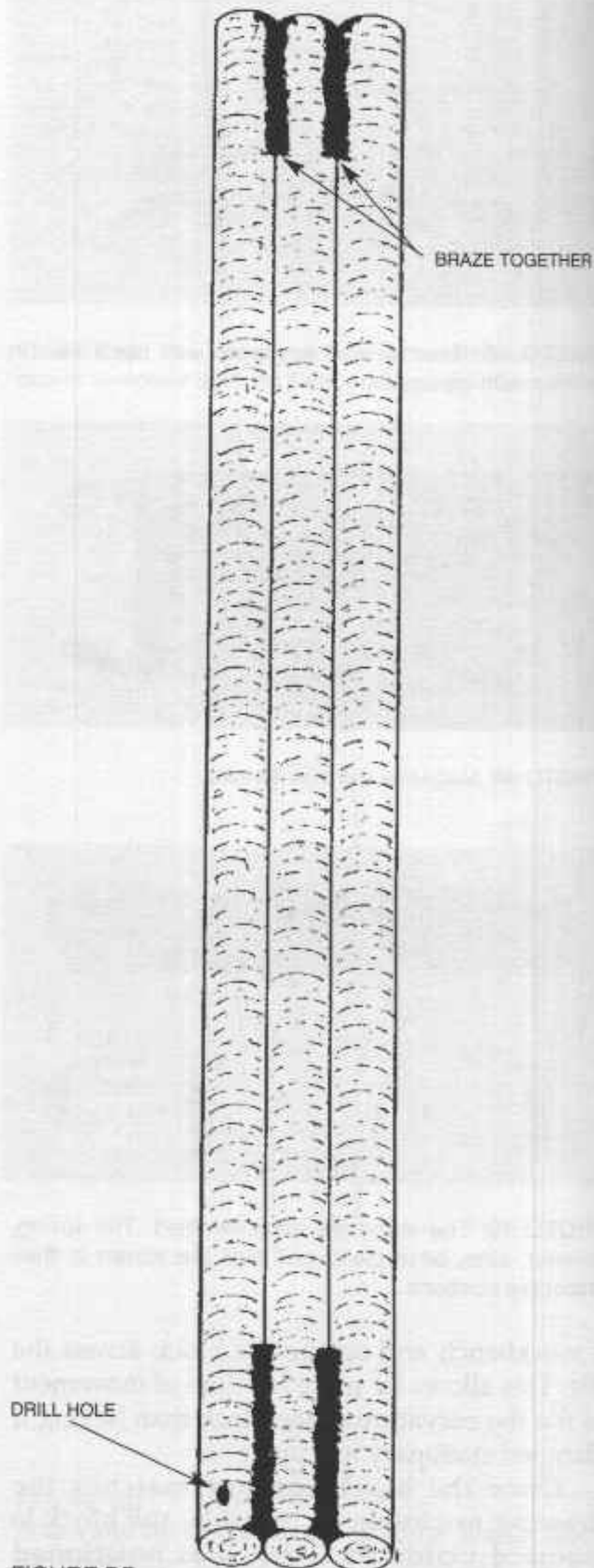

FIGURE DD  
MAGAZINE SPRING  
MANDREL



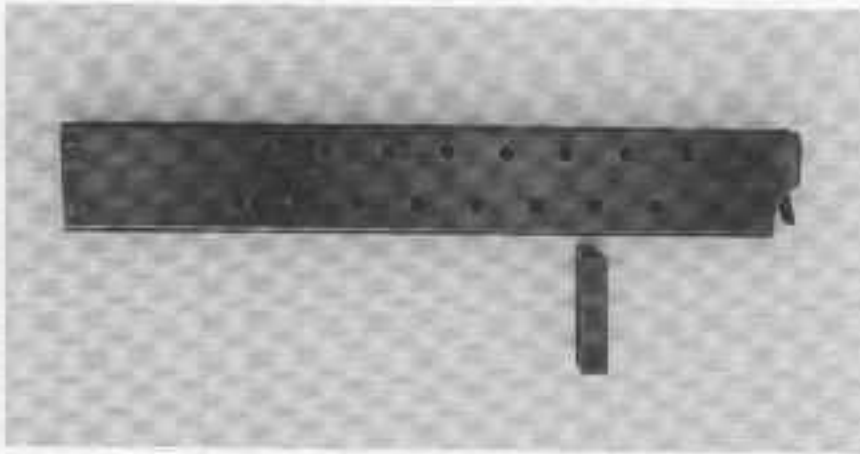

PHOTO 51: The magazine assembled and ready for the stop to be fitted.

each coil back into shape. Though difficult to explain in words, this is a straightforward procedure, and it will become self-explanatory when you see the spring. When a round spring such as the main spring is wound, it also unwinds but it still remains round, albeit a larger diameter. However, the rectangular spring does not remain rectangular when tension on the wire is released. Although this is an unavoidable nuisance, it is quickly rectified. After the coils are bent back into shape, the spring is slid back over the mandrel and fully compressed several times. As with the coil main spring, the magazine spring will shrink in length from 14" to approximately 11", though this is only a rough guide. As long as the spring is 1" to 2" longer than the magazine tube, it is the correct length. Now the spring is slid into the magazine behind the follower.

Next the base plate is made and held in position with two spring pins, 3 mm in diameter.

The plate is a 30 mm length of 1/2" x 16-gauge steel strip—the same material used for the follower. The steel strip is cut to length and held in position in the bottom of the magazine. The two spring pins are now inserted to hold the base plate in position. It is far easier to tap the pins just into one side of the magazine before inserting the base plate; this leaves both hands free—one to hold the plate in position and the other to hold the hammer.

The last part of the magazine to make is the stop. This has two purposes: it stops the magazine from being pushed too far into the



MAGAZINE STOP



SIDE VIEW  
END OF STOP FILED INTO A CURVE

FIGURE FF  
MAGAZINE STOP CONTOURS

gun, and it hooks onto the magazine catch to hold the magazine in position.

The stop is simply a 9 mm-thick slice of the same 40 x 20 mm tube as was used to make the grip and well. A set square is used to mark a straight line across the tubing to ensure both sides of the stop are square. After it's cut out, the stop is slid over a file to make sure both ends are perfectly flat and smooth. A curved taper is now filed onto one end of the stop to allow the catch to slide over it. The contour of the stop's taper is shown Figure FF. The stop should now be about 9 mm thick with a taper filed onto one end. The stop is slid over the top of the magazine with the tapered end positioned at the rear. The stop is positioned directly over the sixth viewing hole from the top of the magazine, and the magazine is inserted into the machine gun.

The release catch should slide over the tapered end of the stop and snap firmly into place, locking the magazine into position (Photo 52). The stop may need to be adjusted or filed slightly to reduce its thickness to allow the catch to fall into position. The stop will be silver-soldered in place eventually, but it must remain movable for now until after test-firing has been carried out, to allow for any adjustments.



## MAGAZINE CONSTRUCTION

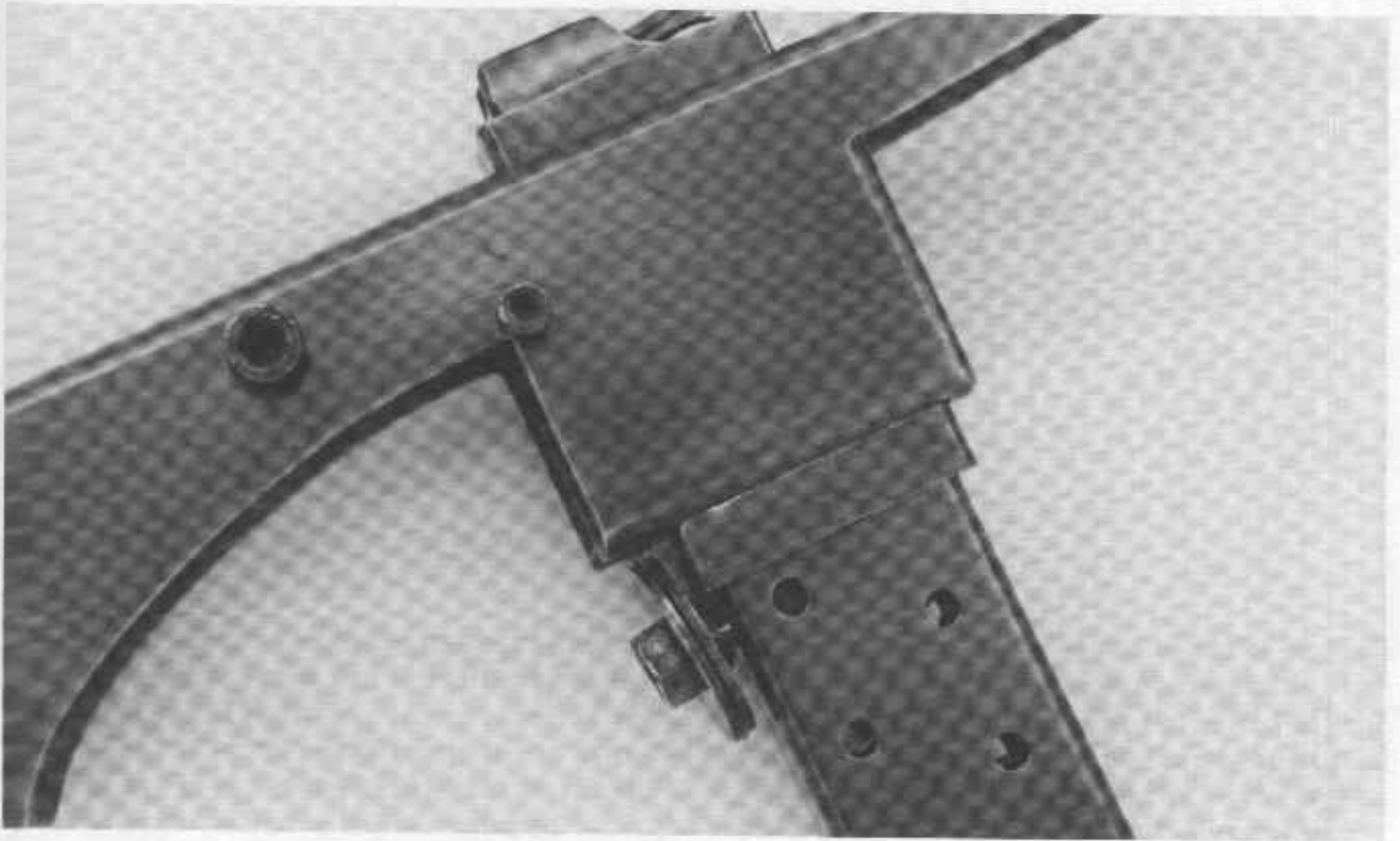

PHOTO 52: The magazine fitted. The magazine catch should hold the magazine firmly in position.

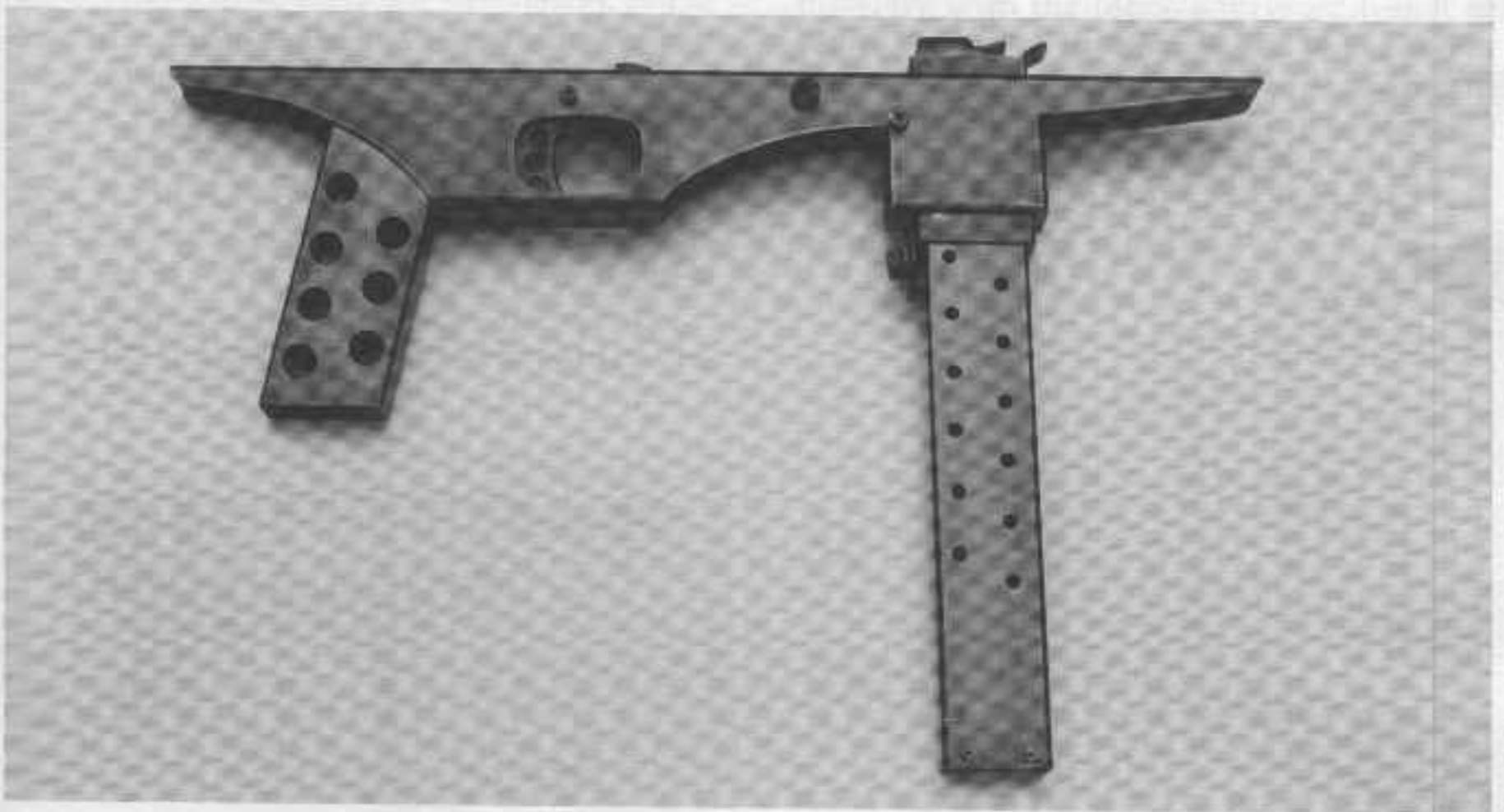

PHOTO 53: The fully assembled lower receiver with all internal parts fitted.

## ASSEMBLING THE MACHINE GUN

Both the upper and lower receivers are now complete and ready to be bolted together (Figure GG). The three socket screws are unscrewed from the underside of the upper receiver, but the screw removed from the middle collar is discarded, since it is not required.

Both receivers are positioned together (Photo 54), and then the remaining two screws are screwed in to hold the two halves of the machine gun together. A certain amount of hand fitting may be necessary before the two receivers will fit together. The front tip of the feed ramps may need to be filed back slightly so there is sufficient clearance between the front of the ramp and the breech face of the barrel. The contour of the ramp may also require adjustment to allow the block to slide over it.

With the receivers bolted together, the

weapon should be dry-fired to make sure all internal parts are functioning smoothly. The breech block (bolt) should be pulled all the way back to check that the sear snaps up to hold the block in the cocked position. When the trigger is pulled, the block should release cleanly and fly forward smoothly. The magazine lips and feed ramp must not interfere with the block's forward travel or slow it down in any way. The correct adjustment of the lips and feed ramp will ensure that this does not occur. Providing no further adjustments are required, we can get down to the fun stuff of test-firing the machine gun.



PHOTO 54: The two receivers ready to be bolted together.

FIGURE GG  
UPPER AND LOWER RECEIVERS FINISHED  
AND READY TO BOLT TOGETHER

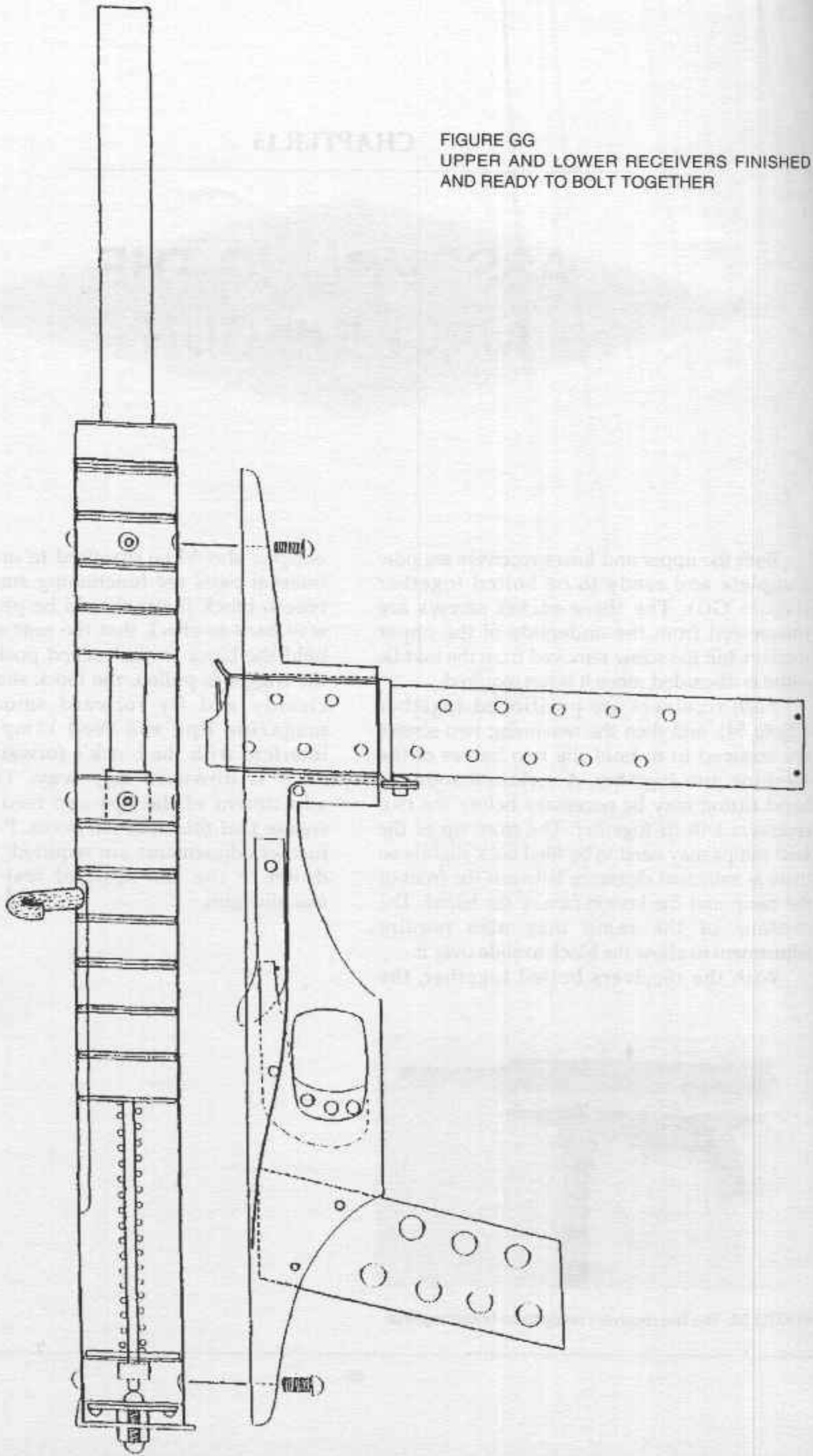

## CHAPTER 16

# TEST-FIRING

Having done extensive testing with various bullet weights, I would advise using 124-grain round-nose jacketed ammunition. This weight of bullet head creates sufficient pressure to reliably cycle the action. If the ammunition is going to be hand-loaded, I would suggest using a moderate load. While the machine gun shown throughout this book is just as strong and durable as many factory-made weapons, it is only a sensible precaution to first use a moderate loading.

Initially, a single round should be fired to ensure that a cartridge will chamber, fire, and eject correctly. One cartridge is loaded into the magazine, then the weapon is cocked. With the muzzle pointed in a safe direction, the trigger is pulled. The cartridge should fire, and the empty case should be ejected through the ejection port. Now five or six rounds are loaded and a short burst fired off by keeping the trigger under constant pressure until the weapon stops firing. Now the weapon should be checked to ensure that no parts have loosened up or been thrown out of their correct position. If all is well, the magazine can be loaded to its maximum 18-round capacity and the trigger pulled. Pressure on the trigger can be released two or three times during this prolonged burst of fire to ensure that the breech block will be held back in the cocked position by the sear when pressure on the trigger is removed. If any misfires or jams are experienced during the firing cycle, a small amount of polishing or adjustment of the feed

ramp or chamber mouth may be required. Any case ejection problems can usually be attributed to the ejector's being too short and incapable of positive contact with the fired case. It is also important to keep the chamber clean, since any build-up of powder residue can also cause extraction/ejection problems.

A wire barrel brush should be used to clean the chamber before shooting, especially if the firearm has been stored for a period of time. Examining fired cases will give a good indication of how well a particular firearm is functioning. The depth of the primer indentation, for example, will indicate whether the firing pin is the correct length or too short to detonate the cartridge reliably. A small nick mark on the base of the case may suggest the pin is too long and so snags on the base of the case as the cartridge slides upward from magazine to chamber. These are all possible problems that may arise, but any functioning problems can be solved by the process of elimination. Providing all measurements are followed, there is no reason why the expedient homemade machine gun will not work perfectly the first time. Once it is confirmed that the weapon is working smoothly, the magazine well and stop are fixed in place permanently. The receivers are separated and the well removed. A layer of bearing adhesive is applied to the well sides, and the well is inserted back into position. The adhesive is left to set for 5 to 10 minutes. Alternatively, the well can be secured with a small amount of

silver solder, but the first method is quicker. The magazine stop can now be silver-soldered to the magazine. The magazine is removed from the gun, but the position of the stop should not be disturbed. The magazine is

stripped of all internal parts and a small amount of solder is applied to the underside of the stop so the solder will not interfere with inserting the magazine.

Now the machine gun is reassembled.

# FITTING A SLING AND FINAL FINISHING

A sling is something of a necessity on any machine gun or rifle as an easy way of carrying the weapon. If a conventional rifle sling can be bought, this would be the obvious course of action. But, as with the weapon itself, we will assume this is not possible and an improvised sling must be used. A good source for sling material is the large cow and horse leads (reins) available from equestrian accessory shops. These are made from either canvas nylon or leather—exactly the same materials used for a machine gun or rifle sling. Usually these are about 1" wide, although a slightly smaller or larger width will suffice. A buckle must also be purchased so the length of the sling can be adjusted.

The lead is cut to a length of approximately 4', and an 8 mm hole is cut approximately 1" in through one end of the lead. The dome nut is unscrewed from the recoil shield and the end of the lead is pushed over the protruding screw. Now a 1" mudwing washer with an 8 mm hole is slid onto the screw behind the lead and then the dome nut is screwed on. One end of the lead is now fixed securely to the rear of the receiver. The buckle is slid onto the opposite end of the lead for a length of approximately 7", then the 7" section is fed back through the buckle to create a loop. The loop is slid over the end of the barrel and the buckle adjusted so the sling is the correct length to suit individual requirements.

The hot bluing techniques employed by the professional gunsmith to finish and protect the steel of a firearm requires the use of special

chemicals and equipment—not to mention the experience and time involved in carrying out this process effectively. Other books have covered this subject extensively, but the method is too complicated and time-consuming to be used on any firearm that can be called "expedient." Also, who would wish to spend days constructing hot bluing tanks and the heating apparatus required to heat the chemicals? The expedient machine gun is relatively quick to make once the necessary materials have been acquired. An equally quick method is required to enhance the appearance of the weapon and, more importantly, to protect the steel against the elements.

Cold gun blue is the obvious choice here. It is available from all gun shops and is sold in liquid and paste form, though I would recommend the liquid version, since it is far easier and less messy to apply. I would recommend purchasing a one-gallon can (although quite expensive), which will make bluing easier and give a much better finish. The liquid is poured into a plastic container, i.e., a plastic washing-up bowl. The container should be long enough to allow the longest parts (i.e., the receivers) to be submerged in the gun blue. The weapon is stripped down completely to its major component parts, and the magazine is stripped as well. All collars are removed from the breech block and barrel, as well as from the inside of the receiver. As during construction, all external surfaces should be polished smooth. This must be done

before the weapon is blued, since the liquid will not cover up any unsightly marks.

The better the gun's appearance beforehand, the better it will look after bluing. All parts must be degreased completely first, because any oils, including those present from simply handling the gun, can prevent the blue from penetrating the steel. All parts are washed in hot, soapy water (washing powder is ideal), then rinsed thoroughly in clean water and dried with a paper towel. Handling the parts directly after drying should be avoided. Also, note that hardware items (i.e., shaft lock collars) are often zinc plated, and since zinc will interfere with the bluing process, the zinc coating must be removed with a wash or quick soak in muriatic (hydrochloric) acid. (When it stops bubbling, all the zinc has been removed.) Then, to prevent rust, all the parts should be washed in a hot baking soda solution before the bluing process begins.

All the components are slowly immersed into the gun blue. The steel will turn black immediately, but the parts should remain submerged for about 15 minutes to ensure maximum penetration of the liquid. After the parts are removed, they are wrapped in paper towels to absorb the excess liquids, unwrapped, and left to dry out thoroughly for several hours at room temperature. Rubbing or polishing the parts at this point is not recommended, as this will jeopardize the final finish. According to the instructions supplied with the cold gun blue, parts should be rinsed in clean water, dried, and then polished with a soft cloth. However, after years of using gun blue on both conventional and homemade firearms, I can assure you that the methods I am describing here result in the best-looking and most durable finish possible. The "rub it on and polish" instructions supplied with the product are to be ignored.

When the parts are completely dry, they will display a thin film, brown in color, that looks like rust. Each part can now be polished using a fine or medium grade of steel wool. This should be done using very light pressure until the rust disappears and the blackened steel is visible underneath. Finally, each part is

polished with a soft cloth, and the resulting finish will be an attractive one. The insides of all the tubes, barrel, block, magazine, and receivers should be checked to be sure they are polished and free from any dried-on gun blue residue. For the barrel and block, a barrel cleaning brush can be used, and for the inside of the other sections an appropriately sized wad of steel wool, pushed back and fourth inside the tubes, works well.

A small amount of oil should now be applied to all internal sections of the weapon, with the exception of the barrel. Oil is also applied to the threads of the collars to ensure easy assembly/disassembly of the weapon. The machine is now finished and can be reassembled.

Cold gun blue can also be bought in small 3 fl. oz (90 ml) bottles at a fraction of the cost of a gallon can. Obviously, submerging the parts in liquid will give the most even finish, but if this amount cannot be obtained, one small bottle is enough to cover the whole weapon.

The component parts are prepared in exactly the same way as described earlier, then the liquid is applied with a cotton wool swab. The advantage of this method is that no internal sections of the weapon need polishing since blue is only applied to the external surfaces. Using a swab to apply the gun blue does not give such a good finish as the submerging method, but is still perfectly satisfactory for an expedient firearm.

As an alternative to bluing, the weapon can be finished to a case-hardened effect. This is my personal favorite, since it is truly expedient and only requires a gas torch and a small amount of oil. While this is not true case hardening, it is a similar good looking and durable finish. Just as with bluing, all visible external surfaces must be polished smooth, but degreasing sections of the weapon is unnecessary for the following process. First the gun is stripped, but only down to its major component parts. The magazine is disassembled, but the pistol grip is not removed. With all necessary parts removed, the receivers are bolted together and the recoil shield inserted back into position. A small amount of

light oil is smeared onto the external surfaces of the receiver assembly, but not too much; a few drops are perfectly adequate.

Starting at one end of the assembly, the flame of a gas torch is applied approximately 1" from the surface of the steel. The flame should not be moved around but held in the same position for approximately 20 to 30 seconds until heat rings appear, which indicate that the steel has changed color. This process is repeated at intervals of about 2" along the entire length of both receivers until all sides have been heated and all oil has evaporated. The magazine body is finished in exactly the same way, but all internal parts are removed first, since any significant heat applied to a spring will destroy it. The barrel must not be finished using this process unless the two barrel tubes were silver-soldered together, since any significant heat applied to bearing adhesive will melt it. Barrel tubes held together with adhesive must either be blued or left the natural steel color. The full case-hardening colors will not become apparent until the steel has cooled partially, at which point, with the steel still warm, a small amount of oil is applied to the receiver assembly and magazine. With a steel wool wad of fine or medium grade, each side of the receivers, grip, and magazine is very lightly polished. The oil will prevent the steel wool from scratching and bring out the full color

case-hardened effect. Finally, any surplus oil is wiped off with a clean cloth or paper towel and the weapon is reassembled.

The end result is an attractive, durable finish and, best of all, is almost foolproof to create because the gas torch and oil do all the work. Remember, these are expedient finishes and are not intended to compete with the sophisticated methods employed in arms factories or gunsmith shops. Providing the machine gun is not dragged along the ground behind a pick-up truck, the blued or heat-colored finishes described here are quick to apply, attractive, and durable.

Practicing with any homemade firearm is more important than with a factory-made counterpart, the latter weapon being made from high-quality materials on a production line, where each one made is identical to the last. Homemade firearms, on the other hand, will vary from weapon to weapon, depending on the person making them and the amount of time and care taken during manufacture. Getting to know one's own individual firearm—its reliability, firepower, eccentricities, and limitations—is of considerable importance, especially if a defense situation should arise. And, if the machine gun is used strictly for recreational purposes, no other firearm can come close to it for sheer shooting fun, at least not in my opinion!



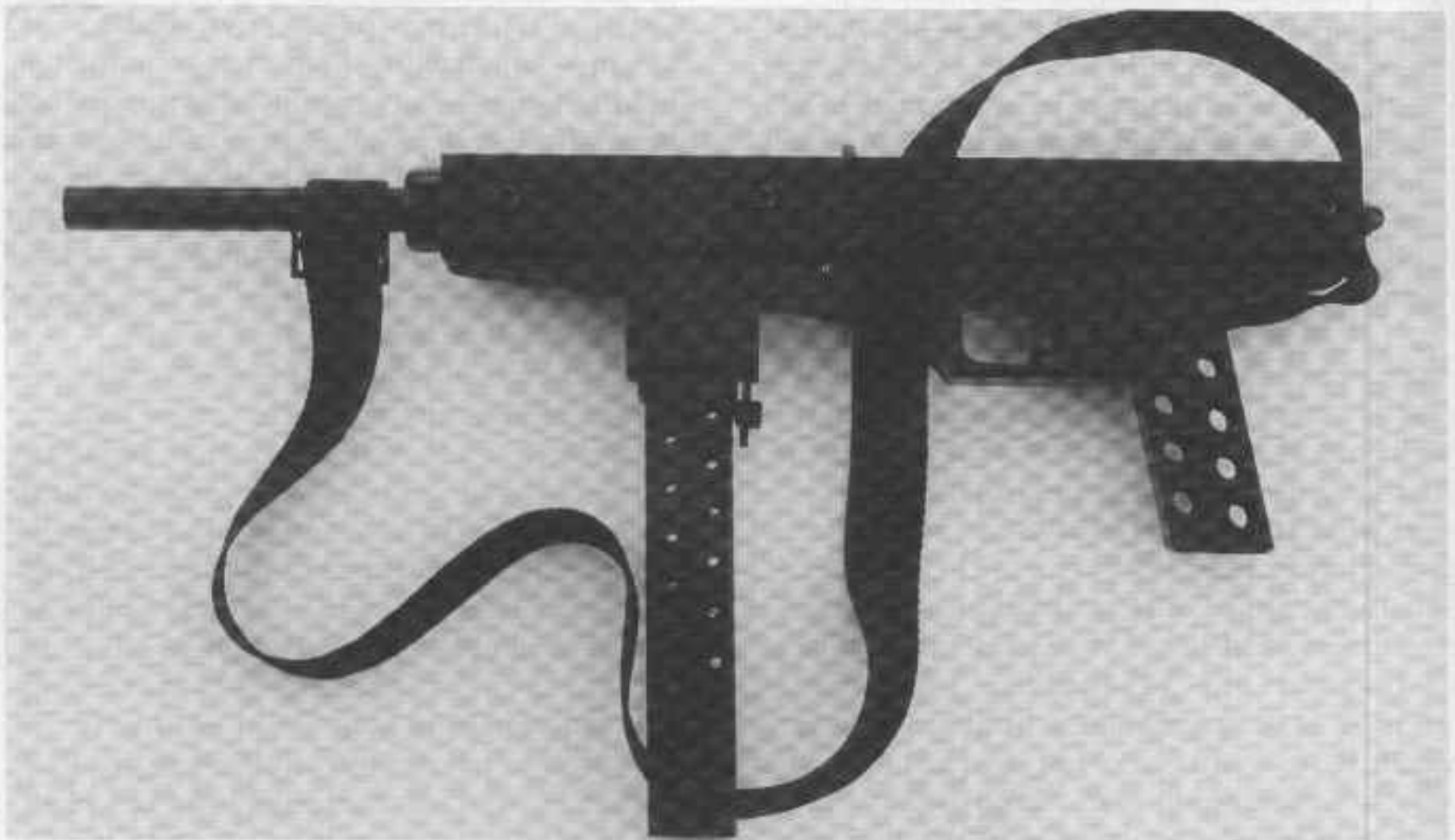
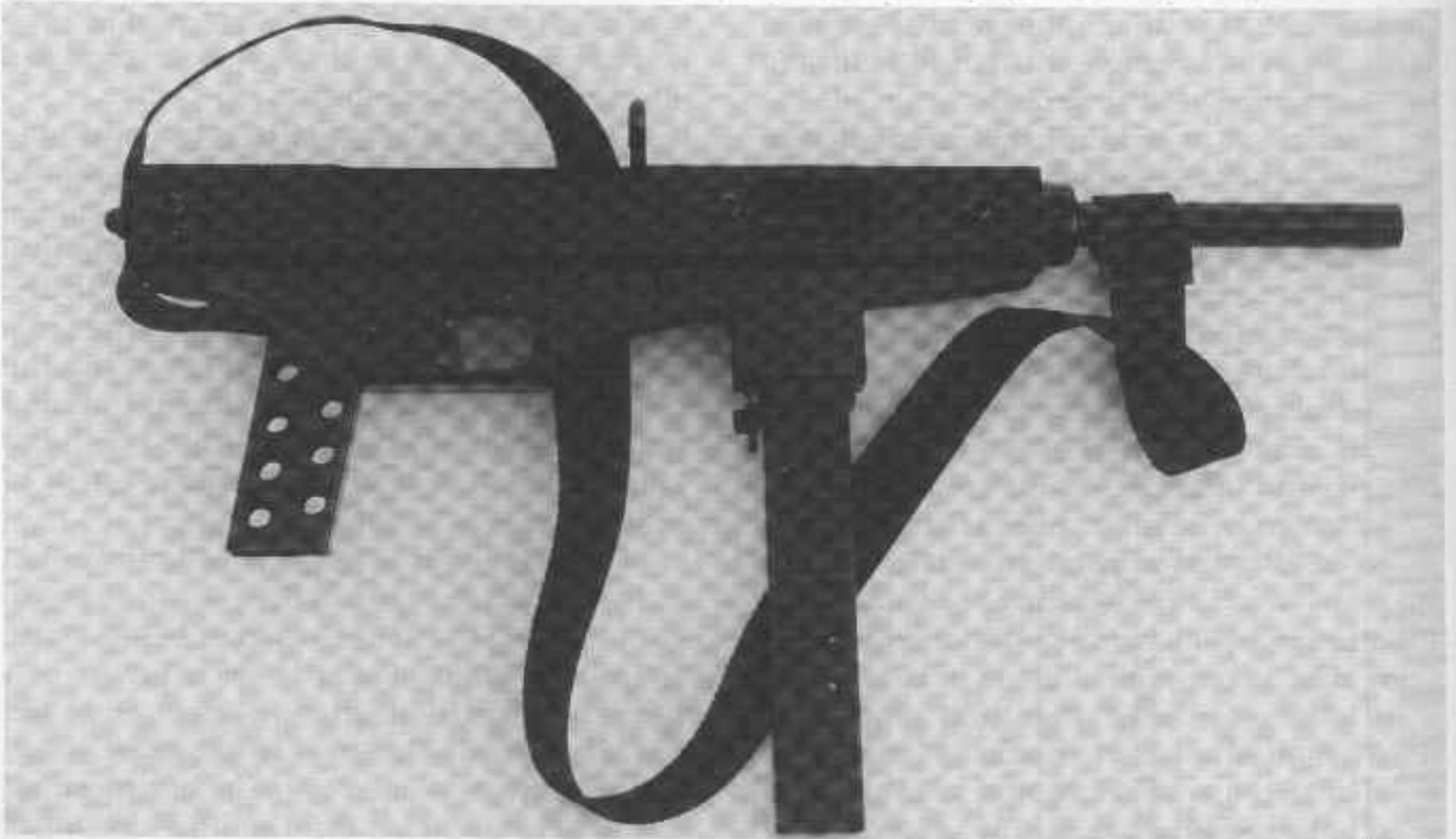

PHOTOS 55 AND 56: Right- and left-side view of the expedient machine gun, fully finished and sling fitted.

1. END CAP
2. GUIDE ROD RETAINING COLLAR
3. GUIDE ROD
4. MAINSPRING
5. BREECH BLOCK (BOLT)
6. COCKING HANDLE
7. EJECTOR
8. BARREL-RETAINING COLLAR
9. BARREL
10. MAGAZINE STOP
11. MAGAZINE
12. MAGAZINE RELEASE CATCH
13. LOWER RECEIVER MAINSPRING
14. SEAR
15. TRIGGER
16. GRIP
17. RECOIL SHIELD

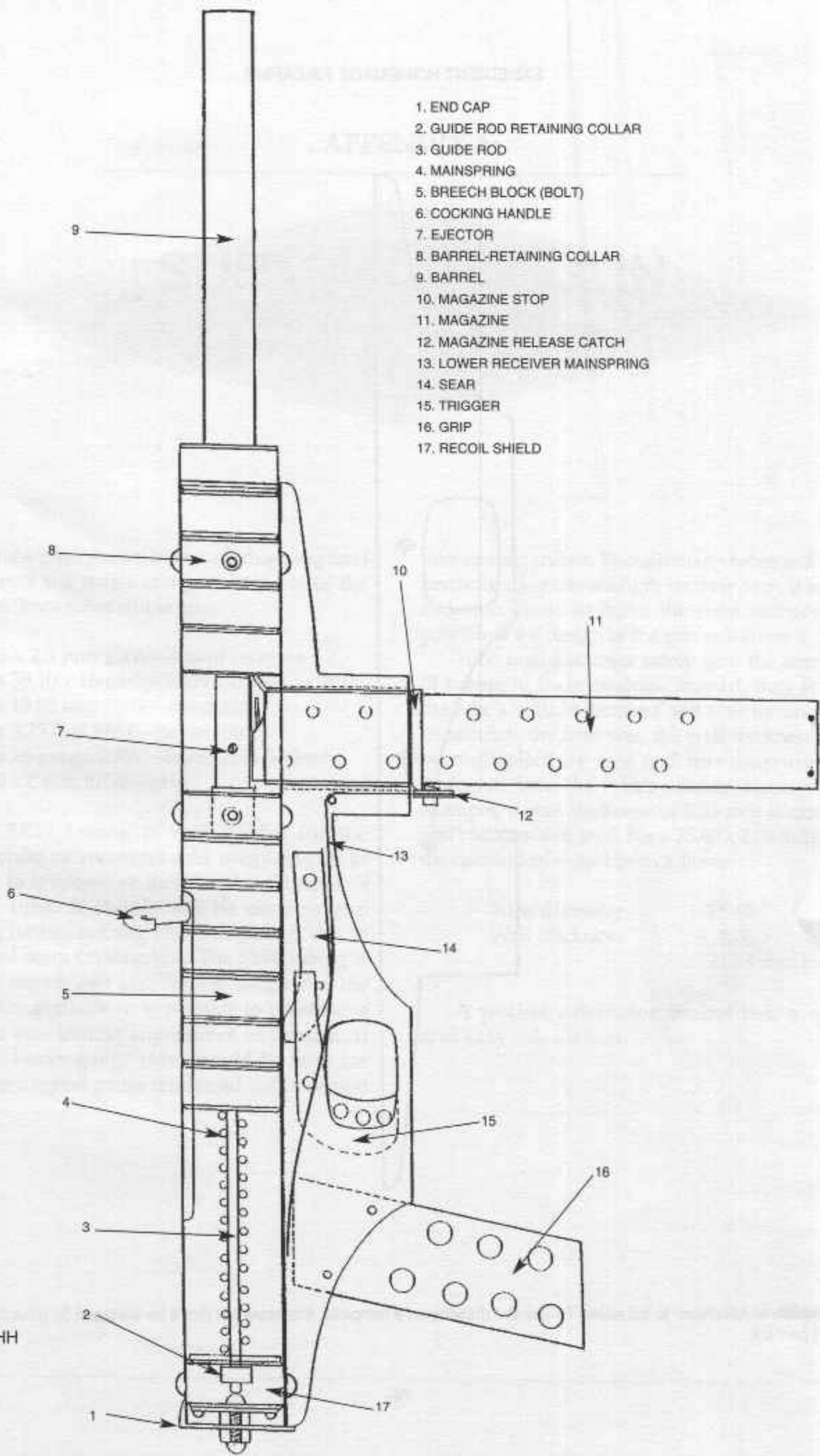
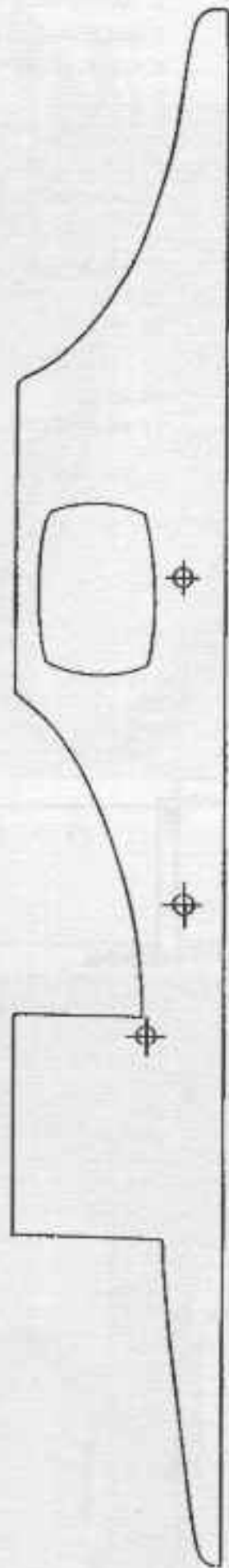

FIGURE HH

# EXPEDIENT HOMEMADE FIREARMS



This template is *not drawn to full scale*. To use the drawing as a template, it is essential that it be enlarged by photocopying it at 200 percent.

## APPENDIX A:

---

# SUBMACHINE GUN TUBING SIZES

The tube sizes shown below are those required to construct the major component parts of the expedient 9mm submachine gun:

1. 50 x 25 x 2.5 mm ERW—lower receiver
2. 38.10 x 38.10 x 16-gauge ERW—upper receiver
3. 34.93 x 15.88 mm ERW—magazine
4. 15.88 x 3.25 mm SMT—barrel/block
5. 19.05 x 16-gauge ERW—barrel/block sleeve
6. 40 x 20 x 2 mm ERW—grip

The ERW tubing is very useful for the construction of receivers and magazine or as sleeving to reinforce or increase the diameter of another tube. It should not be used as gun barreling (unless nothing else is available), due to its welded-seam construction. The SMT tubing is ideal for improvised gun barrels. Because of the many sizes available, it is possible to construct a barrel to suit almost any caliber of firearm. If possible, heavy-gauge tube should be used for barrels, or a lighter gauge reinforced with a second

tube or steel collars. Though many tubes will be of perfectly adequate strength on their own, it is only common sense to make the tube as strong as possible if the design of the gun will allow it.

Tube manufacturers rarely give the bore size of tubing in their catalogs. Instead, they supply the tube's outside diameter and wall thickness. So to calculate the bore size, the wall thickness must be multiplied by two and this measurement deducted from the tube's outside diameter. For example, a wall thickness of 2.03 mm is doubled and becomes 4.06 mm. For a 25.40 x 2.03 mm tube, the calculation would be as follows:

Tube diameter	25.40
Wall thickness	<u>- 4.06</u>
	21.34 mm bore

A pocket calculator makes this a quick and easy calculation.

## APPENDIX B:

---

# USEFUL SMT TUBE SIZES FOR IMPROVISED BARRELS

CALIBER	TUBE SIZE
.22 RF	9.53 x 2.03
.25 ACP	12.70 x 3.25
.32 ACP, S & W, etc.	14.29 x 3.25
.38, .357, 9 mm	(15.88 x 3.25) (19.05 x 4.88)
.44, .410	20.64 x 4.88
.45	17.46 x 2.95
12 gauge	(26.99 x 4.06) (28.58 x 4.06) (30.16 x 4.88)

---

Some of the tube sizes listed here will have a slightly oversized bore for the corresponding caliber, or, alternatively, the bullet may be a perfect fit in the bore. Whatever the caliber of gun, tubing that is as close as possible to the bullet's diameter must be used, and the ones listed here are good examples.

With any homemade firearm, it is strongly advisable to test-fire the weapon

remotely before shooting it by hand. By far the easiest way of doing this is to clamp the gun in a vise or other secure object and pull the trigger with a length of string. Standing several yards behind the gun while pulling the string will ensure that, in the unfortunate event that the tubing is of inadequate strength, the only damage will be to the gun rather than the shooter!

## APPENDIX C:

---

# TROUBLESHOOTING

The following troubleshooting chart lists the various problems that may be experienced and the most likely causes. Never jump to an instant conclusion if a firearm is functioning incorrectly. Instead, go through a careful

process of elimination to locate the precise cause of the problem. In this way, no unnecessary adjustments, which may make any problem worse, will be required

---

### SYMPTOMS

### POSSIBLE CAUSES AND REMEDIES

---

1. Cartridges will not feed smoothly from magazine to chamber.

Incorrect contour to feed ramp; adjust as necessary.

Insufficient bevel to chamber mouth; increase bevel as necessary using countersink, round grind stone, or felt polishing tip and electric drill.

Firing pin too long or too rough; carefully shorten or smooth as necessary.

2. Cartridge will not fully chamber.

Chamber cut to incorrect dimensions; check length and diameter of reamer.

Excess fouling in chamber; clean out with barrel brush.

3. Cartridges chamber but do not fire.

Firing pin too short; remove and replace with pin of correct length.

Chamber cut too long; replace barrel and carefully recut chamber.

---

- |   |  |
|---|--|
| 4. Cartridges fire but will not eject.                    | Ejector bolt too short; replace with ejector of correct length.<br><br>Load too weak; try heavier-powered ammo or ammo with heavier bullet weight.   |
| 5. Cartridges fire but will not extract.                  | Fouling in chamber; clean with barrel brush.   |
| 6. Weapon will not cock.                                  | Trigger and sear binding or sear binding on recess; file or polish to create sufficient free play.   |
| 7. Breech block jams during forward cycle.                | Block snagging on the magazine lips; increase distance between lips.   |
| 8. Breech block jams during rearward cycle                | Block binding on inside of receiver; smooth mating surfaces and ensure adequate lubrication.   |
| 9. Weapon fires single shot but will not repeat fire.     | Fouling in chamber; clean out with brush.<br><br>Loads too light; increase charge or bullet weight.<br><br>Ejector too short; replace with ejector of correct length.  |
| 10. Weapon will not stop firing when trigger is released. | Sear does not protrude sufficiently into upper receiver; adjust or replace as required.<br><br>Insufficient pressure applied to sear from spring. Check spring contour.<br><br>Loads too light; increase powder charge or bullet weight. |

**I**magine, if you will (and you need not have an overly active imagination), that you live under a regime that has banned most types of firearms—or controls them so tightly that they may as well be banned. In such a place, you, the gun enthusiast, might still be able to build your own improvised firearms—providing you have the necessary knowledge and facilities, including a fully equipped machine shop complete with a lathe and milling machine. Lacking these, however, you would likely find yourself frustrated by your creative efforts.

**A**uthor P.A. Luty lives in just such a place and understands the frustration of attempting to build homemade guns based on designs that are just too complicated or so crude as to be undesirable. Luty's idea of a homemade gun is one that can be built by just about anyone, even under adverse social conditions and regardless of available facilities: an *expedient* firearm. In this book he presents clear, step-by-step instructions for manufacturing such a firearm—one that is of simple design, easily constructed in about a week's time, and made of readily available materials, primarily steel tubing. The 9mm submachine gun described herein is of straight blowback design, fires from the open bolt, and holds 18 rounds. It is not pretty; its main priorities are reliability and simple functionality.

**E***xpedient Homemade Firearms* was written to illustrate that no amount of restrictions can prevent those wanting firearms from having them, and it is an invaluable resource for all those who refuse to be helpless subjects of the state. *For academic study only.*

Visit our Web site: [www.paladin-press.com](http://www.paladin-press.com)

A PALADIN PRESS BOOK • ISBN 0-87364-983-4

ISBN 0-87364-983-4



9 780873 649834

