

# THE MACHINE GUN

History, Evolution, and Development  
of Manual, Automatic, and Airborne  
Repeating Weapons

by

George M. Chinn  
Lieutenant Colonel, USMC

VOLUME I OF THREE VOLUMES

Prepared for the Bureau of Ordnance  
Department of the Navy

1951

# PREFACE

With the belief that the next best thing to actual knowledge is knowing where to find it, this research has been compiled by the Bureau of Ordnance, Department of the Navy, in order to place in the hands of those rightfully interested in the art of automatic weapon design, the world's recorded progress in this field of endeavor.

So great a period has been covered on a vast and controversial subject, with practically no precedent to use as a guide, that the sum total of this effort must be regarded somewhat in the nature of an experiment.

While nothing is claimed for this volume except that it is the result of tedious and laborious research, it is believed that in some manner it will help point the way to a better understanding of past development. In so doing, it should help to reduce pitfalls that beset the designer traveling an otherwise dimly lighted path.

A biography is included for each of the great masters of gun design, upon whose countless experiments and basic ideas the automatic armament of the world has been created; thus the reader may better determine the magnitude of their genius and its meaning to history past and future.

Excerpts from actual writings of the inventors, manufacturers and professional critics are given wherever possible. These statements, together with other authoritative matter, are assembled for the most part according to historical sequence.

It is not to be construed that this book is infallible, as it has the inevitable errors of all first editions. Sometimes an apparent digression was thought necessary to help clarify succeeding events, such as gunpowder experiments, ignition improvements, metallurgy formulas and even aviation progress. Without these kindred subjects, present-day ordnance design would not exist.

Great stress has been laid upon the inclusion of actual photographs of early inventors firing their prototype machine guns, to present pictorial proof that the automatic weapons we know today were of as humble origin as the mechanics who created them.

The unholy desire throughout the centuries for man to implement his belligerent impulses with superior tools for conflict, has provided the anvil upon which he has patiently forged the most lethal scourge of the modern world—the Machine Gun.

# ACKNOWLEDGMENTS

The help and encouragement received from many sources in the preparation of this work can never be fully acknowledged. The following individuals are listed in at least partial recognition of such contributions.

Captain Eugene Tatom, USN, formerly Chief, Re8, and Mr. James R. Norton, Head Engineer, Re8, Aviation Ordnance, Bureau of Ordnance.

Mr. M. Bigelow Browning, Vice President, Browning Arms Company; Colonel Leo A. Codd, Executive Vice President, American Ordnance Association; Dr. S. G. Green, Chief, Engineering Section, Small Arms Branch, Industrial Division, Ordnance Corps, Department of the Army; Major General Julian S. Hatcher, National Rifle Association; Colonel Allen L. Keyes, USA, Director, and Mr. Gerald C. Stowe, Curator, West Point Museum; Colonel G. B. Jarrett, Chief, Library and Museum Branch, Aberdeen Proving Ground; Colonel Willard Webb, Chief, Stack and Reader Division, Library of Congress.

Mr. John Casey, General Manager, North American Aviation Corporation; Mr. Louis Ehrman, Pocomoke, Maryland; Mr. Herman P. Dean, President, Standard Printing and Publishing Company, Huntington, West Virginia; Colonel George W. Hicks, Circulation Manager, Columbus (Ohio) Citizen; Colonel Melvin M. Johnson, Jr., Technical Director, Arms Department, Research and Development Division, Mr. Edwin Pugsley, former Vice President in Charge of Research, Mr. James C. Hartley, Director of Research, and Mr. Thomas Hall, Gun Museum Curator, all of Winchester Repeating Arms Company, Division of Olin Industries, Inc.; Mrs. Ruth H. Stoeger, Librarian, Stoeger Arms Co.; Mr. H. P. White, Chief Engineer, and Mr. Burt D. Munhall, Manager, H. P. White Ordnance Co.

Lieutenant Colonel Franklin S. Allen, Jr., Chief, Tactical Combat Branch, USAF; Lieutenant Colonel John J. Driscoll, Chief, Bomber Defense Branch, USAF.

Lieutenant Colonel Andrew W. Hamilton, Chief, Technical Intelligence, Ordnance Research and Development Division, Department of the Army; Lieutenant Colonel Frank J. McMorrow, Officer in Charge of Museum, Springfield Armory; Mr. Joseph H. Church, Chief, Patent Section, Ordnance Corps, Department of the Army; Mr. H. G. Solberg, Technical Intelligence Branch, Ordnance Corps, Department of the Army; Mrs. Rosemary Darsa, Photo Branch, Army Intelligence.

Rear Admiral Malcolm F. Schoffel, USN; Captain T. H. Ahroon, USN; Captain Devere L. Day, USN, Chief, Air Section, Intelligence Branch, ONI; Captain F. B. Miller, USN; Captain R. N. Sharp, USN; Commander William J. Lederer, USN; Commander Richard Matter, USN; Commander Dan W. Snively, USN; Lieutenant Commander Marvin Franger, USN; Lieutenant Commander Paul Pugh, USN; Aviation Ordnance Chief J. W. Cospers, USN.

Brigadier General Vernon E. Megee, USMC; Lieutenant Colonel Francis Kiernan, USMC; Major Ross Jordan, USMC; Captain Don Fenton, USMC; Chief Warrant Officer John Scarborough, USMC.

## ACKNOWLEDGMENTS

vii

Dr. Remington Kellogg, Director, U. S. National Museum; Mr. M. L. Peterson, Acting Curator, Division of Military and Naval History, Smithsonian Institution; Mr. C. E. Haglund, Executive Officer, U. S. Patent Office; Mr. J. F. Nugent, Federal Bureau of Investigation; Mr. Harold L. Peterson, Historian, National Park Service.

Mr. Harry J. Baudu, Miss Josephine Cobb, Miss Elizabeth B. Drewry, Mr. Howard T. Gardner, Mr. Richard G. Giroux, Mrs. Emma B. Haas, Mr. John P. O'Brien, Mr. William F. Shonkwiler, Mr. Charles E. Wiseman and Mr. Richard G. Wood, of the National Archives.

Mr. Henry E. Marschalk, Miss Adele Miller and Mr. C. H. Grover, Publications Branch; Mr. Gerald D. O'Brien, Patent Counsel; Mr. William F. O'Keefe and Miss Lillian Martin, Administrative Division, of the Bureau of Ordnance.

Special thanks must be given for the excellent cooperation and service given by personnel of the U. S. Naval Photographic Center, Still Picture Library. The staffs of all libraries and museums visited were most helpful and accommodating. These institutions include the Library of Congress, Army Library, Army War College Library, Signal Corps Photographic Library, Main Navy Library, Bureau of Aeronautics Library, Bureau of Ordnance Technical Library, Bureau of Ships Library, U. S. National Museum, Aberdeen Proving Ground Library and Museum, Naval Ordnance Laboratory Ordnance Technical Museum, Naval Gun Factory Museum, and Bureau of Ordnance Museum.

Mrs. Jane Virginia Philbrick, Washington, D. C., aided greatly in the tedious research and editorial work involved in the early preparation of this volume.

Mr. Daniel D. Musgrave, Washington, D. C., deserves special thanks for many invaluable contributions based on his encyclopedic knowledge of the subject.

Three people were assigned directly to assist the author. Mr. Leo X. Abernethy, a young man well recognized for his designing skill on automatic firing mechanisms, was lent to the project by the Naval Gun Factory, Washington, D. C. His display of talent in classifying basic principles and interpreting patent drawings of all nations, coupled with his ability to evaluate accurately research material of each era, warrants a commendation of the highest order. Too much credit cannot be given to him for whatever measure of success the finished product may enjoy.

The second member was Master Sergeant John H. Moore, USMC, former instructor at the Marine Corps Aviation Ordnance School, Quantico, Virginia. His meticulous care in collecting historical and pictorial research will be gratefully recognized by students of automatic weapons for years to come. His thorough working knowledge of the intricate mechanics of foreign automatic weapons is outstanding and proved of inestimable value in hastening the conclusion of the project.

The Naval Ordnance Laboratory, White Oak, Maryland, made the last, but by no means the least, contribution in providing the editorial services of Mr. Franklin W. Clark. The others on the project felt his duties were the most difficult of all and agreed that the handling of his part of the work was responsible for the project being completed with speed and accuracy. His capability left them with not only admiration but envy.

*George M. Chinn*

*Lieutenant Colonel, USMC.*

# CONTENTS

## PART I—FORERUNNERS OF THE MACHINE GUN

Chapter	Page
1. Weapon History Prior to Gunpowder .....	3
Primitive Beginnings .....	3
The First Projectile Throwers .....	4
Medieval Instruments of War .....	6
2. Firearm Development to Percussion Ignition .....	11
Origins of Gunpowder .....	11
Early Multibarrel Firearms .....	12
Improvements in Ignition .....	15
Beginnings of Revolving and Volley-Fire Guns .....	16
Application of the Detonating Principle to Firing .....	20
Pioneer American Gunsmiths .....	21
3. Background of Machine Gun Development .....	24
First Models of Percussion Multifiring Weapons .....	24
Development of Cartridges .....	25
Ripley Gun .....	26
Refinements in American Gunsmithing .....	28
Industrial By-Products of the Gun Trade .....	29
Colt Revolving Rifle, Model 1855 .....	30

## PART II—MANUALLY OPERATED MACHINE GUNS

1. Billinghamst Requa Battery .....	35
2. Ager "Coffee Mill" Gun .....	37
3. Claxton Firing Mechanism .....	41
4. Machine Guns Used by the Confederacy .....	42
Williams Machine Gun .....	42
Vandenberg Volley Gun .....	43
Confederate Cannon .....	46
Gorgas Machine Gun .....	46
5. Gatling Machine Gun .....	48
The Model 1862 Gun .....	48
Tests and Demonstrations .....	50
The Model 1865 Gatling .....	51
Adoption by the United States .....	54
International Acceptance of the Weapon .....	55
Performance and Improvement during the Nineteenth Century .....	57
6. Mitrailleuse Type Weapons .....	64
7. Farwell Machine Gun .....	69
8. Hotchkiss Machine Gun .....	71

Chapter	Page
9. Gardner Machine Gun .....	79
10. Lowell Machine Gun .....	89
11. Wilder Machine Gun .....	100
12. J. H. McLean's "Peace Makers" .....	104
13. Bailey Machine Gun .....	107
14. Nordenfelt Machine Gun .....	110
15. Taylor Machine Gun .....	117
16. End of the Manually Operated Period .....	119

### PART III—FULL AUTOMATIC MACHINE GUN DEVELOPMENT

1. Maxim Machine Guns .....	123
Maxim's Early Years .....	123
The First Automatic Machine Gun .....	128
First Trials of the Maxim Gun .....	136
Other Maxim Weapons .....	143
Vickers-Maxim Machine Gun .....	144
2. Skoda Machine Gun .....	150
3. Browning Automatic Machine Guns .....	156
John M. Browning's Early Years .....	156
The Colt Model '95 Machine Gun .....	160
The Browning Model 1901 Machine Gun .....	169
Browning Guns in World War I: B.A.R. and Browning Machine Gun Model 1917 .....	173
Browning Caliber .50 Machine Gun .....	181
4. Hotchkiss Automatic Machine Guns .....	187
Background .....	187
Hotchkiss Machine Gun .....	188
Puteaux and St. Etienne Machine Guns .....	194
Benét-Mercié Machine Rifle .....	195
Hotchkiss Machine Gun Model 1914 .....	200
Hotchkiss 12-mm Machine Gun .....	202
5. Nordenfelt Automatic Machine Gun .....	204
6. De Knight Water-Cooled Machine Gun .....	207
7. Madsen Automatic Machine Gun .....	209
8. Bergmann and Dreyse Machine Guns .....	214
Bergmann Machine Gun .....	214
Dreyse Machine Gun .....	216
9. Perino Machine Gun .....	220
10. Carr Machine Gun .....	224
11. Schwarzlose Machine Gun .....	228
12. McClean Machine Gun .....	232
13. Chauchat Machine Gun .....	238
14. Berthier Machine Gun .....	243
15. Kjellman Machine Gun .....	248
16. Revelli Machine Gun .....	251
17. Laird-Menteyne Machine Gun .....	256

## PART IV—AIRCRAFT AND AIRBORNE WEAPONS

Chapter	Page
1. Early Aircraft Developments .....	259
Aerial History before Kitty Hawk .....	259
The Wright Brothers and other Early Pilots .....	262
Beginnings of Military Aviation .....	265
Pioneer Attempts at Aerial Armament .....	268
2. Lewis Aircraft Machine Gun .....	275
The First Aerial Machine Gun .....	275
Early Development of the Lewis Gun .....	278
The Lewis Gun in World War I .....	279
The Controversy over the Lewis Gun in America .....	285
Later Development and Production of the Lewis Gun .....	291
Use of the Lewis Gun by the Navy .....	293
The Routing of the Zeppelin Menace .....	295
Conclusion .....	297
Models of the Lewis Gun .....	299
3. Vickers Aircraft Machine Gun .....	301
4. German Maxim-Type Aircraft Weapons .....	309
Early Adaptations .....	309
Parabellum Machine Gun .....	310
The Fokker Synchronizer .....	312
Introduction of Armored Planes .....	314
T. u. F. Machine Gun .....	315
Models of Maxim Guns .....	317
5. Marlin Aircraft Machine Gun .....	320
6. Browning Aircraft Machine Guns .....	327
First Attempts at Air Firing .....	327
The Aircraft Armament Board Report .....	328
Browning Aircraft Machine Gun, Cal. .30 .....	332
Browning Cal. .50 Aircraft Machine Gun .....	333
Cycle of Operation .....	339
The B. A. R. Since World War I .....	342
Models of Browning Recoil-Operated Machine Guns .....	343
7. Hotchkiss Aircraft Machine Gun .....	345
Aerial Uses of the Hotchkiss .....	345
Tabulation of Hotchkiss Machine Guns .....	351
8. Nambu Automatic Weapons .....	353
9. Revelli Aircraft Machine Gun .....	356
10. Bergmann, Dreyse, and MG-13 Machine Guns .....	364
German Light Machine Gun Models in World War I .....	364
Bergmann Model 1915, N. A., Machine Gun .....	365
MG-13 .....	367
11. Villar-Perosa Aircraft Machine Gun .....	371
12. S. I. A. Aircraft Machine Gun .....	374
13. Gast Aircraft Machine Gun .....	379
14. Darne Aircraft Machine Gun .....	384
15. Beardmore-Farquhar Aircraft Machine Gun .....	389
16. Brixia Machine Gun .....	393
17. Mendoza Light Machine Gun .....	397

Chapter	Page
18. Chatellerault Machine Gun .....	401
19. Madsen Aircraft Machine Gun .....	407
The Aircraft Version of the Madsen .....	407
Models and Users of the Madsen .....	410
20. B. S. A. Aircraft Machine Gun .....	412
21. Breda Machine Gun .....	416
22. Furrer Machine Gun .....	425
23. ZB Machine Guns .....	429
ZB Model 1926 .....	429
The Bren Gun .....	432
Japanese Models of the ZB .....	433
ZB-50 Machine Gun .....	434
Besa—ZB-53 Machine Guns .....	436
24. Vickers-Berthier Machine Gun .....	441
25. Lahti (Suomi) (L/S) Machine Gun .....	446
26. Rheinmetall-Borsig Machine Guns .....	450
Introduction .....	450
Solothurn Model 29 .....	451
MG-30 .....	453
MG-15 .....	454
MG-17 .....	455
MG-131 .....	457
27. Scotti Machine Gun .....	461
28. Bang Aircraft Machine Gun .....	464
29. Sistar Machine Gun .....	465
30. Knorr-Bremse Machine Gun .....	469
31. Mauser Machine Guns .....	472
Background .....	472
MG-34 .....	473
MG-81 .....	478
32. Johnson Light Machine Gun .....	480
33. MG-42 Machine Gun .....	484
34. FG-42 Machine Gun .....	489

#### PART V—AUTOMATIC AIRCRAFT CANNON

1. Davis Nonrecoiling Gun .....	495
2. Vickers Aircraft Cannon (C.O.W. Aircraft Cannon) .....	500
3. Revelli Aircraft Cannon .....	505
4. Puteaux 37-mm Aircraft Cannon .....	507
5. Becker—Semag—Oerlikon Automatic Aircraft Cannons .....	512
Becker Cannon .....	512
Semag Aircraft Cannon .....	514
Oerlikon Aircraft Cannon .....	515
Gazda Aircraft Cannon .....	519
Polsten Cannon .....	520
Cycle of Operation .....	522
Conclusion .....	522
6. Szakats 20-mm Aircraft Cannon .....	523
7. Baldwin Aircraft Cannon (37-mm) .....	526



Chapter	Page
8. Browning Aircraft Cannon .....	531
9. Madsen Aircraft Cannon .....	537
10. Hotchkiss 25-mm Aircraft Cannon .....	542
11. Scotti Aircraft 20-mm Cannon .....	545
12. Lübbe 20-mm Aircraft Cannon .....	548
13. Rheinmetall-Borsig Automatic Aircraft Cannon .....	550
Ehrhardt, Solothurn & Flak 30 Cannon .....	550
Flak 18 Cannon .....	554
MK-101 Cannon .....	555
MK-103 Cannon .....	557
MK-108 Cannon .....	558
14. Birkigt Type 404 20-mm (Hispano-Suiza) Cannon .....	562
Early History of Hispano-Suiza Company .....	562
Earliest Birkigt Type 404 Cannon .....	563
Cycle of Operation .....	566
British Adoption of the Gun .....	566
American Negotiations for the Cannon .....	570
Production of Hispano-Suiza Cannon by the United States .....	574
Modifications and Attempts at Standardization .....	577
Mount, Feed, and Other Modifications .....	579
Types of Hispano-Suiza Cannon .....	582
T-26 and Other Modified Hispano-Suiza Cannon .....	583
Performance of Hispano-Suiza Cannon During World War II .....	588
15. Furrer Automatic Aircraft Cannon .....	591
16. American Armament Automatic Aircraft Cannon .....	593
17. Lahti Aircraft Cannon .....	596
18. Breda 20-mm Automatic Cannon .....	598
19. Mauser Automatic Cannon .....	602
MG-151 .....	602
Flak 38 .....	604
20. Automatic Aircraft Cannon, Caliber .90 Series .....	607
21. Bofors Automatic Aircraft Cannon .....	610
22. Japanese Automatic Aircraft Cannon .....	614
 CONCLUSION .....	 619
 APPENDICES	
A. Patents on Machine Guns and Relating Mechanisms upon which the World's Automatic Weapons Have Been Based .....	 621
B. Tabulated Characteristics of Machine Guns and Aircraft Cannon .....	657
 BIBLIOGRAPHY .....	 671
 INDEX .....	 675

# ILLUSTRATIONS

	Page
Statue at Entrance to National Archives Building, Washington, D. C. ....	xxiv
A Spring Engine .....	6
A Catapult for Slinging Stones .....	7
The Trebuchet .....	7
The Ballista .....	8
A Heavy German Crossbow and a Cranequin for Cocking .....	9
A Crossbow with Magazine Feed .....	9
An Early Chinese Organ Gun .....	13
Volley Firing Guns Designed by Leonardo da Vinci .....	14
Three-Barrel Match Lock. Barrels are Revolved by Hand .....	15
James Puckle's Revolving Gun .....	18
Seven-Barrel Revolving Flintlock Rifle .....	19
Barnes Machine Gun. Patented 1856 .....	25
Ripley Machine Gun. Patented 1861 .....	27
The Colt Revolving Rifle .....	31
Billinghurst Requa Battery Gun, Cal. .50, Model 1862 .....	35
Ager Machine Gun, Serial No. 2 .....	37
Ager Machine Gun, Cal. .58, without Carriage .....	38
Claxton Machine Gun, Cal. .69 .....	41
Williams Smooth Bore Machine Gun, Cal. 1.56 .....	42
Vandenberg Volley Gun, Cal. .50. 85-Barrel Model used by the Confederates...	43
Vandenberg Volley Gun. A Loading Tool Was Supplied with the Weapon that Loaded All Chambers Simultaneously .....	44
Confederate Revolving Cannon .....	45
Gorgas Machine Gun, Cal. 1.25 .....	46
A Section View Showing the Action of Gatling's First Model Gun .....	49
A Letter from Richard Gatling to President Lincoln .....	52
Gatling Gun Aboard the USS Alliance .....	55
Gatling Gun, Model 1883, Ten-Barrel, Cal. .45, with Accles Feed Drum .....	56
General Custer, Who Left his Gatlings Behind When He Met Sitting Bull at Little Big Horn .....	58
Gatlings at Baiquiri Just Before Starting for the Front in the Spanish-American War .....	59
Dr. Richard Jordan Gatling With His Weapon .....	61
War Department Letter Attesting Capabilities of Gatling Mechanism .....	62
Montigny Mitrailleuse, a Belgian-Designed Volley Firing Gun .....	65
De Reffye Mitrailleuse, a 25-Barreled Version as Modified by the French Ord- nance Officer .....	66
The Chassepot Rifle Cartridge that Was Used in the Mitrailleuse .....	67
Farwell Machine Gun, Cal. .45 (Experimental Model) .....	69
Hotchkiss 37-mm Revolving Cannon Mounted on Ship's Gunwale .....	72
Section through Worm Wheel of Hotchkiss Cannon .....	74

	Page
Section through Loading Rack of Hotchkiss Cannon .....	74
Section through Drive Shaft of Hotchkiss Cannon .....	75
Hotchkiss 37-mm Revolving Cannon on Naval Deck Mount .....	77
Gardner Machine Gun, Model 1879, Cal. .45 .....	80
Section Drawing of Gardner Machine Gun .....	81
Section Drawing of Gardner Feed Action Showing Method of Indexing Cartridges for Loading .....	82
Section of Gardner Bolt Assembly Retracted .....	84
Section of Gardner Bolt Assembly in Battery .....	84
Gardner Single Barrel Machine Gun with Cover Open .....	85
Gardner Machine Gun, Cal. .45. This Weapon Could Be Used Either Water- or Air-Cooled .....	86
Robertson Double-Barrel Machine Gun, Cal. .30 .....	87
Lowell Machine Gun on Carriage Mount .....	90
Lowell Machine Gun with Cover Open and Barrels Depressed for Inspection ...	92
Lowell Machine Gun with Tripod Mount .....	94
Wilder Machine Gun on Tripod Mount .....	101
Section Drawing of Wilder Machine Gun .....	102
Dr. James H. McLean .....	104
Myron Coloney .....	105
Bailey Machine Gun, the First Such Weapon to Use a Belt Feed .....	107
Bailey Machine Gun Cartridge Belt. A Sketch Made by the Officer Who Tested the Weapon at the Washington Navy Yard, 1876 .....	108
The Mechanism of the Bailey Machine Gun. Sketched During the 1876 Trials ..	109
Nordenfelt Machine Gun, Cal. .45, With Gun Carriage Convertible to Tripod Mount .....	111
Nordenfelt Single-Barrel Machine Gun .....	112
Nordenfelt Machine Gun, Cal. .45, Five-Barrel Model. Mounted in Top of a Fighting Ship to Sweep the Decks of the Enemy .....	115
Taylor Machine Gun .....	117
Hiram Maxim at the Age of Seventeen .....	123
Hiram Maxim. Picture Taken Shortly Before His Death in 1915 .....	125
The First Automatic Weapon Patented by Maxim .....	128
The First Model Maxim Automatic Gun .....	130
A Drawing of Maxim's Original Machine Gun. Published in <i>Scientific American</i> , 1884 .....	132
Breech Mechanism of the Improved Maxim Gun .....	133
A Demonstration Gun and Mount Used by Maxim. The Wooden Case Was Used as a Tripod When Firing and to Contain the Gun and Ammunition During Transportation .....	135
Hiram S. Maxim Holding the Light Maxim Gun and Mounting .....	137
Maxim Machine Gun, Model 1893, Cal. .45 .....	139
Maxim Machine Gun, Model 1895, Cal. .303 .....	143
German Maxim Model 1908 with Sled Mount .....	145
Russian Maxim Model 1910 on "Sokolov" Wheeled Carriage .....	146
Maxim Automatic Gun After Firing 15,000 Rounds at an American Trial in 1899	147
British Sergeant Instructing American Troops in France .....	148
Skoda Machine Gun, Model 1893 .....	150
Section Drawing of Skoda Model 1893 .....	152
Skoda Machine Gun, Model 1909 .....	154

	Page
Original Repeating Rifle Developed by Jonathan Browning .....	157
John Moses Browning when 18 Years Old .....	157
Matthew Sandefur Browning .....	158
The First Shop and Arms Factory. John and Matt Browning are Shown in the Doorway. Left to Right Are Sam, George, John, Matt, and Ed Browning, and Another Gunsmith .....	159
John M. Browning at the Height of his Career .....	160
Browning's First Experimental Model of a Gas-Operated Automatic Firearm ....	161
Browning's First Gas-Operated Machine Gun .....	161
Original Letter From Browning Brothers to Colt's Patent Fire Arms Company, 1890 .....	162
Colt Machine Gun, Model 1895 .....	164
Section Drawing of Colt Model 1895 .....	165
John M. Browning with the "Browning Peacemaker" .....	167
Colt Machine Gun, Model 1895, as Modified in 1914 .....	169
Marriner A. Browning, Son of Matthew S. Browning, Firing the Recoil-Operated Machine Gun, Model 1901 .....	170
Section of Browning Cal. .30 Recoil-Operated Machine Gun .....	171
A Drawing From J. M. Browning's Drafting Board. Browning Often Worked from Frechand Sketches Made on Wrapping Paper .....	172
The Prototype Model of the B. A. R. ....	173
John M. Browning Examining One of His Automatic Machine Rifles in 1918 with Mr. Burton, One of Winchester's Experts .....	174
A Sectionalized B. A. R., Cal. 7.92 mm, of Polish Manufacture .....	175
B. A. R., Cal. .30, as Standardized for U. S. Service, Serial Number 5 .....	176
Browning Machine Gun, Model 1917, Cal. .30, as Introduced to the Service in World War I .....	177
Westinghouse Production of Model 1917 Cal. .30 Browning Machine Guns ....	178
Lt. Val A. Browning, Son of John M. Browning, in France Instructing Troops in the Use of the Browning Machine Gun, Cal. .30 .....	179
John M. Browning with His Cal. .30 Machine Gun .....	180
A Demonstration of the B. A. R. in 1918 .....	181
Gen. John J. Pershing, Whose Specifications Resulted in the Cal. .50 Machine Gun	182
A Rare Photograph of John M. Browning's Work Shop with an Early Model Cal. .50 Machine Gun .....	183
John M. Browning Firing His Cal. .50 Machine Gun in Colt's Pasture .....	184
Products of John M. Browning's Genius .....	185
Laurence V. Benét Firing the First Model Hotchkiss Machine Gun .....	188
Components of Hotchkiss First Model Gun .....	189
Section Drawing of Hotchkiss Machine Gun, Model 1897 .....	190
Hotchkiss Machine Gun, Model 1897 .....	192
Hotchkiss Machine Gun, Model 1903, the First Hotchkiss Gun to Use a Belt Feed	193
St. Etienne Machine Gun, Model 1907 .....	195
St. Etienne Machine Gun, Model 1907, 8-mm, Sectionalized .....	196
Benét-Mercié Machine Rifle, Model 1909. This Weapon Manufactured by Colt's Patent Fire Arms Company is Serial Number "O" .....	197
Components of the Benét-Mercié Model 1909 .....	198
Section Drawing of the Benét-Mercié Model 1909 .....	199
Function Firing the Hotchkiss Model 1914 in France .....	200
Hotchkiss Machine Gun, Model 1914, 8 mm. ....	201

	Page
Hotchkiss Balloon Gun, Cal. .472 .....	202
Nordenfelt Machine Gun, Model 1897, with Mount Folded for Carrying .....	204
Components of the Nordenfelt Machine Gun .....	205
Nordenfelt Machine Gun, Model 1897, with Mount Folded for Carrying .....	206
De Knight Automatic Machine Gun, Cal. .30, Manufactured by Pratt and Whitney .....	207
Madsen Machine Gun, Model 1903, Being Demonstrated by Lt. Schouboe .....	209
Madsen Machine Gun, Model 1903. Photographed During United States Trials..	211
Action of the Madsen. (A) Loaded, Locked, and Ready to Fire. (B) After Firing, Bolt Pivots Up to Eject Cartridge. (C) Bolt Pivots Down for Loading. (D) Loaded, Locked, and Ready to Fire. (E) and (F) The Action of the Loading Arm .....	212
Madsen Machine Gun, Model 1914, 8 mm .....	213
Theodor Bergmann Firing the First Model Bergmann Machine Gun .....	214
Bergmann Machine Gun, Model 1910 .....	215
Dreyse Machine Gun, Model 1912 .....	217
Section Drawing of Bergmann Machine Gun .....	218
Section Drawing of Dreyse Machine Gun .....	218
Perino Machine Gun, 6.5 mm .....	221
Perino Machine Gun with Right Side Hinged Down to Expose the Mechanism ..	222
Carr Machine Gun .....	225
Target Made by Carr Gun in 1901 Trials .....	226
Schwarzlose Machine Gun, Model 1907/1912 .....	229
Action of the Schwarzlose Gun .....	230
Schwarzlose Machine Gun, 8 mm .....	231
Samuel M. McClean Demonstrating His 37-mm Automatic Cannon .....	233
McClean Machine Gun, Cal. .30, Being Fired by the Inventor .....	234
McClean Machine Gun .....	235
McClean Machine Gun with Feed Drum .....	236
Chauchat Machine Rifle, Model 1915, 8 mm .....	238
Section Drawing of Chauchat Model 1918, Cal. .30 .....	239
American Troops Training with the Chauchat Machine Rifle .....	240
The Chauchat in Action with American Troops .....	241
Berthier Machine Gun, Model 1911 .....	243
Components of the Berthier Machine Gun .....	244
Berthier Machine Gun, Water-Cooled .....	246
Air-Cooled Berthier Machine Gun Tested by the United States Army, 1917 ....	247
Locking System Designed by Friberg and Used by Kjellman .....	248
Kjellman Heavy Machine Gun .....	249
Kjellman Light Machine Gun Being Fired by the Inventor .....	249
Revelli (Fiat) Machine Gun, Model 1914, 6.5 mm .....	251
Section Drawing of Revelli Mechanism .....	253
American Troops Receiving Instructions on the Revelli Model 1914 .....	254
Ader's Avion, the First Government-Sponsored Flying Machine .....	261
The Launching of Langley's Aerodrome, 7 October 1903 .....	262
The First Flight by Man. The Wright Brothers at Kitty Hawk 17 December 1903	263
One of the Airplanes Used by the Constitucionalistas in Mexico to Bomb Federal Gun Boats .....	267
The First Shot Fired from an Airplane. Glenn Curtiss, Pilot, and Second Lt. Jacob E. Fickel Holding the Rifle .....	269

	Page
The Successful Trial of the Chamblis Catapult at the Washington Navy Yard, 12 November 1912 .....	270
A Curtiss Airplane, the First to Accompany the Army in Maneuvers, Clearing a Stone Wall .....	272
Lt. Col. Isaac N. Lewis, U. S. A. ....	275
Captain Chandler, the First Man to Fire a Machine Gun from the Air, with Lt. Kirkland, His Pilot, at College Park, Maryland .....	277
Lewis Machine Gun, Cal. .303, British .....	278
Section Drawing of Lewis Machine Gun .....	280
Lewis Aircraft Machine Gun, Model 1914, Cal. .303, British .....	282
A Cartridge Catcher, Designed to Keep Spent Cartridges from Striking the Air- man or his Ship when Firing at the Enemy .....	283
Forward-Firing Lewis Machine Gun Mounted on a Pivoting Bracket so the Maga- zines Can Be Changed .....	284
British Troops with Lewis Guns Resting Between Attacks .....	286
A Device for the Lewis Gun Allowing It to be Fired from the Shoulder with Ease	287
Flexible Lewis Machine Gun Mounted on a Scarff Ring .....	288
Lewis Aircraft Machine Gun, Model 1914, Cal. .303, Twin-Mounted, French ....	290
Lewis Aircraft Machine Gun, Model 1918, Cal. .30, with 97-Round Magazine and Muzzle Booster .....	292
U. S. Marine Training with a Lewis Gun, 1917 .....	294
Lewis Machine Gun, Model 1917, Cal. .30 .....	296
Col. I. N. Lewis, U. S. A. (Retired) .....	297
Royalties Returned by Col. Lewis .....	298
Vickers Aircraft Machine Gun, Model 1915, Equipped for Synchronizing. Mount is for Purposes of Photographing Only .....	302
Vickers Machine Gun, Synchronized with Propeller in a Pursuit Plane, World War I .....	303
Vickers Aircraft Machine Gun, Model 1918, Cal. 11 mm, Manufactured by Colt's Patent Fire Arms Co. ....	304
Vickers Aircraft Machine Gun, Class "F", Cal. .303 .....	305
Vickers Machine Gun, Mark C, Cal. .50 .....	306
Vickers Machine Gun, Mark V, Cal. .50 .....	307
Maxim Machine Gun, Model 08/15, 7.92 mm, German .....	309
Parabellum Aircraft Machine Gun, Model 1913, 7.92 mm. This Early Type Used the Water-Cooled Jacket Slotted for Air Cooling .....	311
Parabellum Aircraft Machine Gun, Model 1913, 7.92 mm, with Refined Barrel Jacket .....	313
Maxim Machine Gun, Model '08/15, 7.92 mm, Modified for Synchronizing. This Weapon, Manufactured at the Spandau Arsenal, is Often Called the Spandau Machine Gun .....	314
Maxim Machine Gun, Model '08/15, 7.92 mm, Modified for Aircraft Installation Carl G. Swebilus .....	316
Marlin Aircraft Machine Gun, Model 1917, Cal. .30 .....	320
Marlin Aircraft Machine Gun, Model 1918, Cal. .30 .....	321
Marlin Tank Machine Gun, Model 1918, Cal. .30 .....	322
Marlin Ground Machine Gun, Cal. .30 .....	324
Browning Aircraft Machine Gun Mounted on a Bristol Fighter in England for First Test of the Browning in the Air .....	325
Browning Aircraft Machine Gun, Model 1918, M1, Cal. .30 .....	327
Browning Aircraft Machine Gun, Model 1918, M1, Cal. .30 .....	329

	Page
U. S. Aircraft Machine Gun, Model 1921, Cal. .30, Fixed .....	329
U. S. Aircraft Machine Gun, Model 1922, Cal. .30, Fixed. This Weapon Was De- signed to Feed from the Left or Right Side .....	330
U. S. Aircraft Machine Gun, Model 1922, Cal. .30, Flexible. This Weapon Fired Over 20,000 Rounds in Test and Was Still Serviceable .....	331
Top: Browning Aircraft Machine Gun, M2, Cal. .30, Fixed. Bottom: Browning Aircraft Machine Gun, M2, Cal. .30, Flexible (Sectionalized) .....	332
First Trials of Browning Cal. .50 Machine Gun in Colt's Pasture. Fred Moore Firing the Weapon and John M. Browning Standing .....	334
Aircraft Machine Gun, Model 1918, Cal. .50, Manufactured by Winchester Arms Company .....	335
Top: Aircraft Machine Gun, Cal. .50, M2, Fixed. Bottom: Aircraft Machine Gun, Cal. .50, M2, Fixed (Sectionalized) .....	336
Japanese Copy of the Browning Aircraft Machine Gun, Cal. .50, Type 1941, Fixed Loading Cal. .50 Ammunition on an F6F Aboard the USS Saratoga .....	338
Browning Machine Gun, Cal. .50, Water-Cooled, in Action as Anti-Aircraft Defense .....	339
"Eight-Gun Nose" Installation for B-25 Aircraft. Each Browning Cal. .50 Is Pro- vided with 400 Rounds of Ammunition for Ground Strafing .....	340
Firing the Benét-Mercié Machine Gun from a Deperdussin Airplane, 1914 .....	341
Benét-Mercié Machine Gun Firing Forward. The Propeller is Protected by a De- flection Plate Originated by R. Garros .....	345
An Early Front-Gun Spad with False Nose to Accommodate Gunner .....	346
Benét-Mercié Machine Gun Adapted as an Aircraft Flexible Mount .....	347
Hotchkiss Aircraft Machine Gun, 13.2 mm .....	348
Hotchkiss Ground Machine Gun, 13.2 mm .....	350
Machine Gun, Model 3 (1914), 6.5 mm, Japanese .....	350
Machine Gun, Model 01 (1941), 7.7 mm, Japanese .....	353
Revelli (Fiat) Aircraft Machine Gun, Model 1914, 6.5 mm, Flexible .....	354
Revelli (Fiat) Machine Gun, Model 1926, 6.5 mm .....	356
Drawing of Fiat Model 1926, 6.5 mm .....	357
Drawing of Fiat Model 1928, 6.5 mm .....	359
Fiat Machine Gun, 12.7 mm, Anti-Aircraft .....	359
Fiat Aircraft Machine Gun, Model 1928 A, 7.7 mm .....	361
Fiat (Revelli) Machine Gun, Model 1935, 8 mm .....	362
Dreyse Machine Gun, Model 1915, 7.92 mm .....	362
Bergmann Machine Gun, Model 1915, N. A., 7.92 mm .....	364
Components of the Bergmann Machine Gun, Model 1915, N. A. ....	365
Machine Gun Model 13, 7.92 mm .....	367
German Troops Training with the MG-13 .....	368
Villar-Perosa Aircraft Machine Gun, 9 mm .....	369
S. I. A. Aircraft Machine Gun, 6.5 mm .....	371
S. I. A. Machine Gun, 6.5 mm .....	374
S. I. A. Aircraft Machine Gun, 6.5 mm, Dual Flexible Mount .....	375
Section Drawing of S. I. A. Aircraft Machine Gun .....	376
Gast Aircraft Machine Gun, 7.92 mm .....	377
Gast Aircraft Machine Gun, 7.92 mm, with Feed Drums Removed .....	379
Breech Mechanism of Gast Aircraft Machine Gun .....	380
Gast Aircraft Machine Gun, 7.92 mm. Top View with Feed Drums in Place ....	382
Darne Aircraft Machine Gun, 7.5 mm. Dual Flexible Mount .....	383
	384

Darne Aircraft Machine Gun, Model 1918, Cal. .303 .....	385
Darne Aircraft Machine Gun, 7.5 mm. This Is a Fixed Gun for Synchronizing ..	387
Darne Machine Gun, Model 1929, 7.5 mm .....	388
Beardmore-Farquhar Aircraft Machine Gun, Cal. .303 .....	390
Beardmore-Farquhar Aircraft Machine Gun, Cal. .303 .....	391
Brixia Machine Gun, 6.5 mm .....	393
Components of the Brixia Machine Gun, 6.5 mm .....	394
Brixia Machine Gun, 6.5 mm .....	395
Mendoza Machine Gun, 7 mm, Right Side .....	397
Components of the Mendoza Machine Gun .....	398
Mendoza Machine Gun, 7 mm, Left Side .....	399
Chatellerault Machine Gun, Model 1923, 7.5 mm. This is a Prototype Gun, Serial No. 11 .....	401
Chatellerault Machine Gun, Model 1924-29, 7.5 mm .....	402
Components of the Chatellerault Machine Gun .....	404
Chatellerault Aircraft Machine Gun, Model 1934-39, 7.5 mm, Fixed .....	405
Madsen Aircraft Machine Gun, 7.92 mm. Flexible Twin Mount .....	407
Madsen Machine Gun, Model 1926, 7 mm, Water Cooled .....	408
Madsen Tank Machine Gun, 7.5 mm .....	409
B. S. A. Aircraft Machine Gun, Cal. .50 .....	413
Receiver, Grip and Feed of B. S. A. Aircraft Machine Gun, Cal. .50 .....	414
Breda Machine Gun, Model 1924, 6.5 mm. The Operator is Loading the Weapon	416
Components of the Breda Machine Gun, Model 1924 .....	417
Breda Machine Gun, 6.5 mm, Showing Ease of Barrel Change .....	418
Breda Machine Gun, Model 1930, 6.5 mm .....	419
Breda Machine Gun, Model 1931, 13.2 mm .....	420
Breda Machine Gun, Model 1937, 8 mm .....	421
Breda Machine Gun, Model 1938, 8 mm .....	421
Components of the Breda Machine Gun, Model 1938, 8 mm .....	422
Breda Aircraft Machine Gun, 12.7 mm .....	423
Furrer Machine Gun and Components, Model 1925, 7.5 mm .....	426
Drawing of Furrer Machine Gun Action .....	427
Furrer Machine Gun, Model 1925, 7.5 mm, Left Side .....	428
ZB Machine Gun, Model 1925, 7.92 mm .....	429
Section Drawing of the ZB Machine Gun .....	430
ZB Machine Gun, Model 1926, 7.92 mm .....	431
Bren Machine Gun, Mk I, Cal. .303 .....	433
Bren Machine Gun, 7.92 mm. A Czech Weapon Adopted by the British and Manufactured for the Chinese in Canada .....	433
ZB Machine Gun, Model 96, 6.5 mm. A Japanese Copy of the Czech Weapon ...	434
ZB Machine Gun, Model 50-1932, 7.92 mm. The Only Weapon Designed by ZB Based on the Short Recoil Principle .....	435
ZB Machine Gun Model 53-1937, 7.92 mm .....	436
Besa Machine Gun, Mk II, 7.92 mm .....	437
ZB Machine Gun, Model 60-1938, 15 mm .....	438
Besa Machine Gun, Mk I, 15 mm, as Viewed from Below .....	439
Besa Machine Gun, Mk I, 15 mm, Top View .....	439
A Berthier Machine Gun, Cal. .30, Mounted as a Flexible Gun in a Curtiss Plane by the U. S. Navy, 1917 .....	441
Vickers-Berthier Aircraft Machine Gun, Mk I, Cal. .303 .....	443



	Page
Vickers-Berthier Aircraft Machine Gun, Mk I, Cal. .303, Mounted on a Scarff Ring .....	444
Lahti Machine Gun, Model 26/32, 7.92 mm .....	446
Section Drawing of the Lahti Machine Gun, Model 26/32 .....	447
Lahti Machine Gun With Drum Magazine .....	448
Solothurn Machine Gun, Model 1929, 7.92 mm .....	451
Drawings Showing Stange's Action. Top: Bolt in Battery, Locked, Ready to Fire. Center: Gun Fired, Barrel Recoil Rotating Locking Ring. Bottom: Locking Ring Fully Rotated and Bolt Unlocked .....	452
Solothurn Machine Gun, Model 1930, 7.92 mm .....	454
Rheinmetall Aircraft Machine Gun, Model 15, 7.92 mm .....	455
Rheinmetall Aircraft Machine Gun, Model 17, 7.92 mm .....	456
Components of the Rheinmetall MG-17 .....	456
Rheinmetall Aircraft Machine Gun, Model 131, 13 mm, Fixed .....	458
Rheinmetall Aircraft Machine Gun, Model 131, 13 mm, Flexible .....	459
Scotti Aircraft Machine Gun, 7.7 mm .....	461
Drawing of Scotti's Action. Top: Bolt in Battery and Locked. Slide in Forward Position to Prevent Bolt Head from Rotating. Bottom: Slide Retracted by Gas Piston, Allowing Bolt Head to Rotate and Unlock .....	462
Scotti Aircraft Machine Gun, 12.7 mm .....	462
Bang Aircraft Machine Gun, Cal. .276 .....	464
Sistar Heavy Machine Gun, 7.92 mm .....	465
Sistar Light Machine Gun, 6.5 mm. The Operator Is Loading the Magazine .....	466
Sistar Light Machine Gun, 6.5 mm. The Operator Is Charging the Weapon .....	467
Knorr-Bremse Machine Gun, Model 1933, 7.92 mm .....	469
Components of the Knorr-Bremse Machine Gun, Model 1933 .....	470
Knorr-Bremse Machine Gun, Model 35/36, 7.92 mm .....	471
Mauser Machine Gun, Model 1934, 7.92 mm .....	473
Mauser Machine Gun, Model 1934 S, 7.92 mm .....	474
Comparison of Component Parts of the Mauser Machine Guns of the MG-34 Series. (A) MG-34. (B) MG-34 (Modified). (C) MG-34 S. (D) MG-34/41 ..	476
Comparison of Mauser Machine Guns of the MG-34 Series. (A) MG-34. (B) MG-34 (Modified). (C) MG-34S. (D) MG-34/41 .....	477
Mauser Aircraft Machine Gun Model 81, 7.92 mm, Dual Mount .....	478
Melvin M. Johnson, Jr., Firing the Weapon He Designed .....	481
Johnson Light Machine Gun, Model 1941, Cal. .30/06 .....	482
Johnson Light Machine Gun, Model 1941, Disassembled For Paratroop Work ..	483
Machine Gun, Model 42, 7.92 mm .....	484
Components of the Machine Gun, Model 42 .....	486
Machine Gun, Model 42, 7.92 mm. View Shows Cover Open and Barrel Release Latch Open with Barrel Partly Removed .....	488
Machine Gun Model FG-42, 7.92 mm .....	489
Section Drawing of the Machine Gun FG-42, Showing the Action Immediately After Firing. Gas from the Barrel Is Acting on the Piston which Will Rotate and Unlock the Bolt .....	490
Cleland Davis When He Was a Lieutenant, USN .....	495
A Davis Gun Mounted on a Naval Seaplane. The Gunner Has Pivoted the Breech to the Open Position for Loading .....	496
Davis Gun Mounted for Anti-Submarine Patrol .....	498

	Page
The Davis Principle Applied in World War II. The Germans Attempted Firing a 1,500-Pound Shell from this Dornier 217 .....	499
C. O. W. 37-mm Automatic Aircraft Cannon Mounted in a Voisin Battle Plane, 1915 .....	500
C. O. W. 37-mm Automatic Aircraft Cannon Mk III .....	501
Vickers-Armstrong 37-mm Automatic Aircraft Cannon, Mounted in a Blackburn "Perth" Flying Boat .....	503
Fiat (Revelli) 25-mm Aircraft Cannon .....	506
Puteaux 37-mm Aircraft Cannon (Semi-Automatic) Mounted on a French Bombing Plane, 1916 .....	507
Puteaux 37-mm Automatic Aircraft Cannon .....	509
Puteaux 37-mm Aircraft Cannon, Mounted in the Cylinder Block of a Hispano-Suiza Engine to Fire through the Propeller Hub .....	510
Puteaux 47-mm Aircraft Bombardment Cannon .....	511
Becker 20-mm Automatic Aircraft Cannon, Model 1918 (Flexible) .....	512
Semag 20-mm Automatic Aircraft Cannon (Flexible) .....	513
Semag 20-mm Automatic Cannon for Infantry .....	514
Oerlikon 20-mm Automatic Aircraft Cannon, Model F (Flexible), Adopted by Germany .....	516
Oerlikon 20-mm Automatic Aircraft Cannon, Model 99 (Fixed). This Belt-Fed Weapon Was Manufactured in Japan and Used by Its Naval Air Force .....	517
Oerlikon 20-mm Automatic Aircraft Cannon, Model S. Wing Installation with Belt Feed of 125 Rounds Adopted by the German Air Force .....	518
Antoine Gazda Firing the Gazda 20-mm Automatic Cannon .....	519
Gazda 23-mm Automatic Cannon .....	520
Polsten 20-mm Automatic Cannon Mk. I. Drawing Shows 30-Round Magazine ..	521
Szakats 20-mm Automatic Aircraft Cannon, Model SZB .....	523
The Feed Mechanism of the Szakats Automatic Aircraft Cannon .....	524
Szakats 20-mm Automatic Aircraft Cannon, Model SZC .....	525
Baldwin 37-mm Automatic Aircraft Cannon .....	526
Baldwin 37-mm Automatic Aircraft Cannon Mounted for Test in a Martin Airplane .....	528
Baldwin 37-mm Automatic Aircraft Cannon. Picture Shows the Method of Mounting in Aircraft .....	529
The First Model of the Browning 37-mm Automatic Aircraft Cannon Being Tested in the Foothills Above Ogden, Utah. Left to Right: Matt S. Browning, John M. Browning (the Inventor), John Browning (Son of the Inventor) and Ed Browning .....	531
Early Model Browning 37-mm Automatic Aircraft Cannon .....	533
Browning 37-mm Automatic Aircraft Cannon, M4 .....	534
Browning 37-mm Automatic Aircraft Cannon, M9, Mounted in an A25 .....	535
Madsen 20-mm Automatic Aircraft Cannon, Model 1926 (Prototype) .....	537
Madsen 23-mm Automatic Aircraft Cannon (Flexible) .....	538
Components of the Madsen 23-mm Automatic Aircraft Cannon .....	539
Section Drawing of the Madsen 23-mm Automatic Aircraft Cannon .....	540
Hotchkiss 25-mm Automatic Aircraft Cannon (Fixed) .....	542
Bolt, Lock, and Gas Piston Assembly of the Hotchkiss 25-mm Automatic Aircraft Cannon .....	543
Bolt, Lock, and Gas Piston Disassembled, Hotchkiss Automatic Aircraft Cannon.	544

	Page
Scotti 20-mm Automatic Aircraft Cannon .....	545
Scotti 20-mm Automatic Cannon on Anti-Aircraft Mount .....	546
Lübbe 20-mm Automatic Aircraft Cannon and Feeder .....	548
Lübbe 20-mm Automatic Aircraft Cannon Disassembled .....	549
Ehrhardt 20-mm Automatic Aircraft Cannon .....	550
Rheinmetall (Solothurn) 20-mm Automatic Cannon Model ST-5 on a Naval Mount .....	551
Rheinmetall (Solothurn) 20-mm Automatic Cannon Model ST-5, Showing Ease of Disassembly .....	552
Rheinmetall 20-mm Automatic Aircraft Cannon, Model ST-11 .....	553
Rheinmetall (Solothurn) 20-mm Semi-Automatic Anti-Tank Cannon, Model S18-1000 .....	553
Rheinmetall 37-mm Automatic Cannon, Flak 18 .....	554
Rheinmetall 30-mm Automatic Aircraft Cannon, MK-101 .....	556
Rheinmetall 30-mm Automatic Aircraft Cannon, MK-103 .....	557
Bolt Assembly of Rheinmetall's 30-mm Automatic Aircraft Cannon, MK-103. Left: Bolt Mechanism Disassembled. Right: Bolt Mechanism Assembled and in the Locked Position .....	557
Rheinmetall 30-mm Automatic Aircraft Cannon, MK-108 .....	559
Rheinmetall 30-mm Automatic Aircraft Cannon, MK-108, Disassembled. (1) Blast Tube. (2) Back Plate Assembly. (3) Bolt Assembly. (4) Receiver and Barrel Assembly. (5 and 7) Driving Spring Assembly. (6) Charger Spring Assembly. (8) Sear Plate Assembly. (9) Feed Cover Plate Assembly .....	560
Marc Birkigt, Designer of the Hispano-Suiza 20-mm Automatic Aircraft Cannon, Type 404 .....	562
The Method of Locking Patented by Carl Swebilius .....	564
The Method of Locking Patented by Marc Birkigt .....	565
Section Views of the Hispano-Suiza Action .....	567
Hispano-Suiza "Birkigt" 20-mm Automatic Aircraft Cannon, Type 404. Mounted on a Hispano-Suiza 12-Cylinder Engine to Fire through the Propeller Hub. ...	569
Hispano-Suiza 20/60 Automatic Aircraft Cannon. Experimental Model Manufactured by the British M. A. R. Company .....	571
Hispano-Suiza 30-mm Automatic Aircraft Cannon. This is an Experimental Model Manufactured in France .....	573
Hispano-Suiza 20-mm Automatic Aircraft Cannon. Top: U. S. M2. Bottom: U. S. M1 .....	576
Hispano-Suiza Automatic Aircraft Cannon AN-M2 with Feed Mechanism, 20-mm AN-M1. Developed from the French Chatellerault Feeder .....	580
Comparison Drawing of the Type Designations of the 20-mm AN-M2 .....	584
Hispano-Suiza 20-mm Automatic Aircraft Cannon, Model T31 .....	587
American Armament 37-mm Automatic Aircraft Cannon (Flexible) .....	594
American Armament 37-mm Automatic Aircraft Cannon .....	595
Lahti 20-mm Automatic Aircraft Cannon, Model L27, with Drum Feed .....	596
Lahti 20-mm Automatic Aircraft Cannon, Model L27 .....	597
Breda 20-mm Anti-Tank Automatic Cannon .....	598
Bolt Assembly of the Breda 20-mm Automatic Cannon. Left: Bolt in Traveling Position. Right: Bolt Locked in Battery Position .....	599
Breda 20-mm Automatic Aircraft Cannon with Cover Group Open, Exposing Feed Mechanism .....	600

	Page
Mauser 20-mm Automatic Aircraft Cannon, Model 151, Mounted for Anti-Tank Duty .....	602
Component Parts of the Mauser 20-mm Automatic Aircraft Cannon, Model 151..	604
Mauser 20-mm Automatic Anti-Aircraft Cannon, Model Flak 38, with Cover Group Raised .....	605
Bolt Assembly of the Mauser 20-mm Automatic Anti-Aircraft Cannon, Model Flak 38 .....	606
Cal. .90 Automatic Aircraft Cannon, Model T2, with Feed Mechanism .....	607
Cal. .90 Automatic Aircraft Cannon, Model T2 .....	608
Components of the Cal. .90 Automatic Aircraft Cannon, Model T2 .....	609
Bofors 20-mm Automatic Aircraft Cannon .....	611
Bofors 20-mm Automatic Cannon, Model L/70, on a Field Carriage .....	612
20-mm Automatic Aircraft Cannon, Model IIO5 .....	614
20-mm Automatic Cannon, Model 98, Dual Anti-Tank Mount .....	615
Bolt and Bolt Extension Assembly of the 20-mm Automatic Cannon, Model 98 ..	616
Statue at the Entrance to National Archives Building, Washington, D. C. ....	618

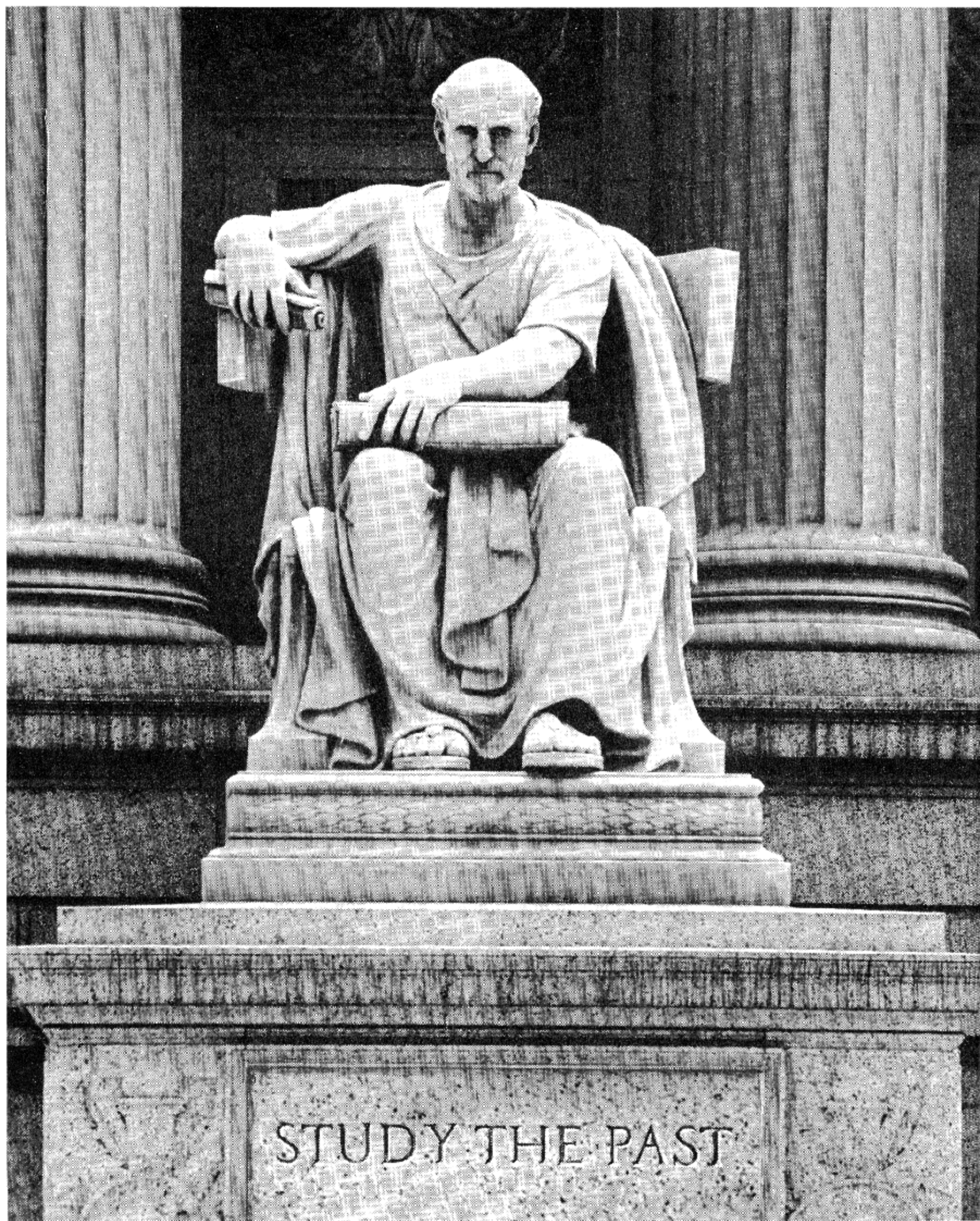

Statue at Entrance to National Archives Building, Washington, D. C.

PART I

FORERUNNERS OF THE MACHINE GUN

# WEAPON HISTORY PRIOR TO GUNPOWDER

## Primitive Beginnings

The club was so universally employed by primitive man that, although originally intended as a tool for providing food and collecting wives, it can be considered the ancestor of all weapons of war. It has been a companion arm of man, in one form or another, since the beginning of time. Today, as a reminder of its once devastating force, it is used as a symbol representing the highest authority, i.e., the field marshal's baton and the emperor's scepter—a tribute to the man who best wields the club.

It was indeed an eventful day when prehistoric man stepped from the path of his upward climb for the purpose of starting the world's second oldest profession—that of making war upon his fellow man. In fact, those who have made a study of the causes of conflict insinuate that the second profession probably arose from a disagreement over an incident involving the first.

Waiting in ambush with a club, the first aggressor little dreamed he was setting the tragic pattern of later generations which, marveling at their own cleverness, underestimate their opponent's ability to devise a defense in an emergency. He felt secure in his ability to annihilate his enemy with one blow. His own hunting skill was unexcelled, his club combined many improvements of which his fathers had never dreamed, and the object of his wrath was approaching unaware of danger.

It is easy to picture the utter surprise of this early tactician when his intended victim survived the initial assault. Driven more by self-preservation than forethought, the latter made a successful escape by evasive action and the use of an entirely new principle of attack—throwing rocks.

Having to retreat before the rain of missiles, the aggressor realized that new dangers now lay in his every movement if the enemy was not

promptly destroyed. He gathered his relatives to witness that he had been unfairly attacked and to convince them that the security of all rested on their ability to help him eliminate the menace.

The adversary likewise had friends and relatives, who banded together on hearing of their clansman's attempted annihilation and his successful counter-attack. Sensing danger, and realizing that a new weapon was at their disposal, they moved to high ground, where they could observe the approaching foe and throw down rocks or roll boulders on him.

These simple acts cover all the basic arts known and practiced in warfare today. The most important was the employment of missiles for the first time as a weapon. Man has traveled far along the path of progress. He has found occasion to pause more times than civilization would care to admit, in order to seize, save, or sanctify those things of his neighbor which he deemed worthy of the effort. However, he has yet to achieve the mental capacity to replace, either in conquest or defense, the earliest of his discoveries—the missile weapon.

True, throughout the centuries countless man hours and sums of money have been expended to break away from this mode of lethal delivery. However, the result has been only a refinement—evolutionary, but in no sense revolutionary.

Even the club did not remain unchanged. Man, in his unholy desire to conquer, made early refinements. In the stone age, for instance, a rock with a sharp edge was fastened to his club to form an ax. When iron or copper was first smelted, a metal spear blade added much to the cutting and puncturing ability of the club. It soon evolved into a very versatile instrument that could kill a man by three methods—cutting, concussion, or perforation. These techniques have remained basic throughout the years. The double-edged battleax with a pike on the blade end and a spiked ball secured by a short chain to

the rear of the handle represents the last word in the development of the club from a single-purpose bone-crushing affair to a tri-method instrument of death.

The discovery that under the influence of heat metals could be cast and worked into different forms not only brought about an improvement in club design but opened the avenue for other types of weapons, already thought of, but heretofore found impracticable because of lack of appropriate materials. The best example of this type is the knife.

When the possibilities of metal-working were realized, knives and daggers appeared in thousands of shapes—short and long, blunt and sharp, heavy cleavers, and long slim rapier blades. All continued to be produced in endless procession. The finest art known to metalwork can be found in the early elaborate designs and scrollwork on the knife and sword. In an attempt to beautify the finished product, inlays of precious stones and pictorial scenes carved on the handles and blades were common.

The origin of our present metallurgy begins with man's efforts to temper the cutting edge of his weapons. Nothing was left undone in his constant experimentation—including quenching the red-hot blade in a living human body, in the belief that the blood gave the blade a superior cutting power.

Each of the many designs was for a specific purpose. The dagger originated as a weapon to be inserted through the vulnerable joints and openings in armor. The broad sword was short, wide, and sharp on both edges, and was used like a cleaver to split an enemy down the middle. Later swords were again narrowed and straightened for use in thrusting, to take the place of the powerful slicing stroke.

The Far East contributed the scimitar with its crescent-shaped blade sharpened on one side only. The curve added much to the slicing power. And in due time its influence reached Europe to be incorporated in the cavalry saber with its long single-edged blade slightly curved.

### The First Projectile Throwers

Projectile-throwing devices were developed also and used in conjunction with the club and

knife. From the first rock throwing and rolling came the sling, bow, and catapult.

The bow is one of the earliest projectile throwers devised by man. Some insist it preceded the sling, and attempt to substantiate their claim by the pictures of bows drawn by the prehistoric hunter-artists in the caves of southern France and Cantabria in the tenth millennium B. C. However, there are others who contend the cavemen-cartoonists were merely depicting better weapons than the slings of their forefathers.

The sling in its simplest form is thought to have come from the observation that when a stone was attached to a club or bludgeon and came loose as the club was swung, it traveled a much greater distance than if thrown by hand.

The Phoenicians were credited by ancient writers with invention of the sling. These inhabitants of the Balearic Isles used leaden projectiles with a purported range of over 600 yards. Ancient Egyptian and Assyrian soldiers also used slings.

In 1062 B. C. David of Israel used one to defeat Goliath of Gath. However, David's accomplishment in overcoming the giant, with the resulting destruction of the Philistine army by King Saul's men, was only secondary to the military lesson pointed out by his actions preceding the battle. His handling of the problem was perfect. Seeing that he was outclassed by his opponent in the application of orthodox warfare, he chose the weapon that best utilized his skill, and calmly decided on the number of missiles he could carry without impairing his mobility and the correct caliber to destroy completely his opponent with one direct hit. He then confidently carried the fighting to the enemy.

Nor was David's act an isolated case of marksmanship, in which luck played more part than skill. The Bible also credits to the tribe of Benjamin phenomenal accuracy with this weapon: "Among all this people there were seven hundred chosen men left-handed; every one could sling a stone at an hair and not miss."

The Roman Legions called the slinger the "funditor," and considered him an integral part of the army. The slinger continued long after his legendary acts had been outmoded in distance and accuracy by the innovation of me-



chanical means of propulsion. It was finally recognized that human muscle had reached its limit. The sling's last major military appearance was during the Huguenot Wars.

Among the hand projectile-launchers, however, the bow served man more efficiently than anything of a similar nature. The earliest ones were generally made from any tough straight-grained wood that would bend and snap smartly forward, without having a tendency to break.

A cord of sinew, gut, or hemp kept the bow in a graceful arc, and served as the agent for transmitting the stored energy of the bow. Arrows were originally long thin tubular pieces of wood tipped with chipped stone. A small group of feathers on the aft end tended to keep the arrow on its true course to the target. Some of the achievements credited to bows and arrows are almost unbelievable.

The constant search to better his existing weapons led the prehistoric warrior to experiment with the construction of bows. The horns of animals were steamed and cut into strips. They were then dried, glued, and scraped into the desired shape. In addition to laminated horn, combinations of woods and the ribs of animals were used. They were wrapped with strips of inner tree bark, or animal gut, in the belief that greater throwing power was given.

The most popular and efficient was a plain solid wood affair, sometimes tipped with horn to prevent splitting, and to facilitate removing or replacing the bowstring. The choice of wood depended on geographical location, as every section had varieties that adequately met the needs of the early bow maker.

The idea of a more powerful weapon to out-range the bow and sling, received serious constructive study in the East during the ninth and eighth centuries B. C. According to the Bible, Uzziah, who reigned from 808 to 756 B. C., "made in Jerusalem engines invented by cunning men, to be in the towers and upon the bulwarks, to shoot arrows and great stones withal." Ezekiel records that Nebuchadnezzar in besieging Tyre set engines of war against the walls. This siege took place at the beginning of the sixth century B. C.

The Greeks were slower to adopt such improvements. Diodorus records an expedition of

Dionysius, tyrant of Syracuse, against the Carthaginians in 397 B. C.: "The Syracusians . . . killed great numbers of the enemy by their sharp arrows, shot out of their engines of battery." From Syracuse the war engine was introduced into Greece.

Dionysius also attempted to improve upon the single bow by inventing a weapon called the *Polybolus*, or repeater thrower, which projected a succession of arrows supplied from a kind of magazine. This is the first recorded example of a mechanical means of sustained fire, giving the soldier who operated it the firepower of several men. There was an interval of thirteen centuries before another advance in fire power warrants mention. At the Battle of Hastings a few archers were equipped with a mechanical bow arrangement designed to discharge several arrows at a time.

"Engines of War," mentioned by Biblical and classical writers, usually were variations of the catapult and the ballista. The first was for high, and the second for low, angle fire. In either case the propelling force was transmitted by tightly twisted skeins of hemp, hair, or sinews. (Replicas of these instruments have been made, but the method of maintaining the elasticity of the sinew remains unsolved.)

The origin of the catapult seems to have been a bent-over, forked sapling for hurling rocks. However, this idea was improved till it became a bulwark in offensive and defensive warfare.

A heavy wooden framework carried strong rope strands across the base. Into these twisted ropes went the tossing beam, with a cuplike holder at the top. Winches pulled back the thrower, twisting the rope so that a great force was stored as in an elastic cord or spring. When released, the throwing beam whirled up and forward, struck against the brake timber, and tossed its rock from the cup a few hundred yards. Catapults were not very accurate, but a battery of them could pound a wall or fort to dust in a few days.

The scorpion type catapult is described by the historian Amianus Marcellinus (A. D. 400): "In the middle of the ropes (twisted skein) rises a wooden arm like a chariot pole. . . . To the top of the arm hangs a sling. . . . When battle

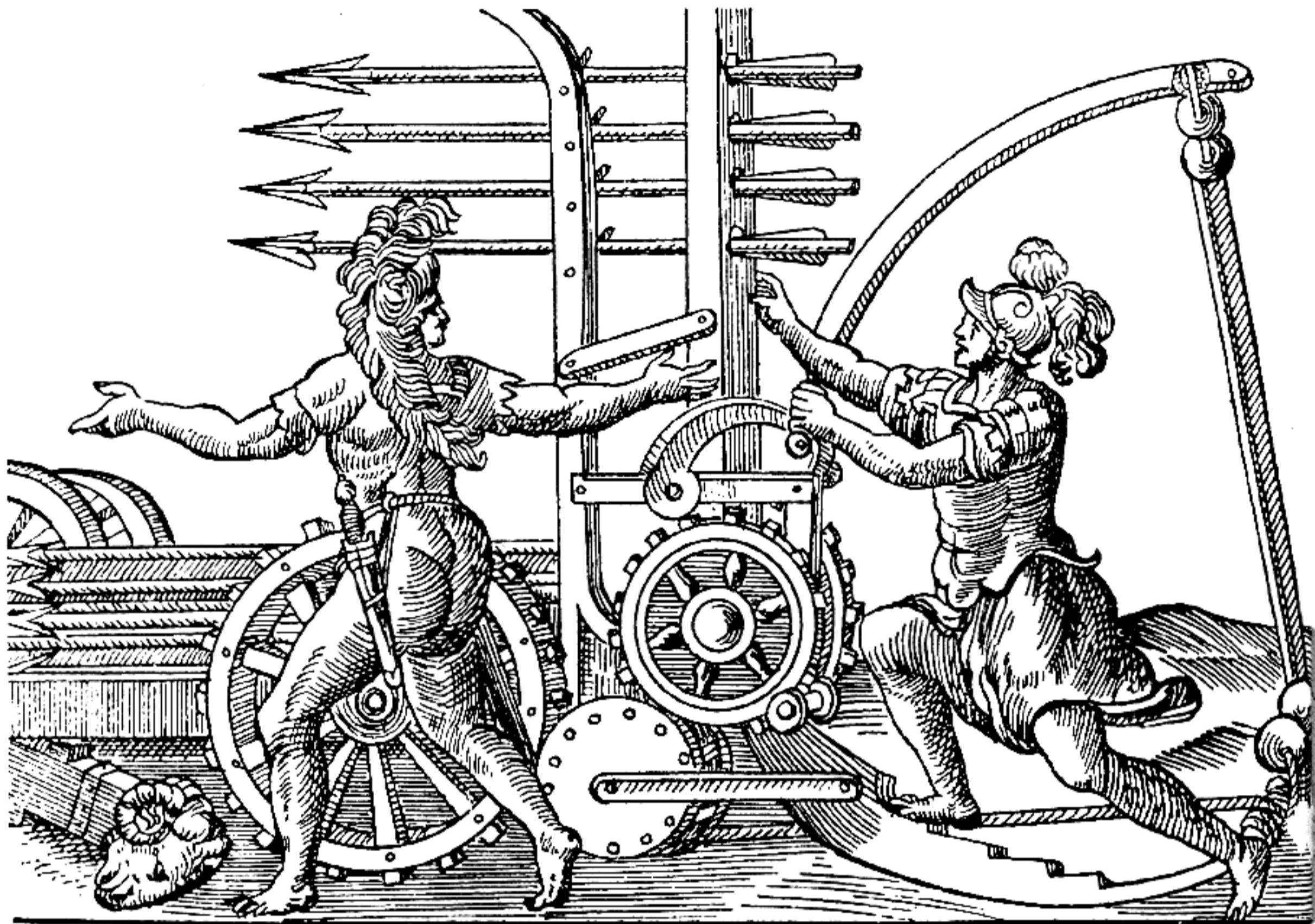

A Spring Engine.

is commenced a round stone is placed in the sling . . . four soldiers on each side of the engine wind the arm down till it is almost level with the ground. . . . When the arm is set free it springs up and hurls forth from its sling the stone, which is certain to crush whatever it strikes." This engine was called a scorpion because of its shape.

The sling on the scorpion added greatly to the range of the catapult. The maximum distance for a round stone weighing one talent (approximately 58 pounds) was recorded at 400 yards. Ranges varied up to 800 yards depending on the weight of the missile used. The projectiles were not always stones that had been rounded. Sometimes they were pebbles molded with clay into balls and baked to a pottery finish. These shattered upon impact, throwing fragments which the enemy could not reuse in his own machines.

### Medieval Instruments of War

The trebuchet was a medieval contribution to the rock-throwing devices. It got its power, not from a taut cord or twisted rope, but from a heavy counterweight. The throwing beam was swiveled on a strong axle near the top of the framework. The bottom carried heavy weight and the top a throwing cup. Winches pulled back the top so that the bottom weight moved up and forward. Upon release, the weighted beam swung down like a huge pendulum. The top struck the brake beam, and the rock was hurled in the general direction of the enemy fortifications.

These siege engines threw other missiles besides stones and javelins. They threw millstone, flaming projectiles, putrid corpses, and live men. A dead horse in the last stage of decomposition was bundled up and shot by a trebuchet into a town.

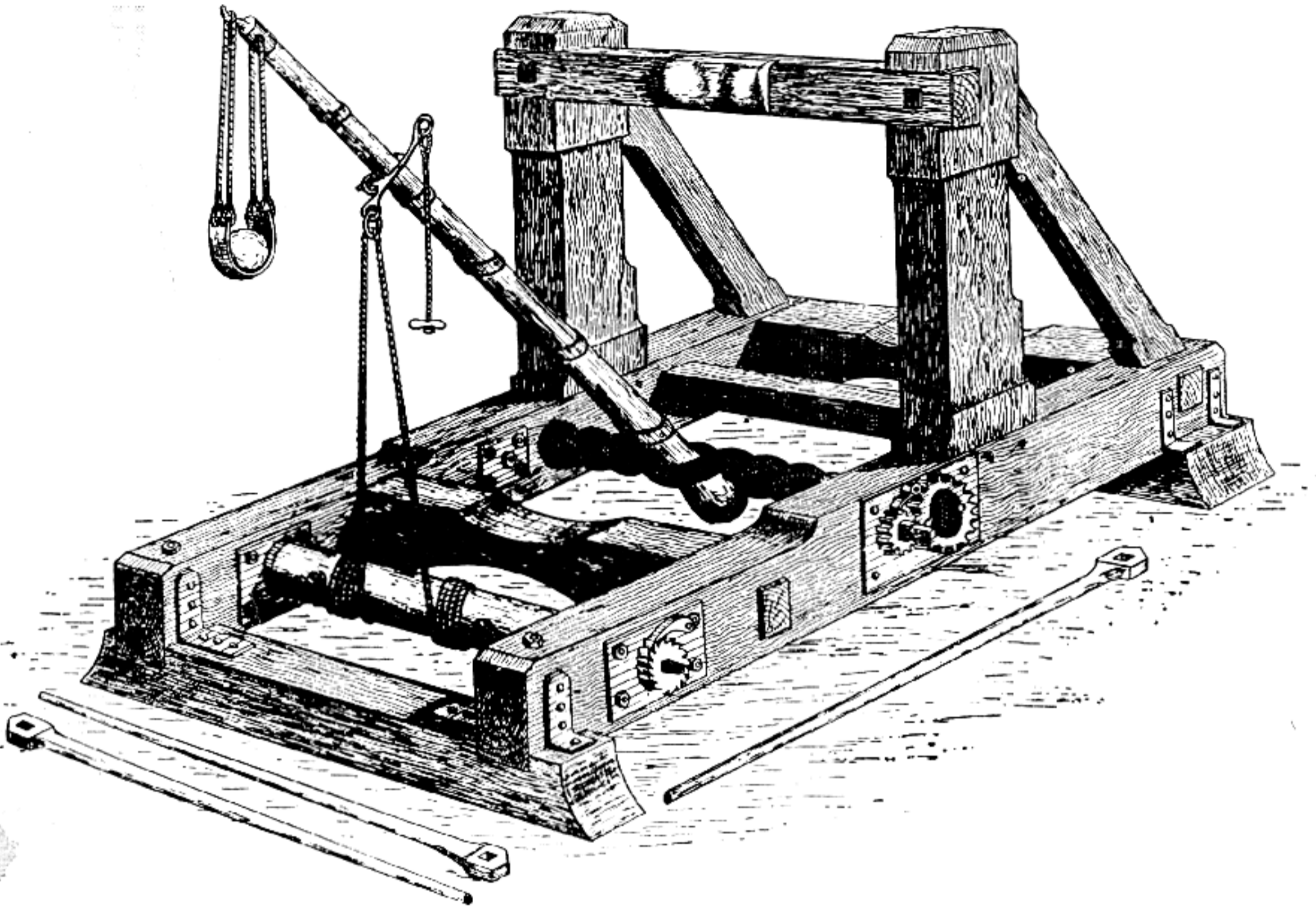

A Catapult for Slinging Stones.

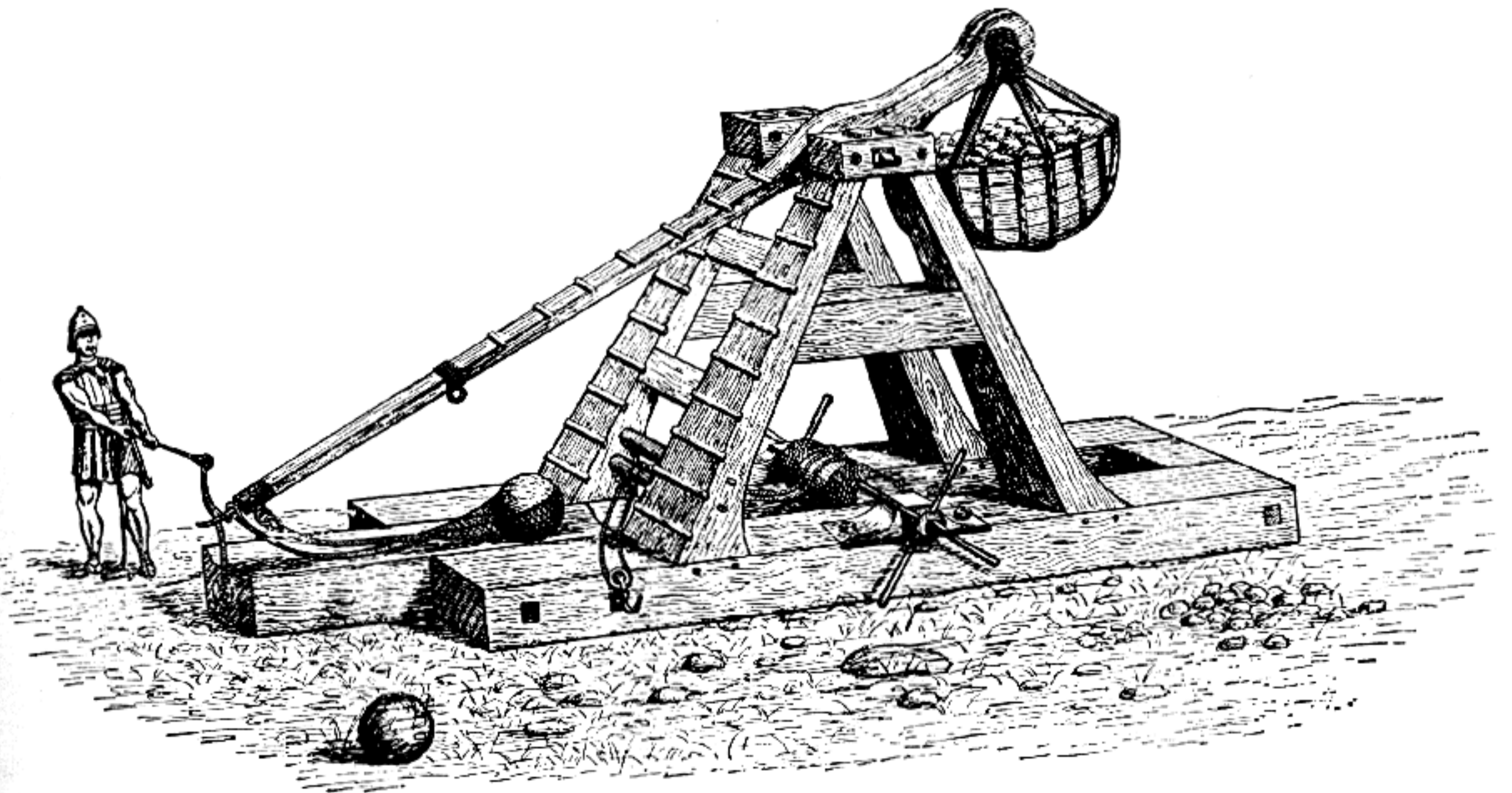

The Trebuchet.

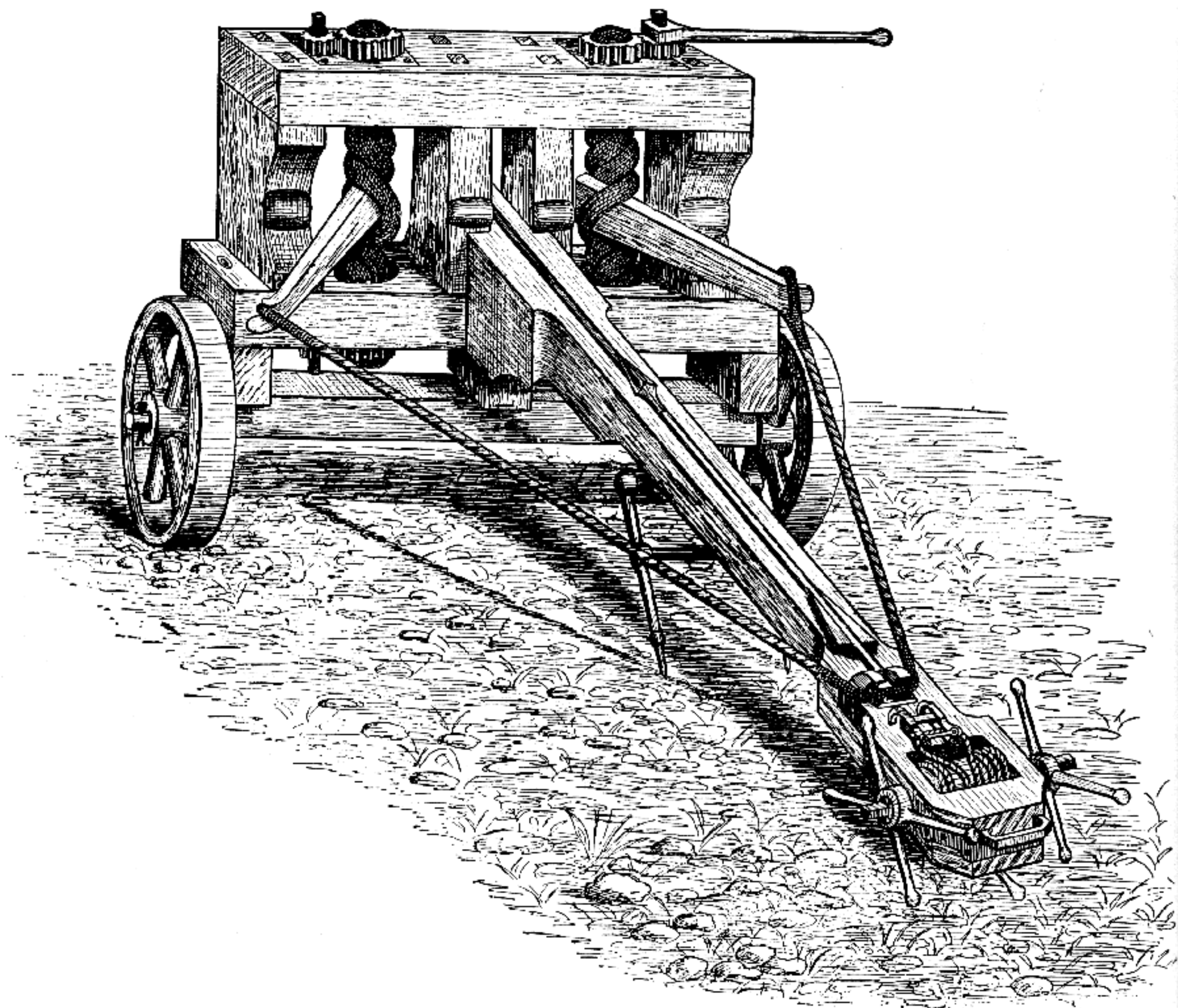

The Ballista.

of which the defenders were half dead with starvation, started a pestilence.

The ballista usually consisted of a sturdy framework which held a horizontal bow of strong laminated wood. From its ends extended a heavy cord of hemp or gut which was pulled back by winches until a very heavy tension was obtained. The gut string worked in a grooved frame into which a javelin 10 or 12 feet long was placed. When the release allowed the arms to snap forward, the javelin was driven 450 to 500 yards with a tremendous force and unusual accuracy for this type of weapon.

Another form of ballista used twisted rope made from hair and sinew for elasticity. Even small engines of this type with 2-foot arms and

4-inch ropes could throw a 1-pound round stone 300 to 350 yards.

An improved arrangement of the ballista had an upright frame carrying two pairs of vertical ropes which, when twisted, furnished the necessary energy. A wooden piece was thrust between each pair of ropes forming the two arms of the bow. These were connected at their other ends by a bowstring. A slotted stock in the frame served as a guide along which the bowstring propelled the missile (either bolt or ball). Tension was applied by a winch.

One type of ballista employed an oversized bow laid horizontally and cocked mechanically. This heavy device was much older than the in-

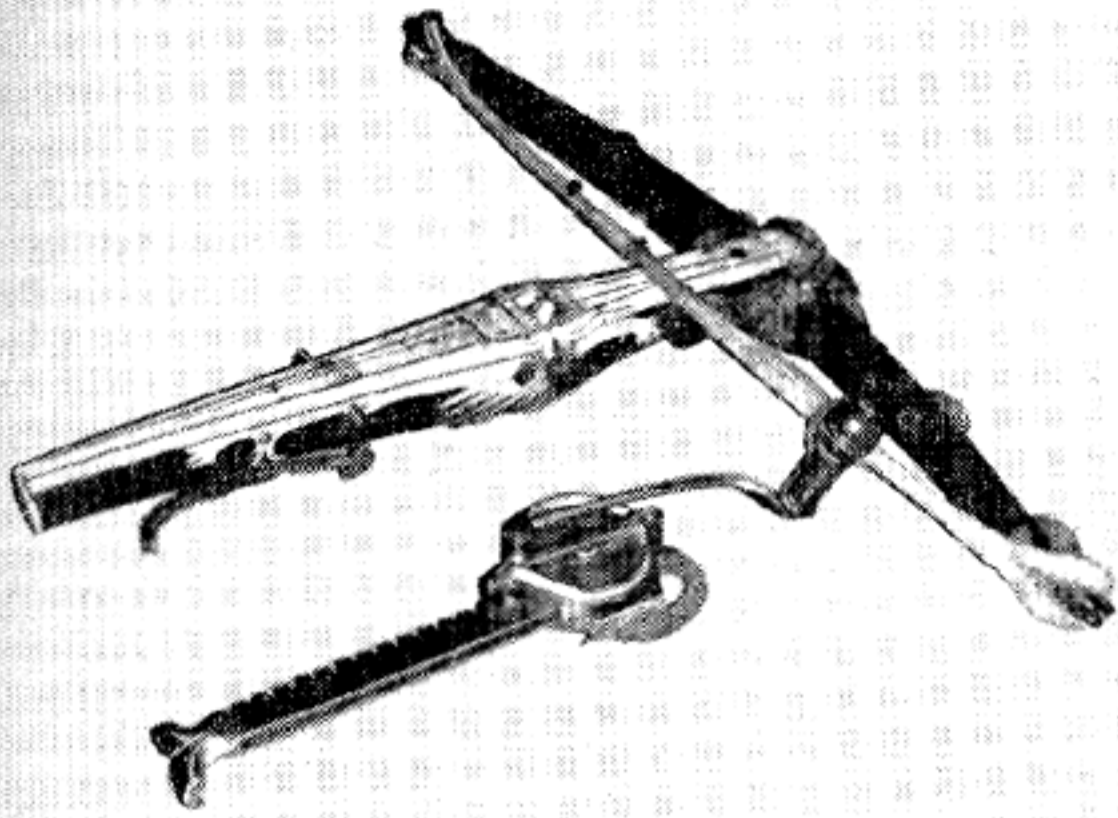

A Heavy German Crossbow and a Cranequin for Cocking.

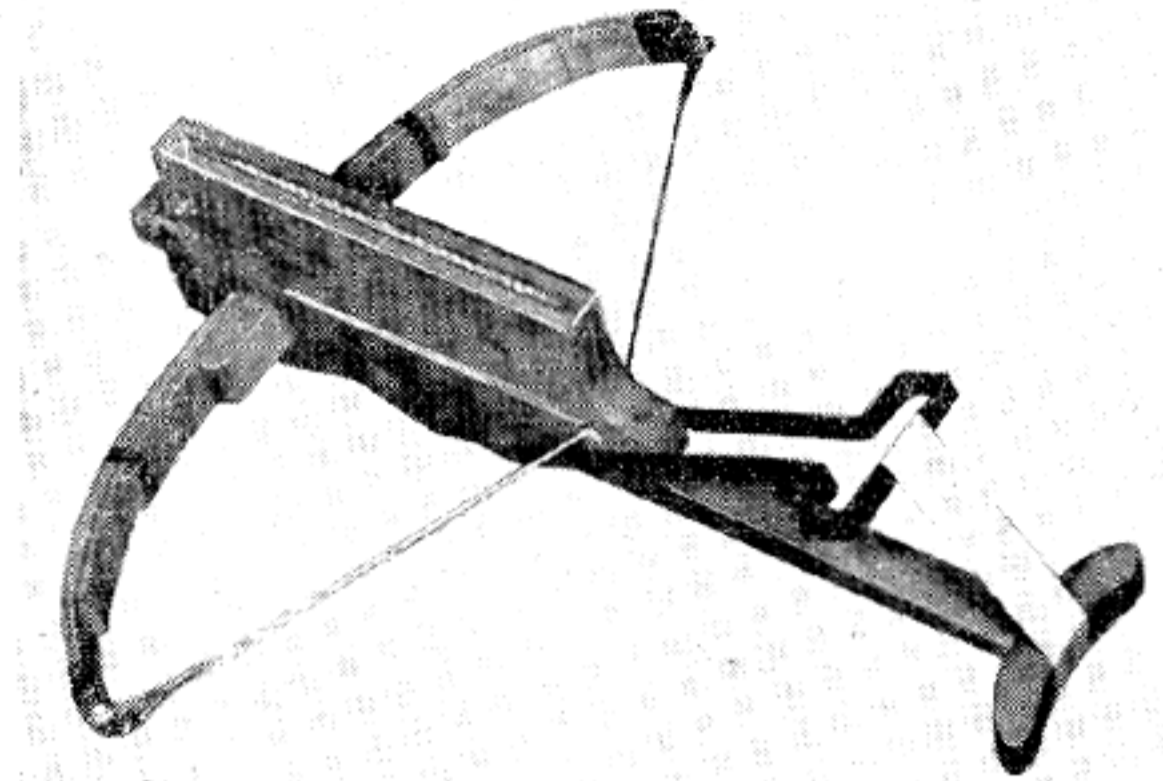

A Crossbow with Magazine Feed.

dividual soldier's crossbow, that it so closely resembled. The latter was an eleventh century adaptation of the larger weapon, combining the basic working principles of the bow and catapult and reducing the size and weight until it could be operated by a single soldier.

Norman artisans are credited with invention of the crossbow. Its use was general throughout the armies of Europe after its introduction, but it was by no means looked upon with favor by all the rulers of the time. Pope Innocent II in 1139, after the Second Lateran Council, called it "a most barbarous and cruel weapon" and forbade its use among warring Christian nations under penalty of anathema as "a weapon hateful to God and unfit for Christians."

The hiring of foreign crossbowmen was also prohibited by the Magna Charta. However, its use in war against the infidels had the blessings of the Church. As a weapon it was much admired by Richard Cœur de Lion. On his crusade against the unbelievers he took a thousand crossbowmen with him. After he popularized it, the crossbow came into general use in all European armies in spite of anathema. Therefore, Richard's death from a crossbow quarrel was considered a judgment from heaven, for he had championed a weapon that could "proletarianize war."

Although England gave the crossbow the needed stimulus to overcome the objections of the Church, it was the first country to realize its military shortcomings. As a weapon it was secondary to the simpler and more powerful long-

bow. Therefore, the crossbow was replaced quickly in England by the latter.

The English longbow, which gained prevalence in the fourteenth century, is considered the highest degree of refinement of the bow. It was used effectively, and with fair accuracy, at ranges of 600 to 800 yards. The phenomenal success of the English archer was no matter of chance but the result of deliberate planning.

From the reign of Edward I (1271-1307) to the sixteenth century, there were placed in the English code statutes which later became known as the Archery Laws. These compelled every male citizen from 12 to 60 years of age, except nobility, to practice with a longbow on Sundays and holidays. Archery ranges were erected in every town at community expense; and the village officials were charged with providing equipment, and with the planning of community meets.

During this period the design of the longbow was standardized. Specifications stated that it must be constructed of elm, 6 feet 4 inches in length, and capable of driving "an arrow at a hundred yards through a 4-inch oak door until the arrow and shaft protruded from the other side the width of a hand's breadth." A fair price was also set to encourage ownership. A plain bow could be purchased for one shilling. A painted bow cost 1 shilling and 6 pence. Standard arrows three feet long were furnished at a rate of two dozen for 1 shilling and 2 pence.

One has only to read early English history to realize the important part these laws played

in building the English archer into the most respected soldier of his day. The outline of the longbow can be seen clearly in the colorful chapters of continuous conflict with the best armies central Europe could muster.

The Battle of Crecy, fought on 26 August 1346, represents the peak efficiency of the longbow as a military weapon. The English army, commanded by Edward III (1327-77), was outnumbered 4 to 1. Yet, it routed and practically annihilated the powerful army of Philip VI of Valois. The perfect marksmanship of the English longbowmen maintained throughout the battle a superiority of fire of ten arrows against one from the crossbows of Philip's Genoese. It was common for the expert English archers to have three arrows in the air at one time from the same bow. Not only did they have a higher rate of fire, but they greatly outranged Philip's soldiers. The English arrows easily pierced the light armor of the French horsemen, upon whose charges Philip had relied to bring him ultimate victory. Although the cavalry made 16 attempts to break the English lines, not one attack was even partially successful. The battle lasted only a few hours, but the English bowmen pumped volley after volley of arrows into the hapless French forces, until they were a struggling mass of wounded horse and foot soldiers trying to escape.

This state of affairs allowed the English to massacre them. A fair picture of the deadliness of the bow in the hands of these skilled longbowmen can be drawn from the fact that of the 40,000 men in King Philip's original army, over 20,000 were casualties in one form or another. The English losses were listed as negligible, in the amount of 50 men.

With the overwhelming victory at Crecy, the English longbow was firmly established as the

paramount military weapon of the day. The English army, as a result, enjoyed its greatest reputation throughout Europe. The French, in justifiable alarm, sought the services of Italian metalsmiths to design coats-of-mail capable of resisting the penetrating powers of the high-velocity longbow arrows.

At the Battle of Auray, in 1365, the French and English again met under conditions somewhat similar to Crecy. However, this time the French felt secure in their new armor. It took but a short time for the English to discover that their formerly lethal arrows were being deflected harmlessly to the ground. They also observed, in an equally short time, that while the French soldier had protected himself against the arrows, he had done so at the expense of mobility. Each individual was so loaded with his own armor that movement was very difficult. The English promptly threw down their longbows, not in disgust, but because they sensed an easier solution to the work at hand. They advanced boldly on their stiffly encased foes, and seizing the Frenchmen's own axes and pikes, they beheaded and bludgeoned thousands, inflicting losses that were even greater in comparison than those at Crecy. Oddly enough, the reputation of the longbow was even more enhanced by this fact. For, it was quickly realized throughout the military world that to protect oneself adequately against longbow arrows required wearing such cumbersome armor that the wearer would be exposed to almost certain death from other means.

It can safely be said that the bow was the first-line instrument of war for several thousand years. But never in all history has the skill of the English archer of the fourteenth century been closely approached.

## FIREARM DEVELOPMENT TO PERCUSSION IGNITION

## Origins of Gunpowder

Strange as it may seem, the Battle of Crecy, which showed the longbow at its best, was also the scene of an incident that sounded the death knell, not only of the bow, but of all merely mechanical means of missile propulsion. This battle saw the first recorded use of artillery in an engagement between major armies and heralded explosives as a means of missile propulsion. However, the justified praise of the longbow was so great at this time that were it not for the meticulous writings of a few historians of the day, it would have gone unnoticed that Edward III employed stampede cannon on his flanks. These devices represented artillery in its crudest form, and were mainly used, as the name implies, to scare the enemy's horses and strike terror into the untrained foot soldier. Missile throwing ability was secondary. Earliest cannon design appears to have been that of an iron tube incased in wood to give it further support, and still keep it light. The explosive was a crude black powder to which generally was added various kinds of wax, the mixture being made into balls. The balls, when discharged, produced an effect somewhat like an oversized Roman candle. The cannon's front end was supported by a metal fork and, to take care of recoil, the butt simply was placed against a convenient knoll. Firearm development stems from this modest beginning.

Just as human muscle had its limitation, so did the awkward and bulky mechanical missile throwers, which in turn gave way to a newer more efficient means for waging war; namely, the chemically stored energy called gunpowder.

That the Chinese knew of gunpowder centuries before, there is no doubt. Their Gentoo Code of Laws, credited with having been written about the time of Moses, contains a thought-provoking section which has been translated as follows:

"The Magistrate will not make war with any deceitful machine, or poisonous weapons, or with cannon or guns, or any kind of firearms."

With the first application of gunpowder to propel a missile, the technological phase of warfare begins and human elements, both physical and moral, are minimized, intellect alone remaining supreme. This has done more to democratize fighting than any other event in history.

While a natural interest is attached to the antiquity of any material which so revolutionized warfare, yet the actual date of the discovery is of little military significance compared to that of its first use as a fuel for the engines of war.

Both Roger Bacon and Barthold Schwartz, a German monk, are erroneously credited with the discovery of gunpowder. Their contribution was the preparation of explosive mixtures. Gunpowder, as such, did not exist till the mixtures were applied to the propelling of missiles.

Roger Bacon describes black powder in his *Concerning the Marvelous Power of Art and Nature, and Concerning the Nullity of Magic* (1252). This document was addressed by the author to a high official of the church and was written to defend himself against the charge that he had been devoting too much time to magic and the practice of black arts.

He pointed out that many phenomena commonly attributed to magic are due only to the operations of nature. He further fortified his position by referring to many natural things which are understood by a chosen few, but considered marvelous by others: "For, regardless of the power of Nature, Art using Nature for an instrument is more powerful by virtue of this fact."

Bacon spoke of the simple deceits which are practiced by jugglers and ventriloquists, and commented that "nothing that men wish it to do, so long as men are agreed about it."

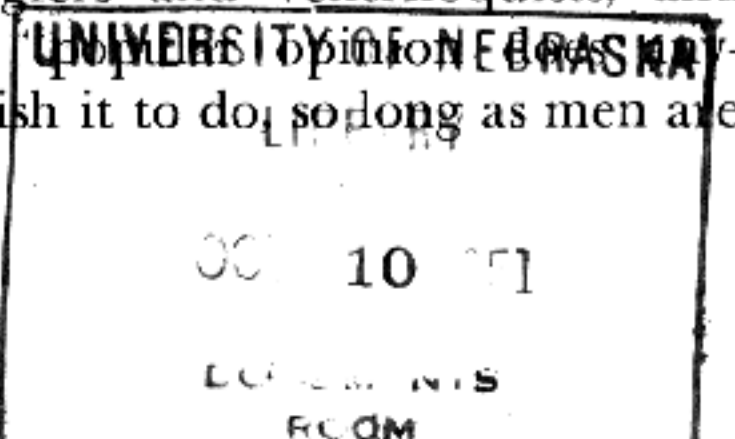

"In addition to these marvels, there are certain others which do not involve particular constructions. We can prepare from saltpeter and other materials an artificial fire which will burn at whatever distance we please . . . Beyond these are still other stupendous things in Nature. For the sound of thunder may be artificially produced in the air with greater resulting horror than if it had been produced by natural causes. A moderate amount of the proper material, of the size of a thumb, will make a horrible sound and violent coruscation."

Bacon speaks also of the purification of saltpeter by dissolving the salt into water, and boiling until the scum has risen to the top. The scum is then removed and the solution is allowed to crystallize. The mother liquid is evaporated for another crop of crystals, which are then piled up in a warm place to dry. Such was the method of refining the basic ingredient of black powder by Roger Bacon (1219-92) in his half magical laboratory.

Without saltpeter there could have been no refined gunpowder. As there is no mention of it before the thirteenth century, it is quite possible that Bacon discovered its absolute importance in the chemical mixture of "seven parts of saltpeter, five of young hazelwood (charcoal), and five of sulphur." This was the standard military formula for many years following the *Epistolae de Secretis Operibus Artis et Naturae et de Nullitate Magiae*.

Although Bacon suggests several military uses for his explosive (for instance, "an enemy might be either blown up bodily or put to flight by the terror caused by the explosion"), there was nothing to be found in any of his writings to show he ever once contemplated its use as a missile-throwing agent. The identity of the individual who first thought of propelling a projectile through a tube from the force generated by gunpowder still remains a mystery.

An Arabic document dated 1304 mentions a mortar type cannon. Two records at Ghent dated 1313 and 1314 also refer to such weapons. Christ Church of Oxford, England, owns an illuminated manuscript which pictures the early "dart-throwing vase," or "pot-de-fer." This weapon was used in the siege of Metz (1324) and by Edward III in Scotland in 1327. (But stampede

cannon were recognized by Edward III to be of more tactical value.)

The German monk, Barthold Schwartz, of Cologne (1310-84), has often been credited with originating gunpowder. He undoubtedly invented a system for casting bronze cannon, and established a workshop in Venice in 1377. He was ordered put to death by the Venetian Senate for insisting he be paid for his work on cannon design.

Schwartz's experiments with cannon and the art of casting naturally brought him into constant contact with the unrefined mixtures that were used to load the weapons. He even made attempts to better the concoctions. On one occasion these efforts resulted in an explosion that almost completely demolished his crude laboratory. From this and other stories arose the belief that he discovered gunpowder.

The Uffizi Museum in Florence is credited with having formerly possessed a picture by Giacomo Cresspi (late fifteenth century artist) which showed Schwartz in his laboratory with many workmen making powder. The existence of this painting has been questioned, although it has been used as evidence by many gunpowder historians. However, any artist depicting a historical character, predating him by a century, must necessarily use imagination. Such a work cannot be considered as documentary evidence. Schwartz never claimed to have originated gunpowder or firearms, but he did attempt to improve both.

Between 1345 and 1349 the Wardrobe Account of Edward III of England carries an entry crediting one Thomas of Roldeston for work on the king's guns and for 912 pounds of saltpeter and 886 pounds of live sulphur. This tends to show that other craftsmen were working on gunpowder as a propelling charge in guns before Schwartz opened his workshop in Venice.

### Early Multibarrel Firearms

In 1339 mention is first made of a new type of firearm called the "ribauld" or "ribauldequin." This was a primitive multibarrel affair that consisted of several iron tubes, so arranged as to be fired simultaneously. Its purpose was to blast an opening in the solid rank of heavily armored



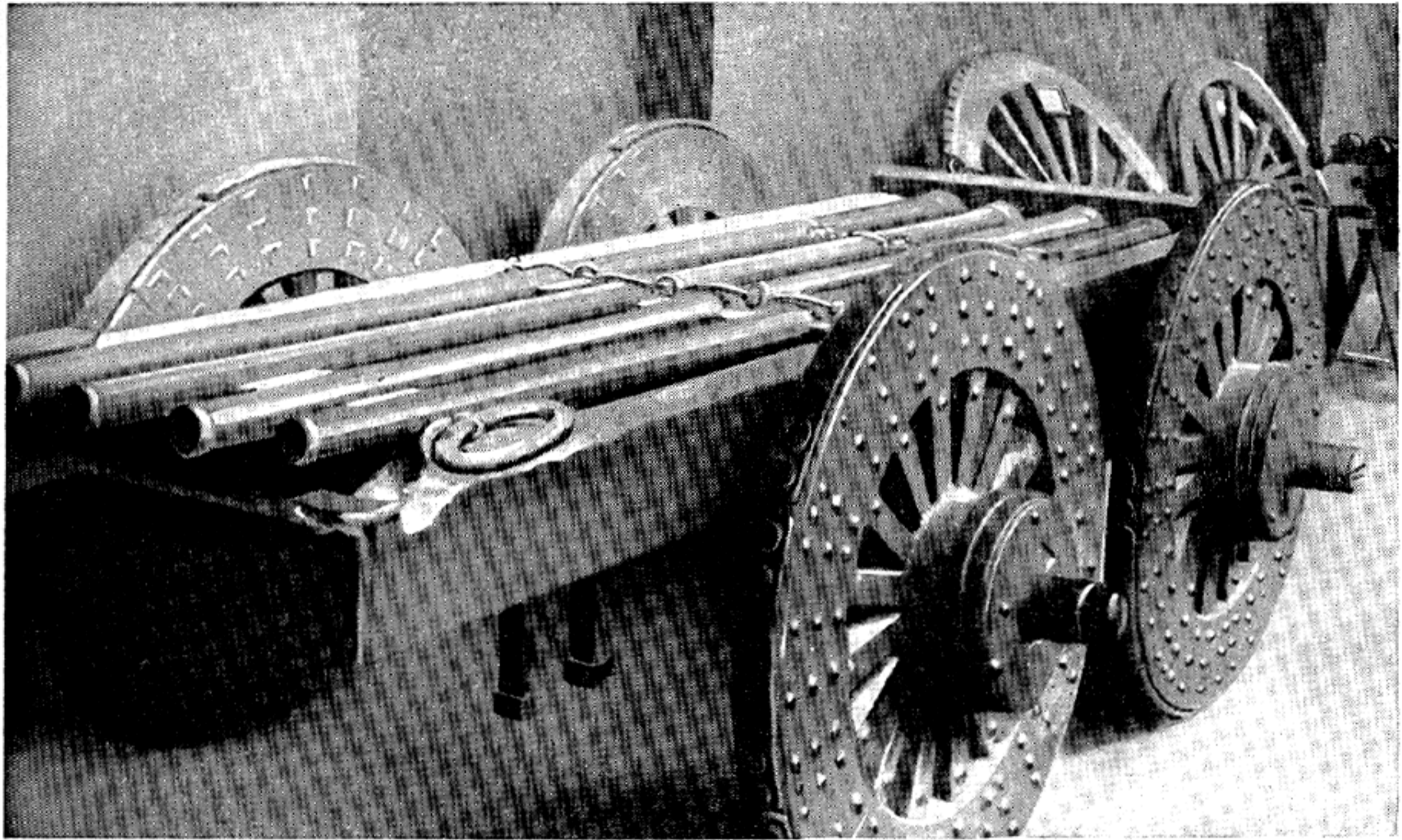

An Early Chinese Organ Gun.

pikemen who were supposed to keep the cavalry from the bowmen.

In one of England's wars with France, Edward III used this weapon to good advantage in conjunction with his battle-tested stampede cannon. For, even at this early date, the theory of volume fire was being considered by the military.

The desire for a multifiring weapon predated the first use of gunpowder in battle. The various experiments to accomplish this end have led, over the years, to an epidemic of designs, all of which were to serve but one purpose—to fire a volley of balls in the direction of the enemy, and to do so repeatedly with the employment of a minimum number of soldiers.

One of the most progressive types of firearms in the fourteenth century was a wrought iron single-shot breech-loading gun, the breech of which was wedged after being dropped into position. The principle was somewhat the same as the present-day system of locking. It is a curious fact that gunmakers should have developed so advanced a method of charging and then aban-

doned it in favor of the inferior muzzle loading.

Considering the crude work of the fourteenth century mechanic, the religious restrictions of the times, and the total ignorance of metallurgy in relation to powder pressure, the progress in firearms was comparatively rapid.

In those days of muzzle-loading battery guns, the universal method of placing the barrels in stacks side by side in a frame led these assemblies to be called "organ guns" or "orgues des bombardes."

The iron ball missile that came into use in 1381 to replace the pebbles and rounded stones, was considered the answer to the armored foot soldier. The attempts to deliver these missiles in a concentrated area led to the many types of early battery guns.

In 1382 the army at Ghent had 200 "chairs de cannon" in the field. These weapons consisted of a number of barrels fastened horizontally on two-wheeled carts with pikes and heavy sharp blades attached to the hubs as a further lethal garnishment. In 1411 the Burgundian army had 2,000 of these weapons.

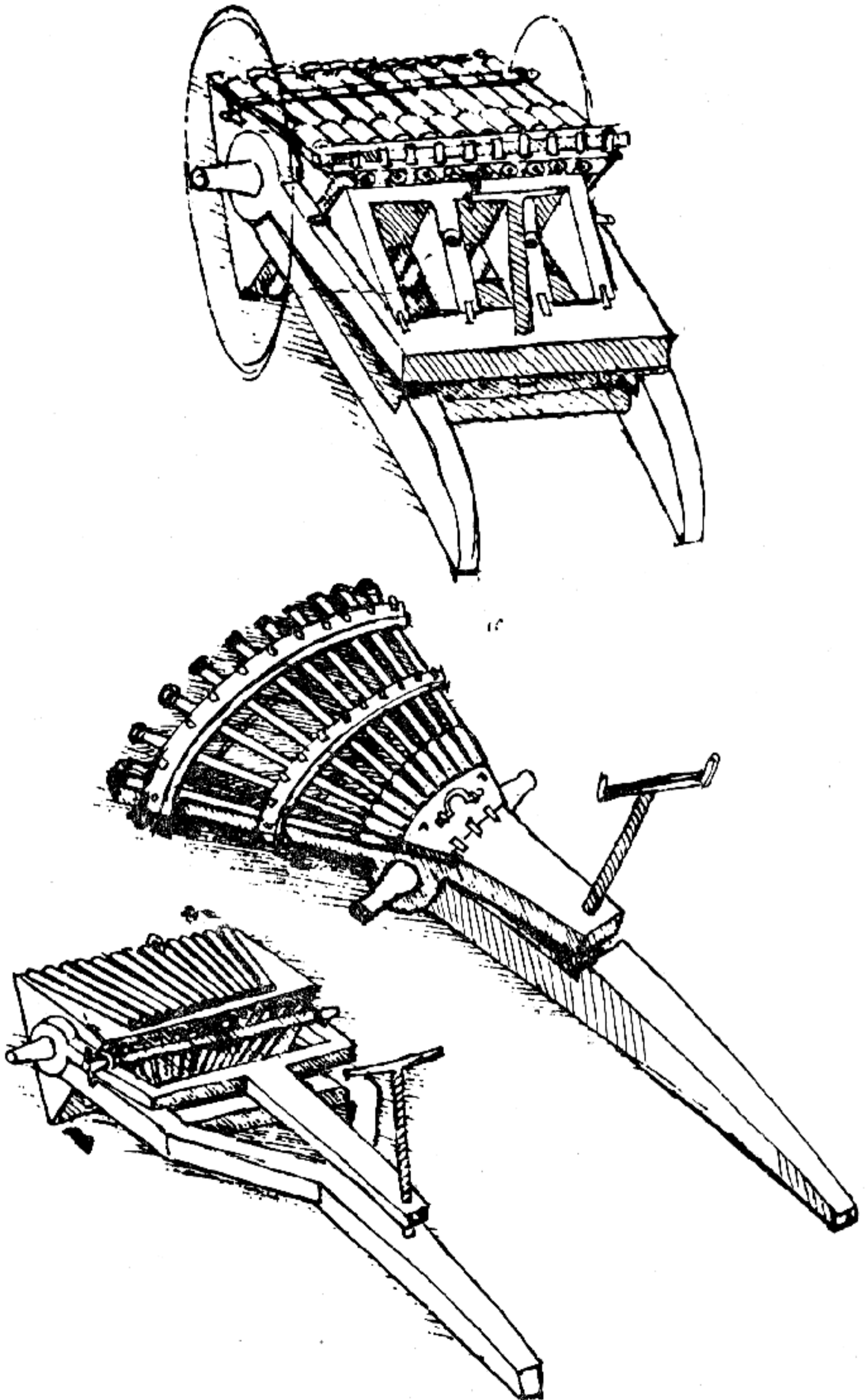

Volley-Firing Guns Designed by Leonardo da Vinci.

A more elaborate design having 144 barrels was constructed in 1387. These were grouped in batteries, allowing 12 salvos of 12 balls each to be fired against the enemy.

Regardless of the clumsy mounting and great transportation difficulties of the organ gun, the demand for fire power, even then, led to their use in many theaters of operation. The Venetian general, Collconi, employed the "orgues des bombardes" as a mobile auxiliary in connection with his armored cavalry at the battle of Piccardini (Picardy) in 1457. Pedro Navarro also used this weapon against the French, by placing 30 carts of multibarrel guns in front of his foot soldiers.

Yet, the development of powder-propelled missiles was not exclusively a Christian project. An infidel is known as the first great gunner of history. Mohammed II (1451-81) in his conquest of Constantinople (1453) recognized the advantages of a new weapon. Fabulous accounts state the largest of his cannon threw 1,200-pound stones having a diameter of 30 inches. This weapon was called a bombard and needed between 50 and 70 oxen to transport it while 400 men were required to attend it. The rate of fire was seven rounds a day, two hours being required for reloading. Some authorities credit as many as 13 of these monstrosities to Mohammed II's artillery, which included 14 batteries and 50-odd cannon of assorted sizes and shapes. But, whatever the statistics, it is claimed that this was the first use of cannon as the principal weapon in an engagement between major armies.

On good authority, Louis XII (1498-1515) is said to have employed a gun having 50 barrels, so arranged that all of them could be fired in one volley.

As a whole, early multifiring weapons could be termed only a moderate success. They were extremely heavy and clumsy to handle. While all the barrels could either be fired at once or in rapid succession, the advantage of momentary volume of fire thus attained was soon canceled out by the long periods of inaction caused by the need to muzzle-load each individual barrel. This inability to deliver sustained fire restricted its use to supporting or auxiliary employment. But at a critical point in battle, one could be maneuvered into a position where a concen-

trated blast would have a serious effect. In order that all barrels be fired simultaneously, or as nearly so as possible, the train of ignition from one barrel to another was shortened. This was about the only refinement attempted on these weapons.

The most notable accomplishment along this line was done by the great Leonardo da Vinci (1452-1519), who designed a fan-shaped affair that more than cut in half the distance between touch holes. Study of other multibarrel weapons contemplated by da Vinci, shows he had in mind a way to drop the breech on the weapon for rear-end loading with some crude sort of fixed ammunition. No doubt the problem of ignition was his main stumbling block.

### Improvements in Ignition

From an historical point of view the development of powder has closely followed the improvements of ignition. The first practical system of ignition was a manually applied slow-match, or fuse. A touch hole was first primed with a finely granulated powder and, when ready, the gunner made contact with the primer by using a live ember or the burning end of an impregnated piece of twisted jute.

The period from the thirteenth to the early sixteenth century may be called the slow-match era. Some improvements were made to this haphazard form of ignition, such as putting the slow match in a crooked arm that could be made to dip into the priming pan when the trigger was actuated. The touch hole also was moved from the top to the side of the barrel, to take it out of the line of sight. None of the so-called refine-

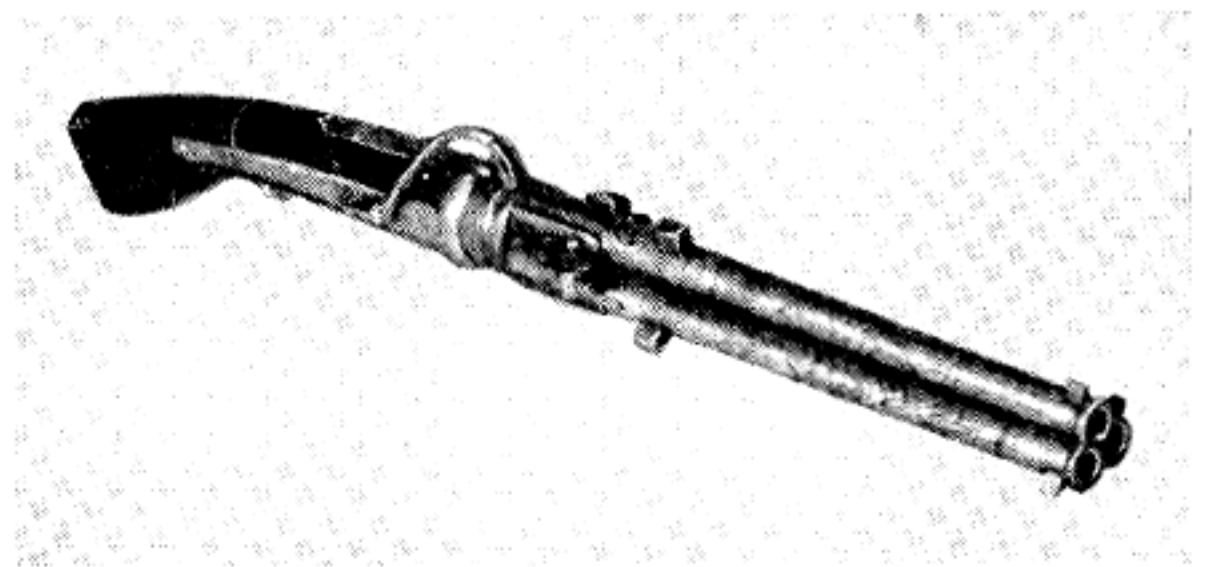

Three-Barrel Match Lock. Barrels are Revolved by Hand.

ments, however, altered the fact that actual fire had to be constantly present to discharge the weapon.

From the sixteenth century to 1807 there was an era of mechanical methods for producing fire by friction. In most instances, ignition was brought about by sharp contact of flint on steel, causing a shower of sparks to fall into a pan in which was nested the primer.

Odd as it may seem, the most perfect and elaborate of these systems came first. It was made in the form of a spring-loaded wheel with a knurled edge that rested against a portion of flint or pyrite. Upon releasing the wheel held under tension, the knurled edge rotated rapidly against the flint, and a shower of sparks was directed into the powder train. This mode of ignition is known as the wheel-lock system.

While this method was very reliable, only the very wealthy could afford such a contrivance; and necessity again proved to be the mother of invention. Thieves, working under cover of darkness, realized their presence would be made known by the glowing slow-match. Since they could not afford the costly wheel-lock, they improvised a cheaper substitute arrangement.

A chunk of flint was held in a jaw. Upon being pulled to the rear, a horizontally placed U-shaped spring was compressed and held under tension by a notch engaging a searing device. It was released by a rearward pull on the trigger. This allowed the flint to snap smartly forward striking an inclined and pivoted piece of roughened steel. This sudden blow resulted in sparks being directed into the priming pan that was located beneath.

This system of ignition was for 200 years known as the "Snap-hance." Translated from the original Dutch, this means "chicken thieves." It should be self explanatory what profession was followed by the inventors of this most reliable and practical method of ignition.

The flintlock proved reliable enough to be used at one time or another by every nation on earth. Nor was its application confined to single shot weapons, although the very nature of the mechanism had a tendency to restrict this particular use.

## Beginnings of Revolving and Volley-Fire Guns

During the slow match and flintlock era, there were many peculiar designs in weapons, including many proposed multifiring devices, all in an attempt to solve the three major problems that confronted the inventor planning a gun. They were: First, an adequate chamber and tube to house the powder charge and direct the missile; second, some method of igniting the propellant at the instant the gunner brought the piece to bear on the target; and third, provision of ways and means of firing successive shots with a minimum of effort and a maximum of speed.

There was also a serious effort to apply the multifire idea to shoulder arms. The bulk, weight, and various accessories necessary for the individual soldier to support and fire the piece, made its practical use as a weapon out of the question. However fanciful pictures of the time often depict wishful thinking rather than an efficient firing device.

During the sixteenth century there appeared for the first time an attempt to take the multi-barrels out of the flat method of mounting by placing them in a circle. In doing this, the idea of the revolving type of firearm came into being.

For a hundred years or more there was little or no actual development in volley-fire weapons, other than a few isolated cases, such as the 1626 patent granted in Scotland to William Drummond by Charles I. This patent was to apply in Scotland only, and was to be void if one or more guns were not produced within 3 years. It is described by the inventor as "being a machine in which a number of musket barrels are fastened together in such a manner as to allow one man to take the place of a hundred musketeers in battle."

The arrangement consisted of 50 barrels put together organ-gun fashion for the purpose of sustained fire. The method of firing volley after volley from the same muzzle-loading barrel was novel, but by no means practical. Each barrel was loaded with one charge upon the other, the powder of each charge being aligned with a touch hole all the way up the barrel. Drummond's idea was to discharge each barrel by mov-

ing adjustable fuse holding devices until they lined up with the touch holes. This was supposed to fire alternately each charge somewhat on the order of the Roman candle principle.

Drummond's description further leads one to believe that the barrels were mounted in a circular manner and could be rotated by hand. Thus, when the outside barrels, or tubes, were discharged, they could easily be removed for loading. If any attempt was made to use this manual system, it no doubt resulted in more casualties to the king's gunners than to the enemy.

These very early experiments reveal that fire power was the paramount theme in each and every weapon offered for governmental consideration. The ruling heads also thought in this fashion and encouraged the design and construction of practically anything that might produce results.

Theories for such instruments of war were devised by men of letters as far back as 1663. *Transactions of the Royal Society 1663-64* contained a paper by a man named Palmer. In it he explored the possibilities, not only of using the forces of recoil, but also of trapping the gases along the barrel and using this heretofore wasted energy to reload the weapon. He described it as "the piece to shoot as fast as it could be and yet to be stopped at pleasure, and wherein the motion of the fire and bullet within was made to charge the piece with powder and bullet, to prime it, and to pull back the cock."

Needless to say Palmer was a couple of centuries ahead of his time. But it is one thing to theorize, and quite another to construct. There is no record of Palmer making any attempt to produce a working model utilizing either gas or recoil forces. It is very possible that the idea was greeted by so much skepticism that he never dared mention it again.

Most of the records of this particular era are more or less vague references to certain developments that cannot be fully authenticated. Such is the story of "the repeating gun of 1688," the records of which were uncovered by a French researcher, Abbé J. Rouquette. In the archives of the province of Languedoc at Montpellier he found a curious and interesting document. This

stated that on 21 August 1688, a man who called himself Abraham Soyer was picked up on some minor charge, and brought before Abbé du Chayla, archpriest and inspector of the mission of the Cevennes.

In the prisoner's luggage was found a small weapon that he was carrying to St. Etienne to turn over to the gunsmiths there as a working model. Evidently this was Soyer's idea of the way to get the gun into production. If the additional information given is correct, the weapon was indeed a clever firing device for that day. It is alleged to have had a breech that allowed it to be loaded through the butt end of the stock (using, perhaps, some crude cartridge to accomplish this). A clear description was not given in the records. The reason can well be imagined when the nature of the device and the troubled times are taken into consideration.

In London, England, on 15 May 1718, there was issued patent number 418 to James Puckle on a revolver type of firearm that has proved one of the most controversial in all weapon history.

This odd-looking weapon, which according to the inventor was "a portable gun or machine that discharges so often and so many bullets, and be so quickly loaded as renders it next to impossible to carry any ship by boarding," has perhaps caused more discussion than any other weapon of its kind. The drawings are unusually clear, considering the time; and many new and clever features are shown, especially in mounting. However, Puckle's specification that round bullets be used on Christians, and square ones on Turks makes one wonder if it were really a serious attempt to produce a repeating weapon. Puckle seems to have been more interested in using the King's patent office as an expedient to advertise his patriotism and church affiliations.

An authority on multifiring weapons in the nineteenth century had the following comment on Puckle's invention:

"As the science of gunnery progressed, the gun maker sought not only to increase the range of the arm but also the rapidity of fire, and it would appear that a large number of the early inventors first thought of the revolver principle as the means which would best lend itself most readily to this end. Nothing would seem simpler than to make the rear of the arm in such a man-

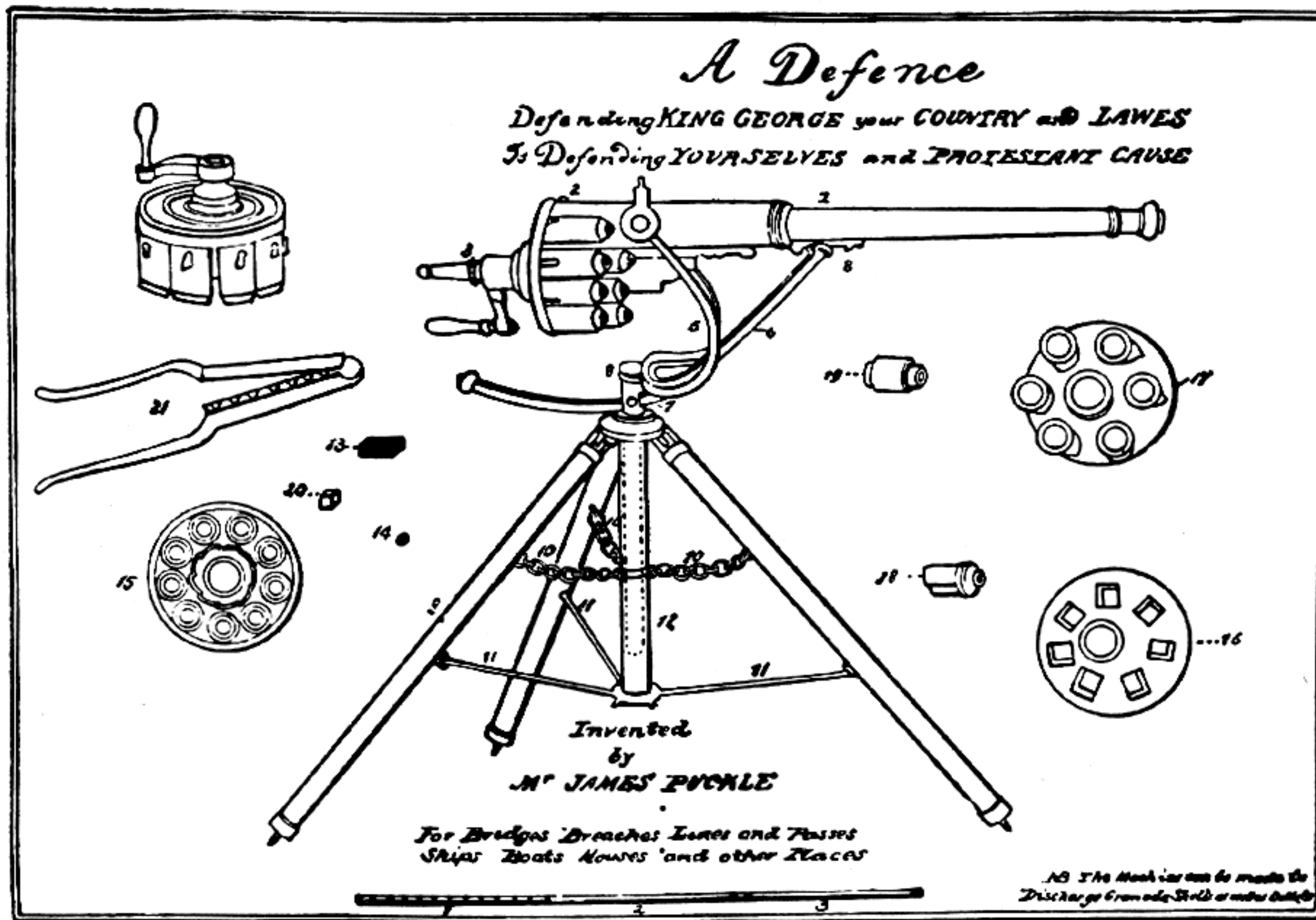

Whereas our Sovereign Lord King George by his Letters patents bearing date the Twelfth day of May in the Fourth Year of his Majesty's Reign was graciously pleased to Give & Grant unto me James Puckle of London Gent my Exors Admors & Assignes the sole privilege & Authority to Make Exercise Work & use a Portable Gun or Machine (by me lately Invented called a Defence) in that part of his Majesty's Kingdom of Great Britain called England his Dominion of Wales, Town of Berwick upon Tweed and his Majesty's Kingdom of Ireland in such manner & with such Materials as should be ascertained to be the sd New Invention by writing under my Hand & Seal and Enrolled in the High court of Chancery within Three Calendar Months from the date of the sd patent as in & by his Maj<sup>ty</sup> Letters Patents Relation bearing thereunto had Doth & may amongst other things more fully & at large appear NOW I the said James Puckle Do hereby Declare that the Materials wherof the sd Machine is Made are Steel Iron & Brass and that the Tripied whercon it stands is Wood & Iron And that in the above print (to which I hereby Refer) the said Gun or Machine by me Invented is delineated & Described July the 25<sup>th</sup> 1718. /

*James Puckle*

ner that a loaded cylinder carrying several charges could be inserted, and these charges brought successively in line with the barrel and fired. The revolver was, in fact, among the first systems thought of by a considerable number of inventors. But it would appear that very little was actually accomplished, the inventors, for the most part, contenting themselves with making a single example of their arm, and these were looked upon more as curiosities than as useful weapons. The inventor at that time, not having the percussion cap, was obliged to employ a somewhat cumbersome means of igniting his charge, and this was the probable reason why revolvers were so long in coming to the front.

"It will be observed that the inventor proposes to use round bullets against Christians, presumably Catholics, and square ones against Turks. Had his Majesty King George been at war with any heathen nation at the time, it may be presumed that he would have recommended a bullet to be used against them still more angular than that recommended for Turks, while he might have recommended the employment of soft bullets made of cork or wood against his own erring co-religionists, the Protestants. However, the illustrations forming part of the patents are certainly interesting in their way. It will be seen that the arm is mounted upon a tripod which very closely resembles the tripods employed with guns of today, that a too great spreading of the legs is prevented by a chain, that stiff rods are used for holding the legs in position, and that for holding the guns at any degree of elevation a device is employed almost identical with that used on some recent forms of machine guns. This arm, I think, may be considered as the first mitrailleuse ever patented in England."

This authority ignored the earlier Scottish patent issued to William Drummond by Charles I.

Whether Puckle's "Defense" represents the first patented manually operated revolving-type machine gun, or not, is immaterial. Its importance lies in the fact that it certainly represents the most refined design to be found in the whole slow-match era. It also shows that the mechanisms involved in getting a weapon to fire repeatedly had far outstripped the method of igniting successively the charges as they came into alinement.

A prominent American gun inventor, during an early visit to London, was shown in the tower of London an actual weapon that had nearly all the basic principles of the modern revolver, with the exception of the ignition system. This consisted of a split hammer clasp ing a slow-match which moved forward under trigger pressure to touch the primer. Each chamber was provided with a priming pan covered by a swinging lid. Before firing, the protecting lid was pushed aside by the finger, exposing the powder to the lighted end of the slow-match.

He was also shown another revolver weapon of a more recent date that was a considerable improvement over the preceding one. It had six chambers and a rotating breech, and was provided with flint lock and one priming pan, arranged to fire the chambers one at a time, or all together. The pan was fitted with a sliding cover. A vertical wheel with a serrated edge projected into it, not quite touching the powder in the pan. To this wheel a rapid whirling motion was given by action of a trigger spring on a lever attached to the axis of the wheel, which caused the teeth on the wheel to strike against the pyrite. A cam brought the action down until a shower of sparks was certain to reach the primer. If the gunner cared to fire it single shot, the breech was rotated by hand until it alined with each individual barrel. To fire all barrels in one volley, all pans were connected by a tubelike affair which, when fired, would simultaneously discharge all the barrels.

This type of revolver flintlock gun was made in various designs, both in England and France. The French went so far as to build a similar weapon that employed eight barrels revolving around a common axis. Each barrel was fired as it revolved into alinement with a fixed flintlock firing system.



Seven-Barrel Revolving Flintlock Rifle.

At about the same time a Bostonian named Elisha H. Collier, after first trying to interest various people in this country in his revolving flintlock firing system, went to England with the design. His gun was very popular and was used by the English army in India. It was considered the finest weapon of its kind and did not suffer in comparison with any known foreign gun.

After his success in England and France, Collier closed his gun shop in London and returned to the United States. He set up a similar gun business in Boston for the purpose of making his revolving flintlock guns. These had such improved features as a self-priming pan and gas-tight joints between cylinder and barrel, formed by camming forward the cylinder counter-bored at the forward end to mate with the breech end of the barrel. A novel way of rotating the cylinder was used; upon releasing the trigger after firing, it was indexed by tension of a spring that had previously been hand wound.

There was little or no actual development in the flintlock period of ignition other than refinement of existing weapons and the substitution of the flint and steel spark-throwing arrangements in lieu of the slow match. True, there was a tendency to reduce the excessive weight of shoulder arms that the earliest weapon designers had simply ignored. Also a better knowledge of, and experience in, working steel produced a more serviceable but streamlined gun.

The art of gunsmithing was considered, during this era, one of the highest skilled trades. This view is justified by comparing the finely designed, reliable weapons of that day with the clumsy freaks of earlier times, and the slipshod gadgets which followed them.

For at least a hundred years, every military power used the flintlock system. This did more to standardize weapons than any other thing. The very nature of this system did not easily lend itself to multifiring, other than to serve as the source of the initial ignition. If other barrels were to be discharged, either one at a time or simultaneously, a chain of priming had to be ignited from the first flash; or the cumbersome mechanism had to be rotated around the primed pans.

Although the reliable flintlock system had

long outlived its usefulness and had become a definite bottleneck to future progress in gun design, only a few people realized this. Opinion at the time was agreed that no improvement was needed, it being a foregone conclusion that nothing could serve more adequately the purpose than the flint- and steel-ignited weapons men's fathers had used.

### Application of the Detonating Principle to Firing

It is very understandable that when Berthollet discovered in 1786 that chlorate could be exploded by a sudden blow with a metallic hammer, the public was not even mildly interested in the fact. Likewise when Howard in 1799 found that mercury fulminate could be rolled into pellets and ignited by percussion, the event was barely recorded for posterity. Regardless of the attitude of scientists and gunsmiths of the day, the latter discovery was the greatest single achievement to be made in the long and interesting history of firearms development. For the discovery of detonating powder introduced the percussion system of ignition and, while it has gone through many radical improvements, it is still with us today.

Whether Berthollet's work may have led Howard to seek something more stable in detonating mixtures is not known. It is universally accepted, however, that this discovery might have lain dormant for years had not an enterprising Scottish minister of Presbyterian faith, the Rev. John Alexander Forsyth (1768-1843), immediately recognized the great advance made in this field. He patented on 11 April 1807, the "Application of the detonating principle to exploding gunpowder firearms."

There are reasons to believe that in both France and Germany the idea of substituting a detonating mixture in place of flint and steel was being worked out simultaneously and independently. Pauly, the famous Parisian gunsmith, was making paper percussion caps as early as 1812. These were made by scaling a small portion of mercury fulminate between two thin layers of paper, producing a cap.

Reverend Forsyth designed and built several guns employing what he called "pill locks." He



placed on the side of the barrel a nipple that led to the powder charge. The upper end of the nipple had a slightly enlarged opening in which was placed a small pellet, or "pill," of the fulminate of mercury mixture. He later improved on this by making a mechanical device to place the pill on the nipple by actuating the hammer. The ease and certainty of fire of this system first became popular with the civilian population and its earliest use is to be found in sporting guns.

Napoleon was the first to become interested in this departure from the time-honored flintlock system, and offered Forsyth £20,000 for his invention. Forsyth, evidently being a very patriotic man, refused the offer and gave the rights to his government. To the memory of this Aberdeenshire minister, a plaque has been erected in the Tower of London. This was a joint gift from arms guilds, whole British regiments, and a host of Scotch and English sportsmen, and is the only memorial in honor of an individual ever erected within the precincts of the 800-year-old Tower, often called the "heart of the British Empire."

An improvement in Forsyth's invention followed immediately. An American sea captain, Joshua E. Shaw, of Philadelphia, evidently in one of his ports of call, had been brought into contact with the fulminate of mercury ignition system. He immediately set about to correct the worse features of the loose pill placed on the nipple of the gun; and conceived the idea of housing the mixture in a pewter cap that could be placed over the nipple. This not only protected the primer from weather conditions, but also rendered it practically impossible to lose as the cap was designed to grip firmly the sides of the nipple.

Shaw, however, did not reckon with American patent laws that refused him a patent (in 1814) on the grounds that his many travels had kept him away from home for more than 2 years. One had to be a bona fide resident for at least 2 years before a patent could be granted.

In the long run this delay proved advantageous. During the period of establishing residence, Shaw found that pewter, the material he originally planned using for his fulminate cap, crushed too easily. Also the crown of the cap

had a tendency to melt when subjected to the intense heat generated by the rapid burning of the powder. A portion of molten pewter would plug the priming hole, and thus render the weapon useless until the obstruction had been removed. When his patent was finally approved, in 1816, he had changed the material from pewter to copper.

It may be said that the combined intellect of three men from the most contrasting professions imaginable (an apothecary, a minister, and a sea captain) prepared the way for the wholesale experiments in the development of weapons. Many of the principles involved in these new designs had been but useless theories to former inventors and armorers.

In 1817 the government had 100 Hall rifles modified to take the percussion cap. Later Congress granted Shaw a \$20,000 bonus for his invention.

The Hall rifle was the first breech-loading arm used by American military forces. Its inventor, Capt. John H. Hall, United States Army, also originated gage application to dimension with tolerances that resulted in our modern conception of interchangeability.

### Pioneer American Gunsmiths

Eli Whitney, inventor of the cotton gin, had already given the armed services a very simple lesson in mass production. He delivered to the army many kegs full of triggers, hammers, barrels, ramrods, stocks, etc. Upon arrival before a group of astonished officials, he used a dozen common mechanics to assemble the component parts. Then he took the finished pieces to the range and personally proofed each weapon. He showed, once and for all, if each part was made to specification, assembly could be done with mediocre skill, thereby doing away with the old theory that a gunsmith had to produce each weapon in its entirety.

By making each component fit a master template, every part was capable of being interchanged with a similar piece. This principle was instantly added to the many other mechanical tricks in the art of gunsmithing, of which the New England States were beginning to be the center.

Any individual who felt he had a high degree of skill in mechanics generally wound up in the production of firearms. Regardless of the cleverness of his ideas on methods for sowing rice, ginning cotton, or planting corn, he eventually was forced to center on gun production as a means of livelihood. It was the one and only mechanical trade where, should a product be first quality, the sale was certain and profitable.

For once, a restless civilian population was creating a demand for weapons far greater than any war had ever done. The pioneer settler could plant his grain in the manner of his forefathers; he could gin his cotton by hand; and the luxury of a buggy was unthinkable. But he demanded, and would pay for in cash to his last cent, the best that could be created in weapons. His specifications were simple: the arm must be reliable, accurate, rugged, simple in design, as light as practical, and with all the firepower the ingenuity of the inventor could build into it.

Every inventor knew that, on building honestly a superior weapon, his name would be praised, his fortune made, and nothing on earth could change this situation except a competitor producing a better gun. Then he knew his public, governed by self preservation, would leave him over night, since a second best gun was considered worse than no gun at all.

The three-quarters of a century following the percussion cap patent saw more accomplished in development, design, and performance of weapons than in all previous history.

True, repeating cannon had been used to good effect by our Navy in the War of 1812. A few of these weapons are now to be found in various museums. Their ignition was of the fire-to-primer type, but they used the revolving chamber system in reverse. The axis of the cylinder was horizontal to the gun, and perpendicular to the center line of the bore. This allowed the cannoneers to load the rear of the cylinder while the forward side was in position for firing.

It was not until 1829 that such a weapon was patented. To Samuel L. Farries of Middletown, Ohio, goes the honor of receiving the first "machine gun" patent issued by the United States Patent Office. This grant seems to imply that the name "machine gun" was to be assigned to any mechanically operated weapon of rifle caliber

and above—regardless of whether the energy necessary for sustained fire is derived manually or from some other power source.

Because of the slowness of muzzle loading, there was no incentive to use improved methods of ignition. Even up to the Civil War, it was standard practice to set off artillery by flaming brand, linstock, slow match, red hot iron, or other fire-to-powder methods.

It is particularly interesting that the third machine gun patent issued in the United States was for a type that has been patented with regularity for over a hundred years. Innumerable hours of labor and millions of dollars have gone into its development. Unsuccessful tests have been run on this kind of weapon by the government from 1838 to the beginning of World War II. It is to the machine gun field what perpetual motion is to the mechanical world: an idea that has been approached so close, but still remains so far—the centrifugal machine gun.

The military class, as a whole, both here and abroad, was very slow to accept the percussion system, even in small arms. It remained for a civilian, Samuel Colt, to give the multifiring idea the impetus needed to start an unparalleled wave of gun design and development in the United States. In 1830, at the age of 16, on the brig "Corlo" bound for India, Colt conceived an idea for a revolving type of firearm. In watching the steering wheel of the ship, he noted that no matter which way the wheel was turned, each spoke passed directly in line with a fixed clutch and could be held fast at any chosen spoke, if desired. From this he visualized his future revolver.

Although the idea of a revolving firearm had been attempted centuries before, the importance of Colt's invention is that it was the first practical revolving weapon employing the percussion cap in conjunction with the automatic revolution and locking of the cylinder by the act of cocking the hammer.

On 5 March 1836, Colt founded the Patent Fire Arms Co., of Paterson, New Jersey, with a capitalization of \$230,000. The company established the first Colt factory in an abandoned silk mill. After producing several models, the venture at Paterson came to an end. Colt, seeking better manufacturing facilities, contracted with

Eli Whitney (son of the cotton gin inventor), who was one of the largest producers of firearms in the United States, to manufacture some revolvers of improved design at Whitneyville, Conn.

As a result of this brief association, mass production combined with the assembly line was introduced into American weapon manufacture. Whitney, Sr., had contributed the first; and Colt, the latter. The innovations in production methods were copied by other gun producers throughout New England. This gave to a limited eastern seaboard area a manufacturing supremacy in firearms production that was unchallenged by the rest of the world for more than a century. Though the business association of Colt and Whitney was of short duration, the ideas of manufacturing interchangeable parts, and of combining the components by the assembly line method have remained the principal cornerstone of American manufacturing supremacy.

Colt, in 1848, established his own plant at Hartford, Conn. Some of the finest rapid-firing weapons known from that day to this were produced in this factory.

The popularity of Colt's early multifiring re-

volvers assured recognition of the application of the percussion cap in relation to other kinds of weapons for military use.

The conventional gunpowder weapons, operating by various means, had reached such a state of development in the United States by 1855, that John A. Reynolds of Elmira, N. Y., patented a device for the cooling of gun barrels. The wording of the patent claim admits the idea of a water jacket, even then, was not original.

"This improvement is peculiarly adapted to and applicable to the manifold firearm of which I am the inventor, rendering that improvement more valuable and efficient by this simple means of cooling the barrels or tubes, necessarily heated by the rapid and repeated discharges through them from the revolving chambers . . .

"I am aware that the application of a jacket to the breech of a gun, in which the gun itself forms a part of the jacket, is not new. . . . The application of a refrigerator construction as described, to the barrels or tubes of firearms for the purpose of keeping said barrels or tubes from undue heating is substantially in the manner set forth in the foregoing specification."

# BACKGROUND OF MACHINE GUN DEVELOPMENT

## First Models of Percussion Multifiring Weapons

The first serious effort abroad to adapt percussion ignition to a multi-firing weapon of war was done by a former officer of the Belgian Army. He completed a model in 1857, which was composed of 50 barrels of rifle caliber, assembled parallel to each other in a prismic group. It had the appearance and weight of a cannon. Records show this unusual weapon's rate of fire to have been a hundred shots a minute; its range, 2,000 meters (1¼ miles), was unusually long for that period.

At the same time, Sir James S. Lillie attempted to build a similar weapon in London. It is now in the Woolwich Museum labeled as a "freak" device. Lillie attempted to combine the revolving chamber with the multibarrel system. Twelve barrels were arranged in two rows, fastened several inches apart. To the rear of the breech end was a revolving cylinder, chambered for 20 charges. Each chamber was fitted with a nipple and percussion cap which could be exploded when a charge was manually aligned with a barrel. The firing was carried out by turning a crank that manipulated a series of rods, serving as hammers, striking the percussion caps in turn. The problem of servicing and loading must have been appalling. It is understandable why this weapon was termed a freak even at a time when radical design was usually heralded as an improvement.

In 1854 Sir Henry Bessemer patented in England a self-acting breech-loading gun that used steam to perform the functions of feeding, locking, and firing of the piece. The weapon's recoil opened the valve after the projectile had safely cleared the bore. This is the first time any outside agent other than manual operation was employed in an attempt to produce sustained fire.

There is no record of the existence of even a

working model of this unusual weapon. Bessemer also patented what is known as the "Bessemer process" for making steel. This was so successful and so revolutionary to the steel business that Bessemer lost all interest in his earlier patents.

An earlier British steam gun, however, was witnessed by the Duke of Wellington. When asked by the proud inventor, a Mr. Perkins, what he thought of the idea of steam propulsion of missiles, the Iron Duke replied, "It would be a very good thing if gunpowder had not been invented."

Thomas F. Linden, also of London, filed a specification in May 1856 for a gas-operated piston beneath the barrel of a weapon. This piston actuated a device that was used to fire and raise a hinged chamber to receive a paper cartridge. The weapon, however, had to be cocked manually and to have a percussion cap placed on the nipple after each shot. The principle, nevertheless, was a clear application of mechanical breech opening.

The United States Patent Office on 8 July 1856 issued patent number 15,315 to C. E. Barnes of Lowell, Mass., for a crank-operated machine cannon. This weapon had many original improvements, and was the forerunner of a series of crank-operated weapons. The gun's locking system employed a toggle joint arrangement that rammed a fixed charge home. The stiff linen cartridge was fed from a tray located on the left side of the breech end of the gun. A very clever method was used to place a percussion cap on the nipple mechanically after the weapon was safely locked. The cap was fired by a continued forward movement of the crank action which tripped a sear. The hammer, similar to a piston, was confined in a cylinder. A part of the force of the explosion in the chamber came back through the nipple and imparted enough energy against the head of the hammer to compress the firing pin spring allowing a sear to engage this

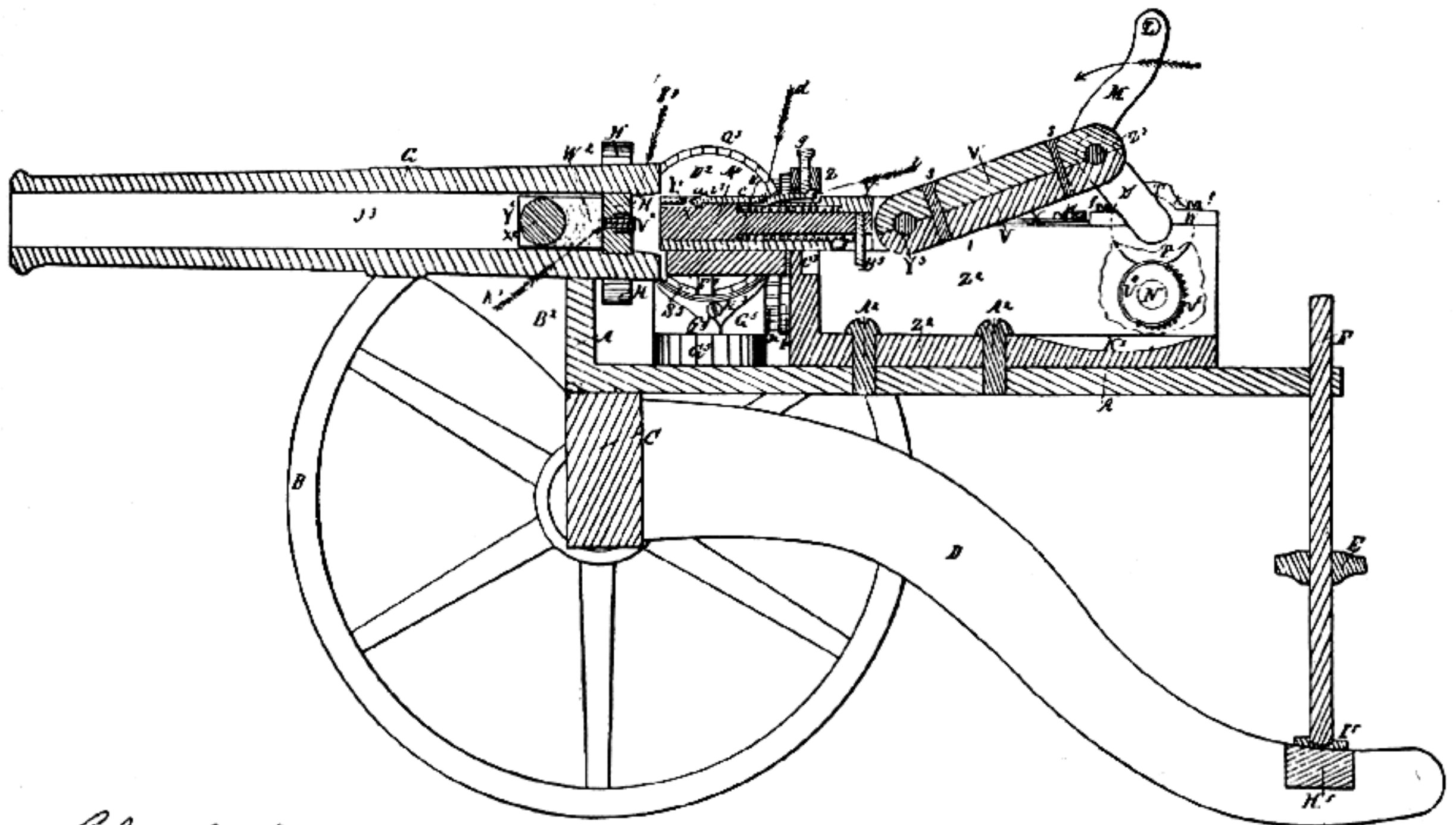

*Chas E Barnes*

Barnes Machine Gun. Patented 1856.

part. This was a novel employment of gas pressure from the chamber for the purpose of cocking the piece.

The rate of fire depended solely upon the speed with which the crank could be turned. This weapon was far ahead of its time, and its development would have placed a reliable machine gun in the armed forces several years prior to the Civil War.

The design of the flintlock system limited its application in weapon construction, but the percussion method of firing seemed to invite attention to its unlimited application. The ignition, now a small separate unit, could be used in many reliable ways, some of which were more ingenious than others.

### Development of Cartridges

As mechanical improvements continued, the idea of incorporating the detonating cap as an integral part of the fixed charge was inevitable. This 20-year period (1856-76) saw more varied and distinct types of breech-loading arms devel-

oped than any other equal period in the history of arms. Many of these required their own peculiar type of cartridge.

Christian Sharps' self-consuming cartridge made of linen was introduced in 1852. It was made at his Fairmount, Pennsylvania, gun factory. This was a definite improvement over the fragile paper-filled envelopes previously used. The linen could be held in shape and would stand more abuse than the paper cartridge. That cartridges, in one form or another, were beginning to be used throughout the service is verified by a record showing the purchase of 393,304 paper cartridges by the United States Army in 1851.

Col. Samuel Colt collaborated with the Ely brothers of England in making further improvements on his patented self-consuming cartridge. This cartridge was made of a stiffer and more durable paper, and could be held to close manufacturing tolerances. The paper cartridge case was impregnated with a mixture of potassium nitrate. The explosion of the powder charge completely consumed the cartridge case. The

percussion cap had sufficient force to rupture the paper and drive fire through to the powder charge.

Smith and Wesson of Springfield, Mass., in 1857 manufactured the first really successful rim-fire version of a metallic cartridge, self-contained and reasonably waterproof. This ammunition, with added improvements, to the present day is still produced by various American companies.

On 22 January 1856, the unusual method of housing both detonator and propelling charge in the base of a bullet was introduced and patented. The Winchester Arms Co. made a repeating weapon called the "Volcanic" using this odd principle. As the propelling ingredients were all contained in the bullet itself, there was naturally no problem of case ejection. This radical design was to compete with the impregnated self-consuming paper cartridge cases.

The volcanic bullet had a small charge of finely granulated powder, and a larger portion of fulminate of mercury mixture housed in a thin metal cup, all of which was protected from the elements by a thin cork insert. When the ball was fed into the arm, a spring-loaded firing pin was cammed forward and forced through the cork until it was brought to bear on the primer cup. A smart blow from the hammer ignited the detonating mixture, forcing the flame through the openings provided, and exploded the powder in the upper conical cavity of the bullet.

During the middle of the nineteenth century, the introduction of various methods of producing cartridge cases, the development of the conical bullet, and the idea of integrating the detonating cap in the cartridge were undoubtedly responsible for the rapid and radical designs of the innumerable weapons constructed to fire them.

Even skin cartridge cases were used successfully. They not only furnished a waterproof container, but also were easily made into the self-consuming case that seemed to be a military "must" of the day. To produce this cartridge case, pig's intestines were used. After cleaning and while still wet, they were stretched over forms of the required cartridge dimensions. When dried, the powder and bullet were put in place. The skin case was then treated with a

compound consisting of "eighteen parts by weight of nitrate of potassium, pure, and seventeen parts of sulphuric acid—pure, after which it was washed to free it from the soluble salts and excess of acids, and then dried by blotting . . . in order to render it perfectly waterproof, a light coat of shellac varnish was applied."

It is easy to see how multifiring weapon development went hand in hand with cartridge design. As each different type of cartridge was introduced, inventors followed closely with a mechanical firing system, designed to use the new idea. No matter how radical a departure any new cartridge may have been from the heretofore accepted methods, there was a gun with an equally original design to shoot it.

The greatest problem in ammunition development was finally solved by George W. Morse's invention in 1858—the first true attempt at a metallic cartridge with a center fire primer and an inside anvil. It marked the most important step in the whole history of cartridge design. All other methods, experiments, and alleged improvements were but attempts to do what Morse successfully accomplished.

But experimentation and development had gone too far to be stopped suddenly by the issuing of this patent. In fact, it was many years before the idea was universally used, and the gun people and cartridge makers continued on in an orgy of original development.

As soon as a patent was filed on an obvious improvement, it seemed to be a challenge to the rest of the profession to see in how many ways the original idea could be circumvented. To compete against the expensive, hard-to-manufacture brass cartridge case, a steel tube with a percussion nipple on the end was often used. This could be easily loaded by shoving a self-consuming paper cartridge into the forward end, and quickly securing a copper detonating cap on the nipple. With this progressive step, the inventor had at his disposal the nucleus of a practical, reliable weapon with increased firepower.

### Ripley Gun

Ezra Ripley of Troy, N. Y., took advantage of the paper cartridge to patent a machine gun. Sustained volley fire was obtained by a compact firing assembly that allowed the gunner to fire

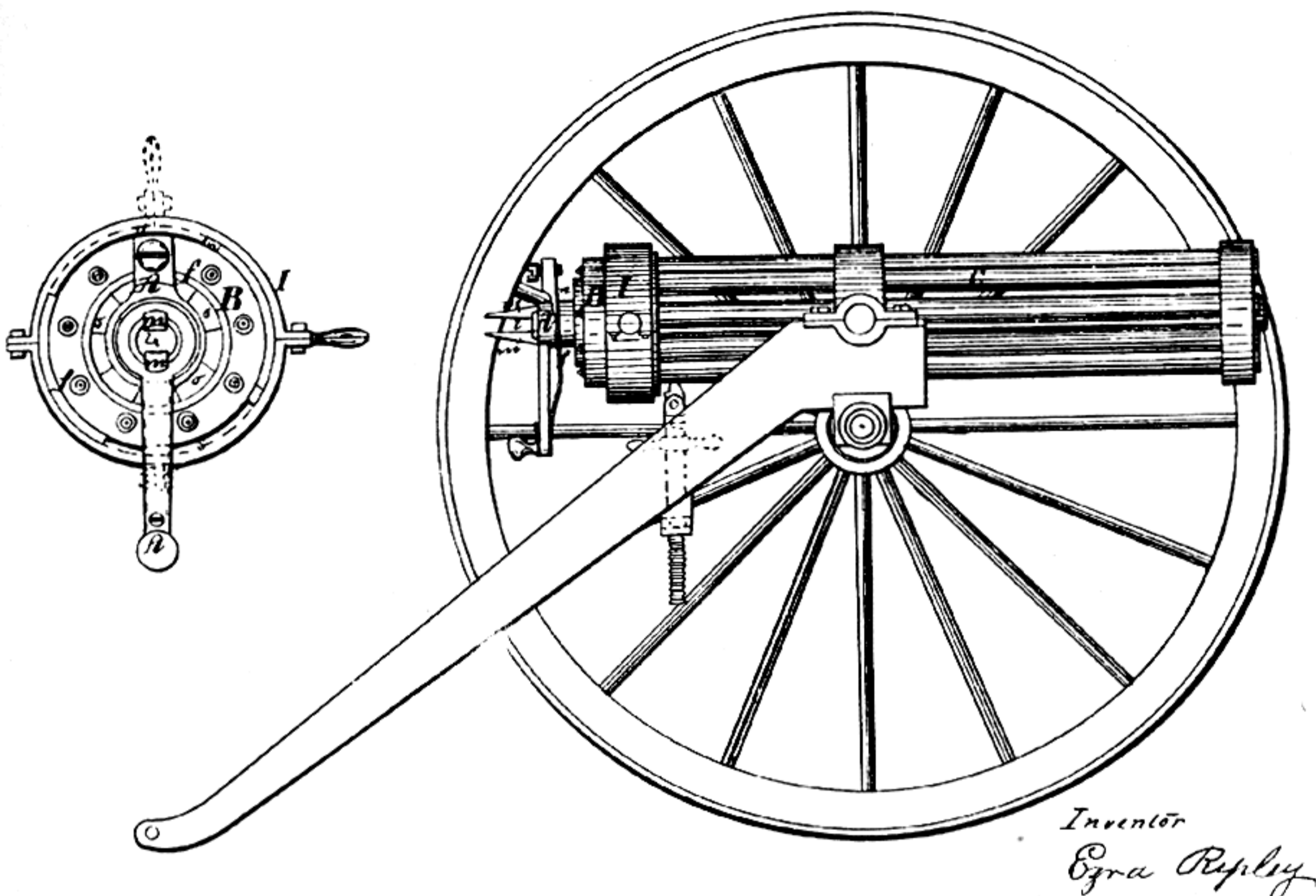

Ripley Machine Gun. Patented 1861.

one shot, or the whole volley, by a quick turn of the handle.

The weapon consists of a series of barrels, grouped around a common axis, that are open at both ends for breech loading. The barrels remain stationary during firing.

The breechblock made in the shape of a revolving cylinder is loaded with the conventional paper cartridge from the forward end of the chamber. On a nipple that protrudes from the center rear of the chamber is placed the percussion cap. The cylinder is then placed on the breech end of the weapon—the holes in the cylinder alining with the rear end of the barrels.

The breech is locked in place by securing the operating handle. This feature makes accidental firing of the weapon impossible before the breech is locked. With a clockwise turn of the handle, the firing pin is forced rearward by the action of a ratchet-type cam which compresses the firing pin spring. Upon alinement with the

nipple, it scars off the high point of the cam, allowing it to snap forward and fire the piece.

The weapon can be prepared for firing by releasing a spring-loaded catch that locks the handle in place. The gunner then pulls the firing assembly rearward and removes the empty chambered cylinder for inserting the paper cartridges. By reversing the procedure, the gun is ready for action. The firing arrangement gives the operator a choice of firing rates, from single shot to slow and rapid fire.

As a number of preloaded cylinders were made available, the individual soldier was able to produce more sustained fire than could a company of men using the standard muzzle loading musket. The Ripley weapon also showed for the first time a consideration for weight saving in field pieces that had been previously ignored. If the weapon is closely studied, it will show many basic features that greatly influenced machine gun design for years to come.

The Ripley gun was no exception to the rule that success depends as much on the personality of the inventor as it does on careful details of design. To introduce a complete innovation of ordnance to the conservative authorities of the day was, in itself, a feat requiring abilities superior to those necessary for actually inventing the weapon.

This gun was light enough in weight to be very mobile, with a desirable method of loading rapidly from the breech end, and it had a simple, foolproof way to control rates of fire. Why it was passed over in favor of the many crude types of organ guns can only be answered by presuming that Ripley let the matter drop after his idea was greeted with skepticism and objections to everything from overheating of barrels to problems of ammunition supply.

The weapon may never have fired a shot, and it is doubtful if a working model was ever made. Yet Ezra Ripley certainly did originate many new and basic principles, which he coupled with the most progressive ideas of others, and patented these features in a weapon that had very definite possibilities.

### Refinements in American Gunsmithing

The Colt revolver and similar weapons enjoyed the confidence of the public as it began to push westward and demanded the best in weapons that money could buy. All the New England gun makers were operating at peak capacity. The war with Mexico had come to a conclusion, Texas was being settled, and gold had been discovered at Sutter's Mill. Colt's name was a household byword, but fine weapons were also being produced by many others. Among them were the Wesson brothers, Oliver Winchester, Elihu Remington, Henry Deringer, James Cooper, Edmund Savage and Christian Sharps. Their factories began to attract the finest mechanical skill. They invited competition, feeling it presented a means of showing their ability, and prided themselves on being able to present a mechanical solution to any firearms problem brought to their attention.

The industry was built on strict competition to meet public demand. There was practically no

encouragement from the government by military orders for improved weapons.

After 36 years of civilian use had proved the reliability of the percussion cap, the army finally gave up the time-honored flintlock, but seemed content to advance no further. Many predicted that even this modern step was too extreme and the army would rue the day it had discarded the flintlock. General Winfield Scott is credited with outfitting a regiment of his own with flintlocks, after the adoption of the percussion system was approved over his strenuous objection.

Fortunately, civilian demand made up for the lack of military orders for the various firearms improvements. The market was practically equal to the adult population; for each male citizen, physically able to do so, usually owned and often carried some form of firearm.

During this period, the military ordered little more than the conventional small arms. For this reason guns like the Ripley were of little or no interest to firearm factories. The military would not consider such guns, and the civilians had no use for them.

Had there been an incentive, and a ready market, no doubt the head engineers of the big companies would have produced a reliable manually operated machine gun at this time. For in no other era have there been more gifted men in actual competition in gun production than during this period: Fordyce Beals and John Rider of Remington; Warner and Leavitt of Wesson Brothers; Tyler Henry of Winchester; Eben Starr; Christopher Spencer; John H. Hall; Simon North; Christian Sharps—to name all the outstanding gunsmiths would easily fill a directory. Any of these, no doubt, could have produced some mechanical means of sustained fire, as advanced as the many reliable hand and shoulder weapons they perfected.

There were many experiments, conducted by individuals, that resulted in reliable repeating shoulder weapons. The most successful variation was that of combining a shoulder stock with the cumbersome revolver. Thus six shots could be fired with great rapidity, and with remarkable accuracy. To increase the range, the revolvers were made with abnormally long barrels, and deeper recessed chambers. The increased powder charge caused the large caliber bullet to jump



the lands and resulted in an unstable trajectory and damage to the rifling of the barrel.

To overcome this, the Colt Co. resorted to "progressive" rifling, whereby the lands and grooves gained in twist as they progressed through the barrel.

This system of rifling became quite popular—especially with large bore weapons designed for high velocities. Progressive rifling, with lands and grooves machined to a parabolic curve, was the only way to overcome the error of having a soft lead bullet propelled by an abnormally large powder charge. The experiments, if of no other value, proved the need for a metal jacket bullet; as the various methods of rifling used were but an expensive mechanical attempt to obtain results that could be gotten with a properly balanced metal-covered projectile.

Of all the designs suggested along this line, perhaps the most unusual was that patented by A. Schneider. He proposed to give the lands a progressive clockwise twist half the length of the bore. At this point the rifling abruptly became counterclockwise. This latter twist would continue increasing to the muzzle end. Just how this sudden reverse torque on the bullet, when it was halfway through the bore, was expected to stabilize the projectile better in flight or increase range and muzzle velocity must ever remain a mystery. It is an example of the extremes resorted to by inventors, when a new idea became popular. The gain twist adequately served its purpose, and gradually disappeared when the problem of bullet design became more fully understood.

### Industrial By-Products of the Gun Trade

The United States was going through an industrial revolution. Lack of transportation and British repressive legislation had thwarted the national aptitude for inventions in the colonial period. Now, for the first time, Yankee ingenuity was beginning to make itself felt. In the isolation of the farms during the long winters, many clever devices were conceived. Since weapon development was a great problem of the day, it naturally received a large share of attention, and an amazing number of new methods of approach were devised to solve current difficulties. But re-

gardless of how obvious an improvement might be, it was worthless unless put into production. As the earliest gun producing plants were in Connecticut, and the Government's manufacturing arsenal was close by in Massachusetts, gun inventors trekked toward this area. If an idea were accepted by the public, its originator stayed on to practice his professional skill in production or in further improvements.

In order to protect himself from his enemy, man has been forced from prehistoric time to the present to produce more effective weapons. While his sole idea might be to create and produce a superior weapon, sometimes the means devised to accomplish this could be used even more successfully in the production of other things that had no relation to guns. For instance, the conception and perfection of machine tools first came into being in this area as an attempt to speed up and to economize on weapon production. The methods spread rapidly to other fields.

In the history of weapon progress, the advent of the machine age rivals the discovery of gunpowder. Power tools accomplished the impossible with the guns of the day, and opened means for the progressive inventor to write an unequalled chapter of development.

The influence of machine tools in modern life is little appreciated by the average person. The New York Museum of Science and Industry has on its wall a panel stating that the origin of machine tools has made possible all generated light, heat, and power; all modern transportation by rail, water, and air; all forms of electric communication; and has likewise caused to be produced all the machinery used in agriculture, textiles, printing, paper making, and all the instruments used in every science. "Everything we use at work, at home, at play, is either a child or a grandchild of a machine tool." But the Adam and Eve of the machine tool, and its application to mass production, were the early Connecticut and Massachusetts gunsmiths.

Good mechanics have been found in every nation, yet for some reason, most of the important machine tools used throughout the world originated in only two places: Great Britain and New England. The English craftsmen, traditionally lovers of the hand-finished product, bene-

fited little from this fact. They have furnished no serious competition in this field since the 1850's when undisputed leadership shifted to New England. This section of the United States became, practically, a manufacturing arsenal. Its mechanics were recognized as the world's best. In fact, some of their contributions to the power tool industry have affected the course of history more through industrial progress than their fine weapons did on the battlefield.

Among the little-known inventions of these men can be found the first milling machine with a power feed which was devised by the original Eli Whitney; it was the direct predecessor of what is known today as the power miller. Christopher M. Spencer, who was noted for his repeating rifles, patented a great improvement on the drop hammer, and perfected a cam control, or "brain wheel," whereby the operation of lathes was made automatic. This invention was one of the few for which the original drawing was so perfectly devised that it is still used today. Another gunsmith, Henry Stone, developed the turret principle for lathes. The high speed automatic lathe of today is a combination of the work of Spencer and Stone. The two men originated many improvements which extend from farm machinery to silk winding machines, but their first success was in weapon design.

Francis A. Pratt was one of the best designers of machine tools. After founding the Pratt & Whitney Co. for manufacturing guns, he found other products so profitable that, today, few people know of the influence of firearms on this outstanding manufacturing concern.

Asa Cook, a brother-in-law of Pratt, and a former Colt mechanic, was the inventor and manufacturer of machines to make screws and bolts automatically. Eli J. Manville, a former Pratt & Whitney engineer, established with his five sons at Waterbury, Conn., a plant which has been conspicuous in the design of presses, bolt headers, and thread rollers for the brass industry.

The arms plants proved training schools for inventors. Guns were made as long as profitable, but with changing times these versatile men began to make things entirely unrelated to firearms. Many became so successful in other manufacturing ventures that today it is often hard to associate a large telescope company or a success-

ful sewing machine plant with its original founder, a master craftsman, working patiently on the development of a new firearm. Yet the fact still remains that American domination of manufacturing "know how" came largely from the honest effort of gun producers just before the Civil War to compete with each other in providing the world's finest weapons.

It did not take long for American gun makers to carry the gospel of machine tool performance across the seven seas. As early as 1851, a Vermont firm showed at a London fair guns with interchangeable components manufactured by mass production methods. The British government was so impressed that it ordered the making of 20,000 Enfield rifles in American factories by this method. Three years later Great Britain ordered from the company that made these weapons 157 gun milling machines, which were the first automatic tools to be used in Europe. Among them was the eccentric lathe invented by Thomas Blanchard of the Springfield Armory. This device allowed wooden gun stocks to be machine carved with great rapidity in lieu of the laborious hand method formerly employed. The machine turned out irregular (eccentric) forms, from patterns, with automatic speed and precision; and has undergone practically no change in design since it was invented by Blanchard. Like innumerable other weapon-inspired tools, it contributed not only to American domination of the armament business but also helped to reshape the entire structure of the manufacturing world.

### Colt Revolving Rifle, Model 1855

The early civilian method of fastening a shoulder stock on the heavy barrel revolvers and making a serviceable repeating shoulder arm led the Colt Co. to apply the same idea to a full fledged rifle. Consequently the 1855 model revolving rifle was produced. It became the first repeating rifle adopted by the armed service of the United States. This caliber .58 weapon had a full length rifle barrel. The cylinder was long enough to hold the large powder charge and conical bullet. The Colt method of ramming the charge in the cylinder by a hinged lever was employed, a device which had proved popular on revolvers.

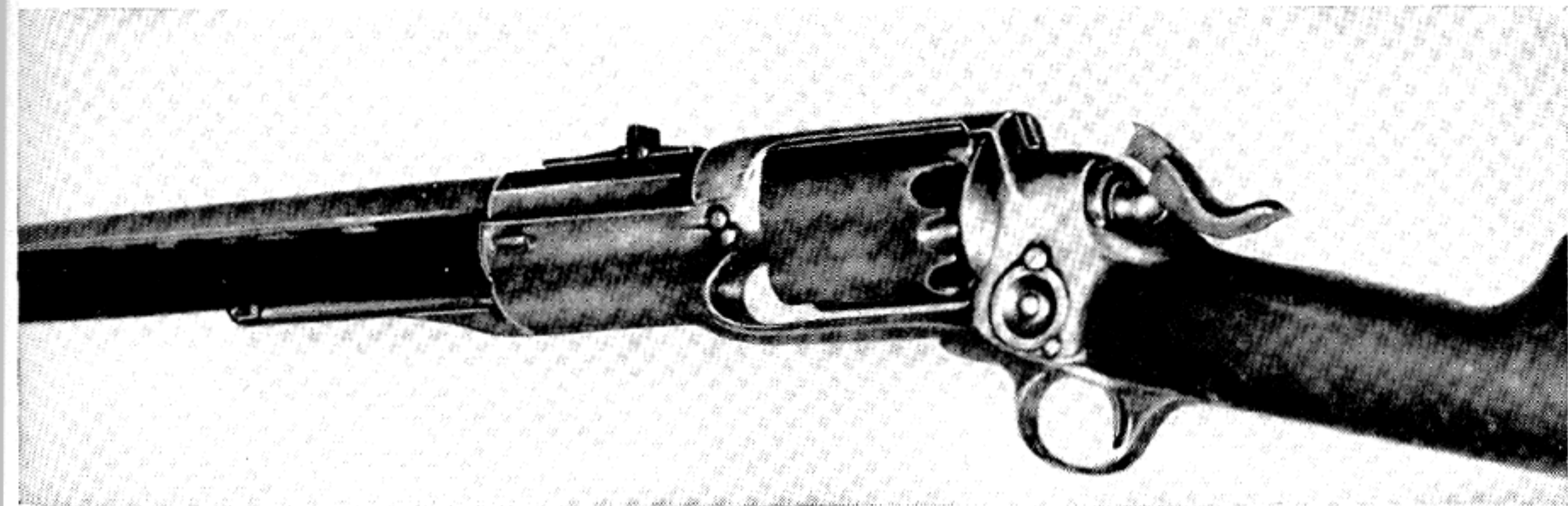

The Colt Revolving Rifle.

One of the features of the weapon failed to work properly under field conditions. The nipples that held the percussion cap were set in a recessed opening in an attempt to protect the cap and primer from weather conditions, which they did successfully. But in field use, as the soldier loaded the cylinders, he placed too much pressure on the loading lever. This force would rupture the paper cartridge where it bottomed at the aft end of the cylinder, causing loose powder to spill through the hole in the nipple. Since it was too dangerous to cover the nipple with a percussion cap while loading, the grains of powder would lodge in the recess connected to other nipples.

During firing the heavy rifle barrel had to be supported by hand. This had not been necessary in the revolver equipped with the shoulder stock. Sometimes loose powder from a faulty cap or gas leak would cause other chambers to be ignited. When this happened, the soldier using the piece lost his hand or the portion of his arm that happened to be in front of the exploding cylinder.

One such accident in a regiment destroyed not only confidence in the weapon, but the morale of soldiers and officers alike. Before the Civil War many a regular was on the pension roll for having lost his hand in line of duty—the duty being, in most cases, nothing more than target practice with the new repeating rifle.

These accidents had become so common that some company commanders ordered the men to lower the loading lever and to hold it in the left hand. This placed the hand out of range of the

gas leak where the cylinder chamber aligned with the bore of the barrel. Thus, should the chamber explode, the shooter was safe from the hail of lead and steel. Other officers protected their men in a different manner, having the soldiers load just one of the chambers. By this simple method of converting to a single shot weapon, they eliminated the hazard of blowing up the piece.

The total failure of the Army's first official attempt to introduce a repeating shoulder weapon into the service gave the conservative element a chance to point out the inevitable disaster that always follows any such departure from what has proved successful over the years.

Finally a board of officers met. After hearing all the evidence, they ordered that the Colt's use be discontinued and the pieces sold for whatever price could be obtained. The highest bid was 42 cents a rifle.

While the weapon's danger to personnel using it had undoubtedly been bad, the effect of its reputation on the trend toward repeating-action guns was almost fatal, so far as our military forces were concerned. For, after the discreditable showing of the Colt revolving rifle, no officer cared to stake his career on any such contrivance, especially since the Colt revolver, which the weapon so closely copied, had been such a huge success. They simply could not understand why a trivial change in design could result in such disaster. It was accepted as proving that one could not go beyond a hand gun in this type of weapon.

## PART II

# MANUALLY OPERATED MACHINE GUNS

## BILLINGHURST REQUA BATTERY

The effect of the failure of the Colt revolving rifle was to turn development of new weapons entirely over to civilians. The military authorities refused to be interested in anything beyond some means of producing volley fire, similar in arrangement to the early organ gun.

The civilian inventors realized they had a difficult sales problem. When they produced a reliable weapon, they arranged to have its performance witnessed and endorsed by public officials and retired officers of high rank. By this they hoped to prove that their weapon merited trial.

The professional standing of the distinguished endorsers was used as a warranty of the product.

The great lengths to which they all went in attempting to market their weapons resulted in many reliable records. These establish, beyond doubt, if one accepts the United States Patent Office definition, that "Machine Guns" were used in battle by both Union and Confederate forces during the Civil War.

Perhaps the weapon most in keeping with the acceptable idea of producing volley fire was the Requa battery. This caliber .58 gun was built

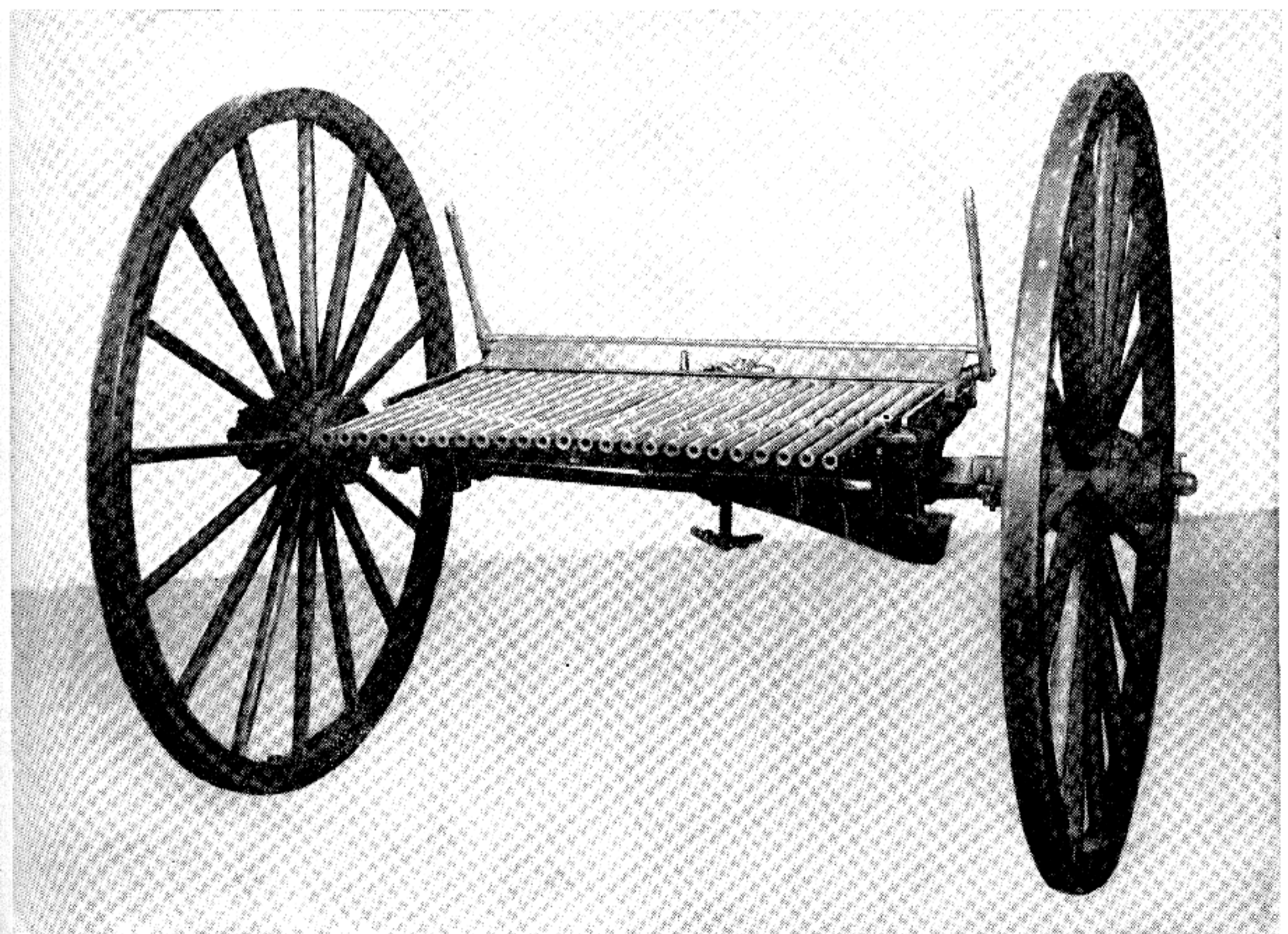

Billinghamurst Requa Battery Gun, Cal. .58, Model 1862.

late in 1861 by the Billingham Co. of Rochester, New York. It was publicly demonstrated in front of the Stock Exchange Building in New York City in the hope of interesting private capital in manufacturing it for army use.

This gun had 25 barrels, mounted flat on a light metal platform. The sliding breech mechanism was operated by a lever. Charging was accomplished by means of cartridges held in special clips. These cartridges were of light steel with an oval base that had an opening in the center for ignition. They were spaced in the 25-round clip so as to mate with the open rear end of the barrels.

After the breech was locked, each cartridge came to rest with its opening aligned to a channel filled with priming powder. All 25 barrels were fired simultaneously by a single nipple and percussion cap, which ignited the powder train, passing the rear hole of each cartridge. A single hammer, manually cocked and released by lanyard, served as the firing mechanism.

The Requa battery did not employ paper cartridges inserted in the steel cases. Instead, the cylinders were loaded by hand with loose powder, and a patched ball was used in the belief it gave the weapon greater accuracy.

This early weapon, though crude, had a few unusual features that warrant mention. The clip

loading, and the quick means of locking and unlocking, allowed a fair rate of fire.

This gun became known as the "covered bridge" gun. During the Civil War, practically every important crossing over a stream was in the form of a wooden bridge, with roof and side-walls to protect the floor and under-structures from the weather. As these covered bridges were usually long and narrow, one of these weapons in the hands of an alert crew could break up a quick charge by the enemy, either on horse or afoot. The 25 barrels could be adjusted to the necessary height and width. With a crew of 3 men, the weapon could be fired at the rate of 7 volleys, or 175 shots per minute. The effective range was 1,300 yards.

In the field, however, the Requa battery had its limitations. Dampness in the unprotected powder train would render it useless. Consequently, it was unfit for offensive service, but very effective in defense of restricted fields of fire.

There is a record of possession by the Confederate forces of a gun of this design on a fort at Charleston, South Carolina. As it was used for defensive purposes only, and there was no problem of mobility, it was heavier than the piece type of the North. The Confederate weapon weighed 1,382 pounds and was of considerably larger caliber than the Northern version.

## AGER "COFFEE MILL" GUN

The next machine gun to be used by the Union forces was the Ager, better known as the "coffee mill" gun. The nickname was derived from its being crank operated with a hopper feed located on top so that it closely resembled the contemporary kitchen coffee grinder. This gun was the invention of Wilson Ager, an Amer-

ican citizen, who for some unknown reason patented his weapon only in Great Britain, although he did patent in this country many industrial devices, such as rice cleaners and corn planters.

The coffee mill gun is a hand-cranked, revolver-type weapon that can use either loose

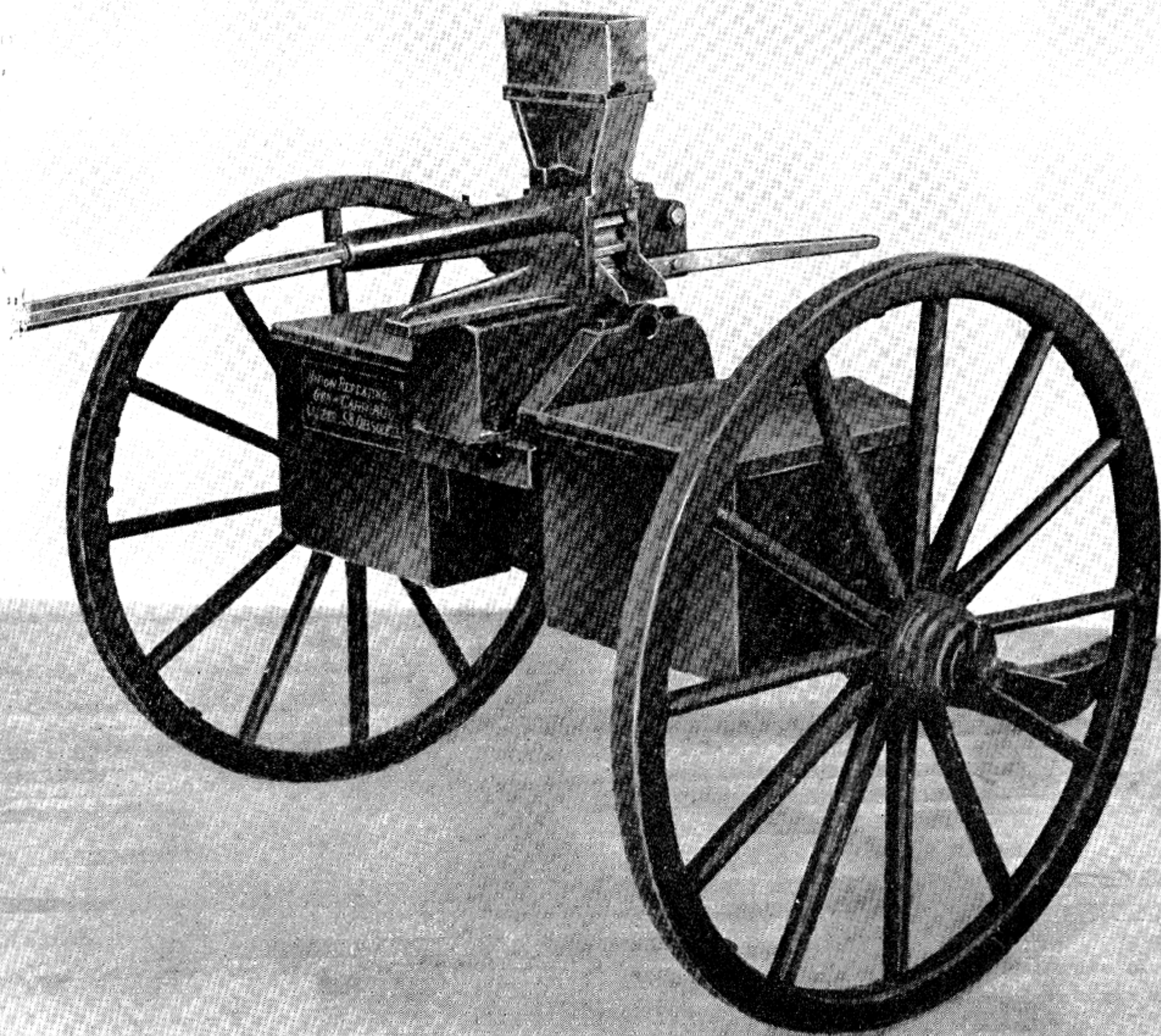

Ager Machine Gun, Serial No. 2.

powder and caliber .58 ball projectile, or an impregnated paper cartridge. The ammunition is loaded into steel containers which do the double duty of being cartridges and explosion chambers. The cartridge does not enter the barrel, but is held in alinement and cammed forward by a wedge lock, the chamber being rotated and held fast behind a stationary barrel, somewhat like a revolver.

To prepare the gun for firing, a number of containers are loaded, either with powder and ball, or a paper cartridge. A percussion cap is placed on a nipple that is screwed into the rear end of the steel container.

These loaded containers are then placed in a rectangular box, or hopper, so mounted on top of the weapon as to allow the containers to roll down, by gravity, one at a time, into a recess formed in the rear of the gun barrel. A crank, turning a system of cogged wheels, allows the charged chamber to be shoved forward forming a prolongation of the barrel. A wedge, rising behind it, locks it in place. Continued turning of the crank secures it firmly for the instant, and while so held, a hammer operating from a camming arrangement falls on the cap, firing the piece. As the crank continues to revolve, the

wedge relaxes its pressure. A lever device shoves the discharged container out of the recess, and a loaded container instantly drops into place.

The Ager weapon was purposely made not to exceed a speed of 120 shots per minute, since it used only a single barrel. The heat from rapid firing was considered a serious drawback. Subsequently the inventor arranged a very ingenious cooling device. The superabundant heat was rapidly carried away by a stream of air driven through the barrel and around a jacket surrounding it. The air was forced through the barrel by the action of a turbine type of fan connected to, and operated by, the same turning of the crank that also charged, fired, and ejected the empty containers. This affair also helped blow away any unconsumed particles of paper cartridge that were in the vicinity of the chambers or bore of the weapon.

Besides this artificial cooling, it also had many construction features that were either new or improved, such as a quickly detachable barrel. Two spares were carried as a further means of overcoming the heating problem. Speedy elevation and traversing was effected by a ball and socket joint mounting, which could be locked at any desired position. The barrel was rifled,

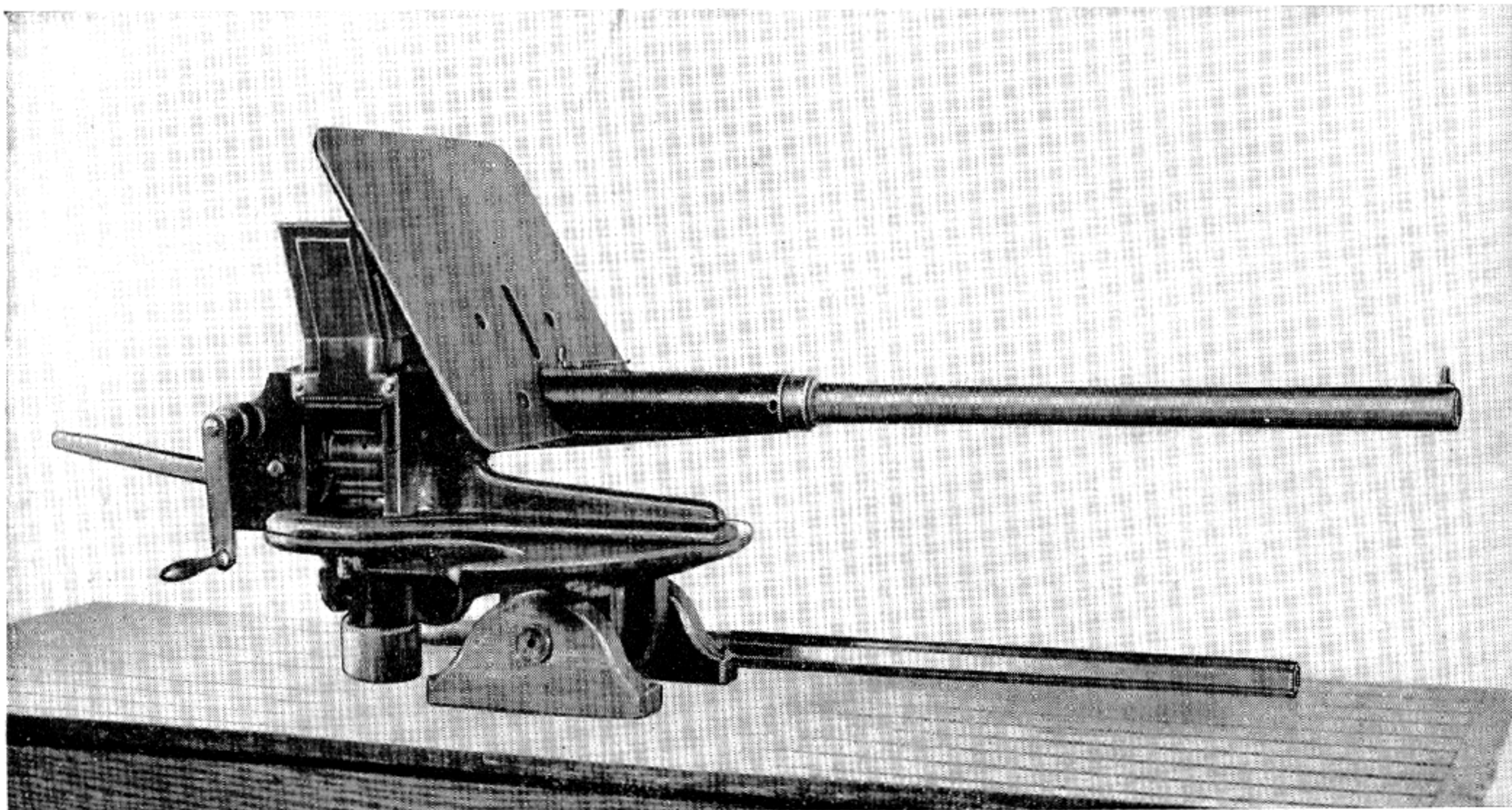

Ager Machine Gun, Cal. .58, without Carriage.



and the maximum effective range, using the caliber .58 Minié-type bullet and a 750-grain powder charge, was 1,000 yards.

The gun was mounted on a light, two-wheeled carriage, with ammunition boxes at either end of the axle, very similar to that used by the mountain guns of the period. It also came equipped with a "manlet" to protect the operator from the fire of small arms.

The Ager gun was a very advanced weapon for the Civil War era. But there was no military demand for a machine gun. Contemporary authorities condemned it as requiring too much ammunition ever to be practical. Also, from the fact that it had only one barrel, they reasoned it could never reach sustained fire to the extent of being considered as an effective arm. Quite a few guns were bought, but they were relegated to covered bridge duty with the Requa battery, there being only a few isolated instances where they were actually used in battle.

The fact that an adequate machine gun mechanism capable of sustained fire existed during the Civil War period can best be verified by a report by a British officer, Major Fosbery, who witnessed a demonstration of the Ager weapon. In his opinion, any weapon consuming such quantities of ammunition was prohibitive from the standpoint of cost and supply. He scoffed at the idea of a single barrel being able to stand the unheard-of feat of discharging from 100 to 120 bullets a minute.

Major Fosbery, an inventor in his own right, felt he had expressed adequately the consensus of all military reasoning when he appended the following to his report: "The only thing forgotten seems to be that, when firing at the rate of 100 discharges a minute, the flame of 7,500 grains of exploded powder and nearly 7 pounds of lead would pass through a single barrel in that time. The effect during the trial proved that the barrel first grew red and nearly white hot, and large drops of fused metal poured from the muzzle, and the firing had to be discontinued from fear of worse consequences."

Further proof of the existence of a serviceable machine gun during the Civil War is unnecessary. It would be considered a severe test even now to fire a weapon either continuously or in short bursts of sufficient duration to heat the

barrel until molten metal ran from the muzzle end.

As early as 1861, the Ager gun was being considered for service. The gun's reliability, during test, had been proved, and the armed forces were at last interested, but the official records show that no one would request unreservedly its purchase.

President Lincoln, himself, made a direct inquiry about the feelers that were being put out by the Army concerning the possible use of the coffee mill guns, and asked whether the Army actually wanted them or not.

The following exchange of correspondence and memoranda among the President, a representative of the makers of the gun, and General McClellan illustrates clearly the reluctance of the armed service to demand boldly something new—even if the time was desperate and the weapon in question had been proved to be reliable enough for consideration.

"EXECUTIVE MANSION

*Washington, December 12, 1861*

"MY DEAR SIR:

"I do not intend to order any more of the 'coffee mill' guns unless upon General McClellan's distinctly indicating in writing that he wishes it done, in which case I will very cheerfully do it. This is very plain: He knows whether the guns will be serviceable; I do not. It avails nothing for him to intimate that he has no *objection* to my purchasing them.

"Yours truly,

"A. LINCOLN.

"J. D. MILLS, ESQ."

"WILLARD'S HOTEL

*Washington, December 12, 1861*

"DEAR SIR:

"The President is under the impression, after seeing the copies of your application to the Secretary of War for fifty guns, and the reply of Colonel Scott, Assistant Secretary, that, as it does not expressly say so, perhaps you do not want them, and that, if you say you want them, in writing, he is ready to order them. He has addressed me a note, of which the foregoing is a copy, for the sake of ascertaining from you in

writing the simple fact that you want the guns. Your early reply will give him the desired information, and much oblige.

"Your obedient servant,

"J. D. MILLS

"MAJ. GEN. GEORGE B. McCLELLAN,  
*Commander In Chief, United States Army.*"

---

"I would recommend that fifty of the 'coffee-mill' guns be purchased, at twenty per cent advance on cost price, which cost may be ascertained by competent Ordnance Officers. I think \$1,200 entirely too high.

"GEORGE B. McCLELLAN  
*Major General, Commanding.*"

---

"December 19, 1861

"Let the fifty guns be ordered on the terms above recommended by General McClellan, and not otherwise.

"A. LINCOLN."

---

"July 3, 1862

"If the fifty guns have been made or tendered according to the above recommendation of General McClellan and conditional order of myself, let them be received and paid for.

"A. LINCOLN."

The extreme caution evinced in these letters was due no doubt to the dismal failure of the 1855 model Colt revolving rifle.

## CLAXTON FIRING MECHANISM

Of the other firing mechanisms that appeared soon after the stimulus of war, the most notable was the Claxton. This weapon consisted of two rifle barrels placed side by side on a framework in such a manner that the pair of the barrels were always in alinement with the two sliding breech mechanisms. This temporarily formed a double-barrel breech-loading rifle that operated by the manipulation of a pump handle located between the two breech actions.

The handle was worked by one man, while another fed the cartridges by hand into a short magazine feeder. Rapidity of fire was governed by the physical ability of the soldier to work the handle to and fro.

The gun could be mounted on a carriage somewhat like the Ager, and with the same kind of shield arrangement to protect the operator. This device was of ingenious construction in that it gave full protection to the gunner and still allowed freedom of action in operating and servicing the weapon.

The various officers and military representa-

tives who attended the tests and demonstrations, conducted by the producers of the Claxton weapon, were not impressed by its performance. According to the general opinion, it was of too frail a construction. The manual feeding was far from positive and had a tendency towards an erratic rate of fire. The whole procedure was slowed until 80 rounds a minute was considered maximum.

The weapon was invented by F. S. Claxton, son of Alexander Claxton, a well-known American naval officer. After the weapon failed to receive the interest expected, young Claxton took his invention to France and introduced it to the French service. The same weakness in construction was noted in France. It was later taken to England and manufactured by the Guthrie & Lee Explosive Arms Co., and is sometimes erroneously known as the Guthrie and Lee. Records of its actual use are very limited. However, its mechanism was revised by a Scandinavian engineer and after much refinement was popularized two decades later as an original European design.

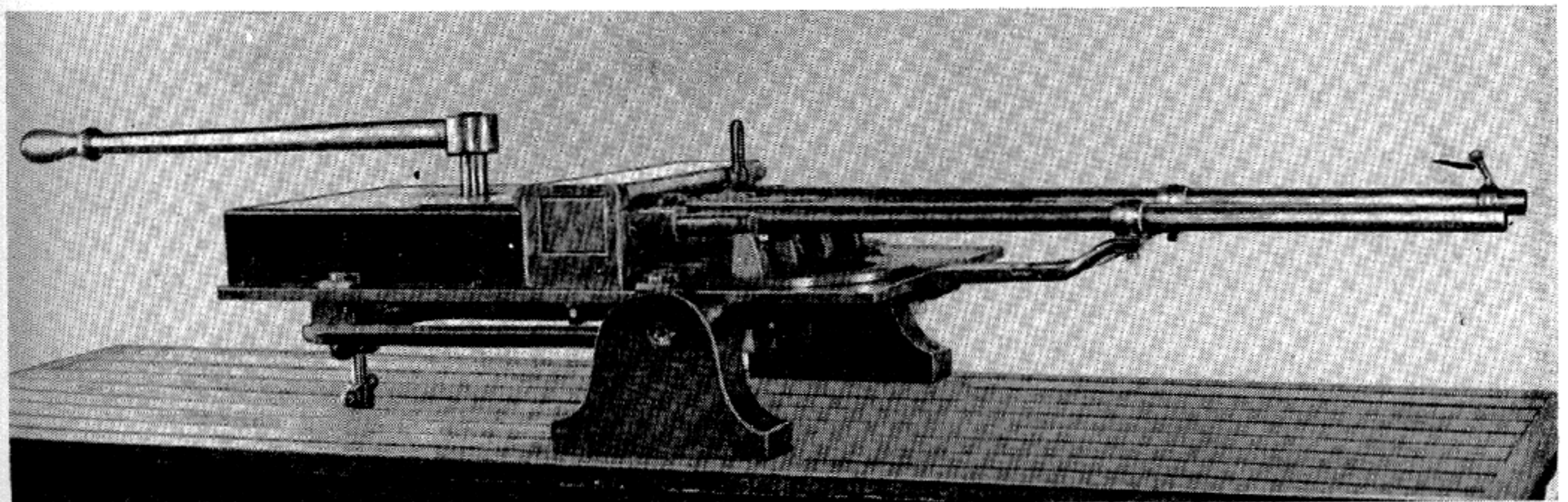

Claxton Machine Gun, Cal. .69.

## MACHINE GUNS USED BY THE CONFEDERACY

## Williams Machine Gun

To Capt. D. R. Williams, C. S. A., of Covington, Ky., goes the distinction of inventing the first machine gun to be used successfully in battle. This weapon, a 1-pounder, with a bore of 1.57 inches and a barrel 4 feet in length, was mounted on a mountain-howitzer-style limber and drawn between shafts by a horse. It was adopted by the Bureau of Ordnance, C. S. A., at the very beginning of the Civil War, and looked upon as a secret weapon.

The firing mechanism was operated by a hand crank located on the right side. When rotated clockwise, an eccentric actuated by the crank alternately retracted and pushed forward the breech lock, which was so arranged that the striker was released simultaneously with the locking of the piece. The weapon used a self-consuming paper cartridge. The latter was dropped by hand into position to be fed by the reciprocating breech lock into its loading recess. The mechanism was so arranged that, when the cartridge was fired, the shock of the explosion

was taken by the shaft on which the breech lock moves by the partial revolution of an eccentric. This transferred the force of the discharge from the breech lock to the shaft.

The rate of fire was 65 shots per minute and by actual test in battle the mechanism proved very reliable. The only trouble encountered was that after prolonged firing the breech would expand from the heat. A resulting failure to lock securely would take place until the barrel had cooled enough to permit the bolt to go fully into battery. A report was made on this type of malfunction by Capt. T. M. Freeman, C. S. A., Houston, Tex., of Giltner's Brigade. This officer commanded a battery of six of these weapons.

The extreme range of the Williams gun was set at 2,000 yards and, when several were operating at one time, unheard of fire power for this era was attained. The most effective official use was its initial test in battle when on 3 May 1862, at the battle of the Seven Pines, Va., under the direction of the inventor, a battery of the weapons opened fire on the Union forces with telling effect. This battery was attached to Pickett's

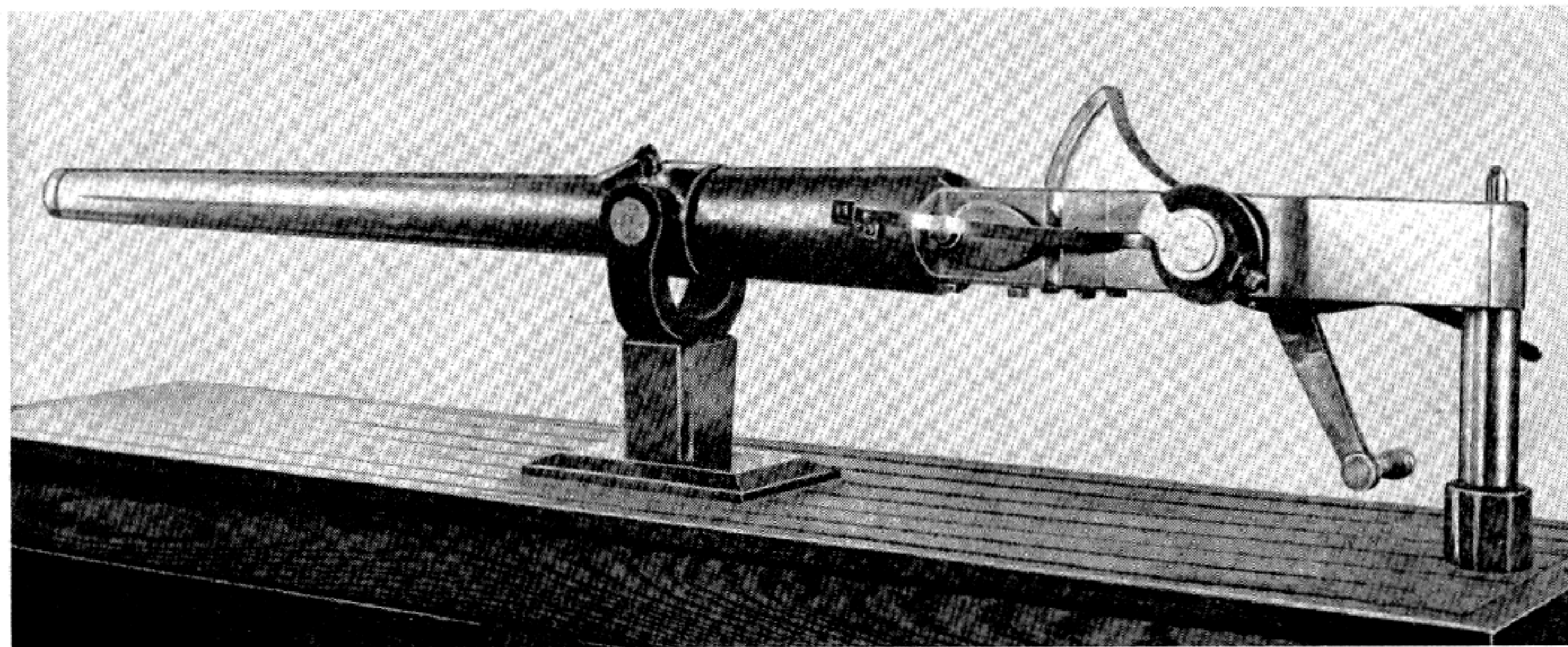

Williams Smooth Bore Machine Gun, Cal. 1.56.

Brigade. Later, when some Union officers were captured by the same Confederate forces, their first inquiry was concerning the strange rapid-firing guns used on them at Seven Pines. It clearly made a great impression on the Northern troops.

These weapons were used by the Confederacy all through the Civil War with a great deal of success, as attested by the written reports of various officers and men of the Union army that met this innovation in warfare. One of the most graphic descriptions was given by Capt. T. T. Allen of the Seventh Ohio Cavalry, who in his writings expressed amazement at the rapidity of fire and devastation wrought by the guns in the Battle of Blue Springs, in east Tennessee, 10 October 1863.

Two batteries of six guns each were constructed at Lynchburg, Va., and four batteries at Richmond, Va., by the Tredegar Iron Works, and one battery at Mobile, Ala. Gen. Simon Bolivar Buckner, C. S. A., placed those made at

Mobile into the artillery branch of the army under his command. One of these guns, with all accessories, was captured by the Union army at Danville, Va., in April 1865 and sent to the West Point Museum as a trophy of war. The unique gas check on this weapon was later adapted to the first breech-loading field piece adopted by the United States Army.

### Vandenberg Volley Gun

The Vandenberg volley gun, manufactured in England, was a weapon of questionable value. It was the invention of an American, Gen. O. Vandenberg, who tried to market his weapon in Britain. He delivered a lecture on 9 May 1862, which was published in the *Journal of the Royal United Service Institution* (British). In his address he discussed his "new system of artillery, for projecting a group or cluster of shot."

The Vandenberg gun closely resembled an earlier Belgian weapon. However, when made

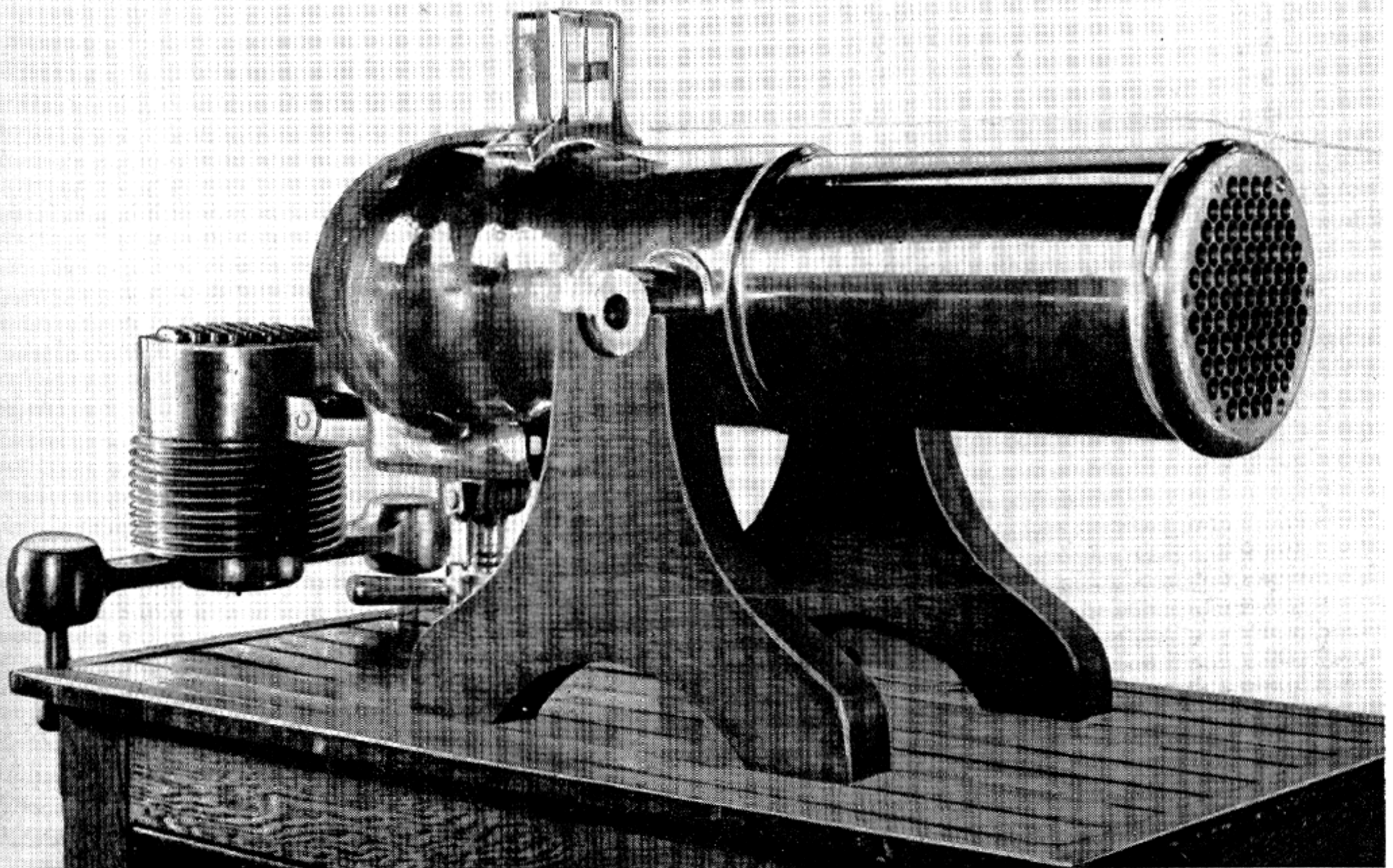

Vandenberg Volley Gun, Cal. .50. 85-Barrel Model Used by the Confederates.

in caliber .45 using a 530-grain lead bullet, many authorities of that day considered it superior to the continental model. Depending on the size of the projectile for which it was designed, the gun had from 85 to 451 barrels. The breech was removable, and was positioned fore and aft by a screw; it was guided into place by a key-way, which, when fitted, brought the holes in the breech end in alinement with those in the stationary barrels.

In order to overcome the escape of gas and smoke at the point where the breech end joined the barrels, the forward end of each chamber was counterbored, and a short copper sleeve, cone-shaped, was placed ahead of the bullet. Upon forcing the breech in place by the screw leverage, the copper piece was crushed into position to form a gas-tight seal or gasket.

The method of ignition was unique in that the center charge was fired by percussion and ignited the whole volley simultaneously. However, by plugging off the vents, or ignition gal-

leries, in advance, the discharge of the piece could be regulated to fire by sections of one-sixth, one-third, or one-half of the group. The other sections remained charged, ready to be fired by inserting a new percussion cap, and opening the formerly plugged orifices.

General Vandenberg also made a loading machine for facilitating the charging of the many chambers in the breech. The device, when placed on dowels, was in proper position over the holes in the chambers. By manipulating a lever, measured charges of powder were dropped simultaneously into every chamber. This mechanism could be removed quickly, to be replaced by another containing lead balls. When properly positioned, the latter dropped the bullets into place. A ramming device was then put on, and all charges were compressed at once by the action of a lever on the loading plungers.

It can readily be seen how by three operations all chambers could be loaded in a relatively short time. An elongated lead ball was used that was

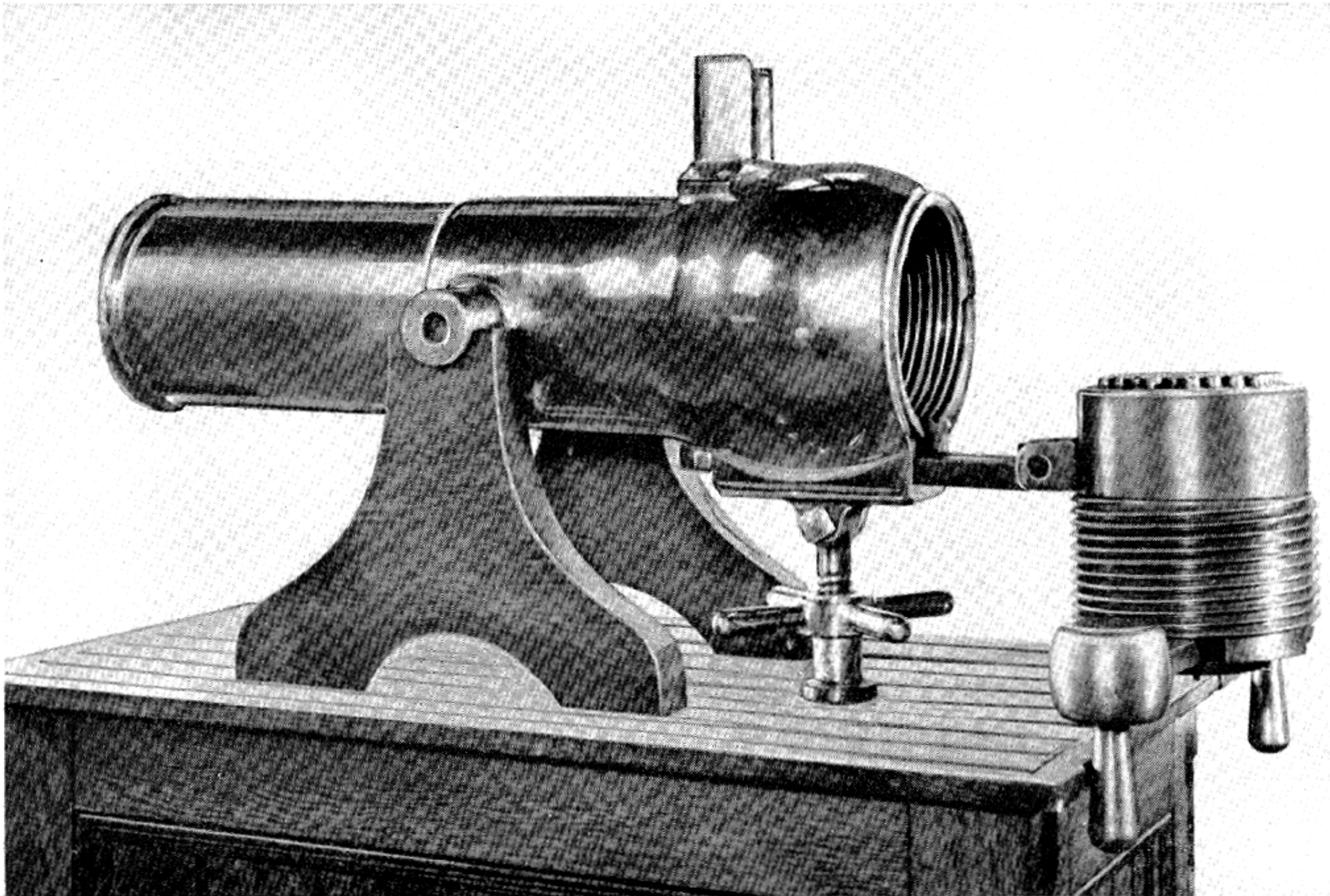

Vandenberg Volley Gun. A Loading Tool Was Supplied with the Weapon that Loaded all Chambers Simultaneously.

.010 inch larger than bore size. The resulting pressure, as it started to engage the rifling, was sufficient to compress the soft lead enough to seal off any gas leakage that might otherwise have resulted.

A test of this weapon in a 91-barrel version showed that it could place nine-tenths of the volley in a target 6 feet square at 100 yards. The British showed an interest in its shipboard use against enemy personnel but, because of its terrific weight, it had little future as a land weapon.

General Vandenberg, at the outbreak of the Civil War, made many attempts to sell the arm to the United States Government. He even went so far as to offer to ship the gun from England for experimentation, free of charge.

When no interest was shown, he wrote a letter on 18 February 1864 to Brig. Gen. George D. Ramsey, Chief of Army Ordnance. In it he stated that he would either send or bring three of his guns to this country, and present them to the President, or the Secretary of War, as an "offering to our country and government."

The three guns were later shipped. Upon arrival they were tested with little delay by Captain Benton, United States Army Ordnance. After a very comprehensive test, he reported that they were not acceptable for Government service. Many improvements would have to be

made before they could even be considered for further testing.

Captain Benton, being a very thorough man, decided, after testing the weapon, to clean it, keeping account of the time required to do so. He found it took 9 hours for one man to clean the bore and chambers of the weapon adequately. This maintenance problem, alone, made its usefulness doubtful in the field.

At this stage, General Vandenberg, perturbed over what he termed a "purely negative attitude" with regard to his artillery, requested that the Government either put the guns in order and further test them, or make payment in full. The Government, after much correspondence, put the weapons in the same condition as received and returned them to him.

The use of several of the guns in the South demonstrates that the Confederate forces did not concur in Captain Benton's views on the subject. However, on these Southern weapons the name of the British firm, Robinson and Cottam, is stamped. Undoubtedly, General Vandenberg was "too patriotic" to allow them to be sold to the South marked with his name.

There is a record of one being used in the defense of Petersburg, Va. Another was purchased by Gov. Zebulon B. Vance of North Carolina, and called by his skeptical constituents "Vance's folly." Later this weapon was captured by a

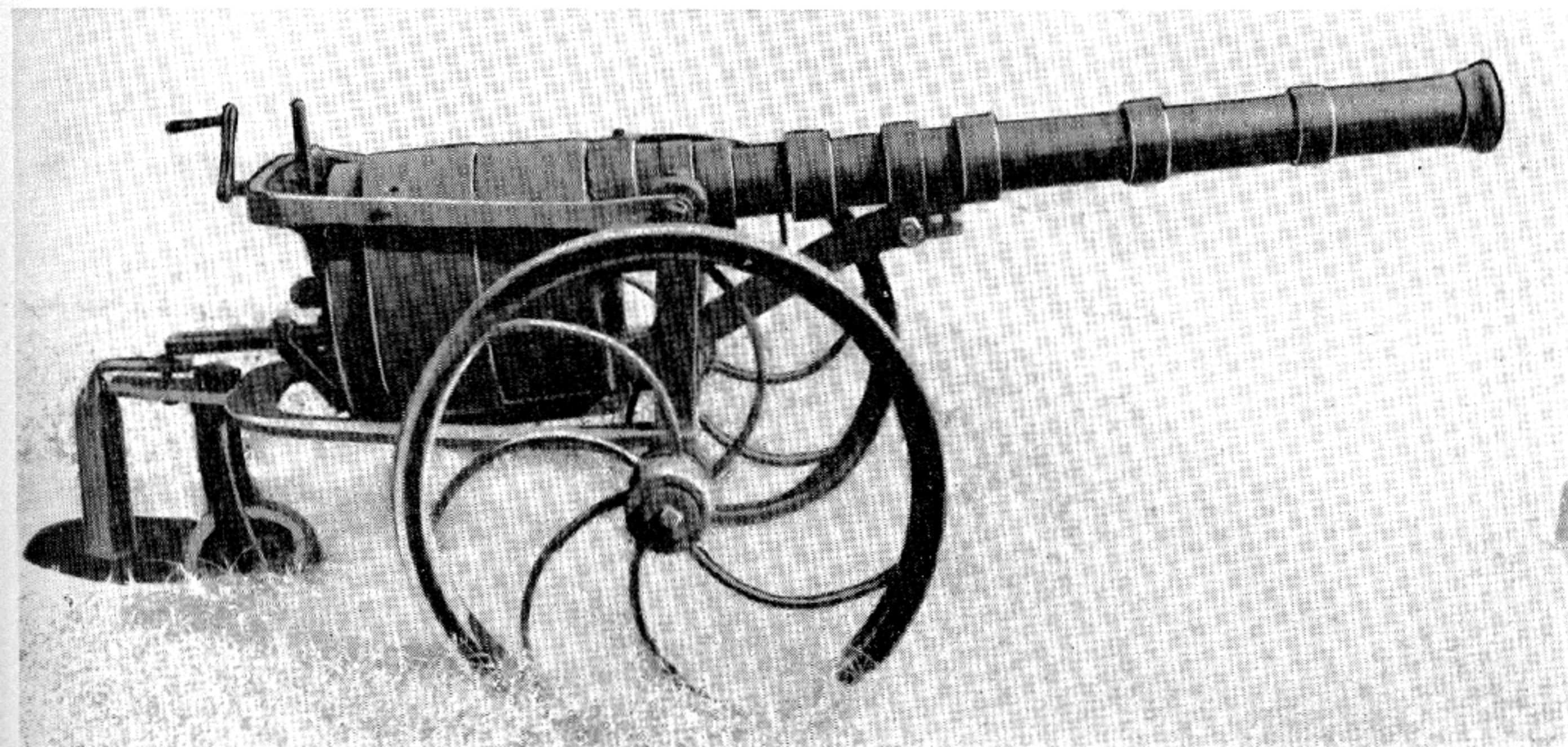

Confederate Revolving Cannon.

Union cavalry unit under Maj. Gen. George Stoneman at Salisbury, N. C., in April 1865.

### Confederate Cannon

The Confederacy also developed a 2-inch bore 5-shot machine gun during the war. It was used in the siege of Petersburg, Va., and was later captured on 27 April 1865, at Danville, Va., by Union troops and sent to the Ordnance Laboratory, United States Military Academy, West Point, N. Y.

The weapon uses the principle of the service revolver whereby rotation of the cylinder indexes a loaded chamber with the breech end of the barrel. It is held in alinement by a spring-loaded dog slipping into a recess in the cylinder. To cut gas leakage to a minimum, a screw arrangement at the rear jacks the cylinder forward after positioning until a tight joint is effected between the front of the chamber in the cylinder and the breech end of the barrel.

The chambers are ignited by use of a percussion cap on a nipple. The cap is struck by a huge spring-actuated striker built into the flat strip

that supports the chambers at their aft end. The cylinder is moved one-fifth of a revolution and lined up for firing by the moving of a lever from left to right. The lever is attached to a ratche arrangement, the distance moved being regulated by its mounting in the frame in such a manner as to control the revolving of the cylinder. The lever, when brought to the left as far as possible and swung to the right as much as the frame will permit, turns the cylinder one-fifth of a revolution and indexes the loaded chamber.

While its use at this time showed the serious effort of the Confederacy to develop a weapon capable of sustained fire, this bit of experimentation added nothing but a bit of colorful history. All the principles involved were as old as the use of gunpowder in warfare.

### Gorgas Machine Gun

Another machine gun, under construction by the Southern forces, was the invention of their Chief of Ordnance, Maj. Gen. Josiah Gorgas, C. S. A., (1818-83). It was a single-barrel, cast iron, smooth-bore affair, caliber 1.25 inches.

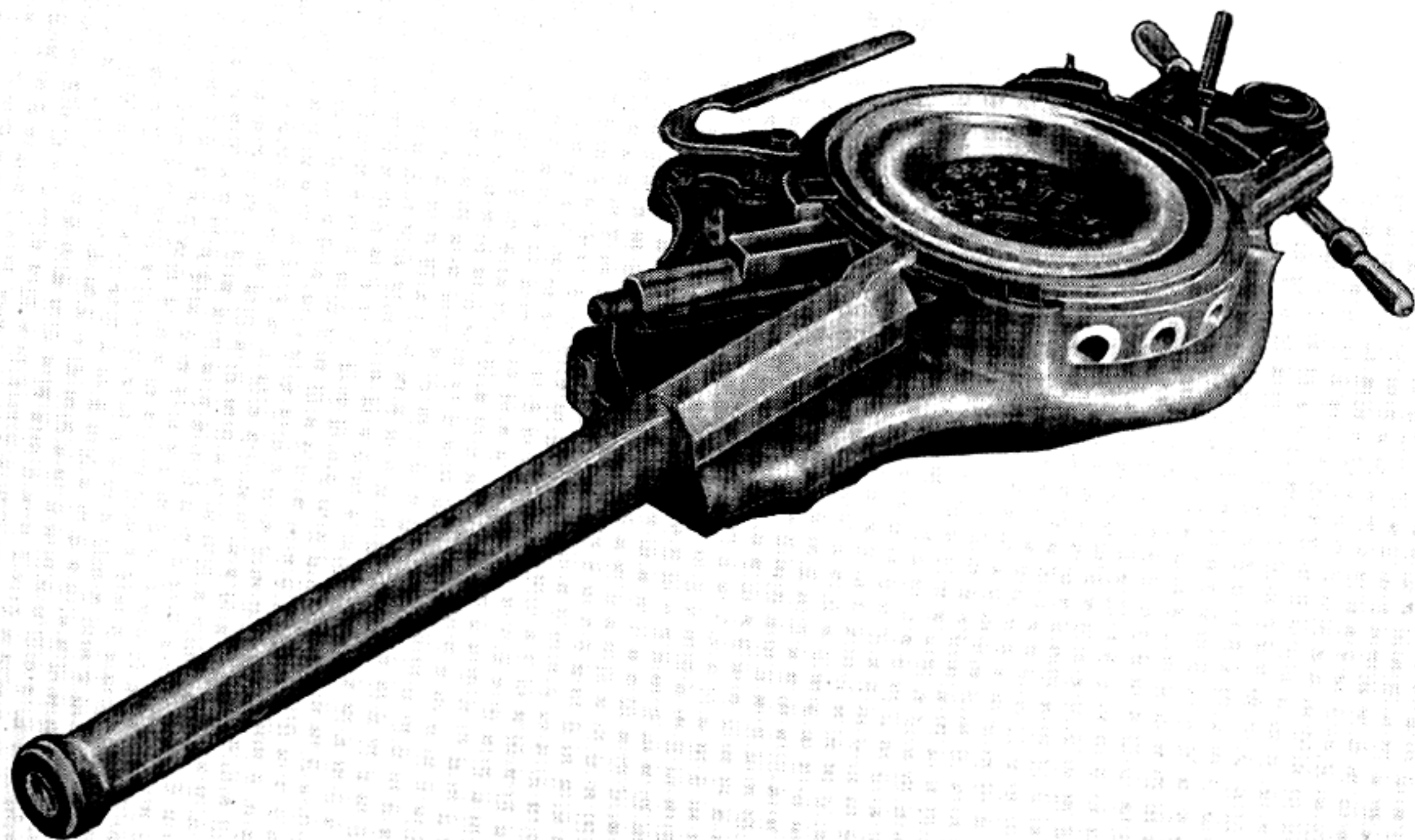

Gorgas Machine Gun, Cal. 1.25.



The barrel is fastened by an eye and wedge key to a heavy cast-iron horizontal plate. This plate extends under part of the barrel, is circular in rear of the barrel and has an extension to the rear; the rear part contains gearing which is operated by a hand lever. This gearing rotates a horizontal ring contained in the circular portion of the horizontal plate. There are 18 copper-lined muzzle loading chambers on the outside circumference of the ring, and 18 corresponding percussion cap nipples on the inner circumference. Under these nipples and on the ring are the same number of cams; these cams act successively on a lever which withdraws a hammer and compresses a firing spring when the ring is rotated from left to right. The hammer is released as it reaches the end of the cam. The trunnion piece is pivoted underneath the front of the horizontal plate. A lever and loading piston, on the right of the barrel and attached to the

horizontal plate, rams home the charges in succession as the ring is rotated and the chambers are seated behind the barrel. The gun is mounted on a pivot that allows it to be moved in azimuth.

General Gorgas was born in Dauphin County, Pa., was a West Point graduate, class of 1841, and an outstanding artilleryman during the Mexican War; he resigned his commission in 1861 and was made Chief of Ordnance of the Confederacy. His own version of a machine gun was not perfected in time to be tested in battle. However, his tactical use of the light and mobile smooth bore cannon, using canister or grapeshot, somewhat in the form of an oversized shotgun, was employed with deadly effect against personnel. It showed the lethal results of concentrated fire and the need for controlling dispersion. This, no doubt, made foreign observers take an interest in any weapon that might come in this category.

# GATLING MACHINE GUNS

## The Model 1862 Gun

The North was deprived of a great ordnance officer when Major General Gorgas joined the Confederacy, but this loss was more than offset when Richard Jordan Gatling moved to the North in 1844, hoping to manufacture and market several of his mechanical inventions.

Gatling was born in Hertford County, N. C., on 12 September 1818. His parents were Mary Barnes and Jordan Gatling, both descended from English colonists in North Carolina. His father, while still a young man, had invented a machine for planting cotton and another for thinning the plants to a stand. Richard Jordan Gatling assisted in the construction of these mechanical aids and, in his own name, patented a rice planter. The younger Gatling, believing that the prospects of a northern market were more profitable, adapted his rice planter to other grain, and moved to various cities in Missouri, Ohio, and Indiana.

In 1847-48, he studied medicine at Laporte, Ind. The following year he entered Ohio Medical College from which he received a degree. While he was ever afterwards known as Dr. Gatling, there is no record of his ever practicing medicine. It is claimed that he studied only to protect his family from the ravages of the small-pox epidemics which were regularly sweeping the country.

Purportedly at a suggestion by Col. R. A. Maxwell that a special objectives weapon was needed, Gatling drew up plans for a machine gun. Conceived in 1861 and patented in 1862, it was designed to defend buildings, causeways, and bridges. The first model was only a crude forerunner of the gun he soon perfected, the prototype of one of the most remarkable firing mechanisms of all ordnance history—the Gatling gun.

The weapon was the logical outgrowth of the trends portrayed in the Ager and Ripley guns.

Gatling combined the best principles of both and overcame their most objectionable features. His successful results caused him to be credited generally with being the father of the machine gun.

The 1862 Gatling guns, types I and II, were fundamentally the Ager principle, improved by the multibarrel arrangement of the Ripley gun. In these models the engineering difficulties had not been completely overcome. However, his first gun laid the basic design groundwork. It was crank-operated with six revolving barrels, having a bolt for each barrel. Cocking and firing were performed by cam action and the weapon was gear driven. By taking advantage of the machine tool progress, he was the first to have used successfully a method of camming to insure positive action and certainty of fire.

This model had many of the bad features of its forerunner, the Ager. It used paper cartridges and steel chargers that acted as firing chambers. The chargers were primed with percussion caps on nipples and the bolts acted as strikers to fire the caps. The chargers were supported during combustion by a cylindrical piece that housed the striker. A hopper gravity feed similar to that of the Ager was also used.

As early as 1862 enough progress had been made on the weapon that a model, actually in working order, was exhibited before thousands of people in Indianapolis. One of the most interested spectators was the Hon. O. P. Morton, Governor of Indiana. This gentleman wrote to P. H. Watson, then Assistant Secretary of War, advising him of the weapon's unusual performance. He suggested that Dr. Gatling's gun be permitted officially to prove its worth.

With this encouragement, Gatling continued to perfect his prototype until he deemed it reliable enough to pass any government test. Financial backers were sought in order to produce the weapon in sufficient quantities should

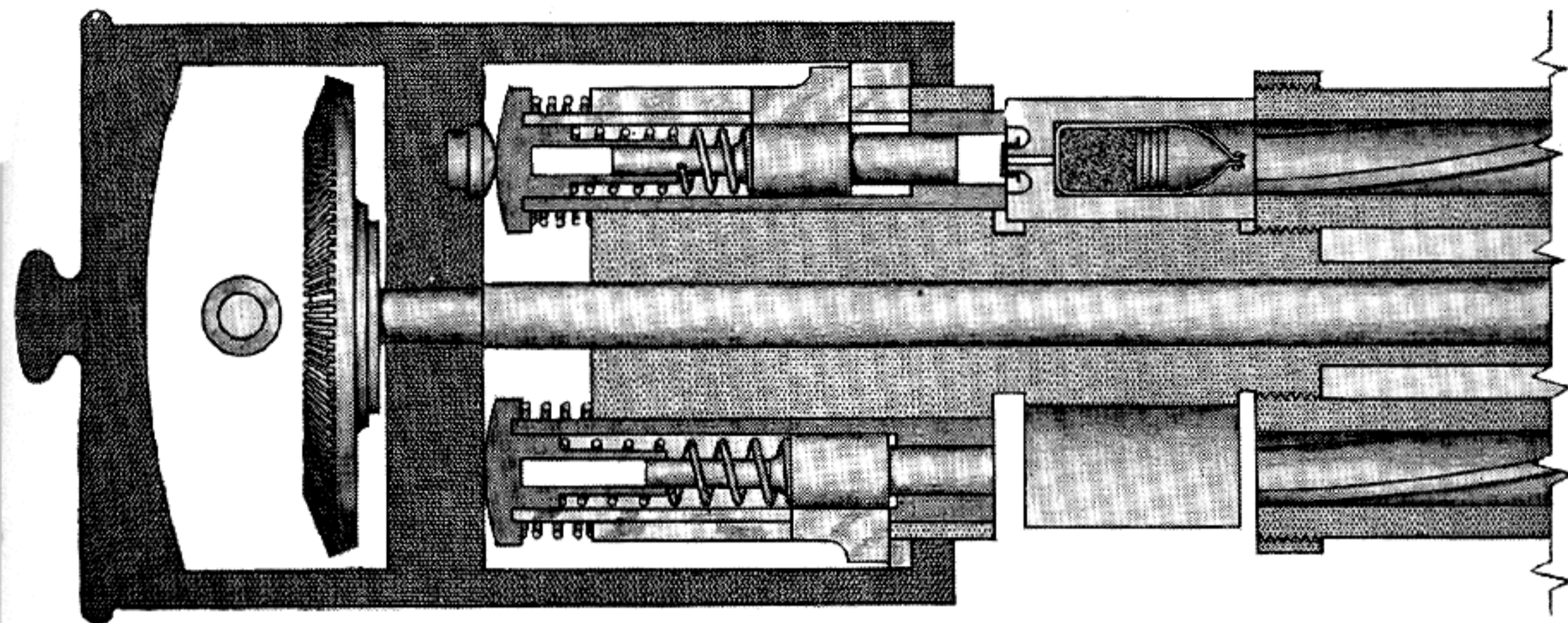

A Section View Showing the Action of Gatling's First Model Gun.

the armed services become interested. With all the capital he could muster, Gatling went to Cincinnati, Ohio. There Miles Greenwood & Co. contracted to make six weapons in accordance with his patent of 4 November 1862.

Unfortunately for Gatling, this factory, together with the weapons then near completion, blueprints and patterns, was destroyed by fire. The inventor was subjected to a heavy loss, both in money and in irreplaceable pilot models used in constructing these first weapons.

But he was not easily discouraged. After a very short interval he was again in business, now backed by McWhinny, Rindge & Co., also of Cincinnati. This time 12 guns of the 1862 model were manufactured.

Constantly seeking perfection, Gatling made several basic construction changes soon after the guns left the factory. For instance, the prototype and the November 1862 weapons employed a steel container with a percussion cap on the end and paper cartridges for the charge. Soon after the guns were completed by McWhinny, Rindge & Co., Gatling decided to use copper in place of paper in the cartridge cases. These metal cartridges were rim fire, which necessitated the placing of two projections on the bolt head to strike the rim-fire primer. The striker served both as firing pin and as a hammer while eliminating the use of the percussion cap on a nipple. In view of these modifications the gun can be classified correctly as type II of the 1862 model.

Results were so successful that, while the in-

ventor retained the steel chambers on this model, he always used metal cartridges thereafter.

The copper-cased rim-fire ammunition was a definite step forward. It made the 1862 model Gatling easier to load and more certain to fire. However, it did not overcome the one difficulty that plagues all revolver-type firearms: the excessive gas leakage that takes place between the forward end of the cylinder and the breech end of the barrel.

Gatling tried to solve this in both of his 1862 types by using a fixed steel cam, so placed as to wedge the chargers tightly against the barrel at the moment of firing. This arrangement was not too efficient. It made the crank hard to turn and caused excessive wear on the parts involved. To some extent this galling action could be compensated for by an adjusting screw that controlled the fore and aft position of the cartridge container.

Both types of the 1862 model were made with six barrels and in rifle caliber .58 only. One of the oddest things about the design of the guns was a tapered bore, which was used to overcome mismatch of the barrels with the steel chargers in the cylindrical carrier. However, this proved very unsatisfactory. Recovered projectiles often showed no engraving marks of the rifling and generally struck the target sideways. An attempt was made to remedy this by increasing the taper and reducing the bore at the muzzle.

## Tests and Demonstrations

Dr. Gatling and Mr. Rindge, one of his partners, demonstrated the gun themselves. They made no attempt to conceal the characteristics or construction of the weapon, but published fully illustrated accounts of its design and performance. These eventually found their way to all parts of the world, and aroused foreign inquiry. Nevertheless, our military authorities did not consider the invention especially desirable.

On one of his numerous trips to Washington to interest the Army, Gatling called on Brig. Gen. J. W. Ripley, Chief of Ordnance, and asked that the weapon be given tests with a view of adopting it. General Ripley refused point blank to take the gun under consideration; no doubt he was influenced by confidential reports on the inventor's southern sympathies as much as by any other factor.

A few days later, one of Gatling's representatives met Gen. Benjamin F. Butler in Baltimore, and asked permission to demonstrate the weapon. At the same time he neglected to mention General Ripley's refusal to become interested. Butler was enthusiastic over the resulting exhibition. He immediately purchased 12 guns, paying \$12,000 for the weapons, on carriages, complete with 12,000 rounds of ammunition, and personally directed their use in battle during the siege of Petersburg, Va.

Gatling was not the kind to hide his light under a bushel. Ever the opportunist, he had written to Maj. R. Maldon of the French Royal Artillery as early as 29 October 1863, suggesting the devastating possibilities of his gun in warfare, and enclosing a full and accurate description of the weapon. He proposed that should the major think it ethical, this might be the appropriate time to show the description and drawings to the Emperor Napoleon III.

Gatling did not have to wait long for a reply. A request, in the name of the French Government, promptly came making specific inquiry on test reports, type of ammunition, the kind considered best for field conditions, proof of reliability, and the possibility of obtaining one of the weapons with ammunition for conducting a conclusive test.

It is of particular interest that the text of the

letter showed the keen awareness of the French Government toward this gun. Its observers during the Civil War, knowing the effectiveness of grapeshot fired from cannon against personnel had recognized the need for an even more efficient weapon. Undoubtedly they had already dispatched information concerning the Gatling gun to their own ordnance department, and discussed the possibilities of its deadly use in European warfare.

To the French inquiry, Gatling promptly responded by sending all the data requested, including published endorsements from high ranking military and civilian persons who maintained that the weapon was revolutionary and the most destructive engine of war ever invented. He likewise informed the French that he would not sell them one gun, as requested; but he could deliver them a hundred if needed, as he was now in a position to manufacture them in a reasonable length of time. This proposition was declined—fortunately; since the United States Government, shortly thereafter, forbade the exporting of arms and munitions of war.

Gatling's correspondence with the French authorities definitely proves that his gun was known to the French high command as early as October 1863.

This occurred considerably before Napoleon III ordered Commandant de Reffye, the leading French ordnance engineer, to produce a weapon that would actually do what records of tests and statements of individuals claimed was possible for the Gatling. It is conclusive proof that Gatling had a reliable and practical weapon for military use, long before any similar gun of European origin was beyond the blueprint stage.

With the hope of getting the necessary Union authorities interested in the matter, Gatling wrote President Lincoln, and pointed out that his deadly invention was an act of Providence for suppressing the rebellion in short order.

This brings to light a peculiar thing about the personality of this extraordinary man. At the same time he was describing his gun as the tool of Providence to help the North defeat the South, Army authorities were investigating his personal life. Henry B. Carrington, commanding general of the District of Indiana, reported that Gatling belonged to the Order of American

Knights, a group of Confederate sympathizers busily engaged in aiding the Southern cause by acts of sabotage; and described Dr. Gatling, "inventor of the gun so named," and the jailer of Louisville, Ky., as the most active and dangerous of the entire organization. Furthermore, he reported that at Louisville a Federal supply boat had been recently burned by them.

Having been born in North Carolina, Gatling's loyalties were naturally assumed to be with the South. This is believed to have influenced the location of his place of manufacture in Cincinnati, on the opposite side of the Ohio River from the South. Should he have gotten into quantity production, it would be a strategic position for selling his product to both the North and the South. He could either have delivered guns, or let them be seized in his shop by a quick Southern raid.

Whatever his incentive was for locating in Cincinnati, nothing materialized. Gatling did not receive from the armed services of either side the recognition he expected. Therefore his production was meager. However, during this period his gun was given an official trial at the Washington Navy Yard and was successful enough for Admiral Dahlgren to approve the weapon's adoption by any fleet or squadron commander who requisitioned it.

### The Model 1865 Gatling

As bad features appeared during tests, Gatling observed them and a short time later made corrections. In the autumn of 1864 he made his first attempt to prepare changes that would correct the parts causing malfunctions, so common to all prototype or first model weapons.

With the completion of what he thought was the solution, Gatling ended his partnership with McWhinny, Rindge & Co., of Cincinnati, and contracted with the Cooper Fire Arms Manufacturing Co. of Frankford (Philadelphia), Pa., for the production of the improved gun. James Maslin Cooper already had an outstanding reputation for precision-built weapons. Therefore, the Gatling guns made under this contract between 1865 and 1866 were a marked improvement over the earlier models.

Incorporated in these later guns were all the

things thought necessary to correct the objectionable features of the previous design. Gatling ended the gas leakage problem by redesigning the weapon, and combining the cartridge chamber with the barrel; which, in effect, resulted in a breech-loading musket barrel, chambered to receive the metallic cartridge. At the same time he introduced reciprocating motion to a bolt of new design. While this piece revolved with the barrels, a fixed helical cam imparted a shuttle movement that performed the functions of loading, firing, extracting, and ejecting.

Since the cartridge was placed in the chamber of the barrel, a method of extraction had to be put into the gun. This was done by adding a spring leaf attachment on the side of the bolt. When the bolt was in battery, the notched lip of the extractor cammed itself over the rim of the cartridge in order to pull the empty case rearward immediately after it was fired.

This modified Gatling design used the caliber .58 with a rim-fire copper cartridge case, having a powder charge of 54 grains, and a Minié bullet of 566 grains. It had six barrels, as did the earlier models. However, this gun design resulted in the excellent piece that was so universally accepted.

The operation of the weapon is very simple. One man installs a loaded feeder while the operator aims the gun and turns the crank. A set of beveled gears revolves the main shaft, carrying with it the bolt cylinder, carrier, barrels, and bolts. As the barrels rotate, the cartridges, one by one, drop into the grooves of the carrier from the feed. Instantly the bolt, by its engagement in the spiral cam surfaces, moves forward pushing the incoming round into the chamber. On the continued forward movement of the bolt, the spring is fully compressed by the cocking lug of the striker reaching the highest projection on the cam. Upon being released at this point, the spring drives the striker forward into the primer, firing the cartridge.

As the rotation continues, the bolt starts rearward. The extractor hooks loosen the empty case, and carry it to a point where its base hits the ejector, knocking the empty brass through an opening in the housing, clear of the mechanism.

Each barrel is discharged in turn as it reaches the lower right hand position, the cycle-of operation of any single bolt and barrel assembly

Indianapolis Ind  
Feby 18<sup>th</sup> 1864,

To His Excellency  
A. Lincoln  
President of U.S.

Sir

Pardon me for the liberty I have taken in addressing you this letter.

I enclose herewith a circular giving a description of the "Gatling Gun" of which I am inventor and patentee.

The arm in question, is an invention of no ordinary character. It is regarded, by all who have seen it operate, as the most effective implement of warfare invented during the war, and it is just the thing needed to aid in crushing the present rebellion.

The gun is very simple in its

construction, strong and durable and can be used effectively by men of ordinary intelligence.

The gun, was, months ago, tested at the Washington Navy Yard and gave entire satisfaction to <sup>the</sup> officers who attended the trial, and it was adopted by the Naval Bureau with the understanding that any requisitions for the gun, made by Naval officers would be allowed, since which time a number of requisitions have been sent in for the gun, by different Naval officers, but none of said requisitions have been granted to my knowledge.

Genl Banks, commanding at New Orleans, has also made requisitions for a number of the guns to be placed on transport vessels in his department, when they would be found, no doubt, very serviceable. Many other Army

officers are very anxious to  
obtain the guns.

Messrs M<sup>c</sup>.Whinney & Kedge, part-  
ners of mine, in the manufacture  
& sale of the gun - are now in  
Washington with a sample gun  
and I hope ere long to hear of  
its adoption by the War Depart-  
ment. Its use, will, undoubtedly,  
be of great service to our armies  
now in the field.

May I ask your kindly  
aid and assistance in getting  
the gun in use? I know of  
a truth that it will do good  
& effective service.

Such an invention, at a time  
like the present, seems to be providen-  
tial, to be used as a means in  
crushing the rebellion.

With very great consideration  
I am your obt<sup>d</sup> serv<sup>t</sup>

(over)

R. S. Gatling

Is 304 - 3<sup>rd</sup> Feby. 64.  
S. K. 1. 224

I have seen an inferior  
arm known as the "Coffee Mill,  
Gun" which I am informed has  
not given satisfaction in practical  
tests on the battle field. I assure  
you my invention is no "Coffee  
Mill Gun" - but is entirely a  
different arm, and is entirely  
free from <sup>the</sup> accidents and objections  
urged against that arm.

R. S.

being completed in one revolution. The firing continues as long as the crank is turned and the feeder remains loaded.

One of these weapons was finished in late December 1864. One month later it was sent to Washington and submitted by the Gatling representative, Gen. John Lowe, to the Army Ordnance Department for test.

A trial was ordered and carried out satisfactorily within a month. The improvements made by Gatling were hailed as a great success. The fact that it had completely overcome all gas leakage at the breech was accepted as the greatest accomplishment of all. After these tests he was granted a patent on the changes (9 May 1865).

General Dyer, the new Chief of Army Ordnance, suggested that additional guns be designed in 1-inch caliber. These were to use either a solid lead ball, or a ball and buckshot load for close shooting—such as might be needed for street fighting and bridge protection. If the design changes could be accomplished, Dyer agreed to order Government trials at the Frankford Arsenal at Philadelphia where machinery would be especially constructed to make the 1-inch rim-fire cartridges. It was decided to build eight such weapons and Gatling personally supervised their construction at the Cooper plant.

When these weapons were completed, they were turned over to Col. S. V. Benét, officer in charge of the Frankford Arsenal. He was to conduct tests for the purpose of improving the ammunition design, since it was very difficult not only to manufacture the conventional rim-fire ammunition, but also to maintain even distribution of mercury fulminate all around the inside of the rim. The latter was necessary to insure positive ignition.

While the weapons were in the hands of Colonel Benét, who later became the Army's Chief of Ordnance with the rank of general, many demonstrations were conducted for high ranking officers. Among those who witnessed a firing in Washington were Generals Grant, Hancock, Dyer, Manadier, and Hagner, as well as other Army and Government officials.

With respect to these various exhibitions, and the expenditure of thousands of rounds of ammunition, Colonel Benét, in a summation that

was unique in its brevity, stated: "The gun worked smoothly in all its parts."

### Adoption by the United States

The development of this type of weapon divided military men into two schools of thought. One believed that it should be an artillery support; the other considered it a special objectives gun for bridges or street defense. Neither recognized its true mission as an infantry weapon.

Many of the trials included its being fired in competition with howitzers and cannon. In each instance the Gatling placed more bullets in the target than did the artillery if allowed to fire as many bullets as the number of grapeshot fired. On the basis of these results, the gun was officially adopted by the United States Army on 24 August 1866. In 18 months' time the 1-inch weapon had been manufactured, given strenuous tests, and adopted by the Army. An order was placed for 100 guns. Fifty were to have 1-inch caliber. The remainder were to use the service ammunition for the caliber .50 army rifle. These 1-inch and caliber .50 rounds were the outgrowth of experimentation and development by Colonel Benét to produce a successful center-fire cartridge.

While maintaining, as before, his Indianapolis main office, Gatling made another change in manufacturing connections. This time he entered into contract with Colt's Patent Fire Arms Co., Hartford, Conn., to build the 100 guns for delivery in 1867. This business connection proved so satisfactory that as long as the service used the Gatling, it was manufactured by the Colt Co.

To adapt the gun to the improved cartridges of Colonel Benét, Gatling again modified his bolt in order to convert from the caliber .58 rim fire to the caliber .50 center-fire ammunition. By this improvement he completed in four short years an evolution in design. He divorced the machine gun for all time from the percussion nipple on a steel cartridge container and substituted instead the center-fire brass cartridge. In doing this he developed the kind of bolt assembly used in so-called "modern" machine guns.

Among the guns in this 1866 group were the first deviations from the original six-barrel de-



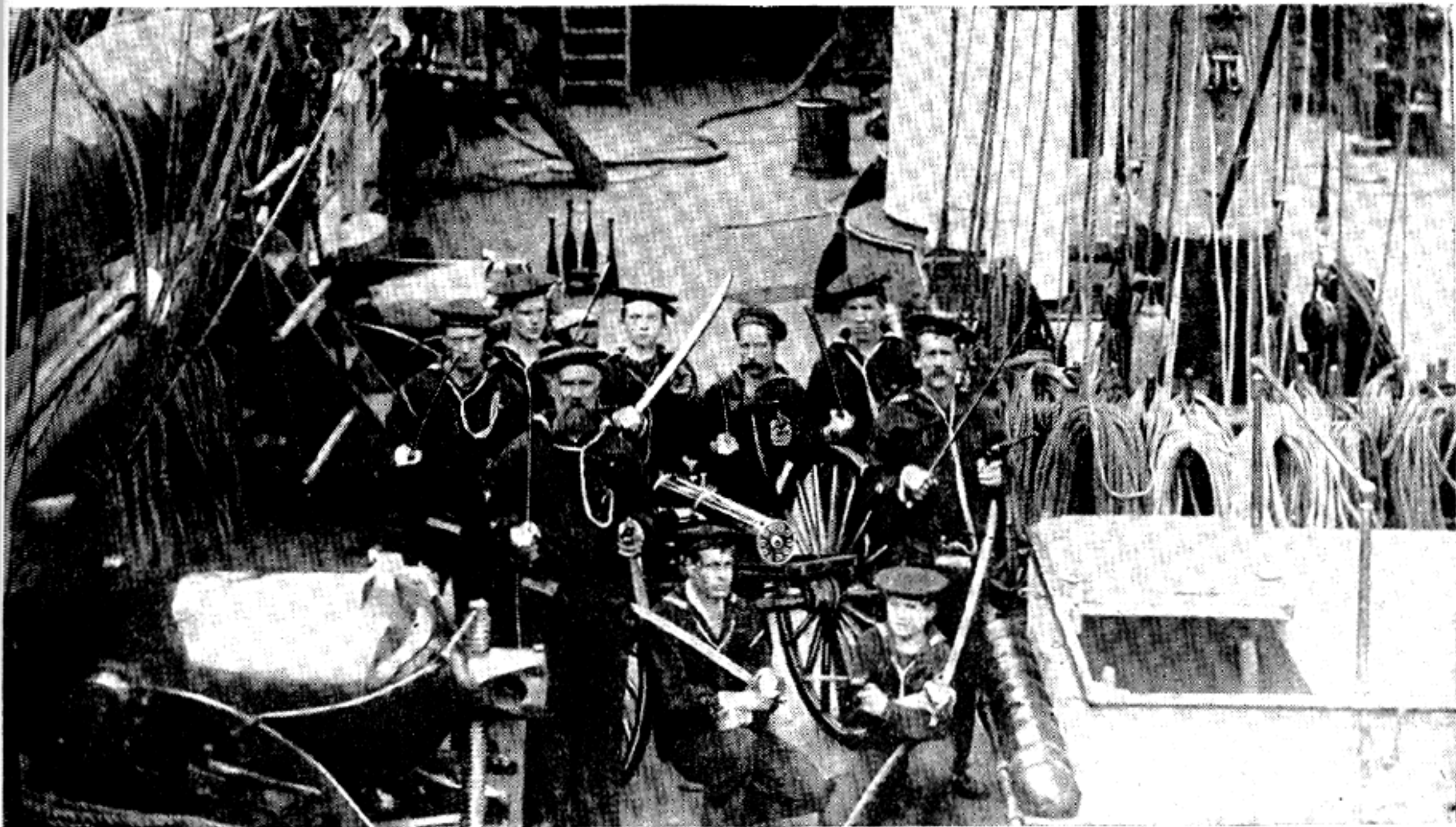

Gatling Gun Aboard the USS Alliance.

sign. A 10-barrel version was made in both the 1-inch and the caliber .50 dimensions.

With the Civil War over and the arms embargo lifted, the Colt Co. appointed representatives for the purpose of introducing and selling Gatling guns throughout the world. They met in open competition the best that Europe had to offer. In every instance where a properly designed cartridge was used, the Gatling gun out-shot everything else under consideration, and successfully met dispersion trials against artillery loaded with grape.

The United States Navy on 30 May 1868, concluded its trials on both the caliber .50 and the 1-inch guns at the Navy Yard, Washington, D.C. The weapons performed in such a creditable manner that the improved model was recommended to replace the few obsolete caliber .58 rim-fire Gatlings that were on hand. A letter praising the weapon's over all performance was sent on that day to Gideon Welles, Secretary of the Navy, apprising him of these facts. The board, appointed by the Navy's Bureau of Ordnance, concluded its report by saying that to its knowledge, the gun tested by them had no superior.

### International Acceptance of the Weapon

Shortly after the adoption of the 1865 model Gatling by the armed forces of this country, the weapon was manufactured in Europe by the Messrs. Paget & Co., Vienna, Austria, and the W. G. Armstrong Co., Newcastle-on-Tyne, England. These firms made the guns with 10 barrels, which were chambered to whatever musket cartridge was used by the various governments. Some of the off sizes included a caliber .65 using a solid  $3\frac{1}{4}$ -ounce bullet, and a caliber .75 with a lead projectile of  $4\frac{1}{2}$  ounces. All were 10-barrel guns, the only exception being the 1-inch model which was made in both 6- and 10-barrel sizes.

Some of the European governments, in order to prove certain tactical points, subjected the weapons to most unusual competitive events. For instance, in Carlsbad, Baden, in 1869 there were pitted against the rifle-caliber Gatling, 100 picked infantry soldiers, armed with the celebrated needle gun and trained to fire by volley. The machine gun was to fire the same amount of ammunition as the 100 riflemen at a distance of 800 meters. The results showed that the Gatling put 88 percent of its bullets into the target, while

the soldiers succeeded in scoring only 27 percent hits. Doubtless the difference would have been even greater had the firing taken place during the heat and smoke of battle.

Even after such a show had clearly demonstrated the Gatling gun's superiority as a death-dealing instrument, its general acceptance was not too enthusiastic. The *London Times* accused the Russian Government of making "undue haste" in adopting this American invention, and ordering a number of guns without even more rigorous trials than had already been conducted.

British distrust of the Gatling at this particular time was due to stubbornness in demanding that all tests be conducted with the famous Boxer cartridge, invented in 1865 by the then Chief of British Ordnance, Colonel Boxer. This was far inferior to American ammunition. The Boxer cartridge case, instead of being made of solid drawn copper, was formed by rolling a thin brass plate around a mandrel, and after soldering, at-

taching an iron base to it. The bullet had a hollow base with a clay plug. Later, for stability at long range, the clay was replaced with a wooden plug. In 1866 the Boxer cartridge was officially adopted as the standard ammunition of all the English armed forces. The persistence of English authorities in conducting tests of highly efficient manually operated machine guns with this outmoded ammunition led to many failures through no fault of the weapon.

During the first Gatling trials in England, the Boxer cartridge was used. On every burst attempted, the extractor, at some point in the firing, invariably tore the head off the cartridge and left the remaining brass in the chamber to block the incoming round and jam the gun.

At later trials in Vienna, continued malfunction was caused by the use of ill-fitting ammunition. The Gatling gun, which had been advertised as firing 300 to 500 shots a minute, barely succeeded in doing more than 200 a minute.

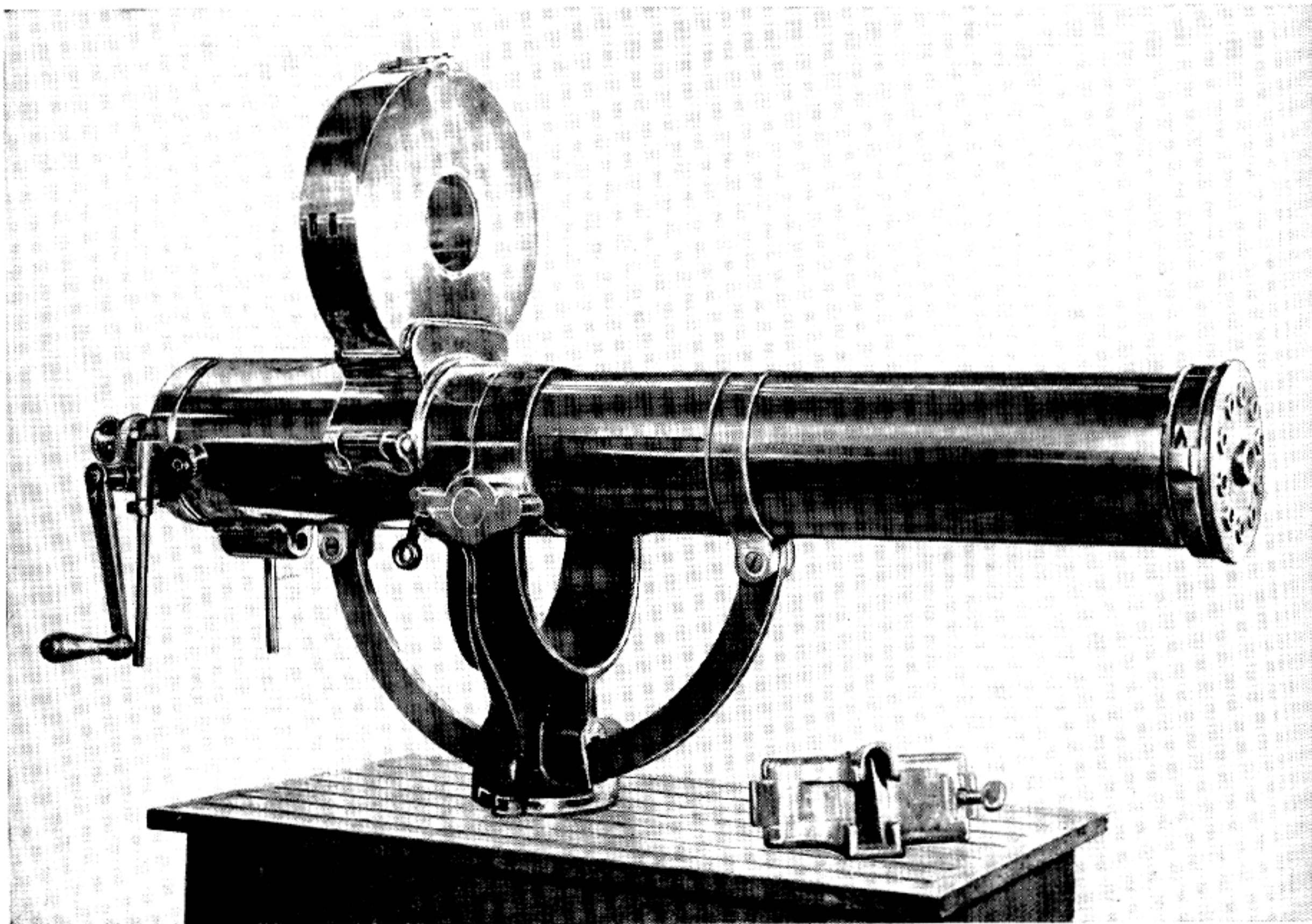

Gatling Gun, Model 1883. Ten-Barrel, Cal. .45, with Accles Feed Drum.

However, any time reliably constructed ammunition was used, the weapon's performance was equal to, and sometimes beyond, the claims of its promoters.

When the British finally developed cartridges suitable for the Gatling, they ordered a demonstration at Shoeburyness. There they put the gun in competition with everything and anything that could be mustered; all ranges and various sizes of targets, both stationary and moving, were included. It was concluded that the arm in no way matched certain types of field guns, but that no artillery branch of an army would be complete without Gatlings as auxiliary or supporting weapons.

Although almost ignored in the Civil War and practically untested in battle, the Gatling slowly but surely impressed observers of all nations that, when used with suitable ammunition, it was the most reliable firing mechanism yet designed. Its drum-type gravity feed was improved by the invention of a positive cartridge-positioning device by James G. Accles of Hartford, Conn. This corrected a feature in the gun's design that had heretofore limited the angle of fire.

The Gatling Gun Co. sent expert operators to every part of the world. In their enthusiasm to put on a good show, they have been known to set up their guns against the enemy of a prospective customer and repel a charge, just to show its effectiveness as an instrument of annihilation.

After the United States Navy and Army had adopted the Gatling, in 1862 and 1866 respectively, the French successfully used a few in the Franco-Prussian War, while the much publicized rapid-firing weapons of European origin were being proved utter failures. For more than 40 years thereafter, the Gatling was used by practically every major power and influenced world events in no small manner.

The Colt Co.'s greatest feat of salesmanship was in Russia. That government, one of the first foreign powers to adopt the Gatling (1871), sent General Gorloff to Hartford as head of a mission to witness the construction of the weapons, and, if thought advisable, to purchase an additional number. They were to be chambered for the Russian infantry rifle cartridge. Four hundred guns were made and delivered in less than a year, but not until each gun was stamped in Russian

with Gorloff's name, since he had supervised their construction. Years later Gatlings were manufactured in Russia's own arsenals, but under the Gorloff name. Finally, when the Russo-Turkish War came, the Russians were fully equipped with Gorloffs. The Turks had the same weapons, but theirs were called Gatlings.

### Performance and Improvement During the Nineteenth Century

The endurance of the Gatling gun seems almost phenomenal when judged by modern standards. On 23, 24, and 25 October 1873, at Fort Madison near Annapolis, Md., 100,000 rounds of center-fire caliber .50 ammunition were fired from one gun to test not only the durability of the 1865 model gun, but also the quality of the cartridges. Lt. Comdr. J. D. Marbin supervised these trials under the auspices of Commodore William Nicholson Jeffers, Chief of the Navy Bureau of Ordnance. Excerpts of the official report are given below:

"October 23, 10:33 a. m., commenced firing in the presence of Chief of Bureau of Ordnance and others. Ten drums, each holding 400 cartridges (making 4,000), were fired rapidly, occupying in actual time of firing ten minutes and forty-eight seconds. The firing was then discontinued to witness experimental firing of the 15-inch Navy rifle. The firing of the Gatling gun was resumed in the afternoon, when some 28,000 cartridges were fired. Commenced firing at 8:50 a. m., October 24, the gun having been cleaned.

"One hundred and fifty-nine drums, of 400 cartridges each, making a total of 63,600 cartridges, were fired without stopping to wipe out or clean the barrels. At the close of the firing, which extended over a period of five hours and fifty-seven minutes, although the actual time of firing was less than four hours, the barrels were not foul to any extent; in proof of which a very good target was made at 300 yards range before cleaning the barrels. On the 25th day of October the remainder of the 100,000 cartridges were fired. The working of the gun, throughout this severe trial was eminently satisfactory, no derangements of any importance whatever occurring."

Colt representatives sold the rifle-caliber guns,

with the improved feed, to Egypt, Morocco, China, Japan, and practically all South American countries. However, it remained for Britain to give the gun more world-wide use in its empire building than any other nation had done. It not only adopted the weapon as the first-line machine gun for its army and navy, but manufactured Gatlings under royalty rights from the Colt Co. In fact, the gun was looked on so favorably by English authorities that it paved the way for the long list of American inventors who have since designed machine guns for the British Empire (there being no record of an Englishman designing any that were officially adopted by his own government).

As other gun designers attempted to encroach on Gatling's world market, he boldly stood his ground. An English publication in September 1881 carried the following:

"A CHALLENGE.  
"THE GATLING GUN."

"Recently many articles have appeared in the press claiming superior advantages for . . . other machine guns over the Gatling system. In order to test the question which is the better gun, the undersigned offers to fire his gun (the Gatling) against any other gun on the following wagers, viz:

"First—£100 that the Gatling can fire more shots in a given time, say one minute, than any other gun in the world.

"Second—£100 that the Gatling can give more hits on a target, firing, say one minute, at a range of 800 or 1000 yards, than any other gun.

"The winning party to contribute the wagers won to charitable objects.

"The time and place for the trials to be mutually agreed upon. Trials of the above character will do more to determine the efficiency of the guns than newspaper articles ever so cleverly written.

"(Signed) R. J. Gatling  
*Of Hartford, Conn., U. S. A.*"

The English Navy used Gatlings against the Peruvians in 1877, put them ashore against the Zulus in 1879, and at Alexandria in 1882. Historians claim the British Christianized the uncivilized world with the Gatling. In fact, it,



General Custer, Who Left his Gatlings Behind When He Met Sitting Bull at Little Big Horn.

more than any other weapon, helped change the odds in their favor during their days of empire building.

The United States, however, was in the midst of peace. There was nothing to warrant the expenditure of ammunition except an occasional Indian uprising, which was suppressed by the regular army. The old-line military men were still not inclined to accept anything as revolutionary as the Gatling. Although it is recorded that each detachment in the field had several of these guns on its allowance list, nothing can be found to show their use in the Indian warfare of the Western plains.

For the purpose of conjecture and discussion, it should be noted that when Gen. George Custer's entire troop was annihilated at Little Big Horn in 1876, his headquarters had on hand four of the 90-pound Gatlings having a rate of fire of 1,000 rounds a minute. These perfected weap-

ons were designed especially for animal transportation, and could be fired from horseback or from the ground on a tripod mounting. They were chambered for the Army standard caliber .45-70-405 infantry center-fire rifle cartridge. Had General Custer taken with him only one of the four that were available, the phrase "Custer massacre," so well known to every school child, would have had a reverse meaning—as one can hardly visualize a more perfect target for a tripod-mounted machine gun than a band of Indians galloping in a circle.

Conditions remained about the same until the war with Spain in 1898. Then, for the first time, American troops fired a Gatling gun at a foreign enemy. This event might well have never taken place had it not been for the audacity of one man, Capt. John H. ("Gatling Gun") Parker. Having recognized the potentialities of this new kind of weapon, he asked that he be allowed to organize a Gatling unit against the Spaniards at Santiago in Cuba. His immediate superior opposed Parker's plans. However, he carried the

request to the commanding officer, Gen. Joe Wheeler, who not only liked the suggestion, but directed Parker to get together the proper men and equipment to operate and maintain the guns.

Parker's effective work against the enemy is a matter of history. As a result of his theories on the employment of the machine gun, the high command of the Army commissioned him to "devise a form of organization for machine guns to be attached to regiments of infantry." For the first time, 36 years after the Gatling was used by General Butler, the Army recognized the value of the weapon in offensive warfare, and gave it a place in future planning.

Machine gun development owes much to Parker, for he organized with great foresight, laying the groundwork of tactical application, and creating in the military a place for future weapons of such a nature. Were it not for Parker, it is quite possible that the Gatling, first-line machine gun at the time of all the major powers in the world, although conceived, developed, and



Gatlings at Baiquiri Just before Starting for the Front in the Spanish-American War.

perfected here, could have been declared obsolete by this country without firing a shot against a foreign foe. The weapon was finally abandoned and its manufacture discontinued in 1911, after surviving its inventor by 8 years.

The 37 years that Gatling lived, following the official adoption of his gun by the United States, were spent as head of the Gatling Gun Co. (a section of Colt's Patent Fire Arms Co., Hartford, Conn.), where he constantly sought to keep the weapon ready to meet changing conditions.

In 1871 Gatling patented his first improvement on the gun, namely, the introduction of a center-fire firing pin. In the next year he was granted a patent on general improvements allowing him to reduce the size and weight of the gun. This patent covered most of the features of his caliber .45 camel gun, so called because it could be easily transported on mules, horses, or camels, and was useful in mountainous desert countries. The gun had 10 barrels, weighed 125 pounds, and fired at a rate of 600 rounds per minute. An automatic traversing mechanism was described, but not claimed in this patent. The patent also shows an alteration in the breech housing to facilitate the use of the drum-type gravity feeder. The feeders came in two sizes, holding 200 and 400 rounds. The heavy guns were equipped with two of the large drums.

In 1873 Gatling patented his automatic traversing mechanism. The same year he began experimenting with a five-barrel model with a direct-drive crank in the rear replacing the side crank with reduction gears.

In 1875 the Springfield Armory issued a pamphlet with field instructions for maintenance and use of the weapon. In this handbook, under the heading *Precautions*, it was noted that the headspace of the gun was customarily adjusted to the ammunition to be used before being issued to the service. In the event this critical measurement was changed, through use or disassembly, and the weapon started separating brass from excessive headspace, a simple field adjustment could put it back in safe operation. By removing the front cover, and tightening the adjusting screw on the front of the main shaft, headspace could be shortened, allowing a minimum clearance for freedom of action between rotating barrels and breechblock. If a case should rupture

during firing, or a block should fail on any barrel, there came as standard equipment with every gun a steel insert that would prevent an attempt to feed the fouled chamber and eliminate jams, while permitting the remaining chambers to function.

The same handbook cautioned the man in the field to limit bursts to 10 minutes, or 4,000 rounds. It had been observed that a burst of this duration was sufficient, by color test, to heat the barrels to a point where ammunition in the feed might be exploded from contact with the hot mechanism.

In 1876 the Gatling gun received the only award for machine guns at the International Exhibition in Philadelphia. The gun shown there was a 5-barrel one using a caliber .45 infantry rifle cartridge. It had a traversing mechanism that, at the choice of the gunner, could either fire at a single target or spread its field of fire automatically over a large lateral area. The weight of this gun was a little over 90 pounds. It fired sustained bursts at 700 rounds per minute and short bursts at 1,000 rounds per minute. At this time the Colt Co. was also making a 10-barrel model with all the improvements of the smaller gun.

By 1880 Gatling was getting fire at a rate of 1,200 rounds per minute from his light gun. Three years later, James G. Accles, an employee of the Gatling firm, patented what has since been known as the Accles feed. This made the weapon even more reliable, and is the grandfather of the drum feed we know today.

In 1886 Gatling developed a new type of gun alloy, composed of steel and aluminum, which was successfully adapted to gun manufacture. In this case, like other inventors of the era, Gatling was forced by popular demand into a field in which he had no business.

About this time Congress granted him \$40,000 to develop a method of casting large steel gun barrels in one piece. An 8-inch cannon was made at the Otis Steel Works, Cleveland, Ohio, and taken to Sandy Hook Proving Ground to be test fired. On the first shot, the gun blew up. Gatling called on an astronomer-mathematician, John Stockwell, to explain the accident. This choice was indeed a wise one, because Stockwell's report was such a mass of scientific confusion and improbable probabilities that Gatling was given the

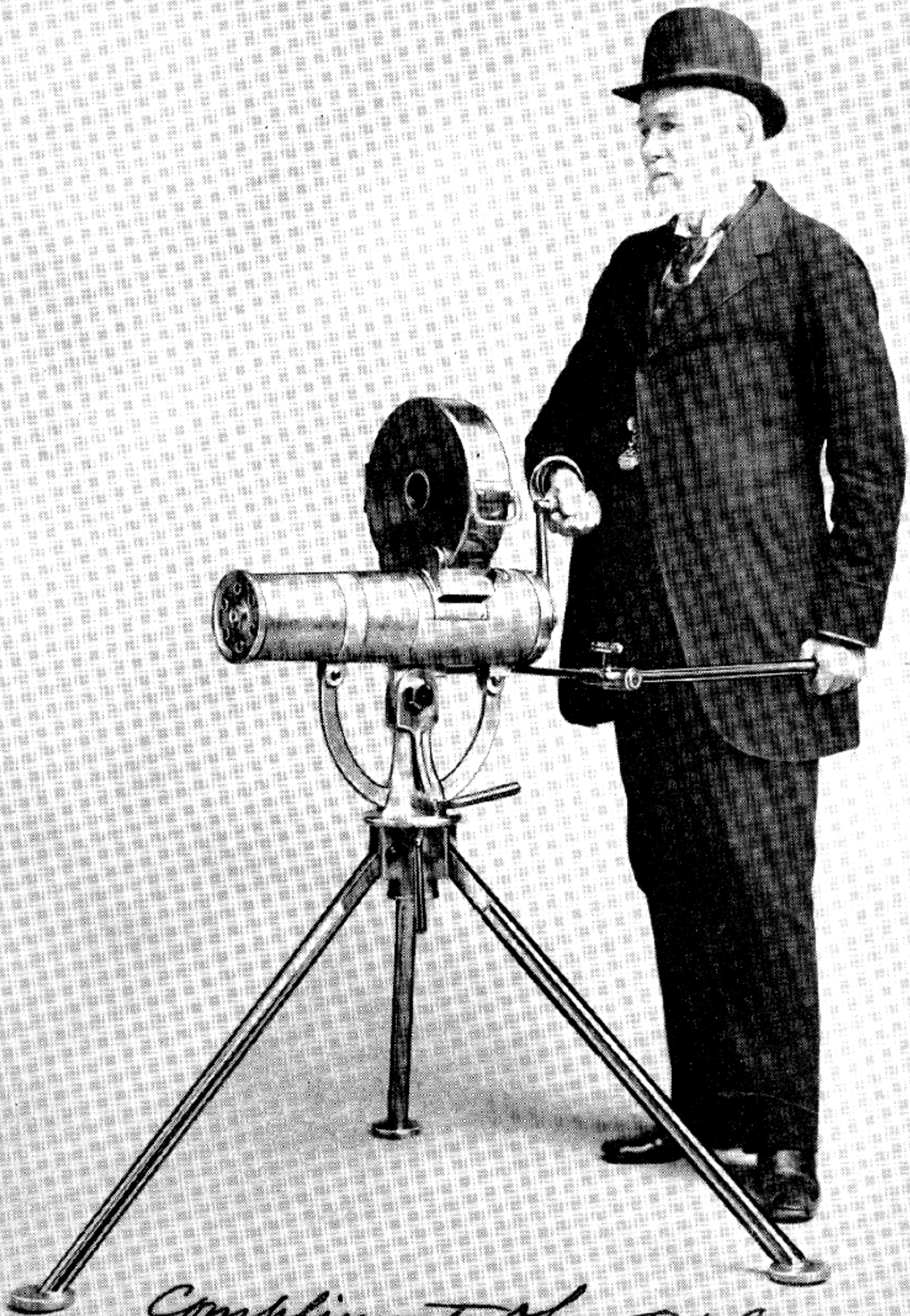

Compliments of R. B. Gatling  
Hartford, May 1st 1893.

WAR DEPARTMENT  
OFFICE OF THE CHIEF OF ORDNANCE  
WASHINGTON

April 18, 1914.

In reply refer to No.

37888/3038

Mr. W. H. Ireland,  
4124 Second Avenue,  
Pittsburgh, Pa.

Mailed APR 18 1914

Sir:

1. Referring to your letter without date, received April 16, 1914 (O.O. 37888/3034), requesting information as to the make of gun in this or foreign countries possessing the greatest rapidity of fire, I am instructed by the Chief of Ordnance to inform you that no gun has ever exceeded the rate of fire of the Gatling gun, motor driven. It is understood that with this gun a rate of fire of 3,000 rounds per minute from its ten barrels is possible.

2. The greatest rate of fire from a single barrel is possessed by the automatic gun manufactured by the Vickers Company which will fire from the single barrel approximately 800 rounds per minute.

Respectfully,

*Rw*

L T HILLMAN

Major, Ord. Dept., U.S. Army.



benefit of the doubt, and the whole thing forgotten.

In 1886 L. F. Bruce, also employed by the Colt firm, received three patents on a gravity-type vertical feeder for use with the light model gun. The novel feature of this feeder was that ammunition could be loaded into it just as it came packaged from the factory. To load, the operator removed the top of the box and in one motion could insert all 20 rounds.

Two patents were granted Gatling in 1893 for a flat strip type feed and for a rifle caliber gun with an electric motor built into the rear of the gun casing. The motor could be detached and replaced by a hand crank should no power be available.

By this time the Gatling gun was totally obsolete, because the word "automatic" was now part of the ordnance vocabulary. Gatling, still a man of determination, proved his vision by designing this built-in electric motor drive. The gun was chambered for the smokeless caliber .30-40 Krag-Jorgensen rifle cartridge.

The power-driven weapon in tests was fired at the phenomenal rate of 3,000 rounds per minute. Production of a reliable mechanism capable of this terrific volume of fire placed Gatling's design as far ahead in the power-driven field as his reliable hand-cranked gun had been with respect to the manually operated weapons of 1865.

As a final defiant gesture to the "full automatic" trend, a device was designed in 1895 for eliminating the electric motor and converting

Gatling machine guns to automatic. It did not entirely eliminate the hand crank, but depended on it only to scar off the first round. Thereafter, the gun became gas-operated in the following manner: A spring loaded pivoted lever was mounted on the front of the gun housing. Near the muzzle of each barrel there was a gas orifice. Upon firing the initial round, the orifice of the discharged barrel was positioned against the lever. This allowed the gas to bleed through this vent driving the lever down. The lever, upon being returned by its spring, indexed the gun through a ratchet assembly bringing the next barrel into position to be fired. This permitted a constant rate of fire to be obtained by correlating the size of the gas orifice with the spring pressure on the lever arm.

No automatic Gatling, either electric or gas operated, was ever accepted by the armed forces of the Nation. However, the crank-operated guns were rechambered for the latest model cartridges caliber .30-40 and .30/06, and the Colt firm continued to produce them until they were declared obsolete by the United States Army in 1911. James Accles, inventor of the feed, went to England, became associated with Shelldrake Arms Co., of Birmingham, and continued to produce the gun.

Gatling lived to see his weapon progress from loose powder and percussion cap to primed metallic ammunition, from black to smokeless powder, and from hand crank to electric drive and thence to full automatic.

## MITRAILLEUSE TYPE WEAPONS

The successful employment by the Confederates of light cannon firing grapeshot caused a wave of inventions to correct the greatest weakness in this method of using artillery. The cannon were smooth bore, and, like fowling pieces, had limited accuracy. The gunner had little or no control over the placement of the individual grapeshot.

The inventors reasoned that if there were 50 balls in a charge or canister, and 30 were wasted in the scatter effect, a concentrated accurate fire, using an equal number of projectiles, would be even more deadly than the already revolutionary tactics of Generals Gorgas and Bragg.

Developmental approach was along two lines, representing separate and distinct schools of thought. One was the volley system, strongly favored by European armies, whereby a number of barrels were grouped in a plane, parallel or in stacks; and could be fired simultaneously and reloaded rapidly. The other viewpoint, strictly American, employed one or more barrels that did not fire simultaneously, but instead developed a high rate of fire from simplicity of action. In lieu of the volley, it fired in rapid succession a veritable stream of bullets.

To impress military authorities and advertise an improved means of delivering the universally used grapeshot, European inventors called their firing mechanisms "mitrailleuse," meaning "grapeshooter," or more literally "grapeshot shooter." By this name they hoped to imply that theirs was a system for controlling the dispersion of grapeshot.

The general principle was not new. It appears to have been invented originally by Captain Falschamps of the Belgian Army in 1851. His rough prototype and finished mechanical drawings were offered to Joseph Montigny. This noted Belgian engineer and armorer had his factory at Fontaine l'Eveque, and a branch of his gun business at Brussels.

Later, Montigny constructed some guns of this kind for the defense of the Belgian fortifications. In 1867 he persuaded Emperor Napoleon III of France to introduce the improved Falschamps gun (now bearing Montigny's name) to the military authorities. Napoleon III was so impressed with the gun that he ordered its manufacture under great secrecy by Commandant de Reffve at the arsenal at Meudon. Montigny had been aided by Louis Christophe, another Belgian ordnance engineer, who added some unique features.

The Montigny gun consists of 37 rifled barrels contained in a wrought iron tube, loaded by an iron plate bored with 37 holes corresponding in position and diameter to the barrels. A cartridge is inserted in each hole of the loading plate. The firing mechanism is operated by a hand crank, one turn of which in a clockwise direction fires all 37 rounds in less than a second. If the gunner prefers, each barrel may be fired alternately at any speed desired. The average rate of fire by a competent crew has been recorded as 12 bursts, or 444 shots a minute.

When the loading plate is dropped into position, the encased cartridges are aligned with their chambers. Grooves formed on the face of the breechblock receive the plate which, upon being dropped into it, is guided by the advance or withdrawal of that piece.

With the cartridges in place, the gunner rotates the loading crank with his left hand. The breechblock advances, pushing the plate forward until the projectiles enter their appropriate barrels. The plate serves as firing chamber. By this act of locking the weapon, the spring-loaded firing pins are brought back to the seared position, ready for firing. As it cannot be cocked until the weapon is securely locked, accidental discharge is impossible. The neck of the cartridge case ex-

tends into the barrel just enough to form a tight seal preventing gas leakage.

The gunner now quits the loading crank and takes his position by the firing crank at the right side of the gun. He can fire all of the barrels by one swift turn, or slowly space each shot as he sees fit. When the last barrel has been discharged, the operator backs off the loading crank, opening the breech. He then reverses the firing crank, returning the scar, and withdraws the empty cases from the barrels by means of the plate, which now performs the function of an extractor—or rather 37 extractors in one. The plate is then lifted from the positioning grooves carrying with it the empty cases, and is replaced by one filled with loaded cartridges ready for repeating the operation.

A clever device on the gun trail enables the ordnance man in charge of loading to clear and reload the plate very rapidly. It consists of a row of pins matched to the holes in the loading plate. The plate is placed over these holes, and by pushing down on a hand or foot lever the pins are jacked sufficiently to free them. The cartridges are then put in the empty chambers, and the plate is ready to be returned to the gun. Use of several plates was recommended for each gun to eliminate any loading lag.

The weapon weighs in the neighborhood of 2 tons, with limber and 2,100 rounds of an especially designed Chassepot ammunition. This cartridge, used in the French version, is composed of a heavy paper case with a brass base, a powder charge, conical bullet and center-fire cap filled with mercury fulminate. The case features a cone-shaped collar that holds the bullet more securely in place. A light coating of tallow over the entire cartridge helps preserve the round. The over-all length of this ammunition is  $4\frac{1}{16}$  inches. It carries a bullet weighing 776 grains and 185 grains of propellant, topped by a felt wad. The powder is formed into cylindrical pellets.

Commandant de Reffye made some corrections on the working drawings. For this reason the weapon has often been called the de Reffye mitrailleuse. The barrels were reduced in number from 37 to 25, the Medford type rifling was adopted, and the ammunition changed from an ill-designed cartridge to the Chassepot, at the

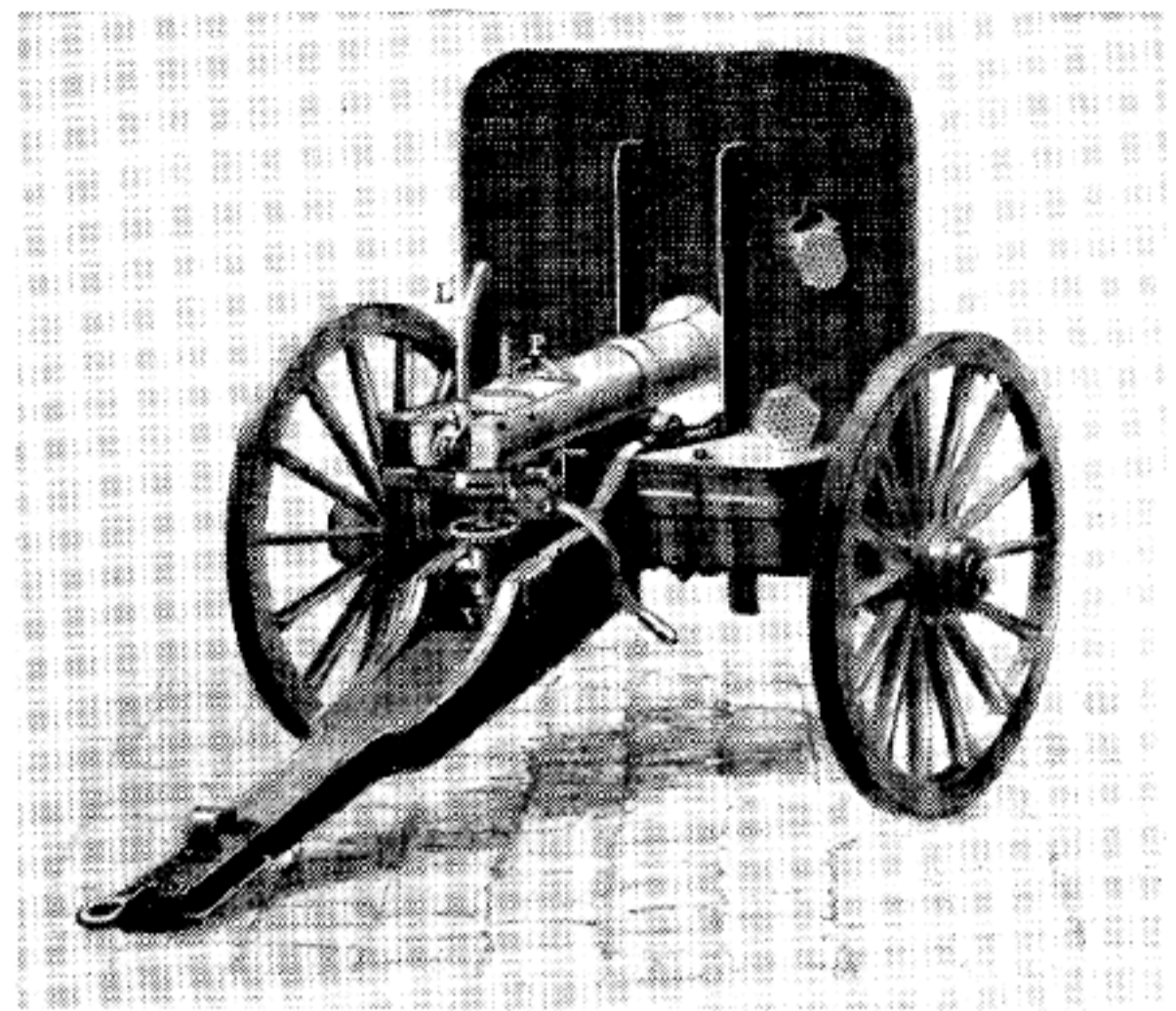

Montigny Mitrailleuse, a Belgian-Designed Volley Firing Gun.

suggestion of Major Fosbery of the British Army.

From the arsenal, where the weapon was being produced with much security, came fantastic stories of France's terrible secret weapon. Only the officers and men who worked on its production were ever allowed to see or handle it. When one was completed, it was moved from the factory to storage under tarpaulins and accompanied by armed guards. This air of mystery gave the French press a field day. Stories appeared regularly, intimating the weapon was capable of doing just about anything desired by the military.

The fantastic publicity was intended to intimidate their victorious Prussian neighbors, whose surprising military success over Austria, in 1866, had been due in great measure to a new infantry weapon, the bolt-action needle gun, a product of the German inventor, Johann Nikolaus von Dreyse (1798-1868). All Europe suddenly became aware of this rifle, and muzzle-loaders were eliminated, either by substitution of new models or by conversion from muzzle- to breech-loading.

France had attempted to supply her infantry with the Chassepot rifle, her answer in the armament race, but had found it impossible to restock the army quickly enough to prepare for coming trouble. The political events of 1867 foreshadowed the Franco-Prussian conflict. Napoleon III sought desperately to overcome the

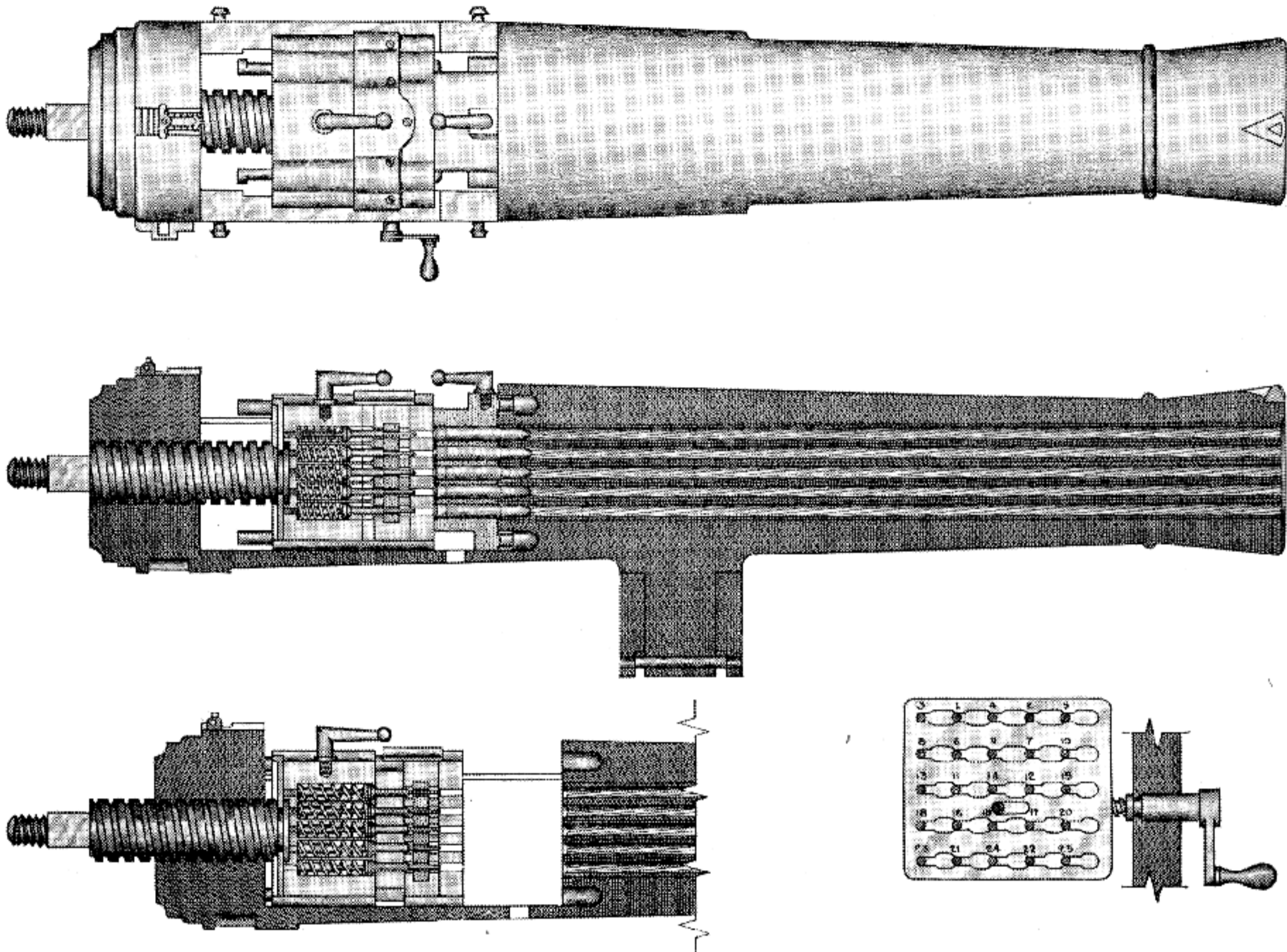

De Reffye Mitrailleuse, a 25-Barreled Version as Modified by the French Ordnance Officer.

German arms supremacy. He felt the morale of the French army had been endangered by the achievements of the Prussians with their Zundnadelgewehr (needle gun), and required some strong stimulus to regain prestige. His attention had been called to the Gatling gun, but national pride rebelled at accepting a foreign weapon. However, when he saw the weapon on exhibit at the Paris World's Fair of 1867, he had it withdrawn to Versailles to be tested in his presence. Presumably this weapon embodied Gatling's 1865 improvements, but the French ammunition was of inferior design. The tests were unimpressive; and the Montigny mitrailleuse, already adopted, continued to be ordered as the standard French equipment, 190 being in service at the outbreak of hostilities 3 years later.

The Franco-Prussian War proved the downfall of the weapon. Too many separate opera-

tions needed to be done by hand, and in sequence, any one of which, if neglected, would prevent the gun from firing. The firing crank must be reversed after the loading crank has pulled back the breech, otherwise the gun would not sear. The loading crank must then close the breech after the replacement of the loading plate with discharged cases by one filled with complete rounds. Where the Gatling depended on steady rotation of a single crank, its French competitor required constantly changing operations: forward and reverse rotation of two separate cranks, and a pause while the loader removed and replaced the loading plate between each 25 shots. Contemporary foreign writers commented on this complexity and marveled that the French, who usually insisted on simplicity above all else in their guns, should have adopted such a weapon.

If the mitrailleuse had been used against rifle fire, it might have been successful, for it was shooting rifle ammunition and had only a small arms range. However, the military command insisted on matching it against field artillery where it was completely outclassed.

Though the first engagement using mitrailleuse, on 2 August 1870, at Saarbrücken was a mere skirmish, it was glowingly publicized as a devastating victory for the new weapon. Later battles, however, proved disastrous. The open location of these guns made them conspicuous targets, and they were quickly put out of action by Prussian artillery fire.

Apparently the secret weapon had been concealed only from the French. The rest of the world had accurate information about it, and the enemy had profited by devising effective countermeasures. Even during the first battle, with only a few hundred Prussian infantry pitted against a complete French division, the Germans deployed themselves in extended skirmish lines, and offered the worst possible target for machine-gun fire.

At Wissembourg 2 days later, the mitrailleuse was matched against the field guns of the Prussian Eleventh Corps advance guard. The French position at the Château of Geisburg was under fire. A battery of mitrailleuse was brought up and positioned on an unprotected knoll. It was immediately spotted by the Prussian artillery. One of its ammunition wagons was blown up by enemy shell fire; and the commanding general, Douay, was mortally wounded, after which the battery was withdrawn.

The army, in spite of these lessons, continued to bring its mitrailleuse into action side by side with field pieces. Naturally, the Krupp guns had little difficulty in destroying them. The Parisian newspapers, however, continued to lull the French with imaginative pictures of the enemy being mowed down by this weapon like grass before a scythe.

Whenever the gun was used as a reinforcement for infantry, it was successful, but these occasions were given little publicity. It had been mounted as a field gun, and was too heavy for the infantry, which insisted on treating it as artillery.

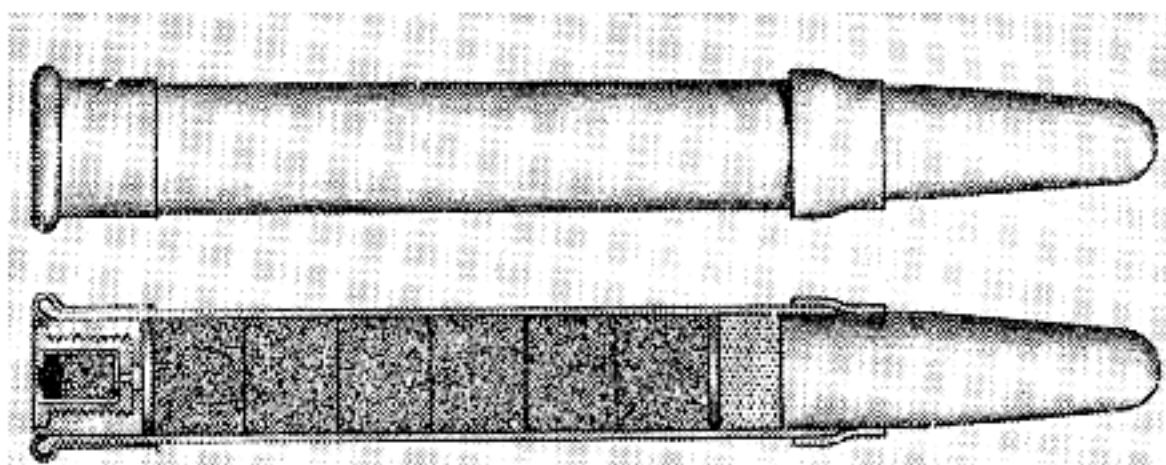

The Chassepot Rifle Cartridge that Was Used in the Mitrailleuse.

Even Major Fosbery, in a contemporary paper, discussed the chances of a duel between a field gun and the French mitrailleuse. He contended that "if both were loaded, and the first shot from the gun failed to smash the mitrailleur, the gun could not be loaded a second time; nor would a horse or a man belonging to it survive the first minute's practice from the weapon opposed to it." However, the major granted this would be a very unusual circumstance, since the field gun could come into action at a distance beyond range of the machine gun.

On 18 August 1870, the first successful use of the Montigny weapons occurred at the Battle of Gravelotte. Here, they were placed with the infantry firing line, and protected by a cluster of trees. The Prussians suffered heavy losses. One battery of these weapons was responsible for the capture of the only field guns lost by the enemy during the entire war. The French did not analyze the victory and profit by its lessons. They did not recognize that success had been due to a difference in tactics.

Machine guns proved of little use to the French. Nearly half of their guns were captured by the Prussians at Sedan. The rest were shut up in the siege of Metz. Colonel de Reffye attempted to increase the supply by operating workshops for their manufacture along the Loire River. In the meantime foreign machine guns were purchased. America supplied Billingham's Requa battery and some Gatlings. However, few Frenchmen knew how to operate these weapons.

By January 1871, Gatling guns were successfully defending the plateau of Anvours and the river crossings. A few were also in trenches. Wherever the mitrailleuse machine gun was used from a protected spot and for short ranges, it was successful. In spite of this the French au-

thorities recognized but one fact: the weapon had been unsuccessful in 9 out of every 10 encounters. They ignored the factors that made the tenth use a success, and were defeated by their own secrecy, for they failed to correlate design and practical tactics.

There was another model, type IV, patented by Montigny and Christophe in 1872 after the French had lost the war. It simplified the locking, and was controlled by means of a jointed lever. This cut in half the time heretofore necessary for securing the breechblock in place, as the toggle joint lock could be opened and closed by two swift movements of the lever. The loading plate was reduced to  $1\frac{1}{16}$ -inch thickness in place of the heavier plate that had been drilled practically the entire length of the cartridge. By this time, however, the mitrailleuse was doomed, following its discreditable showing in the war with Prussia. Although 20 years were spent in its development until it appeared on the battlefield, it lasted less than a year before total failure in action gained it the dubious honor of being the shortest-lived rapid-fire weapon to be adopted by a major power. About all it contributed to the development of quick-firing weapons

is the name, "mitrailleuse," used to this day by the French when referring to their most modern machine guns.

The Feld (or Feldle) machine gun was also used during the Franco-Prussian War. It was employed by the Germans in the siege of Paris, in the Loire campaign, and at Orleans. It was a mitrailleuse type weapon of the Bavarian Army, but was not considered mechanically reliable. It had 24 barrels mounted in parallel rows, and worked by a crank handle, firing about 300 shots per minute. The extreme range was 1,300 to 1,400 meters. It used Bavarian infantry rifle ammunition. These cartridges were unsatisfactory for the purpose. The gun frequently jammed. The barrels overheated easily, warped permanently in their frame, and had to be replaced. The Feld gun's failure contributed to the general dislike for machine guns which prevailed in the German Army for many years after the war of 1870.

American gunmakers, nevertheless, continued to study the problem of sustained fire. Lacking the European prejudice fostered by the mitrailleuse, they came up with some effective hand-operated machine guns.

## FARWELL MACHINE GUN

A machine gun of novel design was originated by Mr. W. B. Farwell of New York City in 1870. This weapon, while quite odd from an operational standpoint, was similar in appearance to the many multibarrel guns that were introduced shortly after the Civil War. It was of very heavy metal construction and had four octagon-shaped barrels chambered for the black powder caliber .45-70 standard infantry rifle cartridge.

The operating mechanism consists primarily of an assembly of gear racks and heavy screw threads. It is actuated by the clockwise rotation of a handle located on the right side of the gun. Each barrel has its own individual bolt, having an upper and a lower rack attached to its rear end, through which the bolts are given a reciprocating motion by segmental pinions. At each revolution of the gear wheel the clutch causes the pin to engage temporarily the drive wheel to which is imparted a partial stoppage in the rotation movement. This pause takes place immediately after firing, thereby providing a time lag in case of a hangfire. The cartridges are fed by means of a box located over and to the

rear of the chambers. The ammunition container has four double-feed slots, or a set of two for each barrel. A peculiar arrangement called the shutter by the inventor is also incorporated in the feed system. Actuated by the bolt's retracting action, this device permits the dropping of a cartridge in the feed slot only when the bolt is far enough back to allow the positioning of the round for chambering.

When the feeder is loaded and latched on top of the gun, a double row of ammunition sits above the loading recess of each barrel. However, the rounds will not drop until the feeder is moved slightly to the right or left enough to create an opening greater than the over-all width of the case. When the weapon is firing, the shutter merely moves the feed box right and left as the empty loading recesses are opened by the rearward action of the bolt.

The operating mechanism is unusual in design, especially the locking and retraction methods. These novel features employ telescoping tubing both as bolt and breech lock. The inner

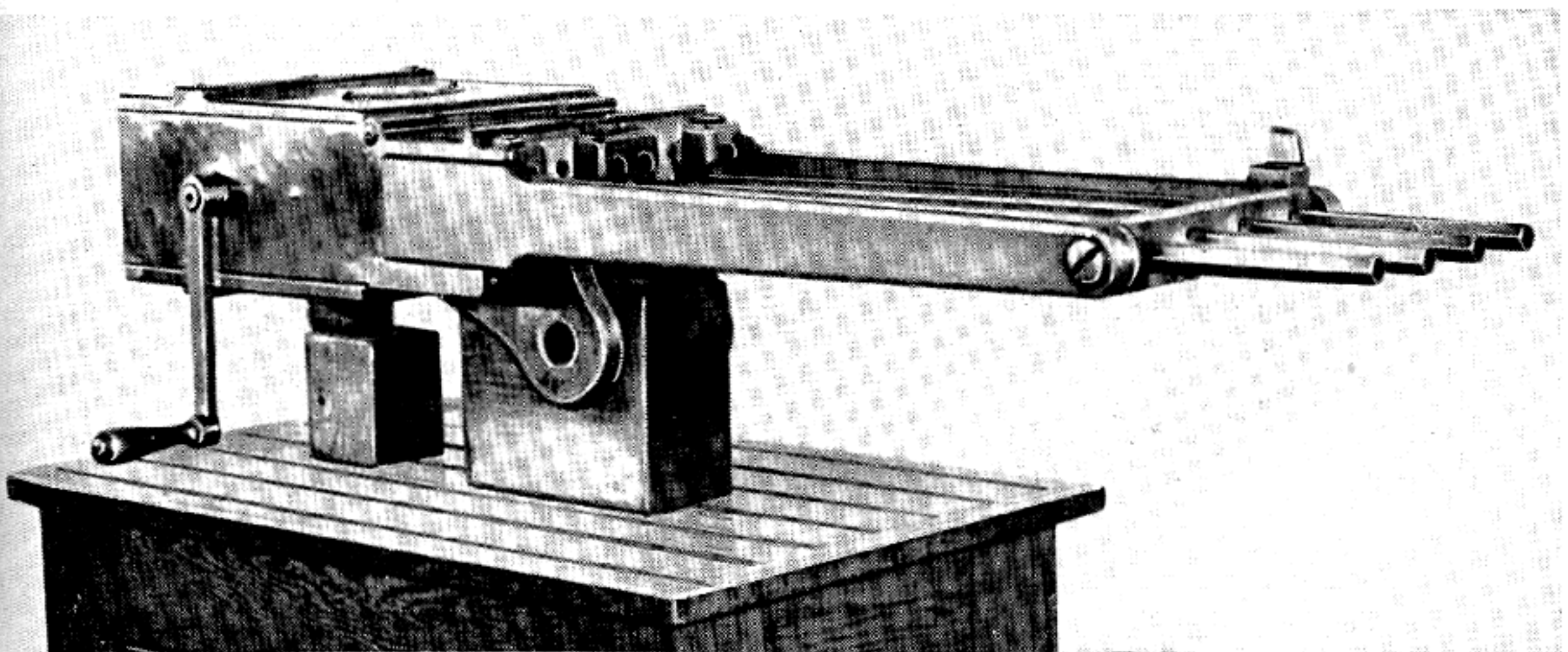

Farwell Machine Gun, Cal. .45 (Experimental Model).

tube carries the firing pin assembly and also serves as the final support behind the base of the cartridge when fired. The outer tube has a rotary rather than a longitudinal movement. It is provided internally with a screw thread which when revolved imparts the reciprocating action to the inner tube. The forward advance of the lower tube chambers the round and fires it while its withdrawal rearward extracts and ejects the empty cartridge case. The rate of fire is probably unusually low, since the actuation of the parts is dependent upon the screw thread method for reciprocating motion.

The weapon could be assembled and disassembled readily with all working parts easily removable for inspection or cleaning. The inventor claimed that, while firing, each barrel could be moved so as to give converging or scattered fire. The mounting of the large flat ammunition box made it necessary to incorporate an offset sight. It was the first appearance of a feature that was used extensively in later years. Only one of the guns was ever made. Since there were so many better weapons already in existence, no one could be interested in financing its production.



## HOTCHKISS MACHINE GUN

Benjamin Berkley Hotchkiss, born in Watertown, Conn., in 1826, served his apprenticeship and became a master mechanic at the Hartford plant of the Colt's Patent Fire Arms Co. He is credited with helping to design and perfect various models of the world-famous Colt revolver.

As early as 1856 he built a rifled field piece that was purchased by the Mexican Government. In 1860 he submitted to the United States Government an improved system of rifling and a new kind of percussion fuze for projectiles. The latter was adopted and was manufactured in New York City. Hotchkiss was placed in charge of the City Arsenal there during the draft riots of 1860.

Like so many other inventors of this time, Hotchkiss felt that his gun knowledge was not being given the recognition it deserved. Therefore, he went to France in 1867 and demonstrated an improved metallic cartridge case to replace the poorly designed paper ones used in the Chassepot rifle.

The French Government ordered the immediate manufacture of his cartridge case at St. Etienne. Hotchkiss was induced to remain in France, when orders were placed in advance for a machine gun he had in mind. Hotchkiss had a theory that the most efficient use of such a weapon could be obtained by combining the destructive forces of the explosive shell with machine-gun rapidity of fire. In 1871 he had developed his gun, a revolving cannon type, to such a point of perfection that it was hailed as a novel and successful weapon.

Four years later he organized Hotchkiss & Co., with offices in Paris and a manufacturing plant in the neighboring town of St. Denis. It was intended to make, not only the weapon itself, but the mounts and ammunition as well.

Hotchkiss had earned his first reputation in ordnance by designing artillery projectiles and systems of firing. From this background he pro-

ceeded to formulate what he considered the best caliber to produce maximum devastation on personnel while the arm remained light enough to be fired with great rapidity.

It is interesting to note that the St. Petersburg Convention in 1868 had specified 450 grams as the minimum weight of a projectile carrying explosives intended for antipersonnel use. This total included the projectile and bursting charge. To be on the safe side, Hotchkiss allowed himself 455 grams minimum. When he arrived at the proper caliber with bursting charge cavity of correct dimensions and a balanced fuze nose, he had a 37-mm projectile. So accurate were his calculations that, though Hotchkiss originated this dimension, it is still considered absolutely the largest projectile that can be fired with any semblance of machine-gun rapidity.

A pamphlet, prepared by the company in 1874, described the gun, its action and ammunition. The publication was incorrect, however, because improvements had been added to the gun during manufacture. The brochure, by this very fact, indirectly shows the rapid progress made by the factory. Early malfunctions were corrected and a reliable gun was turned out that was able to overcome the official prejudice against repeating weapons dating from the dismal failure of the Montigny mitrailleuse.

The Hotchkiss gun was primarily designed for flank defense. To perfect this feature, a peculiar modification was introduced. Each of the five barrels was rifled with a different pitch. This insured that the weapon, having once been correctly installed and aimed, would never require alteration, but could sweep the target area with a shower of shrapnel, 1,500 lethal fragments being obtained from a 60-round burst.

Although planned as an army gun, the introduction of the torpedo boat gave the Hotchkiss a chance to prove its usefulness to the navy. The appearance in 1877 of the high-speed torpedo

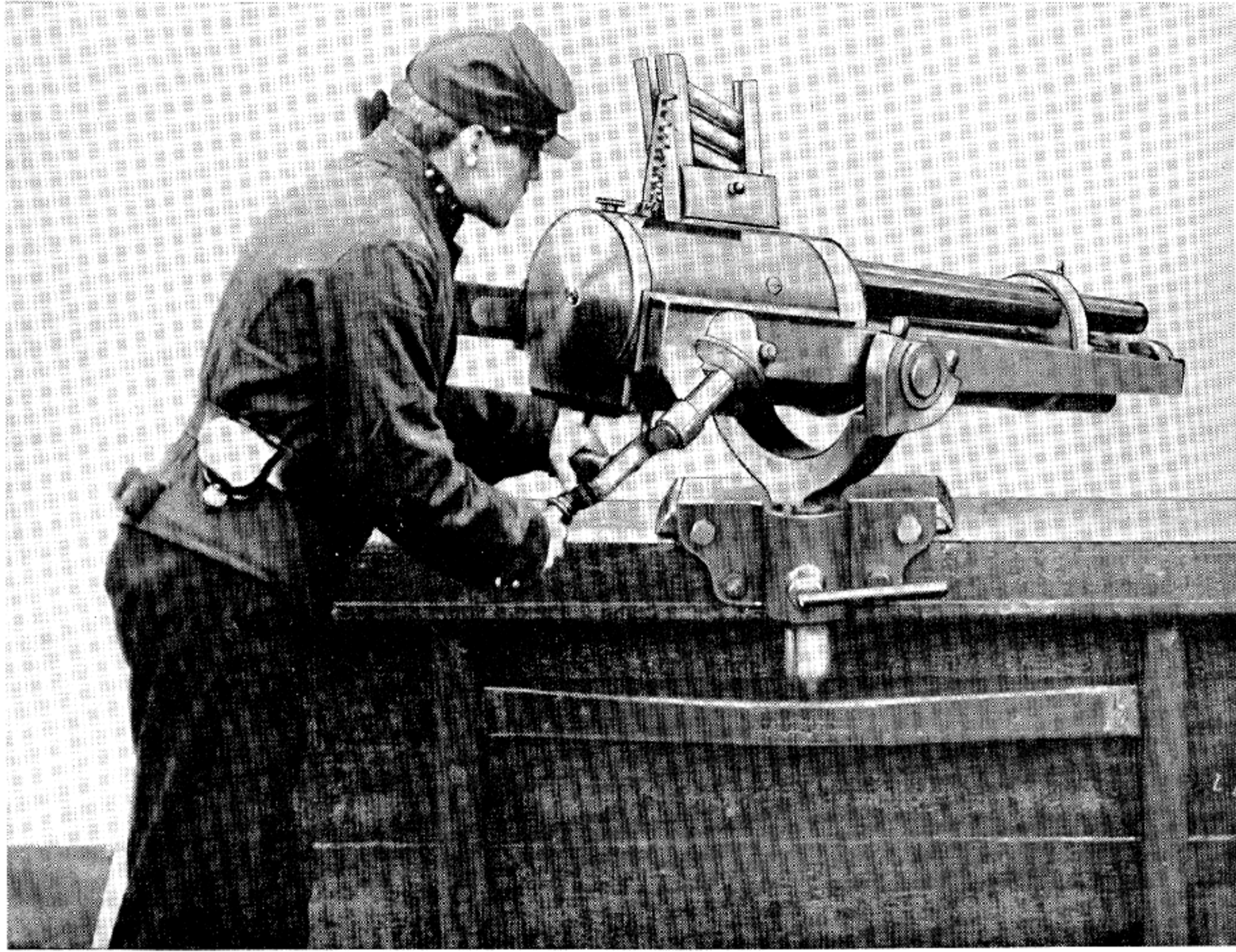

Hotchkiss 37 mm Revolving Cannon Mounted on Ship's Gunwale.

boat as a new weapon of naval warfare created the demand for a new type of gun for naval defense that would combine the highest degree of destructive power, rapidity of fire, quickness of aim, and reliability.

The Gatling had by this time been generally adopted by all the leading navies of the world, but the power of its solid lead projectiles was totally inadequate as a defense against the torpedo boats.

The English Navy felt that a gun of Swedish origin, on which it was conducting trials, would meet the new exigencies if the caliber were increased to an adequate size. However, the British discovered the general arrangement of the weapon was so unwieldy that if its total weight were limited to that of the Hotchkiss revolving cannon, it was necessary to make the projectiles

no larger than 1 inch (less than 26 millimeters). This precluded the use of an explosive shell under the terms of the St. Petersburg convention. This clearly illustrates Hotchkiss's foresight and engineering ability, for the Swedish gun was thus eliminated from competition in weight design. As the size of the torpedo boat increased, and its armor plate thickened, the need for the Hotchkiss and its explosive nose fuzed projectile became more apparent.

The French had been taught a bitter lesson in secret weapons by their stupid handling of the production and testing of the mitrailleuse. They were taking no chances with the Hotchkiss, which was making them again a power to be reckoned with. Although the nation was at peace and no immediate war was in prospect, ordnance writers agree that no French machine gun ever

received so thorough an investigation as did the Hotchkiss revolving cannon. Even though the weapon was considered reliable when adopted (and later events verified this conclusion), for 10 years the gun was fired at the French Naval Testing Grounds at Le Havre. During this period every possible point connected with the gun, or its ammunition, was exhaustively studied and reported. When this prolonged trial was finally ended, all the data covering the test were assembled and properly classified.

A mass of information was obtained that enabled the authorities to form a true and exact judgment, not only of the absolute value of the gun itself, but also of the comparative value of all other machine guns that were considered competitors.

Various models were constructed to suit the special requirements for which they were designed. These different types varied in ballistic features, weight, dimensions, and manner in which they were mounted; but the general system of the mechanism was common to all calibers.

Although the Hotchkiss revolving cannon bears a marked resemblance to the Gatling, the design is original throughout and has many peculiar characteristics found only in this gun. For instance, it has intermittent rotation of the barrels without turning the breech mechanism. The barrels remain stationary at the moment of discharge, thus suppressing the centrifugal motion normally imparted to projectiles at the commencement of flight when fired from a continuously rotating barrel. Extracting and initial loading take place simultaneously in other barrels during this pause. Also, the time lag is adequate to handle hang-fires safely. One firing pin and spring for discharging all barrels and a single loading piston give greater simplicity to the mechanism of the Hotchkiss. Therefore all parts could be made sufficiently strong and heavy to withstand the rough usage to which guns are subjected in actual service.

The shock of discharge is received against a massive, immovable breech, which distributes the force evenly to the whole system. This permits the employment of charges and projectiles whose only limits on weight and size are those dictated by the rapidity of fire. As further proof

of superb engineering, the weapon is so well designed that it can be completely disassembled and assembled without the aid of tools.

The Hotchkiss revolving cannon is composed of four distinct groups: (a) The barrels, (b) the frame carrying the trunnions and serving as a bearing for the forward end of the central shaft, (c) the breech containing operating parts, and (d) the actuating mechanism.

The five rifled barrels are made of compressed steel, which was thought to be the best metal for their construction. They are rigidly mounted parallel to each other around a central shaft, between two metal discs, and rest in the frame carrying the trunnions. They are rotated and controlled by means of a hand crank placed on the right side of the breech. The loading, firing, and extracting also are controlled by this mechanism.

The frame is composed of two channel-shaped beams carrying the trunnions. The rear end of the frame forms the rest for the breechblock which is carried by and fastened to the two parallel members.

The breech itself is cast steel, massively constructed to receive the impact of firing. Since it is very heavy, it absorbs the greater part of the recoil. The rear portion of the weapon contains the actuating mechanism, all of which is accessible through a latched door.

The mechanism for rotating the barrels and performing the functions of loading, firing, and extracting is composed of a crankshaft carrying a worm which works in a pinwheel on the rotating axis of the barrels. The worm is of irregular design, partially helical, partially circular, and during operation of the weapon it rotates continuously. The helical portion causes the barrel assembly to rotate  $72^\circ$ , from one indexed position to the next. The circular portion locks the barrels at indexed position, during which period there are three simultaneous actions, each in different barrels, loading, firing, and extracting.

A spiral cam, on the side of the worm, cocks and discharges the piece at the proper time by action of a lug on the firing pin bearing against the cam. Rotation of the worm retracts the firing pin against a leaf spring and allows it to fly

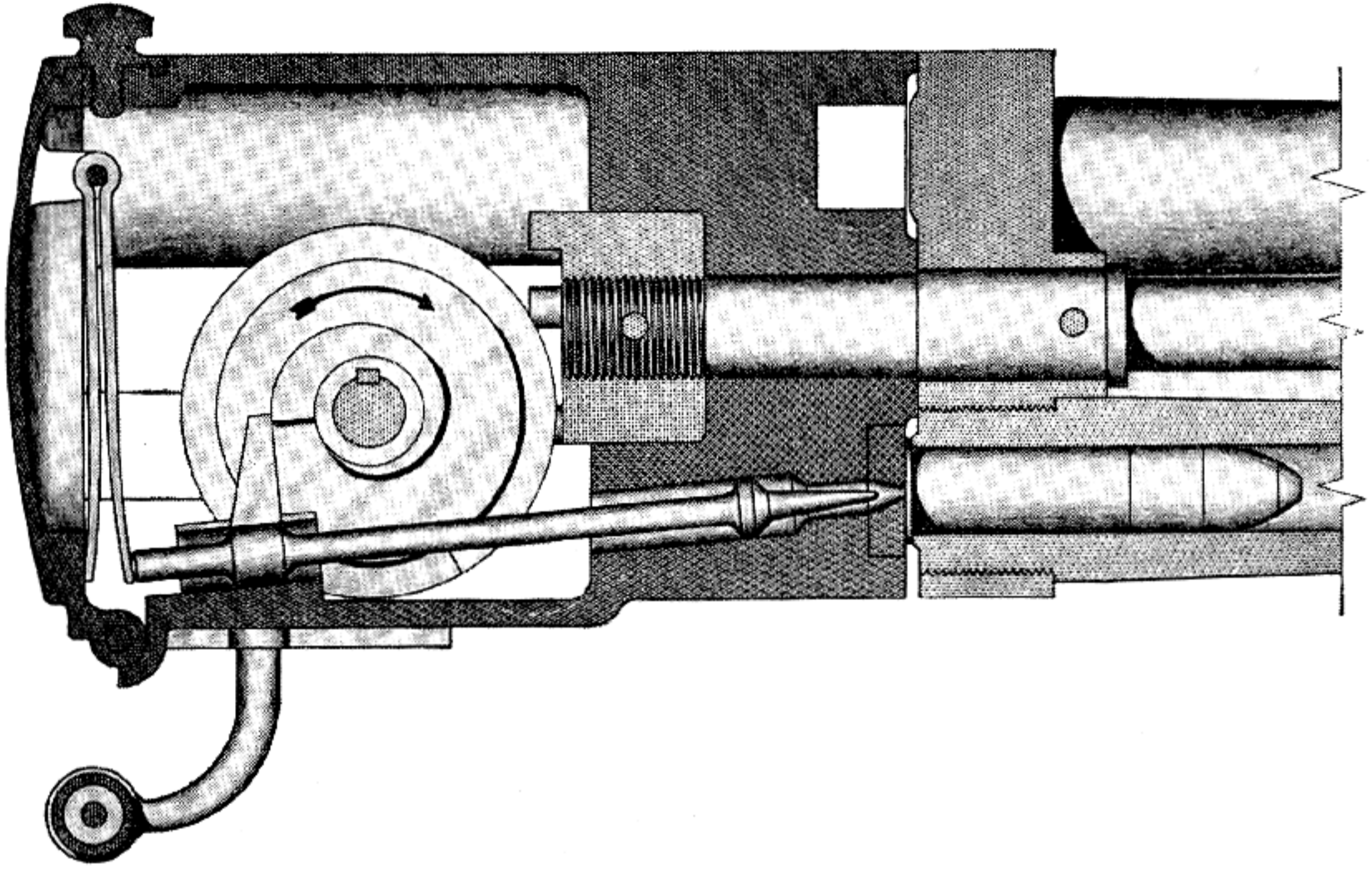

Section through Worm Wheel of Hotchkiss Cannon.

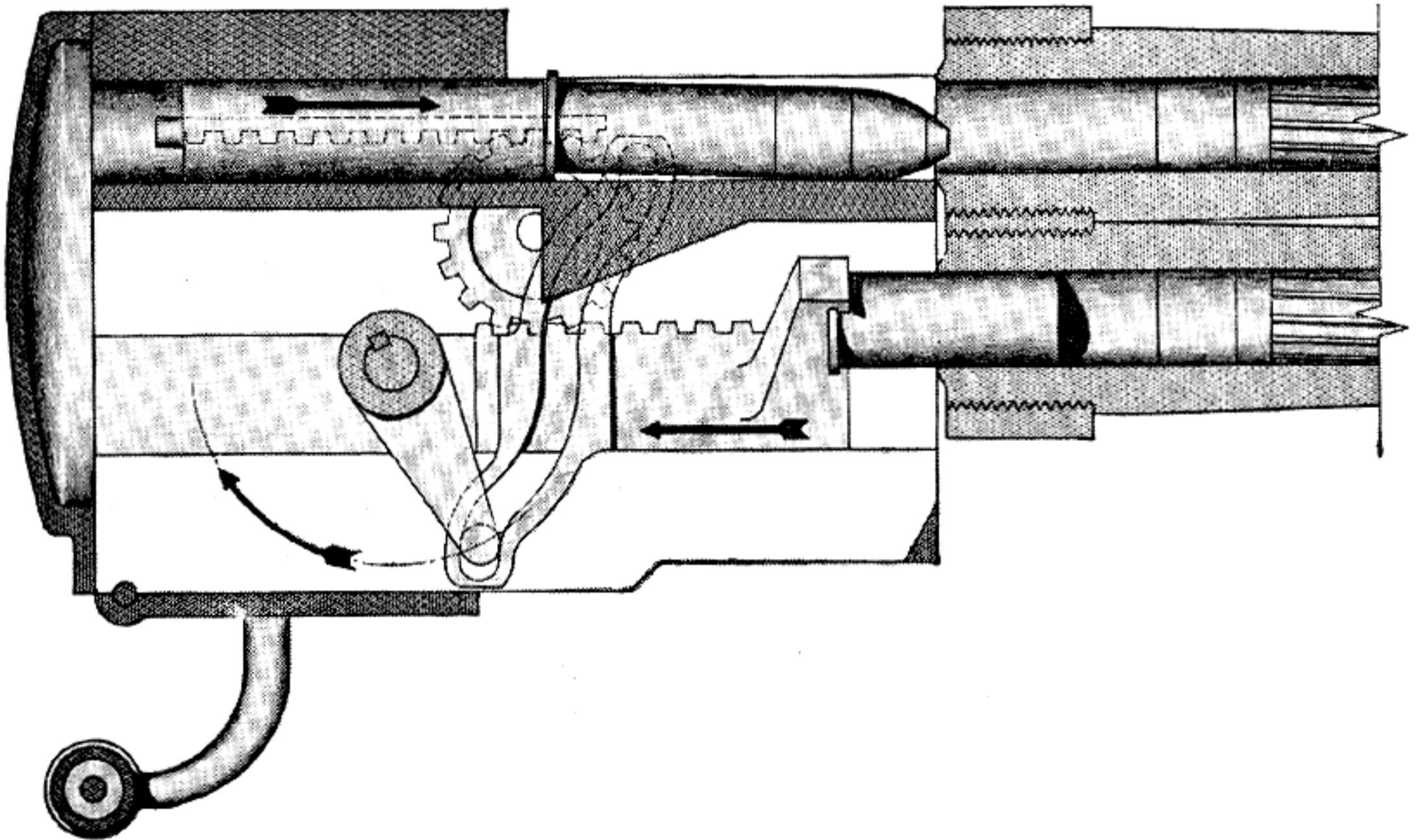

Section through Loading Rack of Hotchkiss Cannon.

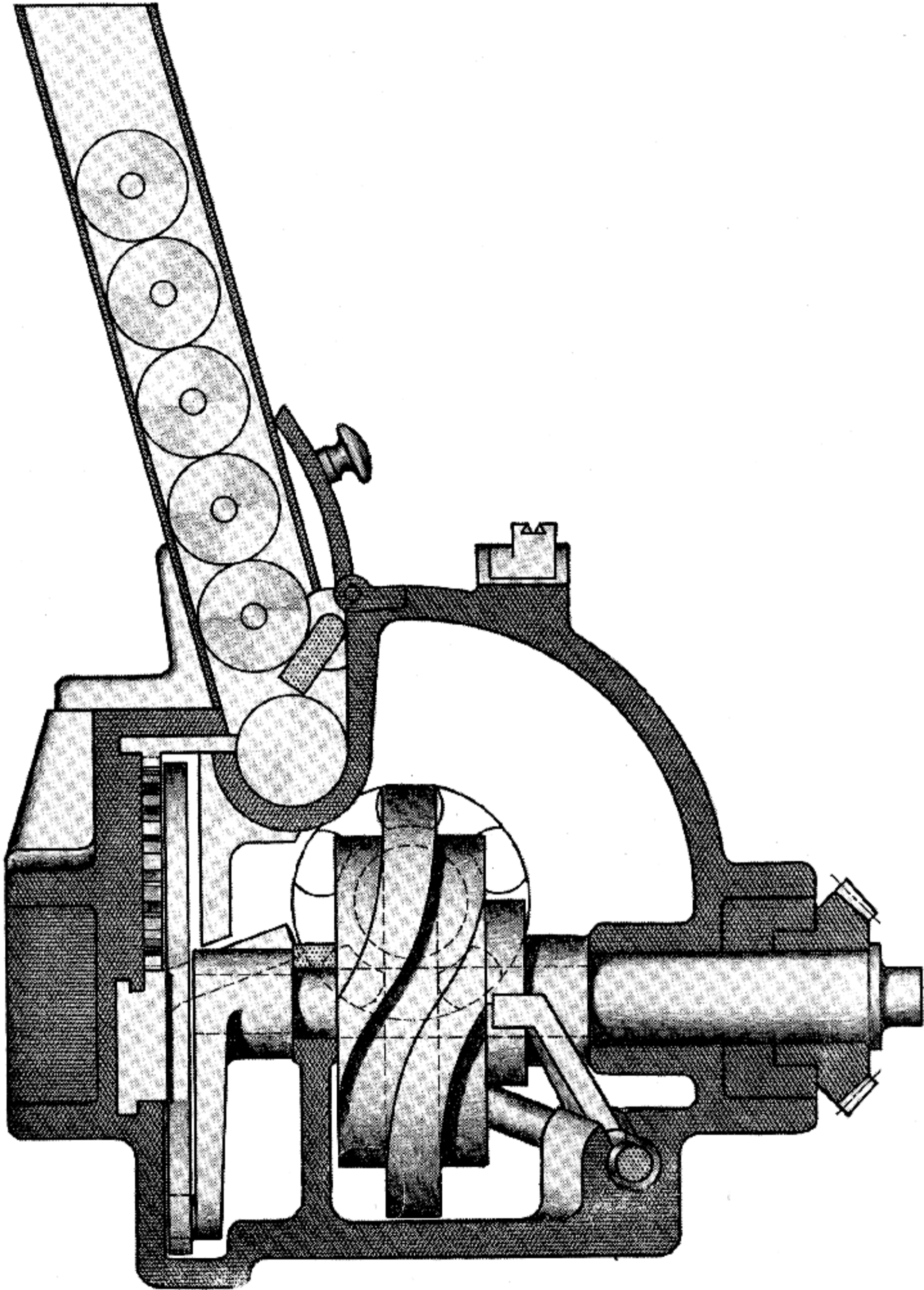

Section through Drive Shaft of Hotchkiss Cannon.

forward at the right moment to strike the primer and discharge the cartridge.

Loading and extracting are accomplished by an eccentric on the crank shaft that imparts a reciprocal motion to the extractor, which is geared to the loading piston. The rotation imparts an alternating and opposite movement to the two racks, so that while one is being retracted, the other is going forward. Thus, a fired cartridge is extracted from the lower left barrel at the same time a loaded round is placed in the upper left-hand chamber.

The cartridge is not driven home in one complete thrust, but is cammed the last fraction of an inch into position by further rotation of the screw. This completes a gradual introduction of the cartridge into the chamber without shock.

After the case is extracted from the chamber, it strikes against an ejector prong which pushes it out of the extractor and allows it to fall through an opening in the under part of the breech. The extractor does not depend on a spring at any time to retain its hold on the cartridge, the action being made positive by camming.

To obviate the difficulties that existed in other machine-gun systems when the cartridges in the act of loading were piled one upon another, there is used an introduction trough, or feeder, through which the loading piston works. As the piston moves forward to load, a gate rises and isolates the other gravity-fed cartridges from the one in the act of being placed in the chamber. In this manner all jamming of cartridges during rapid firing is prevented by the even spacing of the incoming rounds.

The Hotchkiss gun was new in that it occupied an intermediate position between the light machine gun shooting solid small-caliber bullets and the rapid-fire cannon employing an explosive shell. When mounted correctly, the weapon could easily be operated by one man. However, the average crew was composed of a loader, an operator, and a man on the crank. The operator can control the fire by means of a searing arrangement that permits him to stop the firing even when the man on the crank still continues to rotate the mechanism. The weapon can be fired single shot until the exact range is deter-

mined. Then, if rapid fire is desired, feed cases with 10 cartridges each are inserted in the feed trough. In this manner 60 to 80 rounds can be fired. The projectiles were of the type known as shrapnel, containing 24 lead balls, .71 inch in diameter, arranged in 8 tiers of 3 balls each, and having the interstices packed with sawdust. When a rate of 80 rounds a minute is attained, the target area is sprayed with over 2,000 pieces of jagged iron and lead bullets a minute.

The 37-mm cartridge proper consisted of a soldered tube of tin, with one end closed to form a cup. This end was reinforced both within and without by two iron caps, and fastened with three rivets to a wider round iron plate, which formed the true base of the cartridge. This bore the pressure of the gases and afforded a lip for the extractor. The percussion cap was also fixed permanently in the center of this plate. The load was  $3\frac{1}{2}$  ounces of powder and had a thick felt wad between it and the projectile. The cartridge case had a total length of 3.66 inches without the projectile. A complete round weighing 2.42 pounds was 6.68 inches long.

The 37-mm gun, when mounted for shipboard use, weighed 1,181 pounds and measured 70 inches over-all. However, there were six models of the crank-operated Hotchkiss made for specific purposes: the light 37-mm for field use; a high velocity 37-mm for flank defense and fortifications; the 37-mm designed for shipboard use only; a 40-mm for fortifications; a 47-mm gun for naval use; and a 57-mm weapon, also for naval use.

The Hotchkiss Co. was a success from the start and enjoyed the confidence of the French authorities, who felt they had the services of the greatest machine-gun designer of the age. The company not only received large governmental orders, but was allowed to export arms to the rest of the world. It normally employed a thousand craftsmen who built and assembled weapons. Long before the revolving cannon had ended its usefulness, Hotchkiss turned his attention to the development of other weapons, and experimented at great lengths with a machine gun to fire a 75-mm projectile that automatically opened and closed a drop breech. The principle was so sound it is used today on the French 75-mm gun.

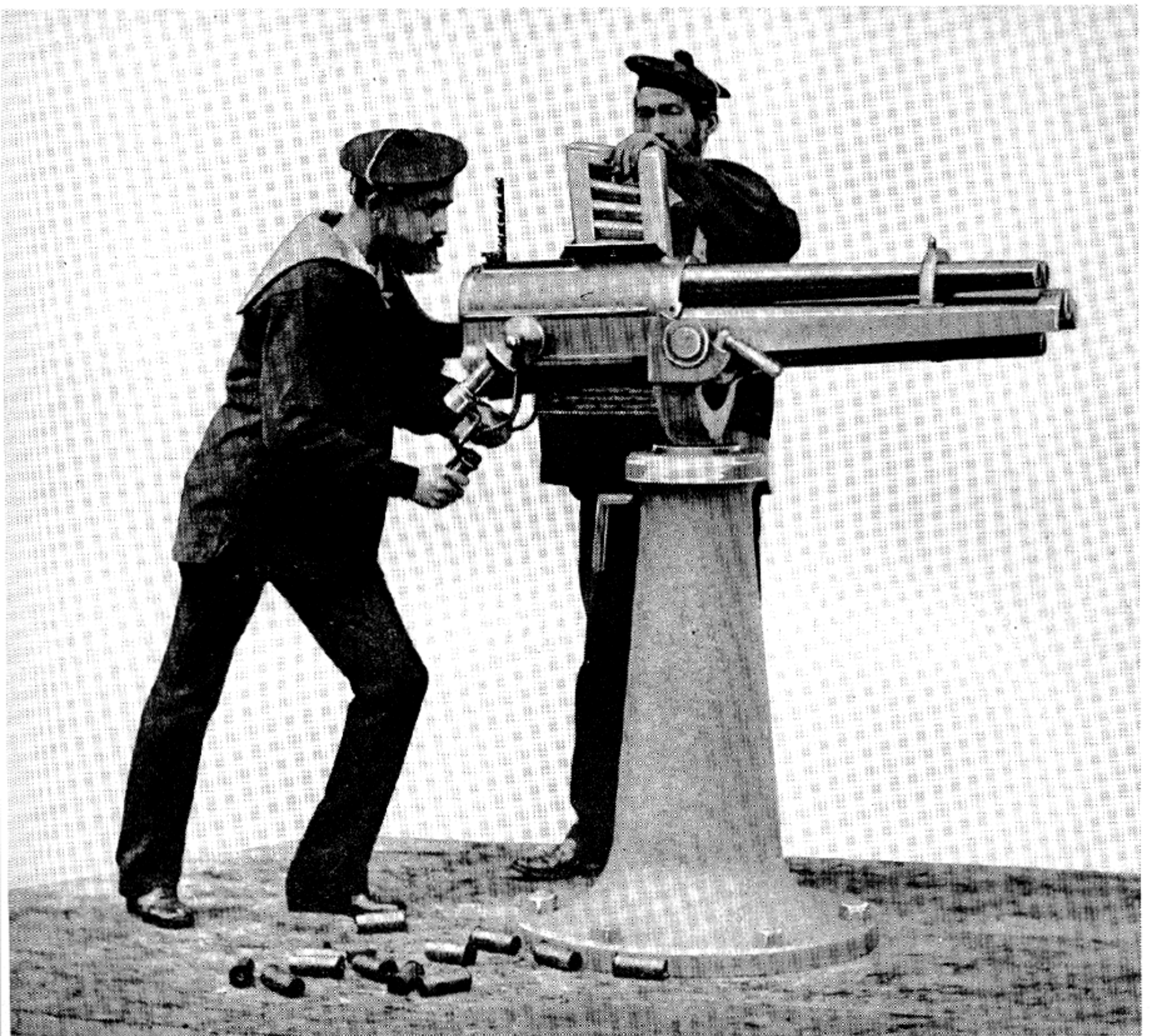

Hotchkiss 37-mm Revolving Cannon on Naval Deck Mount.

In 1884, the business having outgrown the St. Denis factory, a connection was made with William Armstrong & Co. of England for the manufacture of Hotchkiss guns at the Elswick works. At the height of his fame on 14 February 1885, Hotchkiss died. For a while the company was operated under a trusteeship, but in 1887 the affairs of both companies were placed under the control of the French corporation, and renamed respectively the Société Anonyme des Anciens Etablissements Hotchkiss et Cie. of France and the Hotchkiss Ordnance Co. Ltd. in England. In

1891 the company acquired certain patent rights allowing it to manufacture magazine small arms and automatic machine guns. For this, they built a separate factory outside Paris.

From the establishment of the original company to the building of the new plant to produce automatic guns, the firm built and delivered to the French Navy alone, over 10,000 revolving cannon and 4,000,000 rounds of ammunition. The revolving cannon was used by practically every navy in the world at one time or another, including Germany, England, Holland, Italy,

Denmark, Austria, Russia, Turkey, and the United States.

The inventor's theory of combining rapidity of fire with destructiveness of exploding projectiles was recognized by all nations, and the great company he originated in France carried on his policies until his death. One of the most successful methods of selling a weapon to a foreign power was first to make the gun as good as honest work and engineering skill could produce, then to seek out some person of high rank who

could be interested in promoting the weapon. This man's own name was then attached in such a complimentary way that such individuals were sometimes mistakenly credited with inventing the weapon itself.

Hotchkiss contributed much to the development of repeating arms and left conscientious workmen who carried on his progressive ideas after his death. In fact, with the coming of an entirely different trend in machine-gun design, they were prepared to exploit this new principle.



## GARDNER MACHINE GUN

Notwithstanding the wide variety of inventions during this era covering all classes of machine guns, few justified the term "improved" which was invariably mentioned at the beginning of each patent claim. One of the noteworthy exceptions was the Gardner machine gun, invented by William Gardner of Toledo, Ohio, who during the Civil War served in the Union Army as a volunteer in an Ohio regiment and rose to the rank of captain. Being unable to finance production of the weapon, he sold American patent rights to the newly formed company of Pratt & Whitney, Hartford, Conn., after an agreement had been reached whereby the inventor would receive a royalty on each gun delivered. This proved to be a wise move on Gardner's part, for Francis Pratt was no novice in gun design. Being a master mechanic and having spent many years in the employ of Colt's Patent Fire Arms Co., Pratt had attained a reputation for being one of the best gun designers in the field.

The original gun, invented in 1874, was built by hand. The prototype was turned over to Pratt & Whitney, who in less than 1 year produced a weapon thought capable of meeting military requirements.

The Gardner gun consisted of two breech-loading barrels placed parallel to each other, an inch and a quarter apart. The barrels were fastened at the breech ends and housed in a single casing. They were loaded, fired, and ejected alternately by one complete revolution of the hand crank.

To facilitate loading, a special wooden block was filled with ammunition, rim end protruding. This insured fast alinement of the base of the round with the slots in the feed guide. These two T slots, machined in a vertical post, dropped the loaded cartridges in correct position for the feed entrance.

To load and fire, one man inserted the rim

end of the ammunition projecting from the loading block into the feed guide, then withdrew the box from the rounds. Another turned the crank and aimed the piece. As the cartridges were fed from the guide, they were replenished by the loader. In this manner the weapon could be fired continuously.

At the request of Commodore William N. Jeffers, Chief of the Bureau of Ordnance, a test was held at the United States Navy Yard, Washington, D.C., in November 1875. In this trial the system was greatly commended by the officers who supervised the test. They suggested that Pratt & Whitney be allowed to take the weapon back to the factory in order to perfect the new feed system, invented by E. G. Parkhurst, an engineer of that company. This simple and efficient feed was an arrangement of cammed levers that transferred the cartridge from the feed guide to the perforated plate, and positively positioned the round in place, retaining the empty case until ejected. The method eliminated the unreliable gravity feed for which the weapon was originally designed.

A very unique feature was incorporated in the gun's design. In order to overcome extraction difficulties, a device known as a "shell starter" was used. This arrangement consisted of two crescent-shaped pieces pinned to the receiver that engaged the rim of the discharged round before unlocking was fully accomplished and cammed it free in the chamber. A loose cartridge case was thus left to be removed by the conventional extractors. This method of initial extraction was also a development by Parkhurst, who added many new and improved parts to this already reliable mechanism.

The official report on the working of the Gardner gun mechanism stated that it possessed every quality desirable in a machine gun, namely: lightness, strength, simplicity and durability; all working parts readily accessible; prospects of a

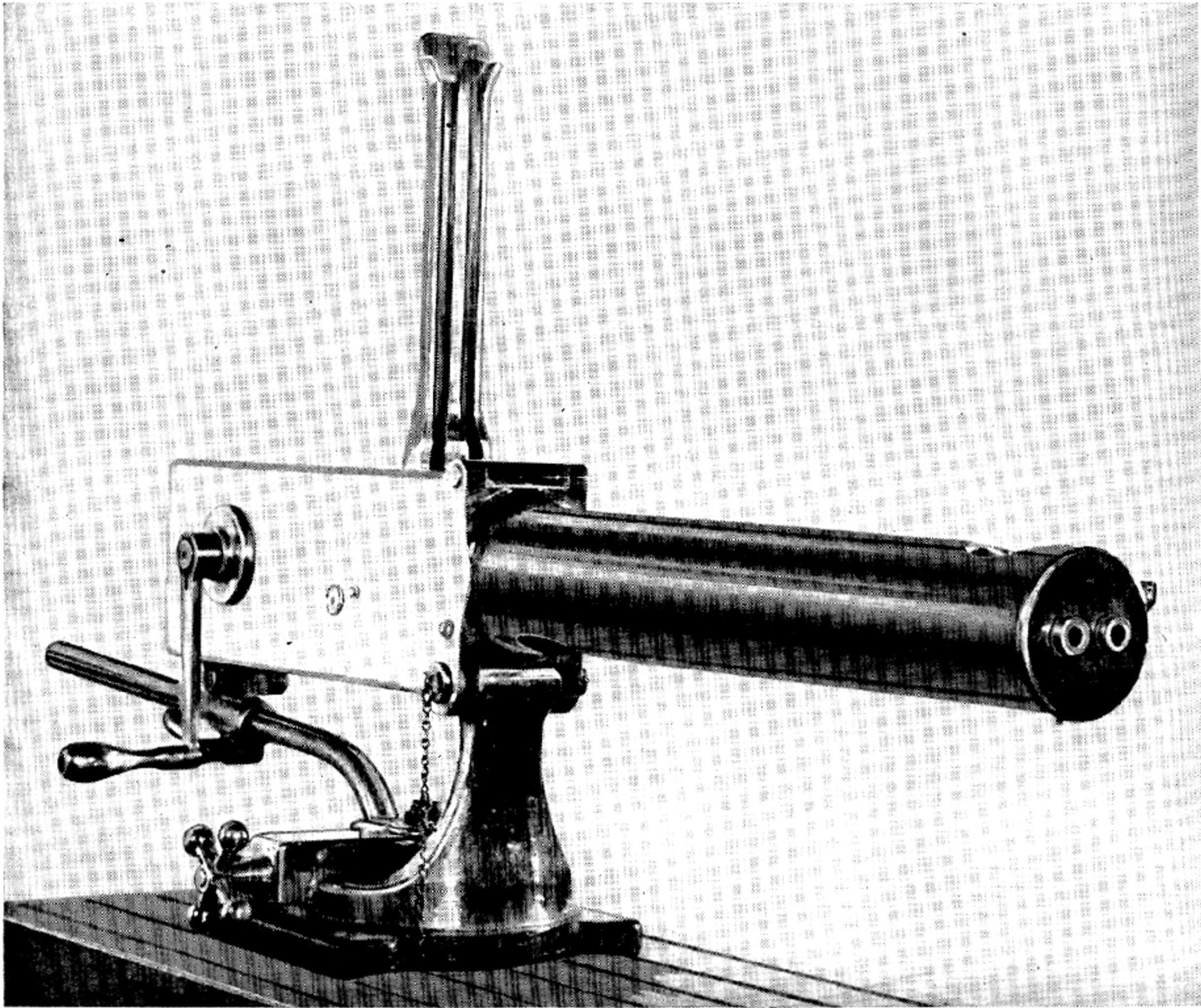

Gardner Machine Gun, Model 1879, Cal. .45.

feed that positively aligned the incoming rounds independently for each barrel; and an adaptation for firing each barrel at will. The mechanism worked perfectly and "commends itself to the critical examination and consideration" of the Government.

The weapon had other unusual features, such as a firing pin that was slowly cocked, thereby preventing any sudden impact; and a safety device that allowed ammunition to be run through the weapon without the possibility of discharging the cartridges.

Although General Benét, Chief of Ordnance, was present at the first test at the Navy Yard, the Army showed no inclination to be interested in

the Gardner gun, feeling, no doubt, that the Gatling was sufficient for Army needs.

In 1877 additional tests were held to try the new feed system, which was deemed reliable, and to determine the initial velocity, which was measured as 1,280 feet a second.

The weapon used a center-fire metallic-cased caliber .45 infantry rifle cartridge, manufactured by the Union Metallic Cartridge Co. of Bridgeport, Conn.

The barrels are securely screwed into the rear barrel ring, which is pinned fast to the case. The muzzles pass through a similar part called the front barrel ring. The rear ring extends from the back of the housing far enough to contain all

bolts, together with operating crank and safety stop. A swinging cover, hinged at the forward end of the case, is locked firmly in position by a quick opening latch. When the cover is raised, the whole operating mechanism is fully exposed, which permits the hasty clearing of malfunctions. The manually operated hand crank is pinned to the crankshaft which is supported by journal boxes. These boxes are locked into the rear of the case and serve to protect the swinging cover from side thrusts. The body of the crankshaft is circular in construction and has journals, or crank pins, for operating the bolts. These pins are diametrically opposite each other for alternate firing and are eccentric enough to give the necessary motion to the bolts as they moved to the front and back, performing the functions of loading the live round, and extracting and ejecting the empty cartridge case.

The center portion of the driven side of the bolt is machined to fit the periphery of the driving cam. This is for the purpose of holding the bolt stationary about one-fifth of a revolution of the crank, so that the time lapse after the firing pin falls will be ample security against hang-fires.

Each bolt is so constructed that it resembles the letter **U**, having a horizontal extension which contains the firing pin, firing-pin spring, and extractor. The **U** part of the bolt, which works under and around the crank pin, is curved at the inner point to correspond with the outer circle of the crank. The purpose of the curved front is to hold the bolt in position at the instant of firing. The firing pin extends from the head of the lock through the firing pin spring and sector sleeve, ending in a flange, for locking it into a sear.

The latter is made in the form of a bell crank,

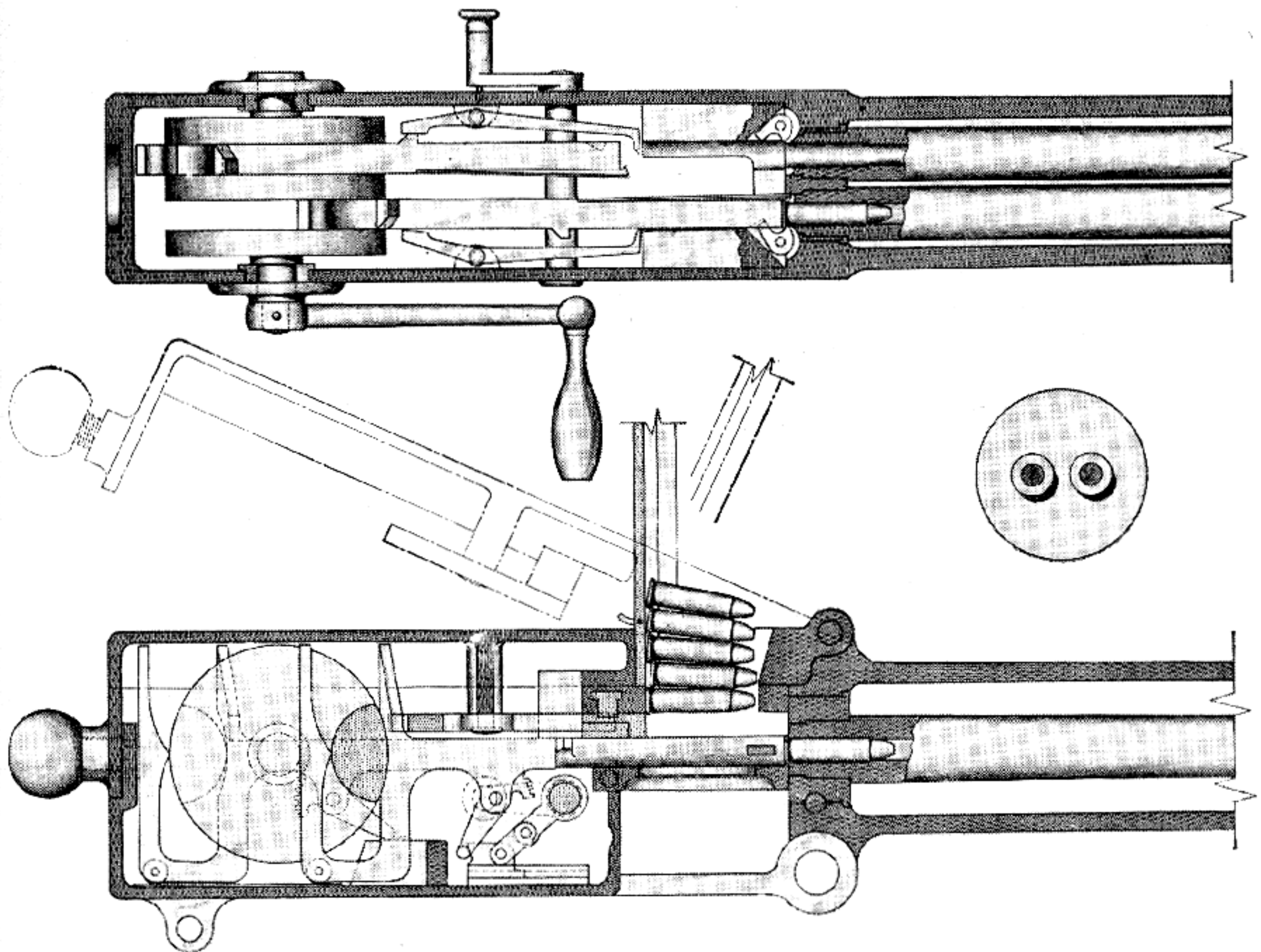

Section Drawing of Gardner Machine Gun.

pivoted in the center of the bolt. It holds the firing pin securely and prevents it from coming in contact with the primer until purposely released from its position by action of the crank journal after the lock is in battery in its extreme forward position. The cocking device, called the sector, or spring compressor, is hinged in a recess of the bolt and engages by means of gear teeth. This pivoting arm is forced against the safety stop, as the main crank advances. The firing pin is then compressed through the medium of the sector sleeve and held safe from accidental discharge but under tension, until released by the action of the sear.

The face of the bolt now receives the recoil from the charge's explosion, but is backed up by the crankshaft, thus presenting at the time of discharge practically a solid member. Each bolt carries a hook-type extractor which cams itself over the rim of the round as it is seated in the

chamber. When the bolt is retracted, the extractor pulls the empty cases from the receiver. It also performs a double function of preventing cartridges from falling through the perforated plate, as they are mechanically forced down through a kind of feed valve.

This valve is operated off the feed-plate lever, attached to the hinged cover and actuated by the motion of the locks. It utilizes about one-eighth the stroke of the crank in its forward motion. The valve is thus given sufficient time to hold both cartridge and empty case down in position while one is loaded and the other ejected. The valve, which is also fastened to the hinged cover, has a reciprocating movement across the perforated plate, containing two angular openings the size and shape of the cartridges. The centers of the openings are equidistant from the center line of the chambers of the barrels.

After a cartridge has dropped one-half its

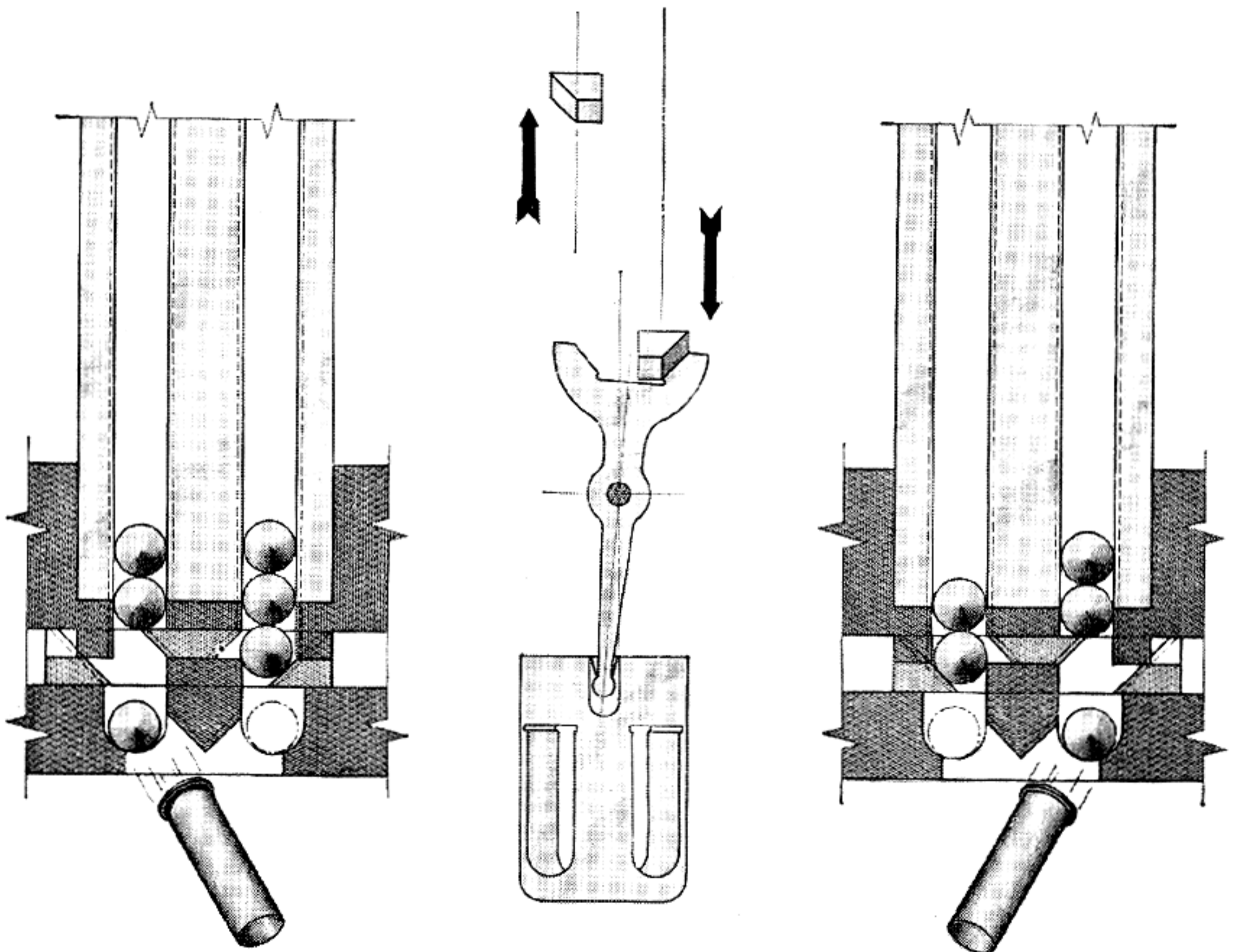

Section Drawing of Gardner Feed Action Showing Method of Indexing Cartridges for Loading.

diameter into the valve, it is forced by the action of the latter into position for loading, and held positively against the cartridge support. As the valve is moved back into its original position, the cartridge is cammed downward into the slot in the plate. At the same time it cuts off the incoming rounds in the feed system, and prevents their obstructing the progress of the one being chambered.

The upper end of the Gardner's feed guide has a trumpet-shaped mouth to facilitate the entrance of the rimmed cartridge heads. The lower end has a stop which holds the remaining ammunition in the guide whenever the latter is lifted out of its supporting cover.

The safety is an oblong block with two positions. It has an angular face against which the projections of the cocking device in the locks may engage when they are moved forward by the operation of the crank. The block is held in position by two links, which are moved by an arm pinned fast to a shaft passing through the rear of the receiver. The stop is fastened to the outer end of the shaft. This arrangement is constructed in the form of a crank having a stop spindle placed in the handle.

Behind the shoulder a spring is located that forces the spindle out of the arm into either of two stop holes, upper and lower. When the spindle is in the upper hole, the arm is in line with the barrels and the safety stop is thrown in contact with the cocking arm, by which the firing-pin springs are compressed. This makes the weapon safe, although in a cocked position. However, with the spindle in the lower hole the safety stop places the cocking arrangement out of gear, making it possible to turn the operating crank without compressing the firing-pin springs. As a result the operator may crank live ammunition through the weapon with perfect safety.

When worked in conjunction with the feed valve, which can be made to block the remaining ammunition in the feeder, the loaded rounds can be removed from the chambers. Yet the feeder will remain fully loaded, ready to be put in action instantly. Thereafter, the crank working the gun can be turned without loading the chambers. The double safety feature of the Gardner gun has many advantages, both for testing and combat, especially when combined with

the unique feature of being able to fire the barrels individually or simultaneously.

The barrels can be changed in short order by driving out a lock pin, and then unscrewing, with the use of a wrench, the flats which are machined on the barrels and made accessible by a large opening on top of the barrel jacket near the muzzle end. This feature is very necessary in this type of machine gun, because it uses a black powder cartridge. The arrangement permits a visual check and is an easy way to keep the chambers free from the residue left by this kind of propellant.

All these features were incorporated in the Gardner weapon, test fired to the satisfaction of company officials, and proved successful. Finally, after many delays and much correspondence the Navy again took it under consideration. Commodore Jeffers ordered a final test to be run on the gun, and specified that it be conducted at the Washington Navy Yard range under the supervision of Commander H. L. Howison. The weapon was brought to the Navy Yard by Francis Pratt and Amos Whitney, who not only explained the mechanism and general characteristics, but took turns at the crank operating it during the day set aside for the test, 17 June 1879.

The weapon was first examined by the board and found to be in good condition, with all parts working smoothly. The locks were lightly lubricated with a coating of tallow to keep the black powder residue in a fluid state. At a given signal the test got underway, with Pratt cranking, and a company representative, Mr. Saunders, feeding the gun. A 200-round warm-up burst was fired, and the operating parts were examined and found to be in perfect condition. Then two ammunition boxes were placed on the left side of the gun so that continuous feeding could be accomplished and a 1,000-round burst was fired without incident. Another check then showed that the fouling on the parts was soft because of the tallow, and the barrel cover was quite hot, but not enough to stop the test. Firing was resumed again. When the ammunition was expended from the boxes, a burst of 431 rounds had been fired. The barrels were then found to be moderately fouled. The mechanism was visually inspected and pronounced in good shape. However, the barrels and their cover had be-

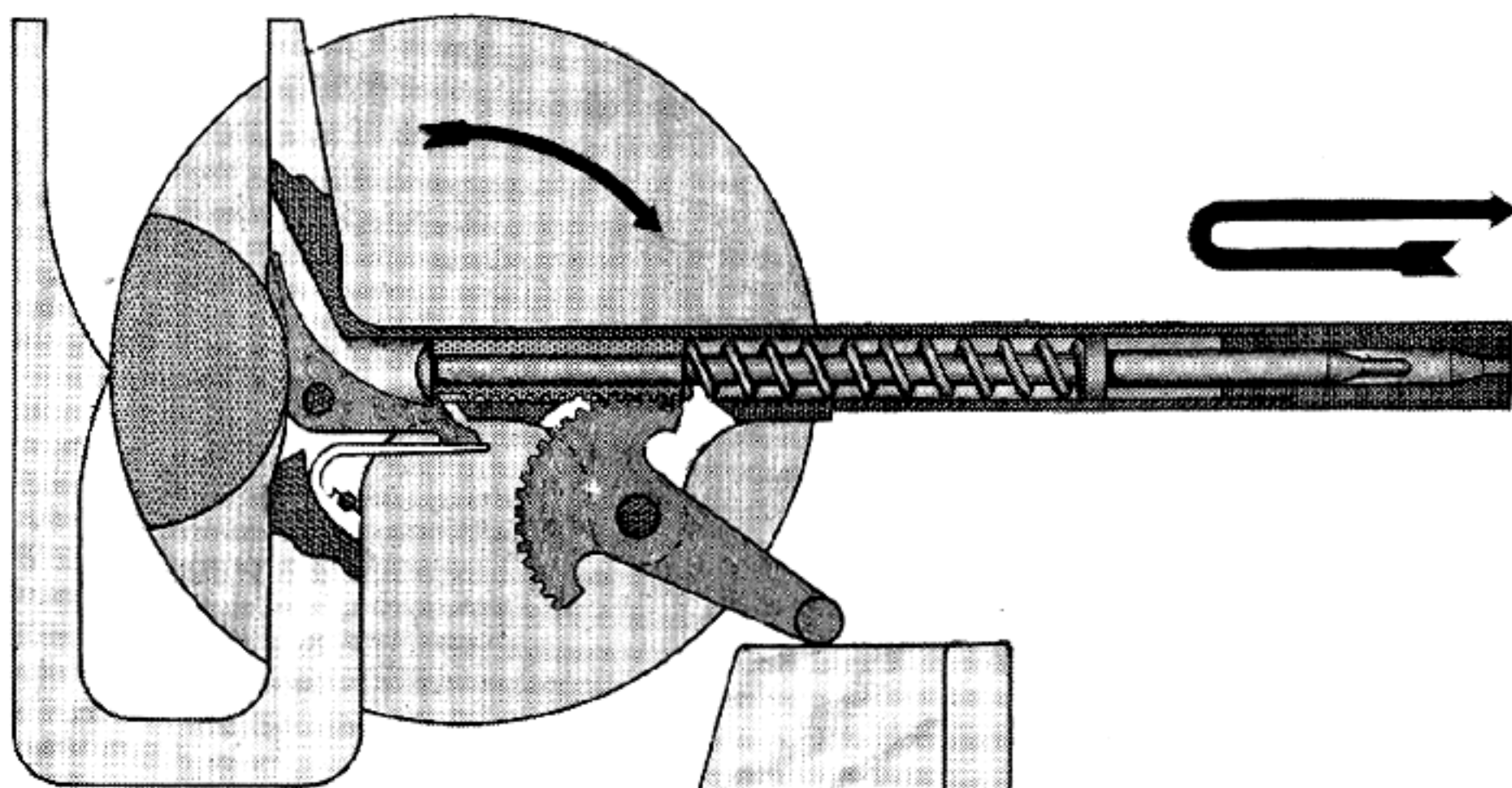

Section of Gardner Bolt Assembly Retracted.

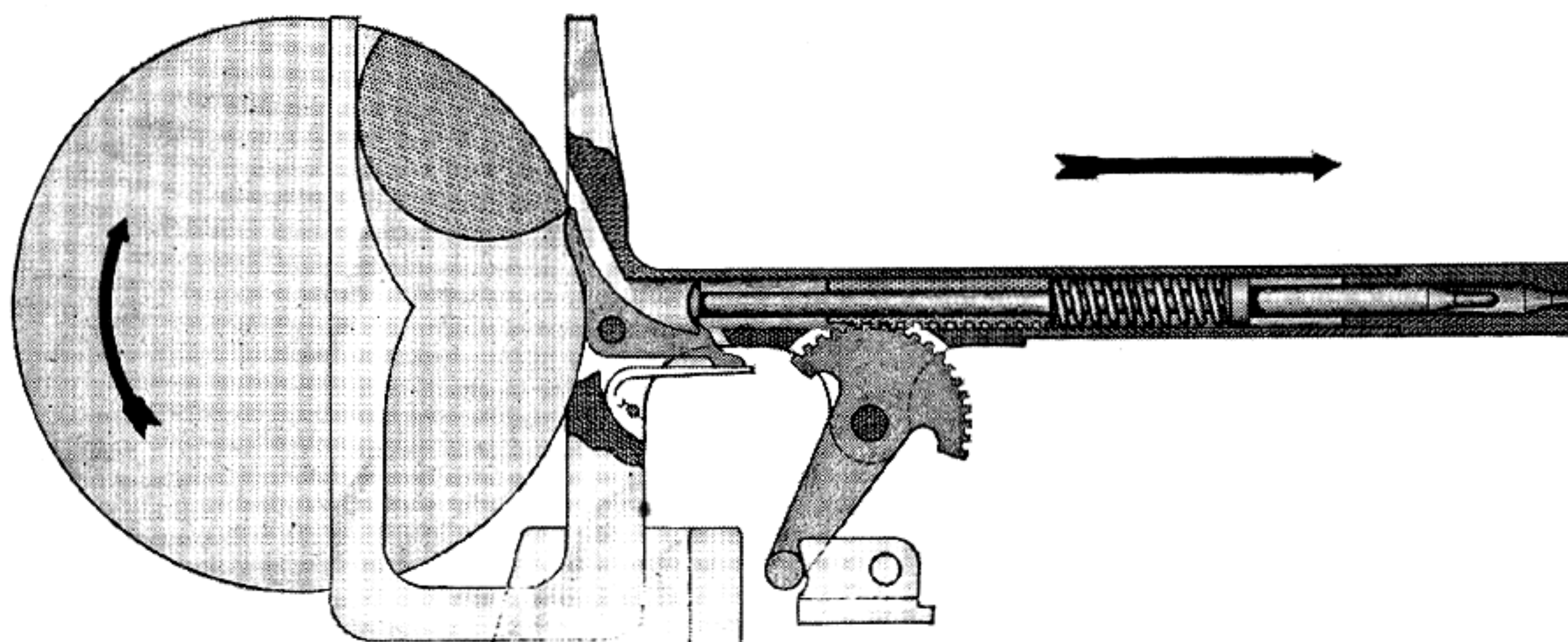

Section of Gardner Bolt Assembly in Battery.

come so hot that in clearing the weapon of cartridges at the end of the burst, it was recorded that "the live round taken from the right barrel was too hot to hold in the hand." (It is clear that no one had ever experienced a "cook off" up to this time.)

It was decided at this point that the gun should be given a burst that would prove the reliability of the weapon. A total of 5,000 rounds were prepared for continuous feeding. It was recorded that the time taken in bringing up the cartridges and putting them in the special feeding block allowed some cooling of the weapon before firing commenced. With 2 men feeding and a third ordnance man helping Whitney on the crank,

firing was resumed, and 3,019 rounds were fired without stopping. The weapon then had its first malfunction when the extractor in the right-hand barrel failed to withdraw the empty case.

There was a delay of 1 minute 15 seconds (according to Navy records) before the brass could be removed and firing resumed. Then after a burst of 359 shots the same malfunction occurred. The officer in charge allowed the gun's proprietors to take the lock out and examine the extractor hooks. They appeared in good condition, but when flexed by hand, the right extractor shank appeared not to be as stiff as the left one. The extractor recess and the grooves in the barrel were observed to be moderately fouled,

but they were not cleaned as the test continued. Since each failure occurred with the right extractor, it was evident that the ammunition was not at fault.

On the next attempt 690 rounds were fired and another stoppage occurred. After two more bursts consumed 870 rounds, the ammunition that had been prepared for the 5,000-round test was entirely expended, and firing was concluded for the morning. The total time consumed in the actual firing of 6,631 rounds, not counting the delay for cleaning, was found to be 18 minutes 55 seconds. The five stoppages from failure to extract from the right-hand barrel were recorded as taking 5 minutes 34 seconds.

At noon Messrs. Pratt and Whitney were allowed to remove the locks in an attempt to put the right-hand extractor in working order. The hook on this piece was found to be dulled and it was filed by hand to provide more bite into the inside rim of the cartridge. The shank was bent inward a bit to increase spring tension.

When firing was resumed after lunch, the jackets covering the barrels were found to be still too hot to pick up the gun by hand. The afternoon test was to be for the purpose of obtaining the best rate of fire. The company elected to fire a 2,000-round burst, with an average of 380 rounds a minute. Pratt was not satisfied with this performance and, turning the crank himself, fired a short burst of 100 rounds in exactly 11 seconds, or a rate of 545 rounds per minute.

The barrels were so hot by this time that permission was asked and granted to pour water through the bores until they cooled down to a safe operating temperature. The weapon then

was moved to the sea wall and the muzzle depressed 29°. With two ordnance men feeding and two assisting on the crank, 430 rounds were run through in a 1-minute burst. With 3 men feeding and a like number on the crank, the remaining ammunition of the 5,000 to be used in the afternoon test were fired, but the rate of fire was not recorded.

No failure to extract took place in the afternoon firing, as the quick fix resorted to by company officials to overcome the malfunction most certainly proved to be the correct diagnosis and cure. The total time for actually firing the 10,000 rounds, again omitting the 5 minutes 35 seconds delay, was 27 minutes 36 seconds.

Mention should be made that Gardner also designed a one-barrel gun, which was bought in limited quantities by the United States Navy.

Unfortunately for Gardner, the firm of Pratt & Whitney, and the United States Government, the armed services had no interest at this time in the further development of machine guns. The services were supplied with the Gatling and even this reliable weapon was seldom, if ever, brought into action against the Indians, whose spasmodic uprisings were the only events that warranted the use of such weapons.

The result was that though the Gardner met successfully every test ordered, nothing was done other than the support given by the Navy, which adopted the weapon and purchased a limited number. Gardner was the first inventor to take into consideration the terrific weight factor involved in the design of hand-transported weapons capable of a high rate of sustained fire. His single-barrel gun weighed only 70 pounds and

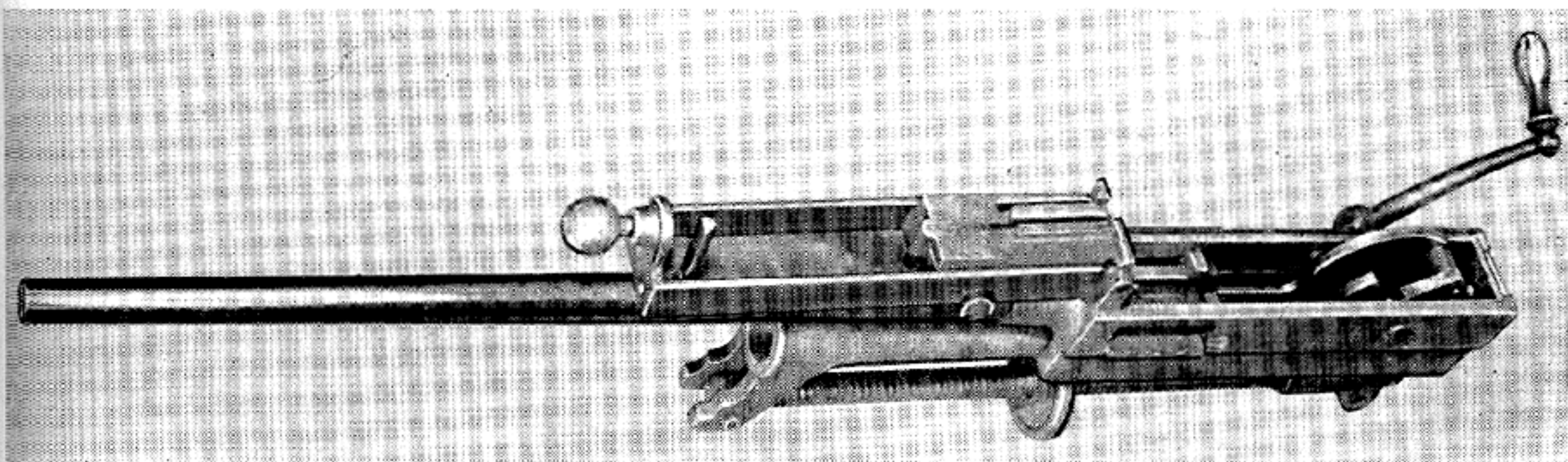

Gardner Single Barrel Machine Gun with Cover Open.

its fire power depended solely on how fast the operator could turn the handle. This feature was recognized by the Navy as desirable for mounting in the rigging and for easy handling aloft and by landing parties where weight and bulk were quite critical.

The Army on 15 January and 17 March 1880, ran duplicate trials at Sandy Hook Proving Grounds before a board consisting of Lieut. Cols. S. Crispen and T. G. Baylor and Maj. Clifton Comly. After a successful performance the board stated that the weapon was reliable, simply constructed, light in weight, and easily operated. It recommended that the War Department buy a limited number for actual use in the field service, especially since the cost of the weapon was so much less than that of other machine guns offered to the Government. Despite these recommendations, nothing was ever done officially by the Army to utilize the weapon. By its inaction the United States lost the benefits of one of the best machine-gun designs of all time. For, the British Navy was quick to capitalize on the great contribution Gardner made to weapon development.

Influenced by its successful employment of the

reliable Gatling, the British Navy had long respected the engineering ability of American gun designers. The light, inexpensively produced, highly mobile Gardner, to be used in conjunction with the Gatlings, answered some pressing naval problems. Gardner accepted a cordial invitation to visit England and exhibit his weapon. The Admiralty not only adopted the gun after trials proved its worth, but it also purchased manufacturing rights whereby the Government would erect a factory for building the arms, provided the inventor would remain in England to supervise their construction. Gardner agreed, and after terminating his business connections with Pratt & Whitney, he moved to England where he resided until his death.

That the British Admiralty knew what it was after is evidenced by the fact that the army, noting the navy's successful trials of the weapon, also became interested in machine guns. The government was requested to order a selection committee to examine all existing systems of machine guns for the purpose of military adoption. This move was very flattering to the navy's foresight in promoting this gun and proving its extreme serviceability, for the army had hereto-

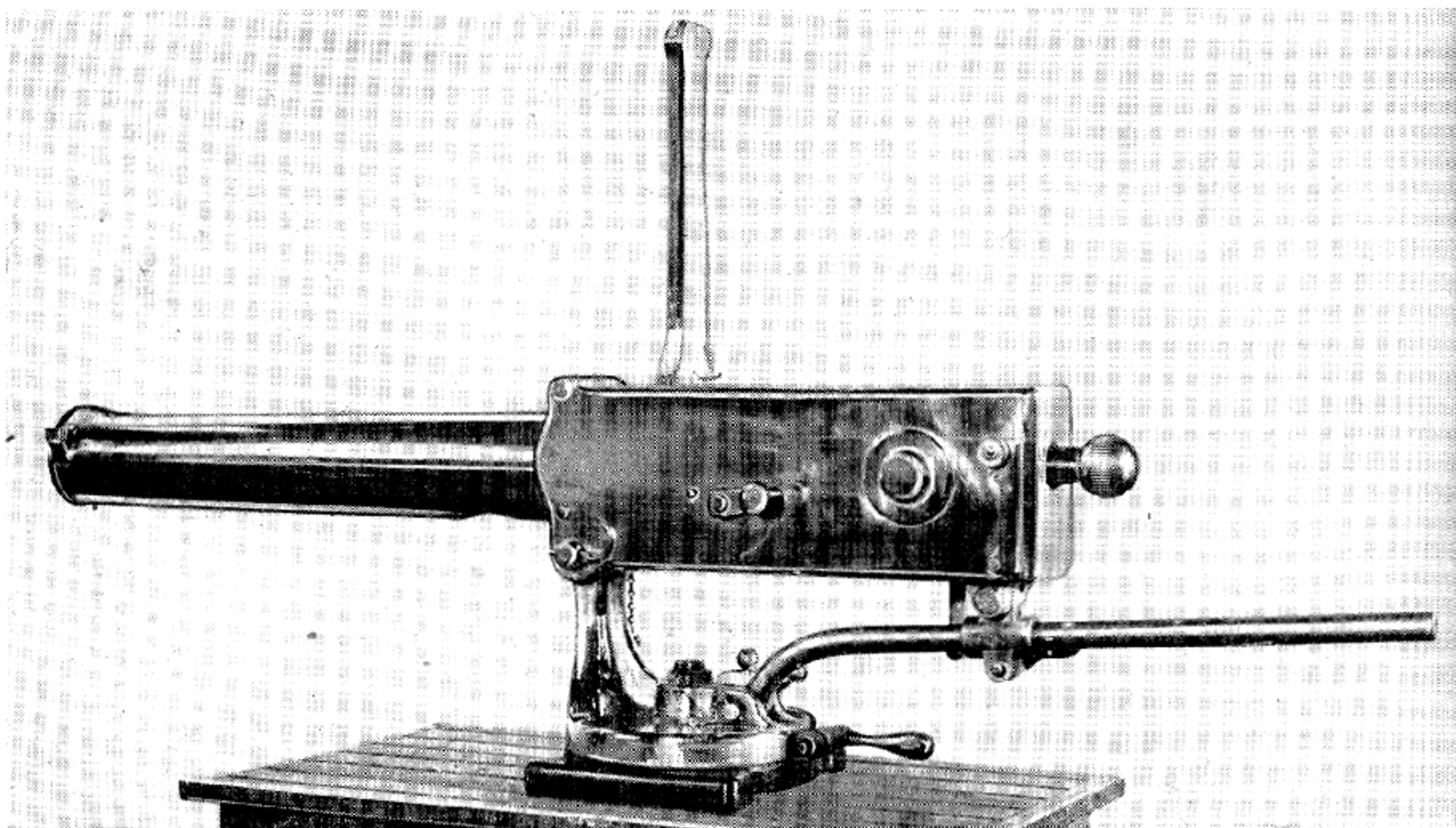

Gardner Machine Gun, Cal. .45. This Weapon Could Be Used Either Water- or Air-Cooled.



fore been violently opposed to any form of machine gun.

The British Government granted the request. The committee, on 21 March 1881, reported that, after exhaustive trials of different machine guns on 10 points of comparison, the Gardner had been preferred in 9. It recommended the adoption of the two-barrel gun for all branches of the service where a light weapon could be used and a limber or similar artillery transportation was not required.

The extremely rigorous workout given the weapons under consideration by the committee can be best illustrated by using its own statistics. The Gardner 5-barrel gun fired 16,754 rounds before a failure occurred, which was considerably more than was done by any of the other 8

guns on trial. Then, each of the 5 barrels fired singly 1,500 shots. The total number of malfunctions was 24, or a percentage of 0.14. Several of the jams were at the very beginning of the trial before the gun, which was new, had been perfectly adjusted. In the last 7,500 rounds fired for endurance, there were but 5 stops: 4 failures to extract and 1 cartridge bent in the feeder. Two of these jams were officially credited to accidental dropping of ammunition in the mud by inexperienced loaders. Leaving out these two stoppages, the percentage drops to 0.04, or 4 malfunctions in 10,000 rounds.

As another example of the strenuous demands placed on these guns during this examination, the weapons were left uncleaned and exposed to the weather for a full week before firing was re-

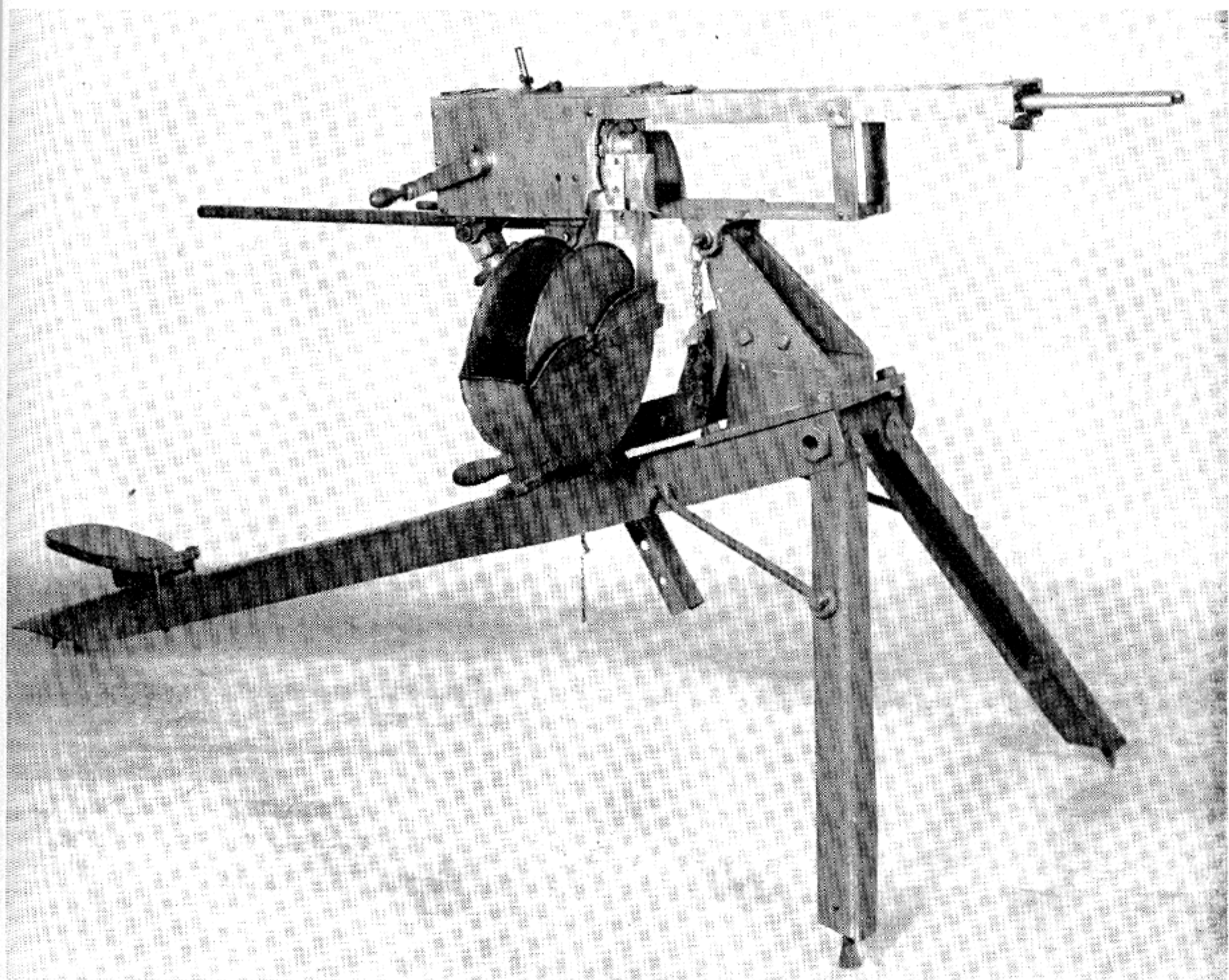

Robertson Double-Barrel Machine Gun, Cal. .30.

sumed. The 5-barrel Gardner fired without hesitation at the rate of 812 rounds a minute.

The committee unanimously agreed that the Boxer cartridge should be eliminated, or at least perfected, as it gave trouble when tried in the Gardner, as it did in the Gatling tests.

That the Royal Navy adopted this lightweight gun long before its official use by the army is credited to hostile opposition from the Woolwich Headquarters of the Royal Artillery. This branch was prejudiced against machine guns of this type, since the lightweight construction of the weapon removed it from the jurisdiction of this organization. Artillerymen, though tolerating cannon-type machine guns for flank defense, always regarded them as inferior field pieces.

While speaking on the rapid machine gun development of the British Navy, Capt. Charles Beresford in July 1884, in a lecture given before the Royal United Service Institute, stated, "It must be remembered that the navy had had more actual experience in the working of machine guns in the field than any other branch of Her Majesty's Service, as guns for this purpose were supplied to the navy, but not to the army."

The early encouragement to Gardner from the British Government in giving him limited orders for the navy was soon followed by the purchase of large quantities of the weapon for all

branches of the service. Its value was proved in Sudan at the battles of El Teb and Tamasi, and with the naval brigades in the Upper Nile in 1884 and 1885. A superior method of mounting was designed by a naval engineer which eliminated the limber system and resulted in a tripod arrangement that was used quite successfully.

Long after the Gardner and other hand-cranked guns had ceased to be considered first-line weapons, due to the method of feed and the employment of black powder cartridges, the British attempted to bring this type of weapon up to a point where it would again be a gun with great possibilities.

The most serious effort along this line was a belt-fed design that used smokeless powder cartridges. It was commonly known in this country as the Robertson, being named for the British engineer who was responsible for the development. As the only improvement deserving mention was the belt-feed arrangement, it should rightfully be called the Gardner-Robertson, there being too many features of the earlier gun present not to be given credit.

This hybrid was tested in the United States in competition with other mechanisms and failed so many times during the trial it was withdrawn by its sponsors. Existing records indicate it was never again entered in trials.

## LOWELL MACHINE GUN

The next competitor in the field of machine guns was produced in 1875 by the Lowell Manufacturing Co., Lowell, Mass. It was the invention of DeWitt Clinton Farrington. He organized the company at this time, to produce the Lowell weapon, which he contended was more reliable than any known firing mechanism. Many concurred in his opinion and the official tests conducted by the Navy at its Experimental Battery at Annapolis, Md., brought out a number of original and improved features. It most certainly did show Farrington to be a man with the single purpose of producing the best machine gun in existence. It seemed to matter little to him that the Government already had similar weapons whose performance, according to ordnance experts, could not be surpassed.

The Lowell is of unusual design. It has 4 barrels mounted between two supporting discs, arranged to revolve in a circle. The ring at the center of the barrels is provided with trunnions which work in the frame connecting the barrels with the breech mechanism. When in position, the rear ring and enclosed disc lock with the frame. By a fastening and pivoting arrangement, the barrels can be disconnected and the breech end tilted up. This allows the bore to be readily inspected or cleaned and makes it relatively easy to remove any residue, or a stuck case, from the chambers.

One of its most original features is that only the upper barrel is fired. When it becomes overheated, it is rotated out of the way by a lever, and another is locked in place. This change can be made in a matter of seconds, without cutting off the feeder, thus allowing the operator to fire continuously with the assurance of a cool barrel at all times.

The working parts are exceedingly simple, and of rugged construction. It requires only a matter of seconds to inspect or remove them. The two extractors have a unique feature in

that they do not depend upon springs, but operate by a positioning cam, forming a solid T slot until the empty case is well loosened from the chamber.

The principal parts of the breech mechanism are the crankshaft and worm for rotating the feed or carrier rolls. There is also the lock which encases the firing pin and spring, and serves as a support for the double extractors. All of this mechanism with the two carrier rolls and shaft is housed in a brass casing, the upper left half of which is hinged. Immediate access to the operating parts is permitted by pressing down on a spring-loaded latch, and then raising the whole side. With the barrels tilted and the housing raised, the entire operating mechanism is exposed for inspection, maintenance, or replacement.

The cam used to force the plunger, or lock, home is so designed that after the lock is in battery, and the round has been fired, it continues to back up the member while the crank rotates. This feature allows a time lag to take care of hang-fires which are such a dangerous possibility in the manually operated type of machine gun where rounds are fed in and out of a chamber with great rapidity.

The operating crank of the Lowell gun is located directly to the rear, and made so that it can be turned without interfering with the gunner's vision. Because only the barrel located in the center of the gun fires at a given time, there is no tendency for the recoil to throw off the operator's aim.

The feeder consists of a square iron tube, inserted in a recess directly over the carrier rolls. Extending its whole length on the forward side is a T slot milled slightly in excess of the diameter of the cartridge and its rim. The feeder holds 30 cartridges, and can be removed, if necessary, by loosening a set screw located at its bottom end. The top of the feeder is open and

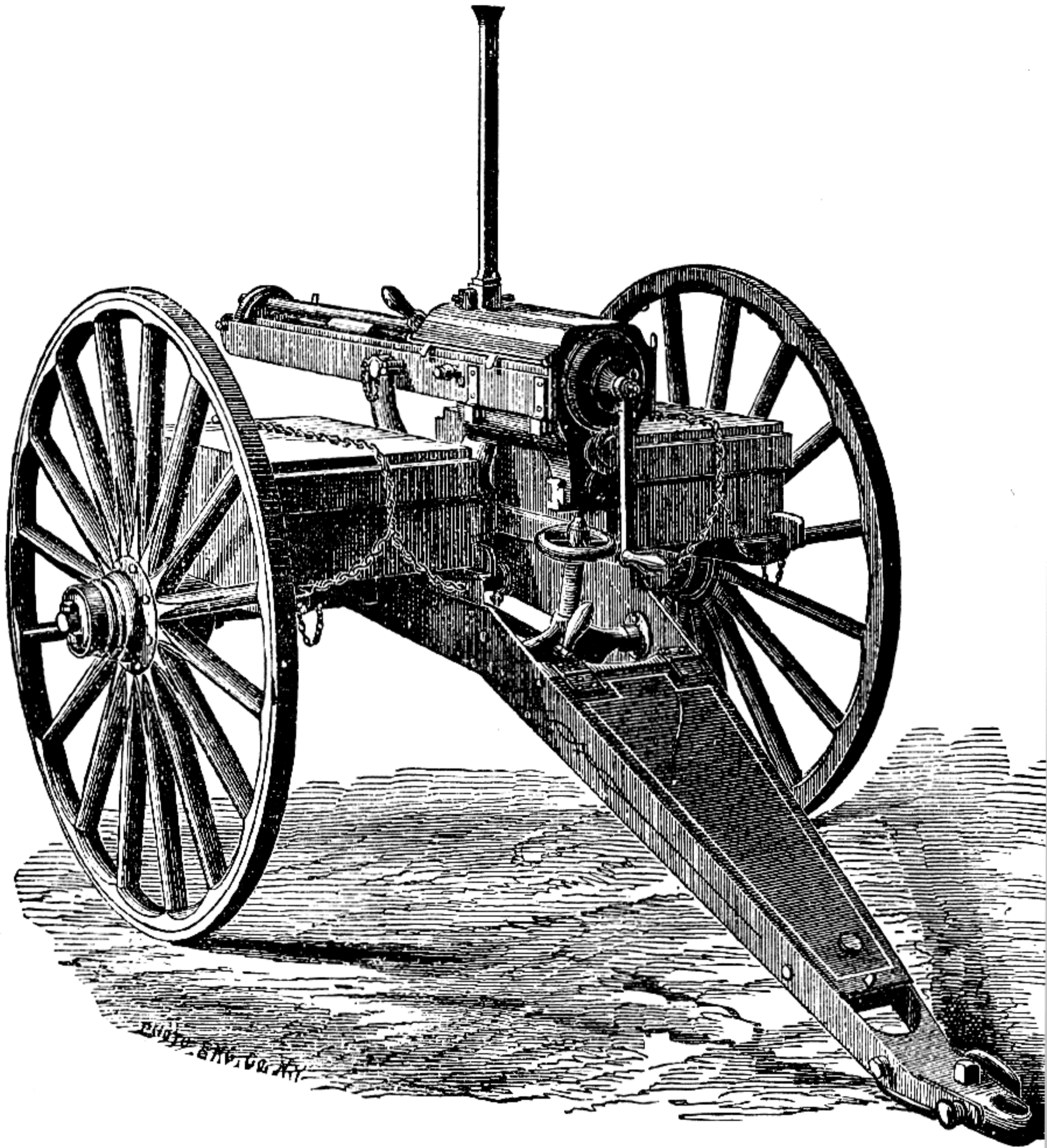

Lowell Machine Gun on Carriage Mount.

flared to facilitate the introduction of the cartridges into their proper position.

When the rims of loaded rounds are dropped into the grooves, they fall by gravity to the bottom. The original horizontal position is maintained throughout the whole descent. They pass out of the feed case at the bottom, and enter the recess in the carrier rolls in proper position to be chambered by the advancing lock plunger.

In the socket which holds the feeder is an ammunition stop that consists of a spring-loaded pawl. It allows the operator to interrupt the feeding at will merely by pushing the release button in and turning it slightly to the left. The stop plunger snaps forward under the incoming round, and holds it above the recess of the carrier rolls.

The Lowell gun uses the service caliber .50 infantry cartridge with a ball of 450 grains and 70 grains of powder, as developed by General Benét. This ammunition is packed in paper containers so that the rims protrude enough to allow easy insertion in the trumpet-shaped mouth of the feeder.

When the feeder is loaded, the weapon may be put in action by changing the selector from *safe* to *fire* and rotating the crank clockwise. As each round is expended, a fresh one drops from the feed guide into the fluted carrier roll. It is moved downward by further rotation of the crank until indexed into position for the plunger lock to shove it forward and chamber the cartridge. As the loading plunger starts toward battery, the firing pin lug is held in contact with the cocking plate, slowly compressing the spring. Upon reaching the locked position, the firing pin rides off the cocking plate cam, causing it to snap forward under spring tension, striking the primer and firing the cartridge.

The continued motion of the propelling cam, after a short dwell to allow for hang fires, starts the plunger lock rearward. During the first fraction of an inch of this travel, the double hooks of the extractors are positively positioned around the rim of the cartridge case forming a solid T slot until the case is fully loosened. Then the extractor claws come out from under the influence of the cam and are left in a position where they offer no resistance while the carrier roll rotates the empty case through the opening in the hous-

ing. It would be very difficult to originate a more positive system to extract and eject an empty cartridge case than is found on this weapon.

At the request of the Lowell Manufacturing Co., Commodore William W. Jeffers, Chief of the Bureau of Ordnance, on 30 September 1876, ordered a board to witness an official test of the 1876 model weapon. At 10 a. m. on 3 October 1876, at the Experimental Battery at Annapolis, Md., the board met. Lt. Comdr. A. S. Crowninshield, the officer in charge of the trials, introduced Farrington, who described the weapon in detail, explaining the function of each working part while demonstrating the ease of assembly and disassembly.

To prove the Lowell's simplicity and substantiate the very important claim that trained operating personnel was unnecessary, Farrington asked that someone not engaged in ordnance work fire the Lowell during the entire test. This request was granted. Two unskilled laborers who had never seen the gun before its arrival at Annapolis were selected. They alternated as operator and loader throughout the test. After being shown once how to remove the lock and two carrier rolls, the only parts considered susceptible to derangement or fouling, they were able successfully to assemble and disassemble the weapon when necessary during the trial.

The muzzles were depressed  $35^{\circ}$  to subject the feed to the maximum vertical angle thought necessary for shipboard use. In this position a burst of 2,100 rounds was fired. The feed system and all other mechanisms worked perfectly. The only delays in this burst were for rotating a cool barrel into position. These changes were deemed necessary approximately every 400 rounds, and averaged 5 seconds each. The 2,100 shots were fired in 8 minutes 30 seconds, including all delays in shifting barrels.

A total of 9,870 rounds were fired during the day, with the laborers manning the weapon. Practically all firing was in bursts averaging 400 rounds. It was noted by the firing officer that when such a burst was fired the barrels were hot enough to char paper, but not to light it. When 600 rounds were fired without stopping, the paper would light upon contact, but the barrels

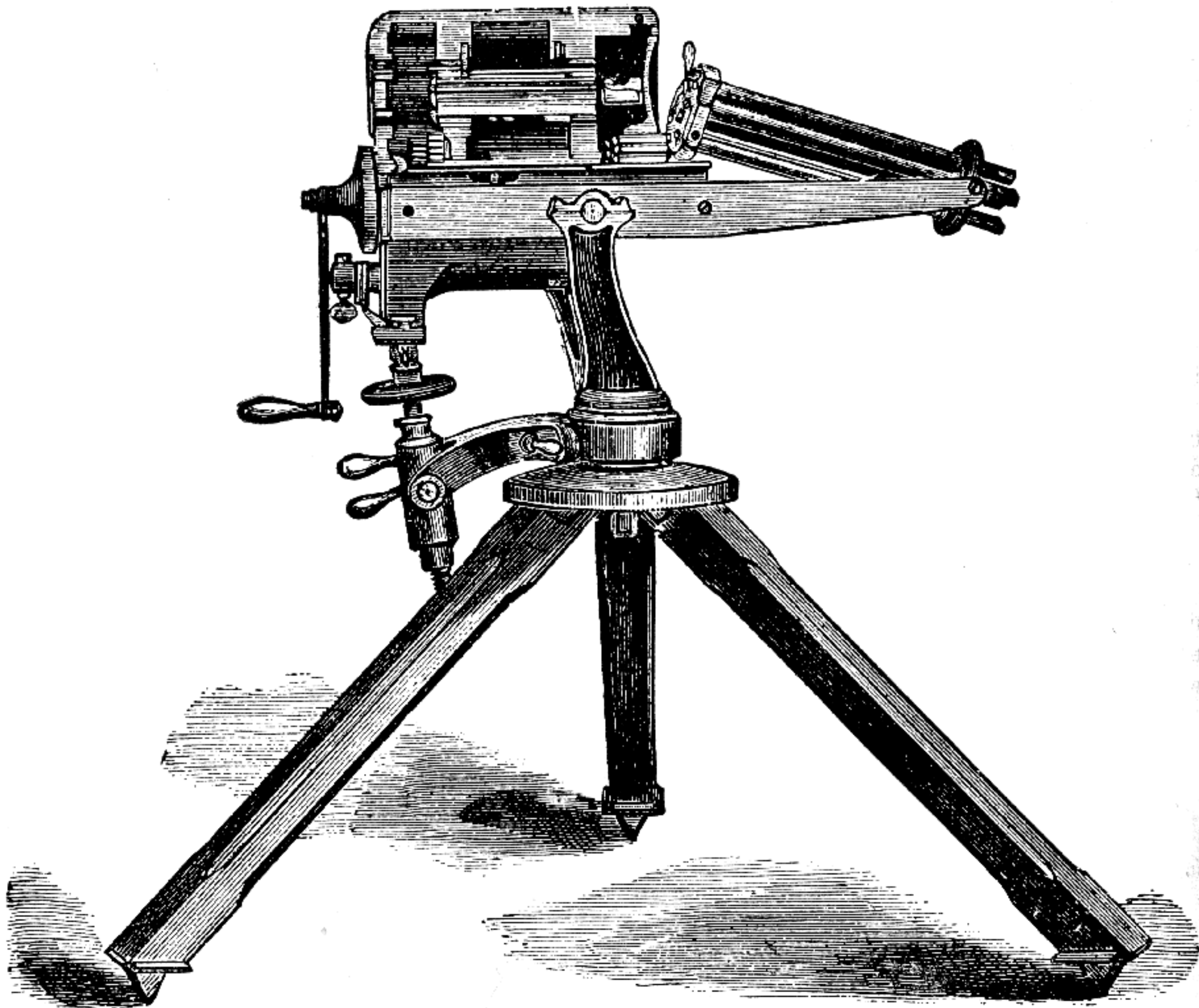

Lowell Machine Gun with Cover Open and Barrels Depressed for Inspection.

could still be rotated easily with the shifting lever.

Farrington had had trouble in doing this in a previous unofficial test. Therefore, a clearance of  $\frac{1}{64}$  inch had been made between the breech end of the barrels and their fastenings in the main body of the receiver to compensate for expansion from heating.

Near the end of the day, Farrington asked to be allowed to use a new method of detonating the primer in lieu of the conventional spring-loaded firing pin. He called it a system of firing by pressure. The tip of the firing pin was forced into the primer by a cam arrangement striking a lug on the assembly at the instant the weapon

was securely locked. Farrington claimed the lurching forward of this heavy piece crushing the primer would bring about ignition as effectively as the quick snap effect heretofore administered by the spring-loaded firing pin.

An attempt to fire 550 rounds was made using the new method. All but 15 of the primers ignited. Farrington explained to the officers present that the novel principle was really undeveloped. Its discovery had been the result of observation from an unofficial test, when he found he could fire the weapon with the firing pin spring removed.

The Naval board was much impressed by this system of detonating the primer and went so far

as to make drawings of modifications that, in its opinion, would make it more reliable. This bit of observation on Farrington's part, and the helpful suggestions made by Lt. Comdr. Crowninshield and Lt. Edward Very, were the origin of what is known today as inertia firing. It has been basic in machine-gun design ever since.

Several 300-round bursts were checked for rate of fire. The two best rates recorded were one in 50 and the other in 53 seconds. Since the cycle of operation was governed by the operator's strength in rotating the crank, this rate could be increased or decreased at will.

The firing records show only four malfunctions in the total number of rounds expended during the day's firing. Of these, only two hang fires were considered serious by the firing officer. No damage was done in either case to the firing mechanism. One of the hang fires exploded, driving the bullet into the barrel. After an examination showed the weapon could continue firing, the plugged barrel was rotated out of the way with the idea of driving out the bullet at the end of the burst. At the end of firing, however, the barrel was found to have been so hot that the bullet had melted, making removal very difficult.

Inventors of this era were quick to capitalize on even the smallest things. Farrington, therefore, pointed out that no other weapon could so quickly resume firing when a barrel had been hopelessly plugged by the worst malfunction imaginable—a shell going off when the weapon was unlocked, leaving a bullet in the barrel. The total time involved after the accident until firing was resumed was recorded by the observers as being 40 seconds.

The rate of fire of the Lowell was well over the minimum previously agreed upon as a practical rate for manually operated machine guns. The board recommended that more consideration be given to simplicity of mechanism, possibility of getting out of order, feed and extraction methods, durability, and accessibility of parts. It further stated that of all the machine guns known to them, the Lowell mechanism had been brought closest to perfection.

Following its creditable performance at Annapolis, the weapon was sent back to the factory. There all the modifications suggested by the board, plus many features Farrington believed

would constitute improvements, were built into the gun. Finally, when it was thought ready for the grueling bursts of fire demanded by the Navy during this period of machine-gun development, it was returned for another test. The records of this performance show the stamina of the improved weapon.

The whole program was carried out with unusual speed. Commodore Jeffers issued the order authorizing the trial on 12 July 1877. The weapon arrived at Annapolis at 8 a.m. on the 13th. By the next afternoon, 50,000 rounds had been fired through the weapon. And on 16 July 1877, the full report, including all firing data, recommendations, and conclusions, was in the hands of Commodore Jeffers who, with high officials, had witnessed the trial in its entirety.

The report is far too bulky to give more than the high lights. The most outstanding is the statement of the firing officer, Commander R. S. McCormick, concerning the weapon's over-all performance.

"There were two stoppages only during the prolonged test of the gun. The first which occasioned a delay of 68 minutes was caused by the crank and internal gear which are connected together, binding upon the crankstud for want of lubrication. The second which consumed seven minutes was due to the shanks of the extractors having been probably sprung by the explosion of a cartridge left intentionally partly inserted in the barrels, to try the effect of their heat on it, aided perhaps by the action of a serious hang-fire that had occurred in the rolls. It was necessary to shift lock once, the firing pin having become jammed by the back fire of a cartridge which had been pierced through the cap. The old lock was repaired and made ready for use by simply hammering back the firing pin and then pouring alcohol into its cylinder [firing pin recess]. The trial showed the great advantage of being able to throw out of use altogether and without delay a barrel which from any cause had become choked. At the end of the trial the gun was taken apart and carefully inspected. No wear or signs of failing were discovered about any of its parts."

In view of the fact that the United States was not at war, and there was not even the slightest indication of trouble in the near future, the

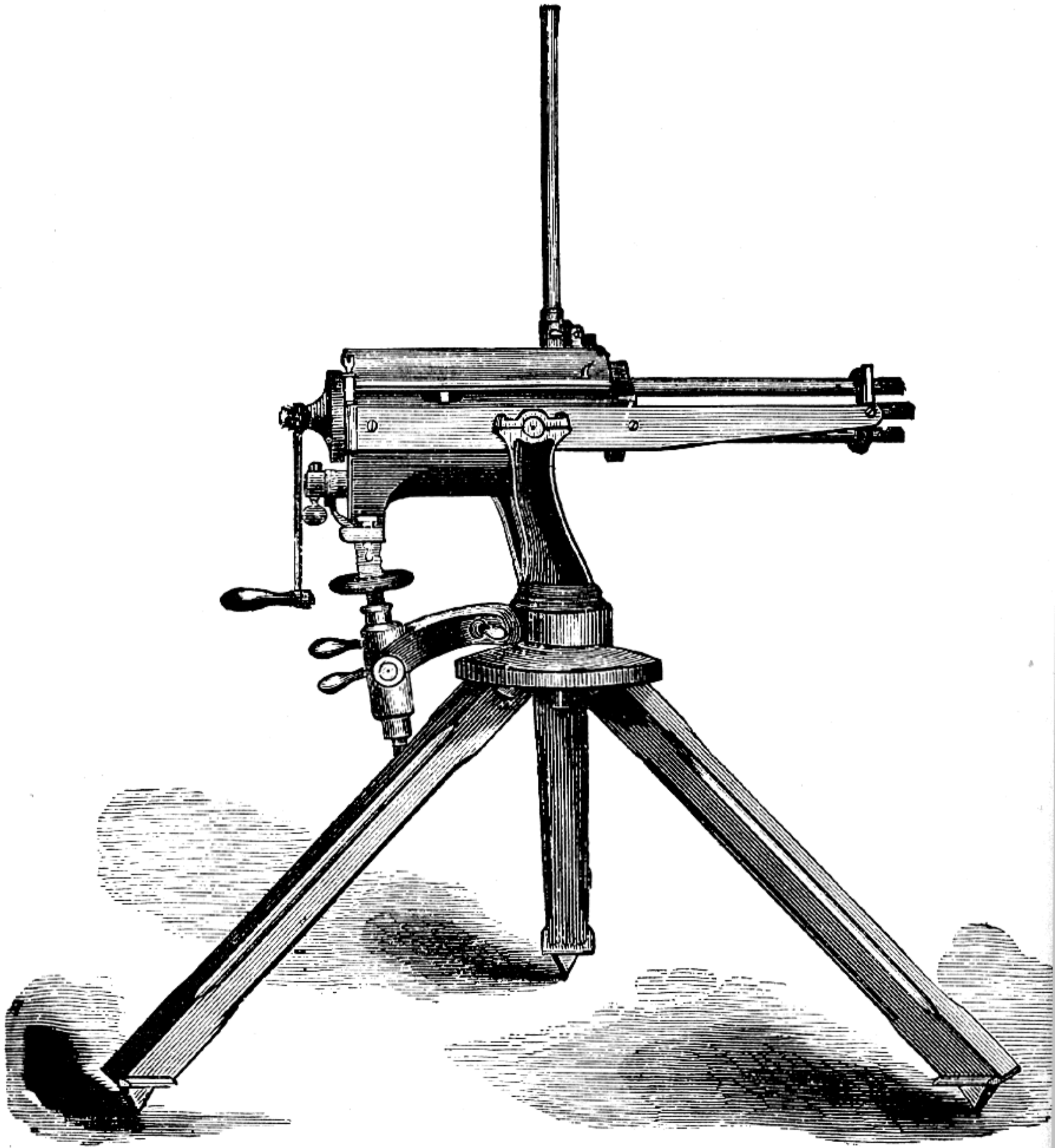

Lowell Machine Gun with Tripod Mount.



rapid development of machine guns by the American Navy at this time was indeed out of the ordinary. The early tests of the Lowell gun were remarkable for a prototype weapon, as there seemed to be no limit to the ingenuity of DeWitt Farrington in adding improvements to an already reliable mechanism. This was especially unusual since he had no Government contracts to encourage him financially. However, the Navy did give the weapon every consideration possible in the way of testing facilities and advice. The firing officers even went so far as to make suggestions and prepare drawings on features that they thought would be beneficial to its operation.

One of the improvements requested was the simplification of the bulky design of the rear housing containing the two feed rolls. With this in mind, Farrington worked out a modification which retained all the good qualities of positive extracting and ejecting. Only one roll is used in conjunction with a cam-operated feed arm that positively places a cartridge in position for the plunger to chamber and fire. In this change the cartridges are fed, not directly into the flutes of the rolls as before, but upon an inclined surface. They are placed into the recess by a spring-loaded finger that is held back until the proper moment by a roller cam functioning only when the roll is at rest. The round is positively held in the flute of the roll, until it is revolved into the prolongation of the axis of the barrel. There it is chambered by the plunger lock. The design is thus improved by permitting a more streamlined housing.

The single feeder roll is locked by the fluted plate on the roll shaft whose flutes are concentric with, and ride upon, the disc on the main shaft. This action prevents any motion of the rolls until the recess in the disc is opposed to, and frees the corner of, one of the flutes. The stud on the disc then comes into action and engages a tooth of the carrier allowing it to turn only one flute and stop. The feed finger is now cammed forward, positioning the round.

It was recognized that the second cartridge which exploded in the feed rolls during the early test might have been the result of the firing pin prematurely searing off, while the lock plunger was chambering the round—instead of a too hasty

unlocking of a hang fire as was first stated in the firing records. In order to make certain that the modified weapon could not be seared off accidentally (as had been possible with the first gun), the main cam, or the lock plunger driving cam, was fastened to the main shaft. It was so designed that the firing pin was retracted and cocked during the forward motion of the lock plunger. The cocking lug was removed as an obstruction only when the weapon was securely locked. This eliminated the possibility of accidental discharge in the act of chambering.

A handle for shifting the barrels was placed on the front side of the rear barrel disc in order to make the lever stronger. It permitted the extension of the carrier roll so that the flute served as a guide to within a sixteenth of an inch of the chamber entrance.

There were a few other modifications, such as placing a plate in front of the breech ring to hold the barrels more firmly and a change in the way the weapon was connected to the traverse mechanism and elevating screw. The latter proved to be undesirable. Firing was interrupted on an average of once every thousand rounds because the brass separated and left a portion in the chamber to jam the incoming round.

The demonstrators were successful in getting off a 2,000-round burst, on which the rate of fire was recorded as being 452 rounds a minute. This was a marked increase over the first Lowell model. When a second man on the crank was added, the gun later reached a rate of 600 shots a minute.

After 4 hours 57 minutes of firing, the board of officers stopped the test. They felt at this point it should be established whether the weapon or the ammunition was at fault, with regard to the consistent splitting of cartridge cases. Out of 19,200 rounds fired throughout the day, 1,803 had split the brass down the side. A few had ruptured, leaving a portion of the empty case in the chamber.

A Remington infantry rifle with perfect head spacing was brought to the range, and 500 rounds of the ammunition were fired. Upon examination of the empty cases, 105 were found to be split in the same manner as were the ones fired in the Lowell gun. To be more certain that the gun was not at fault, a sulphur cast was made of each

chamber. When gauged, they were found to be of correct dimensions.

As no other ammunition was available, the board deemed that a continuance of the trial would only expend labor and material without furnishing any information as to the real quality of the gun after its alteration. Testing was postponed therefore.

A comparison of the Lowell gun with its rivals detracted nothing from the performance. It used only one lock, and was able to change quickly from an overheated or disabled barrel to a cool and serviceable one, maintaining in this manner a continuous fire. It was most certainly a wonderful example of the skill and ingenuity of gun designers of this period, who thrived on competition and welcomed opportunities to pit inventive skill against all problems.

After the unsuccessful attempt resulting from the bad lot of ammunition, no further test was made of the weapon until 7 May 1879. The gun was then returned to the Experimental Battery, accompanied by 25,000 rounds of ammunition, furnished by the Lowell Co., and made expressly for the test by the United States Cartridge Co., also of Lowell.

It seemed to have been an ironclad policy of

the Navy to take under consideration practically anything offered. Before a weapon could be sent to the proving ground, all claims made for it must be verified at the Experimental Battery of Annapolis. This Battery superintended all prototype firing and offered to the inventor any help or suggestions that would better the performance of his firing mechanism. It permitted the inventor, or company representative, the privilege of actively operating the weapon himself, or of designating some particular individual, if it was felt his knowledge and experience would help it pass the severe trials for endurance and speed.

It will be noted that once a test got under way, a delay for any reason whatsoever was counted against the rate of fire. In taking a specific rate of fire, a 5-, 10-, or 15-minute burst was shot, followed by counting the empty brass on the ground.

The results of this 1879 trial are hard to believe when compared to our present-day conception of machine guns. Therefore, the report of the day's firing is given in its entirety. A more complete picture may, thus, be obtained of the requirements demanded.

The following tabulation outlines the test chronologically:

	Times H.M.S.	Car- tridges fired	Remarks
Commenced firing:			
No. 1 barrel .....	11.45.00	500	The gun has considerable vertical vibration.
No. 2 barrel .....	46.42	1,000	
No. 3 barrel .....	48.34	1,500	
No. 4 barrel .....	50.17	2,000	
No. 1 barrel .....	51.50	2,500	All parts of the gun working well.
Changed man at crank .....	52.10		
No. 2 barrel .....	53.50	3,000	No delays over 2s. in shifting the barrels or the men at the crank.
Changed man at crank .....	54.31		
No. 3 barrel .....	55.33	3,500	
No. 4 barrel .....	57.20	4,000	
No. 1 barrel .....	58.53	4,500	A slight breeze blew the smoke directly to the rear causing much annoyance to the men serving the gun.
Changed man at crank .....	59.00		
No. 2 barrel .....	12.00.38	5,000	
Ceased firing .....	02.06		
Commenced firing:			
No. 3 barrel .....	12.18.00	5,500	5,000 cartridges were fired in 17m. 06s. which is at the rate of 292 per minute.
No. 4 barrel .....	19.35		
No. 1 barrel .....	21.13		

	Times H.M.S.	Car- tridges fired	Remarks
No. 2 barrel .....	22.50		
No. 3 barrel .....	24.05		
No. 4 barrel .....	26.12		
Stopped .....	27.13		Delay of 18s. caused by the splitting off of a piece of brass lining which was soldered in head of feeder.
No. 1 barrel .....	28.00		
No. 2 barrel .....	29.40		Changed feeder.
No. 3 barrel .....	31.20		
Stopped .....	33.10		A cartridge shell failed to extract. Delay of 20s.
No. 4 barrel .....	33.50		
Ceased firing .....	35.25	10,000	
Commenced firing .....	1.03.15		
Changed barrel .....	3.50		At 1h. 03m. 50s. a shell failed to extract, delay of 10s.
Ceased firing .....	6.56	12,000	
Commenced firing for maximum speed .....	2.04.56		The bearing of the [finger pivot] was found to be loose, and the points of the extractor hooks appeared to be much worn. (Afterwards cleaned and found to be broken off.) Changed lock and screwed up bearing of the finger pivot.
Ceased firing .....	2.06.56	12,740	
Commenced firing for maximum speed .....	2.10.00		740 cartridges were fired in 2m., which is at the rate of 370 per minute.
Stopped firing .....	2.10.35	12,980	
Resumed firing for maximum speed .....	2.15.00		240 cartridges were fired in 35s., which is at the rate of 411 per minute.
Stopped and changed barrel.	2.16.00		
Resumed firing .....	2.16.12		At 2h. 16m. 00s. a shell failed to extract: delay of 12s.
Stopped .....	2.17.35	13,950	
Commenced firing .....	2.20.00		At 2h. 17m. 35s. there was a jam caused by one of the leaves of the carrier roll being split at its rear end and turned into its flute, preventing the entrance of the lock. Cause unknown. The leaf was pushed back into line and at 2h. 20m. 00s. resumed firing at a slow speed.
Ceased firing .....	2.20.20	13,980	
Commenced firing for maximum speed .....	2.25.00		Gun worked well. No. 4 barrel alone was used, and it became very hot, inflaming paper and pine splinters.
Ceased firing .....	2.27.37	14,980	
Commenced firing for maximum speed .....	2.33.00		No. 1 barrel alone was used, with same results as above.
Ceased firing .....	2.35.30	15,980	
Commenced firing .....	3.03.30		The gun mounted on its field carriage and depressed 34° was fired without traverse from the sea wall into the water.

	Times H.M.S.	Car- tridges fired	Remarks
Jam .....	5.05		At 3h. 05m. 05s. a shell was torn near the ball in loading and caused a jam. Delay of 40s.
Resumed firing .....	5.45		
Changed barrel .....	7.30		
Jam .....	10.20		At 3h. 10m. 20s. jam same as above, delay of 10s.
Resumed firing .....	10.30		
Changed barrel .....	11.45		
Jam .....	12.13		At 3h. 12m. 13s. jam same as above, delay 5s.
Resumed firing .....	12.25		
Changed barrel .....	15.14		Examination of the cartridges shows that in many of them the shells are not properly crimped around the balls, which is probably the cause of their tearing in loading.
Failed to extract			
Changed barrel .....	18.15		
Failed to extract			
Changed barrel .....	19.10		Gun seemed to work less easily. A screw pin of one extractor works out.
Ceased firing .....	20.50	19,980	
Commenced firing .....	3.32.00		Gun mounted as before and depressed 34° was fired with full traverse.
Changed barrel .....	33.30		
Jam .....	3.34.20		At 3.34.20 jam from torn shell as before, delay of 25s.
Ceased firing .....	35.36	20,980	
Commenced firing .....	3.48.25		
Ceased firing .....	52.13	21,980	Gun mounted on its rail pivot and fired from sea wall into the water. Depressed (about 25°) and trained by means of the training bar. The man turning the crank attended to the training bar until 600 cartridges were fired, after which the training was done by another man. Examination of the lock showed that one of the extractor hooks was broken at the point—changed lock.
Commenced firing .....	4.01.12		Gun mounted on its field carriage—depressed 34°, was fired from the sea wall into the water. At 4h. 04m. 20s. a shell was torn in loading as before—delay of 10s.
Jam .....	4.20		
Failed to extract .....	4.07.10		At 4h. 07m. 10s. a shell failed to extract—delay of 10s.
Ceased firing .....	4.11.26	23,960	The gun was examined and found to be in serviceable condition with the exception of the broken extractor hooks.
Cartridges fired in preliminary shots during trial .....		40	
Total .....		24,000	

*Résumé*

Total number of cartridges fed to the gun.....	24,000
Greatest number per minute (at 2h. 16m. 12s.) .....	407
Misfires (bad primers) .....	39
Shells torn in loading .....	10

A similar test was also conducted by the Army at the Sandy Hook Proving Ground with practically the same results as the Navy had obtained.

While the most skeptical individual was forced to marvel at the reliability of the weapon, the fact remained that this country had no immediate need for the gun. The limited encouragement given by Naval adoption of the gun was not sufficient in a financial way to keep the Lowell

Firearms Manufacturing Co. solvent. A few were delivered to the American Navy, 20 were sold to the Russian Navy, 3 went to the State of California for its prisons, and 1 to the police department of the city of Cincinnati. After these sales, the Lowell Co. collapsed, but not before DeWitt Farrington had contributed certain basic principles of design that have been used to the present day.

## WILDER MACHINE GUN

The phenomenal success of the Gatling and Gardner guns led many inventors in this country to design weapons that, in their opinion, were superior. In doing so, they hoped to sell their products to the Government, but if no interest was forthcoming, then to any foreign power that would adopt them for service use. One of the most outstanding examples of an attempt to better machine-gun design by sheer engineering ability was the gun invented by Elihu Wilder of Hillsborough, N. H. In 1876 he made a prototype weapon capable of being demonstrated.

The Wilder gun was made with five barrels in a semicircle, fastened rigidly fore and aft. The barrels did not revolve, which, Wilder claimed, allowed him a great advantage in loading. With revolving barrels the ammunition had to feed through one port and be chambered as each barrel followed the other in the cycle of rotation. With his system each barrel had its own cartridge inlet which enabled one to load considerably faster, and to use, at will, any or all of the five barrels.

Wilder pointed out that other machine guns using stationary barrels side by side, or in stacks, necessitated an equal number of locks. As firing capacity and the number of locks are increased, so do the chances of their getting out of order, to say nothing of the additional cost, weight, and bulk. However, with the five barrels placed in a half circle, as Wilder had done, the weapon was not only much more compact, using only two locks; but one cam could operate all the bolts, fore and aft. This was especially important, since the action of the bolts was independent of either the striker or the hammer, thereby eliminating the wear and friction that most weapons of this type would naturally have. Wilder positioned his two locks opposite each other. This enabled him to discharge all the barrels with a half turn of the crank; in other words, each barrel was fired twice during one revolution of the crank,

giving a rate of fire double that of similar weapons.

His extractors were the double-jawed kind that cammed over the rim of the cartridge when the bolt was in battery with the cartridge in the chamber. This presented a solid T slot until initial extraction had been accomplished.

The original weapon used the caliber .45-70 service cartridge and first was designed for tripod firing, although provision was made whereby it could be mounted on the standard howitzer limber.

After the five feed guides are filled to a capacity of 50 rounds each, the feed stop pawls are placed on *open* and the weapon is ready for action. As the rotation of the operating handle begins, a cartridge is dropped into the top recess and brought immediately in line with its intended barrel. The forward travel of the bolt forces the round into its chamber by the engagement of the lug that rides in the cam. At the same time the hammer is cocked by a ratchet-type cam, compressing its spring. It sears off at the high point, and the hammer snaps forward, driving the firing pin against the primer with great force and firing the cartridge. Located diametrically opposite each other are two such hammers for the five barrels—a very simple system that would save much maintenance.

The weapon having been fired at the conclusion of an intended time lag, a helical cam with a steep slope jacks the bolt rearward with great speed, carrying with it the empty cartridge case. At a distance slightly greater than that of the empty case the extractors relax all hold on the rim of the case, and a section of the star-wheel guide revolves the empty case free of the working mechanism, where it is released to drop out of the gun by gravity.

This method of completely releasing the brass by the extractors before ejection functioned perfectly when firing horizontally. For shipboard

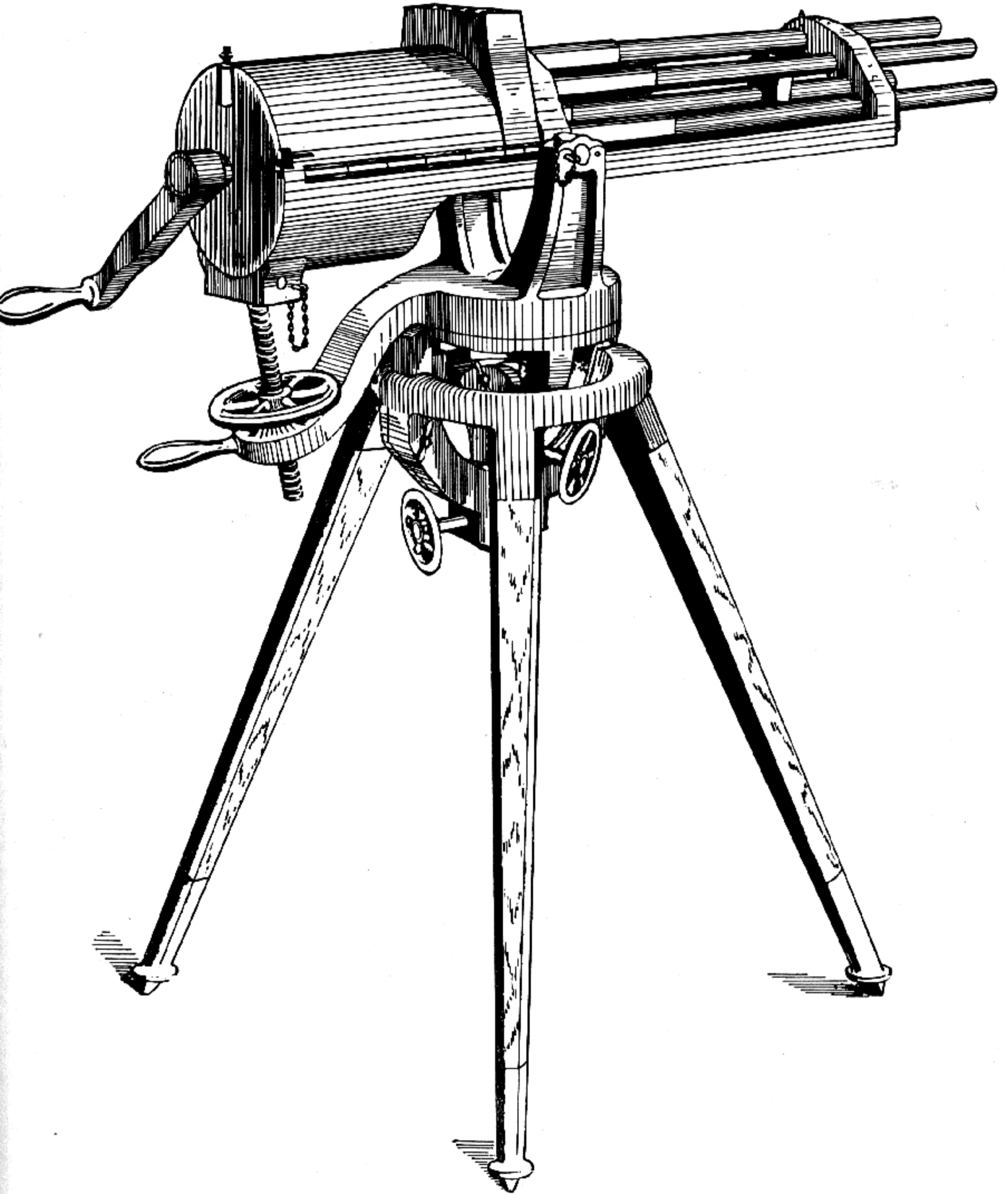

Wilder Machine Gun on Tripod Mount.

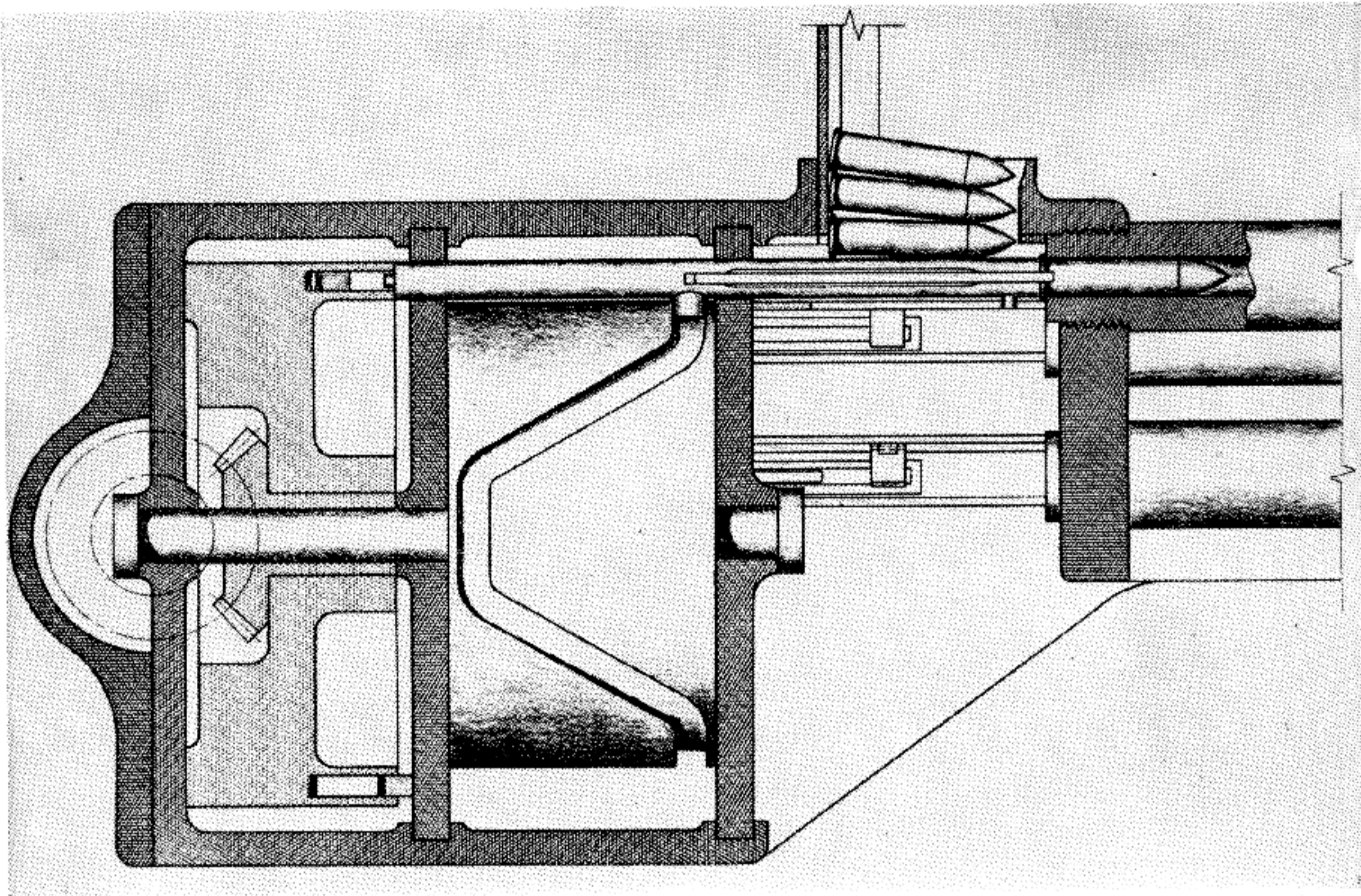

Section Drawing of Wilder Machine Gun.

use, however, where firing was sometimes straight down, the cartridge would drop back in the chamber before the star wheel rotated it to strike the ejector fingers. To overcome this fault, five levers were used (one for each barrel). Actuated by cams, they would swing in between the spent cartridge and the chamber, until ejection was completed, and then return to their normal position, leaving the barrel open to receive the next round.

The ejectors, called by the inventor "abutment fingers," forced the empty cases out of the star wheel and insured that they could not fall or bound back into the mechanism. In the bottom of the receiver a deflection plate helped to control the flight of the brass and kept spent cartridges from piling up in the housing when firing at a high rate.

The Wilder gun was optionally equipped with a water jacket and a device giving the muzzles a lateral motion to and fro during firing. There was also a three-barrel version of the weapon in-

tended for mounting on horseback. This smaller arm weighed only 70 pounds, and was rated as being capable of firing at a speed of 1,000 rounds a minute. This fire power was doubled in the five-barrel version. Brig. Gen. Charles Benjamin Norton, former United States Commissioner to the Paris Exposition, referring in 1882 to one of the guns which had been displayed there, stated, "It is claimed this arm is capable of being fired at a rate of 2,000 shots a minute, this being based on results of a late trial where 200 shots were fired in 6 seconds."

There is no doubt that the Wilder gun would have furnished serious competition to contemporary weapons if the inventor had not died shortly after his first models were produced. Little was done with it until nearly 20 years later when his widow sold her interest to a Boston concern which, no doubt, planned production of the weapon.

By this time manually operated guns were doomed, regardless of cleverness of design or rate



of fire, as the fully automatic machine gun had become a reliable weapon.

The Wilder gun in reality embodied the Ripley principle made to employ a feed system capable of producing sustained fire. In doing this, Wilder used Gatling's mode of feeding practically in its entirety. It seems ironical that this weapon could very easily have furnished stiff competition to the Gatling, which was likewise very similar to the Ripley mechanism.

A large caliber weapon was under design by the inventor before his death. It was to use the 37-mm round of the Hotchkiss revolving cannon

and had a high rate of fire resulting from the fact that only the firing mechanism revolved in place of the heavy barrels of similar guns. Its easy cycle of operation, combined with the devastating explosive effect of the projectile, would have made a naval weapon of great destructive possibilities against torpedo boats and other lightly armored vessels. It was later estimated that its rapidity of fire would have been four times that of the Hotchkiss. However, there was no immediate need for the gun, and without stimulus the 37-mm version was never carried beyond the blueprint stage.

## J. H. McLEAN'S "PEACE MAKERS"

For some reason the profession of gun design and development seems to have been infested with more phonies than any other known vocation. It would be a great injustice to the true craftsmen of the manually operated machine-gun era not to mention in contrast the alleged inventions of Dr. J. H. McLean and his assistant, Myron Coloney. These men invented more mythical weapons, had more publicity, and accomplished less than anyone since Puckle.

McLean was born in Scotland in 1829, and a few months later his father emigrated to Nova Scotia. At the age of 13 the boy left home and followed the frontier west as far as St. Louis, where he attended a medical college. He decided, at this time, to concoct a preparation known as a "strengthening cordial" which, according to advertisements, would cure just about anything from pink eye to paralysis. The returns from his patent-medicine sales, which were practically all profit, soon made McLean immensely wealthy. At this point he entered the gun-development

field. This sudden change in professions was no doubt due to a chance meeting with Myron Coloney of New Haven, Conn., a self-confessed inventor of great reknown.

This pair set out upon a mission, the scope and ambition of which the world has never known; they patented impregnable forts, unsinkable ships, repeating cannon, gun-launched torpedoes, repeating pistols, rifles, and machine guns of all descriptions. The best insight into the aims of McLean and Coloney can be obtained by quoting from a 200-page brochure advertising their world-shaking ordnance designs and extolling the inventors. The pamphlet, entitled *Imperial Edict*, was written by the promoters themselves, but was phrased stiltedly in the third person.

"Dr. J. H. McLean's Strengthening Cordial and Blood Purifier, with his other prepared medicines, can now be found in drug stores in nearly every village, hamlet and home in the Western and Southern States—in fact, in many places in Europe as well as the United States—accessible to the poor as well as the rich. That humane mission fully accomplished, that great life work carried out, one might think would be sufficient; but the Doctor's great heart burned to go on—go on to do more for his fellow men. Hearing of the killing and slaughter of the brave soldiers in Europe and Asia at the will of their rulers, he resolved to develop such terribly destructive weapons of war, arms, torpedoes, and fortresses, and such perfect defenses, as would compel all nations to keep peace towards each other.

"'Save the Lives of the People' is his motto.

"In pursuing his professional career unaided and alone, he amassed a large fortune. The people of the Mississippi Valley know well Dr. J. H. McLean's Grand Tower Block and his vast Laboratory. With him to will is to do and to have done, having all the means necessary at his



Dr. James H. McLean.

command, and the brain and vital force to carry out his enterprises. He has succeeded in developing, and now presents to the world, the most terribly destructive weapons of war, from a 48-shot pistol and 128-shot rifle (self-loading) up to cannons of all grades; Battery (machine) Guns capable of firing from 600 shots a minute up to 2,000 shots a minute, and sweeping an area of six miles; Infantry and Rifle Protection Forms; Floating and Permanent, *absolutely impregnable* Fortresses; swift-sailing vessels, which cannot be sunk by perforation. . . .

"When the world has fully realized the grand success of the crowning act of the life of Doctor James Henry McLean . . . we think all will acknowledge that he is truly a Man of Destiny, a great *reformer* in the highest sense of the word, and a savior of the tyrannized and down-trodden human race. 'So mote it be.' "

It will be noted that McLean could not resist the temptation to list the wonderfully curative powers of his patent medicine at the same time he described the awesome engines of war he and Coloney invented. It is hard to believe any man could write about his own accomplishments in such glowing terms without stretching his ego to the exploding point.

Myron Coloney, in writing about himself in the same pamphlet, left no indication that he was suffering from an inferiority complex and admitted that he even startled himself, at times, with his various gun inventions. A short quotation is given from the many pages he wrote about himself.

"Myron Coloney was born in St. Lawrence County, N. Y., on the 24th of April 1832, and when still quite young, exhibited great constructive skill and mechanical ability in building boyish sawmills, apple-paring machines, animal traps & etc., of curious and novel workmanship. Amongst those rich traits of character with which he was endowed, there was also a deep love for literature. This desire grew almost into a passion, and determined the young lad to enter a printing office, rather than follow his father's more successful trade. . . .

"Among the most important creators of wealth, in any nation, are the inventors. They



Myron Coloney.

are the pioneers in merchandising, in mechanics, and in the arts of sciences. One class of ingenious men invents a new forcible and impressive method of making known their business and of selling their wares, and thereby secure wealth for themselves and afford a means of livelihood to their employees. Other inventive minds, of a mechanical turn, perceive defects in mechanism, and thereupon, originate new devices which cheapen cost and increase production. Both of these classes, in their way, are creators of the wealth of a nation.

"There are others, and great inventors, who, with one master stroke of genius, wipe out all past works of a class and create instead better and more useful forms, which in their application, give employment to the many, and contribute to the general prosperity of the nation. The effort of their genius may be directed toward improvements in the tools employed in husbandry, or towards the perfection of machinery for the manufacture of textile fabrics, or in an effort to create more powerful engines of war. Whatever may be the bent of their effort, the achievement is the same. The world is astonished at the result, and then commences to make use of the improvements, and carries them forward to ultimate perfection, employing the labor and the skill of thousands.

"To this class, we think, belongs Myron Coloney, one of the inventors of the Dr. James H. McLean Peace Makers. . . . Myron Coloney engaged at once with Dr. McLean, and removed to New Haven, Connecticut, where he could obtain the best skill and most able and intelligent mechanics, to superintend and develop these terrible engines of destruction, which are intended to strike terror to the heart of every enemy. Not only those devices . . . but other great inventions, which his fruitful inventive brain suggested and which he has since perfected, have been called into being, and which will create an enthusiasm and a sense of security in every nation on this globe, handing down to posterity the name of Myron Coloney, in connection with Dr. J. H. McLean's Peace Makers, with the great honor and credit."

These two self-acknowledged geniuses continued on for more than 200 pages on a subject they both loved, namely, J. H. McLean and Myron Coloney. They stopped only to illustrate the terrible engines of war conjured up in their frequent outbursts of brilliant design.

Their machine guns were given such colorful names as the "Annihilator," "Pulverizer," "Broom," and "Vixen." But like all strong men, the doctor had his weaker moments and named the most deadly of all his machine guns the "Lady McLean." The paramount motive behind the exorbitant claims of these "Men of Destiny" is to be found after reading 171 pages of sensational copy. At this point the author states:

#### "Fortunes to be Made Everywhere

"The important fact that companies formed in each nation for the manufacture of Dr. J. H.

McLean's Peace Makers can contract with their governments to convert all sound old-fashioned guns into these formidable repeaters at a great saving to the government must be steadily remembered. In this business alone companies can make fortunes in each nation. Address Dr. J. H. McLean, 314 Chestnut Street, St. Louis, Mo."

It is interesting to find, in studying the drawings of McLean's "improved" machine guns, that one rapid-firing cannon has a tubular feed on each side. In order to place the ammunition in this type of feed, the designer drew the cartridges without rims and with a cannellure exactly like the present-day rimless ammunition. While there is no record to show that McLean's great masterpiece ever fired a shot, there is strong likelihood that this drawing was seen later by some wide-awake inventor and developed into the rimless cartridge. It is hoped that this was the case, as it would be a shame that such self-admitted talent did not contribute anything to the field of machine gun development except a large stack of meaningless drawings and ridiculous claims.

Dr. McLean's project was the first attempt of a European to develop a machine gun in America. And should anyone be interested in looking further into his inventions, it will be noted that he remained close to the European demand for volley fire, whereby a number of stacked barrels were to be discharged simultaneously. This ordnance venture, however, proved that unlimited money and publicity cannot make a poorly designed weapon work if the inventor does not have the necessary skill. These self-appointed "geniuses," therefore, were unable to compete with the master mechanics of this era, who did have the happy faculty of knowing what they were doing.

## BAILEY MACHINE GUN

Another interesting machine gun tested by the Navy was designed in 1874 by Fortune L. Bailey of Indianapolis, Ind. One year later the Winchester Arms Co. had manufactured a working model, which seemed reliable enough to warrant a request for Navy consideration for purposes of adoption.

After an interview with company representatives, Commodore T. H. Patterson of the Navy Yard, Washington, D. C., on 31 January 1876, ordered a trial to be held on the Navy Yard Range. At the appointed time, 11 February 1876, the board convened. Commander Montgomery Sicard, Inspector of Ordnance, was the officer in charge.

The weapon shown was small in comparison with similar mechanisms, being made to use a caliber .32 rifle cartridge. The reason for this, according to Bailey, was that the gun being tested was built merely as a working model. Its performance had proved so phenomenal in private tests, however, that its producers had been convinced it was capable of being demonstrated.

The inventor called attention to the fact that until now all machine guns fired either from hoppers or drums. These were limited in their capacity of rounds. His weapon, however, had no such restrictions. It fired from a belt which could be made any length desired. He also made the astounding claim that the round would be fired without being withdrawn from the belt.

After the formal discussion, a close inspection was made of the weapon. Many unusual features were noted that had not been known in other machine guns.

In appearance the Bailey resembles the Gatling, with its barrels grouped around a central shaft and held securely by central discs fastened to the frame. But at this point all resemblance ends. The systems of feeding and firing are radically different from earlier types.

When the crank on the right side is turned,

the barrels revolve. Concurrent with this they have a reciprocating motion caused by successive engagement of an inclined flange, or cam. Sufficient play is, of course, allowed in the bearings to permit such fore and aft motion, and to compensate for the increased diameter of the metal due to heating from sustained bursts.

The firing is done from the top barrel. While this is taking place, the empty cartridge, still in the belt, is cleared.

A plate revolving with the barrels houses the firing pins and springs. As a barrel arrives at battery position, its firing pin is struck by one of the two plungers, or strikers, that alternate in firing. The dual plunger assembly consists of two flat pieces of steel with shanks on the rear end that serve as guides to the striker springs. These springs drive the plungers forward when the studs are alternately released from contact with the flanges of the cocking cam, located on the lock flange cylinder.

The cylinder is a simple, well constructed tube, firmly secured to the center shaft. About its circumference are two separate helical cams of rapid pitch. As the cams are rotated by the clockwise movement of the crank, they are brought into engagement with the studs on the reciprocating plungers. Each set of flanges manipulates its own plunger. As the cylinder con-

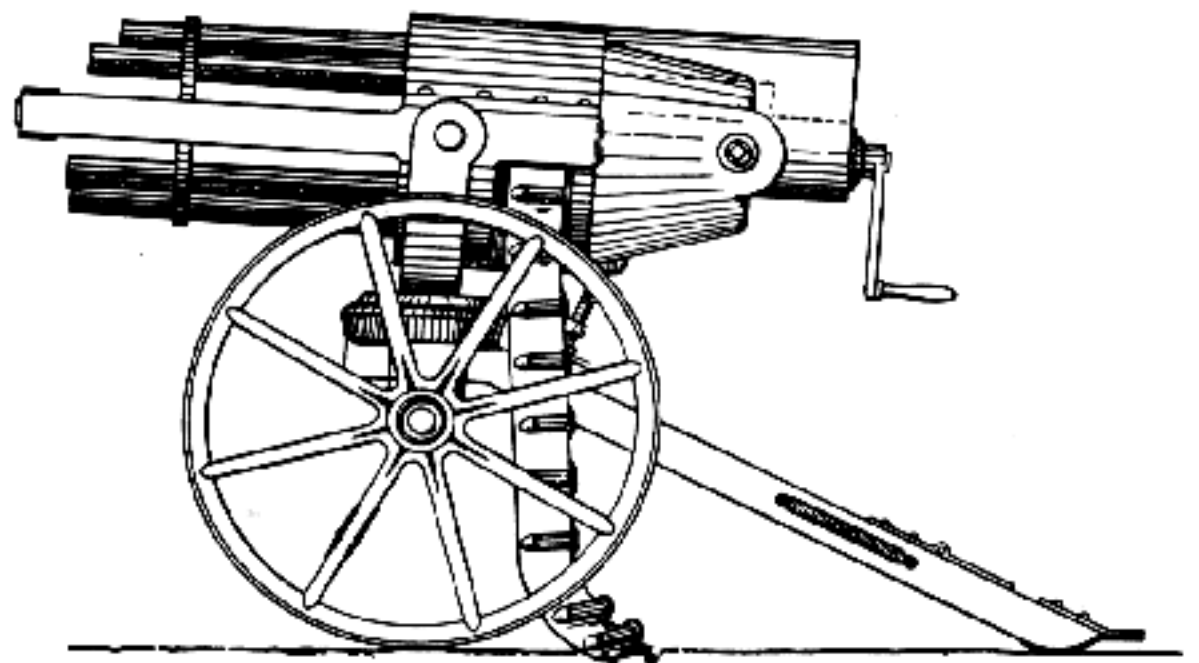

Bailey Machine Gun, the First Such Weapon to Use a Belt Feed.

tinues to turn, the cam that is engaged with a stud forces it back until the end is reached. At this point it sears off, actuated by the compression of the spring, and strikes against the floating firing pin.

As each barrel is fired, the continued rotation of the crank brings up the next one, with its firing pin in position to be struck by the alternate plunger. The weapon cannot possibly be fired until alined with the striker. Accidental firing before being in battery is impossible, as the weapon is secured for firing by the novel method of locking the barrel and not the bolt.

The plan for feeding and extracting is indeed extraordinary. A cylinder of wrought iron is fastened on the center shaft, just forward of the firing pin plate and inside the circle formed by the rear end of the barrels. Its surface is indented by recesses, the general direction of which is parallel to the axis of the center shaft.

These indentations mate with flat pieces of brass similarly shaped, which are riveted to the underside of the feed belt. This makes the cartridge belt a kind of flexible feed rack, running over the wrought iron drum.

The cartridge containers of the Bailey gun are conical-shaped brass sockets fastened at right angles to the flat side of the belt. They receive the loaded rounds when the ammunition is belted before firing. The distance between the rounds in the belt when mated with the recesses in the drum exactly equals that between the center lines of the chambers.

The cartridge containers are conical in exterior design, but are bored internally to receive the round. When the ammunition is pushed into

this device from the rear, the rim is seated in the slight recess made for it, while the entire bullet and the neck of the metallic case protrude through the forward end of the cartridge container.

When the belt is inserted in the left side of the Bailey gun, the cartridge holders are then positioned in a prolongation of the axis of the barrels and directly to the rear of them. The chambers of the barrels of the weapon are bored conically to receive and fit snugly over the cartridge-carrying belt sockets.

As the center shaft is revolved by the crank, the belt and cartridge containers are drawn over the alining cylinder. The cartridges in succession come opposite the rear openings of the barrels, and the reciprocating cam causes the barrels on the left, or loading, side of the piece to move rearward. While they revolve, each successive chamber covers more and more of its assigned cartridge container. By the time the firing position is reached, the whole container is covered, and the firing barrel is securely locked, the butt of the cartridge being backed up by the firing pin plate. With everything now in place, one of the plungers is released by running off the high point on the cocking cam, and the weapon is fired.

As the rotation continues, the discharged barrel starts to cam forward, pulling the chamber off the cartridge holder. By the time one quarter of a revolution is made on the crank, the belt section with the cartridge container and empty case is free to go out the right side of the gun, dropping vertically to the ground.

The Navy board found that Bailey had not brought a sufficient number of belts to warrant an opinion on reliability and endurance in a firing test. Therefore, it refused to take the weapon under consideration, but offered to allow him to fire any amount he wished in an unofficial demonstration.

Because the belts supplied by Bailey held only 100 rounds, and the reputed speed of the weapon precluded attaching additional ones after a burst had started, the sustained fire periods were of relatively short duration compared to Navy requirements. However, he was permitted to prove one point of this claim—rapidity of fire. One of these 100-round bursts was officially recorded as

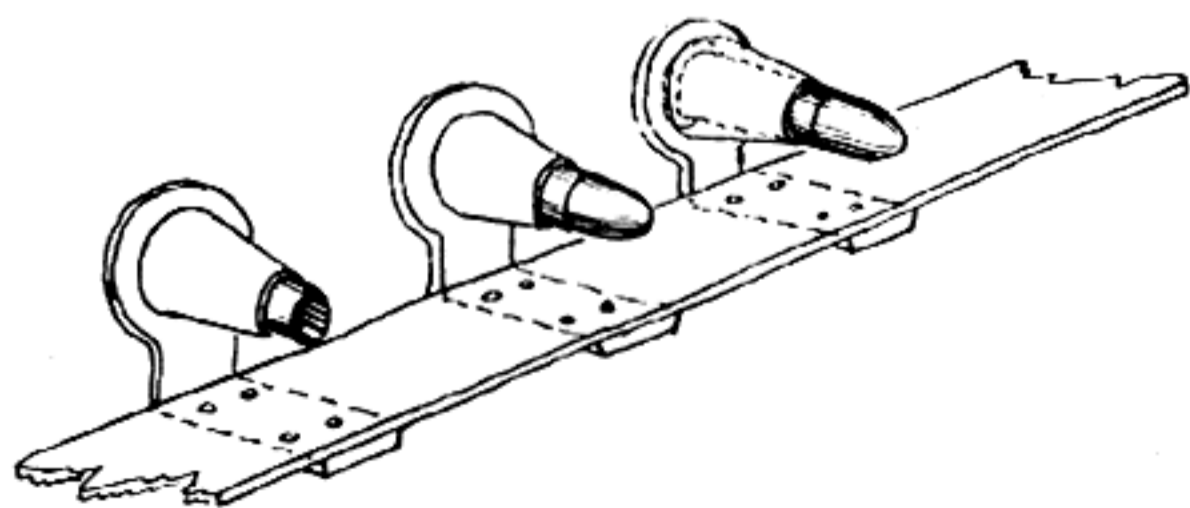

*Belt with Socket, & Cartridge*

Bailey Machine Gun Cartridge Belt. A Sketch Made by the Officer Who Tested the Weapon at the Washington Navy Yard, 1876.

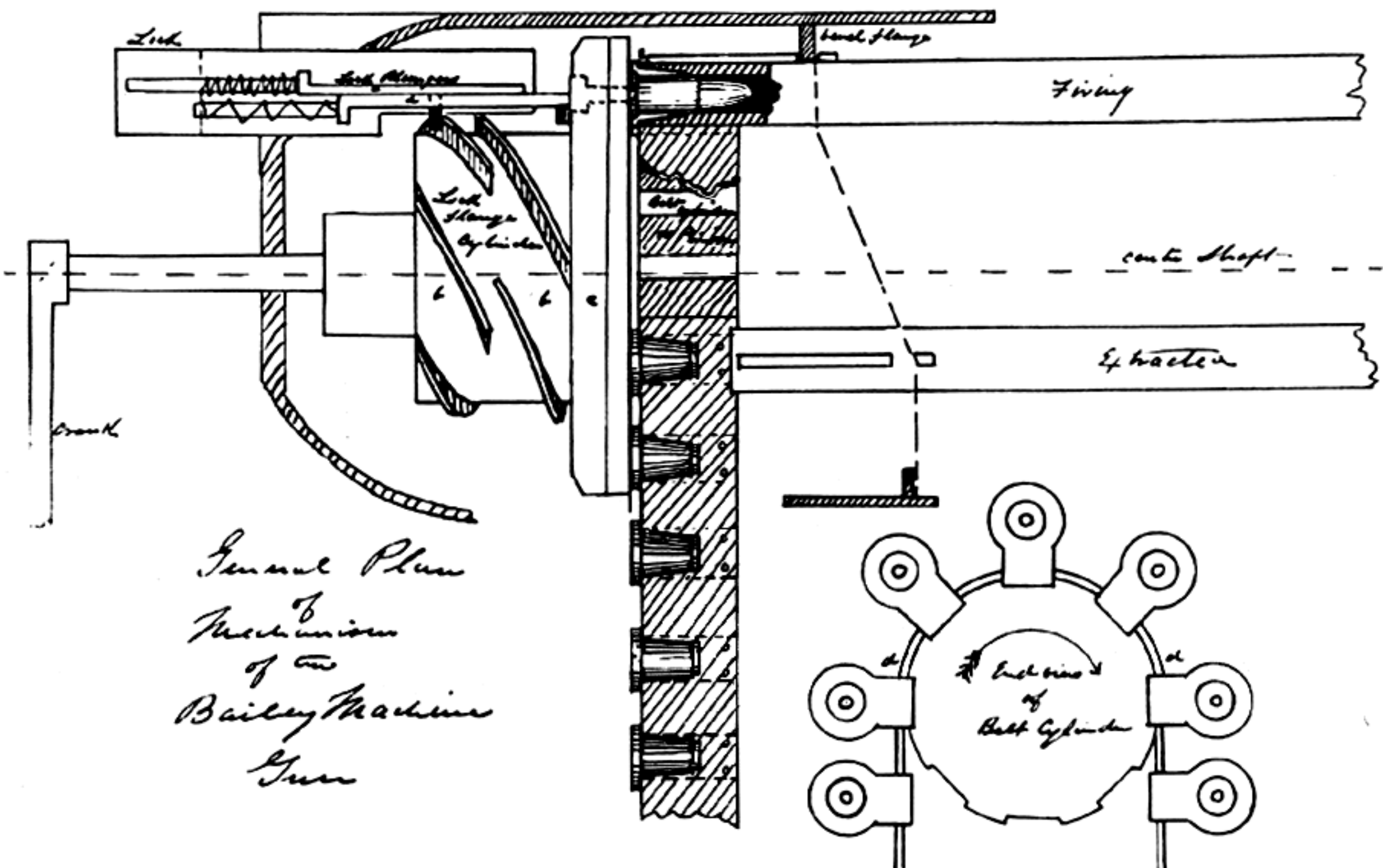

The Mechanism of the Bailey Machine Gun. Sketched During the 1876 Trials.

being fired in 6 seconds, or at a rate of 1,000 rounds per minute. This rate of fire impressed the officer in charge. Commander Sicard stated in describing the unusual performance: "The test that was made for rapidity of fire was, however, truly astonishing. One hundred rounds being fired in about 6 seconds, the gun appearing to be almost in a continual blaze, the whole number ran off smoothly."

Thus ended the first successful attempt to fire a machine gun fed by a belt, in lieu of drum or hoppers. Like many others in his field, Fortune Bailey did not gain financially, but he admirably overcame the bottleneck in machine-gun feeding. The novel mechanism he originated not only fed the weapon from a belt, but fired the round without ever removing it from the conveyor as it passed through the machine.

## NORDENFELT MACHINE GUN

At the same time that American inventors were bending every effort to produce a reliable fast-shooting gun, employing only one barrel at a time, European engineers were still trying to improve volley fire. This they considered to be the acme of perfection in relation to delivering a concentrated small arms fire.

The best attempt at perfecting a system of volley fire was done by Heltge Palmcrantz, a Swedish engineer. He originated a mechanism, very similar to the Claxton, that permitted the operator to keep up sustained fire, or discharge the barrels one at a time if desired. Locking and firing were accomplished by the operation fore and aft of a single lever; a separate gravity feed was installed over each barrel. The cartridge cases fell through openings in the frame, after they had been extracted beyond the length of the empty brass.

As was the case with most inventors, Palmcrantz was without funds to produce his weapon and had to appeal to a Swedish broker named Thorsten Nordenfelt, who at the time was conducting a banking business in London. The latter agreed to finance its manufacture, but not until the name was changed to the Nordenfelt machine gun.

The broker proved himself one of the world's greatest salesmen, as, by sheer merchandising ability, he promoted successfully a multibarrel weapon inferior to half a dozen other guns available at the time. Nordenfelt was a shrewd businessman who made every effort to meet the whims of influential people who could help him in disposing of his products. He constructed from 1- to 12-barrel versions in any caliber from rifle cartridge to artillery.

Realizing that England never took a weapon of this type under consideration unless it was actually built on English soil, his first move was to construct a manufacturing plant in the British Isles, with offices in London. His salesmen, and

in most instances Nordenfelt himself, never let an exhibition go by without the display of his product. If possible, a long demonstration was arranged to bring out the simplicity and reliability of the "Nordenfelt system," as it was now universally called.

The English Government's Small Bore Machine Gun Committee in 1880 laid down three basic conditions that must be met before a machine gun could qualify as being worthy of consideration:

"It must be capable of firing 400 rounds a minute.

"The breech of the barrel being fired to remain securely closed one third of a second, or ample time in the opinion of the experimental committee to insure safety from a delayed explosion of a cartridge (hang fire).

"To fire rapidly 1,000 continuous rounds at a speed satisfactory to the committee. That must not cause undue heating of the barrels."

These specifications favored the Palmcrantz system. This fact was exploited by Nordenfelt, as most of his trials were conducted with the 12-barrel rifle caliber gun. With this he could easily shoot 400 rounds a minute, or less than 50 rounds per barrel. A 1,000-round burst figures out roughly only 83 shots per barrel, so the problem of overheating the barrels did not exist.

Time has proved that the weapon, as far as design was concerned, was hopelessly obsolete while still in the blueprint stage. However, with respect to reliability, workmanship, and endurance, its performance in some cases was nothing short of phenomenal. For instance, at a test of the 10-barrel rifle caliber model, held at Portsmouth, England, in July 1882, the weapon fired 3,000 rounds of ammunition in 3 minutes 3 seconds, without a parts failure or stoppage. In other words, it maintained a rate of fire of 1,000 rounds a minute for three consecutive minutes.



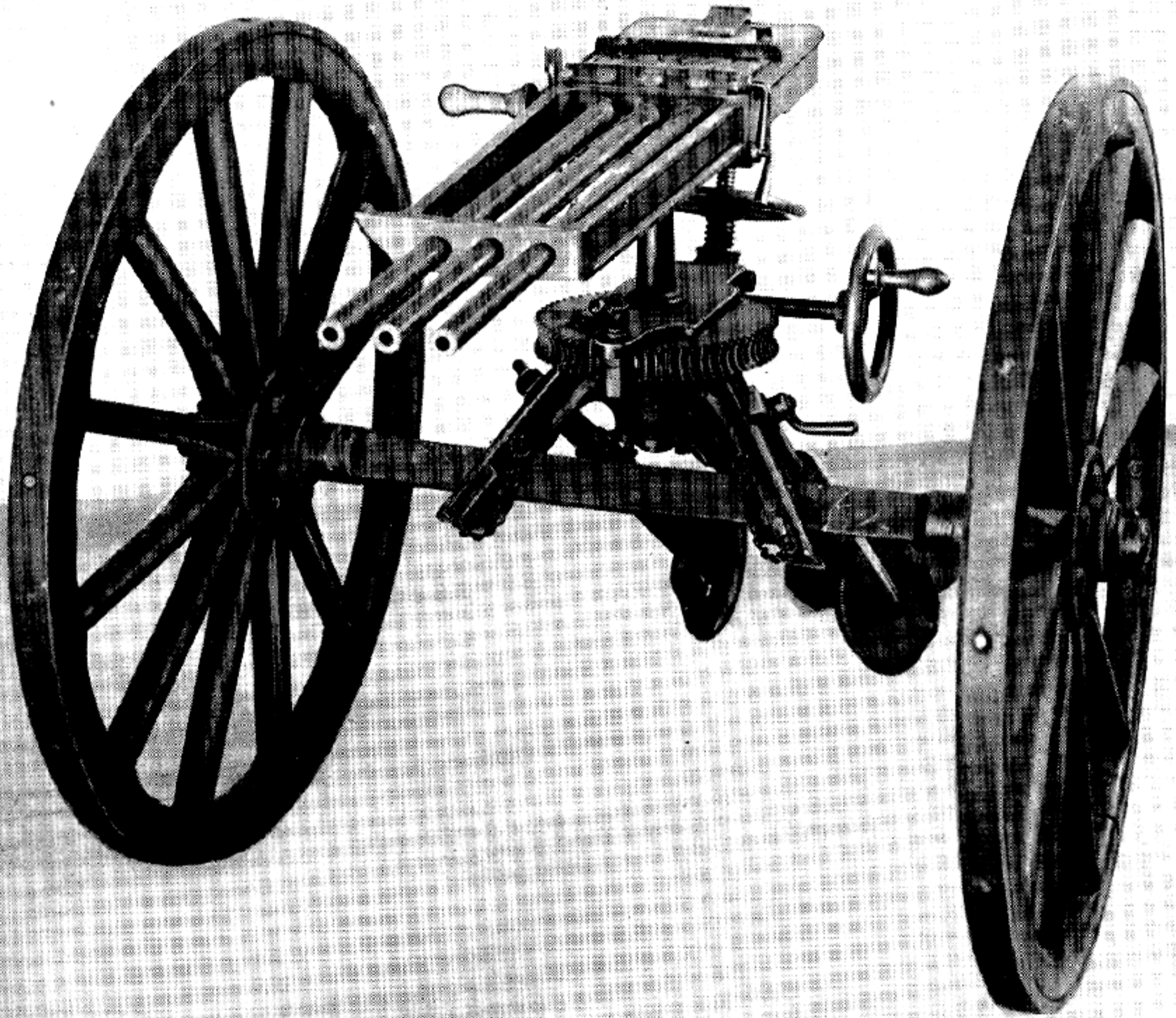

Nordenfelt Machine Gun, Cal. .45, with Gun Carriage Convertible to Tripod Mount.

This model had a rated speed of 1,200 shots per minute with shorter bursts.

A description of one of the Nordenfelt multi-barrel mechanisms will describe all 18 models. They differed only in size, number of barrels and caliber. The operating parts remained basically the same.

All the Nordenfelt weapons can be classified easily by placing them in groups as follows:

(1) Rifle-caliber machine guns.

(a) Light machine guns including those of less than 150 pounds in weight that can be carried by the individual soldier, or on horse or mule back.

(b) Heavy machine guns. Those of 150

pounds upward, that could not be transported other than by limbers or shipboard mountings.

(2) One-inch caliber machine guns. The gun, especially designed for torpedo-boat defense, was made with four barrels only.

(3) Rapid-loading shell guns.

(a) Light guns including 1½ inch, 37-mm and under.

(b) Heavy guns. Those upwards of 1½ inches, 37-mm.

One inch was the largest caliber gun using the lever toggle joint locking system of Palmcrantz, for which Nordenfelt was famed. The larger shell guns were simply manually operated drop-lock mechanisms, that permitted rapid loading

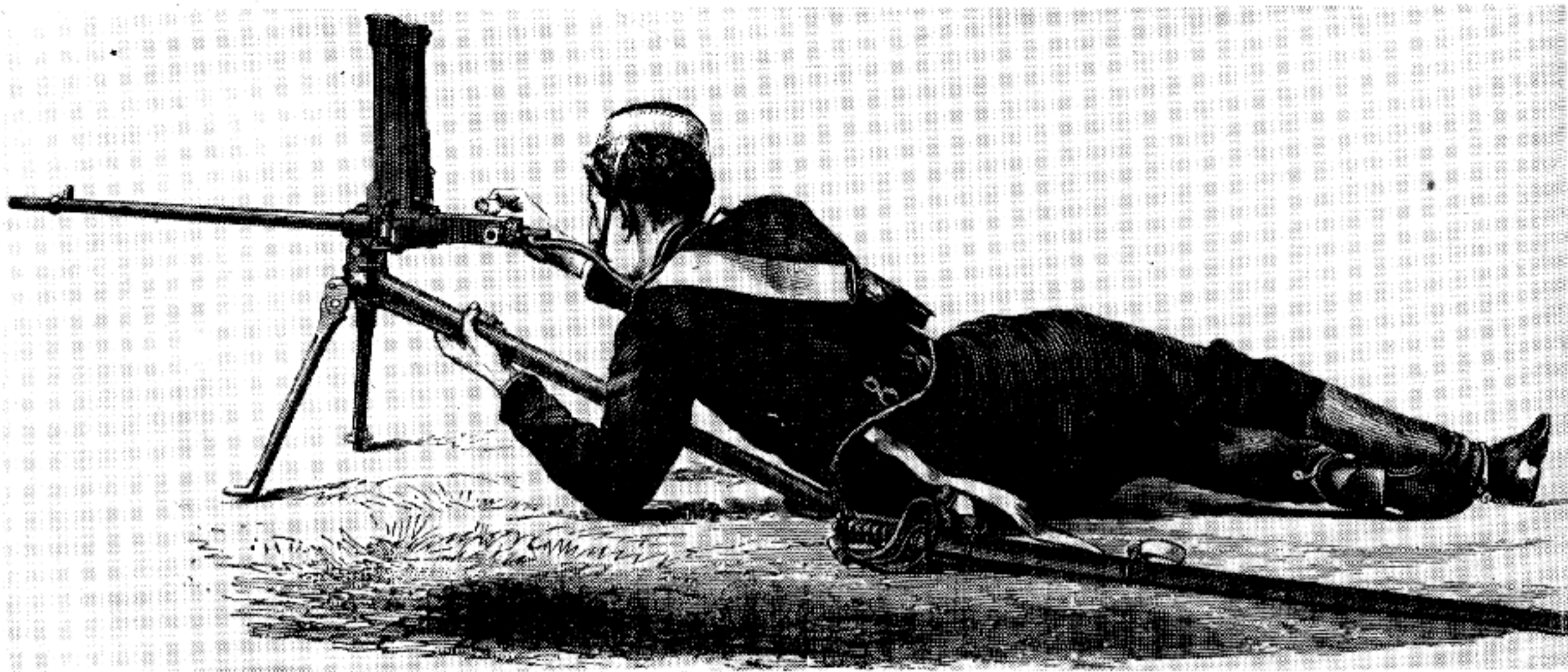

Nordenfelt Single-Barrel Machine Gun.

and extracting. They should in no way be confused with the other weapons, regardless of the fact that the company advertised the heavy guns as "Shell Machine Guns."

The Nordenfelt Co.'s most interesting product was a light single-barrel machine gun designed for the infantryman. It was lever operated and used toggle joint locking. The principal parts of this rifle caliber weapon were: (a) Hand lever with cam plate combined, (b) plunger, (c) action slide piece, and (d) breech cover.

Energy for the horizontal motion necessary for firing is obtained by means of a lever pivoted on the left side, extending under the breech to be manipulated by the right hand.

The plunger contains the firing pin, spring, and extractor. The latter is claw shaped, the upper part seizing the rim of the cartridge above. The lower portion grasps it on the right side. In the center of the plunger, on the under side, is machined a broad slot, and on the rear, two recoil or locking projections. The firing pin is housed in the plunger, and has on its end a T-shaped projection for cocking.

The action slide has a friction roller, as well as a cam piece of the same shape as the slot in the plunger. The roller runs in the hand lever cam slot, with the cam piece working in the plunger slot. Forward travel of the plunger causes rotation of this piece to engage with projections in the receiver, securely locking the piece.

The breech cover has an ejector, fastened underneath at the forward end, which throws the empty cases through the opening and clear of the gun. In the breech of each barrel, on the inside, one above the other, are cut two longitudinal grooves. In the lower one is fixed a flat spring, with a projection on it for the purpose of compressing the firing pin springs.

To fire the single-barrel Nordenfelt, the operating lever is pulled back evenly. This rotates the plunger, bringing its locking projections clear, at the same time alining the cocking piece with the lower grooves. If the weapon has just been fired, the empty cartridge case is drawn to the rear with the plunger, carrying the T-projection cocking piece over and behind the flat spring.

As the operating lever reaches its furthest travel rearward and the empty case is ejected, the cocking lug is held back under spring compression. The lever is then shoved forward and the bolt strips a loaded round from the feeder and chambers it. When the lugs rotate down into locking position, the obstruction is removed from the T of the cocking lug, and the firing pin is seared off, discharging the weapon. A driver permits the operator to use the piece as a reciprocating rifle if he so desires.

It is especially to be noted that the Nordenfelt employs the rotating bolt head that unlocks by a straight pull rearwards. The system has since been copied throughout the machine-gun world.

By shoving the operating handle forward, the firing pin spring is compressed and the lock plunger chambers a loaded round. The final movement forward rotates the locking projection on the plunger. At the instant the act of locking is completed, the T-shaped cocking piece is turned clear of the flat spring projection, releasing the firing pin to strike the primer and fire the piece.

The mechanism is very simple, there being only 23 parts in all. It can be removed in a matter of seconds by unscrewing the rear screw by hand and drawing out the parts. The operating lever is so designed that, when removed, it can be used as a spanner wrench to disassemble the remainder of the weapon.

This gun weighed only 13 pounds, and could be fired by the average soldier at a rate of 180 shots a minute. It was made by the Nordenfelt Co. to show that a machine gun could be made, with a weight only four pounds more than that of the average service rifle.

European military authorities were prejudiced against the single-barrel machine gun at this time. Farrow's Military Encyclopedia expressed the opinion of practically all Europe by stating: "A general would probably not submit to the expenses and inconveniences of machine gun equipment, and services of men and mules for gun and ammunition, when the efficiency of the gun is entirely dependent on one single rifle barrel."

The multibarrel models of the Nordenfelt (Palmcrantz) system (it was internationally known by this name) have a magazine located directly over the carrier block holding 250 rounds of rifle caliber ammunition with an entrance slot behind each chamber in which the rounds drop by gravity.

Power for operating the weapon is furnished when the gunner moves a bent lever using a fore and aft movement of his right hand.

The frame has three cross pieces, and the barrels are inserted from the front (from 1 to 12), all lying in the same plane and parallel to each other. The breech ends of the barrels are secured into the metal crosspiece, while the muzzles rest on a solid part of the frame.

The principal parts are: (a) Hand lever, (b) action lever, (c) action block, (d) breech piece,

(e) trigger comb, (f) carrier block, and (g) cover.

The hand lever is pivoted to the axis pin, and when actuated manually, sets the whole mechanism in motion. The action lever is fixed to the action pin, and has a stud on which a friction roller works. In the rear, a projection riding in a slot, gives a transverse motion to the action block, which is located at the back of the breech framework.

The action block contains slots for the plungers to pass through. In the solid portion between the slots, chambers are bored to house the firing pin springs and hammers, the hammers being each a T-shaped projection. Through the middle part of the action block, a channel passes from right to left for the reception of the trigger comb.

The breech piece consists of a plate with a plunger for each barrel, each plunger housing the firing pin and extractor. Beneath this plate is fixed the director cam slot in which the action lever friction roller works. This affords the breech piece longitudinal movement only. On the upper part are fastened studs which engage the T projection on the hammers, forcing them back and compressing the firing pin springs.

A lug on each side of the breech piece acts against a corresponding lug on the carrier block, thus forcing it to the right or left as the operating handle is moved forward and back. The trigger comb has a small spring to bring it to the right, and to retain the hammers after they have passed the teeth on its lower surface. The comb which projects to the right of the action block is forced against the right side of the framework on the action block, moving to the right. The comb is thus pushed to the left, releasing the hammers.

The carrier block, or cartridge receiver, is given its lateral movement by lugs on the breech piece, allowing the cartridges to drop by gravity into position for chambering.

The cover is hinged to the center crosspiece, and secured in its place by a spring lock on the rear member. The cover is opened towards the muzzle and access to the mechanism is obtained without moving the feeder.

To fire the multibarrel Nordenfelt, the operator moves the handle to the rear, and the aft projection of the action lever carries the action block to the left. The openings in the action block for the plungers being in line with the ac-

tion lever roller in the breech plate cam slot, the breech piece and plungers are carried rearward. If a volley has been previously fired, the empty cartridge cases at this point are extracted and ejected to drop through openings in the bottom of the housing.

By the time the handle has reached its extreme rearward position, the studs on the upper surface of the breech plate catch the lower part of the hammers' T projections. This forces them back against the beveled edges of the trigger comb teeth. The comb is then moved against its spring to the left until the hammers are clear. When the spring carries the trigger comb to its original position with the teeth in the jaws of the hammers, the firing pin springs are compressed and the carrier block brought to the left.

As the handle is pushed forward to battery position, the carrier block is moved to the right, placing loaded rounds in position for chambering. Then the breech piece with its plungers is carried forward, chambering the cartridges in their respective barrels.

After the rounds are driven home, the action block then moves to the right and the hammers are alined behind their firing pins. At the same instant the projecting part of the trigger comb is carried against the framework of the gun, causing the trigger comb to be pushed to the left, freeing each hammer in turn, to be driven forward to strike the firing pin and thus fire the cartridge.

The method of feeding all the barrels from one hopper is unique. The hopper consists of an upper and a lower part. It is constructed of steel plates, with the exception of the rear face and guides, which are of gun metal. The lower hopper, often termed the distributor, is placed on the gun at the top of the breech cover over the carrier block, and secured into position by a spring lock where it remains during firing.

The distributor has a separate compartment for each barrel. On the rear face of each compartment is a guide for holding the cartridges by their rims. The ammunition lies in an inclined position, with the bullet slightly raised and touching the front inner face of the distributor.

The upper part of the hopper also has separate compartments. It is loaded from the top, a hinged cover being provided for that purpose.

The cartridges are kept in place by means of a catch at the rear running the whole width of the hopper. This catch can be thrown in and out of action by a handle on the left outer side of the hopper. A similar catch is used on the distributor.

To operate, the empty lower distributor is first fixed in its place. An upper filled hopper is then positioned. The catch handle is pushed down, dropping the cartridges into the lower hopper where they then fall into their respective compartments in the distributor. When the catch on the distributor is released, a cartridge for each barrel falls into position on the carrier block. The others continue to take their places as soon as a vacancy occurs.

By means of the catch, the distributor and upper hopper could be taken off separately at any time without the cartridges falling out. This method of feeding proved quite adequate and was very simple and positive. The cartridges being contained in a closed case, any chance of the gun being fouled by dust and grime on the cartridges was obviated. While the system served this type of weapon well, it suffered by comparison with other feeds developed for the rapid-firing mechanisms of single-barrel guns.

On the models that had five barrels and over one of the most unusual devices ever put on a machine gun was found. This feature was called the Nordenfelt automatic scattering gear. By this, the shots composing a volley were separated from each other by a space of 3 feet between each bullet. Thus volley fire of 10 shots would cover respectively 5 to 10 men in formation. This spread of bullets can be given for any distance up to 500 yards by adjusting a thumbscrew placed on the left rear of the gun. Beyond that range it was thought the natural dispersion of the gun would insure a sufficient spread. When firing volleys at bodies of troops, the lateral direction on the gun could be slightly altered after each discharge so that no two volleys would fall in the same target area.

Another accessory, called a drill stop, was provided with the 1-inch four- and five-barrel guns. By this the operating lever was prevented from fully completing its back stroke, so that the hammers could not be retracted far enough rearward



Nordenfelt Machine Gun, Cal. .45, Five-Barrel Model. Mounted in Top of a Fighting Ship to Sweep the Decks of the Enemy.

to pass into the trigger comb. With this device the gun could never be full cocked, as the firing springs were not compressed when the action block moved forward. The stop, as the name implies, was for drill purposes only; it allowed the gunner to train gun crews using live ammunition with absolute safety.

The Nordenfelt multibarrel guns as a whole were clumsy contraptions when compared with American-designed weapons of this era. However, the firm did one thing that justified its existence by introducing the rifle caliber armor-piercing bullet years ahead of its time. In fact, it was so revolutionary that it was rediscovered nearly 40 years later. Nordenfelt left no doubt that he had the modern-day AP round in mind when he described his projectile as follows: "The bullet of this kind of cartridge is formed of hardening cast steel with a sharp pointed head. Over this projectile, for the purpose of a gas check and for rotating the bullet, is placed an envelope of brass, which is choked into a cannellure around its base. Also on the base are

several radial cuts, into which the envelope is set on firing. In place of a brass envelope a coating of copper may be deposited on the projectile by the electro-galvanic process, and thus any possibility of altered flight due to the stripping of the brass envelope is rendered impossible."

This high-velocity armor-piercing projectile that had a speed in excess of 2,000 feet a second and penetrated 2 inches of solid iron plate at 300 yards was a distinct contribution to the field of ordnance. It is ironical that Nordenfelt was either far ahead of his time or hopelessly behind it.

But the most outstanding achievement of his long and colorful career was a machine gun that weighed only 13 pounds, capable of easy operation by the individual soldier, and with a rate of fire of 180 rounds a minute. Any army in Europe would have had a great advantage with this fire power and mobility.

Military authorities in Europe still looked upon the machine gun as an auxiliary or supporting arm to artillery in order to protect the

latter from being rushed by foot soldiers or cavalry charges. They continued to insist that volley fire was the best way to break up a charge, and it was practically impossible to sell them on any weapon that would not discharge a hail of bullets at one time.

The British Navy, however, did not share this opinion. Like the American Navy, it did much to encourage and develop a lighter weapon capable of sustained fire that could be put ashore

or fired from the rigging of the ships. The Admiralty already had what it considered the best manually operated weapon ever designed (the Gardner). It took no particular note of the single-barrel Nordenfelt gun, and as the army simply ignored it, the weapon went out of existence. However, Nordenfelt did produce and place in the hands of the British Army the first light-weight rifle-caliber machine gun for carriage and operation by the individual soldier.

## TAYLOR MACHINE GUN

Because of inertia and lack of encouragement, there was little incentive actually to produce a weapon capable of standing the rigorous tests demanded by the proving grounds. Of the more than 80 patents issued in the United States on machine guns between 4 November 1862 and 26 June 1883, only one other was completed sufficiently to justify trial. This weapon was the Taylor machine gun. The inventor, James Patton Taylor of Carter County, Tenn., made a gun very similar in appearance to the Wilder.

Nine rifle-caliber barrels are permanently fastened in a half circle. The bolts work in conjunction with a revolving cam cylinder which is constructed with two grooves or flanges. One is for imparting a longitudinal movement to a series of reciprocating bolts, one for each barrel. The other flange is for retracting the striker and spring, and for searing off the firing mechanism when the bolt is securely locked. The flange that operates the bolts is formed with an opening

at the extreme rear of its stroke to facilitate the removal of a bolt when necessary.

The feeders are of unusual design. A semi-circular housing containing nine separate columns allows the cartridges to drop in line with the corresponding slot behind each chamber.

To fire the weapon, the feeder is loaded and tended by one man, while the gunner turns the crank and aims the piece. As a loaded round drops into position behind its respective barrel, the cam that actuates its bolt causes it to go forward and chamber the round. At the same time the engagement of the cocking lug on the striker with the breech cam on the revolving cylinder compresses the striker spring. When a bolt arrives at its extreme forward travel, the lug reaches the end of the cam. It then sears off, allowing the striker to be driven into the primer and fire the weapon.

As the actuating cylinder continues to turn, the cam that controls the bolt starts jacking it rearward. On its first movement in this direc-

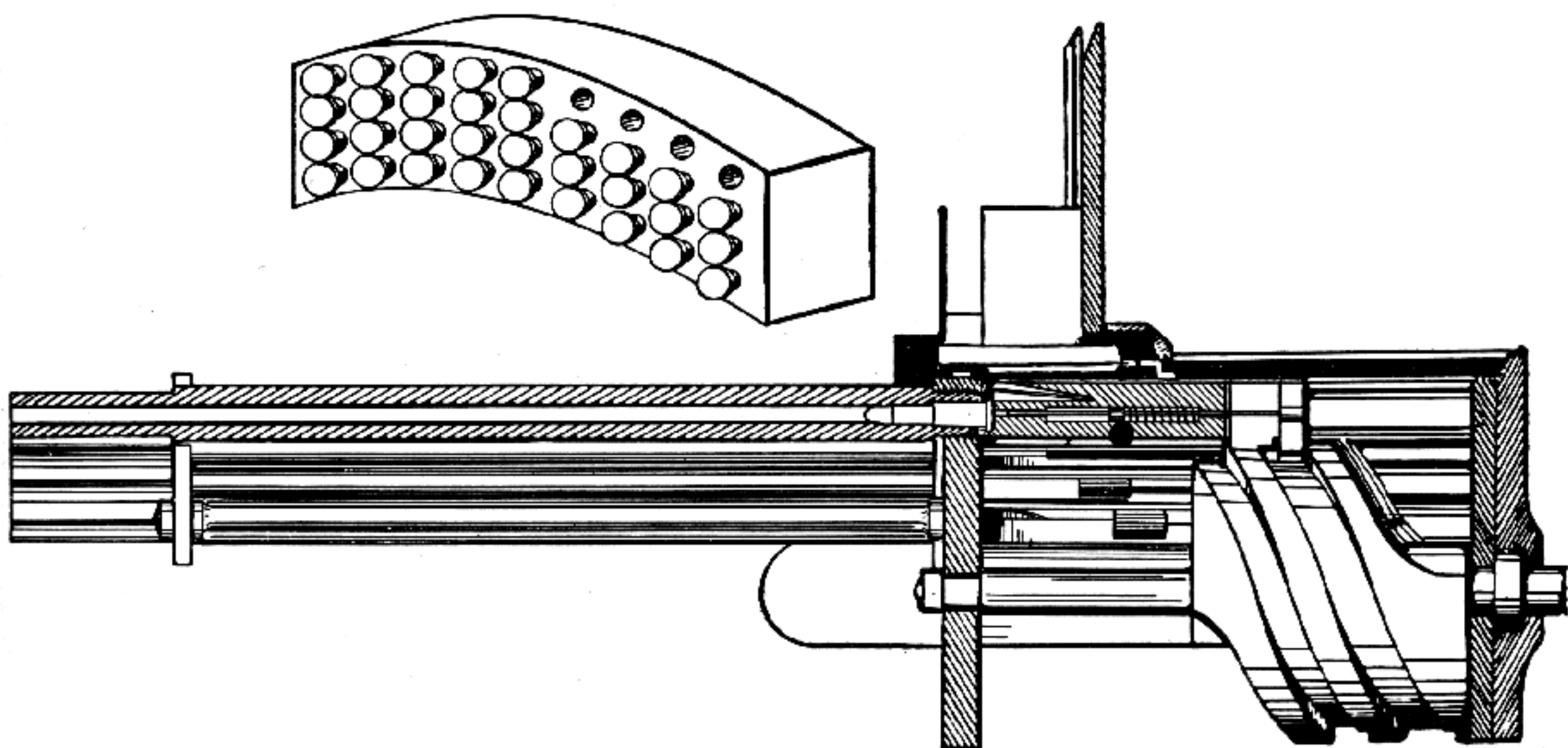

Taylor Machine Gun.

tion, the double jaw type extractors pull the empty case from the chamber. After a travel of 1 inch, a physical interference forces the jaws to release their hold on the rim. When a distance slightly greater than the over-all length of the cartridge is reached, an ejector butts down in its path; striking it a smart blow on the base, it pivots and drives it through an opening in the housing, clear of all operating parts. Continued turning of the crank repeats the cycle. With every complete revolution of the handle the weapon fires nine times.

Of the three machine guns that Taylor patented, the one described is the only one that got

far enough along to stand trial (in 1878). At the time, because of its feed, it failed to meet the demands of the Army board. The only comment was: "The Taylor gun is an ingenious and promising machine gun, but with the present arrangement of feeding the cartridge, it does not compete favorably with the other, better perfected machine guns that have been offered for test before this board. It is probable that a better feed can be effected for the service of this gun by the inventor; until this is accomplished however the board cannot recommend the procurement by the United States of any of these guns for service."



## END OF THE MANUALLY OPERATED PERIOD

From Gatling's original patent on 4 November 1862 to 26 June 1883, American supremacy in machine-gun design went unchallenged. It is of particular importance to note that from the adoption of the Gatling gun by our Army until the conclusion of this era, there was no threat of war to our country. This disproves the pacifist's claim that once any nation has fully developed a superior weapon, war is inevitable to prove its effectiveness.

In this peaceful era, the Navy demanded perfection from the weapons tried. Some of the requirements placed upon these guns seem impossible when compared with our present-day system of testing.

It should be especially noted that at this time a Naval Acceptance Board functioned. This body of officers had the responsibility of seeing that any gun inventor could bring his invention to trial for purposes of adoption, and of extending to him all assistance possible to make his weapon reliable and effective. In fact, some of the suggestions offered helped in no small way the phenomenal success the guns later enjoyed.

The intense and wholehearted cooperation of these officers not only contributed to the mechanical accomplishments of the weapon under test, but undoubtedly furnished the inventor an incentive, since he knew that these officers would give him all the help in their power. That this procedure paid big dividends can best be judged by comparing these 21 years of progress with any other period in the continuous effort to produce weapons.

The establishment by the Navy in 1872 of the Experimental Battery at Annapolis, Md., showed the farsightedness of the officers responsible for weapon development. This facility handled all the firing of prototype weapons. And certain defects, inevitably present during initial firing tests, were required to be remedied before the weapon was allowed to go before the board for

final trial at the Navy Yard, Washington, D.C. The unbelievable performances of machine guns tested there was due to their having previously been fired under the expert supervision of Naval officers at the Experimental Battery. Many of the defects were eliminated that would otherwise have caused the weapon to fail during the rigorous acceptance trials demanded by the Navy.

Some of the official records from these two firing ranges of the Navy reveal performances that no modern fiction writer would dare to credit to the present-day machine gun; yet they were actual accomplishments of this era.

Incidentally the Experimental Battery at Annapolis was the pioneer Naval Proving Ground. In 1890 it was moved to a new tract overlooking the Potomac River at Indian Head, Md., and in 1921 the present Naval Proving Ground was opened at Dahlgren, Va.

Though these tests helped gun design, they did not enrich the designer. One fact, standing out above all others, is that during this era a successful machine gun inventor was compelled to go abroad to market his weapon, although in every instance it was first offered to his Government.

While the United States had no need, and no immediate prospect, of using these superb weapons, foreign governments not only recognized their superiority, but made every possible overture to induce the inventors to leave home and market their discoveries abroad. With no incentive in this country to warrant any other choice, a steady trek of gun geniuses left America for Europe to establish factories—not only taking with them the "know-how" and top talent of the gun profession, but, in most instances, staffing their foreign factories with the highest skilled Yankee machinists they were able to hire. Their services were thus lost forever to their own country. And the factories they established abroad

have been there so long that today they are thought to be of foreign origin, when in reality they were started by skilled American citizens, building a product unwanted at home. Necessity alone placed them on foreign soil to design and perfect the deadliest known instrument of war—the machine gun.

The weapons of this quarter century were all manually operated. Since it was always necessary for a gunner to aim the piece, there seemed no reason why he should not also furnish the power to feed and fire the gun. Mechanical advantage was utilized to enable the individual soldier to

maintain sustained fire with a minimum effort.

During the latter part of this era, the weapons reached such a high degree of efficiency it was predicted there was nothing left to be improved. They were accepted as “invincible reapers of death.”

As has been the case throughout weapon history, when perfection in the *n*th degree seems accomplished, an “impossible” principle is suddenly made to work. Past ideas, years of heart-breaking effort, and standards of perfection are outmoded overnight; yesterday’s invincible weapon is today’s obsolete scrap.

PART III

FULL AUTOMATIC MACHINE GUN DEVELOPMENT

## MAXIM MACHINE GUNS

### Maxim's Early Years

For many years nothing surpassed the American gunmaker's ingenuity. Even refinement of existing firing mechanisms was considered a task challenging the utmost skill of any designer. However, the world did not reckon with a young man from America, Hiram Stevens Maxim, who was for the first time to combine the words "automatic" and "machine gun." He accomplished this by using the power of the recoil forces generated from the explosion of the powder charge in the cartridge to produce the entire cycle of operation. The only human energy now required was for releasing the sear. The internal forces of the gun performed the loading, firing, extracting, ejecting, and cocking of the piece.

Maxim had not previously been a gun designer. His meager schooling had deprived him of the engineering misconceptions preached in his day. He did not believe a better machine gun design was impossible. The simple mechanism he originated as a first attempt worked so successfully that for the last 64 years the famous Maxim automatic machine guns have been basically unchanged.

A summation of his life is given in an attempt to portray the background of this quick-witted American, whose keen observation, native intelligence, and amazing energy have greatly influenced world history.

The Maxim family was of French Huguenot descent. Driven out of France, the ancestors of Hiram Maxim fled to Canterbury, England; then emigrated to Plymouth County, Mass. Here, according to Maxim, "they could worship God according to the dictates of their own conscience, and prevent others from doing the same."

Maxim's great-grandfather lived first at Wareham, Mass., where his grandfather was born. The latter married an unusually large and strong woman, Eliza Rider, also a descendant of early

English settlers. This couple emigrated to the district of Maine, not yet a State, and took possession of a tract of land on the shores of Androscoggin Lake, in sight of the White Mountains.

Maxim's grandfather had seven children. The youngest, Isaac Weston Maxim, was the inventor's father. The middle child in the family was Eliza, a very intellectual young woman and a physical giantess like her mother. Throughout the family history there was in each generation one person of unusual physical proportions. The inventor himself claimed he was the strong member of his own generation and cited the fact that in each place he worked he had made it a point to whip every barroom bully. His father was only average in size, being 5 feet 8 inches in height and weighing 180 pounds.

As a young man, Maxim's father assisted on the grandfather's farm. Later he moved to Massa-



Hiram Maxim at the Age of Seventeen.

chusetts, only to return to Maine, and marry Harriet Boston Stevens. They went to Sangersville, Maine, cleared a farm, erected buildings, and started farming. At this place Hiram Stevens Maxim was born on 5 February 1840.

When Hiram was six, the father gave up his farm, and started a wood turning establishment at French's Mill in the same township as Sangersville, where Maxim began his education at the local school.

The boy was a great hunter and natural outdoorsman. He and his brother, Leander, killed many bears, then so numerous in the Maine woods.

A self-educated man, he took advantage of every opportunity offered. An outstanding example was his contact when 12 years of age with a sea captain, who taught him to read longitude and latitude. At this time his inventive genius first became noticeable. Lacking money to buy a chronometer, he made one that worked perfectly. Since he showed quite an interest in this field, his father obtained for him a book on astronomy, as well as Comstock's *Natural Philosophy*. Both were eagerly read by Maxim.

At the age of 14 he was apprenticed to Daniel Sweat, a carriage maker at East Corinth Village. The recommendations stated that Maxim had built an excellent boat, was a natural mechanic, and, though young, was very handy with machinery. Sweat paid the boy \$4 a month, although not in cash.

It was summer. Sweat and his crew began work at 5 o'clock in the morning, breakfasting at 7. Work was resumed at 7:30 and continued until the dinner hour, 12 to 1. In the afternoon they labored until a 5 o'clock supper, followed by more duties until sunset.

Years later in New York, men striking for an 8-hour day were told by Maxim, "The 8-hour day is nothing new to me. I used to work 8 hours in the morning, and 8 in the afternoon."

After several months with Sweat, Maxim decided to leave and go back to his father, who had moved to Sangersville Village. On the way he stopped for several days with his uncle, Capt. Samuel Maxim, who suggested that a firm in Sangersville making rakes for farmers might have a place for a young man with his aptitude. Hiram worked with this company until school

commenced. While attending school at Sangersville, he supplemented his income by trapping animals.

In Abbot Lower Village, Daniel Flint owned a fine carriage shop equipped with many machines driven by water power. When school was finished that spring, Hiram's father recommended him highly to Mr. Flint, and mentioned the boy's large size, saying that he could do a man's job and do it well. Flint put him to work immediately. The use of power driven machinery made the work easier; the hours, however, were the same as at Sweat's. While with Flint, Maxim started applying his gift of drawing to designing parts, sketching things he thought would be improvements in the carriage business.

After 4 years with Flint, Maxim set up and operated his own grist mill at Abbot Main. Like all grist mills it was infested with mice. While working at the carriage shop Maxim had constructed a few box traps during his off time. The difficulty with these was that after a mouse had been caught, another could not be trapped until the first had been taken out. He therefore decided to make an automatic trap, one that would wind up like a clock and set itself a great number of times. The trap was to be actuated by a coil spring, somewhat like a clock. On the morning after the first one was set, he found it contained five mice. It was the first of the many successful original devices he produced. He made no attempt to patent the trap and years later saw its widespread sale by someone else who had copied it in detail.

Business at the mill involved very little cash, as most of the payments for grinding were taken out in grain, which was hard to sell. So Maxim was again forced to work for Daniel Flint to earn enough to purchase a suit of clothes, as he said, "to get out of Abbot," and obtain more money for his work. Being under age, it was necessary that he have published in the *Piscataquis Observer* what was known as a "freedom notice." In this his father had to state that he relinquished all claim to the young man's earnings.

In Dexter, Maine, he saw Mr. Ed Fifield, who, Maxim understood, needed a decorative painter. Fifield told him the vacancy had been filled but he needed a good wood turner. Maxim applied for this job. Upon learning Maxim had several

years' experience as a wood turner, Fifield gave him the position which he held when the Civil War broke out.

The younger men at Dexter formed a home guard company, with the local shoemaker as captain. They used broomsticks for their drilling in lieu of rifles. Maxim soon tired of what he called "playing soldier." He left the organization and gave his entire time to Fifield's shop. The home guard officers bitterly denounced him for not continuing with the local company.

Their attitude worried Maxim. He sought the advice of an old friend, Dr. Springall, who advised that he was entirely too promising a young man to go off to war and it was hardly worth while, anyway, as every one conceded the war would not last more than 3 or 4 months. And he would have to be seeking another job when it was all over.

Although he was of age, and eligible for military service at the time, he never made another attempt to join the service. A short time after this Maxim left Dexter and went to Huntingdon, Canada. This fact caused people to believe the story circulated by rival concerns at a later date that he deliberately dodged the Civil War draft in the United States by taking up residence in Canada.

While in Huntingdon he was employed in decorating sewing machines, and painting signs for local taverns. He even did some contracting and bartending. Once he had a contract to paint several thousand wooden chairs, for which he received the price of 6 cents each.

While in Canada he tried almost every job imaginable to make a living. One resulted in an unusual achievement. He constructed an entirely new type of blackboard for a schoolhouse at St. Jean Chrisostome, by originating a paint that allowed the chalk to work successfully on plain plaster walls. This would save the school board many hundreds of dollars. He was bitterly disappointed that his work was not accepted with enthusiasm, and had been cut down, as he said, to the price of an every-day laborer. He never forgave the board for this, as it turned out later to be a very valuable invention, and one from which he did not realize a single cent. This influenced him greatly in leaving Canada, which he shortly did. The argument of the school board

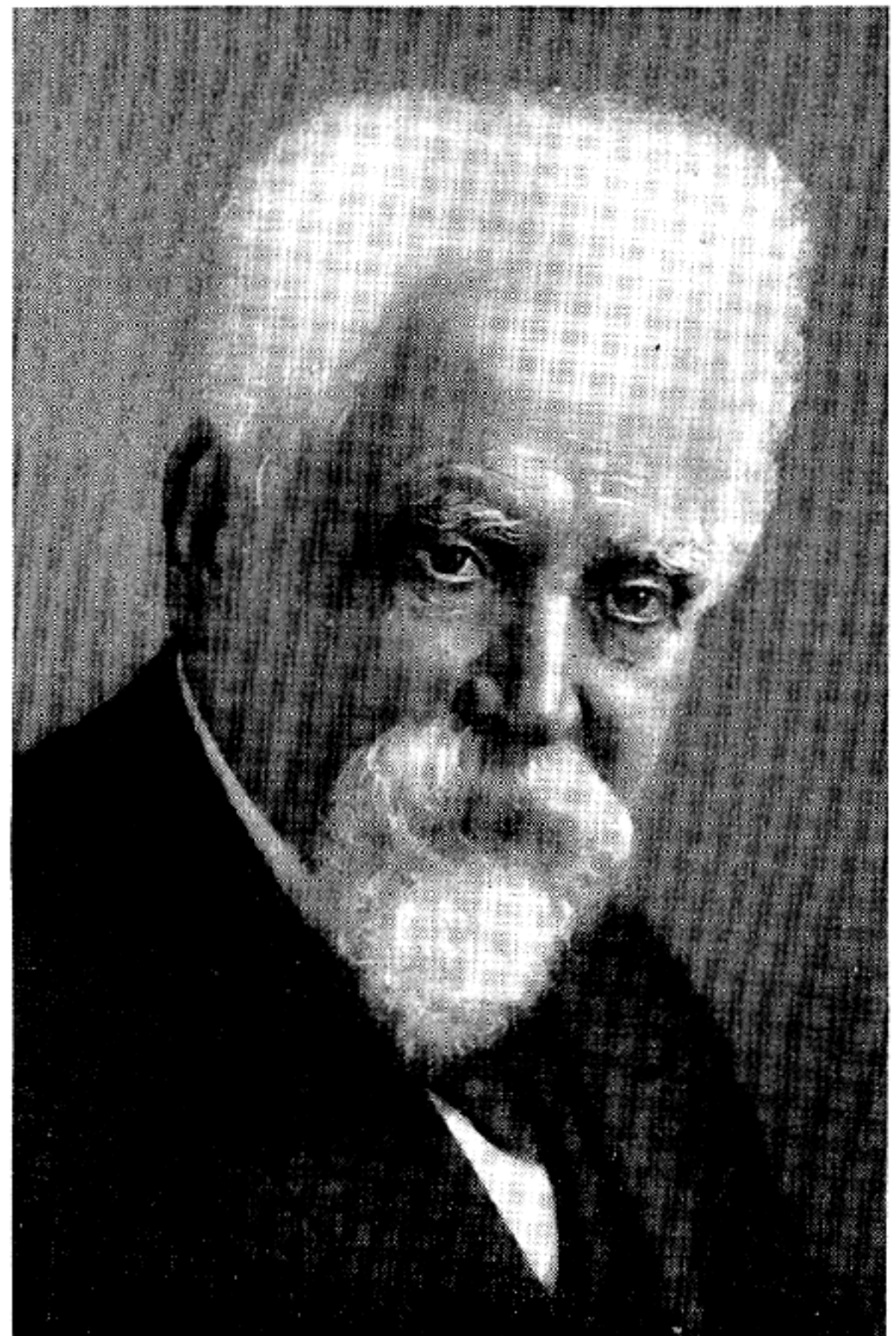

Hiram Maxim. Picture Taken Shortly Before His Death in 1915.

in refusing to pay him, was that while it would save them hundreds of dollars, he only used 40 or 50 cents worth of materials, and that the \$6 he asked was entirely too high.

By this time Maxim's two brothers, Leander and Henry, were in the Army and since it was a policy of the draft board never to take more than two members from one family, he was never called.

Ever seeking to improve his education, Maxim found Ure's *Dictionary of Arts, Mines and Manufactures*. He spent the entire winter reading this book. Later he said it was the background for most of his education. According to him, it amused the girls in the village very much to ridicule him for reading a dictionary. The teasing did not stop his reading. But, he said, it did end his interest in silly young women.

Maxim was soon looking for another job, first

in one community, then another. In Boston, he met a young lady whom, after a courtship of a few months, he married. Even this did not settle him. He continued roaming—in the South, in the Far West, and back again in the North—specifically, to Fitchburg, Mass., where he was employed in the engineering shop of his uncle, Levi Stevens. This family connection meant little. The uncle put him to work, like any other novice, cleaning brass off the new castings.

One day some white metal castings were to be made into patterns. The head foundryman gave the job to Maxim, stating, "You are too good a man to work at cleaning castings. The way to get out of your present job is to make a good showing on these patterns that I am giving you."

Maxim followed his advice and did an unusually good job. The foreman showed them to Stevens, who promoted Hiram to a big lathe on rough cast iron work, and he was soon turning out as much work as the average journeyman.

Soon his uncle contracted to make a number of automatic illuminating gas machines for the Drake Co. of Boston, Mass. Maxim was asked to dismantle the prototype machine that had been furnished, and make mechanical drawings. He got together the necessary wrenches for dismantling the working model, put up a draftsman's table, collected the mediocre drawing instruments the office afforded, and started to work the next morning. His uncle complimented him very highly on his skill, and suggested that he never let this particular talent drop.

Maxim explained that he had studied every book he could find on the subject. To encourage this gift, his uncle obtained better drawing instruments and provided him with a regular draftsman's office.

The Drake machines had not been made for many months before Maxim's uncle felt that he, himself, could construct a much better one. He drew up the working details, and then had one made. It was a dismal failure. He then asked Hiram if he would like to try designing one. The machine Maxim planned worked satisfactorily. His uncle ordered patterns made of the latter machine, a New York firm having agreed to sell all that he could deliver.

As Maxim studied the question, he found that by changing the design again, he could greatly

simplify the machine and reduce the cost of production. Also by interposing a very powerful box spring between the drive gear and the pump, the pump could be made to continue running for a few minutes while the machine was being wound.

The shop had already commenced to produce the original model, and, as the new design would require tooling up all over again, Maxim's uncle was furious. He seemed to think the improved design should have been drawn first. The disagreement led to Maxim's being fired and again he was out of work. This turned out to be a fortunate event for Maxim. He was employed in Boston by Oliver P. Drake, an instrument maker by trade, who understood his business thoroughly. Maxim was working for him when the Civil War came to an end in 1865.

Gas machines in those days consisted of a wet meter wheel used as a pump, and driven by a falling weight, after the manner of a clock. The air forced into the carburetor came into contact with gasoline. When the machine was at the temperature of the surrounding air, and freshly charged, the gas was very rich and would smoke if used in a common burner. After the machine had been running for about an hour, the refrigeration due to evaporation reduced the density of the gas so that it was just right for the burner. Unfortunately, it did not stop at this density. If many burners were used at the same time the evaporators would become too cold and, as the gas diminished in density, the flame soon became weak.

Maxim suggested to Drake that a density regulator would diminish the richness of the first gas made, and add to the gas made at the end of the evening.

Drake replied, "Yes, that would be splendid, if it could be done. But I think it impossible."

Maxim found by experiments that the air expanded only in the degree that it was carbureted. He also discovered that by putting two meter wheels on the same shaft, one slightly larger than the other, the smaller one pumped air into the carburetor while the larger one pumped gas out. Pressure would be formed in the carburetor if the gas were too rich. This, working on a diaphragm, would open a valve and allow the passage of air from the pump directly into the gas

pipe where it would mix with the gas, thus reducing the density.

The first model worked and the principle attained widespread use. He did not get it patented because of the cost. Maxim was led by this experience to try to sell patentable ideas of his to various concerns.

While in Boston a large furniture factory burned for the third time. Maxim was asked to design something to prevent this. He invented and installed the first automatic sprinkler that would be started by the fire itself. It would sprinkle only the place that was burning, at the same time ringing an alarm at the fire house giving the exact location of the outbreak. He installed it in the factory, but met with little success in trying to sell it elsewhere. When the patent expired, however, it was adopted almost universally.

His next place of employment was the Novelty Iron Works of Boston, Mass., where he acted as foreman and draftsman. For this he was paid \$5 a day, a considerable sum at that time. Later he received \$7.50 a day for working in the company's New York establishment on the East River.

Maxim next went into business for himself and formed the Maxim Gas Machine Co. with offices at 264 Broadway, New York City. This venture was very successful. Mr. A. T. Stewart, one of the wealthiest men in America, gave him a lucrative contract to light his mills and a large hotel in New York City.

People were beginning to talk about electric lamps. Regardless of how clever they might be, designs using alternate means of lighting were doomed. Seeing the trend, Maxim did not try to combat it with an improved version of a gas-line lamp. Instead, he met it by producing a fairly successful electric bulb using carbon. It is recorded that the first electric lights used in New York City were installed by Maxim's company in the Equitable Insurance Co. Building at 120 Broadway, in its day considered to be the most modern in the world.

When electric lighting first came into use in America, everyone wanted to examine the machines which produced the current. Many of these sightseers had highpriced watches which became magnetized and stopped.

Maxim developed a simple machine that could demagnetize a watch in a matter of minutes. At first he charged a dollar each for demagnetizing watches. The flow of business took much of his time. After patenting the machine, he made it available to any watchmaker or jeweler. The demagnetizers were used until the introduction of alternating current, at which time anyone could demagnetize a watch in a matter of seconds.

The instrument was made with a very powerful electric bar magnet rotated on a vertical axis, presenting the north and south poles in rapid succession. The magnetized watch was placed near the magnet, and rotated on a wheel and horizontal axis at the same time. As the crank turned, the carriage holding the watch was slowly withdrawn from the magnet by the action of a screw. By the time it reached the limit of its travel, no trace of magnetism was left on the watch.

Few oceanic crossings by an individual have affected the history of mankind more than Maxim's embarking for Europe on the *S. S. Germanic* on 14 August 1881. This voyage was made after he had held jobs in practically every section of the United States. His current employer had come to the conclusion that it would be to the firm's advantage for Maxim to visit the Electrical Exhibition then being held at Paris, France. During this interval he was engaged by the United States Electric Lighting Co. at a salary of \$5,000 a year. By this time Maxim had bestowed upon himself the title of "engineer."

Immediately after his European arrival he received orders from his home office to examine carefully every exhibit of an electrical nature, and describe it in his own words, and to collect and study all circulars and pamphlets on the subject.

He did such a thorough job that he was asked to describe each patent on electric lighting in the French patent office, from the very first one entered to the latest on file. For this job he was assisted by two secretaries and two draftsmen. The important ones were copied verbatim in French, and he wrote his own ideas of their worth to the home office.

At the completion of this project, Maxim examined Belgian patents in the same manner as he had those in France. This work later proved



very valuable to his company, as it helped the firm to defend itself against a considerable number of lawsuits for infringement of previous American patents.

### The First Automatic Machine Gun

When his home office sent Maxim to London to reorganize the British subsidiary, the Maxim-Weston Co., he noticed that every inventor in Europe, regardless of qualifications, was attempting to perfect some sort of machine gun. While in Vienna on business, it was suggested to him that he also try to originate a machine gun. The person advising this was an American friend, also in Europe on electrical business. Disgusted with the delay and red tape encountered in this field, he stated to Maxim, "Hang your chemistry and electricity! If you want to make a pile of money, invent something that will enable these Europeans to cut each other's throats with greater facility."

Maxim later stated that the idea of his machine gun came to him during some target practice with the Springfield caliber .45-70-405 service rifle, which, when fired, left his shoulder black and blue. With his alert mind he naturally asked himself, "Cannot this great force, at present merely an inconvenience, be harnessed to a useful purpose?"

He instantly saw the uselessness of a machine gun constructed like the Montigny mitrailleuse with its terrific weight and meager firepower. Maxim's idea was to produce a single-barrel

weapon that, if possible, would fire full automatic.

Maxim attempted first to develop an automatic rifle to be fired from the shoulder. It was designed to utilize the kick that he had observed as a young man.

His original drawings in 1883 were for a loose spring-supported heel plate fitted to a standard Winchester rifle, with a series of jointed levers, arranged so that the recoil of the piece against the shoulder operated the loading lever. When the recoil force ceased, the action of the spring-loaded butt stock pressed the rifle away from the shoulder and locked the action in battery ready for firing again. The specifications on another early drawing showed a blowback fully automatic rifle fed by a revolving magazine of the Roper type.

At this time a London broker, in an attempt to sell shares, made the exaggerated announcement in English newspapers that "Hiram Maxim, greatest electrician in the world, has been engaged to come to London to reorganize the Maxim-Weston Co. at Bankside."

This publicity was the occasion for much ridicule directed at the American. It influenced him greatly in breaking away from the electrical end of the business and devoting his time solely to the development of the machine gun.

Inspecting his newly reorganized factory, he observed a Brown and Sharpe milling machine. Maxim asked that the machine be assigned to him, and it was upon this American-made product, which in background and origin itself came from the early gun industry, that Maxim made

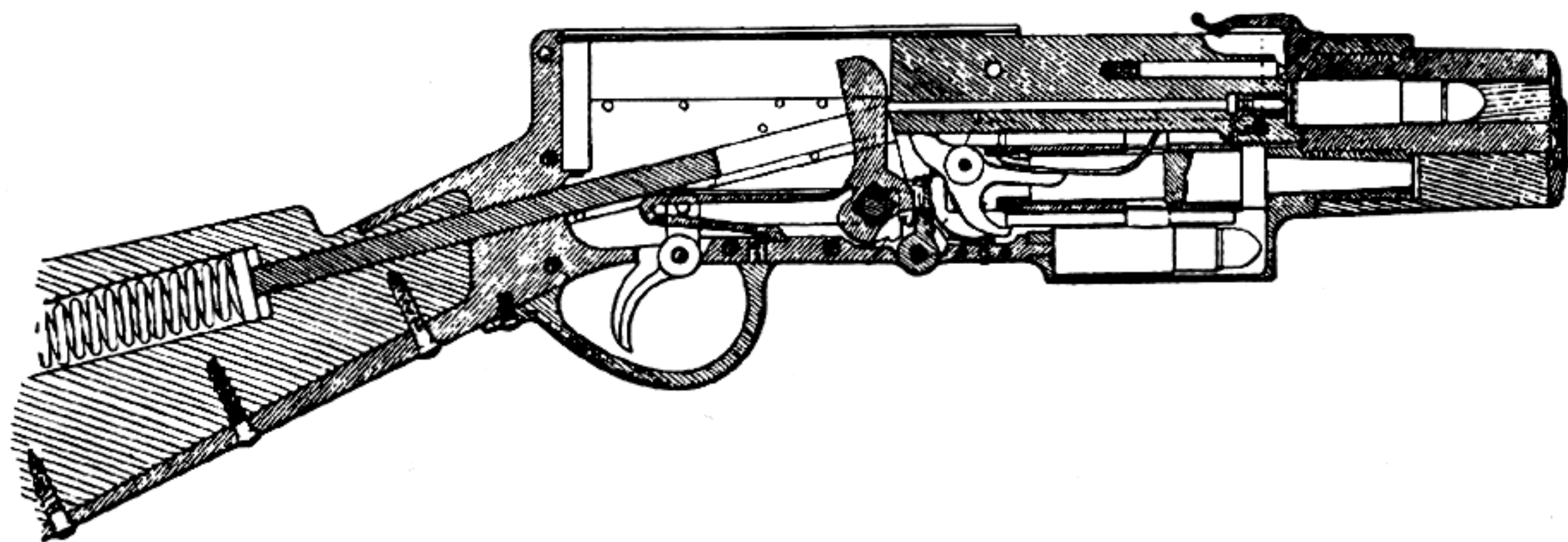

The First Automatic Weapon Patented by Maxim.

the first working model of a fully automatic machine gun.

He set up a small workshop at 57 Hatton Gardens, corner of Clerkenwell Road. Bringing with him the milling machine used at Bankside, he purchased additional American lathes, planers, drill presses, and other tools necessary for the work. He did not attempt to make the barrel for his machine gun, but purchased suitable ones from the London office of the Henry Rifle Barrel Co. These barrels, used in Maxim's first experiments, were the product of the outstanding American gun designer, Tyler Henry, then president of the Winchester Arms Co.

When Mr. Purvis, superintendent of the Henry Rifle Barrel Co. of London, heard that Maxim planned to construct a fully automatic machine gun, he said, "Don't do it. Thousands of men for many years have been working on guns. There are many hundred failures every year. Engineers and clever men imagine that they can make a gun do as you have described. But they have never succeeded. They are all failures. So, you had better drop it and not spend a single penny on it. You don't stand a ghost of a chance in competition with regular gun makers. You are not a gun man. Stick to electricity."

Maxim replied, "I am a totally different mechanic from any you have ever seen before, a different breed."

The barrels were delivered, chambered for the .45 caliber British Gatling gun cartridge of that day, having an 80 grain black powder charge and a 485 grain bullet.

Maxim took his drawings to a local pattern maker. However, the first brass castings delivered for the prototype were not satisfactory because of faulty patterns.

In describing the work on his first model, Maxim states that, as tools were required for the various machines, he forged and tempered them himself. His helpers thought it exceptional for a man in his position to do a blacksmith's and toolmaker's work.

There was no precedent for Maxim to follow. No one before had ever carried experimentation to this point, as it was generally believed that recoil forces would not be adequate to operate machine guns successfully. Maxim ignored these dogmas and continued with his original idea. By

fabricating the components and fitting them together by hand, he saw his experiments evolve into a mechanism that showed promise of success.

It was still necessary for him to conduct a series of tests before he could make final mechanical drawings. He constructed an apparatus by which he could determine the force and character of the recoil and find the distance that the barrel should be allowed to retract, in order for the projectile to clear the bore and let the gun be safely unlocked. All the hand-made working parts were easily assembled. After adjusting them to produce what he thought would be successful results, he placed six cartridges in the feedway and pulled the trigger. They all fired in what was later estimated to be half a second.

Maxim saw certain success ahead, and worked day and night on his drawings until they were finished. Then in his machine shop he proceeded to build a gun rugged enough to meet required demands.

In the spring of 1884 he had progressed to a point where his experiments resulted in a finished product. His original model is now at the South Kensington Museum in London, and is labeled, "This apparatus loads and fires itself by the forces of its own recoil, and is the first apparatus ever made in the world in which energy from the burning powder is employed for loading and firing the arm."

If the single-barrel Gardner is closely compared with Maxim's prototype, it is evident that the action of the former was taken under study by Maxim as the most logical weapon then in existence with which to apply the theory of automatic fire.

Faced with the problem of constantly increasing momentum if the bell crank be allowed continuous rotation, Maxim restricted its motion to three-quarters of its circumference in bringing the bolt back to battery. Firing at this point reversed the rotation.

This not only prevented increased inertia, but likewise eliminated the danger from hangfires, as the mechanism had no means of operating until energy for commencing the next cycle was generated by the fired round.

It is believed that Maxim's earliest experiment resulting in his first successful automatic fire was

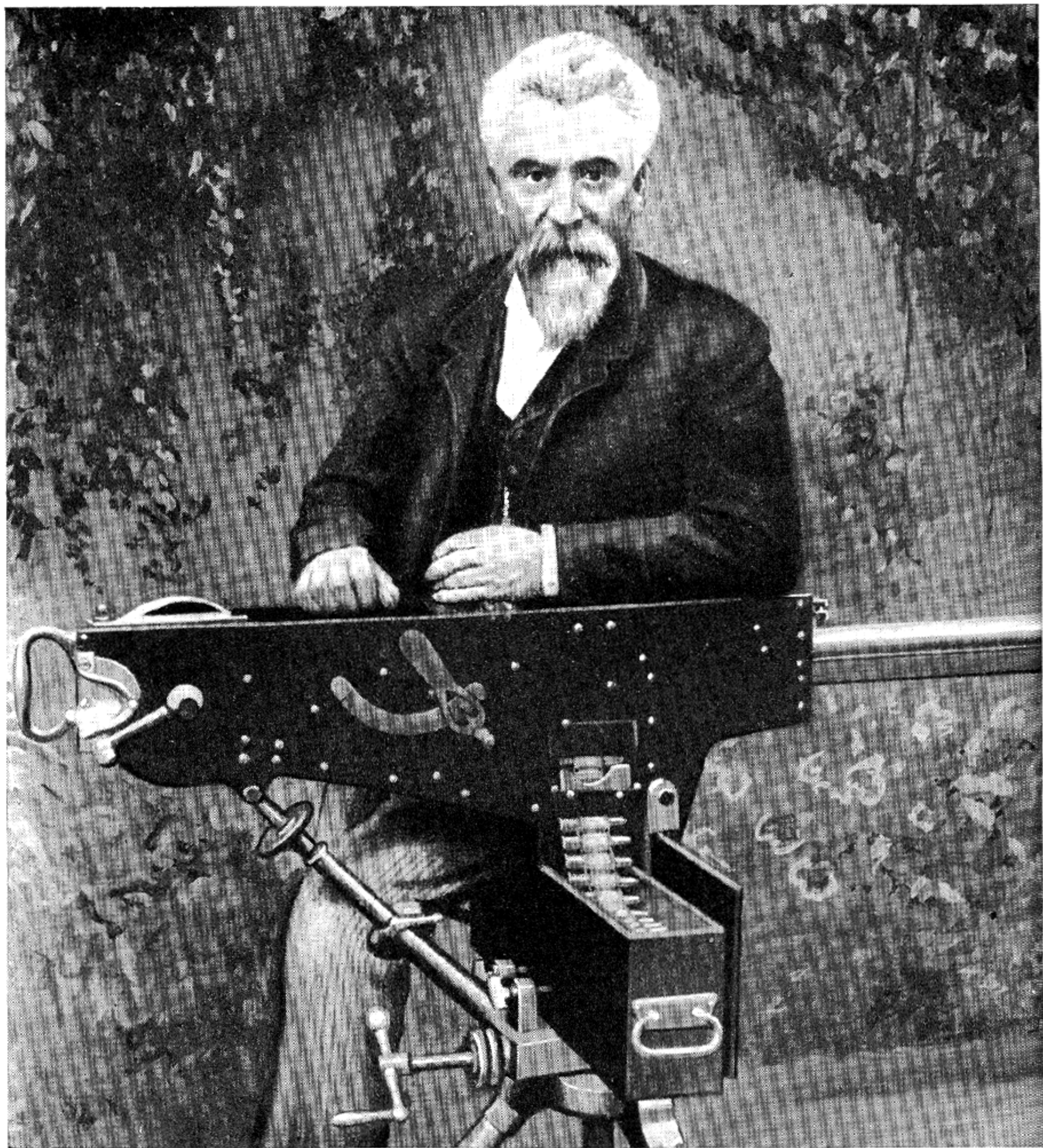

The First Model Maxim Automatic Gun.

one with the conventional post type vertical feed. Realizing that his success would not be complete until he had devised a way to make the weapon continuously feed cartridges from its own energy, he next designed two systems of feed, both operated from surplus barrel recoil energy, first the flat type drum and finally the belt. He perfected the latter, having concluded that it was the only practical system for sustained fire.

He produced several hand-made guns before he let it be known to the press that "Hiram Maxim, the well-known American electrician in Hatton Gardens, has made an automatic machine gun with a single barrel, using the standard caliber .45 rifle cartridge, that will load and fire itself by energy derived from the recoil at a rate of over 600 rounds a minute."

Everyone thought this was somewhat like the advertisement for the "world's greatest electrician" and a bit of Yankee brag. But this time he was waiting with the finished product to squelch any scepticism.

The first person of any prominence to see the new weapon was Sir Donald Currie. A day or so later, Mr. Matthey, a dealer in precious metals in Hatton Gardens, brought His Royal Highness, the Duke of Cambridge. The Duke was delighted and congratulated Maxim on a great achievement. This seemed to be the signal for everybody in London interested in such matters to visit Hatton Gardens to see the phenomenon.

The first cartridges he fired were manufactured by the British Small Arms Co. Many proved faulty. He applied to the government for better ammunition and was sold the latest lot number available, which proved satisfactory.

In demonstrating his weapon, Maxim personally fired over 200,000 rounds. Government authorities became interested in his gun. Lord Wolseley, accompanied by a large number of high ranking officers of the War Office, made an appointment with Maxim. At the designated hour Maxim fired thousands of rounds of ammunition for them. Afterwards, Lord Wolseley said to Maxim, "It is really wonderful, you Yankees beat all creation. There seems to be no limit to what you are able to do."

One of the officers in Lord Wolseley's party was Lt. Gen. Sir Andrew Clarke, inspector general of fortifications. He advised the inventor to

simplify the gun as much as possible and said, "Do not be satisfied until it can be disassembled, examined, and cleaned with no other instrument than the hands."

Taking his advice, Maxim immediately redesigned the feed system, and simplified the working mechanism, so that, if anything injured it, the components could be taken out and replaced in 6 seconds.

The only change from the prototype in what is known as the first model had been a refinement for the purpose of making a presentable gun for demonstration. Having proved the weapon, he now felt it advisable to lighten the gun as a whole and add the features suggested by General Clarke, until its high rate of fire, combined with its light weight and simplicity, would be a selling point. Basically it remained the same with the single barrel supported in a jacket by front and rear bearings.

At the moment of firing the recoil drives the barrel rearward for practically three-quarters of an inch. It is this movement of the barrel alone that unlocks the bolt and actuates the mechanism of the gun, producing continuous fire. The cartridges are placed in a canvas belt, similar to those worn by the sportsmen of that day. Each belt is seven yards long holding 333 cartridges with a clip device on the end for attaching another loaded belt. An external firing and rate control arrangement consisting of a lever placed against a graduated quadrant at the side of the gun determines the rapidity of firing. If the lever, or selector, is pulled toward the gunner until the pointer indicates the figure "1" on the quadrant scale, the gun will fire at the rate of one round per minute. By pulling the selector farther to the rear the rate of fire is gradually increased in proportion to the rearward travel of the lever, until the end of the scale is reached. Then the fire is maintained at the rate of 600 rounds per minute.

It was possible to fire a single shot, bursts of 10, 20, or 100 per minute and to maintain a continuous fire, fast or slow. When a rate had been selected, the gun would fire at that speed, independent of human agency, until all the cartridges had been discharged. Should the man working the gun be killed, the gun would still continue to fire.

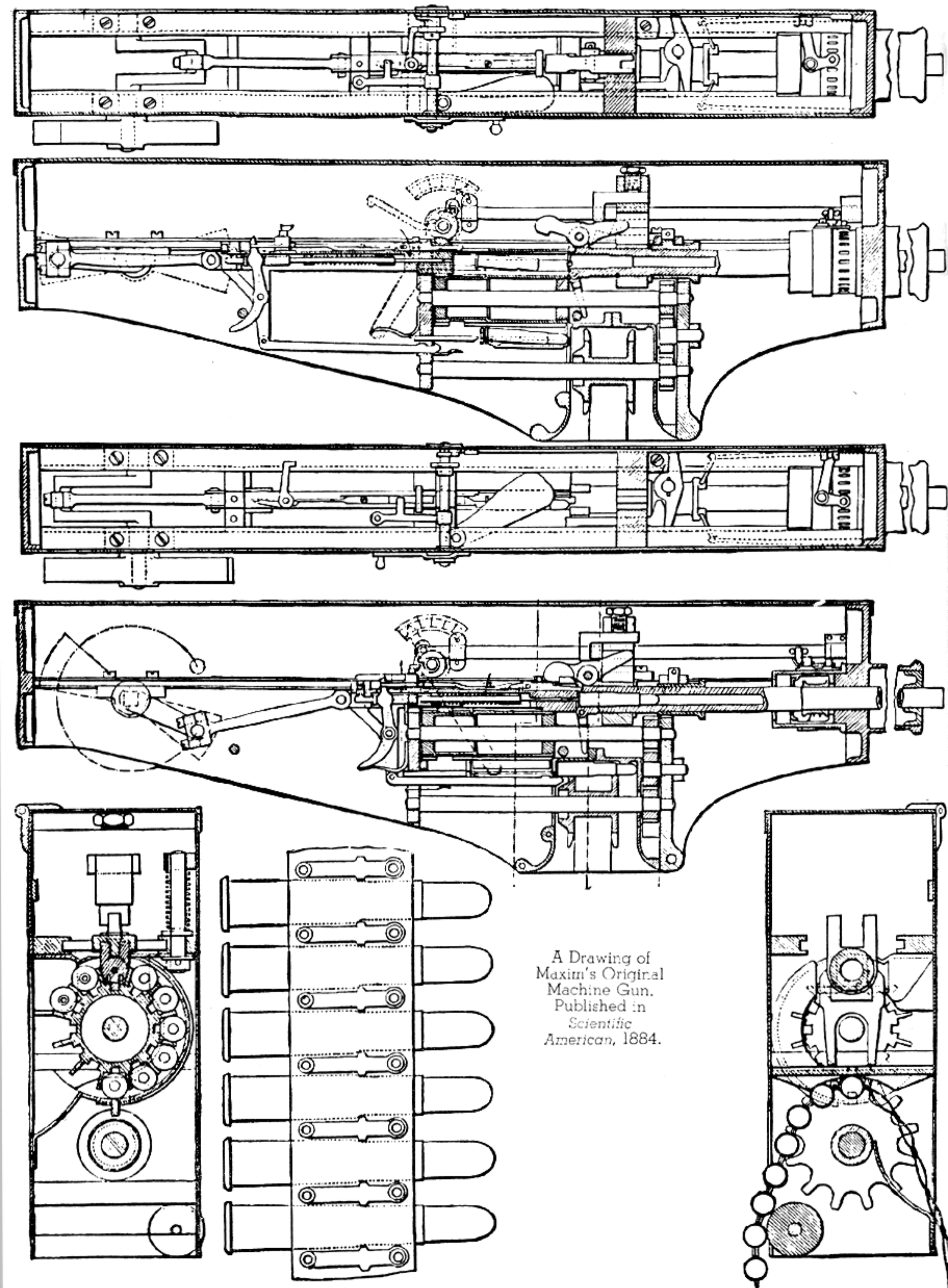

A Drawing of  
Maxim's Original  
Machine Gun.  
Published in  
*Scientific  
American*, 1884.

The rate-of-fire regulator found only on the very first model Maxims employed a simple hydraulic oil buffer arrangement. It controlled the speed of counter recoil by which the weapon returned to battery by varying the size of the orifice in the buffer tube through which the oil flowed. The weapon would complete the recoil movement without restriction but the return movement was checked by the oil and piston method. If the weapon's regulator was set for "Open," the operating parts returned to battery unrestricted and a rate of fire of 600 shots per

minute was maintained. If the orifice was closed, however, the return speed of the battery was slowed to any length of time desired, including a creeping action of a minute or more. While this device was very impressive, it was of small military value and was soon dropped.

Besides the system of feeding from a belt, Mr. Maxim devised another plan in which 96 cartridges are placed in a flat brass drum on top of the gun. The movement of the bolt rotating the drum, withdraws the cartridge and forces it into the feedway to be positioned in the chamber.

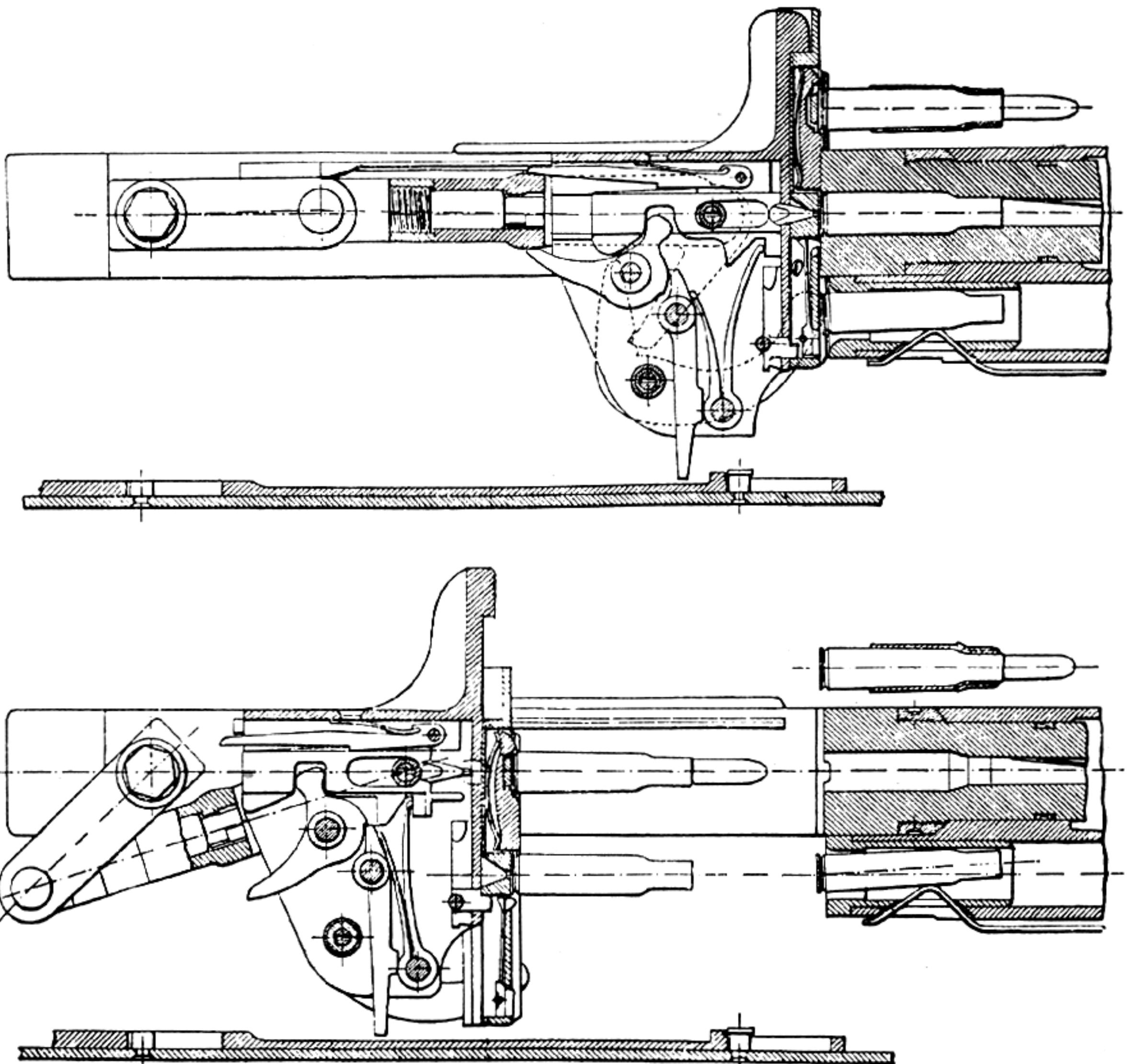

Breech Mechanism of the Improved Maxim Gun.

When the empty drum is removed, another can be substituted without stopping the operation of the gun, as an auxiliary magazine holds enough cartridges to maintain continuous fire.

Gen. Sir Gene Graham (Royal Engineers) preferred the belt feed to the drum feed and suggested that Maxim bend all his efforts to producing a gun that fed in this manner.

The machine gun belt feed was also used with Maxim's automatic rifle fired from the shoulder. In one instance, he altered a Winchester rifle so that the recoil extracted the empty cartridge case, ejected it, cocked the hammer, closed the breech, and performed all necessary functions except pulling the trigger. The inventor also made another gun in which all these operations were performed by means of a slight elongation of the cartridge case at the moment of firing, the case being corrugated to afford the required extension. The last-described system scarcely seems practical.

French Army officials, upon hearing of Maxim's automatic machine gun, invited him to demonstrate it before them. One of their first questions was whether it would be possible to produce one with a controlled rate of fire; they did not know the weapon already had this feature. Their idea was a gun firing automatically, but with a prolonged delay between shots, to be securely locked in position covering a breech in enemy fortifications. The intermittent shots, sighted in during daylight hours, would prevent men from working after dark in the target area.

For answer, Maxim fired the initial round, adjusting the regulator for one shot per minute, and left the gun by itself. While waiting for the second shot to explode, a young lieutenant approached, requesting to see the gun in action. Upon being told by Maxim that the gun was firing, he refused to believe it.

In a few seconds the gun went off by itself. The young lieutenant then waited with watch in hand. One minute later the gun went off again. He threw the remains of his cigarette on the ground, and walked off, exclaiming that while he had seen it, he still did not believe it.

To the French officers, Maxim described the weapon as an engine: the gunpowder in the cartridge being analogous to the steam; the breech block, the piston; and the trigger, the valve gear.

These basic characteristics have remained in every machine gun from that day to this.

Maxim's early successes led him to experiment in earnest on automatic guns from 1883 until 1885. During this time, insofar as it was possible, he patented every conceivable method by which automatic fire could be obtained.

The principle he decided to be the most practical was what is known today as the short recoil system. To this he added the ingenious features of initial extraction, adjustable headspace, an accelerator that transferred energy from the recoiling barrel to the bolt assembly, the T-slot extractor, and "wipe" ejector. These methods have not been improved on.

During the summer of 1885 the general public was shown the Maxim gun at the Inventions Exhibition in South Kensington, a small contract having been let to Albert Vickers, the steel producer of Crayford in Kent, for the manufacture of the gun. At the Inventions Exhibition the gun was fired daily for the crowds.

To operate the weapon, the gunner inserts the loaded ammunition belt in the right side of the gun and raises the safety catch. This permits the thumb piece to be pushed forward, actuating the trigger bar and sear and releasing the firing pin. As the powder charge in the cartridge is ignited, pressure is built up, and the projectile starts through the bore. During this time the barrel and bolt are securely locked.

After recoiling three-quarters of an inch, the bolt is unlocked. The crank engages the unlocking cam, breaking the toggle joint and freeing the bolt. The recoiling forces are now able to accelerate the bolt assembly to the rear and rotate the crank. This winds the actuating chain, loading the extension-type driving spring while the recoiling mechanism completes its rearward stroke.

The initial rotation of the crank pivots the cocking lever, forcing the firing pin back against its spring, until the sear engages the sear notch of the lever.

At the first movement of recoil after unlocking, the sliding boltface (T slot) begins simultaneous extraction of the empty case from the chamber and withdrawal of a loaded round from the belt. Continued rearward movement engage cams in the receiver to force the sliding boltface

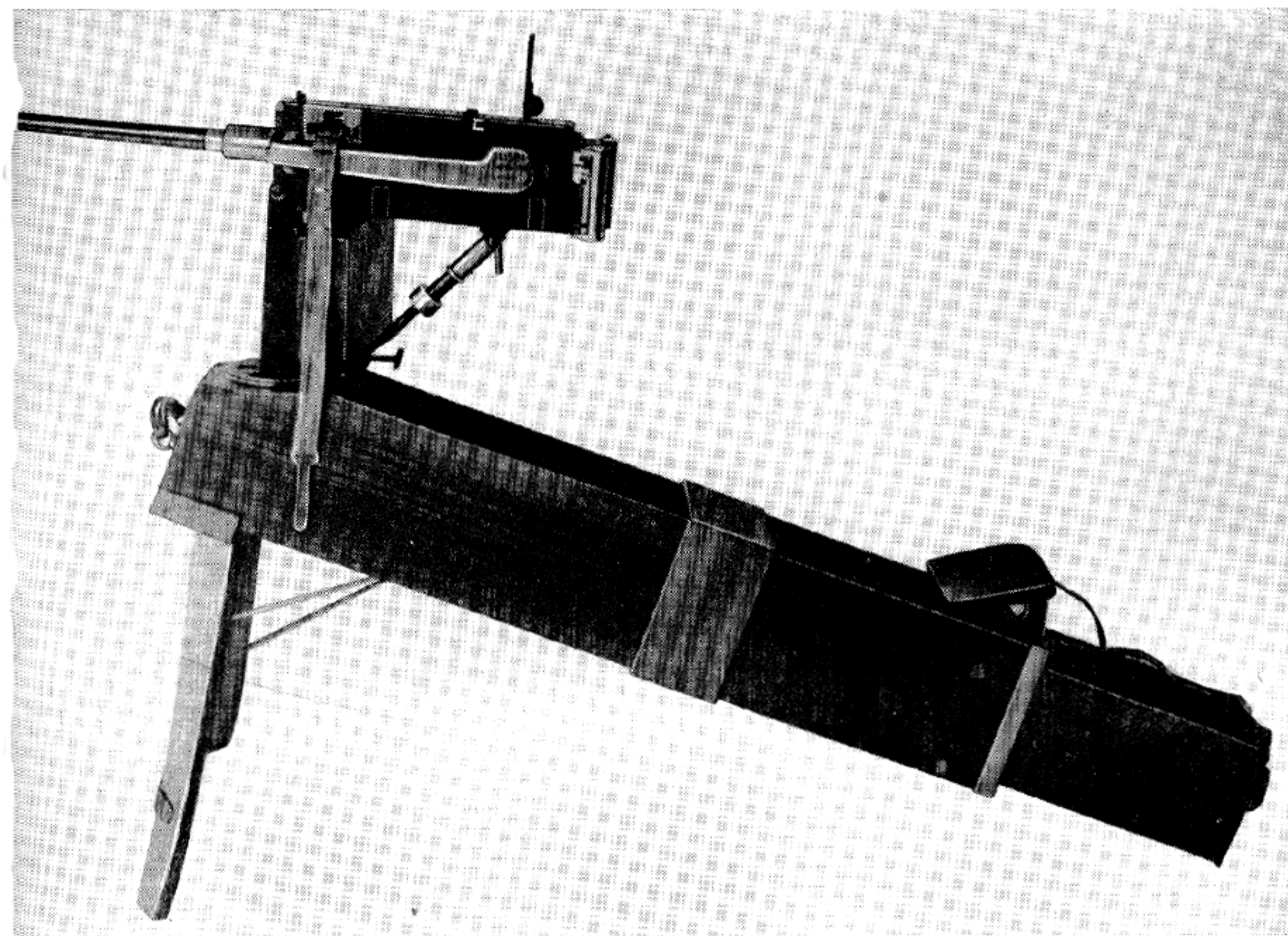

A Demonstration Gun and Mount Used by Maxim. The Wooden Case Was Used as a Tripod When Firing and to Contain the Gun and Ammunition During Transportation.

downward, bringing the loaded round in alignment with the chamber, and the empty case in position for the ejection tube. The loaded cartridge is held securely in place by a latch arrangement located in the face of the T slot.

During recoil a cam lever action moves the entire feed block slide to the right. The top feed-pawls move over to engage the incoming round in the belt (being held in position by the bottom belt-holding pawl), at the same time compressing the barrel return spring. After completing its full recoil stroke, the forward action of the barrel and barrel extension returns the feed block slide to the left, bringing the next live round in the ammunition belt into position against the cartridge stops for engagement by the sliding T slot.

The complete force of recoil having expended itself, the extended driving spring starts the movement of counter recoil. As the bolt moves

forward, the cartridge to be fired is positioned for chambering. When this is accomplished, the T slot rises, "wipes" itself clear of the spent case and slips over the rim of the incoming round in the belt.

When the bolt has reached its extreme travel forward, the toggle joint is forced slightly below the horizontal by the connecting rod. At this securely locked position the sear is depressed and disengaged from the firing pin, removing the safety feature, so that continued pressure on the trigger piece permits automatic fire.

The above cycle represents the basic operating principle on which were constructed all future Maxim and Maxim-Vickers guns (later internationally called the "Vickers"). There were from time to time a few modifications such as muzzle boosters to accelerate recoil, changing the direction of throw of the toggle joint, various attempts



to aid unlocking, and numerous miscellaneous refinements, but nothing that ever affected the original principles of the gun. Although Maxim chambered the weapon to shoot practically every form of cartridge in existence, ranging from black to smokeless powder and from rifle caliber to artillery ammunition, the mechanism remained the same except for weight, rate of fire, systems of cooling, and mounting.

### First Trials of the Maxim Gun

When the light version was finally satisfactory to Maxim, he displayed it at Hatton Gardens. Here Mr. Pratt, of the Pratt and Whitney firm, viewed the weapon. One of the finest machinists in the world, this old friend of Maxim's voiced his amazement, "If any one had told me that it would be possible to make a gun . . . do all these things in the tenth part of a second, I would not have believed it . . . But now I have seen it with my own eyes."

Maxim was wined and dined by London society and met many distinguished personages. On one occasion His Royal Highness, the Duke of Cambridge, took him by the arm, saying, "Come with me, Maxim, and I will introduce you to everyone here who is worth knowing." There were several members of the royal family present. Maxim capitalized on these contacts.

A short time later he received an invitation from the then Duke of Sutherland to spend a week end at Trentham, where he met the Duke of Manchester, Sir Reginald McDonald, and a Mr. Henry Stanley, later famous as the African explorer who found Dr. Livingston. Maxim and Stanley became fast friends. And Maxim humorously mentioned later how they hid out many times to keep from going to church, an act expected of all the guests.

Maxim always leaned strongly toward what he termed "book learning." Whenever he took up anything new, he read everything that could be found on the subject. As he had commenced to make guns, he purchased and read gun books, military documents, and the like.

One day a bookseller obtained for Maxim a very large volume supposedly published for the exclusive use of army and navy officers. In it,

Maxim saw at once a fallacy of reasoning. The designer was calculating a "one-shot" weapon. Repeated shooting would destroy it if constructed on such erroneous calculations. Maxim felt that, if international authorities dispensed such false doctrine, the profession needed practical experience in gun design.

Mr. Pratt, before leaving London, again visited his old friend, and stated he had never made successfully a certain type of gun actuating spring last more than a few rounds. Maxim told him a secret process for constructing springs which an old gun maker had taught him. Pratt, after returning to the United States, wrote how successful this method had been. The springs made following Maxim's instructions had all been tried thousands of times on a testing machine devised by Pratt without any indication of breaking.

The British Government's first order for a Maxim gun specified that it must weigh less than 100 pounds, and be able to fire 400 shots in 1 minute, 600 shots in 2 minutes, and a thousand in 4 minutes. Three guns were supplied to the British Government for trial in March 1887. They easily passed the test. The last fire delivered a thousand rounds in a minute and a half, having previously passed the sand and rust test. The three guns were then purchased by the government. Yet the machine gun was not adopted as a weapon in the regular British Army at this time, although the territorials and militia acquired and used several on their own initiative.

Maxim had unlimited confidence in his gun. When he received an invitation to fire at Enfield for an official trial, he was delighted. After having passed every test easily, he placed the gun on an ordinary tripod, put in a double cartridge belt that contained 666 rounds, and fired them all in 1 minute. As an added attraction, he provided himself with a very large ammunition box and a belt containing 3,000 cartridges. The gun was placed on a naval cone, such as used for machine guns on battleships. The bottom of the cone was filled with water and compressed air. Upon pulling the trigger, a valve was opened allowing the water to circulate inside the water jacket. This provided a cool gun. Maxim introduced the belt and pulled the trigger. The cartridges ran through the gun at the rate of 670 a minute. Many of the bystanders had to leave before the

belt was emptied because the constant firing hurt their ears.

In 1887 Maxim also took one of his automatic machine guns to Switzerland for trial in competition with the Gatling, the Gardner, and the Nordenfelt. The two-barrel Gardner had already beaten the field and large orders were expected. Maxim wrote to the authorities telling them what his gun could do and asking them if they would allow him to fire it in Switzerland in competition with the Gardner. On this occasion he was accompanied by Mr. Albert Vickers, who was now deeply interested in the business. Their gun had been chambered to use a certain German-made cartridge which was not quite so large and powerful as the English. When testing it against the Gardner, they found the latter was using a new cartridge of smaller bore and longer range. To compete with the improved Gardner cartridge, Maxim dipped his projectiles in hot beeswax and tallow to prevent barrel fouling and lubricate the bore. Vickers did the firing and showed great skill as a machine gun marksman, as he outshot the Gardner in spite of its improved ammunition.

The next trials were in Italy at Spezzia, in competition with the Nordenfelt gun, which had already been thoroughly tested and the performance of which was definitely known.

The Maxim gun was lighter and by trial proved much faster and more accurate. Fewer men were required to work it. Next, the Italian officer in charge of the test requested Maxim to submerge the gun in the sea, and allow it to remain there for 3 days. At the end of the period, without cleaning, the gun performed as well as it did before subjection to this unusual demand.

After Italy, the next demonstration was held in Vienna, where thousands of rounds were fired before high ranking army officers, who expressed their amazement that a little gun could fire so fast, and that the crank handle should turn without anyone touching it. Among the high officials who came out from Vienna was His Royal Highness, Archduke William, the Field Marshal of the Austrian Army. He greeted Maxim warmly, and looked with great curiosity at the gun. Maxim showed him the working mechanism and explained all the parts in detail to him. He was then asked to fire it at various ranges. Vickers

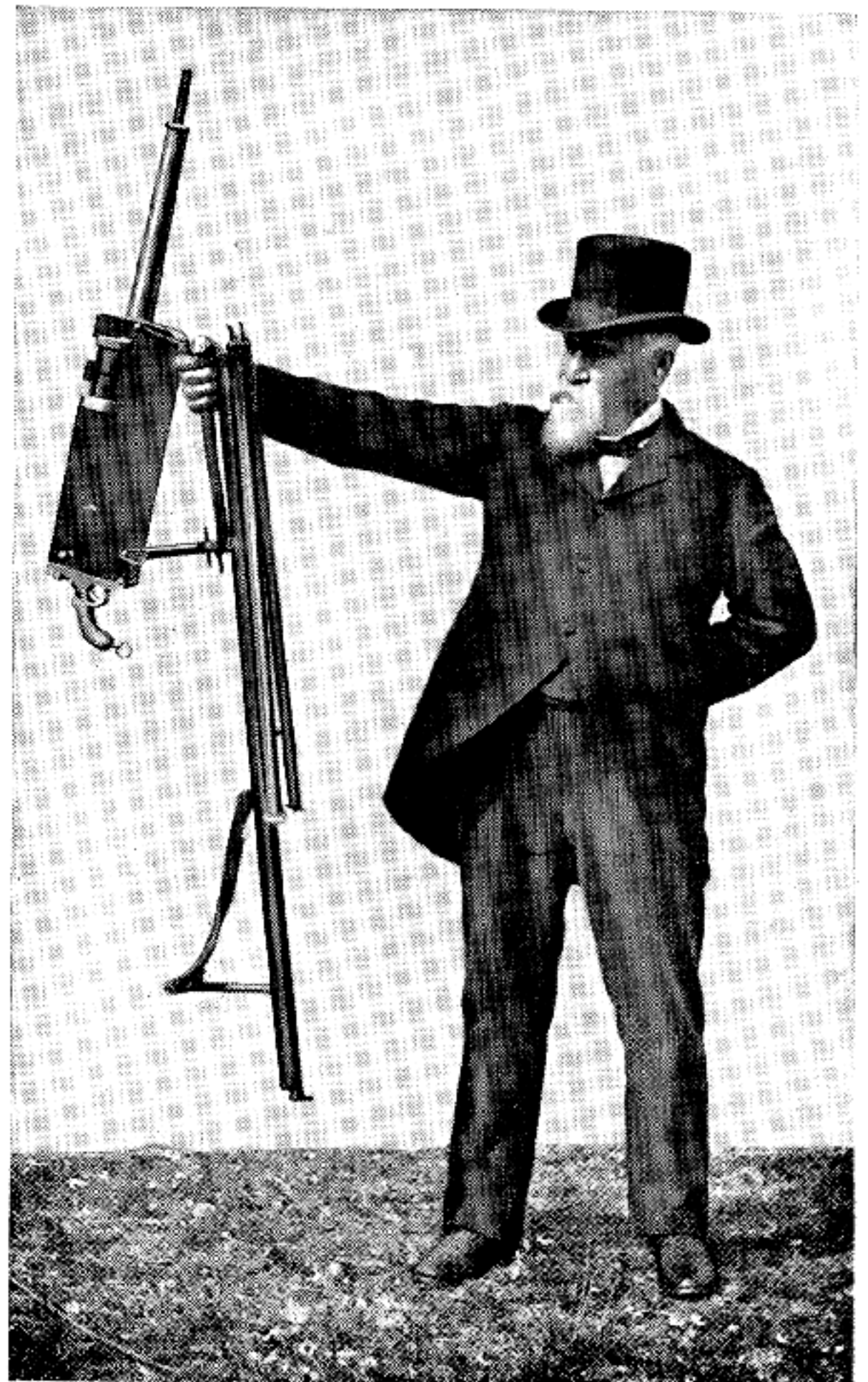

Hiram S. Maxim Holding the Light Maxim Gun and Mounting.

and Maxim alternated in operating the weapon and fired practically the entire day. After the test, the archduke approached the party and congratulated them on the performance of the weapon. When asked by Maxim if it fired fast enough to suit him, he answered, "Indeed, too fast. It is the most dreadful instrument that I have ever seen, or imagined."

During this Austrian test, Maxim used British-made cartridges. While the officers were well pleased with the gun, they insisted on having one that used their own rifle cartridge, which Maxim agreed to make on his return to England. Unfortunately it was illegal for anyone to take one of the Austrian service cartridges out of the country. He had to content himself with a mechanical drawing and a piece of unprimed brass. Upon his

return to England, he ordered a lot of cartridges made according to the specifications. But it appeared that the manufacturer, the Birmingham Small Arms Co., did not understand continental weights and measures. The shape and size of the completed round was correct, but the powder charge was considerably lighter than that of the Austrian cartridge. Maxim attempted to fire the ammunition and found that it would work successfully if the springs were lightened to compensate for the weak charge.

On 7 July 1888 the Austrian committee on the Maxim ordered a preliminary trial with two rifle caliber guns (one 11-mm). They were satisfied as to rapidity of fire, simplicity and ease of manipulation. At 200 meters, 30 shots, all hits, were made in 3 seconds. At 400 meters the same story was repeated. At 600 meters there were 40 rounds in  $4\frac{3}{10}$  seconds, all hits. At 1,000 meters, 40 shots in 4 seconds produced 36 hits. At 1,200 meters 25 shots in  $2\frac{5}{10}$  seconds gave 24 hits. Again at the same range, 40 shots in 4 seconds gave 29 hits. At 1,400 meters 60 shots fired in  $6\frac{1}{10}$  seconds gave 46 hits. And at 1,575 meters, 60 shots in 6 seconds gave 45 hits.

For a reliability and endurance test, 13,504 shots were fired without serious mishap. The cartridges were supplied in belts each containing 333 rounds and averaged 10 rounds per second during the entire test. The original mainspring was of insufficient strength, and gave way after 7,281 rounds. A striker broke after 10,223 rounds and a buffer failed after 11,418 rounds. But these were easily replaced on the scene in a few seconds, and the firing continued. The committee reported strongly in favor of the Maxim. After 6,356 rounds the accuracy was found to be excellent.

The official report stated, "Wet does not impair the mechanism; dust diminishes the speed of firing, but the mechanism, especially the feeding apparatus, is very susceptible to wet and dust combined. If certain reserve parts are supplied, and the buffer spring made stronger, the efficiency of this machine gun is guaranteed under all circumstances."

The committee concluded with this significant summation: "From the foregoing results it is evident that the original favorable judgment

formed after the preliminary trials was justified. It can therefore be asserted that of all systems of machine guns hitherto tried, the Maxim is the best adapted to the purpose for which it is intended."

The next test was in Germany. Although the gun worked perfectly, no decisions were made for a long time. Thousands of rounds were fired, but still no orders were received. While things were in this state, His Royal Highness, Albert Edward, Prince of Wales, visited the Kaiser. When the conversation turned to arms, the Prince asked the Kaiser if he had yet seen the Maxim gun. He said he had not, but had heard a lot about it. The Prince told him that it was really a wonderful weapon, loading and firing itself 600 times a minute. As the gun was at Spandau, only a short distance from Berlin, the Prince suggested they see it. A day or so later, the Kaiser and the Prince visited Spandau where elaborate preparations had been made to show all forms of machine guns. A total of 333 rounds were to be fired from each gun under test at a large target located 200 meters distant. The Gatling gun, worked by four men, fired the cartridges in less than a minute. The same number of men fired the same number of rounds from the Gardner gun in a little over a minute. The Nordenfelt also was fired in approximately the same time. Then Maxim advanced, took his seat on the trail of his automatic gun, pressed the trigger, and 333 cartridges were fired in less than half a minute. The Kaiser, much impressed, walked over to the gun; placing his hand upon it, he said, "That is the gun—There is no other."

Had Maxim tried to market his invention a short time earlier, there is ample reason to believe that he would have found his task more difficult. Several powers were alert for an improved gun when his was introduced. Had he found all war departments completely stocked with hand-operated weapons, he would have had no purchasers. Italy already owned many Gardner hand-operated machine guns. She ignored the new, expensive automatic, as did the United States. The hand-cranked Gatling was relied upon in this country 10 years after the British service had purchased the Maxim full automatic.

In 1887 Maxim took his gun to St. Petersburg, Russia. Here he used the well-made English car-

tridges on which he could rely. It appeared to Maxim that the Russian officers were very impatient, and looked with contempt upon his little gun. One young officer went up to it, took hold of the crank, turned it backwards and forwards, and said in French, "It is absolutely ridiculous for anyone to pretend that this gun can be fired 600 rounds in a minute. No man living can turn this crank handle backwards and forwards more than 200 times in a minute."

The Russian even offered to bet any reasonable amount that the gun could not be fired as fast as 200 times a minute. Maxim chose to answer him by placing a belt of cartridges in the gun and fired 333 shots without stopping. The handle that the officer was talking about worked so fast by itself that it was impossible to see it. The officers present had not the least conception of what an automatic gun really was. Any gun in Russia was said to be automatic when one turned a handle to fire it. Newspapers described it as "a

gun that would load and fire itself simply by turning a crank handle."

The Russians, seeing the handle working by itself and the center of the bulls-eye shot away, were wildly enthusiastic. But Maxim encountered much red tape in Russia. He had not been in St. Petersburg 2 weeks when he was informed he must either leave the country or go to police headquarters and give an account of himself. A friend, Mr. de Kabath, went with him.

The official spoke English perfectly, and commenced by asking Maxim how old he was and where he was born. Maxim told him.

"What religion have you?"

"None whatever, never had any."

He was told no one could remain in Russia unless he had a religion. He replied in that case he would most certainly have to find one—what particular brand did the officer recommend?

Mr. de Kabath suggested that it was more popular to be a Protestant.

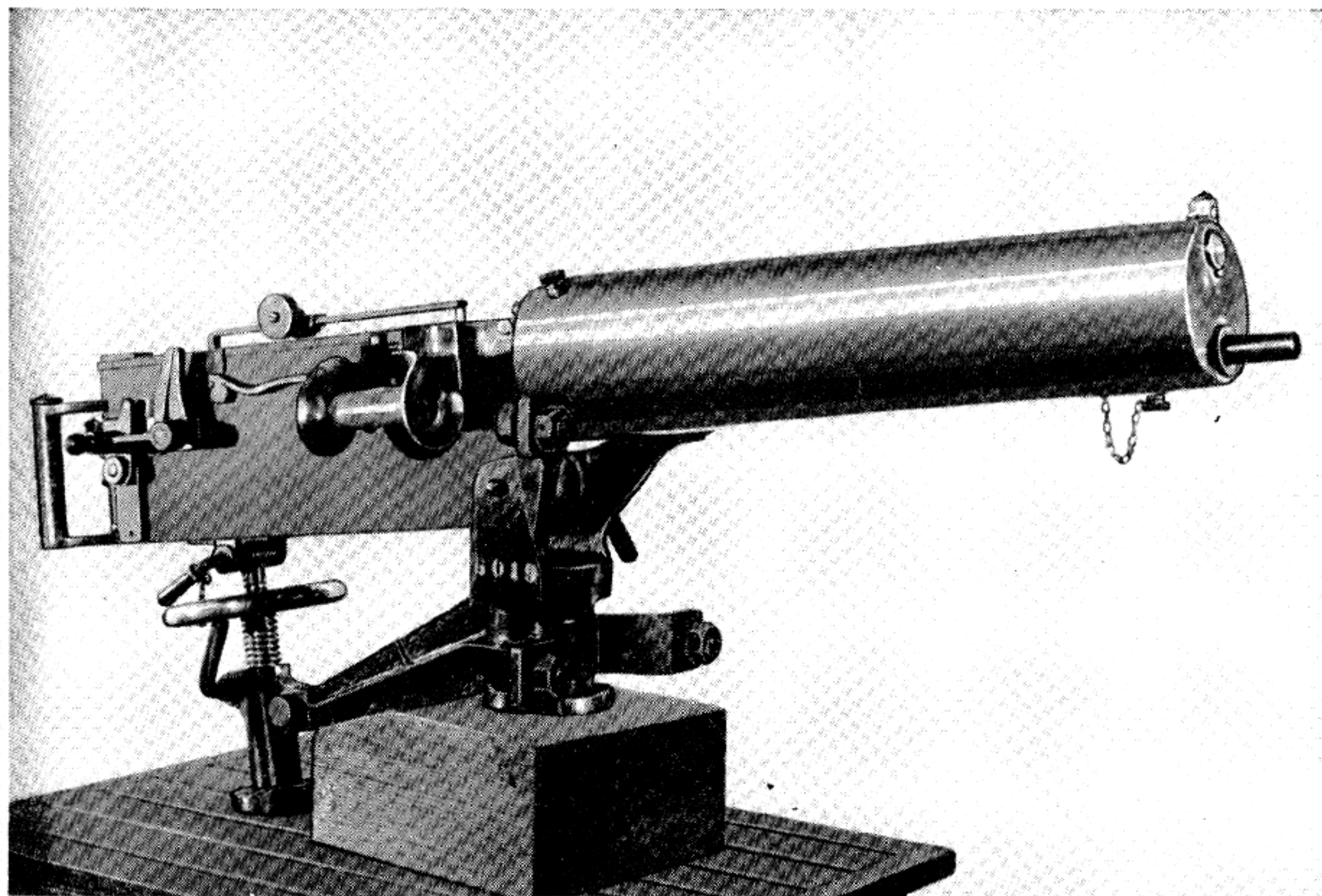

Maxim Machine Gun, Model 1893, Cal. .45.

Maxim asked if a Protestant was not one who protested against something? The Russian admitted that such was the case.

Maxim then said to the official, "Put me down as a Protestant. I am a Protestant among Protestants. I protest against this whole thing." In that way, Maxim said, he became a member of the Protestant church.

Although the Russians moved slowly, they finally purchased vast numbers of Maxim guns. Later, observers reported that over half the Japanese casualties in the Russo-Japanese War were inflicted with the Maxim gun.

On 23 April 1892, Maxim published an article in *Engineering*, from which the following is quoted:

"Of late there has been going the rounds of the press, especially in America, an account of an automatic machine gun made by the Winchester, which is said to fire a thousand rounds a minute, and to beat the Maxim, because the Maxim only fires 750 a minute. In connection with this it might be interesting to the public to know just how fast it is possible to fire a single-barreled automatic gun, and what sort of cartridges can be fired with the greatest rapidity.

"The first automatic Maxim gun which was submitted to an official test at Enfield was claimed to fire 600 rounds a minute, using the Royal Laboratory machine gun cartridge. At the trials 1,000 cartridges, all in one belt, were fired in 1½ minutes. This would give a speed of 666 rounds per minute. The Royal Woolwich cartridges, considered from all points, are perhaps the most perfect cartridges to be met with today. Of over 200,000 rounds which I myself have fired, I have only found one faulty cartridge, and this missed fire on account of not having any fulminating powder in the primer.

"At the official trials in Switzerland, where the German Mauser cartridge was used, the official speed was 612 per minute. At the Italian trials, which took place with the same cartridge at Spezia, the rate of fire was found to be 620 per minute. The French Gras cartridges, which had been made for 7 or 8 years, were found to fire at the rate of about 500 per minute; those which were only 2 or 3 years old, at the rate of 600 a minute; while with those that had only

been made up a few weeks, the rate of fire amounted to nearly 700 rounds a minute.

"At the Austrian trials with the old Mannlicher cartridges the rate of fire was 620 rounds per minute. With the new Austrian cartridge with compressed powder a speed as high as 770 per minute was attained. With the Russian Berdan cartridge, made on the old fashioned plan, having a hollow rim, 1,000 rounds were fired out of a single belt in 2¼ minutes. This was the slowest of all European cartridges except those made in Italy for the old Vetterli rifle, which were found to be imperfect, and the rate of fire in some cases did not exceed 300 per minute. In Spain, cartridges were found which were so bad that they could not be fired at all with an automatic gun. In Germany, the rate of fire varies according to the kind of cartridges which are employed and ranges from 600 to 700 per minute.

"Of all the black powder cartridges the American service cartridge has been found to attain the highest speed. This arises from the fact that the cartridge is small and short, the powder compressed, and the primers very large. At trials which took place in England with this cartridge the rate of fire was 742 per minute. At trials which took place in the United States, in which new cartridges made by the Union Metallic Cartridge Co. were employed, the rate of fire was 775 per minute. This was the highest rate of fire ever attained by an automatic gun deriving all of its energy from the recoil.

"After the Maxim gun had been formally adopted into Her Majesty's service it was found necessary to provide some means of operating them with blank cartridges, as these of course did not give sufficient recoil to operate the mechanism. Attachments were then put on to guns which were required for the maneuvers, in which the escaping gases at the muzzle of the gun produced an action upon the barrel similar to that of recoil. The first of these guns was made for the Easter maneuvers some 5 years ago, and the first cartridges experimented with were loaded with 60 grains of black powder, the rest of the case being filled with tallow, but the rate of fire was so enormously high that the powder charge was reduced to 42 grains, and with this the rate fell to about 600 per minute.

"About 2 years ago, while we were experiment-

ing with the French Lebel cartridge in Paris, I had a gun constructed to utilize the force of the escaping gases at the muzzle for operating the mechanism. The number of cartridges which the officer brought to the trial was only 200; consequently only small belts were used. Upon placing a belt of 20 cartridges in the gun and pulling the trigger, I remarked, 'The gun has stopped, it does not work,' whereupon my French assistant pulled the belt out and said, 'It is quite empty.' My ear had been accustomed to a fire of about 600 per minute, and the usual belts that we first try a gun with hold only 10 cartridges. These 20 Lebel cartridges had gone off in just about the time that 10 English cartridges would have been fired. The speed was found to be somewhere between 1,100 and 1,200 rounds per minute, and the officer in charge decided that the rate of fire was altogether too high, expressing the wish that we should seek to reduce the rate of fire rather than to increase it.

"It is a curious fact that the German and the French committees, acting quite independently of each other, expressed their opinion that the most desirable rate of fire would be 250 per minute, and guns were, in fact, made for these two nations provided with regulators, but it was found that the mechanism necessary to reduce and regulate the speed of a gun was quite equal to all the rest of the mechanism in the gun. The first one-pounder Maxim guns fired at the rate of 400 shots per minute. The speed was afterwards reduced to 300 per minute.

"The effect of very rapid firing upon the chamber and rifling of the gun is most marked. In Austria, when a gun was fired at the rate of about 600 per minute with steel-covered [jacketed] bullets, and the fire was often stopped to replace the ammunition boxes, it was found that the gun made as good a target after 20,000 rounds had been fired as it did upon starting, while with a speed of 670 per minute with practically no stoppages, the bore was considerably injured after 10,000 rounds had been fired. During all the Austrian trials with the Maxim gun, 200,000 rounds of ammunition were used, the greatest number fired at one time from a single gun being 35,000.

"As regards the speed that it might be possible to attain with a single-barreled gun, I would say

that probably if both the gun and cartridge were made expressly for producing the highest possible rate of fire, and if the recoil energy, together with the escaping forces of the gases, were both utilized, 1,500 to 1,600 rounds a minute might be fired, but at this speed the barrel would be very highly heated, even if inclosed in a water casing.

"Machine guns which are operated by hand are as a rule provided with more than one barrel, and perhaps the greatest absolute speed that ever has been attained was with a 12-barrel Nordenfelt gun, in which each barrel was fired 100 rounds per minute, but this fact can only be accomplished by a very powerful and trained athlete. The Gatling 10-barrel gun did not, I believe, fire over 400 rounds a minute at the Shoeburyness trials, but it is said now to fire at the rate of 100 rounds per barrel per minute. The greatest speed ever attained by a single barrel hand-operated machine gun was when Gardner himself fired 250 rounds per minute. The Nordenfelt five-barrel gun, such as is used in the British Navy, may be fired with three trained operators about 400 to 500 rounds per minute. At the Swiss trials the two-barrel Gardner gun, with four men to operate it, fired 333 rounds in a minute."

While the whole world marveled at the machine guns of American origin, a French chemist, Paul Vieille, was quietly trying to develop for his government a smokeless powder that would not reveal the infantryman's position or obscure his aim. In 1885 he discovered a successful propellant that gave off practically no smoke. Mixing cellulose with gelatinized nitroglycerine not only eliminated smoke, but produced a progressive burning powder that left little or no residue. While seeking a musket propellant, he had unknowingly invented the perfect fuel for the automatic machine gun.

Black powder generates all its force at the moment of ignition, then the chamber pressure decreases quickly. Smokeless powder, on the other hand, continues to burn after maximum pressure, giving a prolonged thrust, leaving a high residual pressure in the bore. This allowed machine gun inventors to design mechanisms taking full advantage of this prolonged power-impulse, and to utilize the force of expanding gases in the

barrel after the projectile is gone, to accelerate further the recoiling parts.

That the engine came before the fuel cannot be questioned. Maxim was already firing his automatic gun over the continent of Europe, using almost any black-powder cartridge of current design. But peak efficiency was not reached until he used the French Lebel service cartridge. The prodigious rate of fire mentioned in his article in *Engineering* was produced by the first military cartridge in the world having smokeless powder as a propellant charge.

The Maxim gun was first used by the British colonial forces in the Matabele War of 1893. In this campaign of 1893-94 against the Matabele of the Northern Transvaal, a detachment of 50 infantrymen with four Maxim machine guns defended themselves against 5,000 warriors who charged them five times in an hour and a half. All of these fanatical charges were conducted with great bravery and were invariably stopped each time about a hundred paces in front of the English firing lines by the lethal fire of the Maxim guns. It was recorded that the enemy after the charges left 3,000 dead in front of the English position. The troops engaged against the Matabeles were the armed police of the Rhodesian Charter Co. They were greatly outnumbered by the enemy which attacked with the reckless courage of the Zulu tribes. The Rhodesians, realizing the deadly power of the machine guns, provoked the Matabeles to charge. A handful of men fortified themselves with Maxim guns. And against these determined rushes of thousands of fierce fighting savages, the streams of bullets from the Maxim guns tore lanes of dead through the enemy masses and always broke the attack.

In the Chitral campaign in 1895 on the Afghan frontier, the English again used their Maxim guns against the fanatical mountaineers of the Hindu Kush, the fire proving so effective that the British colonial troops who charged the position found only the dead bodies of the enemy to oppose them.

Later on, in some of the fights of the 1898 campaign in the Sudan these guns were extremely successful. It is stated that General Kitchener could not have held out had it not been for them. A battalion had two machine

gun sections, each organized as a battery of four Maxims mounted on wheeled carriages. A special precaution was taken to prevent the mechanisms from becoming fouled by the desert sands which formed almost a fog on windy days in the Sudan. Each gun had a silk cover in which it was kept wrapped until brought into action.

At Ferkeh, on 7 June 1896, the four guns were only in action for a few minutes, but in this time they broke up the dervishes' only attempt to charge. Perhaps the battle of Omdurman was the most classical example of the deadliness of the weapon. No less than 20,000 dervishes were slaughtered and three-fourths were officially credited to the Maxim machine gunners at this battle. A German military attaché, Major von Tiedemann, told how he watched the effect of the Maxim gun battery on the right front. "The gunners did not get the range at once. But as they soon found it, the enemy went down in heaps and it was evident that the Maxim guns were doing a large share of the work in repelling the dervish rush."

For a moment it seemed as if the dervishes might overwhelm the Sirdar's forces. In dense array they moved forward, but their ranks were torn by the murderous machine gun fire. It is interesting to add here that Winston Churchill went into action with the cavalry charge, almost the last on record in British history. He was attached to the Twenty-First Lancers. British casualties amounted to less than 2 percent, while the enemy was practically annihilated (all due to the deadly Maxims).

Hoping to reach American markets, Maxim wrote to all prominent gun and pistol producers in the United States, telling them that his automatic system could easily be applied to all sizes of pocket pistols or rifles, and advising them to use his mechanisms under license. From these gunmakers he failed to receive one favorable reply. In fact, he stated, most of the answers were scurrilous. In spite of professional jealousy his market grew. Soon the little factory in Hatton Gardens became too small to fill all the orders for his automatic machine guns.

Maxim amalgamated for a short while with Nordenfelt, the financier, and formed the Maxim Nordenfelt Guns & Ammunition Co. In this way he was able to take advantage of the manufactur-

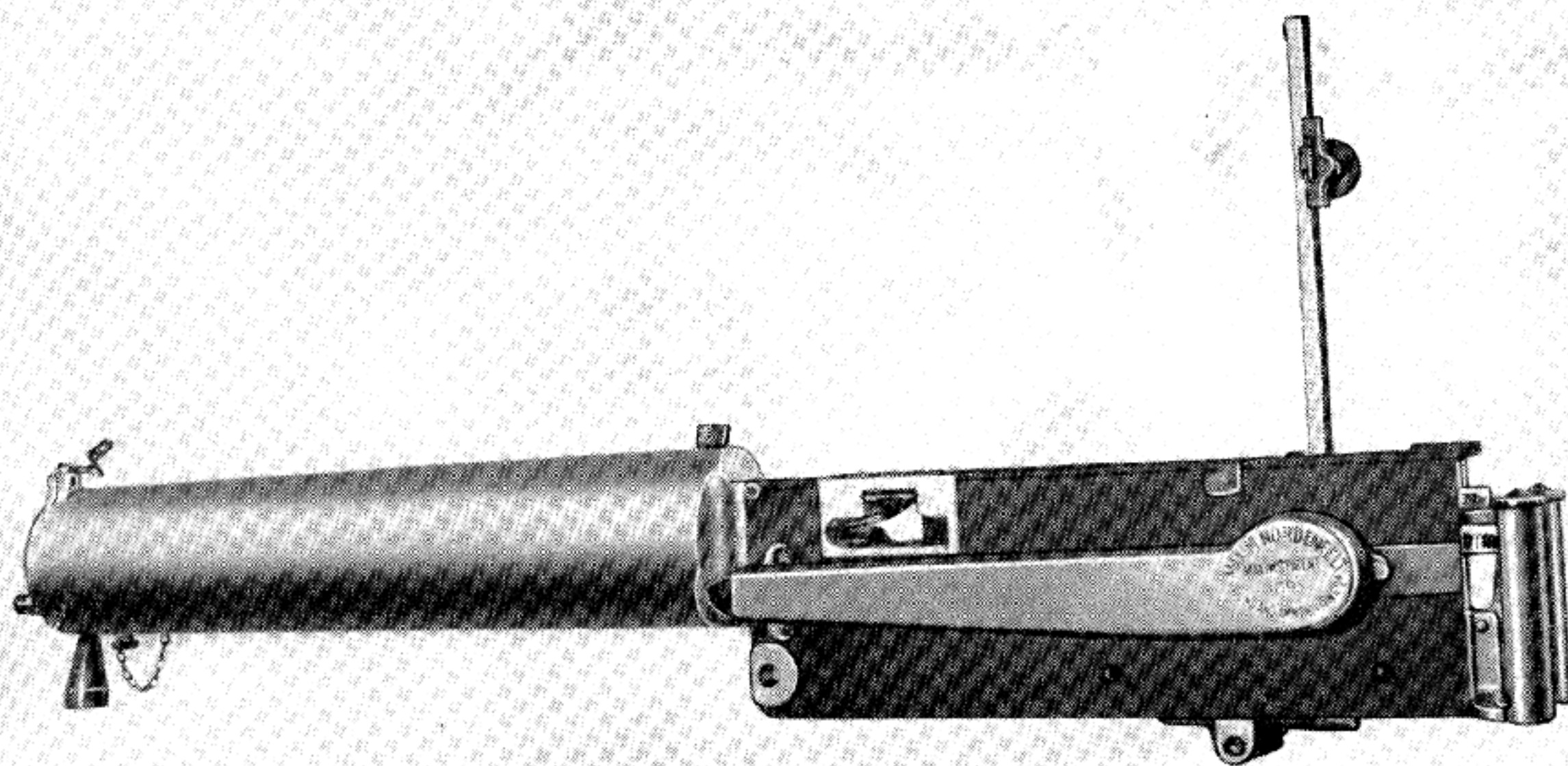

Maxim Machine Gun, Model 1895, Cal. .303.

ing facilities of the Nordenfelt plants to fill his backlog of orders. While they produced many models of rapid-firing naval guns, the only automatic weapons manufactured were the 37-mm pom-pom and the rifle caliber gun, known as the Maxim-Nordenfelt. All were based on his earlier patents.

### Other Maxim Weapons

The success of the rifle-caliber gun led the British Admiralty to ask Maxim to design a special-objectives weapon for use against torpedo boats, specifying that the projectile must be large enough to penetrate light armor, and the rate of fire as high as thought practical.

Lord Wolseley asked Maxim also to produce, if possible, a projectile that could be used effectively against armor at a great range when used as solid shot, but at the gunner's will the same projectile could be converted to fragments having the effect of a shot gun with buckshot when used against personnel at close range.

These demands resulted in 1898 in the long range caliber .75 machine gun with the disintegrating bullet. This projectile was of peculiar construction, being made up of several segments, arranged around a central steel core and held to-

gether by rings of lead, hardened by adding tin. A cutting device on the muzzle allowed the gunner either to fire a solid armor-piercing bullet at great range, or to spray fragments over an area at close quarters. The cutter having severed the bands, the projectile disintegrated from centrifugal force. When not cut, it stayed together and the hardened core easily penetrated light armor.

The next development was the pom-pom, an automatic 37-mm shell gun. The name was given it by African savages trying to describe its unusual report during automatic fire. The operating mechanism was basically the same as the rifle caliber gun. Originally rated at 400 rounds a minute, Maxim concluded this was too fast for peak performance, and slowed the action to 300 a minute, where it remained.

It is ironic that the pom-pom, developed at the request of the English Government, was ignored by the major powers until it proved its deadliness in use against the British soldier. The weapon, when introduced, was scorned by English artillery experts. They contended it was too large for use against personnel, too small for employment against fortifications, and any field battery could put it out of commission in a relatively short engagement.

The War in South Africa disproved their eval-



uation. The Boers obtained a few of these automatic shell guns and, in engagement after engagement, a single pom-pom manned by a crew of four secreted behind rocks and dense foliage would quickly put out of action a whole battery of British artillery. The cartridges were loaded with smokeless powder. The Boers got on a target with single shots, and then covered the area with a full automatic burst, usually fatal to the British artillery unit. The English gunners, though skillful, were unable to take aim at the sound. And, before they could locate their adversary, their battery would be destroyed.

The Boers were aided by their exploding projectiles as the smoke and dust from the detonation showed the pom-pom gunner how far he was off in sighting. Then, making the correction, which rarely took more than three or four spotting shots, he fired approximately half his 25-round belt full automatic into the target.

Neutral newspapers all over the world gave page after page of publicity to the plucky Boers in annihilating the British field artillery units.

Maxim pointed out that the error was not his, as he had made the weapon at the suggestion of the English Government, only to have it turned down by the army. The Boers had purchased their guns from the French, who had bought a considerable number, ostensibly for their own use.

Maxim later was approached by a Chinese Government representative in London, who stated, in behalf of his country, that he would like to see the firing of the 37-mm and rifle-caliber Maxim guns. On the day fixed, the Chinese staff met with a large number of prominent Londoners to watch the demonstration. After a 1,000-round burst by three Maxim rifle-caliber guns, the pom-pom was brought into position. The Chinese representative questioned its advertised rate of 400 rounds per minute. The gun fired, and the projectiles, being filled with explosives, went off upon striking the target. When the firing had ceased, he observed the bursts from the exploding shells continued to flash at the target. When this had stopped, he still heard the reports of the exploding shells from the distance. He at once came to the conclusion that there was some trick, that some machine located behind the tar-

get was producing the flash and report, having failed to cut off when the gun was stopped.

It was then explained to him, as had been previously done for other incredulous observers, that, with the target a thousand yards away, a number of projectiles were still in the air when the gun ceased firing. After the last projectile had struck the target and exploded, the reports in the air were still echoing. The Chinese was satisfied, and, as he had timed the gun with his own watch, said it fired faster than 400 rounds a minute. He examined a cartridge and, on being told the price was 6 shillings 6 pence, he said, "This gun fires altogether too fast for China."

The King of Denmark, likewise, wished to see the pom-pom fired. When told the cost per round he stated, "That gun would bankrupt my kingdom in about 2 hours."

The English press also took up the cry "Economy," pointing out that at 6 shillings for each shell fired, these guns would require the expenditure of 90 pounds per minute in cost of ammunition. The quantity of ammunition for this one gun alone in a war, even if victory were assured, would make the cost prohibitive.

The British Government, still smarting from the lesson handed it by the Boers, who were not so economy minded, answered these paper theorists by adopting the weapon and ordering millions of rounds of ammunition.

### Vickers-Maxim Machine Gun

Though the short-lived Nordenfelt association produced the pom-pom, Maxim's best known and lasting affiliation was with Vickers. Vickers Sons and Maxim Ltd. was formed on 20 July 1888. In this company Hiram Maxim remained an active participator until his seventy-first birthday. The Vickers-Maxim rifle caliber gun is only a refinement of the original Maxim invented in 1884. Its point of difference from the first gun lies in the toggle-joint action, which is inverted, and the weight, which is reduced approximately one-third. This was accomplished by the substitution of superior steel and aluminum in lieu of heavier metals. The 1904 model was reduced to 40.5 pounds, whereas the previous weapon had weighed 60 pounds. Though Maxim had been associated with Messrs. Vickers and

Sons of London for 16 years, it was the first gun to bear the name "Vickers" along with "Maxim."

The South African War between the British and the Boer Armies was the first war in which regular armies composed of white troops both used Maxim guns. The Russo-Japanese war in Manchuria in 1904-5 is also of special significance—it being the first major war between regular armies in which automatic machine guns were employed in large numbers on each side, and with full fire effect. The Russians, converted to a belief in machine guns by the Gorloff (Gatling), used Maxim caliber .312 manufactured by Vickers Sons and Maxim. The Japanese began the war without automatic weapons except for a few in the cavalry. In November 1904, they is-

sued to the infantry large numbers of another type of automatic machine gun having a caliber .253 of French design, but manufactured at Tokyo.

The Russian Maxims were recoil operated and water cooled, while the Japanese weapons were gas operated and air cooled. The Russians and Japanese organized their machine guns alike in batteries of six or eight and treated them as a special arm. The Maxims were mounted first on artillery carriages with high wheels. Due to the exceptionally heavy losses sustained by the Russian batteries at the Yalu River, a low tripod with a shield was substituted.

Field reports spoke in glowing terms of the Maxim guns, saying that in some cases even bet-

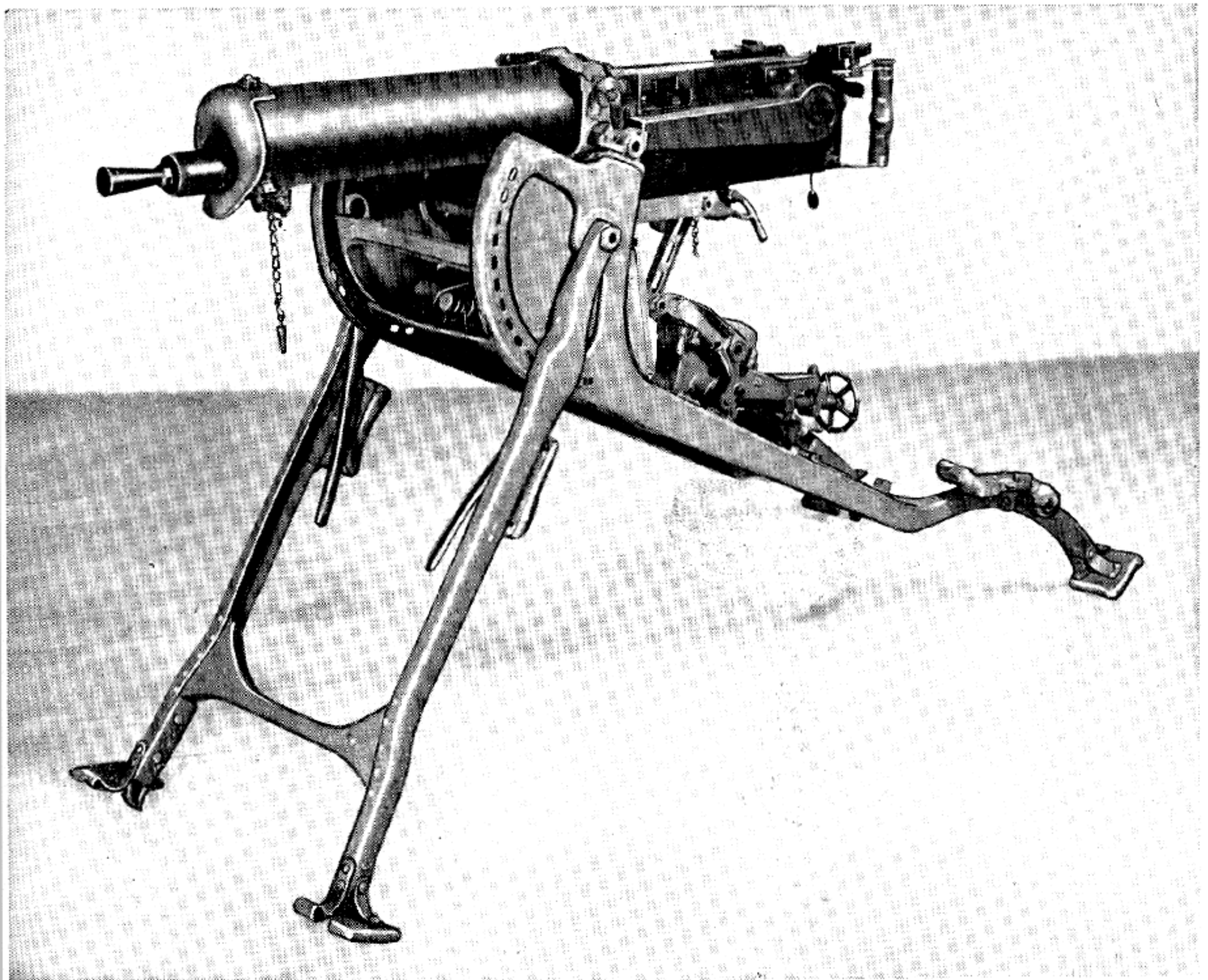

German Maxim Model 1908 with Sled Mount.

ter results were obtained with them than with artillery. One of the best examples of Russian employment of this type of weapon was during the battle of Mukden when 16 Maxims, half of them used at a time, repelled seven fierce Japanese attacks. The eight guns, not firing, were serviced and held in reserve. The guns fired altogether 200,000 rounds of ammunition that day, and every gun remained in excellent condition.

A German observer with the Russian Army sent the following report, which was reprinted in the official Journal of the German Army and Navy. "On January 28, 1905, near Lin-Chin-Pu the Japanese attacked a Russian redoubt that was armed with two Maxim guns. The Japanese company about 200 strong was thrown forward in skirmishing order. The Russians held their fire until the range was only 300 yards. The two machine guns were then brought into action. In less than 2 minutes they fired about 1,000 rounds and the Japanese detachment was literally swept away."

During the Russo-Japanese War military observers for the first time began to look upon the machine gun not as a piece of inferior artillery, but as a superior military rifle.

In the Philippine insurrection, the American Army had not yet adopted an automatic gun. It is interesting to note that Maxim full automatic machine guns caliber .303, manufactured

in 1895, were captured from the natives by our forces.

One of the first countries to capitalize on the potential lethal effect of the automatic machine gun was Germany, which adopted the Maxim gun in the year 1899, and issued it experimentally for some years to various units of the German Army.

After observation by German officers of the deadly employment of these weapons in the Russo-Japanese war, Germany determined to equip herself with large quantities. A heavy Maxim gun designated Model 1908 was developed at the Government armory at Spandau. With a metal sled-like mounting, it weighed around a hundred pounds. A later mount made at Erfurt reduced the total to 85 pounds. The weapon was chambered for the German service cartridge caliber 7.92-mm Mauser, supplied in 250-round belts.

Russia continued to be a big purchaser of the Maxim gun, but now employed an unusual mounting, called the Sokolov, which consisted of two small wheels supporting the traversing mount and a heavy steel shield setup in front of the action of the gun to protect the operator. The Russian gun was chambered for the 7.62-mm infantry rifle cartridges, and the model is listed the M-1910.

Though Englishmen armed the world with an American inventor's weapon, the British pacifist

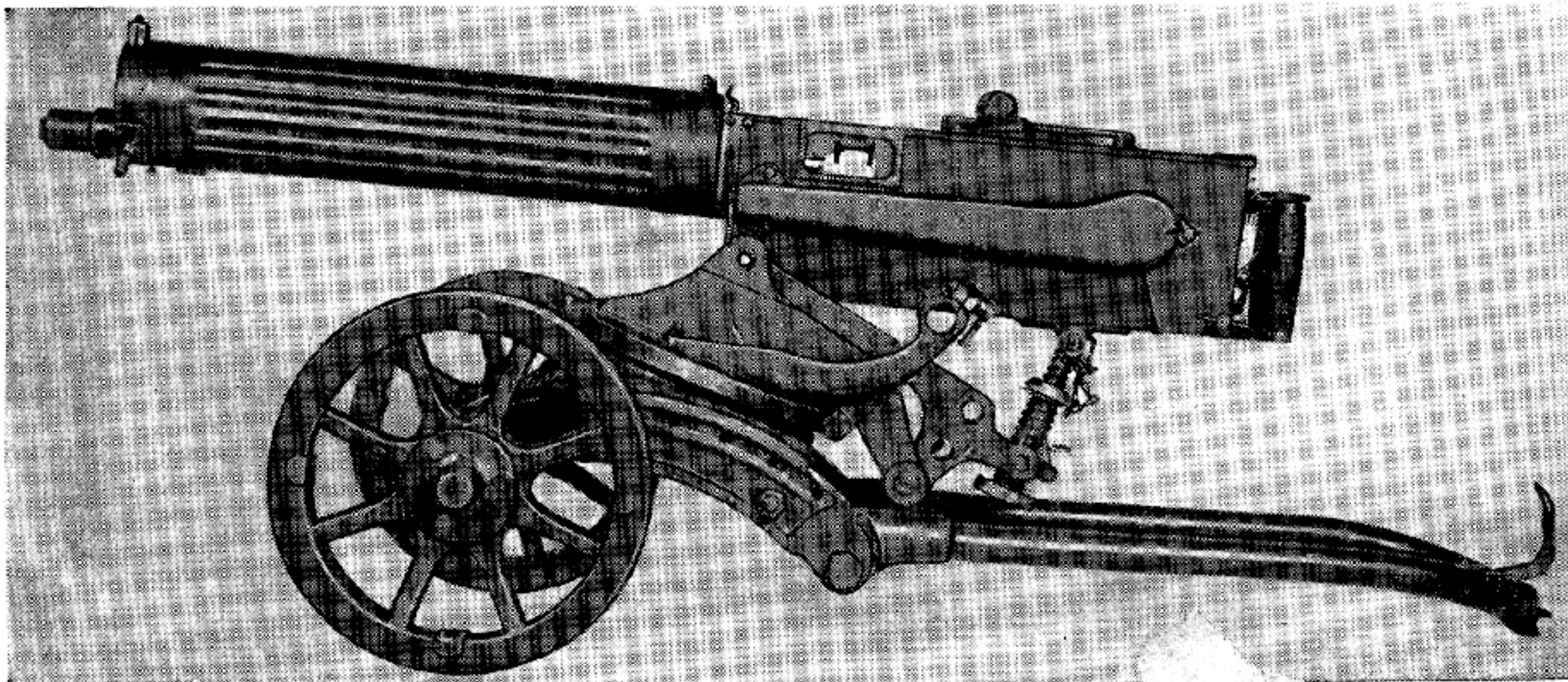

Russian Maxim Model 1910 on "Sokolov" Wheeled Carriage.

element saw to it that England profited less than any other European power. True, there was always an intense and intelligent interest in the machine gun by a minority group of the army. One or two pioneers even suggested the formation of a machine gun corps, but it was not carried out.

In 1908 the rule of Turkey in the Far East was seriously shaken. A reform group calling themselves "The Young Turks" deposed Abdul Hamid in favor of his brother. In the resulting confusion Bulgaria declared its independence, and the provinces of Bosnia and Herzegovina were annexed by Austria. The Balkan League was then formed by Greece, Serbia, Rumania, and Bulgaria. In 1912 the League waged war against Turkey and conquered all of its European possessions, except Constantinople. The principal infantry arm of practically every nation involved was the Maxim machine gun, chambered to fit each country's rifle caliber ammunition. A few employed the 37-mm pom-pom. And

a Greek report stated that Greece received as booty from the Balkan War a quantity of the 7.95-mm Maxim.

The first recorded trial of Maxim guns by the United States was in 1888. Although the gun performed well, nothing came of it. From the test Maxim admits he got the highest rate of fire ever obtained with black powder. The Navy continued Maxim trials up to the Spanish-American War. It decided against the rifle caliber in favor of an American-developed automatic machine gun, following its policy of favoring American products. But it did adopt the pom-pom, since nothing comparable was being produced in this country.

During the peaceful first decade of the twentieth century the American Government, especially the Navy, ran constant trials as new automatic weapons were introduced by their inventors. But there was no prospective need for automatic machine guns. Finally the United States realized she was unarmed compared with

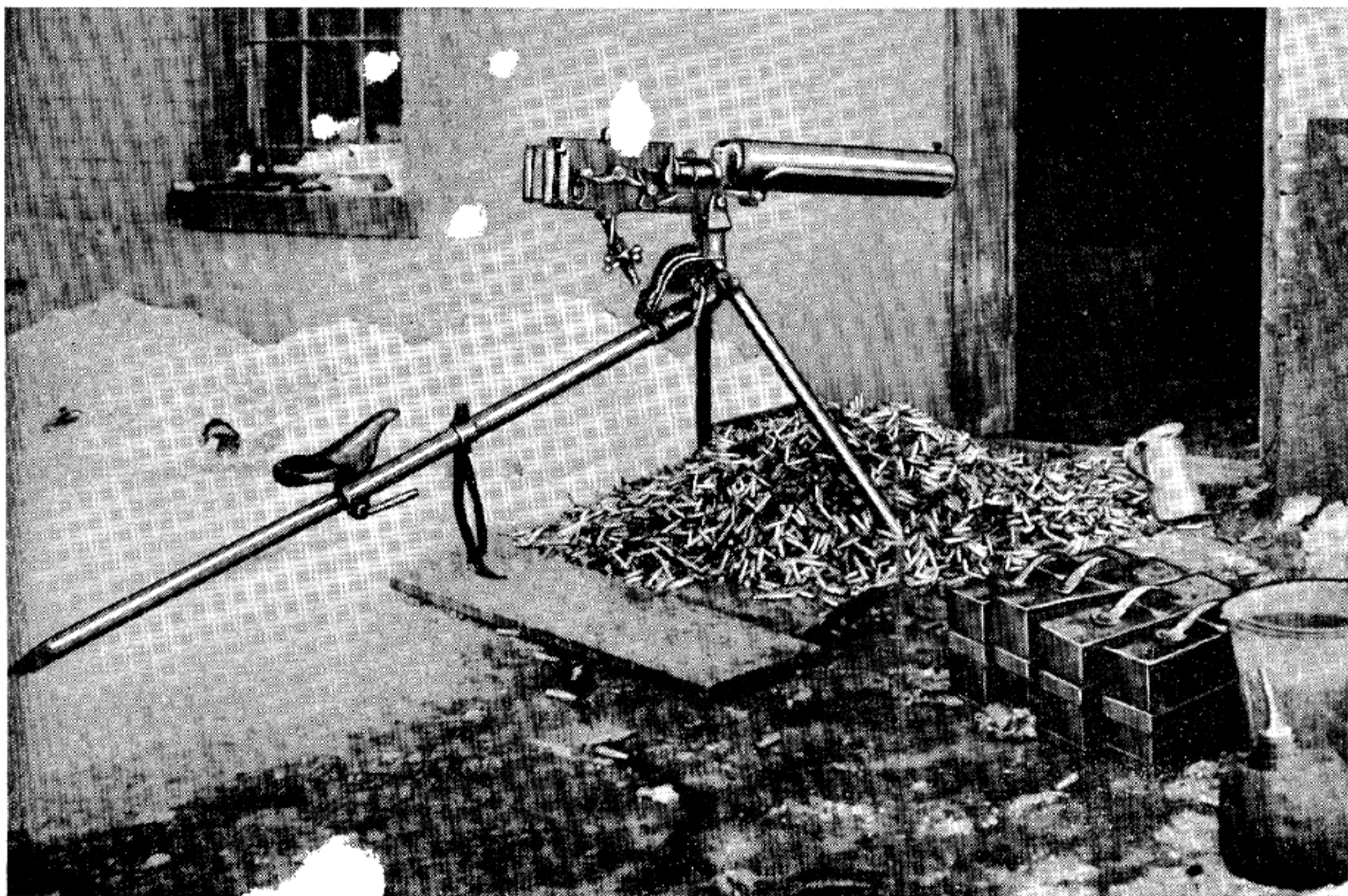

Automatic Gun After Firing 15,000 Rounds at an American Trial in 1899.

the rest of the world, and tests were frantically resumed.

In the 1913 competitive tests, the outstanding automatic machine gun was the Vickers, built by Colt's Patent Fire Arms Co. of Hartford, Conn. This was basically the 1904 Vickers-Maxim, which in turn had the same operating mechanism as the original Maxim model that was featured in the 1888 trials. However, when this weapon was adopted by the United States Army, it became known as the 1915 Model Vickers.

The United States Army Board unanimously declared that the Vickers tested on 15 September 1913 was superior to any of the other seven guns submitted. (The weapon showed it was still capable of the excellent performance this mechanism had demonstrated in the 1888 trial.) Not a single part was broken or replaced, nor was there a jam worthy of the name during the entire series of tests. A better performance could not be desired.

The Board also reported that, with the exception of the Vickers, none of the others submitted showed enough superior qualities to warrant consideration for adoption.

Another test of the Vickers in 1914 was summarized by the Machine Gun Board: "This gun fired 40,000 rounds in a satisfactory manner. While there were a number of malfunctions, they were mostly due to a failure to completely seat

the cartridge in the chamber, and the jam was removed by giving the side lever a sharp blow. Four main springs, one gib, and one muzzle gland were broken. The latter was caused by the loosening of the muzzle attachment, causing a bullet to strike the edge of the orifice. While the firing was sometimes irregular, the time of firing including time for cooling, cleaning, and repacking the barrel was 1 hour, 38 minutes, and 55 seconds consumed for the first 20,000 shots; and 1 hour, 6 minutes, and 9 seconds for the next 20,000 rounds."

The Board stated that the Colt-made Vickers gun was a very efficient weapon, and recommended immediate procurement of 4,600 guns. But nothing was done. Finally, 2 days after the United States declared war, General Crozier, Chief, Ordnance Department, authorized the purchase of 4,000 Vickers, since there was not a single machine gun in the country suitable for use on the European front.

The high command in the Army insisted that an American-developed gun was superior, and cited an early 1917 test as conclusive. Better or not, production on the new gun was almost a year away; consequently, the Vickers was the only gun to fall back on, since Colt was tooled up to make it. Cables from the A. E. F. indicated its efficiency and requested immediate continuance of production.

The first deliveries from Colt were in July 1917. By 12 September 1918, 12,125 Vickers Model 1915 had been made, but few saw action, since the war ended 2 months later.

The French high command, in the fall of 1917, urgently requested a thousand American-made Vickers for a special objective. They offered their machine guns in exchange. This request was granted. Subsequent production was used to equip mobile army troops until the American-developed gun could be available. When this new gun was finally issued, there was such a serious shortage of spare parts it had to be replaced by the Vickers gun.

Every major power in the world, at one time or another between 1900 and World War I, had adopted the Vickers-Maxim gun, either in rifle caliber, the pom-pom, or both. The German high command apparently were the first to realize



British Sergeant Instructing American Troops in France.

the deadliness of the weapon and made thorough preparations for the coming war, having more than 50,000 Maxim-type guns ordered or on hand at the outbreak of World War I. True to

the German military tradition, they sought to build tomorrow's weapons today. In contrast, it has always been our custom to build yesterday's weapons soon.

## SKODA MACHINE GUN

A very peculiarly designed weapon, popularly known as the Skoda automatic machine gun, made its appearance on the Continent shortly after the Maxim gun. Invented by Grand Duke Karl Salvator and Colonel von Dormus of Austria, it was patented in 1888. Patent rights were purchased and the gun produced by the famous Skoda Works of Pilsen, Austria-Hungary. This company was established in 1859 by the Count of Waldstein and came under the ownership of M. de Skoda in 1869. It was one of the outstanding armament manufacturing plants in Europe.

The odd-looking Skoda gun operated from retarded blow-back and was made in rifle calibers ranging from 6.5 to 11 millimeters. Austria-Hungary adopted it and gave it the designation Model

1893. It was, however, relegated to fortifications and naval use. There is no record that the army ever officially used it as a first-line machine gun. But an Austro-Hungarian naval detachment, equipped with the Skoda, was sent to the defense of the Legation at Peking during the Boxer rebellion in 1900. Its use in this engagement was very limited.

The military authorities of Austria-Hungary looked upon the weapon as suitable only for the defense of fixed positions and recommended that it be installed in turrets behind heavy armor.

A lengthy article in a military publication, *Review of Artillery*, volume 43, 1893, noted the reliability of the gun when it was subjected to a rugged proving ground test in Austria-Hungary.

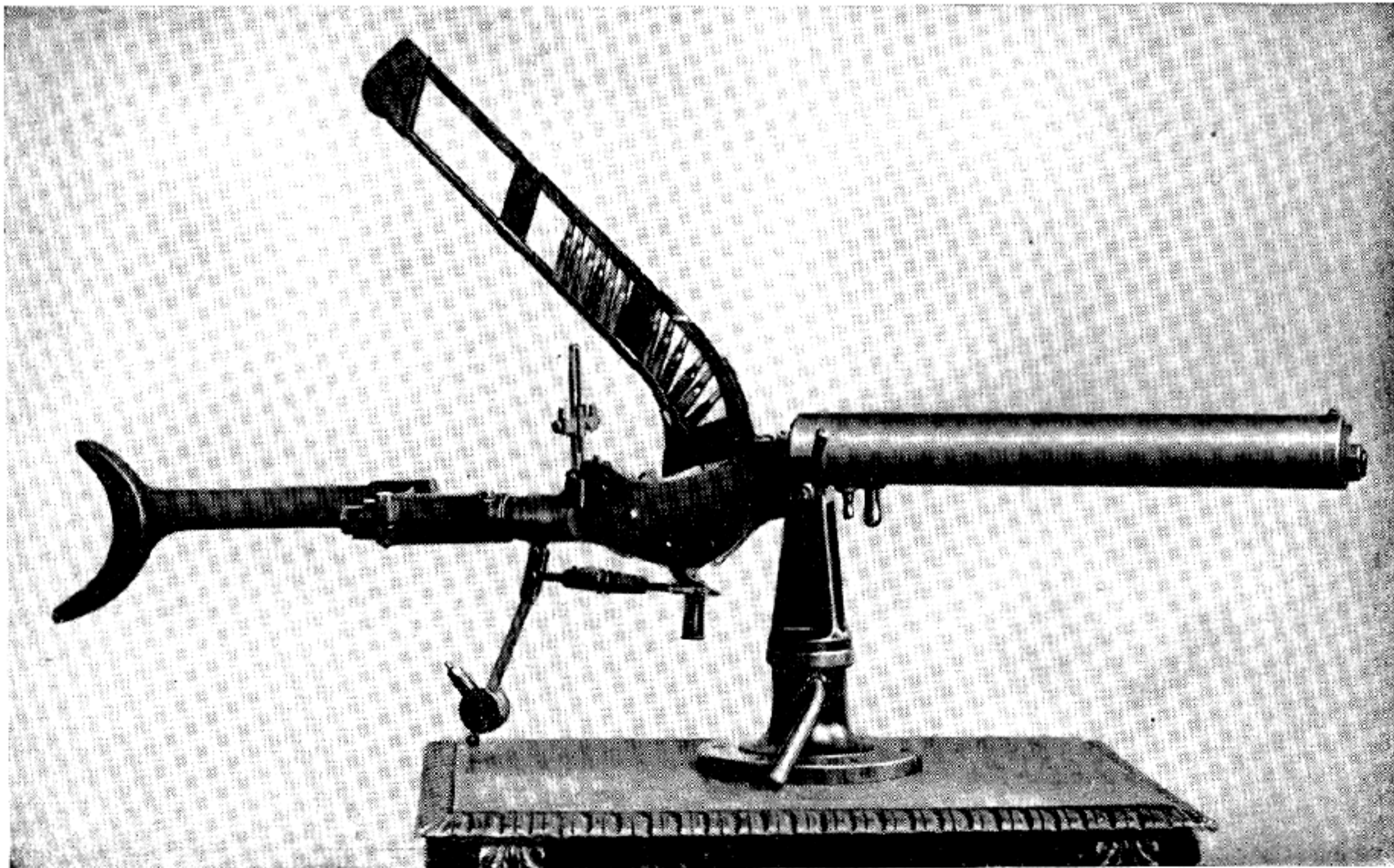

Skoda Machine Gun, Model 1893.

The weapon fired a considerable number of bursts of 3 minutes' duration and, on one occasion operated continuously for 9 minutes before a stoppage occurred to put it out of action. It also passed the dust and mud test and was fired successfully in temperatures ranging from 32° Fahrenheit to 20° below zero.

The gun was optionally provided with a water jacket and, when so used, the barrel life was found to be of unusual length. In fact, a single barrel was required to fire 20,000 rounds and still have a certain degree of accuracy in order to pass an official endurance trial.

The Skoda machine gun, Model 1893, was presented to the United States Army in 1895 for consideration and adoption. The following description and cycle of operation are derived from official Army records and give the conclusions drawn from the test by the Ordnance Board:

The weapon is a single-barreled arm, which operates automatically by a system known as retarded blow-back. Its 25-pound weight puts it in the lightweight gun classification. The rate of fire can be regulated at will. It uses an Austrian cartridge with a weight of 244 grains, and a smokeless powder charge of 42 grains.

The principal parts are the barrel, the receiver, the breech mechanism, and the driving spring.

The barrel, made of Bessemer medium carbon steel, is enveloped by a bronze sleeve, in which circulates a continuous current of cold water. This sleeve is pressed against the shoulder by a nut, screwed on the muzzle. Leather washers make the connection watertight. A screw locks the sleeves in proper position.

An inlet and an outlet are provided in this part, through which cold water can be led in by rubber tubes. The water is forced in by a small pump and finds its way from front to rear through a metal tube placed under the upper element of the sleeve to the outlet. In this way the barrel is constantly covered with cold water.

The pivoted breechblock, mounted between the parallel sides of the casing, is recessed to contain the firing mechanism and, when closed, is held in position by the block support. This pivoted support is continually under the pressure of the accumulator spring through a spindle and exercises a pressure on the block. When the

piece is fired, the shock of recoil, exerted against the face of the block at the instant the bullet leaves the bore, forces it to the rear. This in turn drives back the support against the spring, causing the forward end of the support to revolve downward. A quick screw thread is cut on the forward end of the spindle, which works through a closely fitted cylindrical nut. Its shoulder serves to relieve the spring of part of the energy of recoil. The friction of revolving also diminishes the speed with which the breech is opened and closed.

As soon as the energy of recoil is expended, during which time the empty cartridge case is ejected and a new cartridge supplied from the feed, both being accomplished automatically, the spring forces the support forward, closing the block and pushing the cartridge into the barrel. The rear end of the spindle screws into the nut joining the spindle to the sleeve. Attached to the latter is a crank. The rear of the spring cylinder is cut in the form of a helicoidal ramp, against which the crank rests. To load the first cartridge, the crank is turned to the left. Being forced to the rear by the ramp, it draws the spindle and the support with it, allowing the block to fall and open the breech.

The steel receiver is composed of two parallel frames, screwed on to the rear end of the barrel. On the left frame is fixed a distributor, in front and in rear of which are supports to receive the feed. The distributor consists of a swinging lever pivoted at a point flush with the mouth of the feed. On the outer side of the distributor is a spring, the lower end of which, shaped like a hook, projects through an opening into the receiver.

The feed is a sheet-iron frame, through which the cartridges pass to the distributor, their rims sliding in a groove. When the machine gun is mounted in a turret, the feed is made in two parts, the lower part fixed, and the upper part movable. The lower part rests in the support; the upper part is joined to the lower by a hinge and is held in place by a spring, a tenon of which catches in one of the four holes of the lower part. By this arrangement the movable part can be raised or lowered slightly to allow the necessary space for filling the feed under different angles of fire.



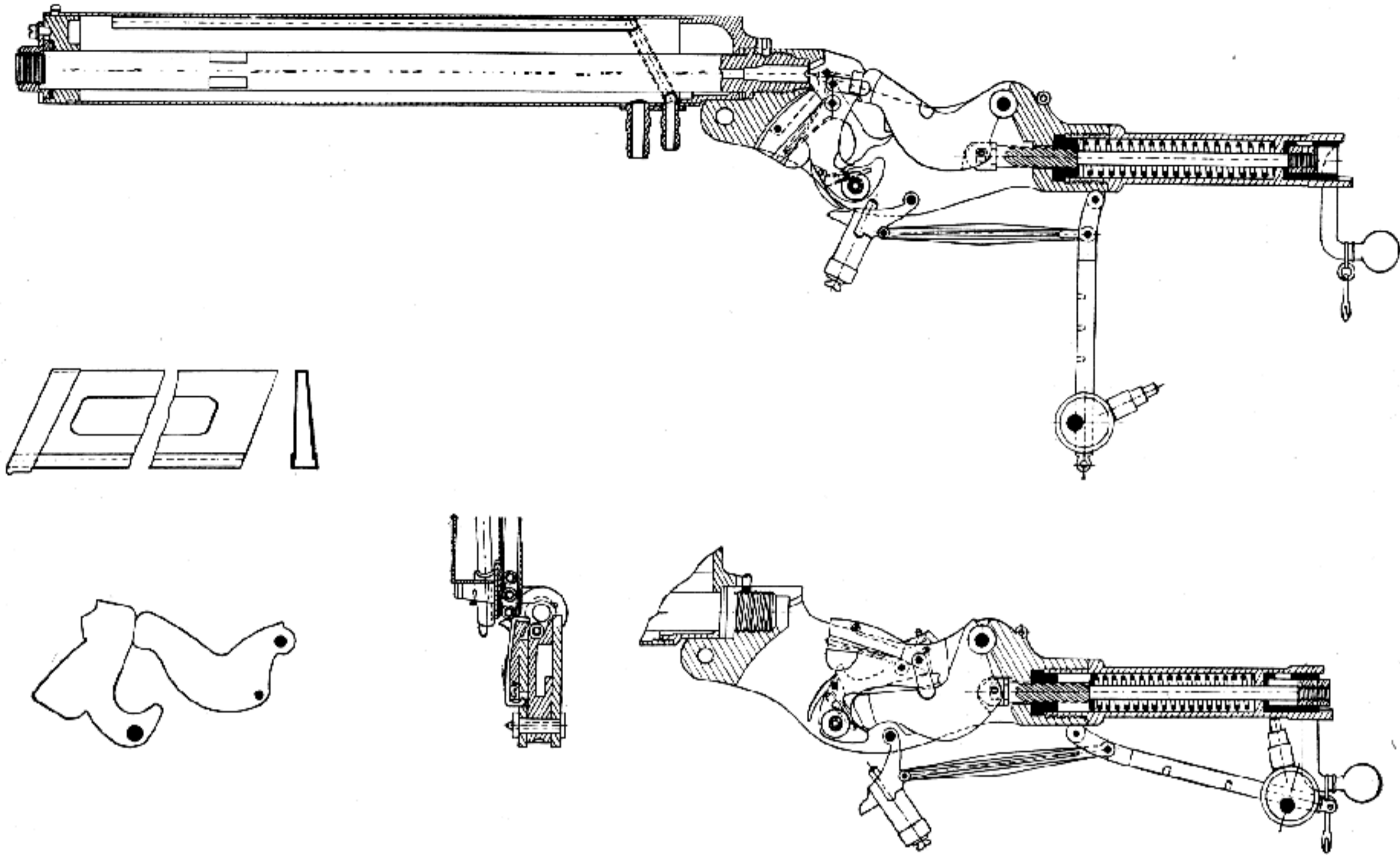

Section Drawing of Skoda Model 1893.

Under the receiver is hung the pendulum, a swinging arm, on which is the adjustable weight that regulates the rapidity of fire. In the weight is a mortise containing the rear stop plunger placed over a heavy spring. At the top is the pendulum stop buffer, also mounted over a spring. These springs are intended to increase the impulses which make the pendulum oscillate. The pendulum arm and the trigger gear are connected by a bar. This bar consists of two parts threaded on the adjoining ends and joined together by a nut. By turning the nut, the rate of fire can be varied at will.

On the receiver is a sight that can be raised or lowered and a deflection plate which throws to one side the empty cartridge cases as they are extracted from the breech.

The breech mechanism comprises the block and the support. The block is recessed to contain the firing pin, the hammer, the firing pin spring, the tumbler, and the tumbler spring. The lower part of the front of the block forms a loading shelf, the location of which assures the proper positioning of the cartridge. The upper

part of the front of the block carries the extractor. In the left face are two openings for the distributor, the forward and rear openings. At the rear of the block is the cylindrical bearing surface.

When the breech is closed, the bearing surfaces of the block and support should be in complete contact. The plane surface closes the rear opening of the barrel and the loading shelf is in front of and below this surface.

When the support revolves to the rear opening of the breech, its finger presses against the tail of the hammer until the nose of the tumbler falls into the notch of the hammer. The piece is thus cocked. While revolving, the support rests on the arm of the block, sending the latter to the rear. When the breech is thus completely open, the block, with the loading shelf above it, rests on the support.

To close the breech, the crank is turned in the opposite direction from that which opens the breech. The spring extends, revolving the support and the block and closing the breech.

In order to fire the weapon, the pendulum is

drawn to the rear until stopped by the bolt striking against the cylinder and then let go. The trigger sear then releases the tail of the tumbler, freeing the nose from the notch of the hammer. The striker spring throws the hammer against the firing pin and discharges the piece. If the breech is not completely closed, the tail of the hammer will strike against the support. The firing pin being thus protected, premature discharge cannot take place.

When the piece is discharged, the recoil throws the breechblock and the support to the rear, the breech opens, the hammer is cocked, the empty case is extracted, and the next cartridge is placed on the loading shelf. Then the driving spring starts closing the breech, shoving the cartridge on the shelf into the chamber, while the lowest cartridge in the feed falls on the distributor tray. The swing of the pendulum causes the trigger assembly to strike the tumbler and the piece is again discharged.

To fill the feed, a charger is placed over its upper end. It is reinforced at one end by the sabot, on the outside of which is a spring. The nose of this spring projects through an opening in the charger and supports the cartridges. At the upper part of the feed, there is also a sabot, with a lug directed toward the interior. When a charger is placed over the feed, this lug pushes outward the wedge-shaped nose and, consequently, the spring. As the cartridges are no longer supported, they drop one by one into the feed.

When the breech opens, the block pushes toward the outside the arm of the distributor spring; the latter throws the distributor in the opposite direction, and the cartridge is rapidly projected on the loading shelf. The tray of the distributor positions the cartridge and directs it into the chamber.

At the closing of the breech, the cartridge is pushed into the chamber by the front face of the breechblock. At the same time the block acts on the extraction arm of the distributor and pushes it to the outside. The next cartridge, which has been resting against the head of the distributor during the loading of its predecessor into the chamber, now falls on the distributor tray, ready to be inserted when the breech opens again.

The rapidity of fire can be regulated in two ways: First, by lengthening or shortening the connecting bar by turning the nut; second, by varying the position of the weight on the pendulum arm, thus changing the time of oscillation.

This gun was tested on 5 June 1894 in the presence and under the direction of the Ordnance Board. The firings were conducted and the gun manipulated by a representative of the company, who was present for the purpose. Owing to the limited amount of ammunition available, the firings were restricted to those necessary to determine the ease and certainty of action of the mechanism when set for different speeds; also for rapidity during comparatively long and short periods of time. Six hundred rounds in all were fired, as follows:

	Rounds
Single shots to test action of mechanism . . .	25
At the rate of 175 rounds per minute . . . .	25
At the rate of 300 rounds per minute . . . .	25
At the rate of 500 rounds per minute . . . .	25
In 1 minute 51½ seconds . . . . .	400
In 13 seconds . . . . .	100

The following conclusions are quoted from the Board's report:

"No tests could be made of the action of the mechanism when subjected to the dust or rust tests, defective cartridges, or excessive pressure. A positive opinion of the merits of the system under these circumstances cannot therefore be formed. It would seem, however, that the mechanism is somewhat delicate and would be liable to get out of order when subjected to the severe conditions of field service, although it was claimed by the representative of the gun that two of them had been tested with 40,000 shots each (with smokeless powder) in hot and cold weather and when covered with dust and rain, and that it has successfully withstood uninterrupted firing for nine minutes. For permanent fortifications or other positions where the gun could be cared for and kept in good condition, it might be a useful arm in repelling storming parties or other work of like nature. Its fitness for adoption in the service as compared with other arms of a similar character can be deter-

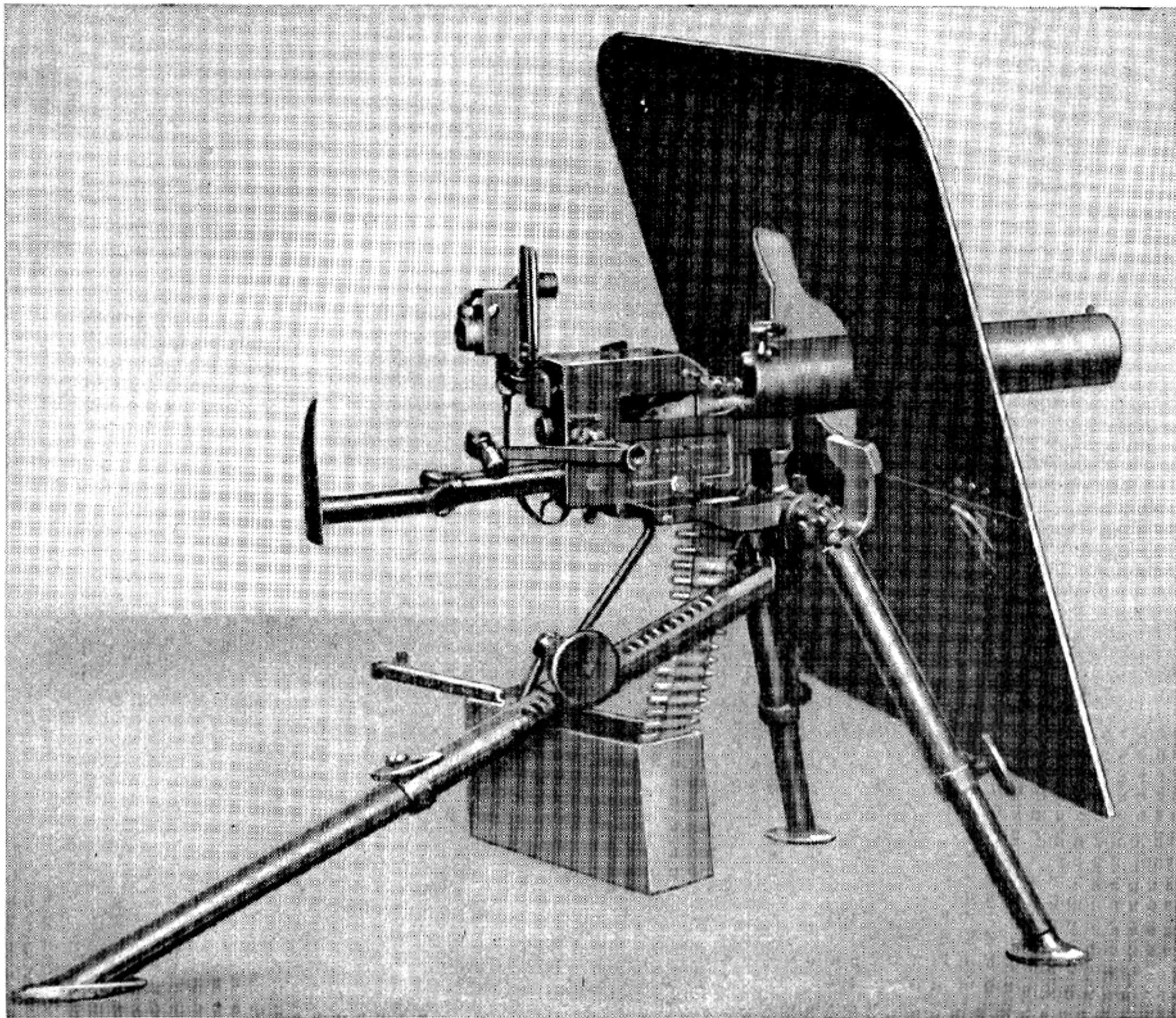

Skoda Machine Gun, Model 1909.

mined only by a much more exhaustive trial than was practicable during the test above referred to."

The Board consisted of the following officers: Frank H. Phipps, Major, Ordnance Department, U. S. A., president; Frank Heath, Captain, Ordnance Department, U. S. A.; and William Crozier, Captain, Ordnance Department, U. S. A.

The Skoda was later completely redesigned and appeared as the Model 1909. The engineers responsible for this modification deserve great credit, as they incorporated many features that were obviously improvements. The bulky ill-designed hopper-type feeder was done away with

and the feed system was altered to use the conventional fabric belt employed by most machine guns of the era.

The swinging pendulum rate-of-fire regulator was replaced by a compact buffer arrangement and a simple cyclic rate control that not only did not interfere with the gunner's aim during firing but allowed the arm to be streamlined.

In the complete working over of this weapon, the designers made great efforts to lessen weight and succeeded to the extent that the finished product was one of the lightest full-automatic belt-fed machine guns of its day. Had this very much improved model with its many true re-

finements made its appearance in place of the crude 1893 Skoda, it would have furnished serious competition to the other automatic machine guns of that time.

There is no record of this later weapon getting beyond a few insignificant trials and its only contribution to machine gun study is as a rare museum piece.

## BROWNING AUTOMATIC MACHINE GUNS

## John M. Browning's Early Years

The next outstanding step in automatic weapon design was made by a young western gunsmith, John Moses Browning. It would be impossible to produce a greater contrast in men than that existing between the two great masters of automatic weapons, Maxim and Browning. Hiram Maxim, a brilliant opportunist, needed only the incentive of promised wealth to turn from electricity at the age of 44; and, on his first attempt at producing an automatic machine gun, he succeeded where countless hundreds before him had failed. John M. Browning, on the other hand, was destined by inheritance to be a gunmaker.

His father, Jonathan Browning, an outstanding riflemith, produced weapons that were as advanced as was possible considering the ammunition of the day, which consisted of loose powder, ball and percussion cap. Born in Sumner County, Tenn., in October 1805, he went to Nashville for his apprenticeship in gunsmithing. When he was about 21 years old, he moved to Davidson County, Tenn., where he set up his own gunsmithing business. He subsequently moved in 1834 to Adams County, Ill., where he invested largely in land and carried on agricultural pursuits in connection with his gun and blacksmith trade. From 1842 to 1846 he conducted his business in Nauvoo, Ill., followed by a move to Kaneshville now known as Council Bluffs, Iowa.

Here he engaged in manufacturing guns, wagons, and other equipment. He also continued his farming and discharged the duties of magistrate, an office he had held in his other places of residence. The merits of his various repeating guns are described in the following advertisement in the Kaneshville *Frontier Guardian* of 19 September 1849:

## "Gunsmithing"

"The subscriber is prepared to manufacture, to order, improved Fire-arms, viz: revolving rifles and pistols; also slide guns, from 5 to 25 shooters. All on an improved plan, and he thinks not equalled this far east. (Farther west they might be.) The emigrating and sporting community are invited to call and examine Browning's improved fire-arms before purchasing elsewhere. Shop eight miles south of Kaneshville on Musquito Creek, half a mile south of Trading Point.

## "JONATHAN BROWNING."

During his stay in Kaneshville, Jonathan Browning produced two different styles of repeating rifles. One was a slide-action weapon that had a rather ingenious arrangement whereby the five-shot magazine alined each chamber concentric with the bore. The magazine was a rectangular piece of bar iron, chambered to accommodate powder and ball. The magazine, or bar, slid through an opening in the breech from left to right, being manipulated by finger pressure on a small lever on the side. At the same time it jacked the action forward, forming a gastight seal between chamber and barrel. This weapon was hailed as a great achievement by the gun trade, as it allowed the user not only to have several quick shots ready in the gun, but also to carry a number of loaded magazines.

Success encouraged Jonathan to make another repeater of different design. This time the breech mechanism housed a cylinder having six chambers operating somewhat on the order of the single-action revolver. Neither of these weapons, which added to the fame of Jonathan Browning throughout the frontier, was ever patented. It is indeed probable that he did not even consider the idea.

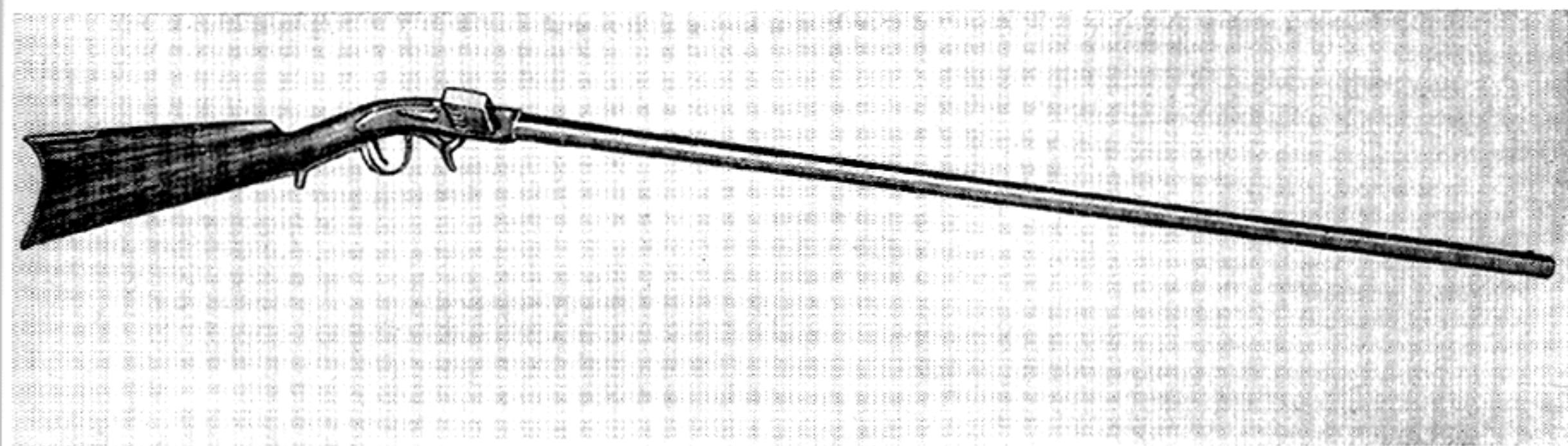

Original Repeating Rifle Developed by Jonathan Browning.

After accumulating a small amount of money, he deemed it appropriate to move further west, and was selected to captain a wagon train, being regarded by his neighbors to be as resourceful and reliable as the weapons he made. Despite the ever-present danger that existed in such an undertaking, he led his wagon train safely through the territory of Utah to the Mormon settlement of Ogden, and opened a gun shop there in 1852.

Money was scarce, and, though there was no end to the demand for superior weapons, profits had to be kept at a minimum in order to sell. Jonathan's gun shop was small. And, as was the custom of that day, his home was but a modest addition to his workshop.

It was in these surroundings that John Moses Browning was born in 1855. He soon showed his heritage from Jonathan Browning. Before he was 20 years old, he was supplying the family table with wild chicken killed by a gun of his own construction. He also made an improved rifle for his brother, Matthew, which his proud father admitted was the best gun he had ever seen and far surpassed anything he had made in all his years as a riflesmith.

John Moses was given an interest in the business and worked daily at the foot-power lathe that the elder Browning had brought with him by oxcart from Council Bluffs. He served as an apprentice for 10 years before he applied for his first patent. It was on a single-shot rifle, operated by a trigger guard lever that opened the breech, ejected the empty cartridge case, and cocked the piece; when locked for firing, the hammer was out of the line of sight. The patented mechanism was promptly bought by the Winchester Arms Co. of Hartford, Conn., and

made in numerous calibers. Thus began an association between Browning and Winchester that lasted for many years. His reputation established, he only worked harder to improve and originate other types of weapons that he felt



John Moses Browning when 18 Years Old.

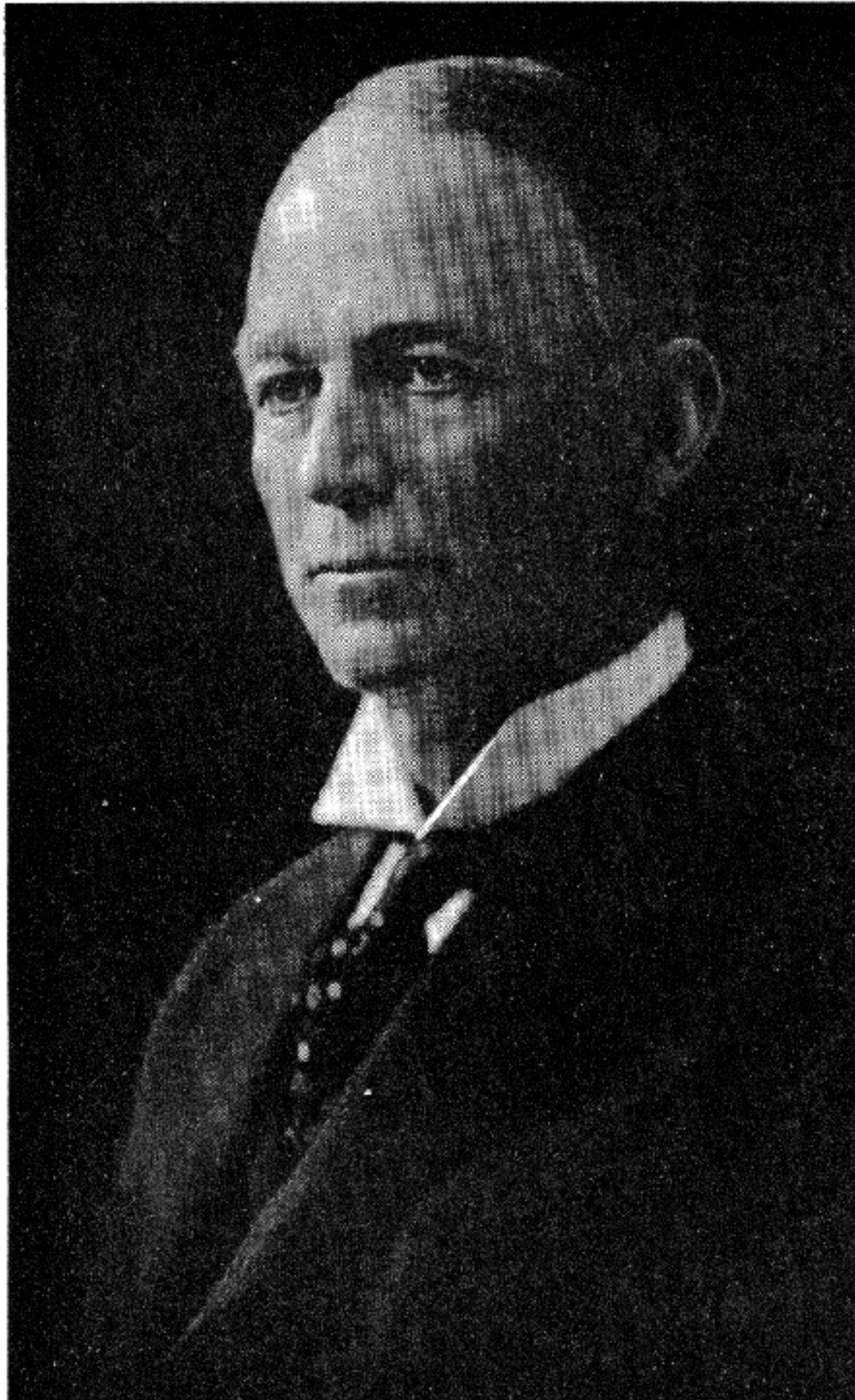

Matthew Sandefur Browning.

would meet the demands of the critical public.

The successful partnership between John Moses and Matthew Sandefur Browning resulted from the death of their father and the added responsibility of providing for the family—as well as from their inherited love for fine guns and pride in their ability to produce them. These basic demands and the unlimited resourcefulness which characterized the lives of the two young men were the deciding factors that lifted the J. M. & M. S. Browning Co. of Ogden, Utah, from obscurity to world fame.

Each believed a man does best that for which he has the most natural aptitude, and wisely decided at the very first to separate their business duties. In complete agreement, they decided that John M. should devote his entire time to the

origination of new weapons and the improvement of previous designs, since he had already shown his ability along this line. On the other hand, Matthew, having exhibited unusual talent in marketing products and in handling patents, contracts and investments, would devote his attention to business and financial problems. It was the latter's shrewd foresight that made them stop catering to individual demands for custom-made weapons. Instead they would decide on a promising design and proceed to have made in the little shop as many as 600 identical guns before a single one was put on the market.

Matthew found that, by this standardization and an assembly-line method of production, not only could he manufacture more economically, but also he was in a position to bargain with larger gun companies by virtue of his potentialities as a serious competitor.

One of the earliest successes of the J. M. & M. S. Browning Co. was the sale, at a good profit, of the complete output of 600 rifles of a popular design to the Winchester Arms Co. The wholesale part of the business became so lucrative that they were able to employ a well-known gunsmith as well as their half brothers, Samuel, George, and Ed Browning, at the tedious task of handmaking and assembling the rifles.

Manufacturing activities expanded and the brothers were forced to buy a two-story building for their business. The lower floor was outfitted as a sporting goods store, in which they displayed for sale not only their own, but also all the popular brands of firearms. The upper floor was converted into a workshop and a pattern room, where John M. made mock-ups of guns that time would prove to be the world's best.

At the age of 26, the designer conceived the idea of a lever-action repeating rifle. The patent was granted in 1884, assigned to Winchester on a royalty basis, and in a comparatively few years the weapon literally monopolized the market. It became known as the '86 model Winchester.

A business competitor of Winchester, shortly after the deal, said to Mr. Browning, "I don't know what you received for the repeater you sold Winchester, but I would have given half my factory for it."

The design was so basically sound that thousands of the weapons are in existence today, and

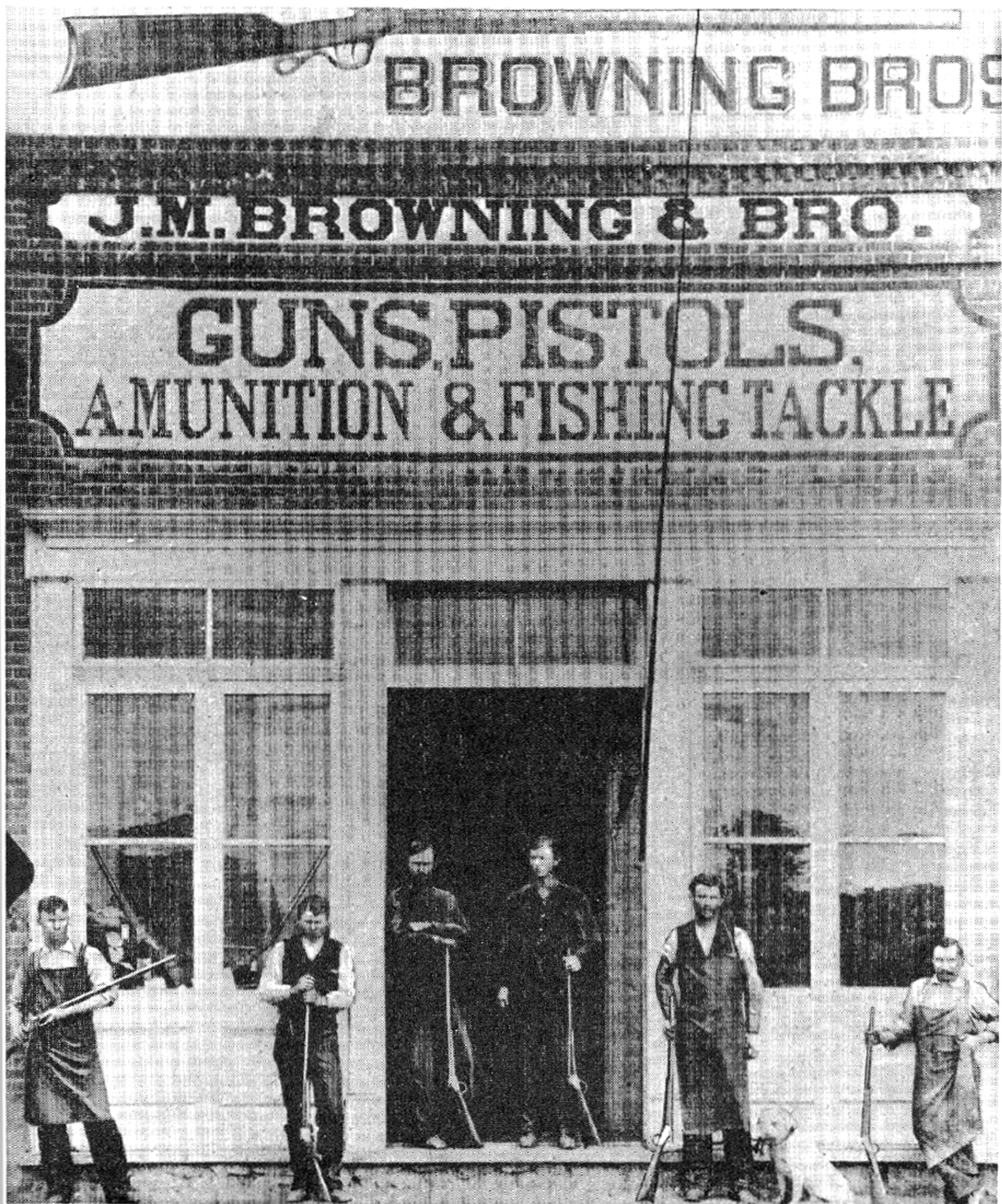

The First Shop and Arms Factory. John and Matt Browning are Shown in the Doorway. Left to Right Are Sam, George, John, Matt, and Ed Browning, and Another Gunsmith.





John M. Browning at the Height of his Career.

it is said that practically every improvement in repeaters since that time has been influenced by this mechanism. The cartridges were carried in a tubular magazine under the barrel. Fore and aft movement of the lever controlled the entire operation of opening the breech, cocking the gun, ejecting the empty cartridge, picking up and inserting the incoming round into the chamber, closing the breech, and securely locking it. All this was done in less than a second's time. The trigger finger could remain in position for firing while this was being accomplished.

The mechanism of this gun was an improvement over that of any other rifle of this period. It was especially effective since the joint between breech and barrel was perfectly sealed. When closed, the sliding part of the locks fitted into place so accurately that the breech had the appearance of one solid piece. The ease and simplicity of locking and the economy of manufacture, coupled with the ruggedness and reliability of the weapon as a whole, made all other rifles

obsolete. A carbine version accompanied Admiral Perry to the North Pole, and Theodore Roosevelt chose a custom-built caliber .405 model for his African hunting expedition.

The Winchester Co. became so convinced of Browning's skill and gun talent that it asked him if he could design for it a caliber .22 (short) repeating rifle. Browning sent drawings of a proposed model. To his utter surprise, he soon received a letter telling him to discontinue his efforts, as the weapon he had submitted could not possibly work. Browning made a working model of the gun, according to the submitted plans. Upon completion, he took it personally to the factory to show to the officials who had said it would not fire and stated, "You said it would not work, but it seems to shoot pretty well for me."

Not only did he design for Winchester, but also for Remington, Stevens, Colt, and other arms companies. His rifles, shotguns, and pistols have been used so long under other factory names that it is often forgotten that they were the inventions of this gun genius.

### The Colt Model '95 Machine Gun

In 1889 John M. Browning made a discovery which, in due time, affected all the military world. Like most great events its place of origin was unimpressive. He was function firing one of his latest rifles in the salt marshes near Ogden, Utah, when he noticed something countless other men had seen before, but had not thought worth remembering. Every time Browning fired, the bulrushes parted from the blast for quite a distance from the muzzle. To others this phenomenon meant nothing. But to Browning's mechanical mind it revealed a wasted, perfectly timed power source which could be utilized to operate the weapon's mechanism and produce sustained fire. Just as Maxim had observed the possibilities of the kick of a gun for harnessing the recoil, Browning likewise realized the potentialities of the muzzle blast—which at the time did no more than make a loud report. The keen observations of a man firing a high-powered rifle in tall rushes resulted in the experiments producing the first successful gas-operated automatic machine gun.

In order to ascertain the amount of power gen-

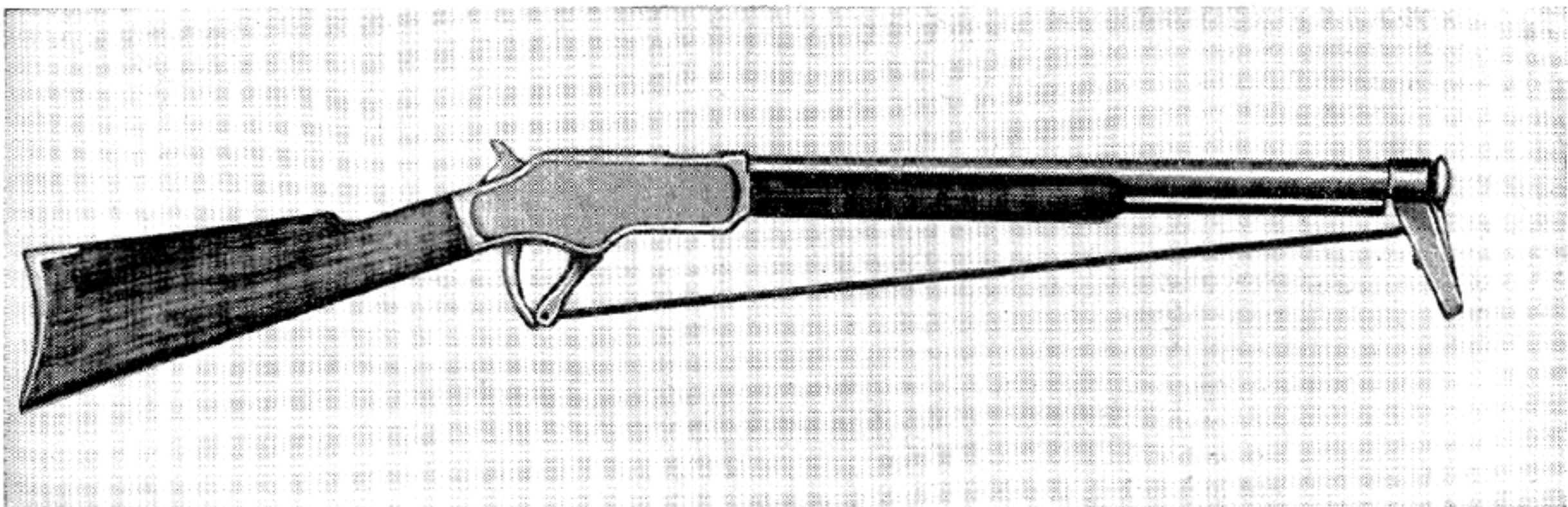

Browning's First Experimental Model of a Gas-Operated Automatic Firearm.

erated by the muzzle blast, Browning made a device in his shop to fasten to the identical rifle he had fired in the marsh. One inch in front of the muzzle he put a 4-inch square piece of iron weighing approximately 5 pounds. The iron block had a hole drilled in the center, which he adjusted until it was in alignment with the bore. By means of a long lanyard, he pulled the trigger. As anticipated, after the bullet had passed through the hole, the subsequent blast blew the iron block the full distance of the room.

He next made a concave cap of steel with a hole in the center to fasten over the muzzle of the rifle, and connected it by a hinged arrangement to the spring-loaded operating lever. When the bullet passed through the opening, the blast blew the cap down, pulling the loading lever forward. The spring returned the lever rearward to the locked position, and another pull of the trigger repeated the cycle.

This experiment was followed almost imme-

diately by still another rifle modification. This time the rifle was magazine fed and rigged to fire full automatic. The barrel was tapped near the muzzle, and a gas piston was actuated while the bullet was just clearing the bore. At the completion of the cycle of extraction, ejection, loading, locking, and cocking, a built-in device seared off the piece. The action was continuous as long as the trigger remained depressed.

Such was the modest introduction of the world's first successful automatic gas-operated weapon. This unusual gun has been credited with firing 16 shots a second, using caliber .44-40 black powder cartridges.

Much more experimentation and hard work produced the basic design for the first automatic gas-operated machine gun to be developed by Browning. It was offered for production to the Colt's Patent Fire Arms Co. in a letter in Matthew S. Browning's own handwriting dated 22 November 1890.

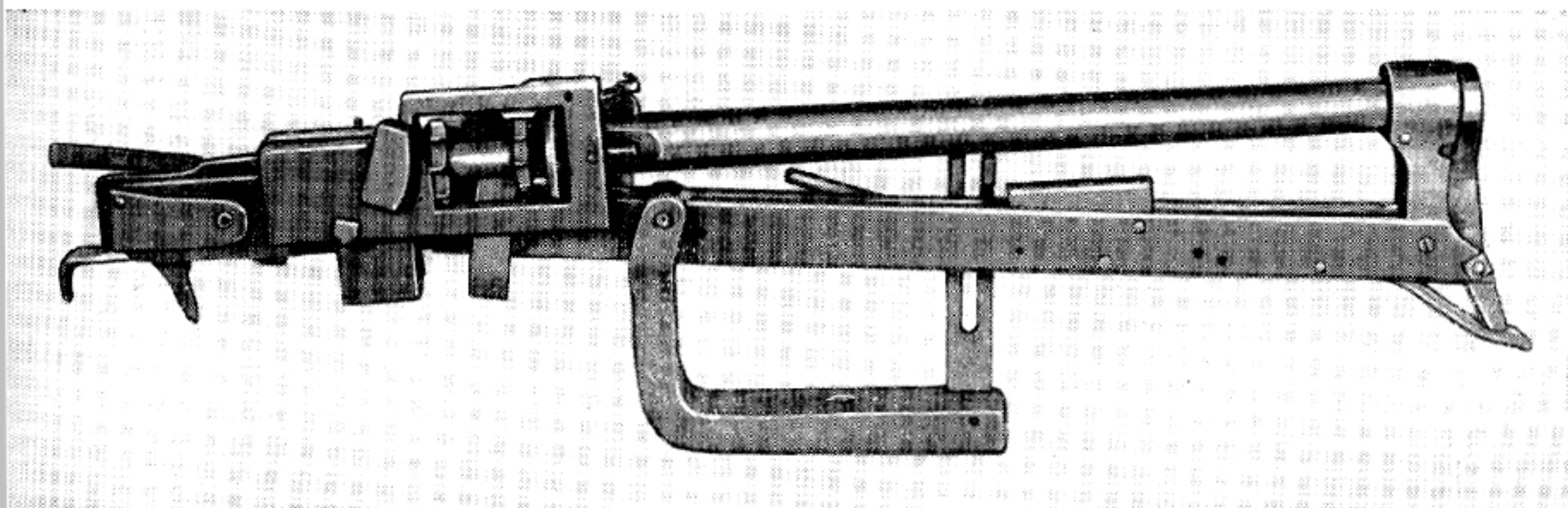

Browning's First Gas-Operated Machine Gun.

2461 Washington Ave., Ogden

155 Main Street, Salt Lake City.

JOHN M. BROWNING,  
MATT S. BROWNINGOgden Utah 22<sup>nd</sup> Nov. '90

Colt Pat. F. A. Mfg. Co.

Hartford Conn

Dear Sirs:

We have just completed our new Automatic Machine gun I thought we would write to you to see if you are interested in that kind of a gun. We have been at work on this gun for some time I have got it in good shape. We made a small one first which shot a .44 W.C.F. C&G at the rate of about 16 times per second & weighed about 8#. The one we have just completed shoots the 45 Gov't C&G about 6 times per second & with the mount weighs about 40#. It is entirely automatic & can be made as cheaply as a common sporting rifle. If you are interested in this kind of guns we would be pleased to show you what it is & how it works as we are intending to take it down your way before long. Kindly let us hear from you in relation to it at once.

Sincerely,  
Browning Bros

"Dear Sirs:

"We have just completed our new automatic machine gun & thought we would write to you to see if you are interested in that kind of a gun. We have been at work on this gun for some time & have got it in good shape. We made a small one first which shot a 44 W. C. F. chge at the rate of about 16 times per second & weight about 8 #. The one we have just completed shoots the 45 Gov't chge about 6 times per second & with the mount weighs about 40 #. It is entirely automatic & can be made as cheaply as a common sporting rifle. If you are interested in this kind of gun we would be pleased to show you what it is & how it works as we are intending to take it down your way before long. Kindly let us hear from you in relation to it at once.

"Yours Very Truly,

"Browning Bros."

The gun was tested by the United States Navy as early as 1893. By 1895 it had been perfected to a point where it would successfully handle both the caliber .30-40 Krag (Army) and the 6-mm Lee (Navy) smokeless powder, rifle cartridges. Known officially as the Colt '95 model machine gun, it was promptly nicknamed by the service the "potato digger," on account of the unusual movement of the gas-actuating arm that swung in a half arc beneath the muzzle.

The following report was made by the Inspector of Ordnance to the Secretary of the Navy in 1896. It shows that the trend of the Navy was to get away from the manually operated machine gun and secure as soon as possible a reliable weapon capable of firing sustained bursts full automatic, at a minimum of 400 rounds actually fired during 1 minute of operation.

"The year has been an eventful one in machine-gun matters, and though at this date a final decision has not been reached as to which one of several competing guns is the most desirable for adoption as the standard naval gun, much has been done toward that end, and it seems probable that a few weeks at most will see the question settled.

"In the last annual report from this office three machine guns were named as being in course of development in this district for submittal to the naval board on machine guns;

shortly afterwards, and before the August session of the board, the Pratt & Whitney Company suspended work on their gun, a two-barreled, crank-operated gun, on the Gardner system, having become convinced after long experiments that no crank gun could be made to handle successfully and safely the modern smokeless powder ammunition, owing to the danger from hang-fires. Repeated instances occurred of cartridges exploding after being entirely drawn from the gun, in rapid fire, and in one case a cartridge was discharged when partially out of the chamber, damaging the mechanism.

"The Gatling Gun Company, still having faith in the crank principle, and having met with gratifying success in handling .30-caliber ammunition, completed a gun of 6-millimeter caliber and submitted it in competitive trial to the Navy board.

"The Colt automatic gun was also completed and was tested by the board. Other guns submitted were the Accles Improved Gatling, the Maxim automatic, [and an automatic weapon produced by a French arms company].

"The board held several sessions, at which all these guns were tested, and in January, 1896, all tests having been completed, a report was submitted. Shortly after, 50 guns of the Colt automatic type were ordered from the Colt's Patent Fire Arms Manufacturing Company, and the Maxim and French companies informed that a second opportunity would be given them to exhibit their guns to the board before the remainder of the guns required were ordered.

"The Colt Company accepted the order for 50 guns, guaranteeing perfect operation with rimless cases (all competitive tests were with flanged cartridges) and a minimum uninterrupted speed of 400 shots per minute for one minute. Work was at once begun, and a model gun made, which has been tested and found to work in an eminently satisfactory manner, justifying the Bureau's conclusion that a successful automatic gun could be produced.

"Three guns have been completed, assembled, and provisionally tested. Lack of suitable ammunition has made it impossible up to this time to give any of these guns the exhaustive tests contemplated by the Bureau, or even to prove them for acceptance. It is hoped at an early date to

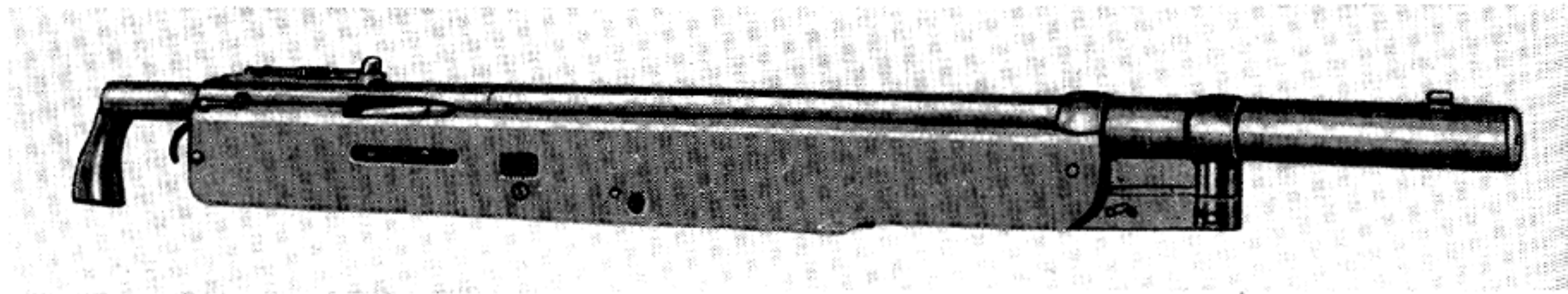

Colt Machine Gun, Model 1895.

receive a large shipment of Troisdorf powder, when sufficient ammunition can be furnished to complete the tests of the three finished guns. Thereafter the remainder of the order will be rapidly pushed to completion, a large percentage of the parts being already in hand.

"The Colt gun is exceedingly simple in construction, and has not more than one hundred separate parts, a surprisingly small number, considering the type. It has been designed with great care and with due attention to the often conflicting requirements of lightness and strength, so that with a maximum weight of 40 pounds no part, with the single exception of the extractor, has been broken in the course of a number of very severe tests.

"The rifling adopted is the same as that decided upon for the barrels of the new small arms. It is of pure Medford form, consisting of six grooves of a uniform depth of 0.004 inch, and having a twist of one turn in 7.5 inches. The life of this rifling has not yet been determined, but it is evidently considerably longer than that of the experimental rifling previously used, in which the groove was of slightly different form and of more rapid twist.

"A flat-leaf front sight has been adopted, which is grooved on each side, leaving a bead at the top, upon which the eye is quickly fixed without effort. The rear sight is a plain folding-bar sight with spring slide. It is marked for all ranges from 300 to 2,000 yards. In the course of the experiments for marking the sight several hundred shots were fired, with most gratifying results as to accuracy. The idea held in some quarters that the motion of the pendulum would seriously affect the accuracy of the gun has not been borne out by experience. The vertical jump-angle of the gun and service mount is only about 4' of arc, and is practically constant in all ranges and at all rates of fire. On one occasion, in an ammu-

nition test, 140 shots were fired rapidly at a 300-yard target; 2 sighting shots not considered, all the rest fell in a circle of 12-inch radius, the greatest lateral dispersion being about 7 inches. The gun was unclamped and in hand during this firing.

"The slight recoil of the automatic gun and the absence of strain on the mount are evidenced by the facts that it can be fired from the shoulder without inconvenience, that when placed in the saddle without a retaining pin and fired for several seconds the displacement is so small that the pin can usually be readily entered without moving the gun, and that when secured in the saddle, the tripod placed on a smooth platform, and the gun fired, there is only a slight rearward movement of the tripod after considerable firing.

"A tripod mount has been designed for use on shore, the pivot of the saddle being of such a diameter as to fit the adapters hitherto used for mounting Gatling guns in 1-pounder cage stands. The shore mount will weigh about 52 pounds. Two men will be able to transport gun and mount without inconvenience.

"With each gun and mount there will be furnished ten belts, each holding 250 cartridges, and a small box of accessories and spare parts. The accessory box and the jointed wiping rod will be secured to the tripod, and will thus always be at hand when required.

"In case the Bureau should, in the future, order additional guns of this type, a few minor improvements might be made. As at present constructed, the interior of the receiver is difficult of access, some other automatic guns being superior to it in this respect. It would not be a difficult matter to so alter the design that free access could be had into the mechanism without detracting anything from the strength of the frame. There are a number of screws used in the gun, which, though not particularly objectionable, as

their removal is not often necessary, might be replaced by pins with locking devices. All pins could be brought to one or two standard sizes without affecting weight or strength materially.

"In addition to the 6-millimeter gun, the Colt Company has also perfected guns of the same type of other calibers for handling the following cartridges:

	Caliber
United States Army .....	inch .30
Remington .....	millimeters 6
Mauser .....	millimeters 7.65
Mexican .....	millimeters 6.5
Austrian .....	millimeters 7 "

The Navy's order of 50 Colt weapons, which were delivered in 1897, represented the first purchase of an automatic machine gun by the United States Government. It is a matter of history that their use in the hands of the Marines saved the foreign legations in Peking during the Boxer uprising.

In 1898 an additional 150 Colts were procured. The machine gun field, as far as the Navy was concerned, had been cleared of crank-operated guns. Browning had proved that the gas-operated automatic weapon was not only a possibility, but an accomplished fact. The Army, however, thought otherwise and kept the Gatling as standard equipment for another decade.

The model '95 consists of a heavy barrel attached to the breech casing which carries the mechanism for charging, firing and ejecting the shell. The loaded belts are contained in boxes to be attached to the gun casing so that the ammunition supply will not be affected by vertical or horizontal motion of the weapon. The mechanism is operated by the pressure of the powder gases in the barrel after the projectile has received its maximum velocity, and is done without injuring either the range or penetration. In the barrel to the rear of the muzzle a small radial vent opens downward from the bore. This is closed by a piston which fits in the gas cylinder surrounding the outer edge of the vent. The piston is pivoted to a gas lever in such a way that the latter adjusts itself to the gas cylinder. The lever swings in a vertical plane.

The small weight and bulk of the gun ren-

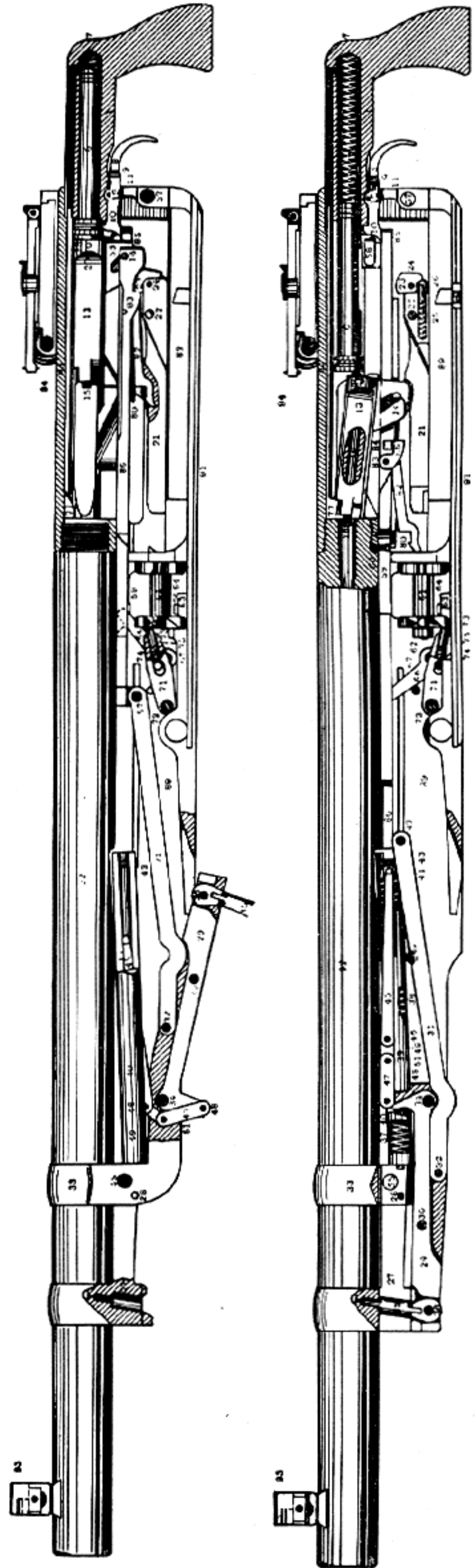

Section Drawing of Colt Model 1895.

dered it ideal for landing parties, since it could be carried by the individual soldier, or on a mount attached to the side of a landing craft.

On 20 April 1897 the auto-loading pistol was patented. It was the forerunner of the Army Colt caliber .45. In order to promote further his commercial models, Browning became connected with the Fabrique Nationale d'Armes de Guerre of Liège, Belgium. The first gun produced was a hammerless auto-loading pistol which made its appearance in 1900. Six years later a quarter million had been sold. Twelve years from the time the first weapon was produced, the millionth pistol was made. After this fact was engraved on the receiver, the weapon was presented to John M. Browning during the ceremony of conferring the title "Chevalier de l'Ordre de Leopold" by King Albert of Belgium. Unlike Maxim who renounced his citizenship to receive an equivalent British honor, Browning accepted it as one of the necessary nuisances accompanying success. But from that day on, the title, medal, and all lay unused in his desk drawer.

Of all the design problems that confronted Browning, producing an auto-loading shot gun was the most challenging; and its successful accomplishment in 1900 was his greatest pride. It was first manufactured in Belgium by the Fabrique Nationale, and later by American arms plants, as were his auto-loading rifles, including the high-powered and the numerous caliber .22 models. All these later Browning-designed rifles, manufactured originally in Belgium, were also made by the Remington Arms Co. of Ilion, N. Y.

About the only real purpose served by the Colt machine gun Model '95 was to introduce a full automatic weapon into equipment of American armed forces. Its use at Santiago de Cuba was limited to Navy landing parties going into action beside the Army's Gatlings under Lt. J. H. ("Gatling Gun") Parker. The first model was modified in 1902 and again in 1904.

The modified Colt was purchased in considerable numbers by all the South American countries and by most of the great European powers. One of the distinguishing features of the early models was that no adjustments were to be made by the gunner, the weapon having been adjusted

at the factory to shoot at a rate slightly greater than 400 shots per minute.

Cooling was dependent upon the heavy barrel construction. The system was inadequate in not permitting a sustained burst of undue length, nor could the weapon be fired with the gunner lying prone on the ground. The fore and aft sweep of the gas-actuated loading lever made this impossible.

To operate the weapon, the gunner pushes the brass tip of the loaded belt through the opening in the feedway and, at the same time, swings the loading lever downward and to the rear until it strikes the bottom plate of the gun. Upon release of the spring-loaded lever at the extreme end of the movement, it will return to its ready position, at the same time chambering the round, cocking the piece, and locking the breech. The safety latch is then pushed to the fire position and the gunner pulls the trigger actuating the sear. After the powder charge has exploded and the bullet has passed the orifice, the gases expand through the radial vent upon the piston in the end of the gas lever. When forced downward and to the rear, the latter opens the breech, extracts the empty case, ejects it, and feeds the incoming round into position in the carrier. The lever, returned by a spring, chambers the live round, closes and locks the breech, and in the final act of locking, releases the sear of the firing mechanism. The cycle continues as long as the trigger is held rearward.

The working parts were all readily accessible. One of the selling features of the gun was that the hammer allegedly pumped cool air into the chamber. Regardless of this exorbitant claim, it was considered necessary that the gunner unload the weapon immediately after firing, as the rapid heating of the barrel made it hazardous to leave a live round in the chamber following a burst of moderate length. This necessitated unloading the chamber at the end of practically every burst if the weapon was not to be put immediately in action again.

As a result of the Navy's successful use of the '95 model Colt in the Spanish-American War, the Army also became interested in the weapon. But it could not use the Navy's guns due to the difference in caliber between Army and Navy rifle ammunition. In December 1898 a joint

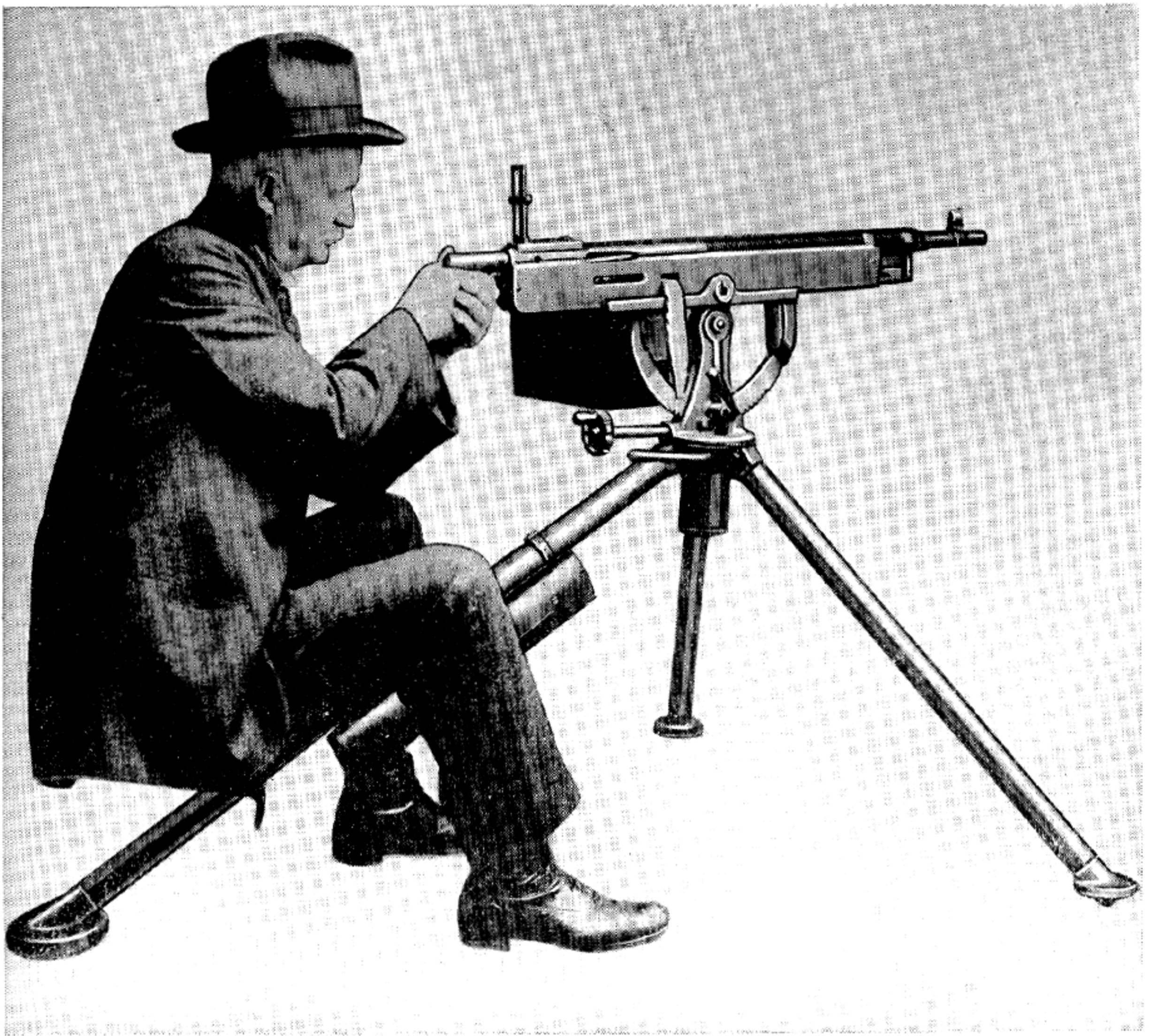

John M. Browning with the "Browning Peacemaker."

Army-Navy board met and recommended standardization not only of rifle cartridges, but of all small arms in the service. The report was as follows:

"The board is of the opinion that there are no conditions in the nature of the service peculiar to the Army, Navy and Marine Corps which require a different caliber for their small arms and machine guns.

"Since the board finds no sufficient reason for a different caliber of small arms and machine

guns for the Army, Navy and Marine Corps the board is of the opinion that the same caliber should be adopted for these services, and since interchangeability of ammunition is the special advantage to be gained by the use of a single caliber, a standard and uniform cartridge to the extent of securing interchangeability should be adopted.

"As the board is of the opinion that there should be but one caliber of small arms and machine guns for the Army, Navy and Marine Corps, and as great numbers of satisfactory cali-



ber .30 rifles are now in service in the Army and are being manufactured at a considerable daily rate, after large preliminary expenditures for plant, and as, under the prospective enlarged sphere of the Army's action and possible increase in numbers, it will require an immediate additional supply of such arms, the board is further of the opinion that the retention of the caliber now in use is at present imperative for the Army, and therefore, under their previous conclusions, it should also be adopted for the Navy and Marine Corps.

"The board, however, while recognizing the desirability of a uniform caliber for both services, does not deem it of vital importance, and is of the opinion that the change of the Navy caliber might well be postponed until it has been definitely settled whether or not it is advantageous to modify the Army cartridge by the use of a cannellured instead of a rim case.

"In considering a standard cartridge the board recognizes that the cannellured case is a simple one for small arms and machine guns, and its use in the Naval weapons of these classes has been satisfactory. It is further of the opinion that, if found practicable at moderate cost to adapt the present Army rifle to the use of such a case, a cartridge conforming in other external forms and dimensions to the present Army cartridge should be adopted as the standard and uniform small-arms cartridge for the Army, Navy and Marine Corps."

After the agreement to standardize all small arms and ammunition, the Navy ordered all its 6-mm guns rechambered for the caliber .30-40 Krag ammunition — making them practically identical with the gun in which the Army was interested. However, each service retained its own system of identification. The Navy continued to designate with Mark and Roman numeral; the Army with model and year. The Navy's 6-mm gun was known officially as the Colt machine gun, Mark I, and the modified weapon rechambered for the caliber .30-40 was called the Mark I Modification 1.

At a later date, when the Krag caliber .30-40 was dropped from the service in favor of the Springfield caliber .30, the Navy again rechambered the weapon to use the new service round.

But, for reasons unknown, unless it was considered too obsolete to warrant the additional trouble, the Mark and Modification numbers were not changed. This is believed to be the only time a major power twice rechambered the barrels of an automatic machine gun while it was still in the status of being in active service.

While the Army gave it the designation known throughout the world, there is no record of its ever having officially adopted the '95 model Colt machine gun. Instead, the Gatling gun, after the successful demonstration at San Juan Hill, had a tremendous following in the Army. And while the Colt '95 was tested at regular intervals, and made a creditable showing in every instance, the Army's official stamp of approval was never given. The following report of a machine gun board at Springfield Armory to the Chief of Ordnance, United States Army, on 14 June 1895, is typical of the weapon's reception:

"The Colt automatic gun is an ingenious, compact, and relatively light arm. Its continuous automatic firing depends upon the action of the ammunition used. It is easily pointed by hand, and its fire is completely under the operator's control. Its rapidity of fire during the tests was about 100 rounds in 17 seconds.

"A perusal of the tests made shows that stoppages in the firings were experienced from various causes, necessitating in each case a recocking of the piece by hand, and in consequence it appears that the uninterrupted automatic firing of a belt of 100 or more cartridges is not apt to be obtained. The mechanism, composed of a large number of working parts and spiral springs, was prevented from working by such a small particle as the piece of brass punched out for the gas channel in a cartridge shell head, and as experience shows that pieces of the primer or cartridge shell, if detached from any cause, are apt to fall into the working parts, this is considered a serious defect. During the firings there was a constant vibration of the muzzle, and in general the elevation was increased, due, undoubtedly, to the action of the gases in escaping through the vent in the underside of the barrel and the repeated striking of the gas lever on the same point of the barrel when returned to its position by the gas-lever springs.

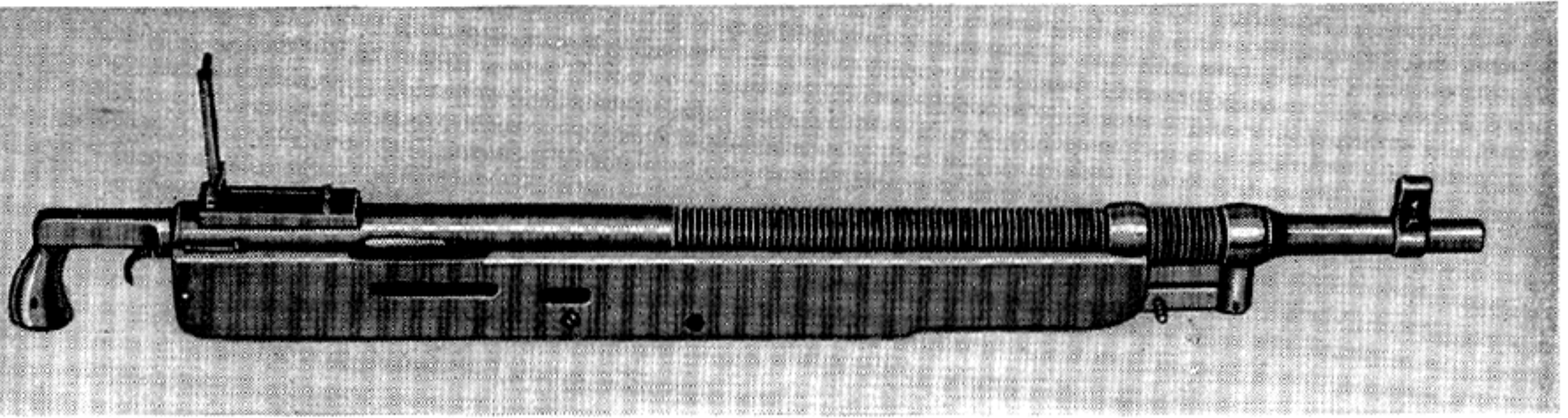

Colt Machine Gun Model 1895, as Modified in 1914.

"It is thought probably that the heat developed in a prolonged, continuous firing would so expand the gas cylinder and the piston on the gas lever as to interfere with uninterrupted automatic action, and that the continuous action of the gases on the head of the piston and also the striking of the gas lever on its return may so upset the piston as to have the same effect. The liability of the mechanism to derangement would require a gun crew equipped for and practiced in making repairs.

"The advantages of this arm are: Relative lightness, compactness, automatic action, ease of manipulation, complete control of the firing, small gun crew required, and absolute safety from hang fires.

"The disadvantages are: Numerous small working parts, dependency upon spiral springs, delicacy of mechanism, liability to be clogged by foreign particles, decrease in initial velocity due to loss of gases escaping through vent, vibration of muzzle and consequent inaccuracy, necessity of loading belts by hand before gun can be used, and frequent interruptions in automatic firing from various causes. The board is of the opinion that in its present form, as shown by the tests made, this arm is not suitable for ordinary service and has no place in the land armament.

"There being no further business before the board, it adjourned sine die.

"D. M. TAYLOR,  
*Captain, Ordnance Department.*

"JAS. ROCKWELL, JR.,  
*Captain, Ordnance Department.*

"JNO. T. HAINES,  
*First Lieutenant, Fifth Cavalry.*

"TRACY C. DICKSON,  
*Lieutenant, Ordnance Department.*

"The foregoing proceedings and opinions are approved.

"A. MORDECAI,  
*Colonel, Ordnance Department,*  
*U. S. A., Commanding."*

At the outbreak of World War I our unpreparedness made the Government disregard the fact that the Colt '95 was outmoded. Due to our deplorable lack of machine guns on entering the conflict, large contracts were given for the weapon. While it was admittedly obsolete in every respect, it still represented about the only machine gun with any chance of speedy delivery. Since Colt was tooled up for it and other companies were making a rechambered version for Russia, these firms would be able to turn out large quantities of the weapon in short order. The only change made in the weapon was that it was to have an interchangeable barrel and to identify this version it was known as the Mark III (Navy) or the Model 1917 (Army).

The Colt Co. supplied 1,500 of these weapons before the end of the war. But by this time recoil-operated machine guns (also a Browning design) were being delivered. They were so superior to the gas-operated "potato digger" that the latter was relegated to training uses only.

### The Browning Model 1901 Machine Gun

American-made recoil-operated guns had their inception at the turn of the century. Like most machine gun designers, Browning determined that the cleanest, most efficient and practical principle for a high-rate-of-fire automatic weapon was the short recoil system. As early as 1900 he

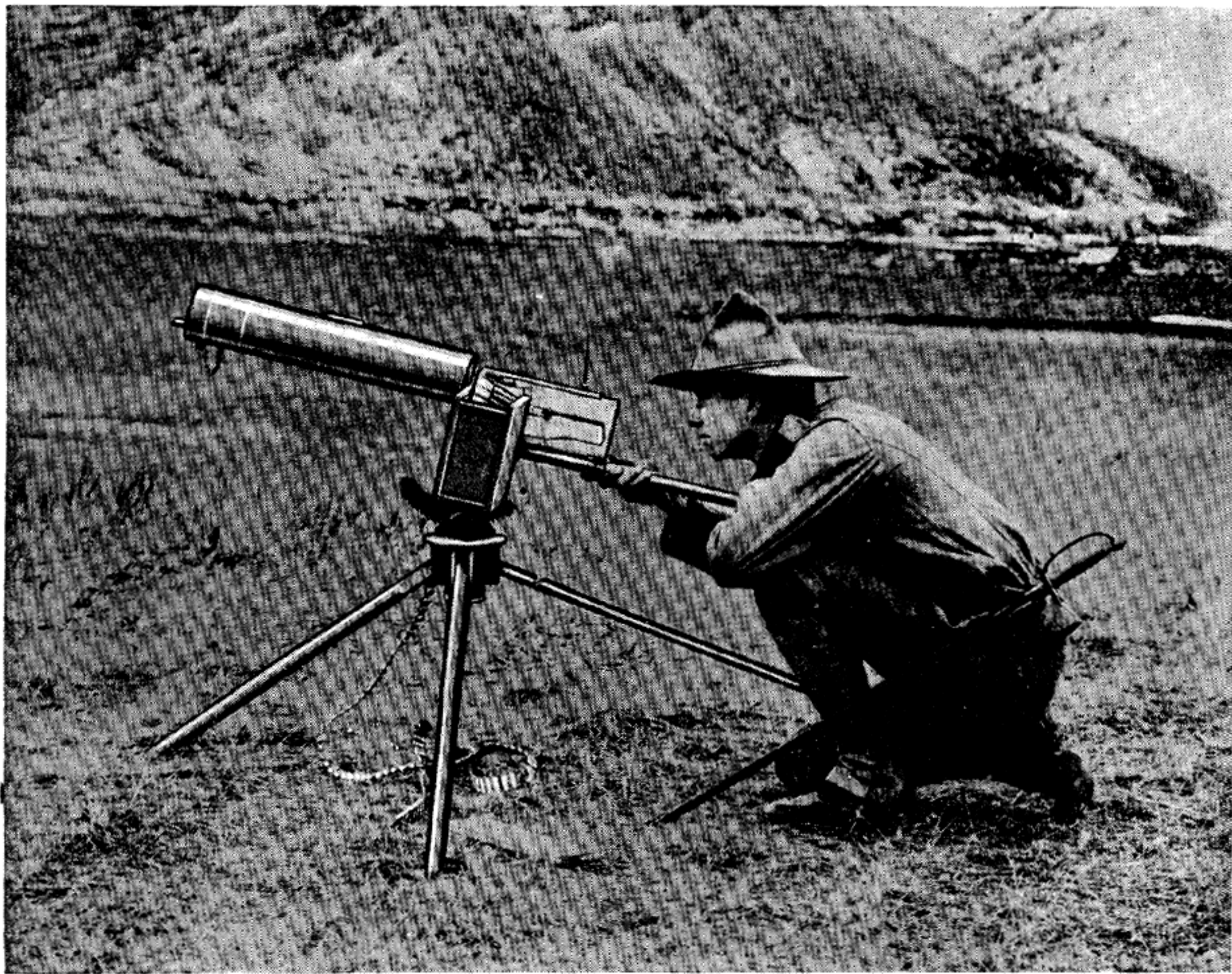

Marriner A. Browning, Son of Matthew S. Browning, Firing the Recoil-Operated Machine Gun, Model 1901.

filed application, and in 1901 was granted the patent for a short-recoil-operated water-cooled gun, incorporating all the basic features of the present line of Browning automatic arms.

Due to the lack of financial support from the United States Government for the development of an automatic weapon, he let this design lie dormant until 1910, as there was a ready civilian market for his hunting rifles, shot guns, auto-loading pistols, and high-powered weapons to keep him busy during this interval. But having reached the zenith in gun design for commercial purposes, he turned again to machine guns.

In case there is doubt that our present family of Browning machine guns is of such early origin, quotation is made from Browning's own description of the weapon's cycle of operation,

written in 1900 (current nomenclature added in brackets):

"The operation is as follows: The belt, which contains cartridges, is fed into the opening . . . in the casing until the flange of the first cartridge in the belt enters under the hook of carrier [extractor claw] . . . and the second cartridge is just past the cartridge-feed stop [belt holding pawl] . . . Now grasp handle and draw the bolt back. As the bolt and barrel extension are in this position locked together by the locking-block [breech lock] . . . the barrel will move back with the bolt, compressing both barrel [buffer] and bolt [driving] springs and cocking the hammer [striker], which is caught by both sears. The cartridge is drawn back by the hook of the carrier

[extractor claw]. (It thus appears that the hammer [striker] cannot fall against the firing-pin except when the barrel is in its forward position, in which position the barrel and bolt are firmly locked together.) When the pin . . . of the locking-block [breech lock] reaches the downward incline . . . of the cam-groove [breech lock cam] in the casing [receiver], the locking-block [breech lock] will be forced downward, freeing the barrel from the bolt. The barrel is then thrown forward by the action of its spring [buffer spring]. . . . The pressure of plunger [cover extractor cam] . . . throws down the forward end of the carrier [extractor claw], causing the front of the cartridge to fall into the receiver [T slot] . . . so as to move forward below the cartridge-belt in line with chamber. The forward movement of the barrel is stopped by the barrel-latch [accelerator claws] . . . engaging the projection . . . of the barrel extension [shank].

"The projection . . . on the barrel extension or receiver at the same time locks the bolt-latch [accelerator] . . . so that the bolt cannot be engaged thereby. . . . The feed-lever . . . , feed-slide . . . , and feed-pawl will have been moved to the proper position . . . by the backward movement of the cam. . . . If the grasp on the bolt be now released, the bolt [driving] spring will throw the bolt forward, carrying the cartridge into its chamber in the barrel. When the

bolt is near the limit of its independent forward movement, the cam . . . on its under surface engages the arm [claw] . . . on the barrel latch [accelerator], thus forcing down said latch [accelerator] and releasing the barrel to continue its forward movement under the influence of the barrel [buffer]-spring.

"The barrel and bolt then move forward together, and as pin . . . of locking-block [breech lock] . . . rides up the incline in the casing . . . the locking-block [breech lock] is forced into engagement with the groove [locking recess] . . . in the bolt, so that the barrel and bolt are locked together. When about at the limit of its forward movement, the forward end of extension . . . of the barrel-piece strikes sear . . . and disengages this sear from the hammer [striker], leaving the sear . . . in engagement and the gun in position for firing by bearing on the trigger . . .

"When the gun is fired and as long as the trigger is held down and cartridges supplied, the automatic action of firing will be continued in manner as has been explained, . . . the sear . . . then alternately holding and releasing the hammer [striker]. The action of the bolt moves the cartridge-feed [belt feed lever], as has been explained, and as long as there are cartridges in place in the belt the firing will continue unless trigger . . . is lifted, when the firing will cease.

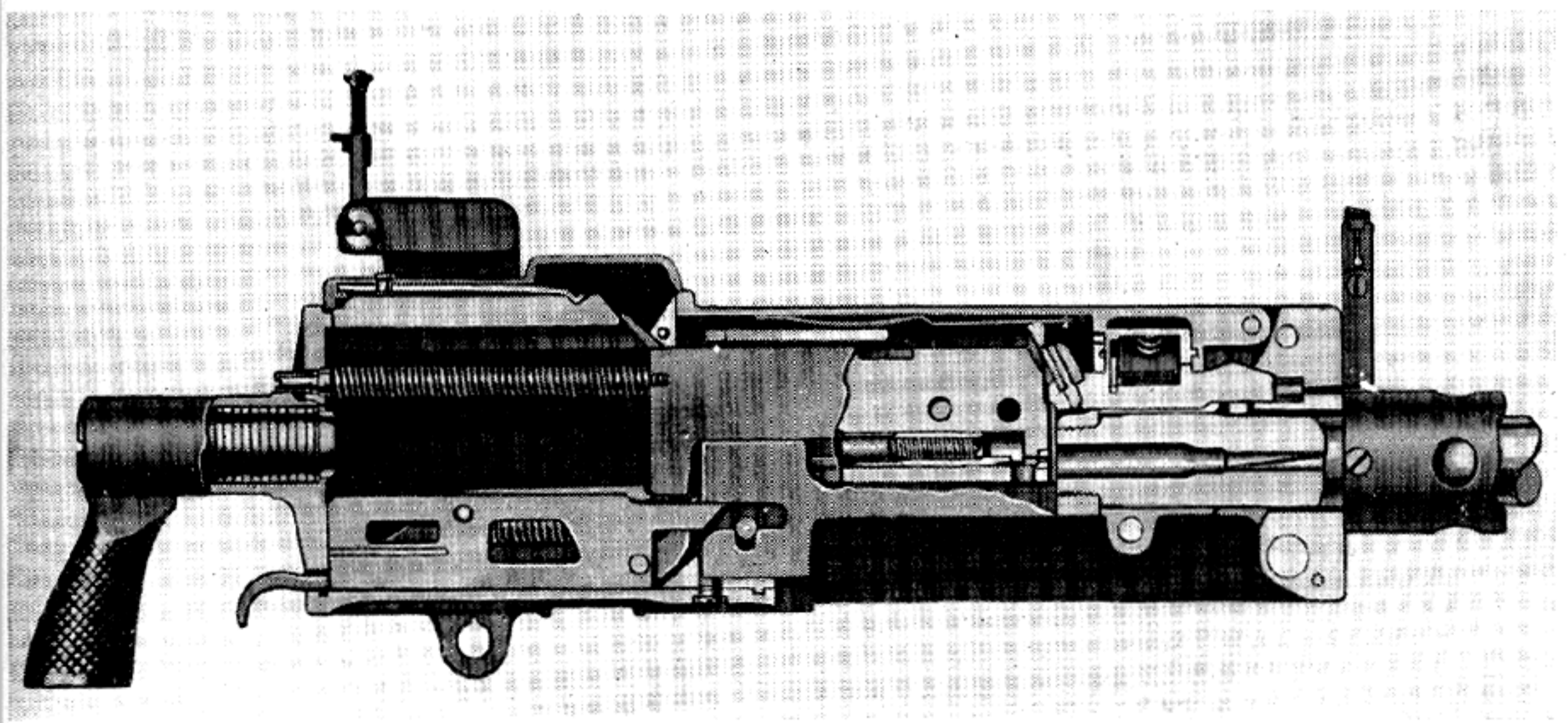

Section of Browning Cal. .30 Recoil-Operated Machine Gun.

The cartridges are fed forward by the bolt almost their whole length while the barrel is held back by the barrel-latch [accelerator]. This allows them to feed into the receiver just forward of the retracted position of the carrier [extractor claws] with little lost motion.

"As the barrel moves forward while the bolt is held back by the latch [accelerator claws] . . . a stud [combination extractor feed cam and ejector] . . . on the left-hand side of the barrel extension, which extends into the path of the cartridge (the bolt being grooved to allow it), comes into contact with the rim of the fired shell as it is held back by the ejector and ejects the shell. . . . When the gun is fired, the barrel recoils to a position further back than when the bolt is drawn back by hand, and by its action on the cushion-rocker [accelerator body] accelerates the backward movement of the bolt, while its own motion is gradually checked by the rocker [accelerator body], as explained.

"The bolt . . . has a bayonet-catch groove . . . cut around the bore, in which the bolt-[driving-] spring . . . is inserted, and the rod, . . . which guides the spring, has a pin . . . projecting at one side, which pin can enter said groove, so that when the spring is compressed and the rod forced into the bore of the bolt with its pin in the groove a partial turn of the rod will lock the spring in place, when the rear cover [back plate] . . . can be lifted if in place . . . or can be applied to the casing if said cover has been removed and can then slide down over the rod. Then by drawing the bolt back, the rear end of rod will project through the rear cover, and by turning the rod the spring is released and bolt thrown forward. The rear cover [back plate] is retained in place by the rod . . . projecting through a hole in said cover . . ."

The weapon ejected the empty cartridge case from an opening in the right side of the receiver, and not through the bottom. This feature, however, had no bearing on the basic principles of operation used throughout the development of the later guns. The absence of a rear buffer should also be noted; but since high rates of fire were not demanded, it was of small consequence. The barrel buffer and driving springs were ade-

quate in stopping the recoiling parts and returning them to battery at a speed considered reasonable.

Browning's description of the preceding cycle of operation was written when there were only 45 states in the Union and 3 years before the Wright brothers made the first flight in an air plane. This serves as a yardstick by which to measure just how far this remarkable man was ahead of his time with his basic machine gun principles.

The water-cooled prototype of 1910, built on the 1900 specifications, was proofed at Ogden, Utah, and worked reliably. Browning thought that it needed only refinement and increased rate of fire. The first change was to do away with side ejection of the empty cartridge. Though dependable, it presented the problem of hot empty brass flying at a right angle, thus limiting the area in which another gun could be operated.

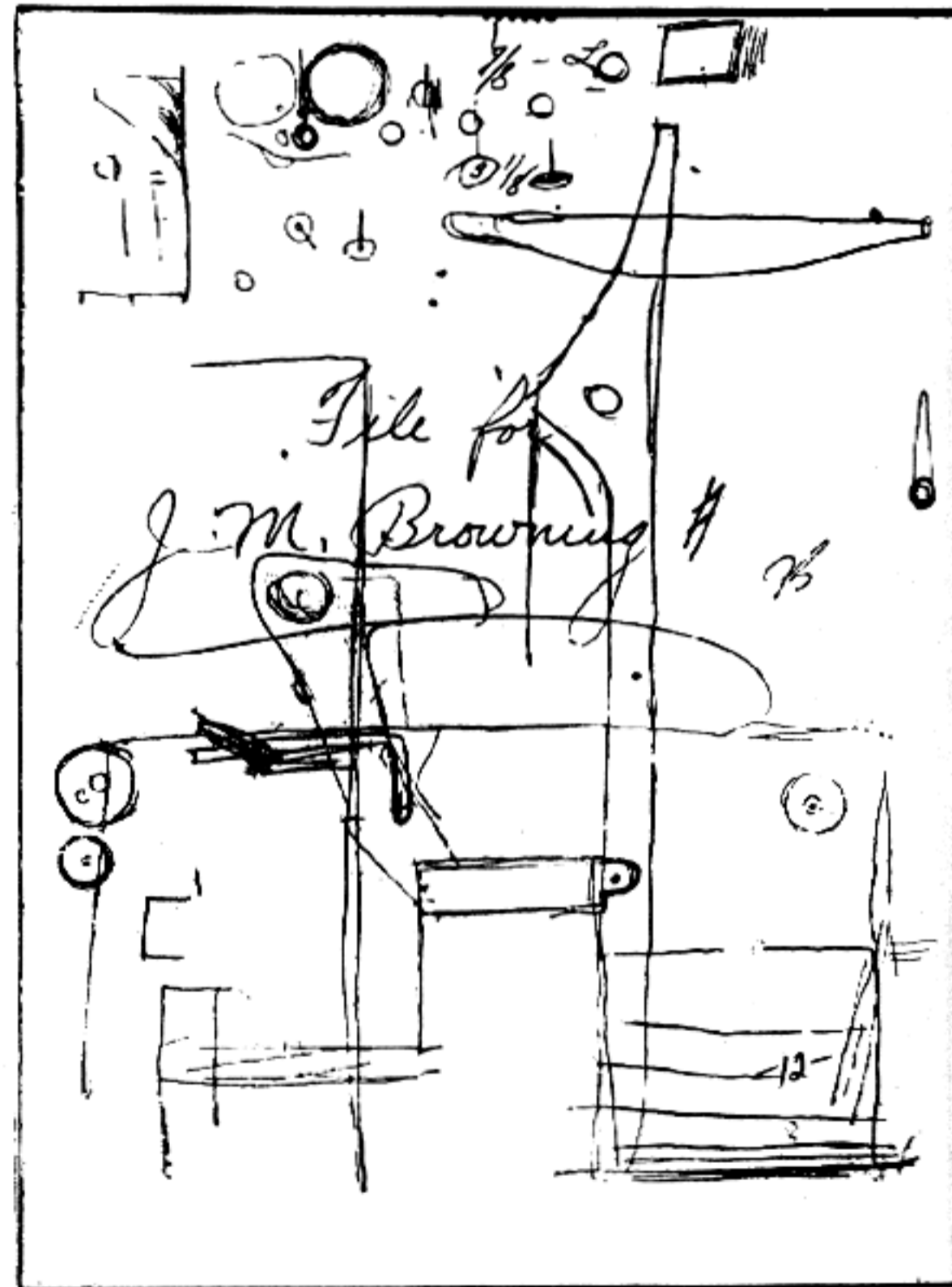

A Drawing from J. M. Browning's Drafting Board. Browning Often Worked from Freehand Sketches Made on Wrapping Paper.

It was solved by cutting an opening in the bottom of the receiver just forward of the breech-lock cam. The incoming brass, forced down by the extractor, knocked the empty case straight down to the ground. The last round fired was struck by the ejector tip and thus cleared the gun.

In order to return the bolt to battery faster and smoother, a buffer filled with horn fiber discs served the two-fold purpose of absorbing the surplus energy and bouncing the bolt back at a greater speed. Browning also did away with the hammer method of firing, replacing it with a two-piece firing pin that had a sear notch on the rear, and had sufficient weight to serve as both striker and firing pin.

A trigger bar was added which allowed the operator to actuate the sear from two positions. The nose of the bar, upon being depressed, pushed the sear down out of engagement with the sear notch on the aft end of the firing pin.

Other minor improvements included the use of breech lock depressors to assist in disengaging the breech lock from the locking recess in the bottom of the bolt. However, all these changes were merely refinements. Not a single basic feature was used that John M. Browning did not already have in his 1900 design. The reliability of the mechanism and its freedom from adjustments enabled the individual soldier to obtain a large volume of fire without much preliminary training and its simplicity of construction from a manufacturing standpoint was quite acceptable. Browning, on his own initiative, developed and improved the weapon until he corrected practically all the minor defects.

Browning Guns in World War I: B. A. R. and Browning Machine Gun Model 1917

The United States showed no interest in machine guns until after we were officially at war with Germany, at which time Browning, along with other inventors, was asked to submit weapons with a view of adoption. It is true that there had been earlier trials of various machine gun mechanisms of both American and foreign manufacture. But nothing resulted from them except a passive interest by our Government. Thus, although we had practically two years to prepare after the start of World War I before we entered and it was almost a foregone conclusion that we were to be a participant, there had been no effective machine gun program in spite of the early demonstration by Germany as to the deadly employment of the weapon.

Machine gun development in this country floundered on one thing only: Those in authority could not make up their minds on what was wanted. Had they come to some happy conclusion as to what weapon would be adequate, there would have been no machine gun problem to face on 6 April 1917. On that afternoon the headlines proclaimed that a state of war existed between the United States and the Imperial German Government. But the public was not told of a confidential report issued the same day to the military high command that to fight this strictly machine-gun war there were on hand only 670 Benét-Merciés, 282 Maxims, Model 1904, and 158 Colts, Model '95.

In other words, we had a total of 1,100 of what

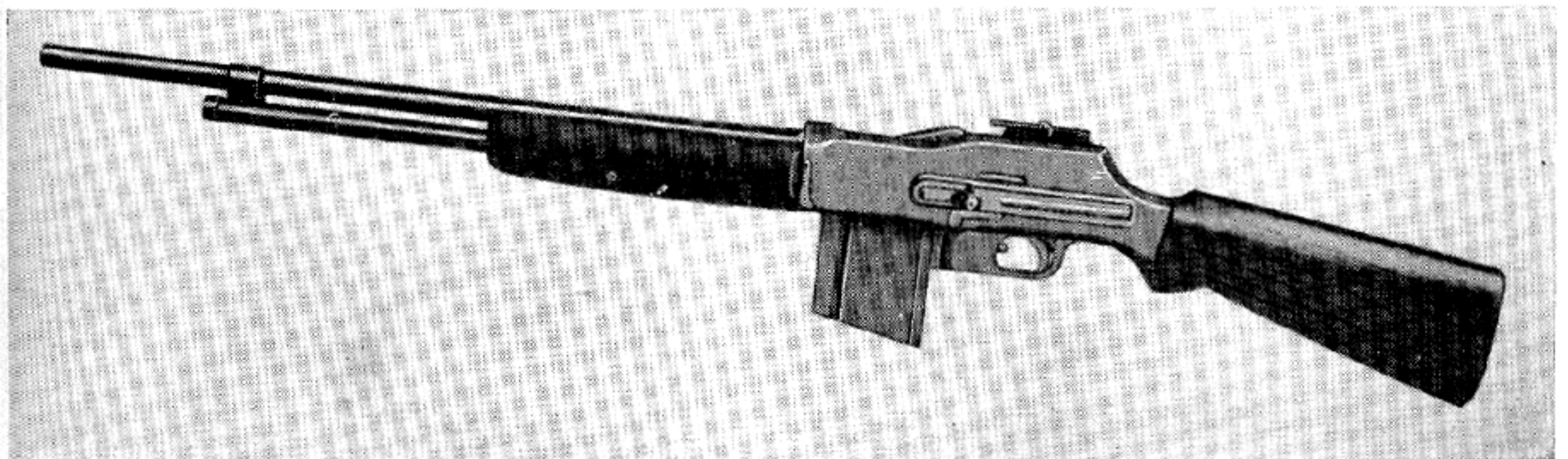

The Prototype Model of the B. A. R.

could be called machine guns (if one was generous enough to include the gas-operated, lever-action Colts, and the outmoded Benét-Merciés), while our requirements were at the time conservatively estimated at no less than 100,000 machine guns. Germany, upon entering the war over 3 years before, had done so with 12,500 highly improved Maxim-type guns with an additional 50,000 under construction. And she only needed to have each of her ordnance plants manufacture a moderate number each year to possess a staggering total at this period of the war.

In order for the United States to participate in the war with a semblance of machine gun armament, it was finally agreed, after still more debate, that until we did put into production

something of our own design, our forces sent overseas would be armed with whatever the French had to offer. The arms sold us, as can be easily understood, were their second best. The fact remains, regardless of how unpleasant it may be, that the country which originated and showed the world how to produce this deadly instrument actually entered the war with a most obsolete assortment of machine guns. They would have been more in keeping with the armament of revolutionists in a banana republic than as weapons of soldiers representing one of the richest and most progressive nations on earth.

The first French machine guns used to arm American troops were chambered for the Lebel 8 mm rim-type cartridge, necessitating the issuing of two different types of cartridge by our

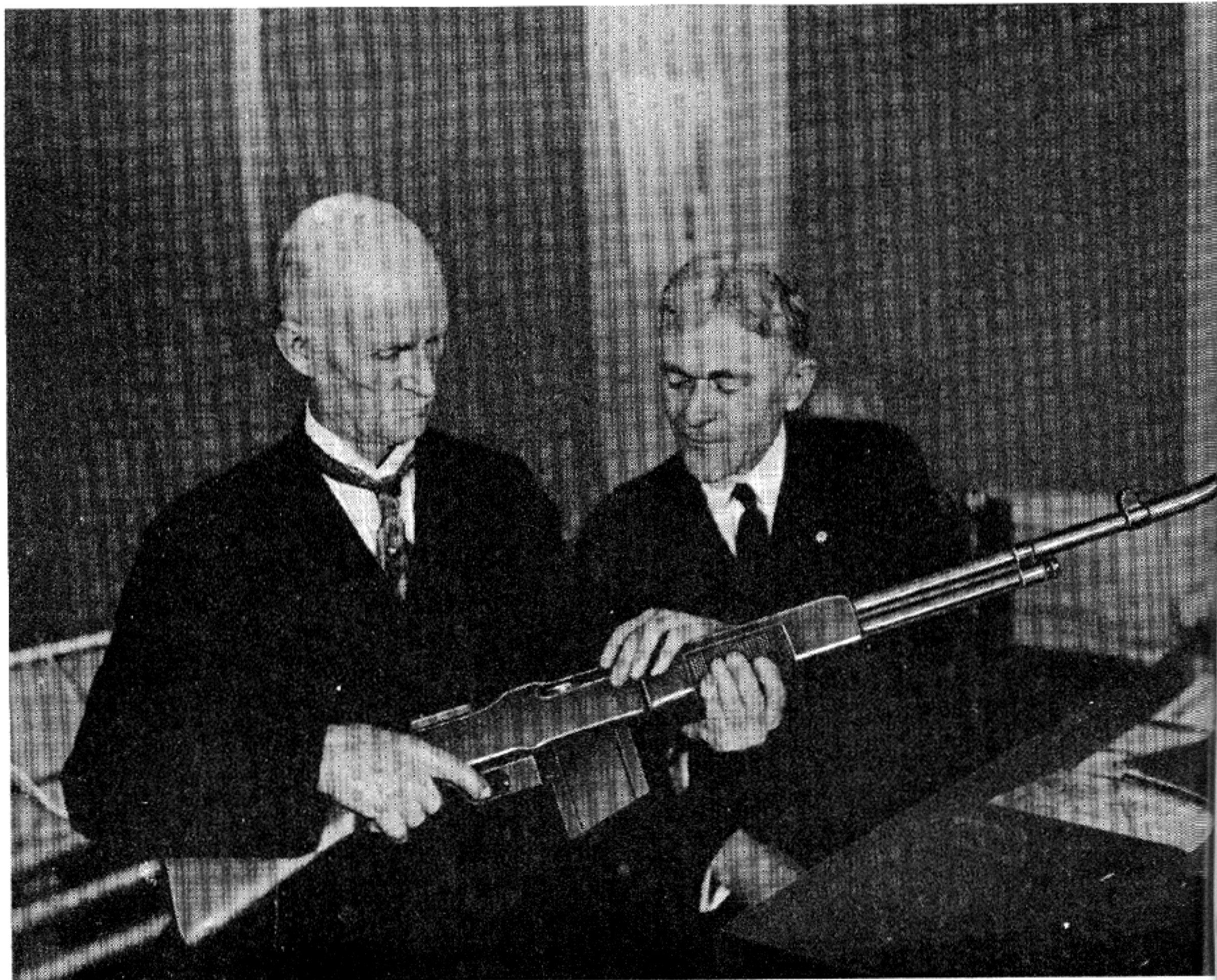

John M. Browning Examining One of His Automatic Machine Rifles in 1918 with Mr. Burton, One of Winchester's Experts.

supply department, one for machine gunners, another for riflemen. And as they invariably operated together as a unit, the logistics involved certainly should have given much aid and comfort to the enemy.

During the prewar period of indecision, John M. Browning personally brought to Washington, D. C., for purposes of demonstration, two weapons, the heavy (water-cooled) machine gun and the machine rifle (to be known later as the B. A. R.). These were both chambered to take the standard Springfield rifle cartridge known throughout the service as the .30/06.

The B. A. R. (Browning Automatic Rifle) had been designed as an answer to the demand for "walking fire"—thought to be so necessary to the individual soldier in trench warfare. The rifle can either be fired single shot or be converted instantly to full automatic with a maximum rate of 480 shots per minute. It is gas actuated, air cooled and employs a 20-shot magazine that can be emptied in  $2\frac{1}{2}$  seconds. The unloaded magazine can be detached and a fresh one put in its place in about the same length of time. Three crifices are on the gun to insure smooth functioning. The weapon's seventy pieces can be completely disassembled and assembled in 55 seconds.

The rifle is designed to be carried by the advancing infantryman with the sling over his shoulder, allowing the butt to be held firmly against the hip. When necessary to fire a burst, the safety switch is moved to "Automatic," and as long as the trigger is held the weapon will continue firing.

The operating mechanism is rear seared. The trigger releases the bolt to go forward. The latter strips the round from the magazine and starts to chamber it. When two inches from battery, a

circular cam surface on the bottom of the bolt lock begins to ride over the rear shoulders of the bolt support, camming up the rear end of the bolt lock.

As the link pin rises above the line joining the bolt and hammer pins, the bolt lock is alined with its locking recess in the receiver and pivots about the bolt-lock pin. The hammer pin on its link revolves, forcing upward the bolt lock. The rounded surface of the lock slips over the locking shoulder in the "hump" of the receiver and provides additional thrust, forcing the bolt all the way into battery.

This final act removes the obstruction from the firing pin, exposing it to the center rib of the hammer. On the final movement forward of the slide, the hammer drives the firing pin into the primer exploding the powder charge in the cartridge. All counter recoil is ended when the slide strikes the shoulder at the rear end of the gas cylinder tube.

Prior to the bullet's clearance of the bore, the gases pass through a port 6 inches from the muzzle, expanding in the cylinder and impinging on the piston head. This sudden blow forces the piston to the rear.

The initial backward movement of the slide cocks the hammer before moving either the attached bolt lock or bolt. The circular cam on the lower part of the bolt lock, operating in conjunction with the rear shoulders of the bolt support, produces a leverage that loosens the empty case in the chamber. This initial extraction occurs before the weapon is fully unlocked.

After the piston has carried the slide rearward, the gas is exhausted through six ports located at the rear of the gas-cylinder-tube brackets. Two rings on the piston prevent the gas from returning through the cylinder tube.

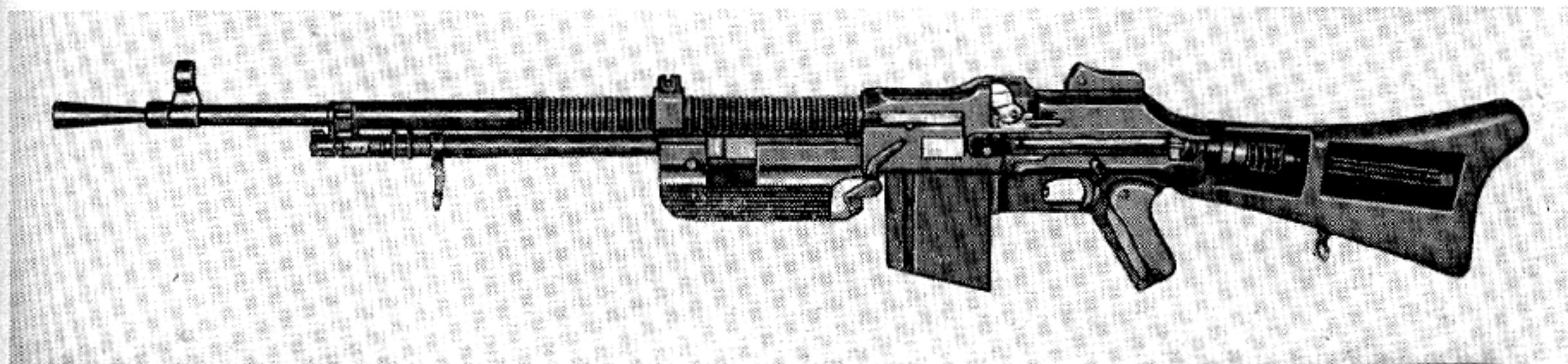

A Sectionalized B. A. R., Cal. 7.92 mm, of Polish Manufacture.



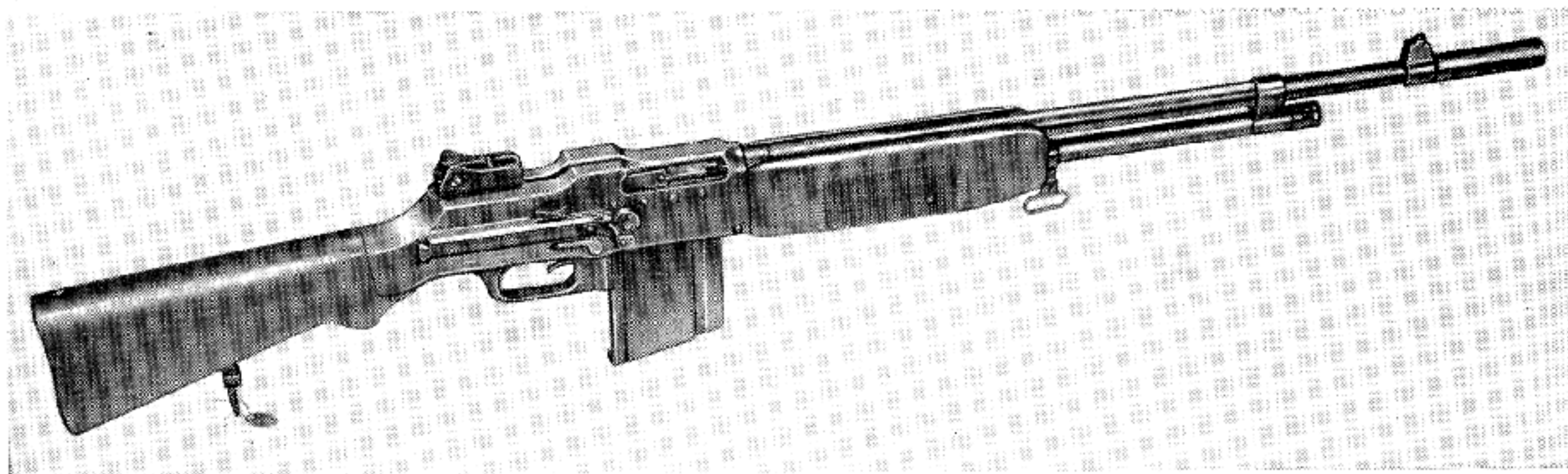

B. A. R., Cal. .30, as Standardized for U.S. Service, Serial Number 5.

When the recoil has reached one-fifth of an inch, the breech pressure is low enough to allow the bolt to be safely unlocked. At this point the link is compelled to revolve forward about the hammer pin, drawing the bolt lock down clear of the "hump" in the receiver. A cam slot in the bottom side of the bolt lock comes in contact with the firing-pin lug, drawing the tip of the firing pin away from the primer.

After the piece unlocks, the empty case is carried rearward on the face of the bolt, held there by the extractor. When the base of the cartridge strikes the ejector, the extractor serves as a pivot point to throw the brass through the slot in the right side of the receiver. As the cartridge case passes through the opening, the brass strikes the outside frame and is deflected to the right and forward.

At the end of the extreme rearward travel of the bolt, the recoil spring is fully compressed, storing energy for the return movement. The sear nose is now in position to catch in the notch at the underside of the slide and hold the mechanism back under spring compression ready for the next pull of the trigger. If the trigger is still held to the rear, the weapon continues the cycle of operation.

The first public firing demonstration of the B. A. R. and the water-cooled machine gun took place on 27 February 1917 at a location outside the city limits of Washington, D. C., known as Congress Heights. It was witnessed by 300 people including men of high rank in our own military service, many Senators and Congressmen, members of the armed services from Great Britain, France, Belgium, and Italy, and representatives

of the press. The latter wrote much about the exhibition. They gave a glowing account of the reliability and tremendous firepower of both weapons and painted verbal pictures in the local papers of how a hundred men advancing with these weapons firing full automatic would literally sweep an enemy out of the way. The only feature they seemed to forget was that though war, at this point, was practically inevitable, the superb weapons demonstrated were the only ones in existence and were a long way from mass production.

The successful exhibition at Congress Heights, however, did create an interest that encouraged Browning to continue personally to improve and function fire his water-cooled gun at the Colt plant until he was satisfied that it was ready for endurance trials. The Government had adopted the B. A. R. from its initial showing at Congress Heights, but felt that a machine gun of the water-cooled type should be tested more thoroughly because of the more rigorous treatment given this type of weapon. In May 1917 he brought his heavy water-cooled gun to the Government Proving Ground at Springfield Armory for an official test. It showed a reliability that was amazing for a newly introduced weapon. A total of 20,000 rounds was fired without a malfunction or broken part at a cyclic rate in excess of 600 rounds a minute.

After the splendid performance of the weapon, Browning decided to test it further and fired an additional 20,000 rounds. All 40,000 cartridges were expended without the failure of a component part. This was such an unusual performance for a new weapon that it aroused great in-



Browning Machine Gun, Model 1917, Cal. .30, as Introduced to the Service in World War I.

terest and some skepticism among its most ardent backers.

In order to show that the gun was not especially prepared for the test, a second weapon was used that not only duplicated the original trial, but bettered it by operating continuously for 48 minutes and 12 seconds. This was accomplished by having available sufficient belted ammunition for this phenomenal burst.

Following this excellent demonstration, the board of five Army officers and two civilians appointed by the Secretary of War to study the problem of machine gun supply recommended for immediate adoption the water-cooled Browning, pronouncing it and the previously accepted B. A. R. the "most effective guns of their type known to the members."

The outstanding features were reliability and simplicity of design. The officers who demonstrated the weapons showed that it was possible for the operator, while blindfolded, to take them

down and reassemble them in a matter of minutes. This was so impressive that all machine gun schools adopted the blindfold test as a "must" in their courses of instruction.

The easily constructed mechanism was a great selling point for the Government, as it appeared possible to get the weapons into mass production quickly. Nothing was more important at this critical stage.

After the hasty adoption of the Browning automatic machine gun and the machine rifle, it was quite apparent that no single manufacturing plant was capable of taking care of the vast war need for these weapons. The Colt's Patent Fire Arms Co., which had an exclusive concession to manufacture the weapons under the Browning patents, agreed to sell its rights to the Government. By July 1917 it delivered prepared gages and drawings that other companies could work from in producing the guns.

During July and August 1917, more than 2

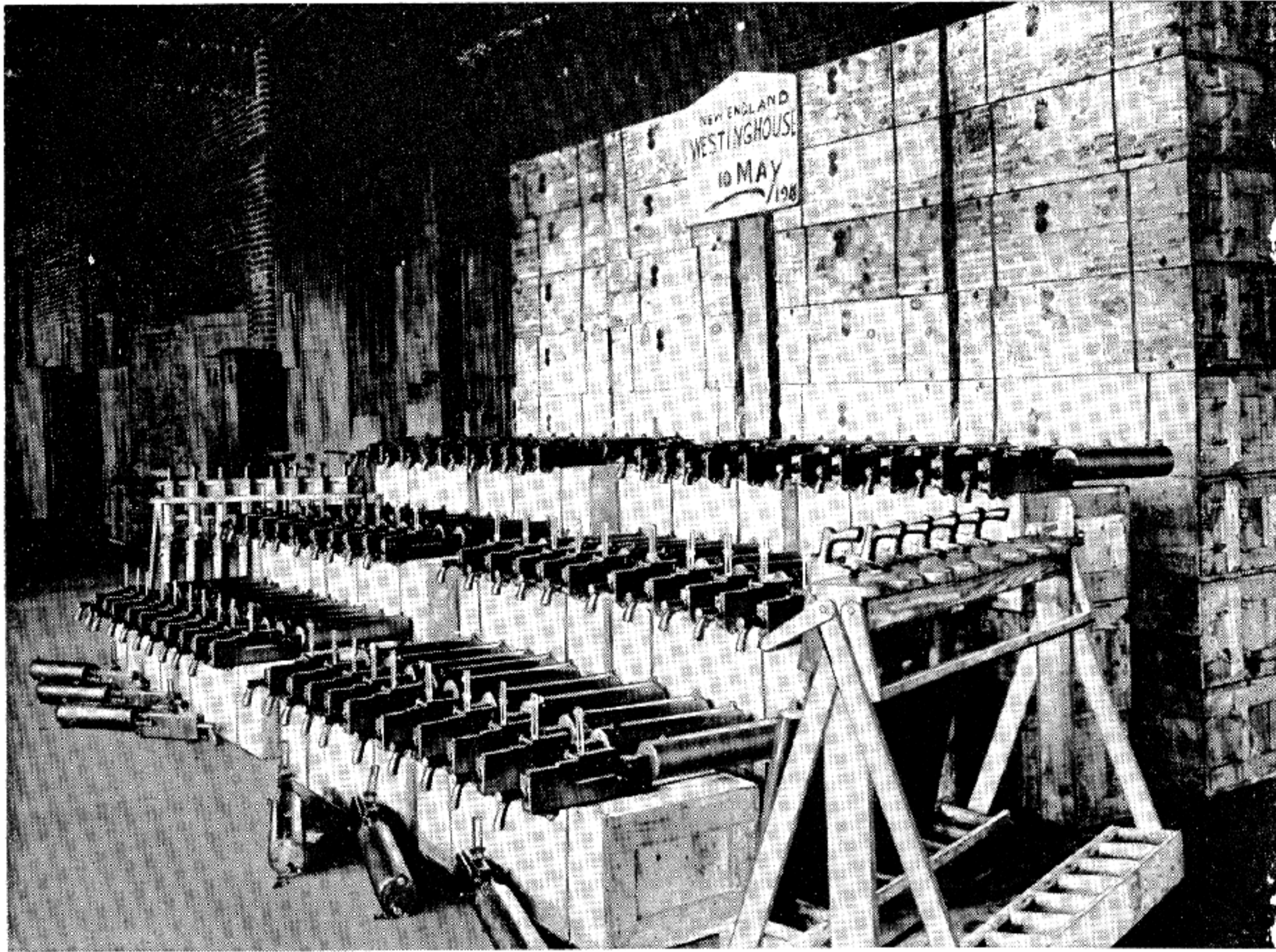

Westinghouse Production of Model 1917 Cal. .30 Browning Machine Guns.

months after our entry into the war, a survey was made of facilities and plants thought capable of turning out the water-cooled version in quantity. The Colt Co. established a plant at Meriden, Conn., for the manufacture of 10,000 guns. In September 1917, Remington Arms Union Metallic Cartridge Co. of Ilion, N. Y., was given a contract to produce 15,000. On 1 January 1918, the New England Westinghouse Co. was approached concerning its availability to construct 20,000 and a contract was agreed upon on 10 January 1918.

The Westinghouse production schedule proved to be very outstanding. In 29 days a hand-made pilot model had been constructed, and in 63 days the first gun came off the assembly line. Some 3,500 rounds were fired through this gun without a single malfunction or stoppage. And at the time the Armistice was signed 9

months later, this plant was producing 500 guns a day.

From the quantity standpoint Westinghouse was the most prolific in the manufacture of this machine gun. It was the middle of May before Remington began to deliver the completed weapon, having been delayed due to a previous Russian contract. Colt, strange as it may seem, was the last to come into production, as it was late in June 1918 before its Meriden plant started to deliver the guns. The company's time had been largely occupied by the preparation of mechanical drawings and the manufacturing of precision gages for the other plants, and by its earlier contract with the British for the making of the Maxim-Vickers machine gun.

The final production schedule illustrates how some forethought on what was needed would have found us properly prepared for war. For,

once put into operation, the wheels of industry started a constant flow of these weapons from the plants. By the end of June 1918, Westinghouse had a cumulative production of 2,500 and Remington a production of 1,600 weapons. As of 1 August both plants had made a few under 10,000; 2 months later, they had turned out 26,000. And when the Armistice was signed, the three companies had sent from their proof ranges nearly 43,000 machine guns of this type, divided as follows: Westinghouse, 30,150; Remington, 12,000; and Colt, 600.

While these figures are most impressive, it can be readily seen that this stupendous effort was practically worthless as far as the war effort was concerned. The dates of delivery were far too late to get the weapons into the hands of our troops in France, who were still armed with the French and English war surplus. Great emphasis has been placed on the impressive number of Browning machine guns made during World War I, but those who have boasted most of this accomplishment have negligently failed to mention the fact that these guns arrived too late to offer more than a token demonstration against an already defeated enemy. Our allies, though impressed by the clean lines and simplicity of construction of the Browning automatic machine guns, never considered them as having been battle tested.

The first of these weapons sent overseas were routed to machine gun schools to acquaint the soldier with the much publicized American product that would rid him of the French arms. They met with the enthusiastic approval of all who viewed them. Requests came from the Allied high command to speed up delivery so as to have their presence felt at the front. The war ended, however, before we had equipped even a small portion of our own Army.

First combat use of the Browning automatic machine guns was on 26 September 1918 by a small detachment of the 79th Division. The following report was sent General Pershing by the commanding officer of this detail:

"During the 5 days that my four guns were in action they fired approximately 13,000 rounds of ammunition. They had very rough handling due to the fact that the infantry made constant halts, causing the guns to be placed in the mud.



Lt. Val A. Browning, Son of John M. Browning, in France Instructing Troops in the Use of the Browning Machine Gun, Cal. .30.

The condition of the ground on these five days was very muddy, and considerable grit, etc., got into the working parts of the guns. Guns became rusty on the outside due to the rain and wet weather, but in every instance when the guns were called upon to fire, they fired perfectly. During all this time I had only one stoppage, and this was due to a broken ejector."

Only after Browning's guns had been officially adopted by the United States Government and production had reached its peak, did a conference take place between representatives of the War Department and agents of the J. M. & M. S. Browning Co. in regard to royalties.

The Government representative was asked what he thought would be a fair remuneration for the use of all Browning patents on machine guns and the caliber .45 auto-loading pistol. When he suggested a certain sum, the Browning Co.'s agent stated that his firm's instructions to him were to allow the Government to set its own price and to accept this cheerfully without hesitation or further bargaining. The records reveal the settlement amounted to less than one-tenth the amount our government usually allowed its inventors.

The Secretary of War, upon hearing of the generous terms the Brownings had agreed upon as a settlement, sent John M. Browning the following letter in expressing the whole country's gratitude, not only for his invaluable contribution in the field of weapon design, but also for his patriotism in accepting such a modest return on the products of his genius.

"WAR DEPARTMENT  
"WASHINGTON

"NOVEMBER 13, 1917.

"MY DEAR MR. BROWNING:

"I have learned from Major Little of the patriotic and generous attitude taken by you in the negotiations for the use of your patents of light and heavy machine guns in this emergency, and beg leave to express my appreciation of it.

"You have performed, as you must realize, a very distinct service to the country in these inventions, and contributed to the strength and effectiveness of our armies. You have added to that service by the attitude you have taken in the financial arrangements necessary to make your inventions available to the Government.

"Cordially yours,  
(Signed) "NEWTON D. BAKER,  
*Secretary of War.*"

While the production effort in turning out these arms was most commendable, the major weakness of the system of mass production manifested itself. All identical components are constructed with a manufacturing tolerance of within a few thousandths of an inch. Once tooled up, if an error is made, thousands of weapons would be turned out with the "built-in" malfunction. Correcting an inherent defect in design sometimes resulted in an expenditure of time and money greater than the original cost of manufacture.

This was most certainly the case with the 1917 model gun; and while its use was very limited in World War I, it is indeed most fortunate that the gun did not see too much service. The receiver of this mass-produced weapon was found to have a weakness in the bottom plate, caused, not from faulty design, but from choos-



John M. Browning with His Cal. .30 Machine Gun.

ing an inadequate metal. The mistake could have been prevented had time permitted more strenuous endurance firing of sample weapons taken from random lots. Such a part failure necessitated the construction of a piece known as a reinforcing stirrup that fitted over the affected spot on the outside of the receiver. Over 25,000 guns were modified by this addition in one year, and this and other hand work required as much time and expense as did the construction of the gun.

The production of the B. A. R. followed a similar pattern. Browning carried on most of his early development on the machine rifle at the Colt's Patent Fire Arms Co. Later, Winchester gave valuable assistance in connection with the preparation and correction of the drawings, adding many refinements to the gun. Winchester was the first to start manufacture on this model. Since the work did not begin until February 1918, it was so rushed that the component parts of the first 1,800 to be put out were found to be not strictly interchangeable. Production had to be temporarily halted until the required manu-

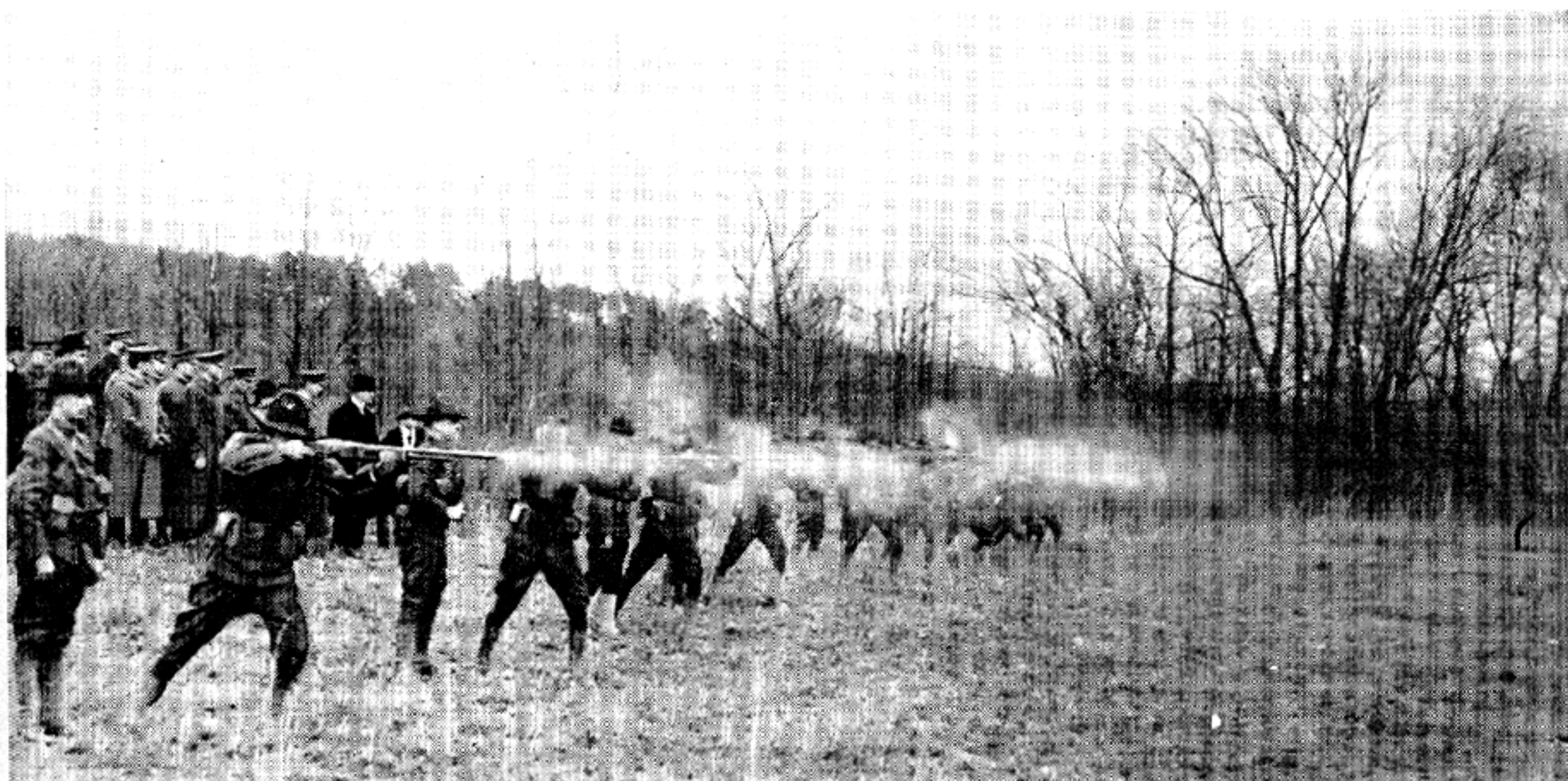

A Demonstration of the B. A. R. in 1918.

facturing procedures were altered to bring the weapon up to specifications. At the end of the war the Winchester Co. was producing 300 B. A. R.'s a day. A total of 63,000 items was canceled at the time of the Armistice.

The Marlin-Rockwell Corp. intended originally to use the Hopkins and Allen Co. plant for the construction of this weapon, but found that a contract for making rifles for the Belgian Government fully occupied its facilities. The corporation then acquired the Mayo Radiator Co.'s factory for use in its contract to produce the B. A. R. The first gun from this source was made on 11 June 1918, and by 11 November 1918 the company was turning out 200 automatic rifles a day. The postwar cancellation was 93,000 weapons.

The Colt Co., because of the heavy demands of previous orders, produced only 9,000 B. A. R.'s. The combined daily production by all companies was 706 and a total of approximately 52,000 rifles was delivered by all sources.

In July 1918 the B. A. R.'s arrived in France in the hands of the United States 79th Division, which was the first organization to be equipped with them and took them into action on 13 September 1918. The 80th Division was the first American Division already in France to be is-

sued the weapons. It is an interesting fact that First Lt. Val Browning, son of the inventor, personally demonstrated the weapon against the enemy.

The B. A. R. was more enthusiastically received in Europe than the heavy water-cooled gun, and requests for purchase by all the Allied Governments were made immediately after it arrived overseas. The French Government alone asked for 15,000 to take the place of the inferior machine rifle, then being used by both French and American troops. The latter weapon was found so unreliable that many were actually thrown away by troops during action.

However, the war ended so soon after this that the bulk of the American forces were still equipped with machine guns supplied by the British and French.

### Browning Caliber .50 Machine Gun

The Browning caliber .30 machine guns had scarcely been introduced overseas when a larger weapon was demanded by the commanding officer of the American Expeditionary Forces, Gen. John J. Pershing, who had observed the rapid advances of the British and French in raising their machine gun caliber from .303 and 8 mm to

caliber .50 and above. This change was considered vital in order to be able to penetrate the armor that was beginning to make its appearance on combat vehicles, tanks, and in some cases, the individual soldier. The smaller bullet was no longer considered completely effective against such targets.

At the United States Army machine gun school at Gonducourt, France, the officer-in-charge, Col. John Henry Parker, had noted the deadliness of the 11-mm incendiary, armor-piercing bullets used in lately developed French weapons to penetrate armor and ignite hydrogen-filled observation balloons. He learned from a liaison officer that a French proving ground had two prototype machine guns, entirely new in principle, that successfully fired a bullet and powder charge even larger than the 11-mm one.

Colonel Parker, always a man of action, detailed Capt. Henry B. Allen to look into the situation and secure as much information as possible. The weapons were located at Bourges Arsenal and arrangements were made for Captain Allen to take one of the guns to the United States for study.

The American Army's ordnance engineers had tried earlier to meet the increased caliber de-

mand by rechambering a caliber .30 heavy (water-cooled) barrel to take the French 11-mm cartridge. The attempted quick-fix met with only fair success, because of the great difference in the ballistic characteristics of the two cartridges that were to operate the same mechanism. Nevertheless the Army Ordnance Department gave an experimental order to Colt for eight guns to be rechambered in this manner for the 11-mm shell.

By this time the French gun secured by Captain Allen had arrived and, after being thoroughly checked, it was decided that its velocity was too low to meet General Pershing's demands. He had specified that the bullet should weigh not less than 670 grains with a muzzle velocity of at least 2,700 feet per second. The French ammunition could not approach this and all work on machine guns to fire 11-mm cartridges was consequently dropped.

As early as July 1917, John M. Browning, using the facilities of the Colt plant, undertook the problem of increasing the caliber of his machine gun, while keeping its simplicity of construction and all basic operating features.

The Winchester Repeating Arms Co., in cooperation with Browning, attempted to develop a suitable cartridge. Winchester, forced by the ever-present time element, scaled up the present caliber .30/06 case, but put a rim on it in hopes it could be used in both the machine gun and the clip-fed, belt-action, anti-tank rifle it was manufacturing at the time.

When the specification for this ammunition was delivered to General Pershing, he cabled the Ordnance Department on 18 July 1918 rejecting the Winchester cartridge, and ordered that the case be immediately redesigned to be rimless.

Winchester followed instructions and sent a dummy round for Browning to use in his mock-up, then under way at the Colt plant. This was a prototype that retained all the mechanical features of the caliber .30 gun, but possessed larger physical proportions to stand the increased powder pressures.

To expedite the project, Browning took his original gun to the Winchester Co. for experimental single-shot firing in order to determine

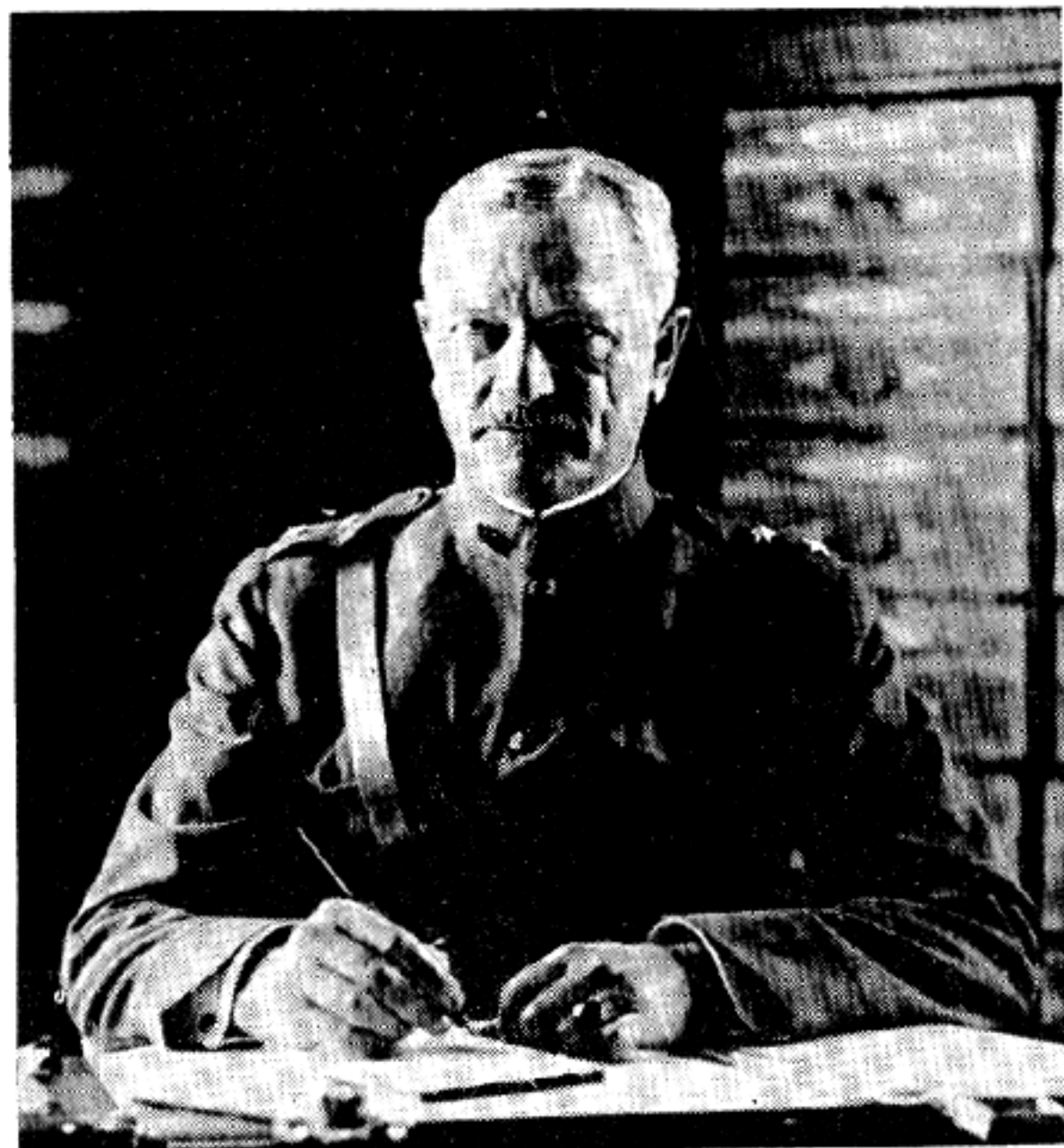

General John J. Pershing, Whose Specifications Resulted in the Cal. .50 Machine Gun.

quickly a balanced load that would give the greatest velocity and the minimum strain on the component parts. The work progressed so well that although the weapon was originally started at Colt's, he decided to stay on at Winchester to develop it.

On 12 September 1918 Browning received from the Colt Co. all the parts it had completed to date, allowing him to assemble finally the first caliber .50 machine gun. Winchester agreed to start the construction of six more guns. This was deemed to be a sufficient number to permit the endurance tests that are necessary to detect and eliminate the various errors of design in any new weapon.

On 15 October 1918 the first caliber .50 machine gun was ready for the proving ground.

Upon its initial attempt the weapon fired 877 rounds in bursts of 100 to 150 rounds each. The rate of fire was under 500 rounds per minute. The five and a quarter inch cartridge had a 707-grain bullet that developed a velocity of less than 2,300 feet a second. This velocity was also under the minimum set by General Pershing.

Impressed by the test, the Engineering Division of the Office of Chief of Ordnance recommended that Winchester be given an order for 10,000 guns. The original model was water cooled and had only a 30.5-inch barrel, the longest that Winchester was then equipped to rifle. The Ordnance Department was assured that a better balanced powder charge and a longer barrel would bring the velocity up to the required specifications and that this would be accom-



A Rare Photograph of John M. Browning's Work Shop with an Early Model Cal. .50 Machine Gun.



plished long before the delivery of the weapons on order.

The gun, in later tests conducted by the infantry, was found to be extremely difficult to keep on a target when fired full automatic, as the energy developed was so much greater than that of the smaller bore weapon. It was practically impossible to hold the gun down for horizontal fire. The weight of the gun and tripod was about 160 pounds, a fact that made quick mobility extremely difficult. For these reasons, strictly as an infantry arm the weapon did not meet with approval. And for tank use it was not overly successful, since the rate of fire was too slow for anti-personnel use and the bullet was too small to penetrate the thicker armor on the late model tanks. Before the weapon had gotten too far along in development, a few German anti-tank rifles were captured, together with some 12.7-mm ammunition. It was found that the Germans were getting a muzzle velocity in excess of 2,700 feet a second with an 800-grain

bullet that would penetrate one inch of armor at 250 yards.

Not to be outnoded before completion, Winchester immediately increased the penetration requirements of the caliber .50 under development to conform to the identical ballistic properties of the German anti-tank rifle cartridge.

One important deviation that Browning made from the caliber .30 mechanism was in the addition of an oil buffer. It was employed for a dual purpose: first, to absorb the excess energy of the recoiling parts resulting from use of an increased powder charge; and second, to provide a method of regulating the firing speed. The oil buffer tube could be turned to any required position for opening or closing the valve. When the oil flow was restricted, the buffer absorbed more recoil and reduced the rate of fire.

On 1 December 1918 the Ordnance Department decided that all future development of the caliber .50 ammunition would be done at Frankford Arsenal instead of at the Winchester plant.



John M. Browning Firing His Cal. .50 Machine Gun in Colt's Pasture.



Products of John M. Browning's Genius.

This did not take effect immediately, as Winchester continued to furnish caliber .50 ball ammunition to the Government all through 1918 and 1919, until production at Frankford reached a point where it was felt that it could take over. The Arsenal did very little to alter Winchester's established load and weight dimensions for the powder charge and projectile that in turn had been copied from the German 12.7-mm anti-tank rifle cartridge. The latter developed a maximum chamber pressure of 52,000 pounds and a muzzle velocity of 2,750 feet per second.

Browning incorporated a few minor features in this weapon that are not to be found in his small caliber automatic machine guns. For instance, a latch located at the upper rear of the receiver securely held the bolt in the rear position. In lieu of the pistol grip of the smaller gun, the caliber .50 was provided with a double spade grip attached to the back plate. The back plate also housed the bolt latch release and the thumb piece that actuated the trigger bar. When the weapon was fired from the latch-back position, thumb pressure released the latch mechanism, allowing the bolt to drive forward under compression from the driving springs. If continued pressure of the thumb on the scar release was applied, the weapon would fire automatic as long as this condition remained.

The head space adjustment, the most important feature in the Browning caliber .30 machine gun, was retained. This critical feature could be regulated in the field by the most inexperienced ordnance man by the simple use of gages. The original water-cooled gun without the mount weighed 82 pounds when the 16-pint jacket was filled. The barrel rode in close-fitting bearings at the muzzle and breech, packed with

fabric washers to allow it to recoil freely without leaking.

The total time consumed by John M. Browning on the caliber .50 machine gun from conception to successful firing was slightly over a year. When asked by the press to what he attributed his achievement, he replied, "One drop of genius in a barrel of sweat wrought the miracle."

Browning can surely be called a self-made man. He had no formal education except a few months now and then when he could be spared by his father. He picked up a fair working knowledge of French in the course of his work at the Fabrique Nationale in Belgium in his later years. His thorough knowledge of mechanical drawing, mathematics, and manufacturing procedure was gained simply by observation in the course of developing his designs through model room to production line.

He died suddenly at Liège, Belgium, on 26 November 1926 while supervising the manufacture of arms of his own design. In a long eulogy delivered by the Honorable Dwight F. Davis, Secretary of War at the time, the following words were used:

"It is a fact to be recorded that no design of Mr. Browning's has ever proved a failure, nor has any model been discontinued. The War Department, through its agency, the Ordnance Department of the Army, will be greatly handicapped in its future development work on automatic firearms as a result of the loss of Mr. Browning's services. It is not thought that any other individual has contributed so much to the national security of this country as Mr. Browning in the development of our machine guns and our automatic weapons to a state of military efficiency surpassing that of all nations."

# HOTCHKISS AUTOMATIC MACHINE GUNS

## Background

After the successful efforts of Hiram Stevens Maxim to produce a weapon that delivered sustained fire from the generated energy of its recoil forces, inventors of all countries tried to design firing mechanisms that were capable of duplicating this act without infringing on Maxim's patents. One of the most effective European attempts to accomplish this was made by a young Viennese nobleman and officer in the Austrian Army, Capt. Baron Adolph von Odkolek, who constructed a prototype gas-operated automatic machine gun. Seeking a market for his invention, he brought it in 1893 to the Hotchkiss gun manufacturing plant at St. Denis, France, just outside the city limits of Paris, in hopes he could interest this already world-famous establishment in producing his weapon.

The company at this time was in a very disorganized state. It had flourished when the manually operated revolving cannons it produced were purchased by almost every major power in the world. In 1884 the business of the firm having outgrown the capacity of the St. Denis factory, connection was made with William Armstrong & Co. for manufacture of Hotchkiss material at the Elswick works in England. The following year the founder and president, Mr. B. B. Hotchkiss, died and by 1887 the parent branch was reorganized under the name of Société Anonyme des Anciens Etablissements, Hotchkiss et Cie. with offices at 21 Rue Royale, Paris, and the English plant under the firm name of Hotchkiss Ordnance Company, Limited, with offices at 25 Victoria Street, London. The management of both firms was under the control of the French office.

In the same year, the stockholders decided to appoint as head engineer and promotion manager an American, Laurence V. Benét, who had been connected with the company prior to the

death of Mr. Hotchkiss. Few men of his age had a more qualifying background for this kind of work. His father, Gen. S. V. Benét, the United States Army's Chief of Ordnance following the Civil War, was famous for his progressive development of cartridge case and primer design that contributed greatly to the early successes of the Gatling and other manually operated machine guns.

General Benét was very ambitious for his son's future and realized better than any one else the difficulties of earning a living in the United States in the machine gun field. He advised his son to go to France and seek out his friend, B. B. Hotchkiss, for employment in a field where the products of his labor would not only be appreciated but also result in financial gain.

Hotchkiss was delighted to have the services of this brilliant young man, already a recognized authority on certain types of artillery, particularly at a time when Maxim's introduction of the full automatic gun had made obsolete the manually operated weapons then being manufactured. He hoped that Benét would be able to carry the Hotchkiss Co. through this transition period from manual operation to full automatic. But before anything had been settled upon as the optimum automatic weapon, Hotchkiss died and reorganization followed, with Benét as the man in charge of the company's future policy.

Laurence Benét showed from the start a talent not only for gun design but also for choosing good associates. A very interesting sidelight in this connection was his affiliation with Henri A. Mercié, who was selected as his chief assistant.

When the Hotchkiss plant was being built, everything went along smoothly until a power source was installed. The machinery on hand was found to require far more energy than anticipated by the plans. The French Government, anxious to assist the plant in every way possible, offered the loan of a railway locomotive as an

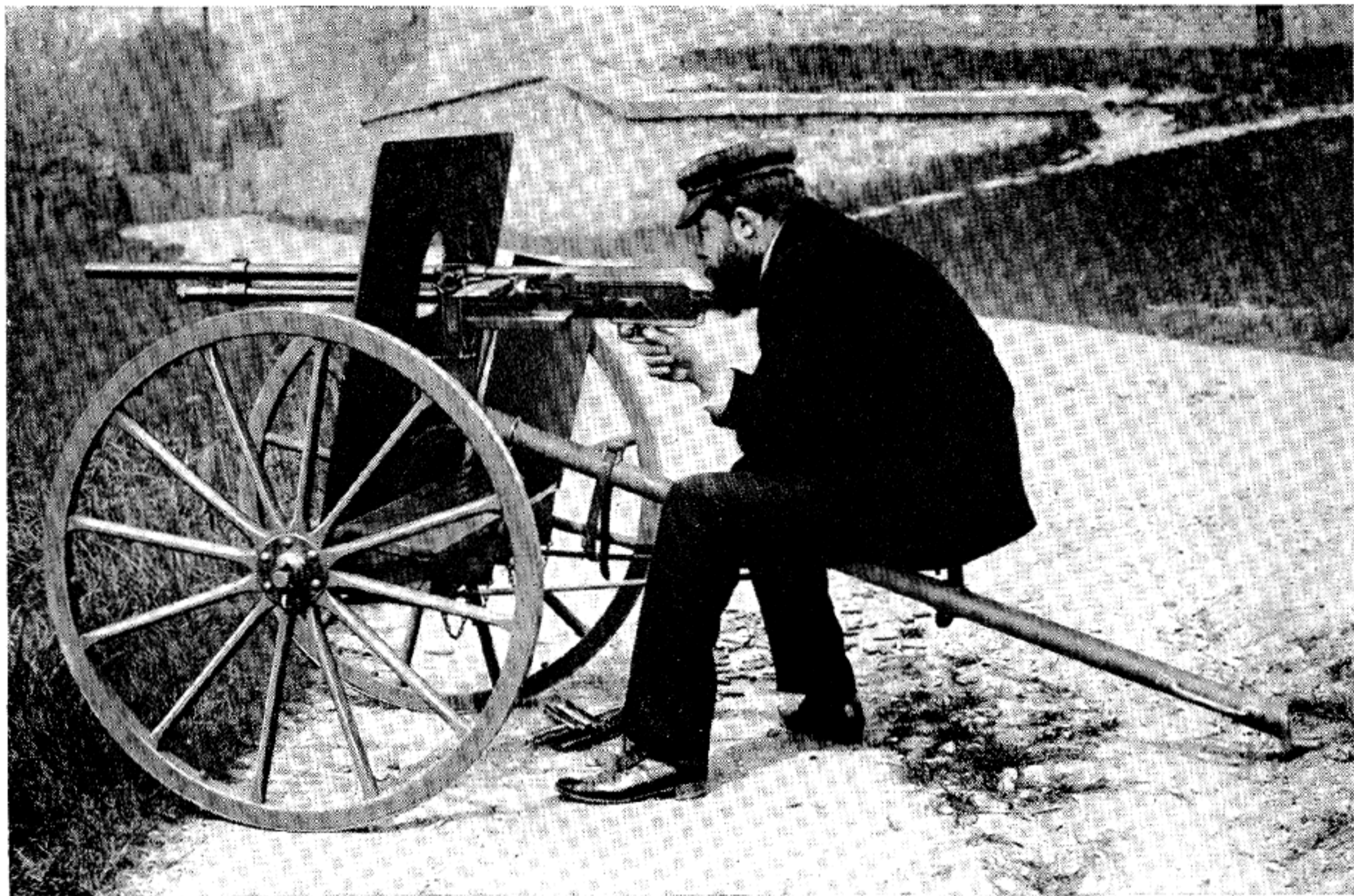

Laurence V. Benét Firing the First Model Hotchkiss Machine Gun.

auxiliary power supply until a more permanent one could be arranged. In due time the locomotive arrived and was placed adjacent to the buildings housing the steam-driven machinery. To operate this stationary engine, the railroad supplied an elderly engineer named Mercié and his son, Henri, who was serving as an apprentice.

Young Mercié showed such natural aptitude in solving the many problems that faced this makeshift arrangement that Benét never forgot it. At the first opportunity, he offered him a place high in the management of the company, an act that not only showed Benét's sound judgment but later added much to the success of a company that was trying to regain a world market.

### Hotchkiss Machine Gun

Captain Odkolek appeared at this time with his prototype machine gun under conditions that an inventor too often fails to encounter. He had

unconsciously picked a moment when there was a demand for just the type of weapon he had brought along to show the business executives of Hotchkiss.

Benét and Mercié saw certain basic principles in the model which could be employed in building a reliable and efficient machine gun. As for Odkolek's weapon itself, they thought little of it and firing tests at the plant later proved their judgment to be right. But the one thing covered by his patent claims which they desired was the operation of a simple mechanism by a housed piston fastened beneath the barrel.

The Hotchkiss Co. refused to make Odkolek's weapon on a royalty basis, but offered to buy the patent outright in order to use certain desirable features. The inventor agreed to this, accepting a lump sum for assigning all manufacturing rights to the company.

Benét and his assistants immediately began refinement and development of the principles sold them until they had produced a weapon

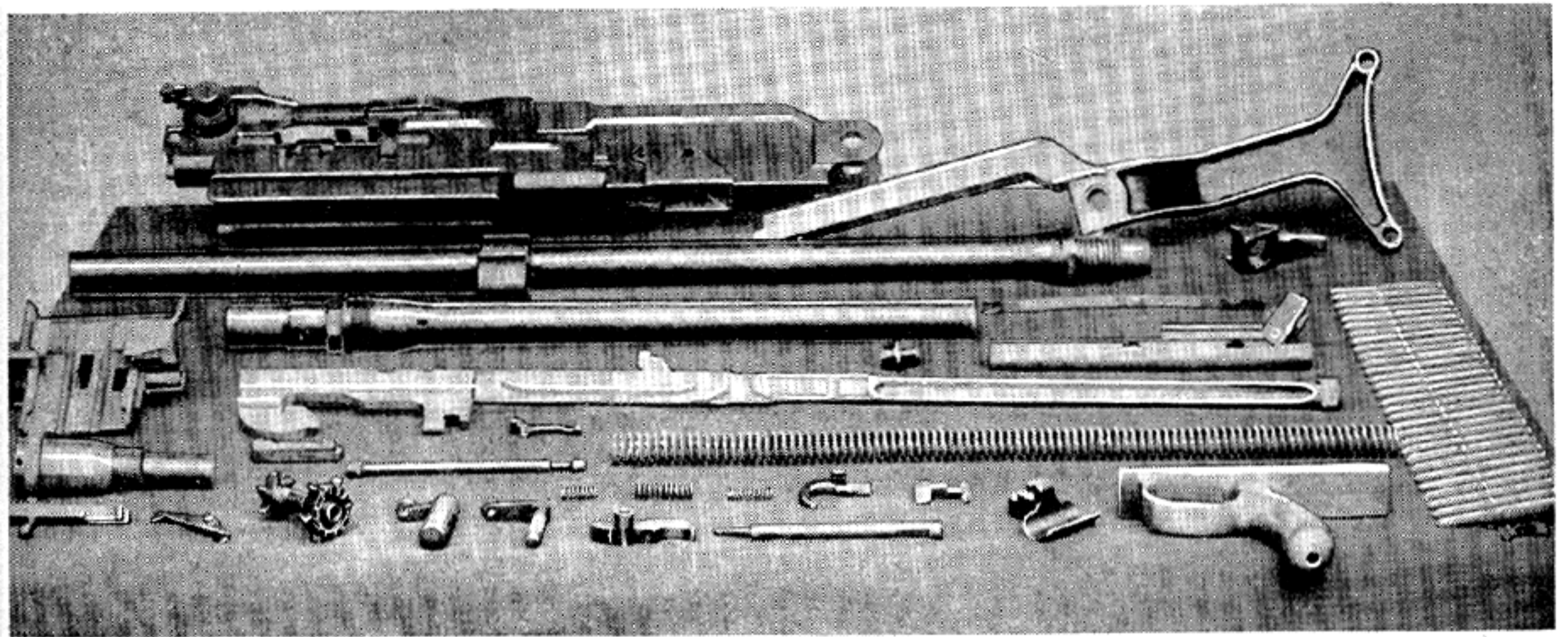

Components of Hotchkiss First Model Gun.

which in their opinion would give competition to any in the world without infringement of patents. The redesigned gun, chambered for the 8-mm Lebel cartridge, was strictly gas-operated and employed a simple reciprocating piston, instead of a swinging lever, as did Browning's gas-operated Colt machine gun. As a tribute to the founder of the company, the finished product was named "the Hotchkiss."

The first of these guns was tested at the St. Denis factory by Laurence Benét in 1895. While the mechanical features held up even better than anticipated, there was a tendency for the heavy barrel to overheat and after a relatively small number of rounds the rifling was destroyed.

Benét's alert mind quickly found a solution for this problem. He realized that a mass of metal toward the breech end of the barrel was necessary to absorb the great amount of heat generated at this point. But instead of adding to the solid metal, which would make the weight of the gun prohibitive, he formed heavy circular doughnut-shaped fins at the critical heating places. The fins added little weight and gave more than ten times the original radiating surface for air cooling. This feature, which proved so successful, has been identified with the Hotchkiss gun so long that the slightest change in its design is noted immediately by those familiar with it.

The following description is derived from a contemporary Hotchkiss pamphlet on the first

model. It outlines the simple operation and improved features that distinguished the weapon from the conventional belt-fed, water-cooled, recoil-actuated machine gun of that day.

The first round is loaded by hand, after which the operations of feeding, firing, extracting, and ejecting are carried on automatically but under complete control of the operator. Slow automatic fire may be delivered at any rate up to about 100 rounds per minute, and rapid fire at the rate of 500 to 600 rounds per minute.

The weapon's single barrel is securely fastened to the breech, allowing none of the moving parts to be subjected to the heat developed by the powder gas. Consequently a water jacket or any other cooling device is superfluous, and the gun may be fired indefinitely without danger of jams from expanded parts. The design is extremely simple, comprising 38 parts in all, exclusive of the sights, but including barrel, shoulder-piece, etc. In the whole mechanism there are but four springs, viz: main, sear, extractor, and pawl springs, and no screws. With the exception of the barrel and the cylinder, the gun may be completely dismounted and assembled without tools, a wrench being necessary for these two parts only.

Beneath and parallel to the barrel is fixed a small cylinder, which is in communication with the bore through a port drilled through the barrel a few calibers from the muzzle. To the rear of the cylinder is an exhaust port opening to vent

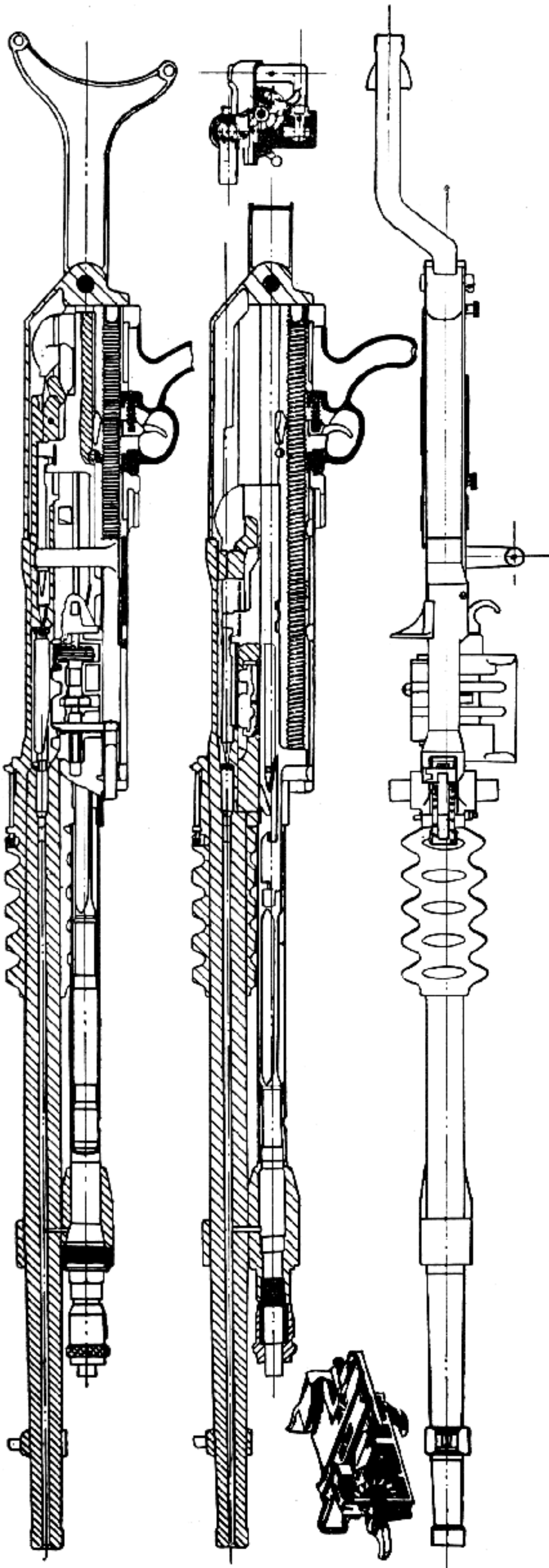

Section Drawing of Hotchkiss Machine Gun, Model 1897.

off this gas. On the discharge of the gun, as soon as the bullet has passed the port connecting bore and cylinder, the powder gas enters the latter throwing a long piston to the rear. When the piston has recoiled a given distance, the exhaust port is uncovered, permitting the gas to escape, and the piston is held in its backward position by an ordinary sear. On releasing the latter, the piston is thrown forward to its original position by the mainspring. It is obvious that if the sear is held out of engagement by the trigger and the supply of cartridges is kept up, the piston will have a constant and automatic reciprocating motion. The piston engages with the breechblock, which is somewhat similar to the original Lee rifle straight-pull bolt. Its motion opens and closes the breech, unlocks and locks the bolt, and fires; performing, in other words, the function of the soldier's hand when operating a straight-pull rifle.

Instead of feeding ammunition in fabric belts, the Hotchkiss uses metal strips. The cartridges are packed in these clips, each containing 30 rounds, and having a length of about 15 inches. Each loaded strip is in an ordinary pasteboard box, from which, when opened, it may be fed directly to the gun. The feed mechanism consists of a spur wheel, which engages in cams cut in the piston, and in openings formed in the clip. It is so arranged that the feed strip may be engaged, with breech either open or closed. The strips being so constructed as to lock one with another, a series may be fired without the necessity of cocking the gun each time by hand.

To the breech is fitted a shoulderpiece, or stock, which the operator brings to his right shoulder, and the sear is controlled by a trigger mounted in a pistol grip. Aiming and firing are therefore carried out, as in all Hotchkiss guns, with the same facility as when firing a rifle from a rest. A safety lock is fitted to the piston, by which the mechanism may be secured with the breech closed or open, as may be desired.

It is an interesting bit of ordnance history that the United States Navy tested the original Hotchkiss machine gun before any model number had ever been assigned. This test took place on 3 January 1896, at which time the weapon failed due to improper heat treatment of components and poor choice of metals in construction. At the suggestion of the Navy, the Hotchkiss Co. em-

ployed Mr. Edward G. Parkhurst, of Hartford, Conn., to correct the manufacturing errors that caused the gun to fail.

Parkhurst, who had done such outstanding work on the Gardner manually operated machine gun, suggested certain changes in design and submitted them to the company, which not only used the ideas but thanked him through the Navy Department for his contribution.

The improved gun then came out as the Hotchkiss '97 model and has been basic ever since. As no water jacket was employed, the weapon's weight was held at about 20 pounds.

To prepare the '97 model gun for firing, the operator turns the lever of the cocking handle upward and to the left as far as it will go. The ribs on the collar in the guard are then opposite the closed grooves in the cocking handle, while the lugs on the head of the latter are engaged in front of the collar in the piston rod. After pulling the cocking handle smartly rearward to its full extent, the operator then pushes it forward, still keeping the lever slightly to the left of vertical. When it is fully home, the lever is set at an indicator according to the nature of fire desired. The weapon is now ready to fire.

A pull on the trigger releases the sear latch on the under side of the piston. The energy of the recoil spring then forces the piston forward. The lug of the firing pin resting between the firing-pin projection and the breechblock tang of the piston is held back in this safe position. The nose of the piston bearing against the breechblock lock carries this part forward. The front face of this piece forces the forward end of the ejector out of the path of the operating mechanism. The lower part of the breechblock face strikes the base of the cartridge, stripping it from the feed clip and driving it forward into the chamber.

The feed wheel is advanced through the first half of the feeding movement by the action of the large feed cam of the piston against an operating lug on the wheel's ratchet. The cartridge-holding pawl is then engaged by the ratchet, thus preventing rebound. As the breech lock chambers the round, the extractor cams itself over the rim of the cartridge. The breechblock lock is in position above the recoil block in the receiver and is now free to lock. This movement is against the cam surface of the

breechblock lock, causing its rear end to tilt up in front of the recoil blocks.

The piston continues forward, carrying the firing pin which detonates the primer in the cartridge. After the explosion of the powder charge in the cartridge and before the bullet has cleared the muzzle, it passes a gas port in the barrel. The gases expand through this orifice into the gas chamber and impinge against the head of the piston forcing it to the rear. This action compresses the recoil spring and stores up energy for counter recoil.

The piston withdraws the firing pin from the primer, as the lower cam of the breechblock lock on the upper cam surface of the piston raises the lock clear of the recoil blocks. The breechblock tang on the piston strikes the rear shoulder of the breechblock and carries it back. The extractor withdraws the empty shell from the chamber, while the rear end of the ejector rides out of its groove in the breechblock. The front end is thus pivoted into the path of the cartridge, striking it at its base and throwing the empty case clear of the slot in the receiver and to the right.

The small feed cam on the piston now completes the rotation of the feed wheel and places the next cartridge in position above the stripping finger, while the feed-wheel pawl engages the feed-wheel ratchet and prevents rebound. This backward motion is limited by the rear end of the piston striking its buffer. If the trigger is still held back manually or by the automatic trigger catch, the mechanism starts immediately on its forward motion. If, however, the trigger has been released, it springs up and engages the sear notch of the piston, holding the gun in a cocked-bolt position. When the feed strip has been fed entirely through, it allows the upper lug of the arrester catch to engage the lug on the piston. This locks the piston back so as to allow loading of the next strip.

Laurence Benét retained his American citizenship throughout his connection with the Hotchkiss Co. and at the outbreak of the Spanish-American War he returned to this country, serving in the United States Navy with the rank of ensign. At the end of hostilities he went back to his duties in France with the Hotchkiss Co. The French Government in the meantime had purchased a limited number of the Hotchkiss,



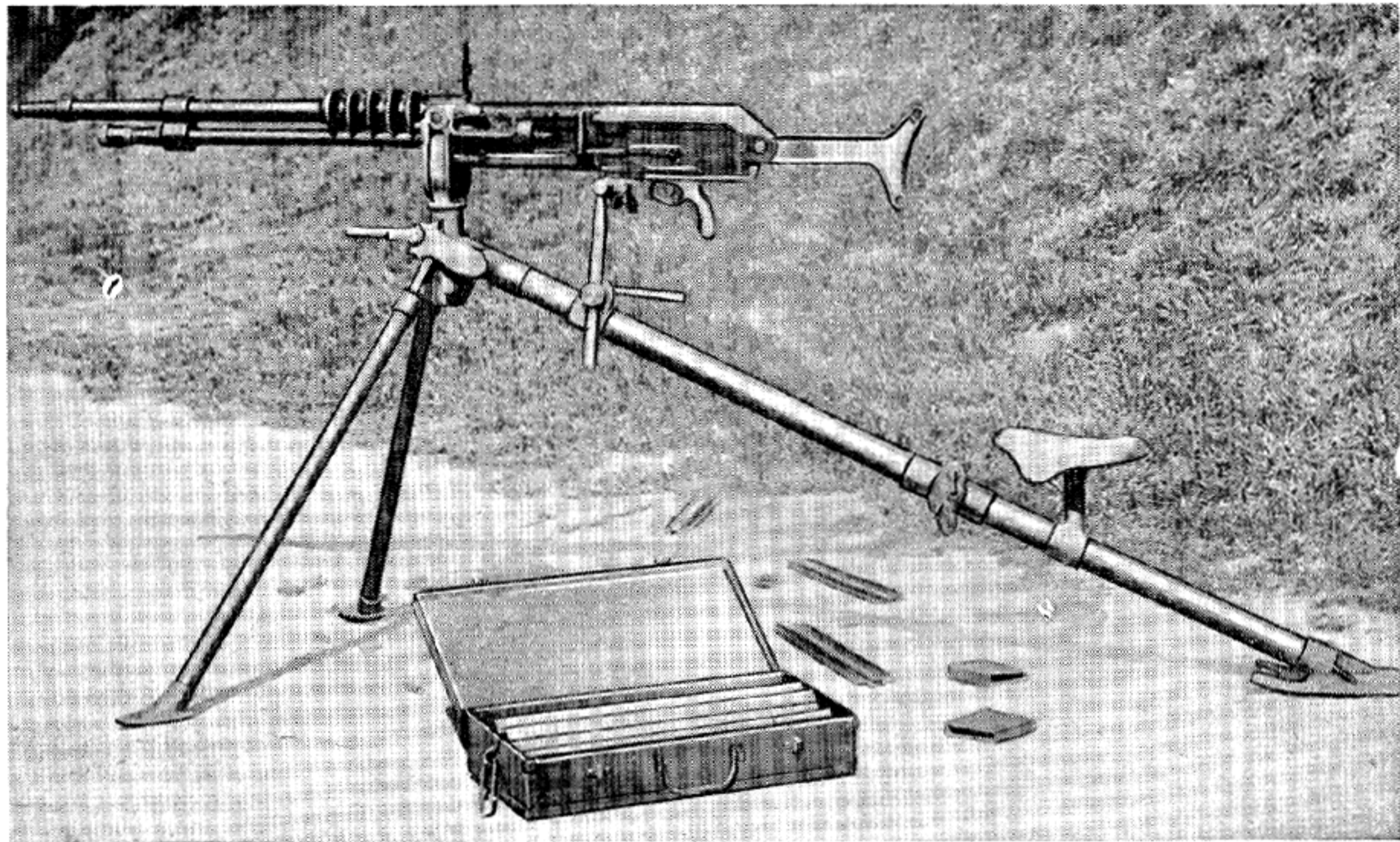

Hotchkiss Machine Gun Model 1897.

model '97, for its armed services. Its military leaders looked with great favor on the weapon's air-cooled feature, as desert warfare was at its height in the African colonies, where cooling by water would have been a serious problem.

A modified version, known as the Hotchkiss 1900 model, appeared at the turn of the century. The so-called improvements consisted more in refinement of the mount than in the weapon itself. The only changes in the gun were the substitution of circular steel cooling fins in lieu of the brass ones and a barrel designed to withstand the terrific heat resulting from long bursts.

This model with its added features was tested at Springfield Armory by an Army board on 3 May 1900. The purpose was to determine whether the new barrel would pass the rigorous endurance test that was based on performance of water-cooled guns. The barrel was made with only 0.020 percent carbon, but with 5 percent nickel added, and was considered by its creators as being far superior to former barrels made with a high carbon content.

The physical properties of the new barrel were as follows: Tensile strength, 98,730 pounds

per square inch; elastic limit, 48,800 pounds per square inch; percent elongation, 15.3; percent reduction of area at fracture, 41. The ammunition used throughout the trial was of Frankford Arsenal manufacture with a velocity of 2,200 feet per second. The propellant charge was 36 grains of Peyton smokeless powder.

Firing commenced at 10:47 a. m. and the weapon successfully expended 1,376 rounds in 4 minutes and 10 seconds before a serious stoppage was caused by the jarring of a cartridge out of the feed strip which jammed the mechanism. This necessitated removal of the bolt to clear the malfunction.

The officers observed that after 2 minutes and 20 seconds of continuous firing the barrel showed a dull red and at the end of the 4 minutes and 10 second burst it was bright red from the radial cooling fins to the muzzle end.

At 10:56 firing was resumed and a burst of 848 rounds was completed before another stoppage took place, again caused by a cartridge falling prematurely from the feed strip into the mechanism.

The barrel already having been heated to a



Hotchkiss Machine Gun, Model 1903. The First Hotchkiss Gun to Use a Belt Feed.

very high degree from the previous firing, it was noted that in 1 minute and 8 seconds it showed a dark red, and before the end of the 848 rounds of sustained fire it was again a bright red.

Upon examination of the working components, there was evidence of much fouling in the receiver, while all the oil had been burned away from the forward part of the piece. These parts were working sluggishly when charged back and forth by hand. A total of 2,224 cartridges had been fired in 6 minutes and 8 seconds of actual firing time.

As the mechanism showed such fouling, it was decided by the board to allow the barrel to cool so it could be checked for both fouling and erosion. When examined, it was found that erosion began just in front of the chamber, with the rifling showing noticeable wearing away to a point aft of the gas port. The forward portion of the rifling showed very little wear.

When the weapon was reassembled, the cocking piece worked hard and further examination showed it to be sprung out of shape and "considerable filing and hammering had to be done before it could be made to work freely again."

After lunch, firing was resumed at 2:29 p. m., at which time 773 rounds were discharged. A lug on the gas piston then broke, stopping the weapon. The time consumed was 2 minutes and 5 seconds. A new piston was substituted for the broken one and firing was resumed. The first round jammed the mechanism in the act of feeding. The officers held that the round had been jarred out of the strip when the piston change was made. When this malfunction was cleared, the test continued. After 750 rounds were fired on this attempt, the extractor failed to pull the empty cartridge case from the chamber. When the case was removed and firing commenced, it was found that the extractor had failed at this point and a new one was substituted.

The remainder of the ammunition that had been put into the feed strips, 816 rounds in all, was then fired without incident, making a total expenditure of 4,500 rounds.

The weapon was then disassembled and all components were examined thoroughly for excessive wear or signs of breakage. None were found to be unserviceable, and, with the exception of the piston lug and the extractor, all parts

finished the test in serviceable condition. The barrel was ordered sawed in half. Slight erosion was found, although the rifling was practically worn away from breech to muzzle end. The sawed portion of the barrel was photographed as a record of the event.

The Army report concludes as follows:

"The system of feeding the cartridges into the gun by the use of metal feed strips has not shown itself to be as satisfactory as a canvas belt feed, but the advantages of having an additional source of supply in case of emergency would, in the opinion of the board, warrant the use of this gun in addition to the Maxim and Colt, both of which have already been reported upon as being suitable for adoption."

The members of the board were: John E. Greer, Major, Ordnance Department, U. S. A., president; Jno. T. Thompson, Captain, Ordnance Department, U. S. A.; and Odus C. Horney, Captain, Ordnance Department, U. S. A., Recorder.

In approving the report, Lt. Col. Frank H. Phipps, commanding officer at Springfield Armory, added:

"These tests seem to indicate conclusively that a high percent of carbon in a gun-barrel steel shortens the efficient life of the barrel.

"The rapidity of fire in this test was greatly in excess of what it would be in service; the great heat generated caused the wearing away of the rifling before the completion of 4,500 rounds.

"The desirability of a water jacket for automatic guns has been demonstrated by the tests of the board."

The Russo-Japanese War (1904-05) was the first conflict between major powers in which machine guns were employed by each participant. The Russians were equipped with Maxims, while the Japanese had the Hotchkiss. The deadliness of machine-gun fire was demonstrated time and again by the two armies using these different types of automatic weapons.

### Puteaux and St. Etienne Machine Guns

Since 1900 French Army officers had worked continuously on refinements that in their opinion would result in the ultimate in machine guns. The National Arsenal at Puteaux pro-

duced in 1905 a version that used a modified version of the Hotchkiss system. The normal rate of fire was 500 rounds per minute but the gun had a device that permitted regulation of the cycle of operation from eight shots a minute minimum to 650 maximum. The weapon had a series of brass circular fins that extended from the breech to the muzzle of the barrel. It was issued to French colonial troops in 1906 but was never as popular as the standard Hotchkiss, over which it was supposedly an improvement. It was soon relegated to reserve units and fortifications. The latter use was so widespread that it is sometimes erroneously known as the "Fortification model."

In another attempt to improve existing machine guns, the officers at the St. Etienne Arsenal in France made what is known as the 1907 model St. Etienne. This weapon was a compromise between the Puteaux 1905 and the Hotchkiss 1900. However, the gun used one of the most unusual methods of operation yet to be developed. While it was gas actuated by means of a piston, the French reversed the conventional principle.

Instead of the piston thrust rearward furnishing the source of energy to operate the piece, the gas propels the piston forward to unlock the bolt. The piston is attached by a spring-loaded rod to a gear rack. This in turn engages a spur gear which is fastened to an actuating lever. When the lever is in the forward horizontal position and engages a cam slot in the bolt, the gun is locked. Upon firing, the gas drives the piston forward, compressing the spring and causing the spur gear to rotate clockwise. The actuating lever turns with the gear for a half revolution, retracting the bolt and stopping at the rear horizontal position. The driving spring then forces the piston rearward, which reverses the action and returns the bolt to battery.

The weapon is readily distinguishable by the heavy brass casting of the barrel receiver. The actuating spring, located under the barrel and behind the gas piston, is always visible, as the heat from its close proximity to the barrel would destroy its life if housed.

It is of interest that Baron von Odkolek, whose original patents were the basis of the Hotchkiss weapon, attempted to produce another machine

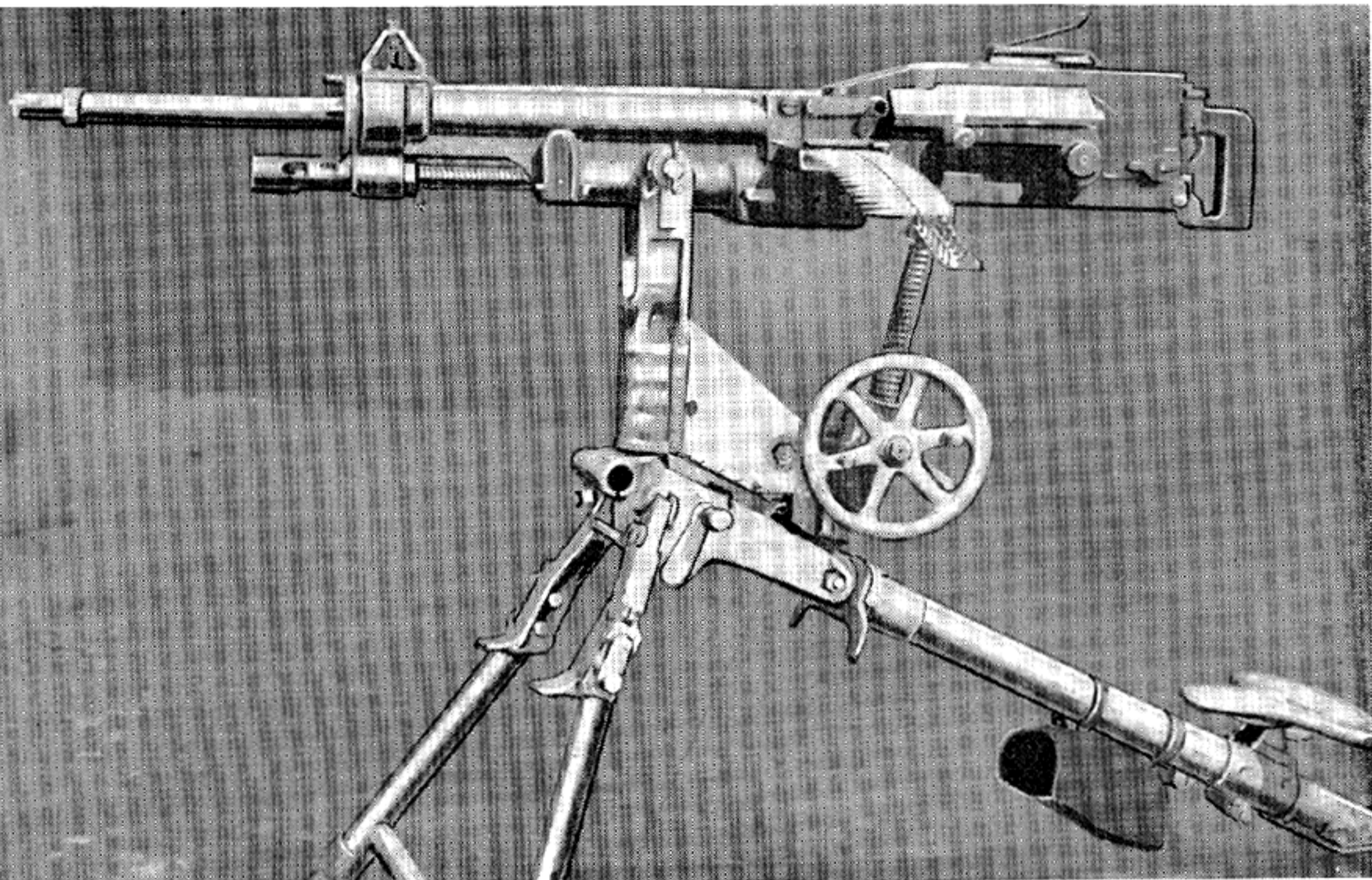

St. Etienne Machine Gun, Model 1907.

gun during this period. In order to stay clear of his already assigned patents, he resorted to features that were unusual from an engineering standpoint.

For instance, the weapon was both water cooled and gas operated. In order to cover the barrel and gas piston cylinder with a water jacket that would not allow the liquid to leak into the critical gas-cylinder chamber, he constructed the barrel and gas-cylinder chamber out of one piece, by turning the muzzle and breech ends eccentric. This method allowed a sufficient mass of metal, which was offset from the breech end and was an integral part of the barrel, to house the gas-cylinder chamber.

The gas cylinder was located on top, instead of on the underside, of the barrel. This 180° turn no doubt was intended to help make the model look more original. However, a close examination shows that the operating mechanism was very similar to the prototype weapon submitted to the Hotchkiss Co. in 1893.

The feed was the only radically different feature, for in lieu of brass strips of 30 cartridges

each, he used a drum and reel arrangement, on which 250 cartridges were attached to a belt made of light and flexible brass. The Odkolek weapon was never recognized and did not progress beyond its prototype stage.

### Benét-Mercié Machine Rifle

The French Army ordnance engineers at the government arsenals, in their attempts to produce an all-purpose machine gun modeled on the Hotchkiss, had succeeded only in developing two weapons of questionable merit. In 1909 another modification appeared, a highly portable machine gun developed by the Hotchkiss Co. It differed in a mechanical way from the 1900 and 1907 guns only in the means of closing the breech, and the upside-down introduction of the feed clip from the right side, so that the cartridges were underneath the clip. This was just the reverse of earlier models. The gun was even simpler in construction than its predecessors, having only 25 parts.

This weapon was the joint effort of Laurence

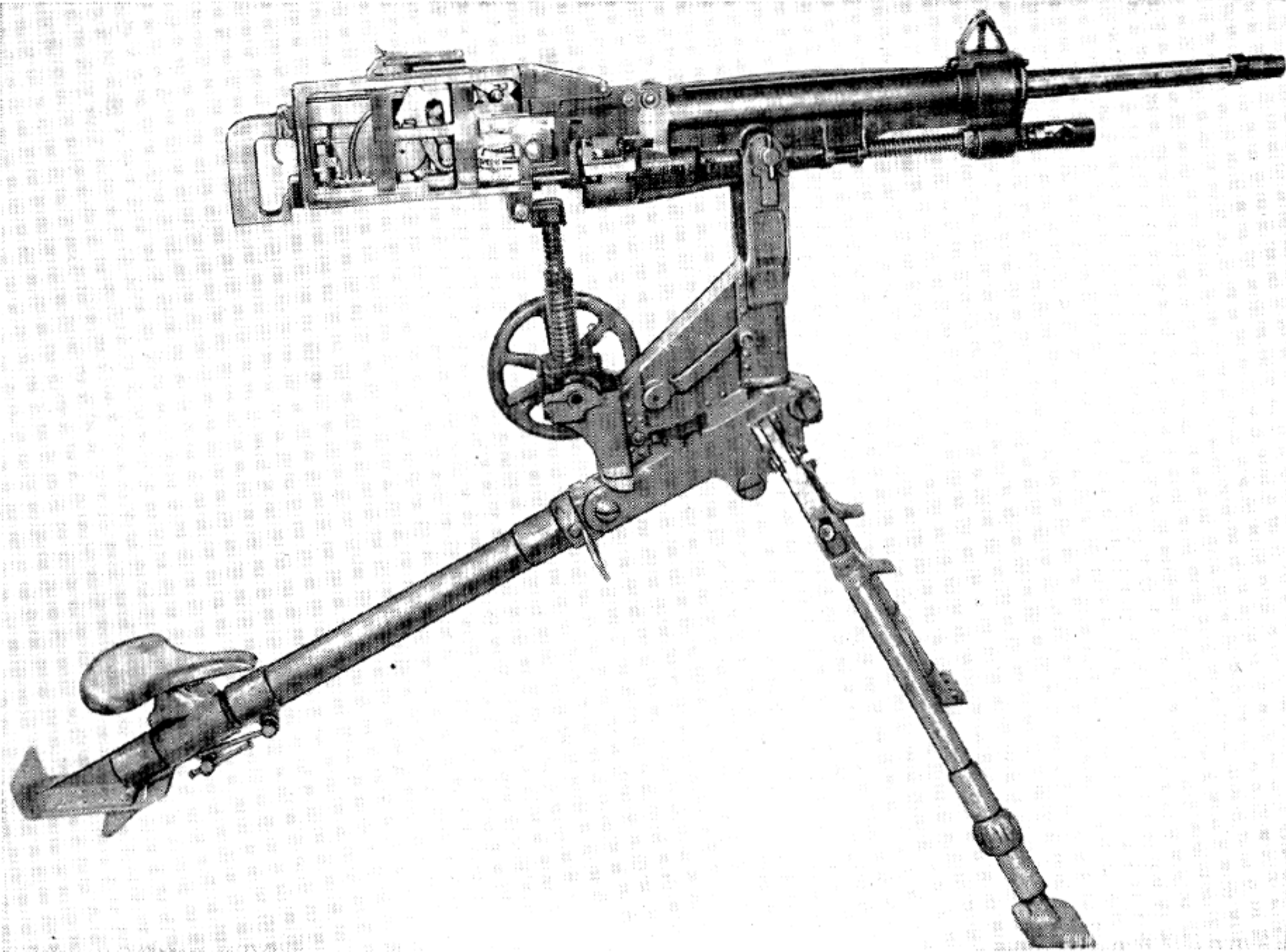

St. Etienne Machine Gun, Model 1907, 8-mm, Sectionalized.

Benét and his assistant, Henri Mercié. While it was known on the Continent as the Hotchkiss Portative, it was called both in England and America the Benét-Mercié machine rifle Model 1909, since the weapon was fitted with a shoulder stock. It was adopted by both the French and American armies in 1910. The French chambered theirs for the 8-mm Lebel cartridge, while our army used a caliber .30/06.

The breech is locked by a device called the "fermeture nut" which is cylindrical in shape. On top of this piece a long longitudinal cut provides clearance for the cartridge in loading. Near the left rear end is a semicircular depression to allow the passage of the front side of the feed strip. The rear shoulder of the fermeture nut is beveled and has a lug to engage the corresponding recess in the gas piston. The function of the latter piece is to lock the breechblock

slightly before firing and to unlock when gas pressure has dropped to a safe operating limit.

This locking system is located in the forward part of the receiver, directly in the rear of the breech, and is held in place by a shoulder on the barrel. On the top side of the piston actuator is a large slot that moves the camming projection on the rear surface of the fermeture nut. If the locking nut holding the assembly is permitted to work loose, it allows the barrel to creep slightly forward resulting in excessive head space. In an emergency this can be corrected by turning the nut as far past the locked position as possible. The locking screw is then screwed up tightly, holding it for a short duration.

To fire the Benét-Mercié Model 1909 machine rifle, great care must be taken to enter the 30-shot feed strip properly into the feedway in the upper right side of the receiver. Then the gas



Benét-Mercié Machine Rifle, Model 1909. This Weapon Manufactured by Colt's Patent Fire Arms Company is Serial Number "O".

piston and bolt assembly is pulled to the rear by means of the cocking handle until it engages the sear holding it in a cocked position. The handle is then pushed forward. When all the way home it may be turned to the right and lined up with either the letter "A" (for *Automatic*) or "R" (for *Repeater* or *Semi-automatic fire*) as desired.

A round has now been positioned and the weapon cocked ready for firing. When the trigger is pulled back, the sear releases the action that starts forward under compression of the driving spring. The face of the bolt strikes the first round in the feed strip forcing it into the chamber while the claw of the extractor snaps into the cannellure of the cartridge. As soon as the bolt engages the fermature nut, the firing pin and its large lug contact the ramp in the receiver, causing the firing pin to rotate partially and disengage the lug from the transverse cut in the bolt. Immediately after the bolt is locked

rigidly behind the chambered cartridge, the pin is free to go forward and is driven into the primer discharging the weapon.

When the bullet has passed the gas port in the barrel, a part of the powder gases is bled into the gas cylinder and forces the actuating piston to the rear. The cam surface cut in its upper portion engages the lug in the fermature nut the rotation of which unlocks the bolt. The firing pin then turns on its axis and is withdrawn, coming to rest with its lug in the transverse cut in the bolt, thus holding it retracted.

Engaging the rim of the empty case, the claw of the extractor draws it from the chamber and holds it during recoil until the ejector strikes the cartridge base and knocks it out the ejection slot on the left side of the receiver. When the gas piston has recoiled over half-way, the cam surface cut on its right side fits into the upper lug of the feed piece causing the latter to rotate from right to left on its axis.

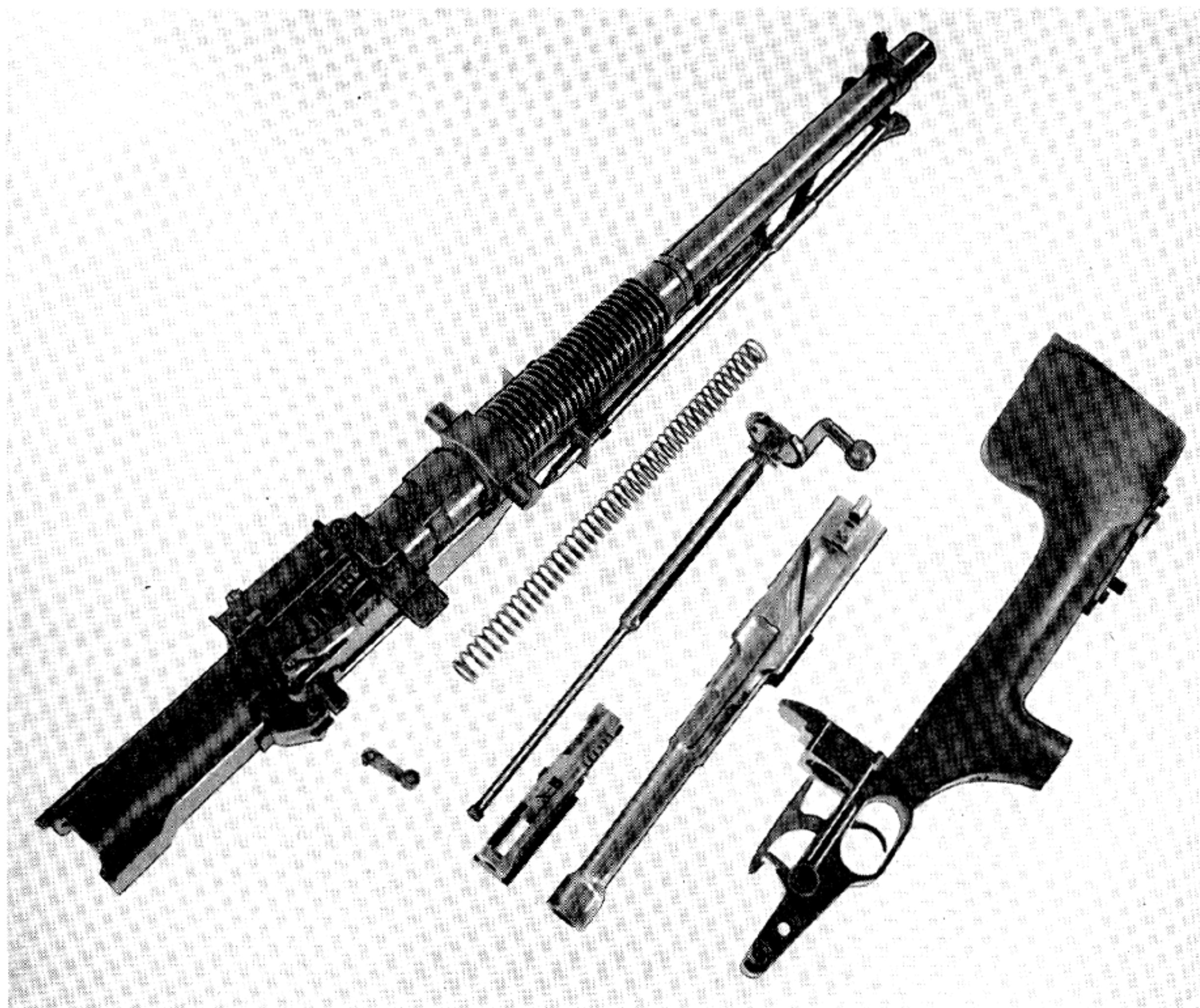

Components of the Benét-Mercié Model 1909.

The feed arm engages the lug in the central opening of the feed strip, indexing the next round for loading into the chamber. Full recoil stroke is accomplished when the driving spring is completely compressed and the operating parts then start counter recoil movement. The cycle of operation is repeated as long as the trigger is held back.

The Benét-Mercié remained our standard automatic machine gun until 1917. It saw limited service at the landings at Vera Cruz in 1913 and fell into general disrepute during the border trouble in 1916 with the Mexican bandit, Pancho Villa. The Benét-Mercié failed to operate during Villa's night raid on Columbus, New Mexico.

The alibi given by the machine gun squads was that the weapons could not be operated after dark because of their intricate system of loading. Newspapers throughout the United States had a field day with this statement and wrote many sarcastic stories, calling the Benét-Mercié the Army's famous "daylight gun" and suggested that the rules of warfare be rewritten so that no fighting take place except in daylight in order that our machine guns could participate.

Discontent in the press with our inadequate equipment was further increased when a short time later efficient American-made Colt guns (model '95) chambered for our caliber .30/06 ammunition, as well as medium and heavy

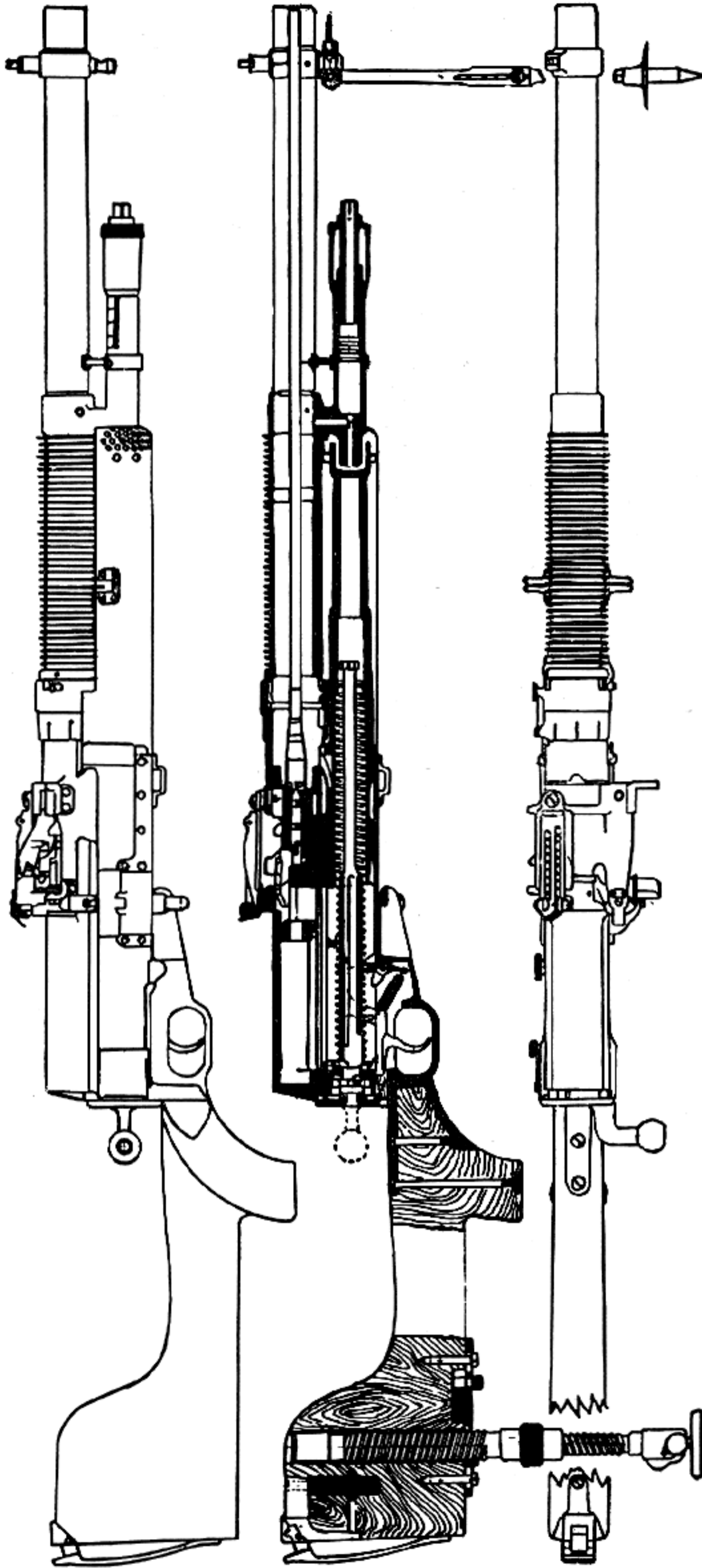

Section Drawing of the Benét-Mercié Model 1909.



Hotchkiss '97 machine guns, were captured from the Mexican guerrillas by our troops. The American Army's commander, Gen. John J. Pershing, sent them to the West Point Museum.

The United States, like all other countries, soon realized that no type of machine rifle could supplant the machine gun. While the Benét-Mercié was quite popular with the troops in peacetime because of its light weight, it could in no way meet the demands of warfare which required the heavier belt-fed weapons.

### Hotchkiss Machine Gun Model 1914

The summer of 1914 found France at a serious disadvantage because of its small stock of automatic arms. Army leaders, however, did feel that they were very fortunate to have available a thoroughly tested weapon simple to construct and reliable enough to give a good account of itself under any condition. In preparation for the coming war, the Hotchkiss machine gun was given a final bit of refinement and went into production as the Model 1914.

It soon became evident that machine guns would be required in unthought of quantities. The government factories at St. Etienne and Chatellerault lacked the manufacturing capacity for the numbers required, and the French War Department called upon the Hotchkiss Co. to prepare for quantity fabrication of the Model 1914.

Most of the first guns so produced were issued to territorial regiments of the line, then held in

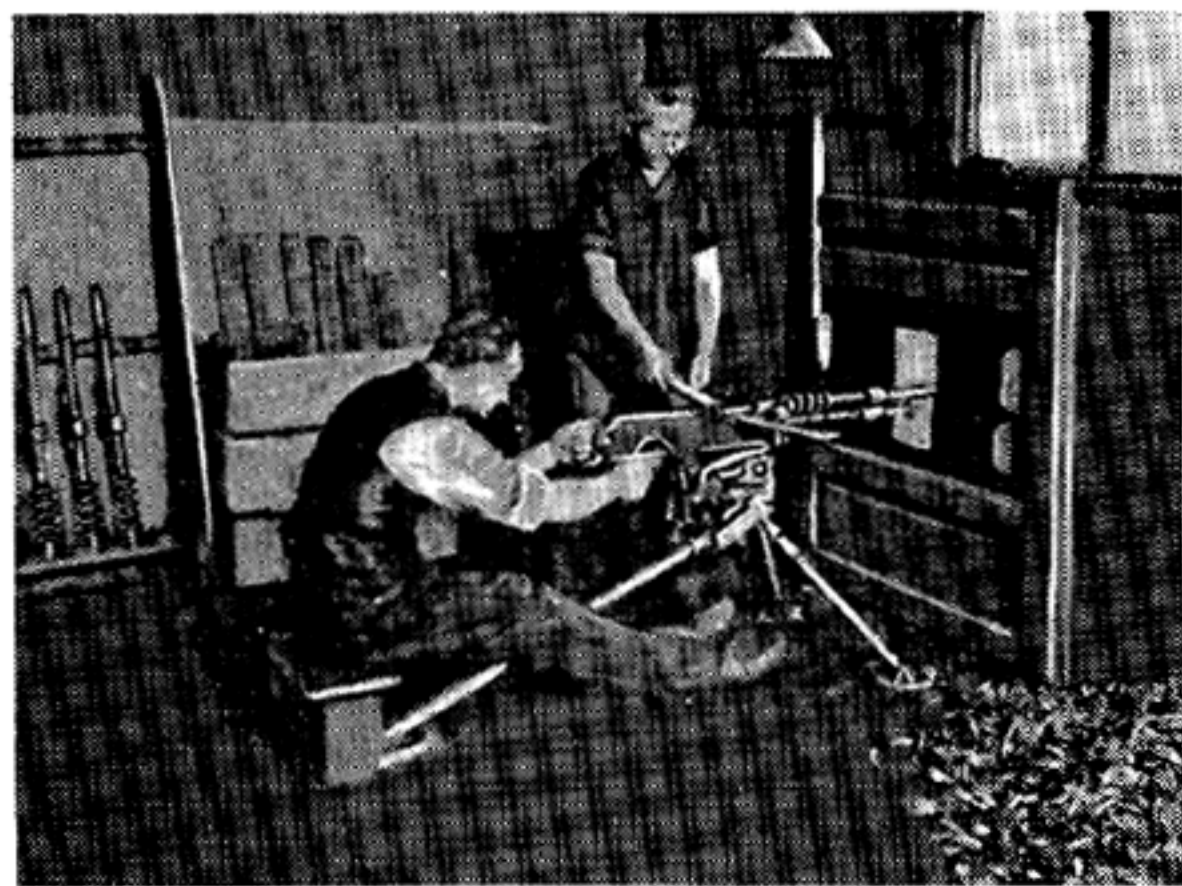

Function Firing the Hotchkiss Model 1914 in France.

reserve, so there was little opportunity to judge their merits in actual fighting during the operations of 1915.

In the following year when mass production had been realized, the Hotchkiss machine gun was issued as first-line equipment, a large number of brigade companies having been formed and armed with this weapon. The reliable qualities of the Hotchkiss gun were then promptly recognized by the entire army.

The best instance, among many, demonstrating the efficiency of the weapon was in the spring of 1916, during the heroic defense of Verdun, when a section armed with two Hotchkiss machine guns held its position near Hill 304 for 10 consecutive days and nights. Entrenched 150 yards behind the crest which the Germans were endeavoring to seize, this unit repulsed unaided all assaults, mowing down the succeeding waves of attack as they reached the summit. During these 10 days, the section, cut off from all supplies and communication expended over 150,000 rounds of ammunition. The original and normal supply of a section was 5,000 rounds. Fortunately, a dump of infantry cartridges was near at hand and, such was the enthusiasm aroused by the fire of the machine guns that all hands, including the officers, set about reloading the feed strips, thus enabling the section to carry on to the end. When it is realized that each gun fired upwards of 75,000 rounds and still was serviceable, one must have admiration for weapons that proved so reliable under such conditions.

The winter of 1916-17 confirmed the favorable opinion of the French Army for the Hotchkiss gun, as it could always be relied upon in spite of snow, mud, or the bad condition of the ammunition available. In March 1917, the French contingent operating in Belgium had to have its St. Etienne weapons, model 1917, replaced with Hotchkiss guns, because "this gun is the only one which works in spite of the sand, which on the Nieuport dunes constantly blows into the mechanism." By this time there arose a spontaneous demand from all French armies for the Hotchkiss.

On 15 July 1918 the weapon reached the zenith of its achievements. Military authorities

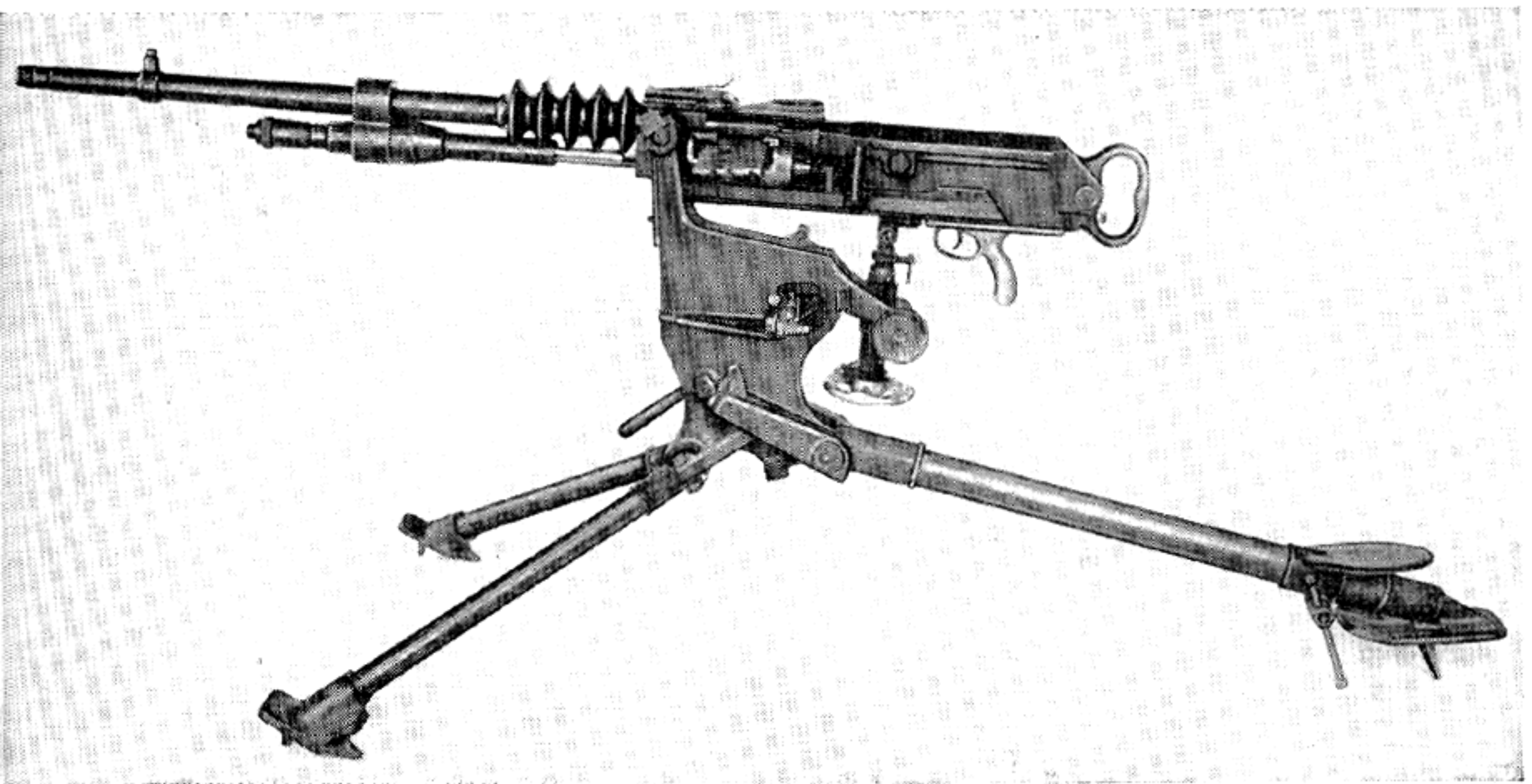

Hotchkiss Machine Gun, Model 1914, 8 mm.

agree that the heroic defense made that day by the Fourth (Gouraud's) Army against the last desperate German drive, marked the end of the offensive power of the enemy, and permitted Foch, 3 days later, to launch the general offensive that continued without respite for nearly 4 months and only ended with final victory for the Allies.

The brilliant tactical use of artillery and machine guns by General Gouraud resulted for the first time since the beginning of the war in stopping short a powerful general attack at the exact point of prepared defense. So completely was the attack shattered by the devastating machine-gun fire that the enemy withdrew in disorder, leaving more than half of his force as casualties on the field, and so broken and demoralized that no further attack was ever attempted.

On 18 July 1918 the Allied offensive began by the attack of the Franco-American Army under Mangin from Château-Thierry toward Ferc-en-Tardenois. Midway between these positions the advance of the French division was stopped by extremely violent fire from a large number of machine guns. The situation was critical, for these machine guns, concealed and scattered in fields of wheat, escaped the effects of artillery and an exposed clearing 1,500 yards in depth pre-

vented an advance within range of direct fire. All the machine guns of the entire French division were promptly united into a single battery and proceeded methodically to sweep the area occupied by the Germans. The effect was immediate and complete, and the enemy abandoned its positions with considerable loss.

It was with the 8-mm 1914 model that American soldiers were originally armed when our entry into World I found us practically without machine guns of our own. Twelve American divisions were equipped with this weapon.

The Army, in order to solve the logistics involved in carrying two kinds of ammunition, one for riflemen and another for machine gunners, had rapidly replaced the original 8-mm Hotchkiss machine guns with ones chambered for our .30/06 service rifle cartridge. After a brief period of battle use, there arose a pressing need for extra barrels. This shortage became very critical and it was with the greatest difficulty that the supply organization found the 20,000 spare barrels required. Manufacturing plants in America had not been tooled up long enough to meet the demand for the vast amount of extra barrels chambered for American ammunition. The urgency of the situation greatly alarmed the commanding officers of the sectors held by our troops.



Hotchkiss Balloon Gun, Cal. .472.

### Hotchkiss 12-mm Machine Gun

The French Army is noted for the work of its artillery men in producing some of the world's most outstanding heavy ordnance. Needless to say, their influence in military planning has been great and when the machine gun became such a lethal reality, they asked for the development of a long-range machine gun capable of inflicting heavy damage on observation balloons and on mobile artillery gun crews attempting to bring their pieces into action.

This demand resulted in much experimental work on such a weapon. Although research had been undertaken from time to time beginning with the turn of the century, it was late in the

war before the Hotchkiss company really approached perfection along this line with the introduction of the 12-mm machine gun. To distinguish it from the rifle-caliber weapon, it was referred to as the "balloon gun," since its employment on observation balloons at great range was most effective. The large caliber bullet contained an adequate charge of incendiary compound that ignited the hydrogen-filled bags upon contact.

The mechanism of the gun consisted of only 18 parts and was very similar in design to that of the rifle-caliber gun. The initial velocity, however, was 2,020 feet per second with a mean maximum pressure of 37,000 pounds per square inch at the breech. The range of the gun was 3,000

yards; the armor-piercing bullet at its extreme range had a velocity of 500 feet per second. French officers felt that this weapon would be able to put any mobile artillery gun crew out of action at a range which would be impossible with the rifle-caliber gun. The importance of this additional reach could hardly be overestimated in engagements in which the opposing forces of both armies were armed with machine guns.

The maximum rate of fire of the Hotchkiss balloon gun is 400 to 500 rounds. At a hundred yards the armor-piercing bullet would perforate one inch of homogeneous steel plate. The weapon can be fed by the conventional metal tray that holds 20 rounds of ammunition or by a long belt consisting of a series of cartridge holders on a flexible metal strip, which are hinged together to make possible a continuous feed.

Each holder has four clips which embrace the cartridge at the neck and near the base. To the first cartridge holder is hinged a thin steel tongue by means of which the belt is started into the feed. The cartridges are packed in a continuous belt of 250 rounds, having a length of 20 feet. Being wholly metallic, the belt is not affected by oil, water or temperature, and may be used repeatedly without deforming. The loaded belts

are carried already folded in light wooden chests from which they can be fed directly to the gun.

It was this weapon that Col. John Henry Parker heard about when it was in its prototype stage and, knowing that the United States was at the time trying to raise the caliber of its machine gun, he made arrangements with the French Government to borrow one of the two weapons under test and send it to this country.

After a thorough study was made of its ballistic features, it was decided not to adopt the weapon as it did not meet the minimum specifications in regard to bullet weight and muzzle velocity laid down by General Pershing in a cablegram to the Army's Chief of Ordnance. While the gun was undoubtedly superior to the rifle-caliber-type gun for certain tactical uses, it was dropped as far as the United States was concerned. Time has proved the wisdom of Pershing's decision not to consider any large-caliber machine gun that did not have a muzzle velocity of at least 2,750 feet per second.

The military authorities of all countries had great respect for this model and it was adopted by many governments. When the velocity was later increased, it was considered an ideal weapon for special objectives.

## NORDENFELT AUTOMATIC MACHINE GUN

A weapon that made its appearance on the continent in prototype stage only was known as the Nordenfelt Model 1897. It was actually the invention of Capt. W. Bergman of the Swedish Army, who sold his patent outright to the Nordenfelt Co., then located in Paris, France.

This company, like all other arms manufacturing plants that were selling manually operated weapons, suddenly found its products made obsolete by the success of automatic machine guns.

A booklet was published by this firm in order to arouse the interest of military authorities in the Nordenfelt Model 1897. It described the basic operating principles and went into great detail about the advantages to be found exclusively in this model.

The outstanding feature of the gun was that it was designed for both automatic and manual operation. Its rate of fire was 600 rounds per minute when fired full automatic. On conversion

to manual operation, it had a rate of fire of 130 shots per minute.

The operating mechanism is completely contained in a receiver, with bearings that support the barrel fore and aft. The gun is water cooled, having a jacket with valves to vent off steam. The rear of the receiver has two quick openings that permit the operator to get at the mechanism for purposes of inspection or clearing a malfunction.

A barrel extension is attached to the barrel and recoils with the latter between the parallel inner walls of the receiver. The bolt is thrown rearward at high speed by an accelerator. The barrel, extension and all operating components move longitudinally and are locked together for only a fraction of an inch, making this one of the shortest recoil actions known.

To load the piece for automatic fire, the operator places the first cartridge in the belt under

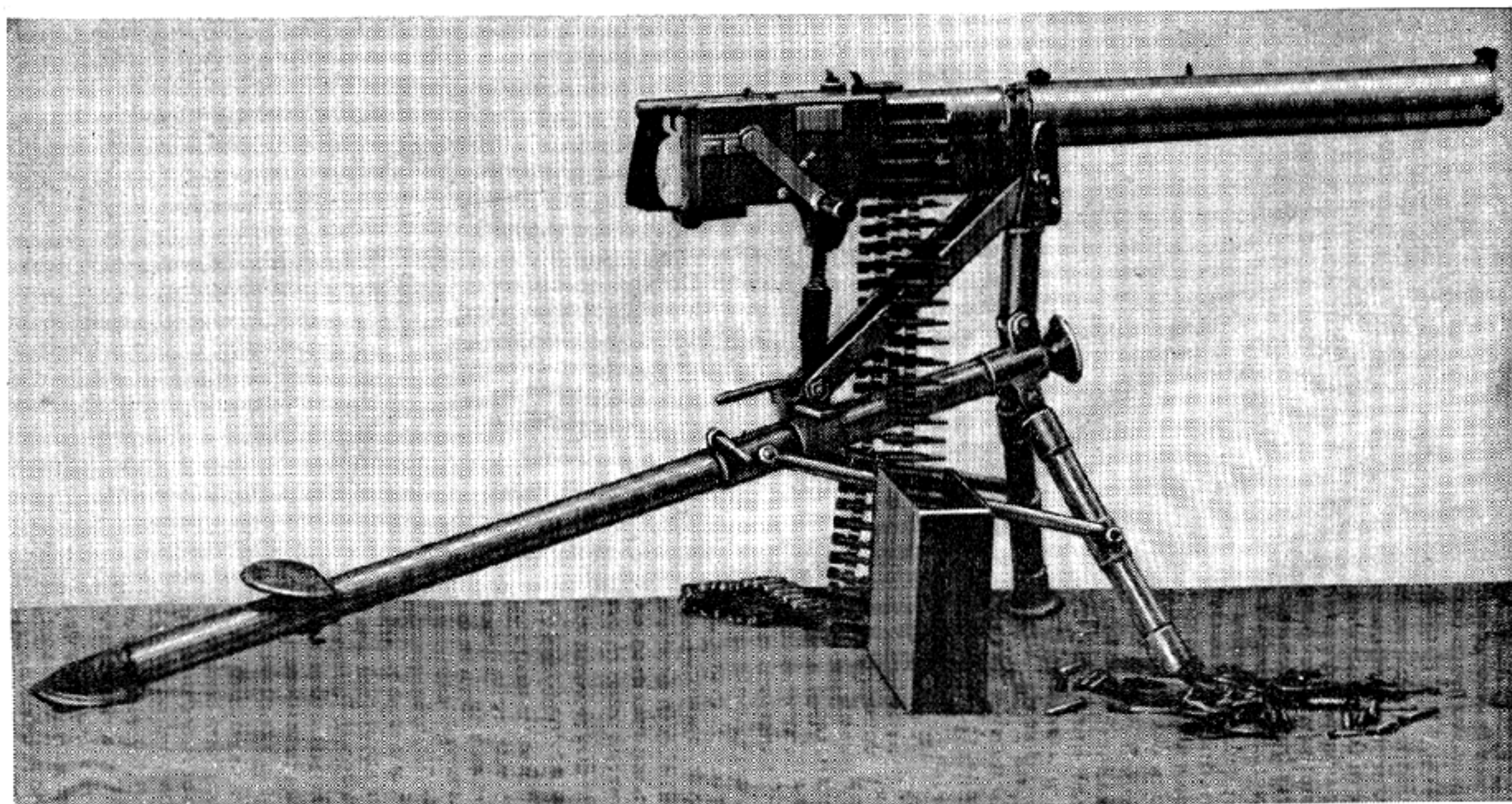

Nordenfelt Machine Gun, Model 1897.

the star wheel in the feed. After placing the fire regulator on *Safe*, the handle is pulled smartly to the rear four times and released. The compressed driving spring, in returning the mechanism to battery the required number of times, performs the cycle of feeding first by taking the cartridge out of the link in the feed belt and then by chambering it.

The piece is fired by a trigger located at the upper forward part of the pistol-type handle. While the powder charge is building up its peak pressure, the bolt is securely locked to the barrel and barrel extension and recoil begins. In less than an inch of rearward travel, the accelerator lever starts to pivot about the pin.

This rotation moves the roller in the accelerator cam groove of the locking angle and starts the accelerator cam turning rearward. The roller, which is attached to the bolt and rides in the accelerator cam groove, whips the bolt back at high speed, driving this part during recoil at a ratio of four to one.

In order to relieve the shock on the mechanism and prevent rupture of cartridge cases, the weapon is so designed that not until well after

the chamber pressure has passed its peak does the breech lock begin to open. Then the recoil movement is utilized to loosen gradually the empty cartridge case in the chamber before sudden extraction takes place. The case is ejected in the most peculiar fashion ever used by a machine gun. It is wiped from the face of the bolt and pushed through an opening on the upper right side of the receiver and on the same side from which it is fed.

After unlocking, the bolt assembly, consisting of the bolt, striker, striker spring, extractor, and two sears, recoils as a unit, and during this movement the striker is compressed against its spring and the weapon cocked. This is brought about as the accelerator cam engages the rear of the striker. When fully retracted, the sears drop into their notches.

The gun is front seared and the accelerator lever times the release point for the striker during full automatic fire. It will continue to operate as long as the trigger mechanism is actuated.

To convert the weapon for operation by hand, the selector on top of the cover is moved from

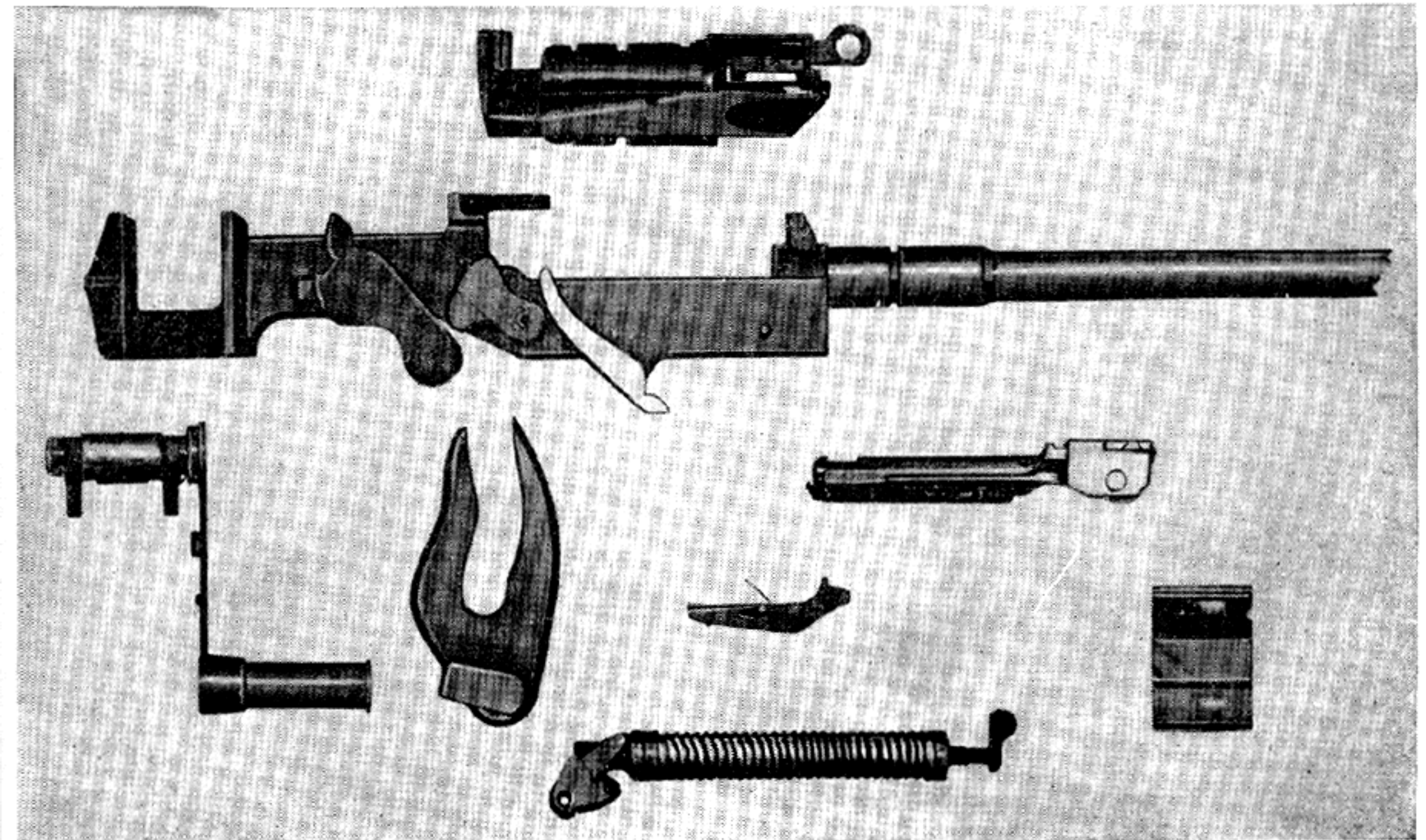

Components of the Nordenfelt Machine Gun.

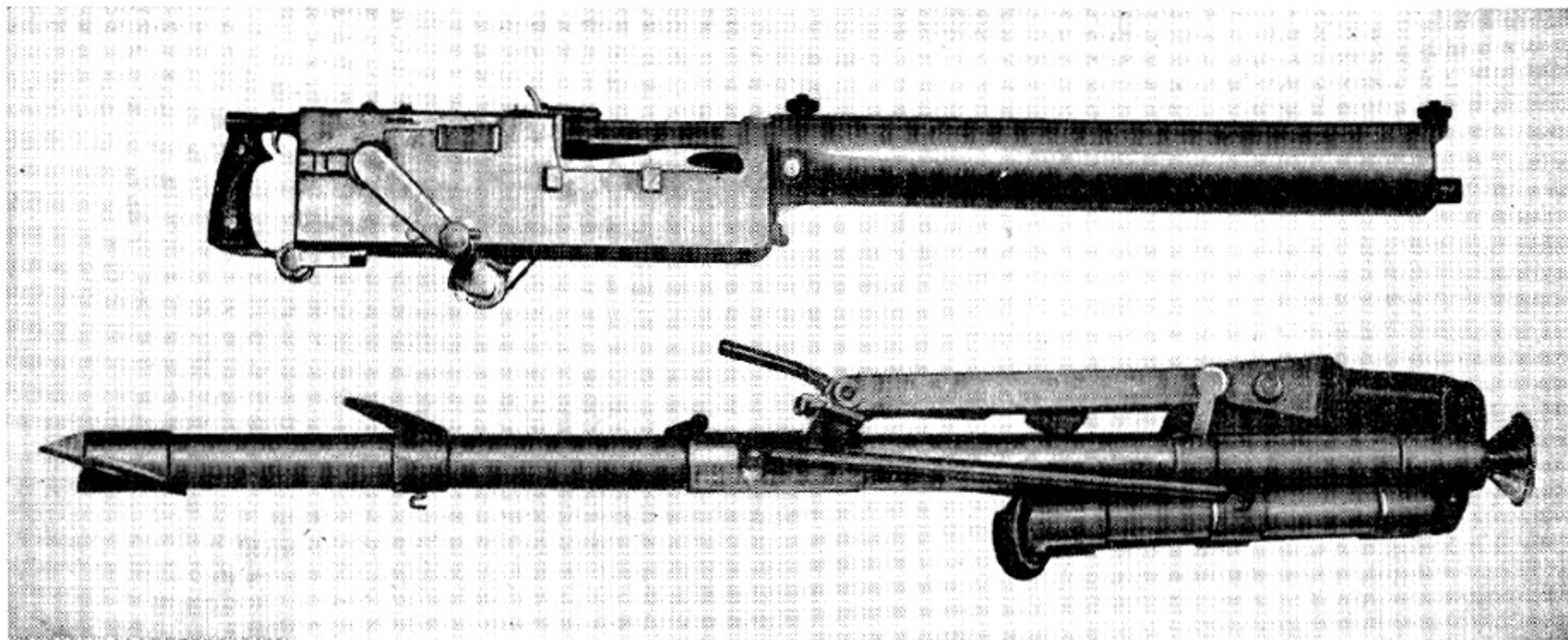

Nordenfelt Machine Gun, Model 1897, with Mount Folded for Carrying.

*Automatic to Manual* and the large crank on the right side is rotated in a counterclockwise direction. An eccentric on the crank cycles the barrel and barrel extension which in turn throws the bolt rearward.

By continued rotation the lugs on the operating crank shove the bolt into battery and chamber the incoming round at the same time. The lug then comes into position behind the bolt. This securely locks the mechanism so that the whole assembly will not recoil as in automatic fire. When this position is reached, the handle cams in the manual sear that protrudes through the right rear side of the receiver and the cartridge is fired. The operation will be repeated as long as the crank is rotated.

The ammunition is loaded 200 rounds to a belt and is fed from right to left. The feed mechanism consists of a star wheel with six divisions or spaces. When feeding during automatic fire, the recoil of the barrel extension actuates a projection on the feeder to the rear. This piece is engaged in a helical cam and the movement of the lug causes the cam to rotate one-sixth space counterclockwise, and winds a torque spring fastened to the star wheel shaft.

When the lug has made full movement, an escapement allows the stored energy in the spring to index the feeder. A ratchet arrangement then releases the barrel extension and permits the assembly to return to battery.

The belt enters the right side near the top of

the receiver. If the weapon is to be fired manually and the force of the barrel-return spring is not utilized to help load the weapon, as is done when it is set for automatic fire, the crank handle must be rotated four complete revolutions to index the belt over the feeder and put the first round in the chamber.

One of the many peculiarities of the weapon is that if set on automatic fire and the trigger is actuated before the crank handle has been secured in its rest position, the latter will on the first shot rotate to its proper place and remain motionless throughout the remainder of the burst.

A barrel-return spring of the Maxim type, located underneath the front part of the receiver, can be adjusted to give any desired pressure by the adjustment of a winged nut.

The most notable feature of the feed system is that in 1897 the gun employed a push-out type of metallic link that is practically identical with ones used today.

Thorsten Nordenfelt was of the school that did not believe the automatic weapon was here to stay. Having long built and promoted the sale of manually operated multibarreled guns that enjoyed a fair amount of popularity throughout the world, he had little confidence in self-loading weapons. This was his first and last attempt to enter a field strange to him and towards which he was bitter and hostile.

## DE KNIGHT WATER-COOLED MACHINE GUN

On 20 July 1898 Victor P. De Knight, a resident of Washington, D. C., applied for a patent on a gas-operated water-cooled automatic machine gun. Originally chambered for the caliber .30 Krag United States infantry rifle cartridge, it had a rate of fire of 600 rounds a minute. While it represented one of the few water-cooled gas-operated guns ever to get beyond the design stage, it still was unsuccessful and is described here only to show the great lengths an inventor will go to in order to avoid infringement of anyone else's patents.

De Knight interested the Pratt & Whitney Co. in producing a prototype, which was given the

designation, Model 1902. At the time this company was seeking a mechanism to market in place of its hand-operated Gardner, then being outmoded by the appearance of self-loading rapid-firing guns.

The weapon, although very clumsy in many respects, did have a few advanced features. The hinged top of the receiver not only made all working parts readily accessible but also housed the driving spring. Inertia firing, a pivoting bolt that was securely locked by the advance of the gas piston, and a simple screw in the side of the receiver that served as an ejector were also innovations. But the complicated gas system cov-



De Knight Automatic Machine Gun, Cal. .30, Manufactured by Pratt and Whitney.



ered by a water jacket with a regulating device that supposedly could be adjusted from the outside doomed the weapon from the start.

Feeding was accomplished by a lug on the gas piston which cammed the feed slide over one space on the recoil stroke. With the return of the piston a heavy spring pulled the feed pawl over behind the next round. The cartridge rim was engaged by a spring-loaded hook device that, when pulled a sufficient distance to the rear, removed the round from the belt and pivoted, forcing the bullet end down in alinement with the bore.

To fire the De Knight, the tab on a belt of ammunition is slipped through the left side of the feedway and the bolt-handled charger is pulled until the first cartridge is seated behind the stops and the next round in front of the holding pawl. When the bolt is pulled all the way to the rear, the operating mechanism is held by a scar located at the top of the pistol grip. The cartridge has been removed from the belt and tilted for chambering. Actuation of the trigger releases the bolt and gas piston to be pulled forward by the spring in the top of the receiver. The bolt face hits the bottom rim of the cartridge and drives it ahead into the breech end of the barrel.

As the bolt reaches battery, the extractor snaps over the cartridge rim and a lug on the gas piston in completing counter-recoil movement cams down the forward part of the pivoting breech lock. The rear end is thrust up into its locking recess in the receiver. The front part of the lug exposes the firing pin, which is struck by a portion of the gas piston to discharge the chambered cartridge.

When the bullet clears a gas port located nearly three-fourths of the way up the barrel, gas is let through the orifice and, after being vented through a long tubular affair, is finally released in a large cylinder and brought to bear on the piston. By this time the bullet has cleared the bore. As the piston is shoved back, the lug

strikes the rear of the pivoting piece unlocking the action. The gas piston and bolt start recoil movement with the extractor claw holding the rim of the cartridge until it collides with the ejector screw, kicking it out the right side of the receiver. Meanwhile, the incoming round has been removed from the belt and pivoted down. The recoil movement is stopped by driving spring tension and, if the trigger remains depressed, automatic fire will result.

Outside of a few unofficial demonstrations nothing was done in the way of development since the De Knight first appeared in 1902. Even in the few trials it did have, it could by no means be classified as reliable, having at all times an abnormal number of stoppages. In 1916, with the United States at the point of war, interest in the weapon was revived and a thorough test was ordered by the Army on 31 May 1917. The only change from the earlier model was the use of a spring-loaded firing pin in place of inertia firing. That this was a mistake is evident by the results of the trial.

Part of the test report is given in order that the reader may judge for himself the reliability of the De Knight water-cooled machine gun.

"During the first 1,150 shots, three breech-blocks broke and there were also many misfires and other malfunctions.

"The gun was then temporarily withdrawn by the representatives of the company in order to procure new parts.

"Upon resuming the test there were many malfunctions during the first 6,000 shots, and the representatives again desired to withdraw it for alterations and repairs. This the board did not allow on account of the short time remaining at its disposal and the gun then was permanently withdrawn.

"Total number of malfunctions: Misfires—143; Jams—5; Broken parts—7; Ruptured cases—1; Failure to eject—1; Failure to extract—0; Failure to feed—16; Other malfunctions—9. Total—182. Total number of rounds fired 7,150."

## MADSEN AUTOMATIC MACHINE GUNS

There came into existence in 1902 an automatic machine gun the parentage of which has been one of the most controversial subjects in the history of such weapons. It has been officially known under the names, Madsen, Rexer, D. R. R. S., and Schouboe, and was originally manufactured by the Dansk Rekyrliffel Syndikat of Copenhagen, Denmark.

It derived the title by which it is best known,

Madsen, from the name of the Danish Minister of War of that period, as a tribute to his enthusiasm for the weapon at the time of its adoption by the country's armed services. The use of the name, Rexer, is due to a long-standing policy of the British Empire in not considering for adoption any small arm that was not fabricated on English soil. Thus, in order to interest the authorities, many of these guns were made at a



Madsen Machine Gun, Model 1903, Being Demonstrated by Lt. Schouboe.

British arms factory known as Rexer. The D. R. R. S. title uses the initials of the Danish firm. The designation of Schouboe comes from the widespread belief that Theodor Schouboe, the director and engineer of the rifle company, was the actual inventor of the weapon.

Research on this bewildering topic adds even more complications. While it is true that Schouboe on 14 February 1902 did patent the basic operating principles of the mechanism, it is also a fact that on 15 June 1899 Julius Alexander Rasmussen, the director of the Royal Military Arms factory, in Copenhagen, applied for and was subsequently issued a patent on the identical features claimed by Schouboe three years later. To confuse the issue further, Rasmussen assigned his patent rights to the Dansk Rekyriffel Syndikat, the first to produce the weapon.

The original patent grant to Rasmussen covers fully all principles involved in utilizing an automatic rifle in which the energy of its recoil forces makes the arm automatically feed, fire, extract, and eject. It employs the basic system, first manually used in the lever-operated Peabody and Martini rifles, whereby a pinned breechblock rises during the forward lever stroke to uncover the base of the fired cartridge case, thus allowing its extraction and ejection. Then by its first rearward action, the bolt or breechblock falls below the barrel opening to permit chambering of the incoming round. The final movement forces the bolt to rise again to give support behind the loaded cartridge.

These actions, on the automatic weapons, are governed by a circular stud on the recoiling barrel extension working in grooves on a switch plate fastened to the receiver. The bolt is locked in the up position for the first half inch of recoil and so held until the bullet has traveled through the bore and the powder pressure has dropped to a point where it is considered safe to start the cycle of operation.

While this unique system has worked with great reliability, many still insist that the action is unsound in an automatic weapon, for the reason that each round, upon being rapidly loaded, is slightly distorted into an arc while being chambered. This view is supported by the fact that a very high percentage of stoppages results from stuck cases, especially when rimmed am-

munition is used. This is thought to be caused by a deformation of the round in the act of loading.

The pilot model was chambered for the 8-mm Danish Krag-Jorgensen round with a muzzle velocity of 2,228 feet per second. This was nearly identical with the service rifle cartridge employed by the United States Army just after the Spanish-American War. Practically all models that followed were designed for rimless ammunition, which was always considered more reliable, since a more tolerant head space can be allowed.

The first-mentioned use of the Madsen in warfare was by Russian forces in the Manchurian war of 1904-05. Some of their cavalry units were armed with it, but the foreign observers barely made note of the fact beyond a statement that a few had been seen.

Official tests were begun by the United States Army on the machine rifle version on 9 September 1903, at Springfield Armory, Springfield, Mass., and later concluded at Fort Riley, Kans. The firing was done by Lt. Theodor Schouboe, of the Danish Army, who personally represented the Dansk Rekyriffel Syndikat. In this test the feed was considered unsatisfactory and, when the ammunition was not lubricated, a ruptured cartridge case generally resulted.

A total of 7,163 rounds were fired, during which enough malfunctions occurred to justify the official conclusion that the Madsen weapon had not reached a stage of reliability to warrant adoption. The most objectionable feature occurred when the driving spring repeatedly failed to propel the mechanism home and Lieutenant Schouboe then had to rise to a kneeling position in order to exert enough force on the charging handle to shove the action full into battery. In combat such a movement would make the operator an outstanding target. The weapon's accuracy was considered satisfactory and complimentary reference was made to its unusually light weight.

An air-cooled, belt-fed heavy Madsen machine gun, designed for calibers from 6.5 mm to 11.35 mm, made its appearance shortly after this. Many of the earlier malfunctions were corrected, so that it was considered reliable for special objectives. If certain peculiarities are overlooked, the

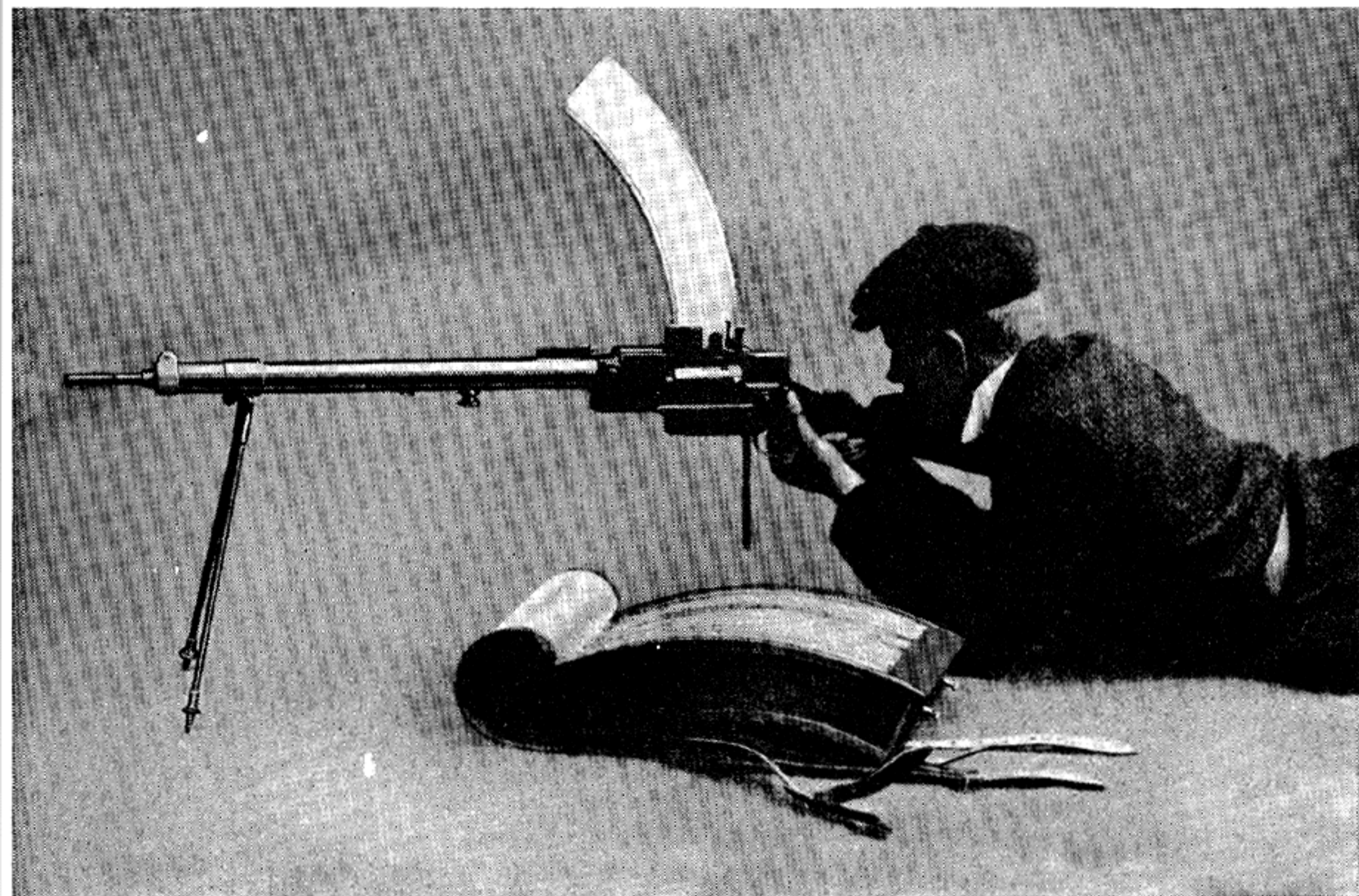

Madsen Machine Gun, Model 1903. Photographed During United States Trials.

Madsen can be classed as one of the few automatic weapons that have successfully stood the test of time.

When the belt-fed automatic machine gun version is prepared for firing, the ammunition belt is started into the left side. The disintegrating links used in the feed belt are of peculiar design. The front of the link fits over the shoulder of the round which has to be pulled through it by the feeding action. The rear portion of the link is of the type known as the "push-out" or "half-link," in that it does not go all the way around the base of the cartridge. A sharp claw of spring steel holds the case firmly until it is finally withdrawn.

Once the weapon is cocked and the first cartridge is placed under the belt-holding pawl, the large charging handle on the right side is pulled back. This action moves the barrel extension a considerable distance to the rear after the bolt rises. The pawl holding the cartridge in position is carried to the right by the camming

action which takes place between the barrel extension and the piece supporting the incoming round until the cartridge is forced through the feed slot in the receiver.

At this time a spring-loaded claw cams itself over the rim of the cartridge. The pivoting of the feed arm actuates the claw rearward and withdraws the cartridge from the belt, positioning it in the feed trough in the top of the bolt. The pivoting lever has by now taken its place behind the round. Upon release of the cocking handle the energy of the compressed driving spring sends the lever forward. The front end of the bolt is pivoted down below the bore in the barrel. Further movement forward of this lever causes it to strike the base of the cartridge, ramming it into the chamber. The final pivot movement raises the breech block full behind the bolt and the weapon is ready to fire.

The rearward pull of a trigger releases the large striker which flies upwards in an arc against a firing pin, detonating the primer. Dur-

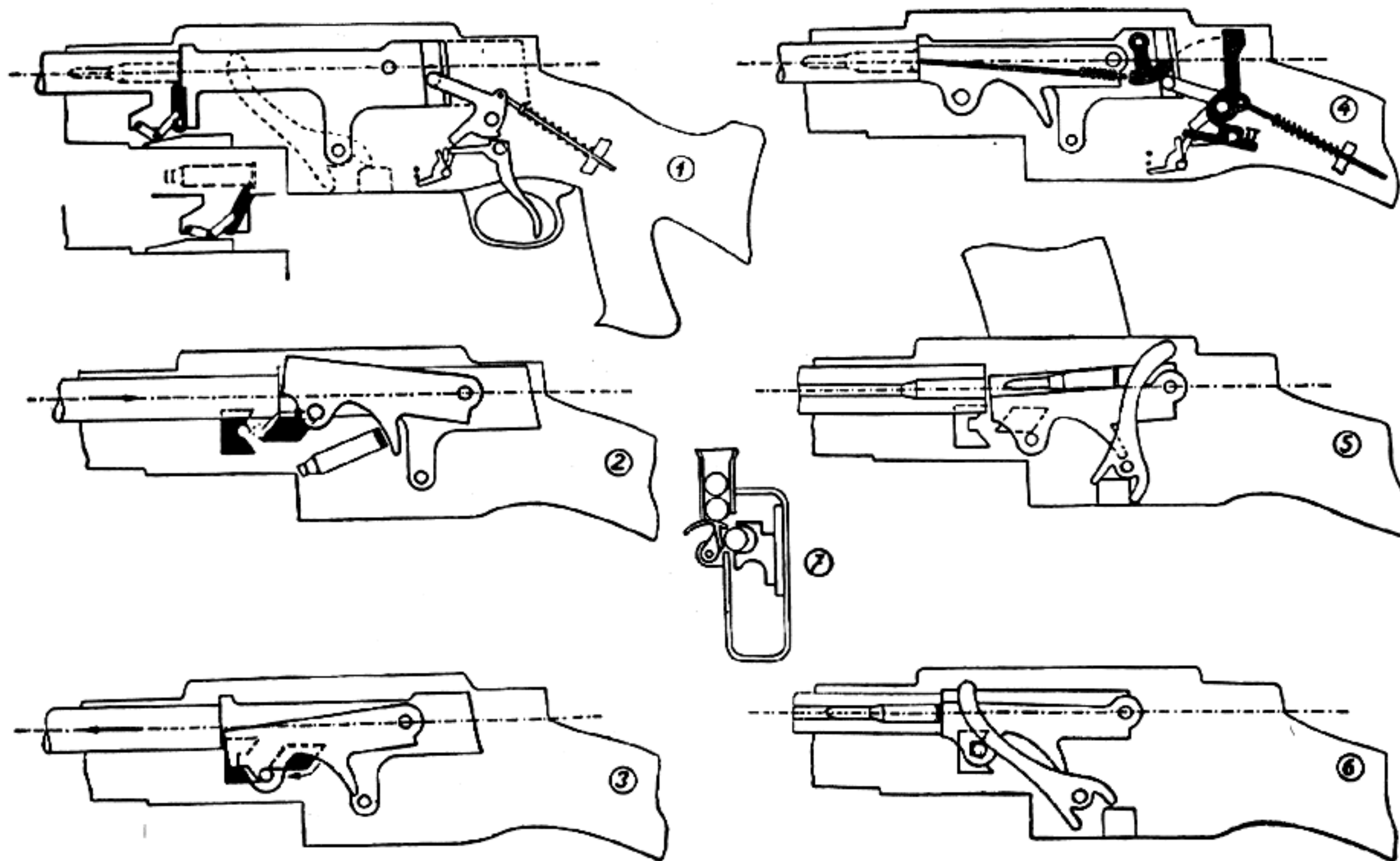

Action of the Madsen. (1) Loaded, Locked, and Ready to Fire. (2) After Firing, Bolt Pivots Up to Eject Cartridge. (3) Bolt Pivots Down for Loading. (4) Loaded, Locked, and Ready to Fire. (5) and (6) The Action of the Loading Arm. (7) Magazine Cut off Device.

ing recoil, the barrel, barrel extension, and bolt are securely locked for one-half inch, until the trigger bar is struck by the rear of the recoiling bolt mechanism. This frees it, allowing the striker to be forced back to the cocked position and the spring-loaded firing pin is withdrawn into the bolt body. The guide stud then passes out of the horizontal groove and travels up the top cam of the switch plate to pivot the bolt face upwards. The base of the empty cartridge case is thus uncovered, permitting the recoiling extractor to apply a sudden mechanical advantage as it strikes the lug in the bottom of the receiver. The extractor claw, in one rolling motion, not only withdraws but ejects the empty case from the chamber. The case is guided out of the receiver by the curved contour of the bolt until it falls clear to the ground.

During the last of the recoil movement the barrel extension has cammed another round into the receiver feed slot, and the pivoting feed and operating arm positions it in the trough formed by the machined recess in the top of the bolt.

Counterrecoil, originating in the stored energy of the driving spring, when it starts the entire operating assembly back to battery, first depresses the bolt and then drives the cartridge into the chamber.

The bolt and barrel extension are then accelerated forward by this spring acting through the medium of the cammed pivoting of the radial operating arm. When the counterrecoil movement is almost completed and the base of the cartridge is fully covered by the rising of the pivoting bolt, a cam on the arm automatically releases a sear if the trigger is still held rearward. The striker again flies up to continue the cycle.

This was the most unusual employment of the short-recoil principle known to date. Although the bolt unlocked in scarcely a half-inch rear travel, the barrel extension continued to recoil to a point slightly exceeding the combined overall length of the cartridge case and projectile.

On some models a device was fastened to the barrel jacket at the muzzle end to trap the blast after the bullet cleared the bore. This was done

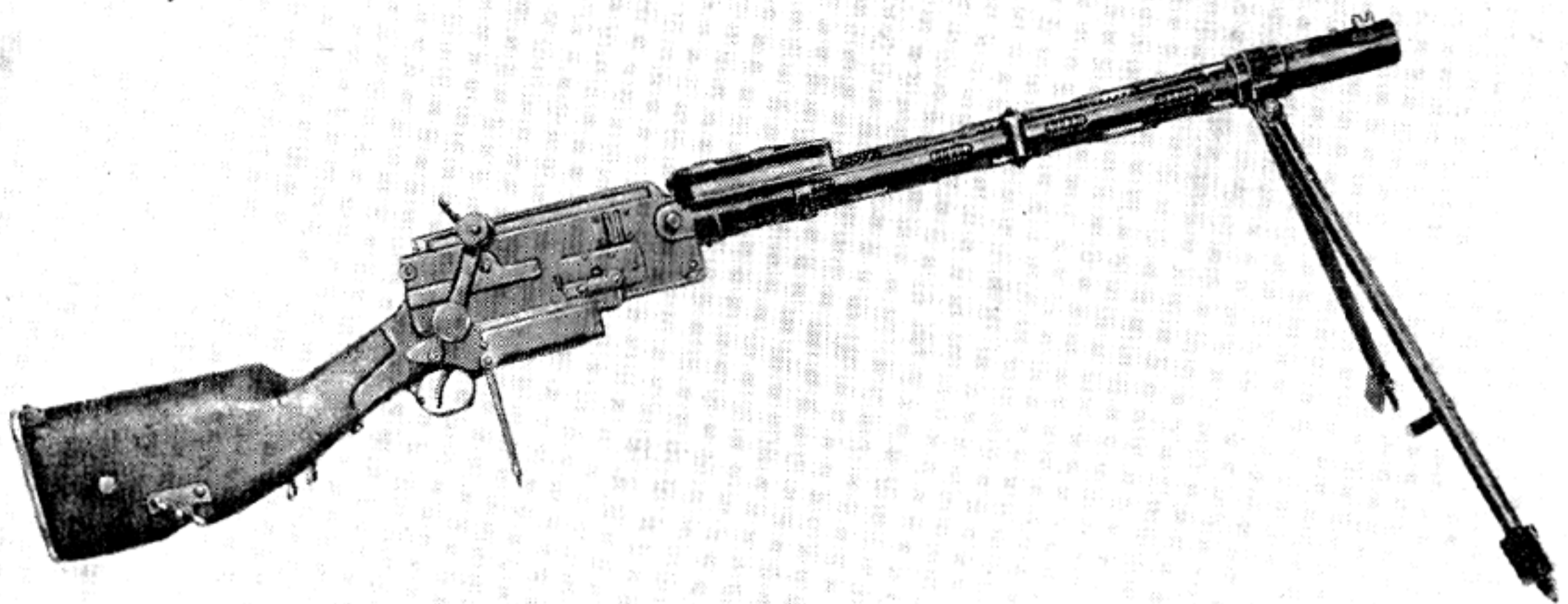

Madsen Machine Gun, Model 1914, 8 mm.

by a controlled orifice that permitted the bullet to clear along with some of the still-expanding gases. The remainder acted on the face of the barrel somewhat on the order of a piston, accelerating the recoil forces and resulting in an increased rate of fire plus an added amount of belt pull.

The Madsen was greatly respected by European governments and met in open competition all the machine guns that were commonly known at the time. Although it was more reliable than spectacular and had a notoriously slow rate of fire when the muzzle booster was not used, it nearly always managed to pass successfully the various trials. An experimental Madsen gun with a muzzle booster, fast return spring and very light working parts was once found capable of reaching a very high speed but had frequent stoppages due to ruptured cartridge cases. However, this was eventually overcome by lubrication of the ammunition.

Many consider the Madsen the first truly light machine gun to make its appearance in the automatic field. It was accurate, reliable with good ammunition, and had little recoil to disturb the

gunner's aim. It was however prone to serious stoppages that were exceedingly hard to clear unless ammunition was used that was above the average issued for service use. And while it was fairly simple and very robust in design, it was found to be unusually expensive to manufacture due to certain features that required extensive machining.

While the Madsen was standard equipment of the Danish and Norwegian Armies and was used by some small states on the Continent, it was not looked upon favorably by the larger powers. Both England and Germany tested the weapon experimentally during World War I. England used a few to a very limited degree while Germany rejected it outright.

The action on this machine gun has been exploited perhaps as much as any other system in existence. This has resulted in over a hundred different models that were used by most of the military forces of the smaller nations, with the Balkan and South American countries buying the bulk of these weapons. It has been chambered at one time or another for just about every size rifle cartridge that has ever been developed.

## BERGMANN AND DREYSE MACHINE GUNS

## Bergmann Machine Gun

Perhaps there has been more confusion surrounding Bergmann and Dreyse machine guns than for any other automatic weapons on record. Although these two are separate and distinct mechanisms, they are here presented in the same chapter in an attempt to show clearly the differences between them.

The original gun was designed by Theodor Bergmann of Gaggenau, Germany, and patented by him in 1900. The weapon was known as Model 1902 and was manufactured by Bergmann Industrie Werke Abt. Waffenbau of Suhl. It was followed shortly by Model 1903, which differed from the first gun only in mounting and positioning of the feed box.

The Bergmann is operated on the principle of short recoil, whereby all recoiling parts are securely locked until the bullet has cleared the bore. At the instant of unlocking the bolt is free to move to the rear, with all components working in a straight-line movement. Its simple construction makes it possible for the soldier in the field to disassemble and put the mechanism together again without the aid of tools. A vertical rising type lock is employed.

There are three principal parts to the gun: The receiver, which houses the barrel, barrel extension, and water jacket; the back plate, which contains the trigger mechanism and has fastened to it the spade grips; and the cover group, which encases the feed system and serves to lock the receiver to the cover.

To fire the weapon, the gunner places the first round in the cartridge belt under the belt-holding pawl until the round comes to rest against the cartridge stop. The bolt is then manually pulled back by a cocking handle. When it starts rearward, the claw of the feed slide begins to extract the loaded cartridge from the feed belt. This rearward action also pushes the striker down until it engages the sear that holds it in a cocked position. By the time the bolt has reached its full stroke, the feeder arm pivots over and places another round in the belt in place of the one just removed.

When the bolt is released, it is driven forward by the driving spring. In doing so, it picks up the cartridge held by the feed claw and chambers it. At the same time the extractor lip is cammed over the rim of the cartridge case.

The weapon is now charged and ready to fire. The disc-shaped upper part of the trigger is



Theodor Bergmann Firing the First Model Bergmann Machine Gun.

pressed forward after the safety catch has been disengaged to force back the trigger bar. This in turn pulls the sear away from the cocked hammer, which flies up detonating the primer in the cartridge. Upon discharge of the cartridge, all recoiling parts move together securely locked for one-half inch. At this point the bolt is unlocked. The breech lock is cammed down out of its locking recess and allows the bolt to recoil free of the heavier parts. The extractor withdraws the empty case and holds it in position for the ejector, a curved spring-loaded arm fastened in the top of the receiver. It strikes the empty case a blow on its base, knocking it through an opening in the left side at an angle of 45 degrees downward. This cycle of operation is continued as long as the gunner depresses the trigger piece located between the spade grips.

The Bergmann machine gun was looked upon

favorably by the German Army because of its many refinements. It was compact in form, built on small dimensions and protected from dust, mud, and moisture by its tight-fitting receiver. The so-called "straight-line" action has always been regarded by the Germans as the most durable and the one that would require the least servicing in the field.

The barrel had a quick disconnect that could be changed in 20 seconds, being held securely to the receiver by a bayonet lock that could be disengaged merely by pressure on this part. The most notable feature about the gun was that this act could be accomplished without losing the water out of the jacket. This was done by tilting the barrel down at a 45° angle. When the barrel extension and barrel were pulled out from the rear, a leather stopper was placed in the front barrel bearing to prevent a leak. The insertion of

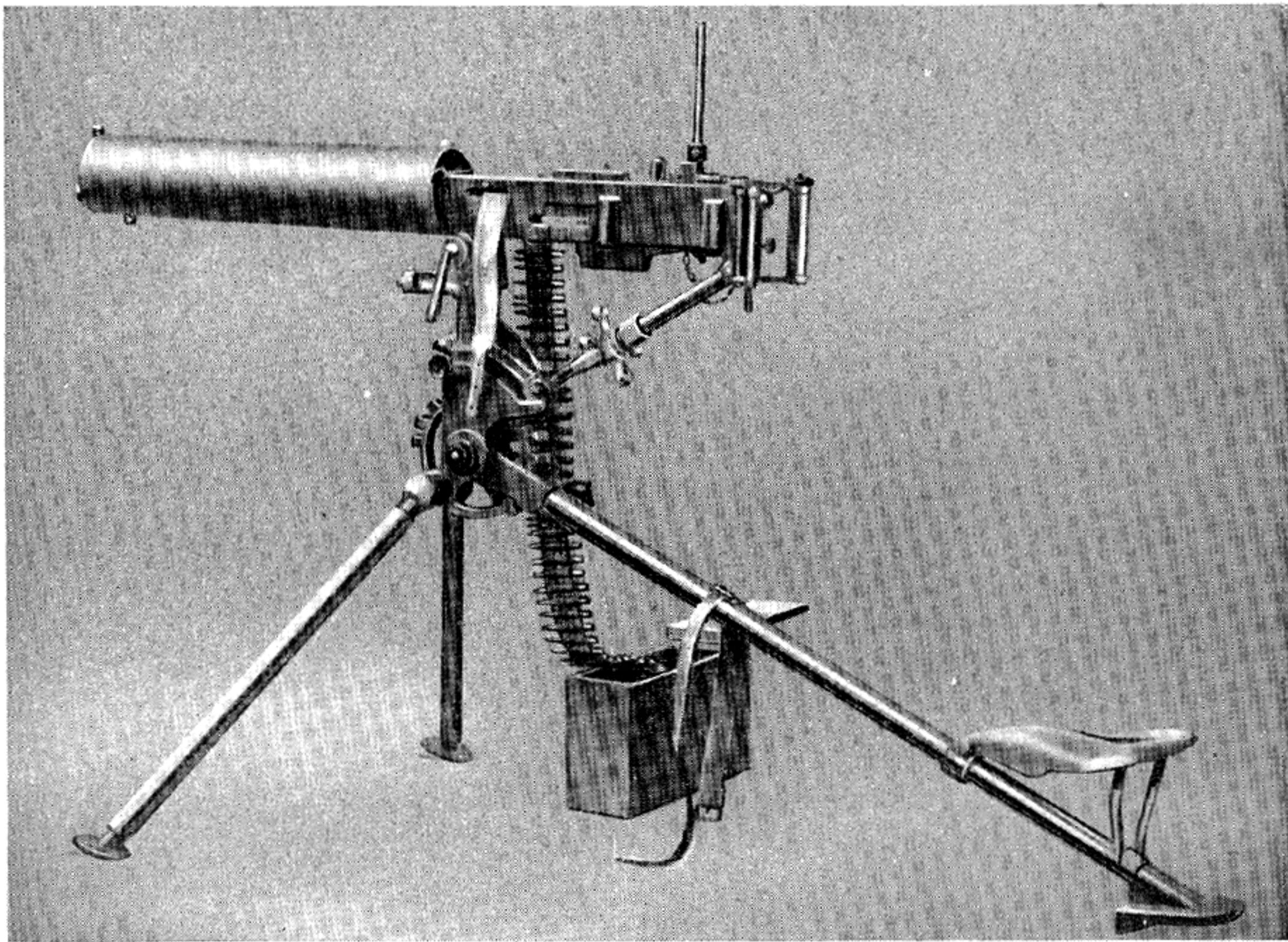

Bergmann Machine Gun, Model 1910.



a fresh barrel simply knocked the plug out of the bearing as it was inserted in the proper position.

The cover could be lifted to expose the breech lock and recoiling parts. The operator thus had full view of all parts that might need maintenance. As the feeder was housed by the cover, any fault could be easily corrected without delay.

A double safety arrangement gave absolute security against accidental discharge from any conceivable source. This was considered of great importance by the Germans as their maneuvers required machine gun units to drag loaded weapons through thick underbrush.

The rate of fire was fairly low, with a maximum of only 400 to 450 shots per minute. This feature was also felt to be adequate by the Germans, as it was thought that with the Bergmann gun's medium weight any higher cyclic rate would only increase dispersion.

One of the best features was the withdrawing and positioning of ammunition from a belt by an extractor claw arranged on the feed slide. The part was so located that the claw would engage the rim of the incoming cartridge case even when haphazardly belted. This permitted reliable firing of ammunition the linkage of which would prohibit use in other machine guns. The belt itself was constructed of aluminum non-disintegrating links.

Such refinements show the meticulous skill of Theodor Bergmann, who not only designed this fine weapon but had numerous other patents on all types of automatic arms ranging from heavy machine guns to blow-back-operated submachine guns and pistols. His products have always demonstrated the highest degree of skill in the art of gun creation.

The weapon was again modified and issued as the Bergmann machine gun Model 1910. The changes in the basic mechanism were slight, the mount receiving the major alterations.

### Dreyse Machine Gun

In 1912 a new water-cooled machine gun, caliber 7.9-mm, was introduced to the German service. The weapon was called the Dreyse, in honor of Johann Nikolaus von Dreyse, the inventor of the German needle gun and founder of the arms

factory so named. This mechanism was patented by Louis Schmeisser of Erfurt, Germany, in 1907 and all rights were assigned to Rheinische Metallwaren und Maschinenfabrik A.G. of Düsseldorf. Although at first glance the gun appeared to be but an improved Bergmann, basically it is different and there is no similarity in the mechanism. The main difference between the two is that the Bergmann lock rises vertically while the Schmeisser (or Dreyse) lock pivots.

The principal features found in the gun were the mechanical accelerator and a three-claw arrangement on the mainspring housing that withdrew the cartridges from the feed belt. The claws were positioned in a manner that made it practically impossible to have belted ammunition so much out of alignment that one of the claws would not pick it up and position it for chambering.

The breech lock was known as the oscillating or pivoting type. It was pinned at the bottom of the barrel extension, swinging down for unlocking as the rear portion rode up a ramp on the recoil stroke. The addition of the accelerator gave a rate of fire of 600 shots a minute.

The weapon, when it made its first appearance, was looked upon as just another machine gun by German military leaders. Later the Dreyse Models 1915 and 1918 were introduced as the possibilities of its design were better appreciated. The Model 1915 did not perform successfully. However the Model 1918 proved to be quite reliable.

The German Army, which had been committed to the Maxim, found that this heavy weapon and its sled-shaped mount did not lend itself to the mobility that had by this time been found vitally necessary. A lightweight machine gun was needed that could be carried by a single soldier and was capable of delivering sustained fire so that relatively few men so armed could hold a position until reinforcement by the heavier Maxims was possible.

The Dreyse had been designed for just such a use. It could fire bursts of great duration since it was water cooled. It was the lightest gun of its type then known, weighing only 37 pounds with water jacket empty. The Germans had several light machine guns but the others were air cooled and the authorities thought much more highly

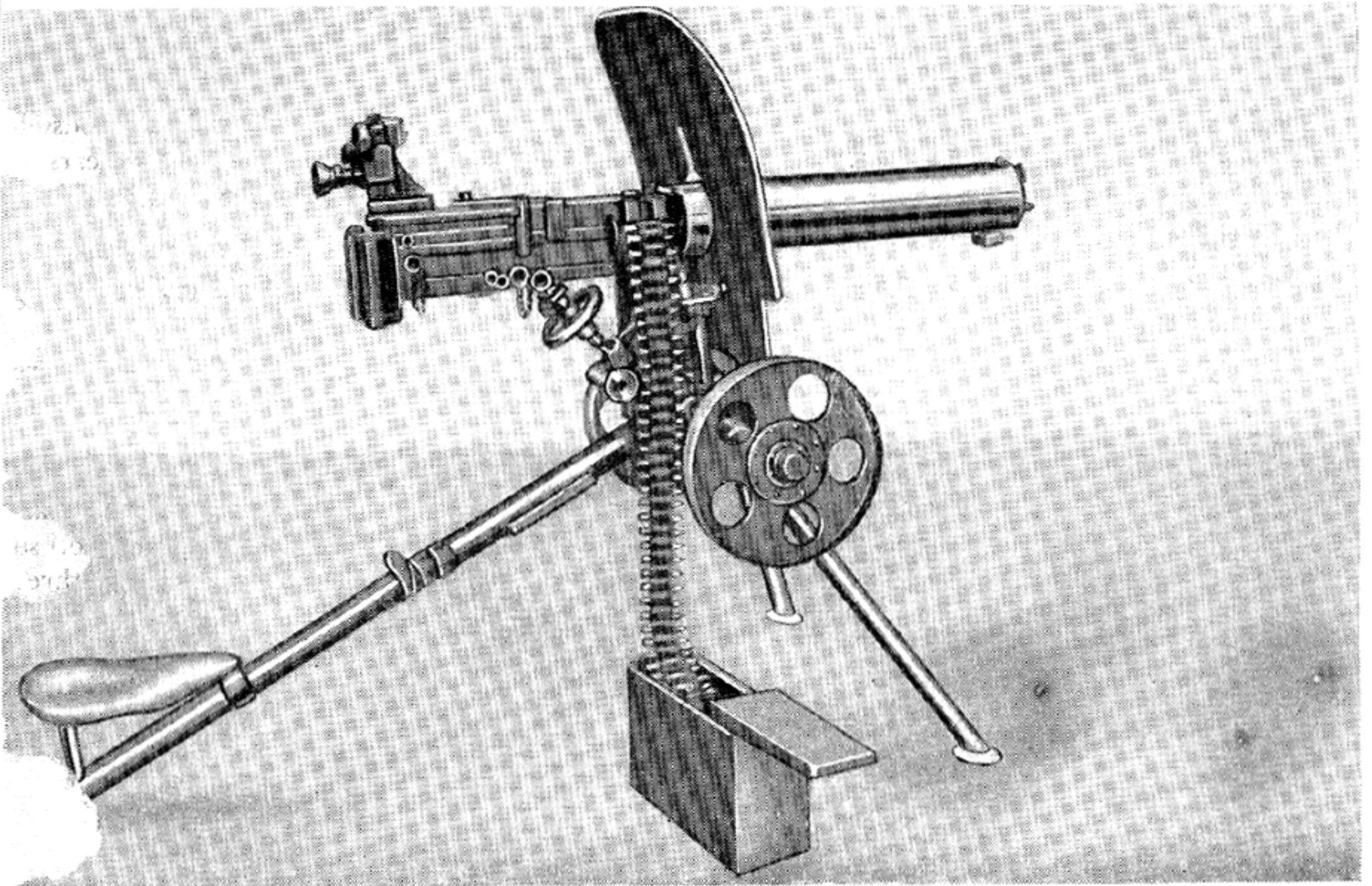

Dreyse Machine Gun, Model 1912.

At the efficiency of the water-cooled weapon. Since only a few pounds separated the two different styles, they looked very favorably on the extremely lightweight Dreyse. The large tripod mount originally designed for it was removed, and a bipod was substituted. This permitted the advancing infantryman to fire from the prone position. It was thought that this weapon, so mounted, best fulfilled the high command's conception of the primary function of all automatic weapons, namely, to deliver economically the greatest volume of fire power without sacrifice of mobility and accuracy.

Provision was made on the receiver for mounting a telescope sight; otherwise the conventional graduated iron sights that could be folded down when not in use were employed. The double safety arrangement was retained from the original design. There were only three main groups in its construction: The receiver, the back plate, and the cover. The receiver housed the barrel, barrel extension, operating parts, and water jacket; the back plate contained the buffer

spring and trigger mechanism; while the cover held the feed slide and components.

To unload the weapon, the belt-holding pawl was lifted, allowing the belt to be pulled back so that the feed pawl would not engage the last round. Then the chambered round was removed by pulling back all the way on the retracting handle and then releasing it.

To fire the Dreyse water-cooled machine gun, Model 1918, a loaded cartridge belt is placed in position and the tip is pulled to the left until the first round snaps behind the belt-holding pawl. The retracting handle is withdrawn all the way and released, only one pull being necessary to withdraw the cartridge from the belt and chamber it. The trigger is now pushed in to pivot the sear back, releasing the hammer which, upon flying up, strikes the firing pin and detonates the powder charge. After the barrel extension, barrel, and bolt recoil a distance of less than a half inch, the breech lock is lifted at its rear end by the cammed surface at the bottom of the receiver. This forces down the front part

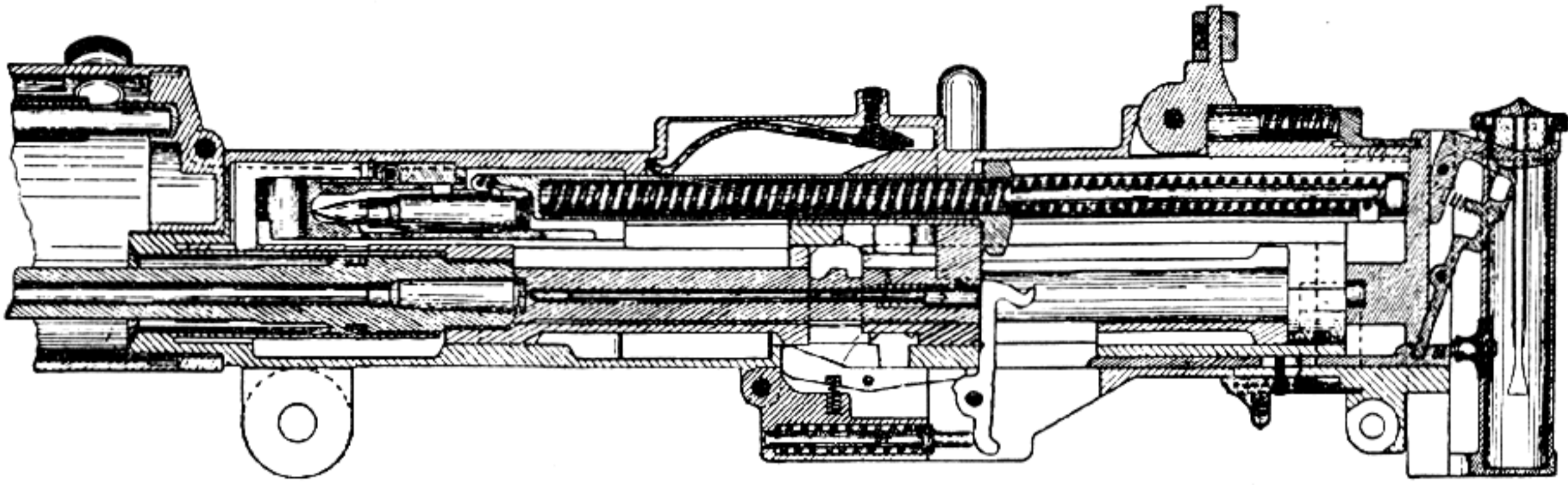

Section Drawing of Bergmann Machine Gun.

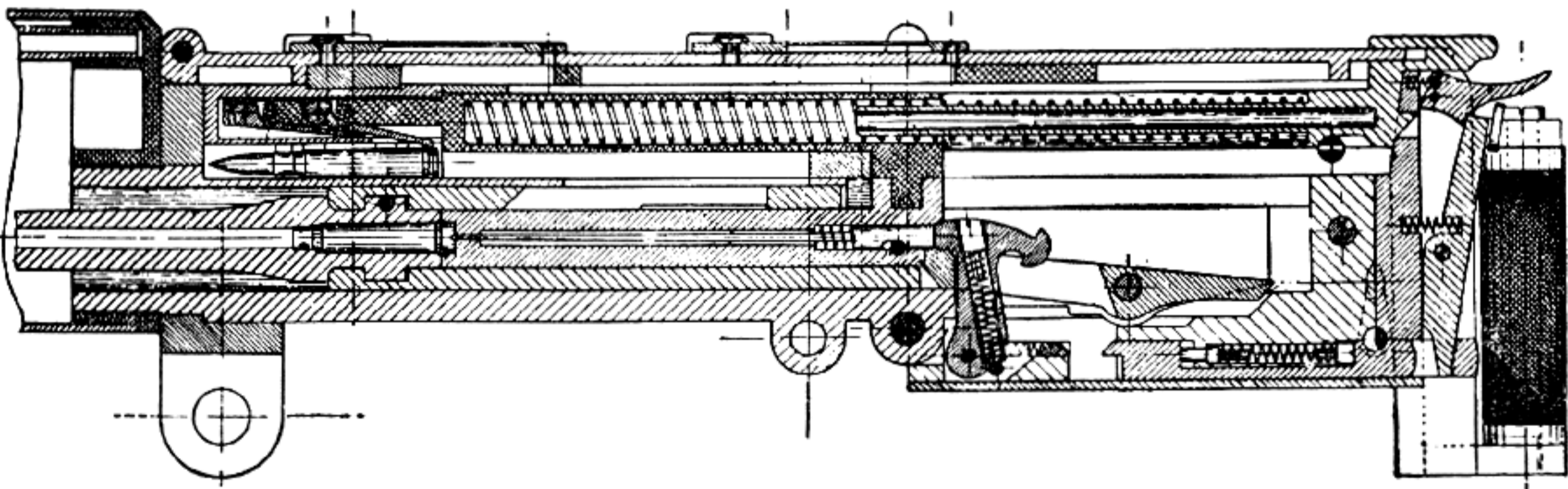
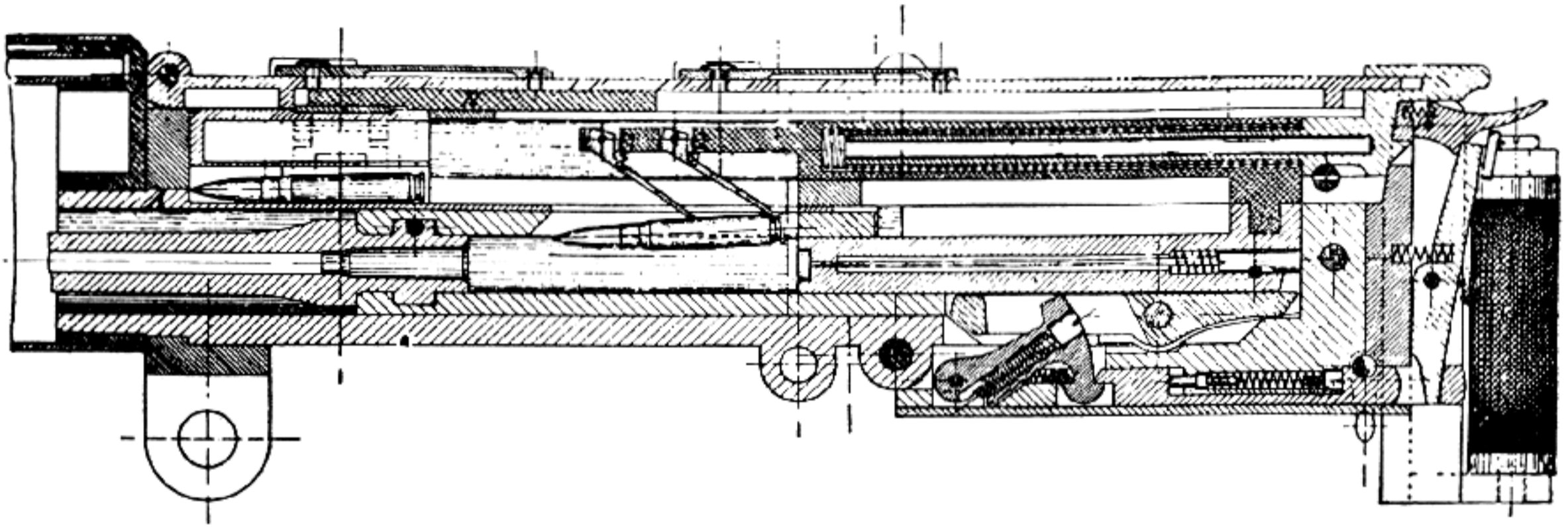

Section Drawing of Dreyse Machine Gun.

located behind the bolt, allowing it to recoil free of the heavier parts.

Actuated by the stud on the barrel extension, the accelerator then drives the bolt to the rear. The hammer is caught by the bolt lock and held to its rear position by the safety sear. The base of the cartridge strikes against the right guide which serves as the ejector and kicks the empty cartridge out the left side of the gun at a down-

ward angle. The rear claws on the mainspring housing draw the new cartridge from the belt, and the housing, continuing to travel to the rear, catches the feed lever by means of a stud. The longitudinal movement is thus translated into transverse motion, actuating the feed slide over one space and positioning the incoming round.

The belt-holding pawl at the same time slips behind the next cartridge in the belt and holds it

for the next phase. The two remaining claws on the mainspring housing depress the withdrawn cartridge into the feedway. The recoil stroke having reached an end, the stored energy in the driving spring then starts the firing mechanism forward. After chambering the round, the accelerator releases the barrel and extension from a retracted position to go into battery. This pivots the swinging lock, which is raised by the cam on the bottom of the receiver, and locks the barrel, barrel extension, and bolt together.

The stud on the main spring housing carries the feed lever all the way in to place the incoming round against a cartridge stop in position for the extractor claw to slip over the cannellure of the cartridge. A projection on the barrel extension will trip the safety sear if the trigger is still depressed. And the last forward movement of the locked bolt and barrel releases the cocked hammer that drives the firing pin forward to discharge the next cartridge.

## PERINO MACHINE GUN

Italian inventors, like those of every other nation in Europe, felt as a matter of national pride that their military forces should be armed with an automatic machine gun that was not only designed but fabricated in their own country.

In 1901 Giuseppe Perino, officer in charge of the Italian artillery factory in Rome, designed a machine gun that must still be admired today for its many advanced features.

The Italian Government, coming to the conclusion that it had a superior arm, immediately placed it in confidential status. Only a few at a time were built and experimented with, until it was felt the weapon was improved enough to compete with well-known machine guns.

In 1908 the government conducted a secret trial to compare the Perino with the Maxim. The test revealed that the Perino had a higher rate of fire than the latter, and that when water boiled in the jacket from prolonged bursts, the liquid could be changed during continued operation in the Italian gun but not in the other.

The mechanism was also found to be of simpler construction and was far easier to handle in the field, although it weighed 50 pounds without mount.

The most objectionable feature noted by the examining board was the delay caused by the need for manual removal of empty cartridge cases from the strips before they could be reloaded. This was an odd complaint since it was a by-product of one of the best and most unique methods of feeding to be found at this early date.

Metal trays holding 25 rounds of 6.5-mm cartridges were fed into the gun from left to right. The ammunition box held five such trays or clips. The weapon fed the trays one at a time from the bottom of the ammunition container. In this manner it was easy for the gunner's assistant to keep the box full by laying loaded ones

on top of the stack. It also allowed a sustained fire as long as the gun functioned. A loaded tray followed immediately behind the ejection of an expended one from the right side of the weapon with the empty brass reloaded in the tray. In this manner of feeding, no metal link or fabric belt was required and no case ejection chute was necessary, since the empty case was placed back in the tray after being extracted from the chamber.

To fire the Perino, a clip or tray of ammunition is inserted in the feed opening on the left side. This is done only when the bolt is in battery, and secured by the pivot lock that is fastened to the barrel extension and engages the locking grooves on both top and bottom of the bolt.

The charging handle is then pulled smartly to the rear. When it reaches its full rearward stroke, a sear engages the bolt recess and holds it in the cocked-bolt position. This movement also indexes a round in position to be chambered. Upon pulling the trigger, the sear releases the bolt, which is then driven forward by the stored energy of the barrel-return spring. The bolt does not strip the round, as in most other machine guns of this type, but pushes it out of the clip into the chamber. It actually passes over the top of the clip where the cartridge was formerly held.

When the round is chambered, it is fired by inertia after the bolt is securely locked. After firing, the barrel, barrel extension, and bolt are locked together until the barrel pressure has reached a safe operating limit. At this point the unlocking lug of the lock engages a cam in a fixed receiver and pivots the lock to free the bolt from the barrel.

At the instant the bolt is freed, the cocking device, consisting of a two-forked lever pinned to the barrel extension, strikes a fixed stop in the bottom of the receiver. Further recoil of the

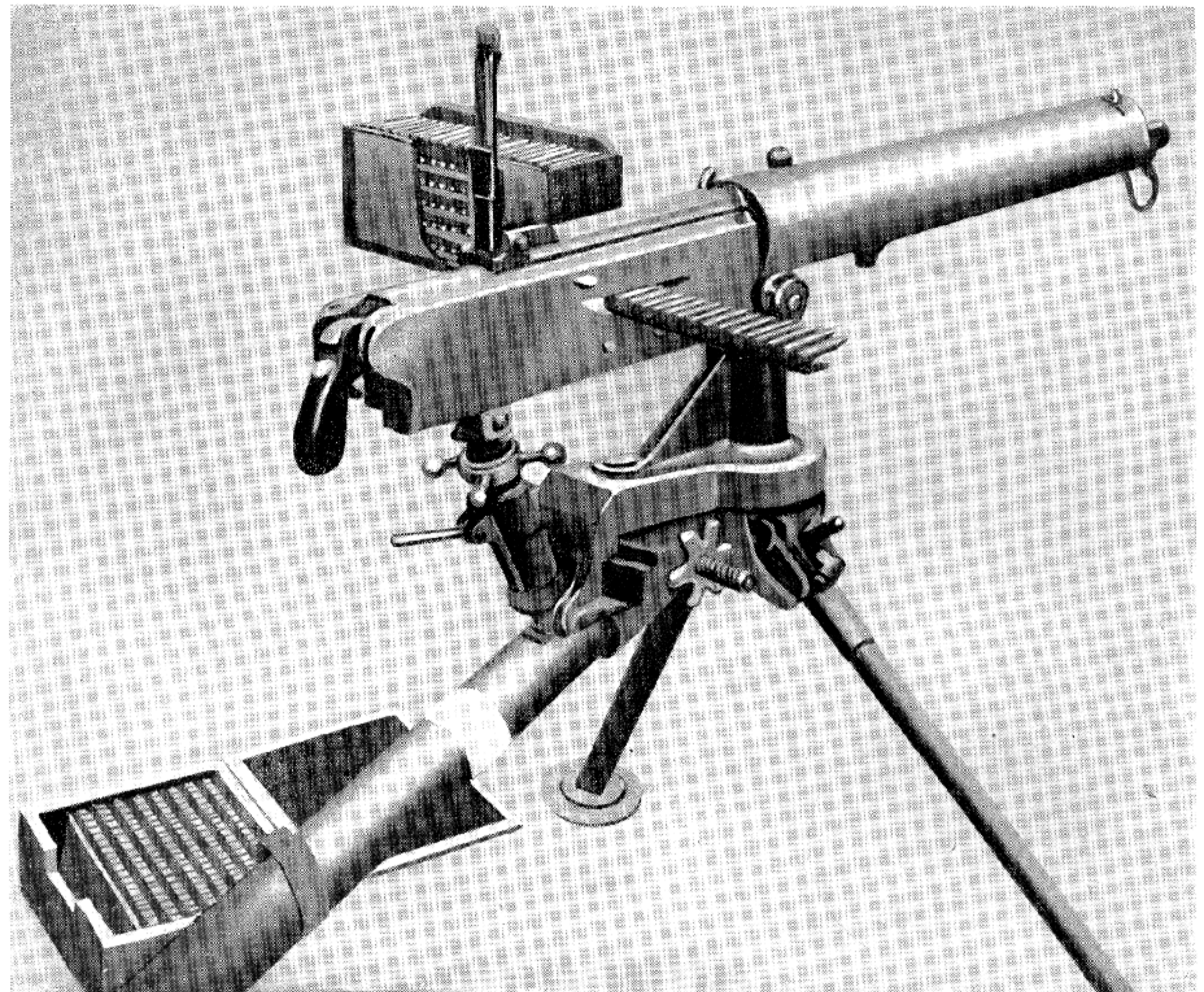

Perino Machine Gun, 6.5 mm.

barrel extension causes the cocking lever to rotate. The top end of the lever engages the bolt, and its rotation first retracts the firing pin and then accelerates the bolt to the rear.

When this movement starts, a lever attached to the barrel extension engages a gear rack in the bottom of the receiver. This is done to utilize all the energy of the extremely long recoil stroke, and to give positive timing between the bolt and barrel cycle. This linkage arrangement acts as an accelerator both for carrying the bolt to the buffer and for returning it to battery, with the bolt and barrel both in their most rearward position. The lever takes the place of a driving spring. For as the barrel return spring forces the

barrel back to battery, this linkage whips the bolt forward, insuring that it will overtake the barrel in time to go into battery together. It also positions the bolt so that the cam-operated lock can engage it, thus preventing any possibility of firing before the piece is securely locked.

The long recoil stroke allows a gradual loosening of the empty cartridge case in the chamber. When the fired brass is withdrawn by the extractor, it travels its length rearward and in place of being ejected from the gun, it is released by the extractor and snapped down in the feed tray. The bolt continues its travel. After it has passed clear of the cartridge tray and is at the extreme end of its recoil stroke, the lug on the

barrel extension cams the feed tray over one space, indexing the next round into position. If the trigger is held, the automatic action will continue.

Italy planned to manufacture the Perino weapon in its federal arms plants, believing that this, coupled with its simple design, would allow the economical production of one of the world's finest machine guns.

After the secret trials the only important change was an alternate method of supplying cartridges besides the strip feed. This modification consisted of a drum arrangement on the left side of the weapon upon which was rolled the belted ammunition fixed on a flexible brass strip. The feature of rebelted empty cartridge cases was retained. The loaded ammunition still was fed in from the left side while the belted empty brass emerged from the right. The belts had a quick detachable snap at two-foot intervals, so that the gunner could instantly separate the strip if he cared to move the weapon's position when the empty brass and belt began to pile up.

This model was designed for cooling both by air and water. When the latter method was used, the barrel acted as a small reciprocating pump operating from recoil, insuring a constant circulation of water in the jacket during firing. A longitudinally ribbed barrel was employed, aiding in the control of dispersion when long

bursts were fired. The ribs gave added strength with little weight and allowed considerably more surface for radiation.

A built-in device at the muzzle, after permitting the bullet to clear the bore safely, trapped the blast. This heretofore wasted energy was employed to accelerate the recoil further. No driving spring was used in this weapon, as the barrel-return spring and accelerator lever returned the bolt to battery. A muzzle booster with this unusual bolt action reached its highest efficiency at 600 shots per minute.

The cartridge was indexed by the surplus barrel-recoil energy. The ammunition tray or belt, if the latter was used, could be released from the mechanism of the weapon merely by pushing a button disconnect. This permitted the clearing of a feed failure without access to the working parts.

To clear a malfunction, the whole right side hinged down and exposed all the operating parts. A soldier, while lying prone on the ground without exposure to enemy fire, could completely disassemble and replace any parts that failed in action. The Italian authorities felt that this feature was of extreme importance.

To keep the weapon in secret status, the government actually purchased and equipped its army with Maxims, while at the same time continuing to perfect the Perino gun. Shortly after

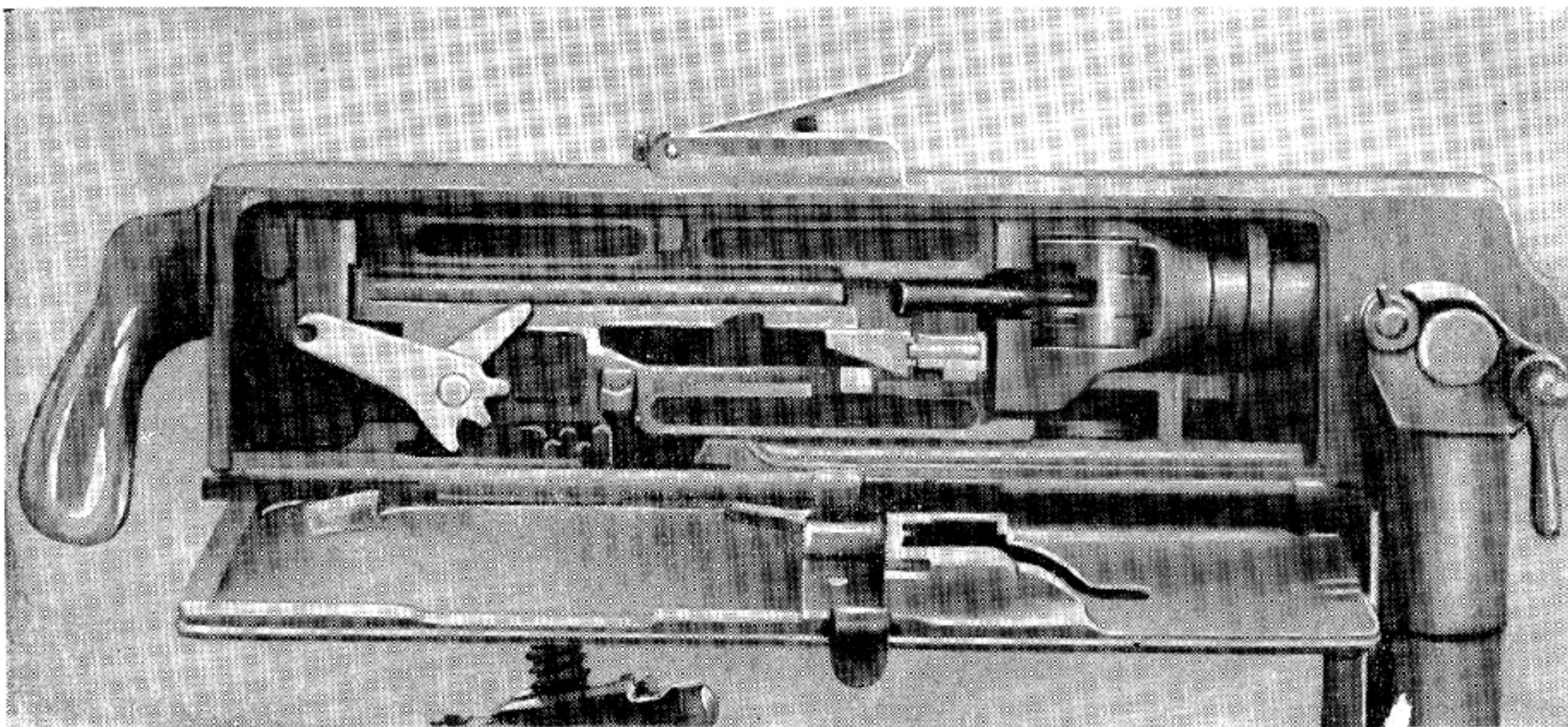

Perino Machine Gun with Right Side Hinged Down to Expose the Mechanism.

the next trial there appeared what is known as the 1908 model, which was only a highly refined version of the original design. A 1910 model followed later.

Still no effort was made by the authorities of the Italian army to put the weapon in open trial. Had the Perino gun been given competition and failures corrected by firing as they appeared, it would no doubt have been ranked with the best

the world had to offer. The ultra-security measures of the Italians did more to retard the development of the weapon than anything else. The gun, having been in existence for so long without any proof of its efficiency, was for this reason considered outmoded before it had been adequately proved. The Perino heads the list of fine machine gun principles that have been stifled by over-security.



## CARR MACHINE GUN

The Navy's Bureau of Ordnance on 14 April 1901 was requested by the Driggs-Seabury Gun and Ammunition Co., 43 Cedar Street, New York City, to arrange a test of a new machine gun at the Naval Proving Ground, Indian Head, Md. The inventor of the gun, produced by this company, was Howard Carr of San Francisco.

The Navy assured Driggs-Seabury that it would give the weapon a trial and consider it for adoption if it proved capable of meeting certain requirements. The date for the test was set for 16 July 1901, at which time the weapon would be given an official rating on rapidity of fire, efficiency, accuracy, durability, and simplicity of design.

Since the request did not originate with the Navy, it was specified that all ammunition used would be provided by the Government but paid for by the promoters of the weapon. This was agreed upon and Mr. Carr, the inventor, arrived at the appointed time with his gun, having elected to fire the weapon himself.

The following account is taken from official records of two trials. Lt. Francis Broughton, USN, Inspector of Ordnance, was officer in charge.

The gun, which was chambered for the caliber .30 Krag-Jorgensen rifle cartridge, was recoil operated and drum fed, having a single barrel. A fire regulator allowed both single-shot and automatic firing. The gun was mounted on a tripod, fitted with a seat for the operator. Changes in both train and elevation were obtained by gear and screw attachments, which could be thrown quickly out of action and the gun aimed by the pistol grip or shoulder stock.

The magazine was circular in shape, and slipped into position on top of the breech end of the receiver. The drum was divided into 62 radial compartments, each holding 4 cartridges, making it hold 248 in all. An even larger drum, holding 310 rounds, 5 to a compartment, was also brought with the gun.

Carr, in describing the weapon's action to the Navy Board, gave the following cycle of operation:

"Upon discharge, the barrel recoils about one inch, extending a heavy return spring fitted underneath the receiver. The barrel and bolt, at the moment of firing, are held securely locked by a jointed lever. The end of this lever engages a scar located in the pistol-grip. After unlocking, the barrel is returned to battery by the barrel return, while the lock continues to travel rearward.

"When about half of the recoil movement is accomplished, the empty cartridge case is extracted from the chamber and ejected downwards through a slot in the bottom of the receiver. A lug on the side of the receiver revolves the magazine and at the same time places a cartridge in position, forcing it down in line with the chamber. The driving spring then completely closes the breech, throwing the toggle lever into a straight line with the breech block, and, in case of automatic firing, releasing the firing pin.

"Automatic or single firing can be obtained by placing the fire regulator in the position desired. Fitted on the right side of the breech is a lever for charging the mechanism by hand. It is used to clear feed failures or any other malfunction that might arise, obviating any considerable delay in firing."

Mr. Carr, in order to demonstrate the general action of the gun to the assembled officers, fired 20 shots singly and 20 full automatic. It worked perfectly during this part of the test. To show how rapidly it was possible to assemble the weapon in the field, the gun, feeder, and tripod were brought in separately. In 40 seconds they were assembled and the first shot fired.

To prove the general efficiency of the mechanism, the Carr gun was tested under the following conditions:

(a) Twenty-five rounds were fired, with a dummy cartridge every fifth round. It was

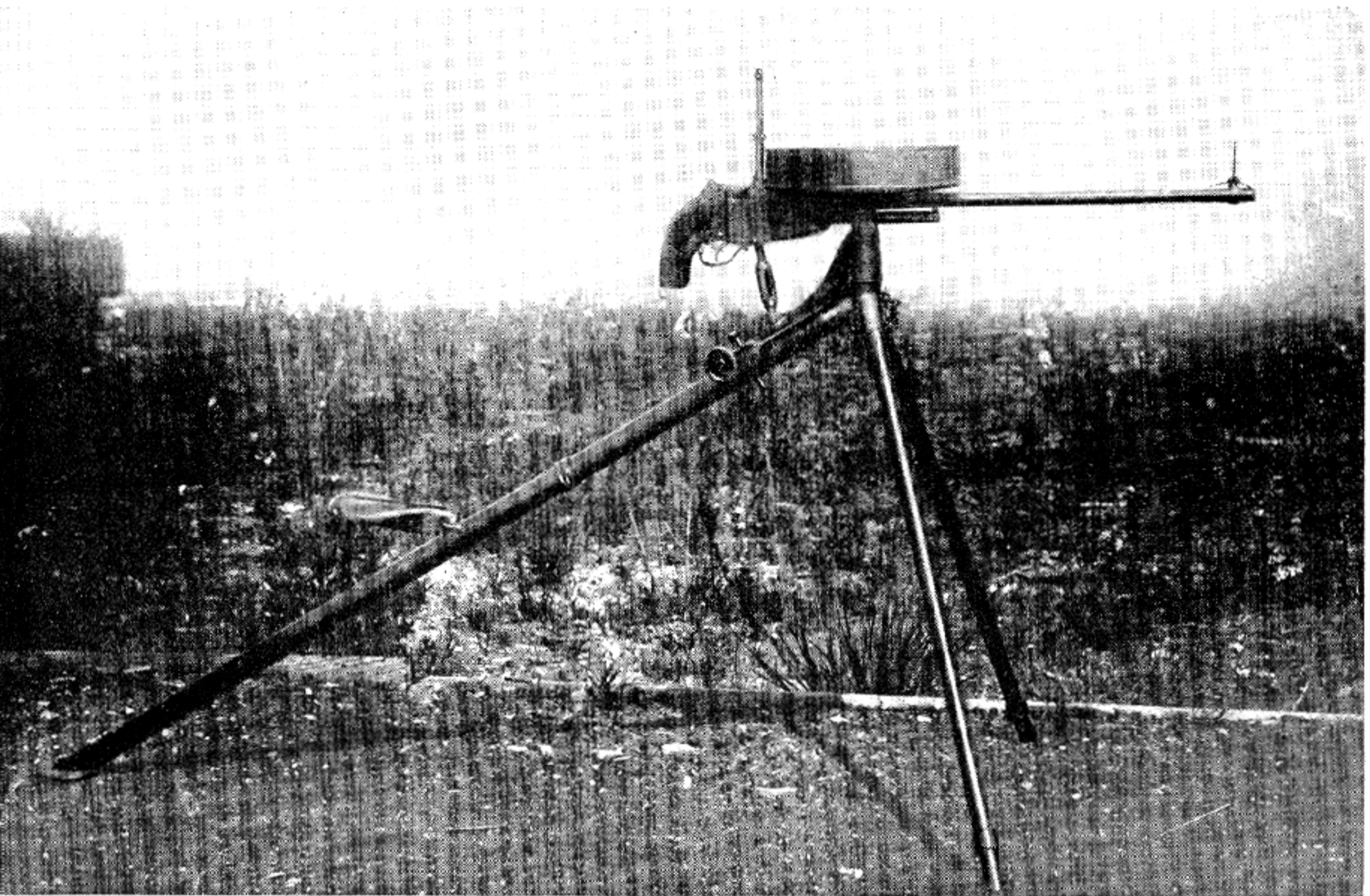

Carr Machine Gun.

found that the "dud" was in every case quickly removed by means of the hand charger.

(b) Twenty-five rounds were fired with one vacant space at the end of the first five rounds, two at the end of the second five rounds, three at the end of the third five rounds, and four at the end of the fourth five rounds. The gun ceased functioning upon coming to the vacant spaces. To resume firing, it was necessary by means of the hand charger to revolve the magazine until the next cartridge was dropped. Ten rounds were then placed in the feeder, one of them being a cartridge that had been purposely deformed so that it would not enter the chamber. When fed into the gun, it jammed the mechanism, but was extracted manually without difficulty.

(c) Fifty rounds were successfully fired with the gun elevated  $15^\circ$ , and another 50 with the gun depressed the same amount.

(d) On two different occasions a handful of dust was thrown into the mechanism, the time

taken to clean the lock and fire the first shot being 35 and 40 seconds, respectively. Carr did not deem it necessary to dismount any portion of the mechanism for cleaning, but charged the gun by the hand-operating lever until all parts worked freely.

Three targets were made at a range of 120 yards, using the Army B target. Seventeen rounds were fired single shot, using the elevating and training gear. Fifty rounds were fired full automatic, using the elevating and training gear. Twenty rounds were fired singly, with the elevating and training gear thrown out of action, the gun being held by means of the pistol grip.

Carr experienced considerable difficulty in holding on the target, so that only a few shots hit the bull's-eye. He attempted to account for this by stating that the sight had not yet been adjusted for drift. As the shoulder bar had not been sent with the gun, it was not deemed safe to endeavor to make a target with the gun firing

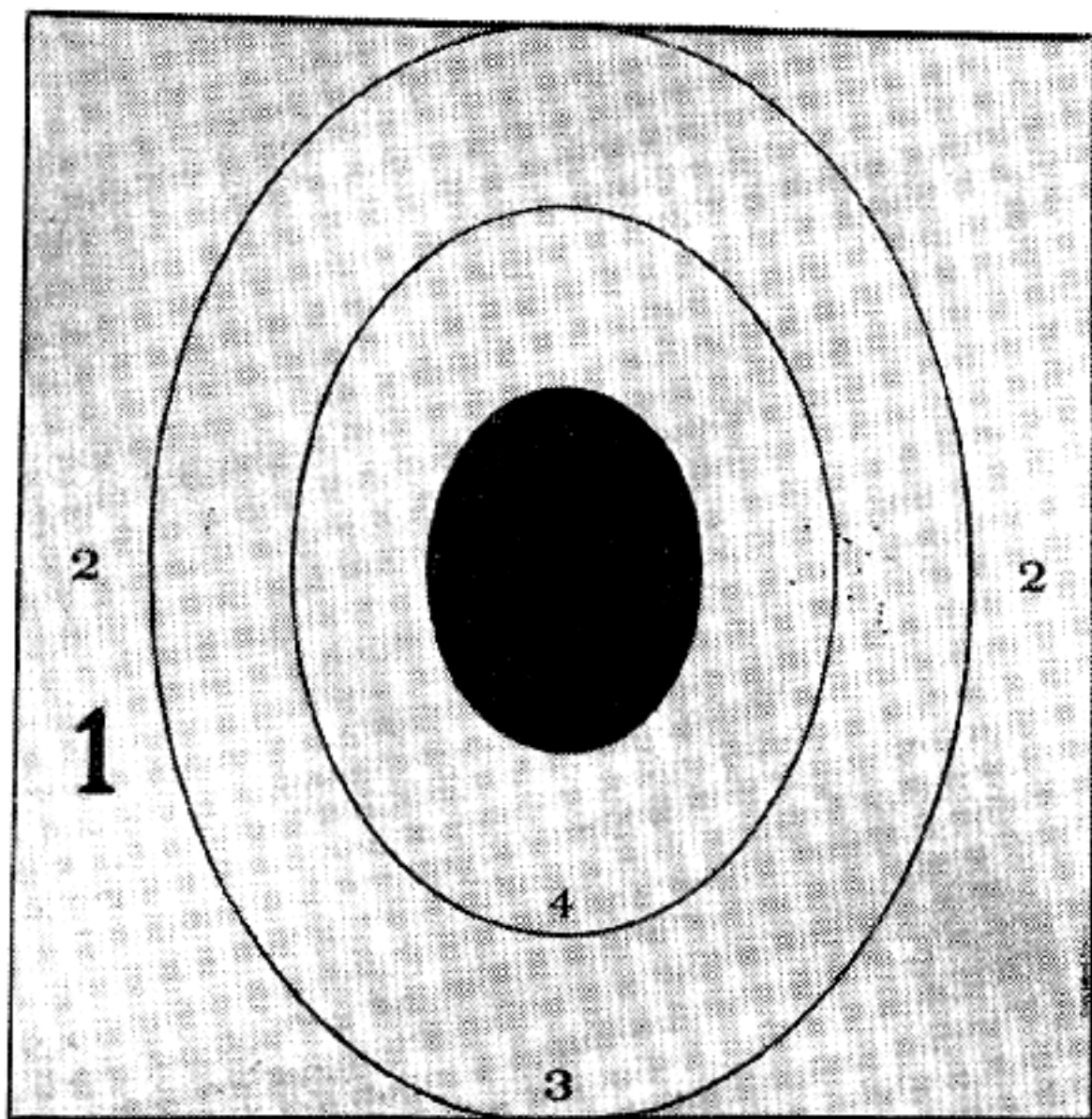

Target Made by Carr Gun in 1901 Trials.

automatic, while the elevating and training gear was disconnected. A velocity check showed 1,966 feet per second 88 feet from the muzzle. The velocity obtained with this cartridge in the Army rifle is given as 1,954 feet per second 53 feet from the rifle.

The bolt was withdrawn by the inventor and entirely taken apart in 50 seconds without the use of any tools. It was reassembled in 3 minutes. There were very few screws, those in use being principally for the purpose of holding small springs. During the test a great many empty cartridge cases were pulled apart upon extraction, breaking at a point about one-half inch from the base. This part was extracted and ejected, the rest of the case remaining in the gun. It was not found difficult to remove it with an ordinary cleaning rod.

In order to ascertain whether the ammunition was defective, 100 rounds were fired in the Colt automatic gun. None of the cartridge cases pulled apart nor showed any signs of breaking. It was, therefore, considered that the defect lay with the gun, and was due either to a swelling of the rear portion of the chamber or to a failure of the breech-block in holding the cartridge home sufficiently secure. The ammunition used came from Frankford Arsenal. It was loaded with W. A. powder and primed with H-48 primer.

It had been intended to test the gun for durability by firing 1,000 rounds as rapidly as possible, observing afterwards the condition of the barrel, the rifling, and the mechanism, and obtaining velocities and targets. As the firing was interrupted frequently by reason of the splitting of the cartridge cases, it was considered impossible to carry out this test.

Another barrel fitted with a small water jacket was sent with the gun. This also would have been used in the durability test, had it not been postponed until the inventor thought his weapon could meet the required demands.

On 25 July 1901 the second and final phase of the trial began, Carr having declared his weapon ready for the endurance and rate of fire test.

It was found that 4 minutes and 45 seconds were required for one man to load a drum with 248 rounds. To test the extractor, six cartridges were coated with varnish, so as to stick in the chamber. They were extracted satisfactorily. In 35 seconds 192 cartridges were fired full automatic; in 40 seconds, 240 cartridges were fired in a single burst. This was at a rate of 360 rounds per minute.

The endurance test of 1,000 rounds of sustained fire was attempted, but interruptions were so frequent that it was not completed. The failures were due principally to: (1) A lack of operating power, the magazine gear not leaving enough force to close the breech; and (2) failure to extract, the extractor slipping from under the rim of the cartridge.

The splitting of the cartridge cases in the first trial was found to be due to the fact that the cartridge was not shoved completely home. This was remedied by screwing the barrel one thirty-second of an inch further into the breech casing, thus forming a more perfect head space. Why the weapon started to rupture cases during the latter part of the second trial was not determined by the board.

The test was then stopped by the officer in charge as the weapon had not shown a degree of reliability that warranted further consideration. Overheating was of such a nature as to cause the weapon's operating mechanism to seize and slow it until there was not enough energy to rotate the feeder and lock the bolt.

It was interesting that this machine gun em-

ployed the drum-type feed that was used so much at a later date. While Hiram Maxim was the originator of this method of feeding, Howard Carr was the first to attempt to put it to practical use. The unusually large number of rounds in the feeder made the weapon breech heavy and when this large mass rotated, it was found that unless the weapon was securely fastened to the front mount it was exceedingly hard to

hold on the target. It also added greatly to the clumsy appearance of the gun.

These were the only official tests run on the Carr weapon. By this time the inventor no doubt realized it had fallen so far short of Navy requirements that to meet them would require complete redesign. On the whole, the weapon was quite inferior to many guns that had already been proved reliable.

## SCHWARZLOSE MACHINE GUN

Andreas Wilhelm Schwarzlose of Charlottenburg, Germany, was an inventor who was already well known on the continent by 1900, having produced many designs for self-loading pistols. His first one used a locked breech with short-recoil action. It was later developed into what was known as the blow-forward system, in which the breech remains motionless while the entire mechanism, including the barrel, goes forward when the shot is fired.

Schwarzlose is best remembered for his machine gun, patented in 1902 but first manufactured in 1905 by the Steyr arms works in Austria. He was perhaps the first machine gun designer to accomplish true simplicity of mechanism. He determined to eliminate the hard-to-manufacture lock and moving barrel of the Maxim and also to avoid any of the gas-operating features of the Hotchkiss. A straight blow-back mechanism, as used in several successful self-loading hand arms, was out of the question; all smokeless-powder high-pressure rifle-caliber cartridges ruptured unless the initial extraction was slow enough to permit pressure to drop to a degree where they would not stick to the chamber.

Schwarzlose solved the problem in an unusual manner. A powerful mainspring and heavy bolt were used that provided inertia enough to resist the first rearward thrust of the exploding powder charge. But this alone was not sufficient. A comparatively short barrel was also employed, coupled with an arrangement of levers that caused the bolt to act at a mechanical disadvantage when trying to compress the mainspring suddenly.

To fire the weapon, a tag at the beginning of the cartridge belt, on the under side of which are held the rounds, is inserted in the belt guide at the lower right side of the feed. The belt is then pulled to the left and over the sprocket wheel of the feeder until the first cartridge engages a tooth. The charging handle is pulled

smartly to the rear three times and released. The driving spring, in taking the parts to battery on the third return, aligns the round with the chamber.

The gun has a double trigger actuated by the thumbs. In order to fire, one thumb has to keep an automatic safety catch to the left before the other can depress the trigger releasing the sear. When the powder charge is detonated, the barrel, not being locked to the bolt, does not recoil as in other automatic weapons. The pressure exerted on the base of the cartridge is transmitted to the face of the bolt. In order to keep the action in a closed position as long as the bullet is in the barrel, the bolt is so constructed that when in battery it forms a linkage. An elbow joint is attached to the bolt with another arm pivoted to a fixed axis in the receiver.

During the initial movement rearward the elbow has to move through an arc. Since there is a very small angle between the linkage and crank when the breech is closed, much of the shock of initial recoil is absorbed by the receiver. This movement is utilized first to withdraw the firing pin from the primer and cock the weapon by engaging the crank handle in the receiver with a camming toe on the cocking piece.

After the retarding action the bolt starts to recoil. It carries the empty cartridge which the extractor is holding by the rim in position to be struck and thrown out of the left side of the receiver by the ejector. The movement of the bolt is completed, against the resistance of the unusually strong return spring, by the acquired momentum of the heavy moving parts of the mechanism. The bolt then starts counterrecoil from the stored energy of the driving spring. When the incoming round from the feed is rolled into position and chambered, the striker is seared off automatically. This operation will continue as long as the two thumb triggers are actuated.

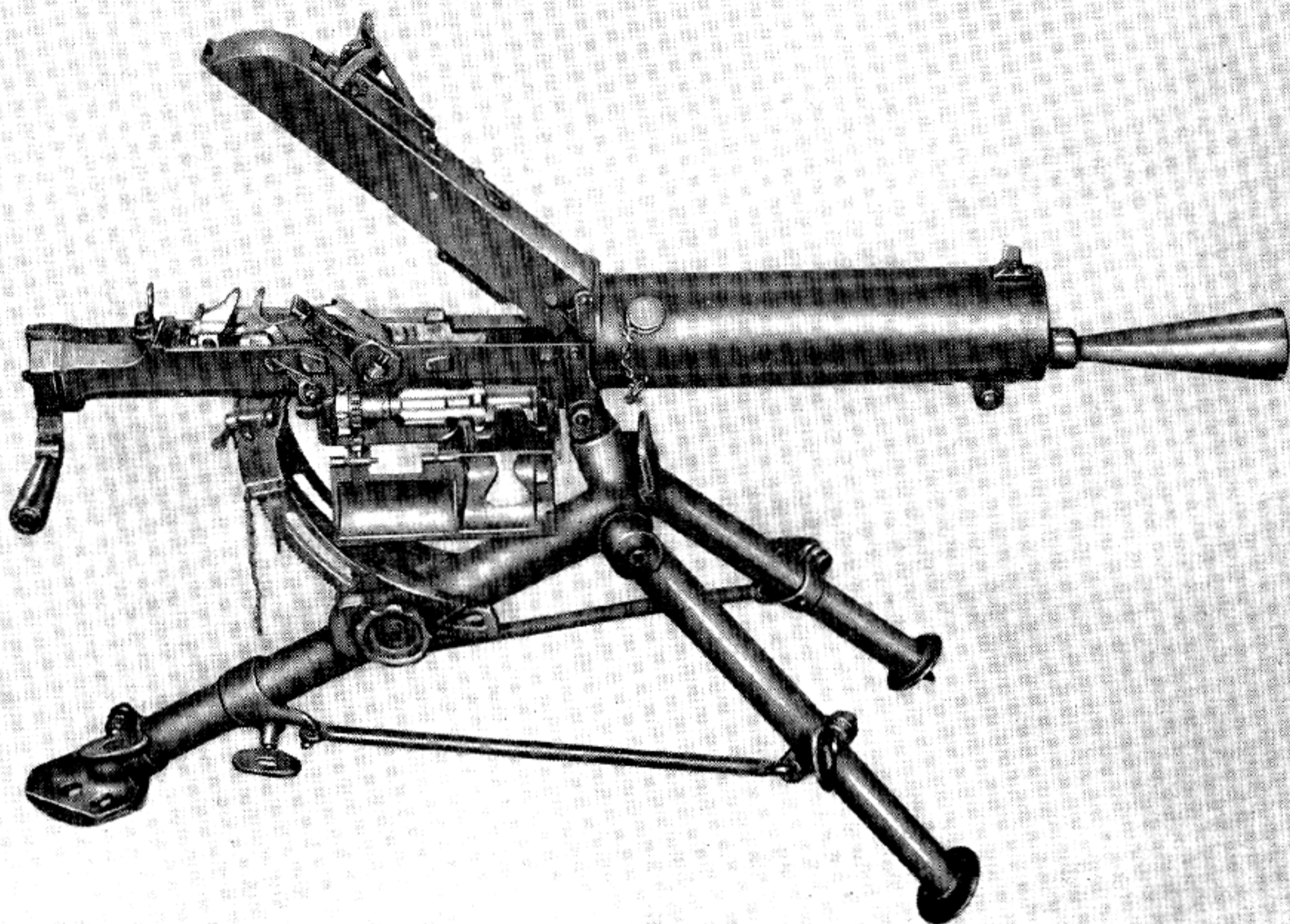

Schwarzlose Machine Gun, Model 1907/1912.

The breech mechanism of the Schwarzlose weapon is never positively locked. The necessary delay in opening the breech is largely dependent upon the inertia furnished by the elbow-type linkage, the resistance of a strong spring, and the absorption of the first shock of the early stage of peak pressure by the receiver. However, the major factor is the use of a 20 $\frac{3}{4}$ -inch barrel. This is the maximum length that can be used to insure the bullet's clearing the bore before recoil of the bolt begins. If any longer barrel were to be used, with the rifle caliber cartridge it was designed for, the mechanism, to be safe, would assume such large proportions that it could not remain in the portable machine gun class.

The Schwarzlose is constructed so that it can be disassembled in a few seconds. In its design the theme of simplicity is followed so closely that operating parts are kept at a minimum. One

outstanding example of efficiency is the employment of a single large rear-positioned spring that serves as a buffer, bolt return, and firing pin spring, performing each cycle in turn.

The feed is unique, being a star-wheel type located on the lower right side. It consists of only two working parts, the feed roller and the detent slide. The roller engages the cartridges in its sprockets as the belt is pulled into the mechanism by action of the bolt on the roller. As the ammunition passes through the wheel, the rounds are slowly cammed rearward for a short distance before the extractor claw on the bolt makes a final withdrawal. This initial movement adds greatly to the ease of feeding, as contrasted with other weapons of a similar nature which attempt to pull the round from the belt by a sudden jerk rearward.

The roller is synchronized with the bolt so

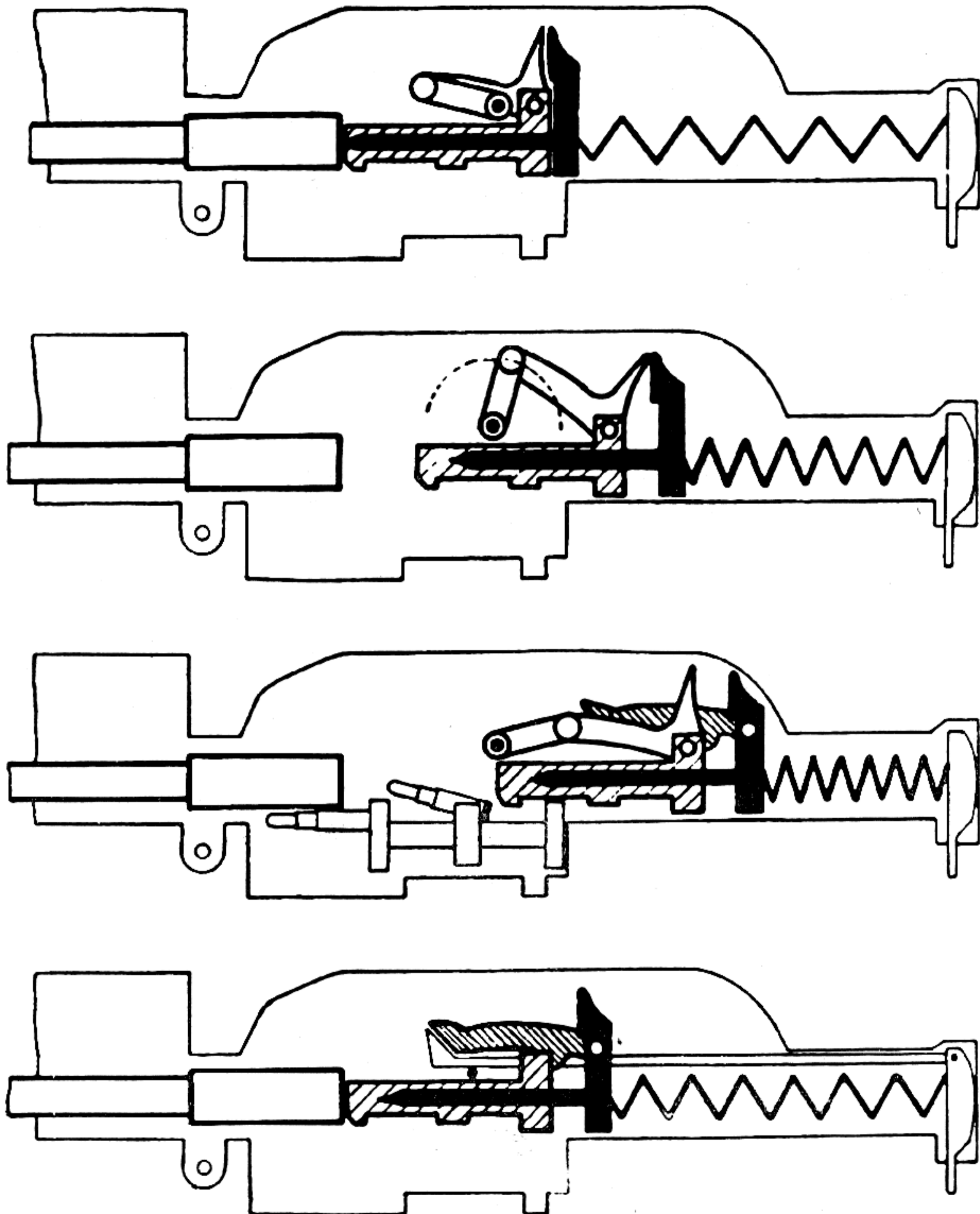

Action of the Schwarzlose Gun.

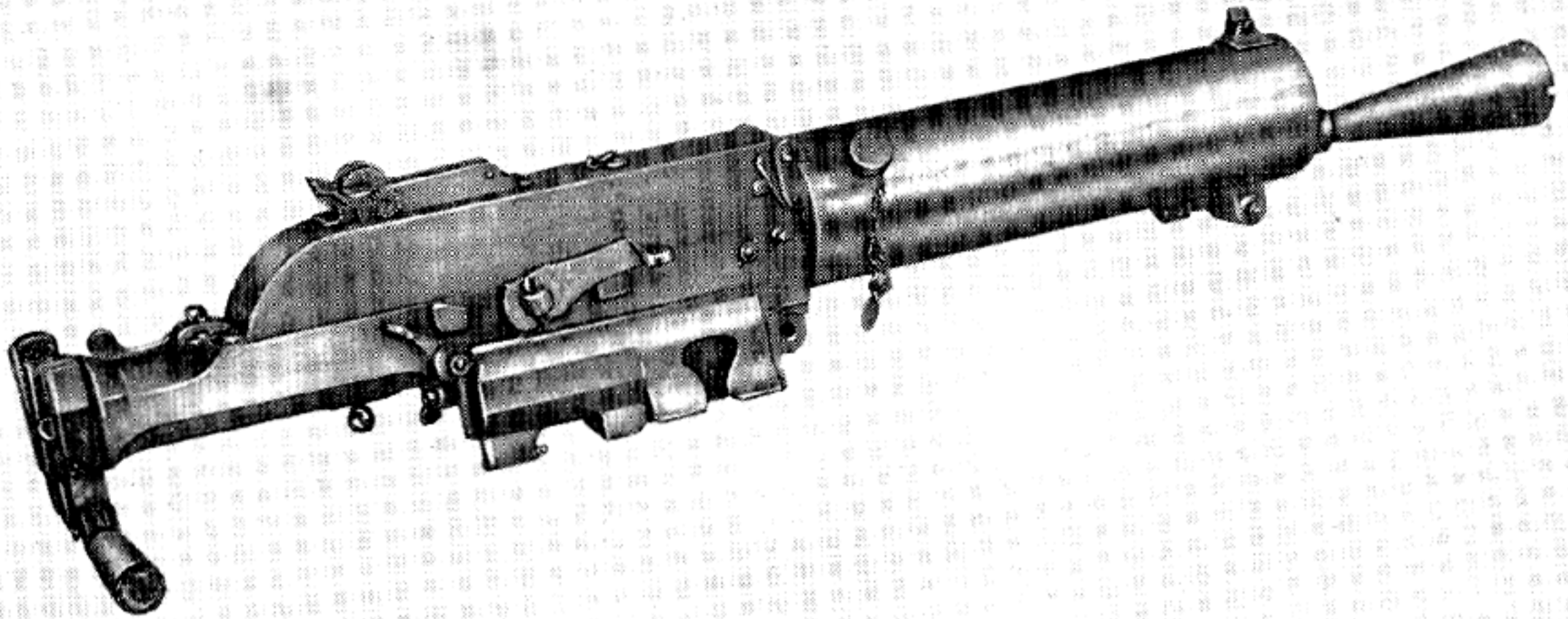

Schwarzlose Machine Gun, 8 mm.

that, when the latter is at its rearmost position, the top sprocket wheel rolls the cartridge upon an inclined shelf directly in line with the chamber. It is so confined in this recess that the rim always makes contact with the bolt face that pushes it forward into the chamber.

This system is appropriately designated retarded blow-back. Due to the fact that the cartridge is extracted under relatively high gas pressure, it was found necessary to lubricate the ammunition. Schwarzlose settled this problem by installing, as an integral part of the weapon, a pump to lubricate the cases. This device pumped a squirt of oil in the chamber between each extraction and loading. The combination of the lubricated ammunition, heavy spring, large bolt assembly, and short barrel allowed the use of an unlocked action which proved quite satisfactory.

The Schwarzlose was fairly popular with European governments and was used by a number of foreign powers at one time or another. The

gun was water cooled, belt fed, and tripod mounted, with all typical blow-back peculiarities, including the low rate of fire of 400 rounds a minute. It was originally chambered for the Austrian service rifle 8-mm rim cartridge, and came in three models, the 1905, 1907, and 1912.

The 1912 model was redesigned to fire dry ammunition, no oil pump being required for its functioning. This was done by adding more weight to the bolt, a heavier driving spring and slightly more angle in the linkage action. Having no breech lock, this new toggle design put the blow-back forces to a still greater mechanical disadvantage, allowing the crank to be moved far enough off center to permit the pressure to push the bolt back more slowly. When the 1912 gun is in battery, the crank is not quite on dead center, so that the first action of the gas pressure is to raise the crank out of line. This longer delay in starting the mass in recoil is just enough to dispense with the lubrication of the ammunition.



## McCLEAN MACHINE GUN

Before going into the description and background of the McClean automatic weapons, first patented in 1902 and government-tested both in 1903-05 and in 1916-18, it is necessary to bring attention to the fact that the inventor is often confused with Dr. James H. McLean, patent medicine salesman and so-called machine gun inventor of the manual-operated period. The designer of the weapons under discussion resembles the St. Louis doctor only in the close spelling of the last name.

Samuel Neal McClean at an early age began to patent improvements on magazine repeating arms. He then progressed to designing a full-automatic firing mechanism and formed the McClean Ordnance & Arms Co. of Cleveland, Ohio, to produce it in both rifle and shell gun caliber.

The first gun made by this new company had a bore of 37 millimeters and was commonly called a one-pounder. This truck-mounted cannon was completely automatic in action and according to the company would revolutionize artillery through its rapidity of fire and mobility.

McClean, feeling that the weapon should be introduced by an official capable of insuring its being brought to the attention of the proper people, employed Gen. Joseph Wheeler, United States Army, Retired, to present the weapon to the Army board for purposes of trial and adoption. The request for an official test was granted and Brig. Gen. William Crozier, Chief of Army Ordnance, ordered that it be scheduled on 10 November 1904. The inventor was allowed to conduct two earlier firings in order to bring to light and correct any malfunctions that might jeopardize the performance during official considerations.

The Sandy Hook Proving Ground was selected for the test. While 670 rounds were fired in the preliminary stages between 8 March and 2 April 1904, many stoppages resulted. It was decided to ship the weapon back to the place of

manufacture after McClean concluded that certain modifications would be necessary.

After the needed changes it was returned and 518 rounds were expended between 17 June and 26 August 1904. While the reworking of the components showed a marked improvement in performance, the gun was again sent to the factory to incorporate in it other refinements in order to be in first-class condition for the official test in November.

In these two warm-up runs, McClean did the firing and other members of the company were present to assist. The Chief of Army Ordnance was also an interested spectator during these attempts. For the final trial an Army board convened at the time set by General Crozier and the weapon was presented and described by the inventor. As each component was disassembled, its function was outlined. The speed with which it could be put into action and its mobility were especially stressed.

The McClean cannon is clip fed and gas-piston actuated, with a non-recoiling barrel. The principal parts are the barrel, the receiver to which it is fastened, the gas cylinder located directly beneath the barrel, and the bolt assembly that operates from and in conjunction with the gas piston. The ammunition is fed into the mechanism by means of two sizes of clips, holding five and ten cartridges respectively.

In order to reduce the shock of recoil, which, if not taken into consideration, would make mobile mounting of such a large bore gun impossible, a device located at the front end of the barrel has been added. This serves as a muzzle brake through the action of the expanding gases striking angular slots in the attachment after the projectile clears. The application of blast at this instant counteracts the recoil forces to a marked degree.

The operating mechanism consists of a reciprocating and rotating breech lock as an integral

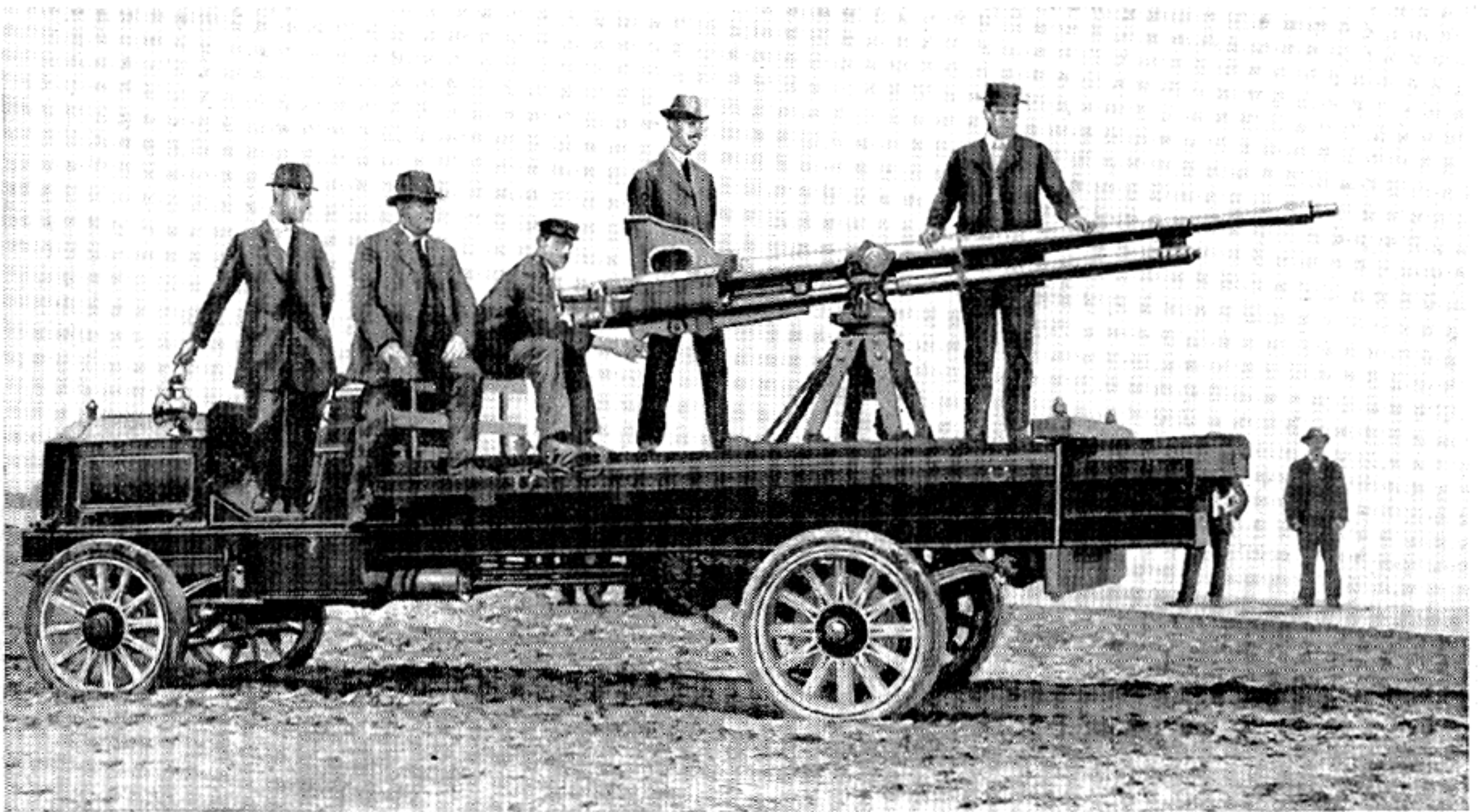

Samuel M. McClean Demonstrating His 37-mm Automatic Cannon.

part of the bolt, a gas-actuated piston, a sear, and a trigger so constructed that single-shot firing can be converted to full automatic without the gunner taking his finger from the trigger. The port in the barrel through which the gas bleeds for action on the piston has a regulator that controls the size of the orifice. The rate of fire is governed by the setting of this device.

The gas-driven piston is so constructed that by a series of consecutive steps it controls the entire cycle of automatic fire. It has a cam engagement with the breech lock which regulates positively the unlocking, reciprocating, and locking action of the bolt by the breech lock. It also has another cam that engages the cartridge feed to insure the alternate positioning of the incoming cartridges. Finally, an inertia-type firing pin and sear notch for engagement with the sear controls firing action for either automatic or single shot.

The heavy steel receiver screws to the breech end of the barrel. It has a cylinder housing in which the bolt travels and a companion opening in which the piston rod moves. On the under side there is a pistol grip encasing the trigger and a dial that can be set to regulate the rate of fire. The upper right hand side has a short

slotted post arrangement in which are slipped the loaded clips. A latch permits the instant freeing of the clips after insertion.

An easily removable gas-actuating assembly is connected at one end to the gun barrel, a short distance from the muzzle, and at the other to the frame. The piston rod is a hollow tube. A piston at the forward end is screw-threaded into the bar to permit a coiled return spring to be added to, or removed from, the piece. The rear part of the piston is provided with an upwardly projecting arm to the forward end of which the firing pin is attached. It has a cam that mates with one on the breechblock to give positive control over the locking action of the gun. Another cam on its right side engages the feed in such a manner as to position and then chamber the incoming cartridge.

The breechblock is a cylindrical bolt having an interrupted screw thread. This forms a series of lugs that are cammed down into the locking recesses cut in the receiver near the chamber. A heavy conical-shaped firing pin is also fastened to the piston. The lugs have to be in position for engagement before the piston can advance all the way into battery and drive the firing pin

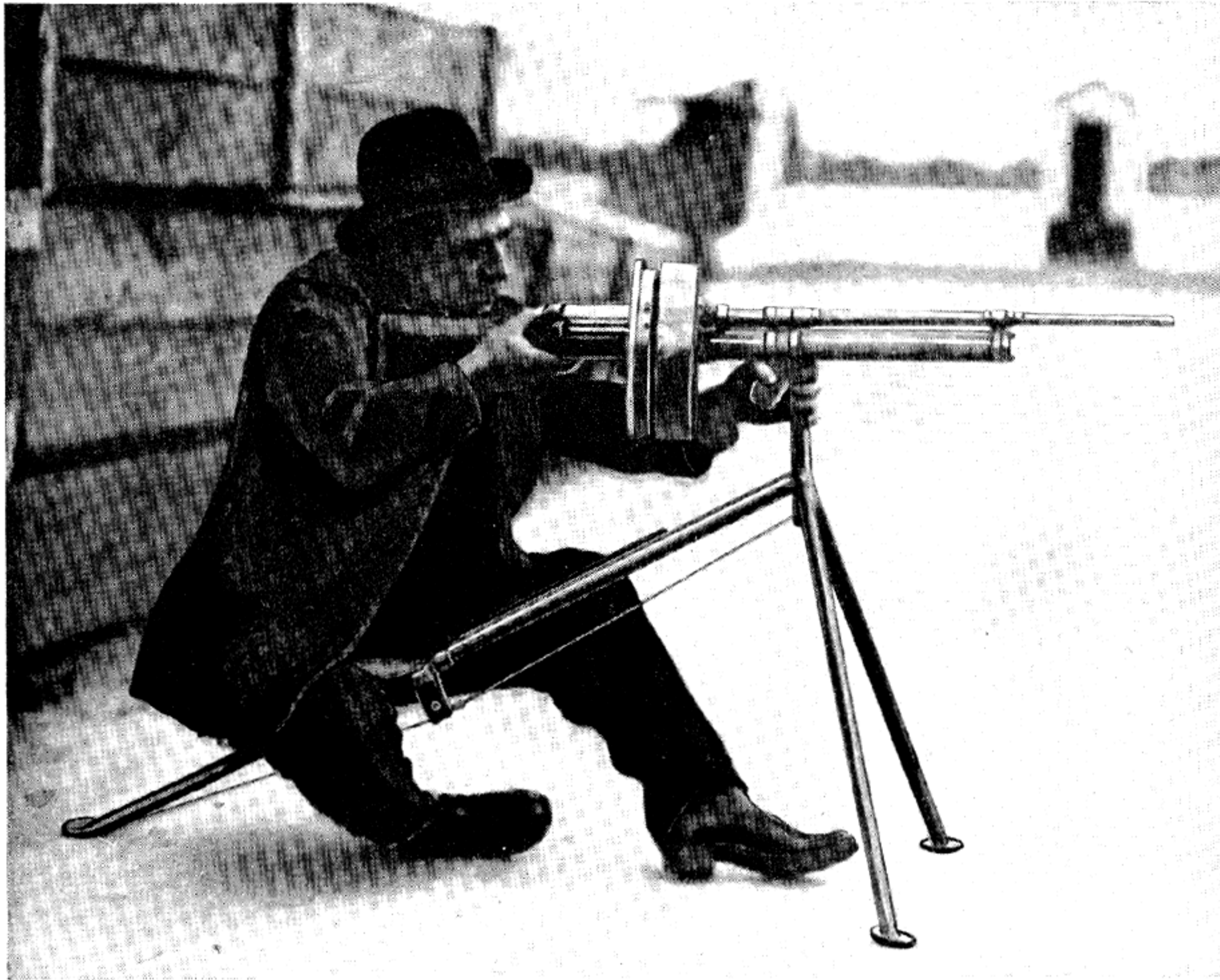

McClellan Machine Gun, Cal. .30, Being Fired by the Inventor.

into the primer. The bolt also houses the extractor hooks which are short stiff hooks so formed as to lock into the extractor seats and fasten over the rim of the cartridge in a modified form of T slot. It is not released until the empty case has been fully withdrawn.

A swinging lever, which is a part of the bolt, is designed so that when the empty cartridge is over the ejection opening in the receiver, the rear of the ejector rides up on an angle and pivots the front down. The spent round is thus knocked clear of the operating parts.

The whole extractor and ejection system is carried on the bolt in three pieces, two extractors and the ejector, which could be removed from the gun and replaced in a matter of seconds. The

firing indicator lever, with a dial showing the type of firing desired, is located on the right side of the pistol grip. The entire mechanism can be completely disassembled and put back together without the aid of wrenches or tools other than a specially designed shoulder bar.

The cartridge slips are formed of sheet metal and have a flanged guide that form a T slot to engage the rims of the shell cases. They were designed for five or ten rounds as desired. The ammunition is the standard service fixed one-pounder or 37-millimeter with a muzzle velocity of 2,100 feet per second and capable of generating a maximum chamber pressure of 25,000 pounds.

Five proof charges were fired with the Mc-

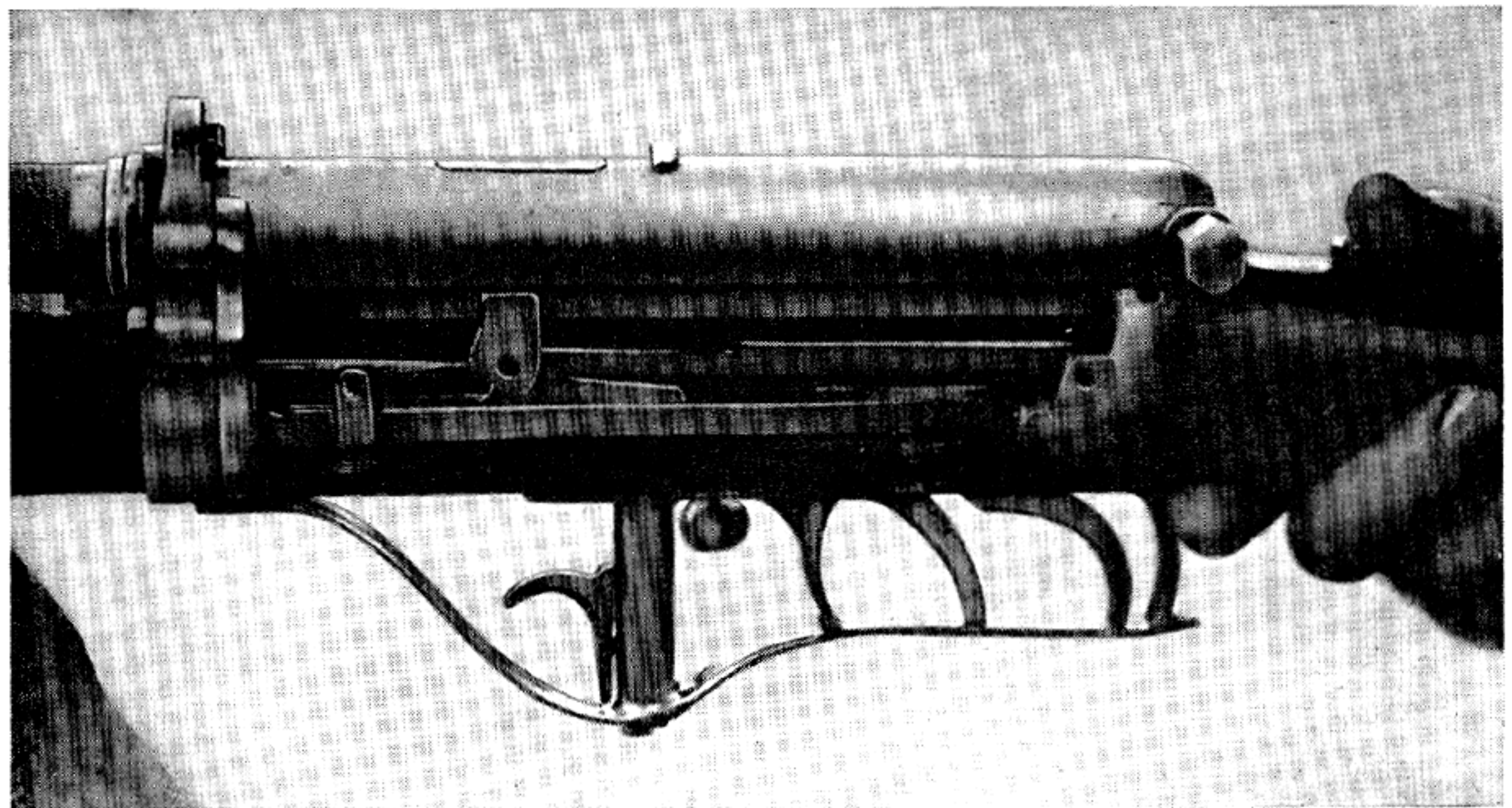

McCleean Machine Gun.

Clean automatic cannon that reached a peak pressure of 39,700 pounds and a close visual inspection showed no breakage or deformation of parts. But when the official tests for automatic fire got under way, numerous stoppages were encountered, most of them being feed jams. When these were cleared, an attempt was made to fire 100 rounds in two 50-round bursts; during this try there were eight malfunctions. The stoppages were the result of the piston slowing up and finally halting. The officers present thought this was due to the expansion of the moving parts from heat.

A total of 200 rounds were tried next in one burst; this was done in 6 minutes and 51 seconds. It also was not accomplished without piston seizure taking place. Temperature of the bore at the muzzle was taken before starting and recorded at 230° F.; at the end of the burst it was 428°.

It was observed that all stoppages took place when the end of the feed pawl was in the cam groove at the rear position of the piston's stroke. The board was asked that McCleean be allowed to change the angle of the cam slightly with a view to improving conditions. This was permitted; however, the time delay was charged to

the gun. When firing resumed, the same type of stoppage persisted. After 1,182 rounds had been fired, the trial was terminated. McCleean expressed a desire to send the piston back to the factory and increase its diameter in order to give it more operating power.

The weapon had a very improved buffer for this early date. It operated by compressed air, the recoiling parts striking the piston backed up by a high air pressure.

The following conclusions are taken from the official reports of the Army board:

"The results of the trials of the gun and mount are not satisfactory. . . . The muzzle attachment takes up a considerable percentage of the recoil in a useful manner: the reciprocating piston rod and its control of the breechblock is simple and effective and its action has not, so far as observed in these trials, been materially interfered with by fouling of the piston from the powder gases. The mechanism of the gun otherwise comprises a large number of springs and small parts which govern important functions in operation and the trials have been characterized by a great number of breakages and interruptions, including especially the feed mechanism, the extractors, the ejector, and the cushion pis-

ton. The sights are not satisfactory, nor the training gear. The rate of aimed fire is very low. It has not been practicable to secure a good rate of continuous fire at will, and the accuracy of fire at fixed targets, and especially at moving targets, shows a very low standard generally.

"The failure . . . [of the piston rod] . . . to work properly especially in the 200 rounds continuous automatic action test and also in the dust and rust tests renders the trials unsatisfactory. It is thought a gun of this character should be capable of delivering a considerably greater number than 200 rounds continuous fire without trouble, and the number of rounds for this test in one-pounder automatic guns in future may properly be increased to 300."

The members of the board were: Charles S. Smith, Colonel, Ordnance Department, president; R. Birnie, Major, Ordnance Department; George L. Anderson, Major, Artillery Corps;

and B. W. Dunn, Major, Ordnance Department.

To fire the McClean one-pounder, the gunner drops five loaded rounds into the hopper feed and pulls the operating mechanism rearward by means of a drawbar. When released, the parts are driven forward as the compression of the driving spring strips the round from the feeder and chambers it. Continued movement forward locks and cocks the piece.

When the trigger is pulled, the exploding powder charge starts the projectile through the bore. After it has passed a port in the barrel, the expanding gases enter the gas cylinder and impel the actuating piston rearward. Mounted on the piston is the unlocking lug to which is attached the firing pin. The first movement rearward withdraws the pin, which works in a slide-way in the piston, and further travel of the piston rotates the bolt body with its lugs, thus unlocking the action.

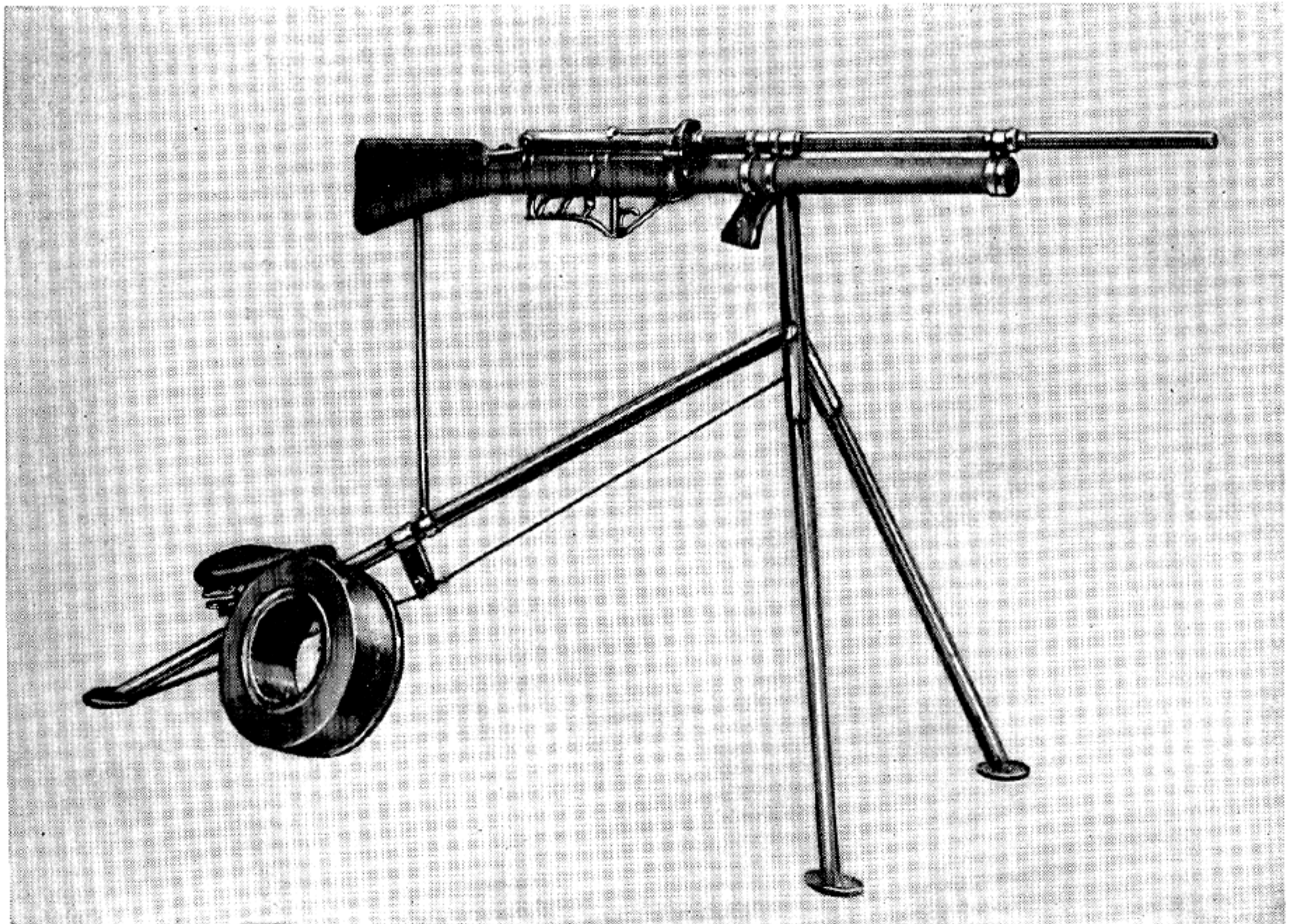

McClean Machine Gun with Feed Drum.

The projectile has now safely cleared the muzzle. The empty shell case withdrawn by the extractors is held by these pieces until the opening in the bottom of the receiver is reached. A pivoting ejector then snaps over the bolt face, striking the empty case and knocking it through the ejection slot.

The operating parts continue to recoil until the rear buffer is struck. The latter absorbs all surplus energy and, aided by the fully compressed driving spring, starts counterrecoil movement. A raised part of the bolt body makes contact with the first round in the hopper and starts to chamber it. At a distance of one and a half inches from battery, the firing pin is held in a retracted position while the gas piston, in going home, fully rotates the bolt body, engaging its lugs in their locking recesses. The obstruction in front of the firing pin is removed by this means, and if the trigger continues to be held back, the striker flies forward to drive the firing pin into the primer.

The stockholders of the McClean Arms & Ordnance Co. were so disappointed at the performance of the automatic cannon that they would not underwrite another venture on the weapon and for the most part dropped all financial backing of the company. Reorganization followed, but instead of developing the larger gun, this time all energy was placed on producing a caliber .30 automatic lightweight machine gun, chambered for a service rifle cartridge. For promotional work the services of Lt. Col. O. M. Lissak, United States Army Ordnance, were secured. The weapon when produced was even called the McClean-Lissak machine gun, although there is nothing to show that Lissak contributed anything beyond his business ability. The weapon was still McClean's early invention with many features of the automatic cannon being scaled down to rifle caliber and used in this model.

It was quite apparent that the designers tried to create a weapon that excelled any known weapon in every feature. The McClean-Lissak weighed only 19 pounds and the operating parts were fewer in number than those of the Benét-

Mercié. The company claimed the barrel could be removed in one-half the time required by any other machine gun.

The McClean cannon, which never passed a successful proving ground test either for the Army or the Navy, dropped out of existence for a while. During World War I, Russia, desperately in need of any kind of armament, did buy quite a number from its new producer, the Poole Engineering Co. of Baltimore, Maryland. As late as 1916 the United States gave Poole Co. officials another chance to demonstrate the "improved" model, but it also failed as miserably as its predecessors.

This gun, with its unenviable record, still has a leading place in weapon history. The features patented by Mr. S. N. McClean were assigned by him to the Auto Ordnance Co., of Buffalo, New York, and were later used in the devisement of one of the outstanding early aircraft machine guns. A close study reveals the similarity of construction in the two arms.

After McClean had sold his patents to the Buffalo firm and their utilization in an adapted form had turned out to be highly successful, he tried once again to produce a machine gun by a method known as reversing the principle.

The flat drum feed was moved from the top to the side, making the weapon very cumbersome and heavily unbalanced at the part to which the feed was attached. The mechanism itself was practically identical with the one-pounder. In May 1919 McClean finally interested the Navy to the extent that he was allowed to demonstrate this model to the Bureau of Ordnance at the Naval Air Station, Anacostia, D. C. While he did fire the weapon to a more or less satisfactory degree, it did not warrant, in the opinion of the Chief of the Bureau of Ordnance, any further testing and on 31 May 1919 McClean was so notified.

This decision ended his long period of machine gun development. And while it takes considerable research to identify his name with productive machine gun design, nevertheless automatic arms development owes much to his patient inventive efforts.

## CHAUCHAT MACHINE GUN

In 1903 the French Government, having what it felt was an adequate heavy machine gun, started looking about for a machine rifle as a companion arm. Of the numerous types taken under study, the French Army board became interested in an extremely lightweight automatic arm that could be fired either single shot or full automatic and be carried by the soldier with as little difficulty as the standard infantry rifle. It became known as the Chauchat.

This weapon, while originally made at the French Government arsenals, was most certainly not native in design. It was undoubtedly inspired by the experimental weapon invented by the Hungarian arms designer, Rudolf Frommer, who

had already become well known for his weapons built on the long-recoil system and had demonstrated a similar design at an earlier date. The fact that this machine rifle employed the long-recoil system for its operation is in itself of great interest, as it represents the only automatic machine gun ever produced by France that did not use gas as the actuating force. Although it has been experimented with by inventors of every country in the world, the French for some reason have always looked upon the operation of machine guns by gas as a specialty of their own. That they should deviate at this time indicates an outside influence in the matter of design.

The Chauchat employs a front-locking bolt



Chauchat Machine Rifle, Model 1915, 8 mm.

that releases on the straight-pull principle found both in Mannlicher and Frommer self-loading pistols. This rotary bolt has four locking lugs, is of heavy construction, and is actuated by a recoiling non-rotating sleeve. In this piece are incorporated the striker, a hook to engage the sear, the feed bar which projects forward under the bolt, and the cocking piece which in turn carries a rod to operate the feed block.

The tail of the bolt has two cams which engage in helical slots cut in the sleeve. They are locked together in the retracted position by a spring-loaded stud which is released only when the bolt is in the act of turning in battery position. The helical slots in the sleeve are cut on a shallow pitch, so that the sleeve carrying the striker must advance one full half inch after the bolt is closed and locked before the striker can make contact with the primer of the chambered cartridge. Another unusual safety feature is that a spring-loaded plunger projecting from the face of the bolt must be compressed by the rim of the seated cartridge in order to remove the plunger from alignment with the striker point. In effect, the bolt must be home, securely locked, and the plunger cammed back by a round in the chamber before the primer can be touched.

The feed is semicircular in construction and holds twenty 8-mm Lebel cartridges. Its unusually clumsy design is very adaptable to the steeply conical round. A swinging feed block operating in conjunction with the cocking piece during the cycle of operation first positions and then guides the incoming rounds from the circular magazine into the chamber.

To fire the Chauchat, a loaded magazine is inserted between the side plate and bottom of the barrel. The rear end is then pushed up until the magazine catch snaps, holding it in position. To fire single shot, the fire regulator is changed from "S," or *safe* ("sur" in French), to "C," or *control* ("controle" in French). If automatic fire is required, the regulator is moved to "M," *machine gun* or *automatic fire* ("mitrailleuse" in French).

Assuming that automatic firing is desired and the regulator is properly set, the operating knob is pulled to the rear until the sear engages the notch in the feed piece holding the action in the cocked-bolt position. Pulling the trigger rear-

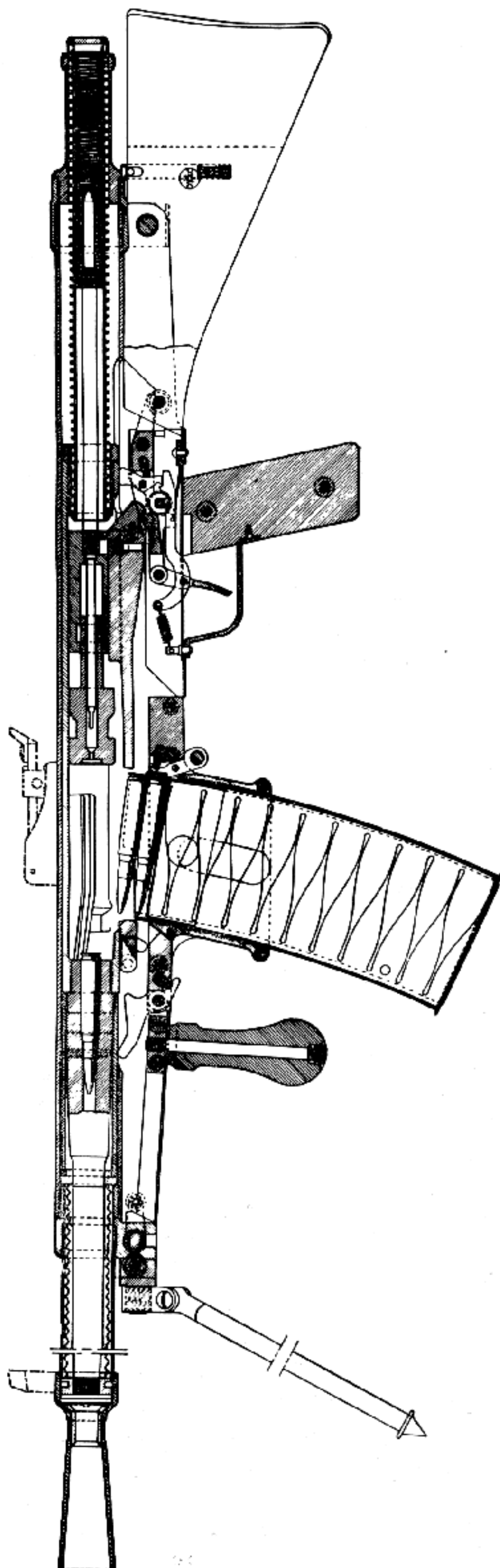

Section Drawing of Chauchat Model 1918, Cal. .30.



ward releases the operating mechanism, allowing it to fly forward under energy of the compressed driving spring. The rolling action of the cocking assembly pushes a cartridge from the magazine mouth, where it is picked up by the bolt and chambering of the round begins. This action is assisted by the cartridge guide which cams the point of the bullet up into the entrance of the chamber. A cam then moves the guide out of the way of the magazine mouth.

As the bolt travels forward, the locking lugs are vertical. To insure their remaining temporarily in this position, the bolt stop is used. This consists of a conical plug that fits partly in the bolt body and partly in the bolt head, thus preventing a torque motion between the two parts except when released. When the cartridge is firmly seated, the bolt stop rides inside the breech housing forcing the bolt head to turn. This locks the assembly securely when the movement forward has reached its limit. The driving spring continues to drive forward the portion of the bolt body that carries the striker, since the final rotary motion of the locking lugs frees the striker to detonate the primer.

The bolt, barrel, and barrel extension recoil rearward, still locked together, for a distance greater than the combined overall length of the cartridge case and bullet. At a point slightly less than its full recoil stroke, the bolt lugs unlock

the bolt from the barrel extension and barrel. The bolt is then held to the rear by a sear device and the barrel extension and barrel counter recoil. As the rim of the fired cartridge is held secure by the extractor in the bolt face, the barrel and barrel extension, in starting forward to battery, pull away from the spent brass. When the barrel has traveled a distance that will permit it, a spring-loaded ejector bearing on the empty case kicks it from the ejection slot in the right side of the receiver.

If the trigger remains depressed, the barrel assembly cams the sear off just before it reaches battery, releasing the bolt that had been held to the rear and the cycle is repeated.

No more crudely designed nor uglier automatic weapon has ever been put in the hands of soldiers of a first-rate power than this weapon. The Chauchat was cheap to construct and easy to adapt to mass production methods, as its careless manufacturing tolerances were of such a nature that anything could be accepted. When the danger of war became imminent, it was made by the thousands. To cite instances of its simple construction, the barrel jacket, barrel extension and receiver were constructed of convent tubing. Even the locking lugs were stamped and shrunk on, and the remainder of the frame consisted of assembled stampings that were screwed together. Anything resembling refinement was



American Troops Training with the Chauchat Machine Rifle.

conspicuously absent. The handle did not even have the appearance of a pistol grip, being only a simple angled piece of wood screwed onto a trigger guard and frame. And while the total production ran into many thousands, there was no interchangeability of parts, as the French methods did not call for such close gaging of components. Thus, the weapon could be considered hand finished as far as interchangeability is concerned.

The weight of the Chauchat weapon (19 pounds, including folding bipod) definitely placed it in the lightweight machine rifle class. The extreme distance of travel of the operating parts, brought about by the long recoil action, made it difficult to hold on a target and consequently it was very inaccurate. It is to be considered incomparably the worst machine gun of its class used by any belligerent in World War I.

At the time the United States entered the conflict, the country did not possess anything comparable even to the Chauchat, and when the A. E. F. landed overseas, the Government con-

tracted with the French for enough of these weapons to arm each division as it arrived. While the American troops read glowing accounts of production feats at home with the superior Browning automatic machine guns, they were compelled to fight the war to the end armed with Chauchats. It is a matter of record that their issue to American troops was nearly twice what was anticipated as they were almost invariably thrown away in action.

The use of a weapon designed for the French cartridge made it necessary for our supply department to carry two kinds of rifle ammunition as all combat units had guns with both calibers. This situation was undesirable from a logistics viewpoint. It was found that with little difficulty and few changes the 8-mm Chauchat could be rechambered to take our caliber .30 service cartridge. On 17 August 1917, 5 months after we were in the war, an order was placed with the French commission to alter 25,000 weapons in such a manner. The revised gun was to be known as the caliber .30 Model 1918, with the reworking to be carried out by the original



The Chauchat in Action with American Troops.

producers of the basic mechanism. As a result it was practically the same arm as before, except for the chamber. The magazine was cut from 20- to 16-cartridge capacity and there was a slight increase in rate of fire. The modified gun did not even approach expectations, being more unreliable than the original. The most prevalent malfunctions were parts breakage, feed jams, and cartridges sticking in the chamber as soon as the barrel became slightly hot.

Despite many requests from the field for certain changes, it was impossible to incorporate them because of the way the contract with the French was drawn. All modification and inspection was placed in their hands and the guns, as soon as passed by the French inspectors, were shipped to this country to arm divisions about to go overseas.

From 31 December 1917 to 3 April 1918, 37,864 Chauchats were purchased in 8-mm or altered to caliber .30, and nine American combat

divisions were armed with them in the United States before sailing for Europe.

The gun got its name from Colonel Chauchat, chairman of the French commission that adopted it. It was customary in European countries, for some reason that can only be surmised, to name a weapon for a high government official, particularly if the said person showed an especial interest in the adoption of the piece under consideration. By the same token, this machine rifle is sometimes called the C. S. R. G., paying tribute to all members of the board that selected the automatic rifle for the French Army. The board was composed of Messrs. Chauchat, Suterre, Ribeyrolle, and Gladiator.

The last named member of the board at a later date went to Greece and manufactured the identical weapon with his own name on the piece in lieu of that of Chauchat. From the character of the gun's reputation, one can only marvel that anyone cared to have his name so implicated.

## BERTHIER MACHINE GUN

The French Army, from the earliest days of automatic arms, has considered gas operation as the most logical method of deriving the necessary forces to actuate the firing mechanism. As was customary at the time, practically every young officer showing any aptitude in advanced weapon design was given a chance to carry out his ideas. Most notable of these was Lt. André Virgile Paul Marie Berthier, who, feeling that the Hotchkiss heavy machine gun was adequate in its field, tried to make for the infantryman a lightweight machine gun that could be carried with the ease of a carbine and at the same time had the fire power of the heavier weapon.

As early as 1905 Berthier applied for a patent in Belgium while serving in Constantinople, Turkey. His first gun was simply a straight pull rifle of the Mannlicher type. A gas cylinder with piston was installed on the right side of the receiver. It drove the bolt handle rearward by

means of gas pressure being exerted on the face of the piston. The bolt and handle were returned by driving-spring compression. The weapon used a conventional magazine feed located underneath it. This model was known on the continent as the Berthier-Pacha. The latter name, also spelled "Pasha," was added as an honorary title granted by the Turkish Government in recognition of Berthier's contribution to ordnance.

Three years later he perfected another design that would fit the specifications demanded for an infantryman and still be rugged enough to stand the rigorous trials of the French proving grounds. The weapon, when it first appeared, was known as the Berthier Model 1908.

The rate of fire on this early Berthier was approximately 450 rounds per minute. It was first manufactured by the Anciens Etablissements Pieper at Herstal, Belgium, and a pamphlet pub-

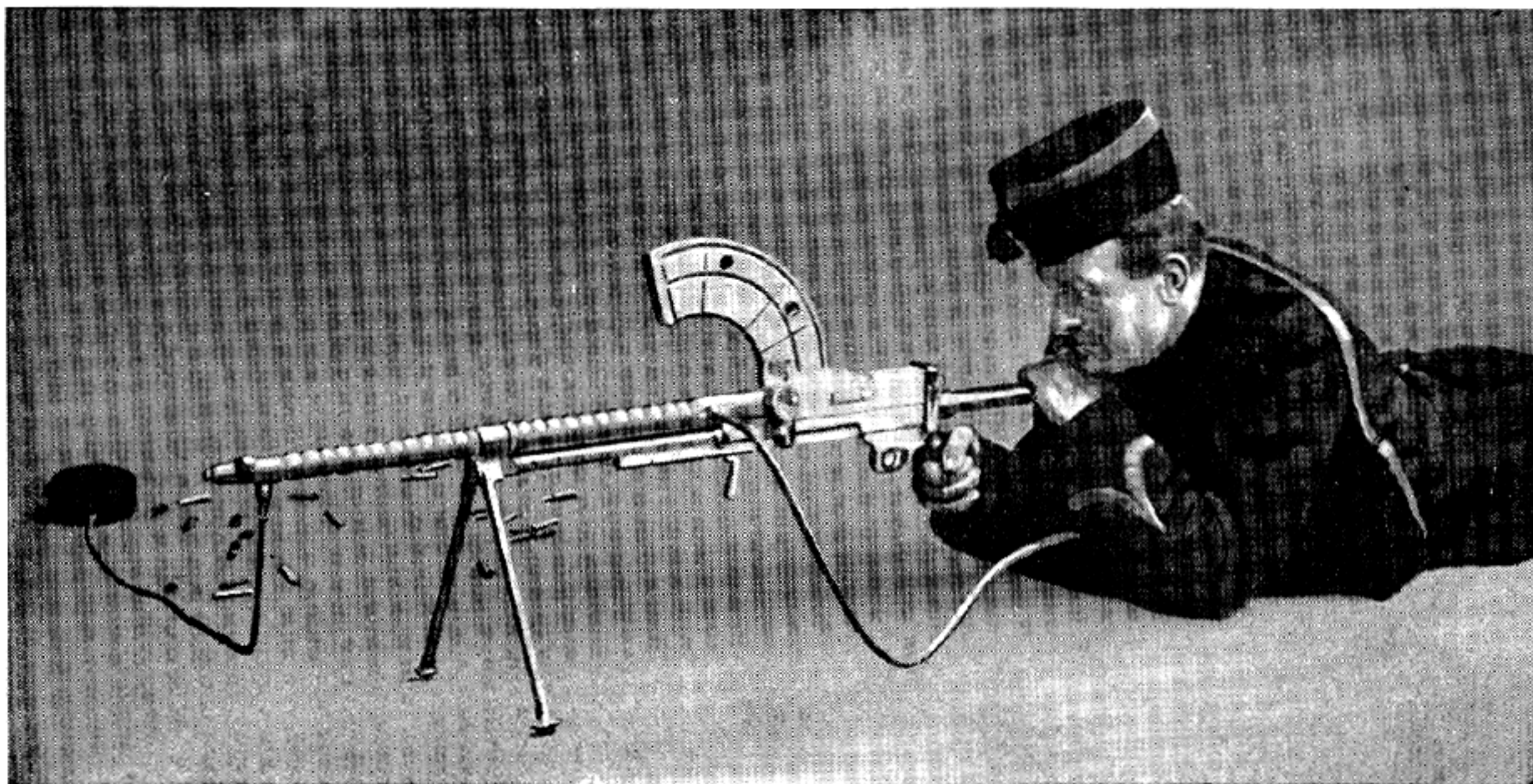

Berthier Machine Gun, Model 1911.

lished by the company not only gave its many features as an infantry arm but also pointed out its adaptability to cavalry tactics. Like all air-cooled machine rifles that were forced to use lightweight barrels, heating was the paramount problem. As a solution Berthier devised a system that permitted him to cool the barrel with water and still retain its low weight. The barrel was covered by a fairly close-fitting jacket made in two compartments. Using two small connecting rubber bags containing water, the gunner's assistant forced the liquid through the jacket from one container to another. This system was found to be adequate for up to 600 rounds of sustained fire. As a further remedy, the barrel and receiver were joined by an interrupted thread that allowed the barrel to be changed in a matter of seconds.

It is gas operated and locked by the "prop-up" method. That is, a part of the bolt when in battery is cammed in a vertical plane by the gas piston arm that actuates it as it continues on in a horizontal path. The barrel and receiver are designed so that the gun can use both air and water cooling. It is fed from a 30-cartridge clip located on top of the receiver. The cocking lever

is placed on the side of the breech cover, allowing the operator to pull it to the cocked-bolt position, where it is held until released by the trigger. The firing pin, being attached to the gas-piston-actuating arm, detonates the primer from the continued forward travel of the gas-piston arm after it has cammed or "propped" the bolt up into locking position.

The main component parts may be divided for purposes of description into four main assemblies: Barrel group, consisting of the barrel, firing regulator, and gas block; receiver components, being the gas cylinder, buffer, trigger mechanism, and shoulder stock; recoiling parts, consisting of the bolt, piston, and driving spring; and the feed, which is in the form of a semicircular spring-loaded magazine.

All of the barrel assembly is easily detached as a unit. A trap, called the gas block, located about one-third of the way back from the muzzle, houses the cylinder and when removed can be inspected or readily cleaned. The group also has a regulator that has four settings to allow additional gas pressure to be vented to the face of the operating piston.

The receiver is milled from solid stock, the



Components of the Berthier Machine Gun.

front being threaded to take the barrel, below which is constructed the gas cylinder. A recess is cut in the rear into which can be fitted a detachable stock, while a rectangular piece is formed on top of the receiver which locks the magazine in place. An ejection slot in the right side of the receiver is closed by a spring-loaded catch except at the time of firing. Immediately behind the magazine housing is the locking shoulder, consisting of a transverse piece of case-hardened steel, set into the roof of the receiver and beveled on its leading lower edge to engage the rear of the tilted bolt. There are also four additional removable hardened cams (these comprise the feed piece) and the bullet guides that govern the cartridge's position on approaching the chamber. A recess to house the buffer is milled at the rear above the mainspring tunnel. This absorbs surplus energy and accelerates the return to battery of the recoiling bolt and gas piston assembly.

The recoiling group is summarized as follows. The head of the piston is slightly cupped with three annular grooves cut into the body to prevent formation of carbon. Its rear is constructed with a projection to form what is known as the cross head. This carries two cams which engage with inclined grooves inside the bolt. A third cam in the rear, known as the actuating cam, fits into a recess in the rear of the bolt body. A flat is cut on the bottom of the cross head with a notch to contact the sear. In front of the cross head is a shoulder to engage the piston stop cut into the receiver. It holds the entire assembly in the rear position when the trigger is released.

The bolt is a long rectangular block that not only slides horizontally between its recesses in the receiver wall but at the end of its travel is allowed a certain degree of tilting in a vertical plane. It is milled out on the rear underside to permit insertion and necessary lateral movement of the cross head. A groove is also cut on the bottom forward part to furnish a slideway for the lock lifting cam. The extractor is located on the right side and the feed guide on the top portion.

The left side of the bolt is cut away sufficiently to accommodate the ejector. The rear upper part of the piece that engages the locking shoulder is cut with a corresponding angle and case-hardened

to coincide with its mating part in the locking shoulder.

The cocking piece on the right side of the gun does not form part of the recoiling group. In order to cock the piece, the handle is drawn to the rear and its catch engages the notch in the guide key on the right side of the cross head. This pulls both bolt and piston back together until the latter engages the sear. The cocking lug is then pushed forward until it snaps into a one-way arrangement that prevents its recoiling with the operating mechanism.

The Berthier weapon represented the lightest water-cooled rifle-caliber machine gun that had yet been developed. Why it did not more than fulfill the requirements of the infantryman is not known, as it most certainly was an advance over the alleged machine rifles that were making their appearance at the time. One cannot help but note the comparison between the operating mechanism of the weapon upon which Berthier based his patent claim in 1909 and the later Browning automatic rifle that has proved so reliable in United States military service. The gas-operated rotating bolt in Berthier's first design of 1905 was a system that time has also proved to be among the best. It is hard to conceive that the French Army, having in its possession the nuclei of two fine automatic rifles, could have veered so far away as to consider the Chauchat. Only one conclusion can be drawn, namely, that mass production, so necessary to win wars, could not be geared to produce this well-balanced but hard-to-manufacture weapon, whereas the Chauchat, although admittedly inferior, could be turned out in practically any plumbing shop.

To fire the Berthier gun, a loaded magazine is slipped into a recess on top of the barrel until it engages its holding catch. The charging knob is pulled to the rear and then shoved forward. The selector located at the right rear is turned to automatic fire. This cams down one of the two sears that lock the piston. The other is released when the trigger is pulled and permits the bolt to leave the cocked position. Driven forward by the energy of the compressed driving spring, the upper face of the bolt strips a cartridge from the mouth of the magazine and starts to chamber it. During this act the extractor rides over the cartridge rim and snaps in the cannellure. Coinci-

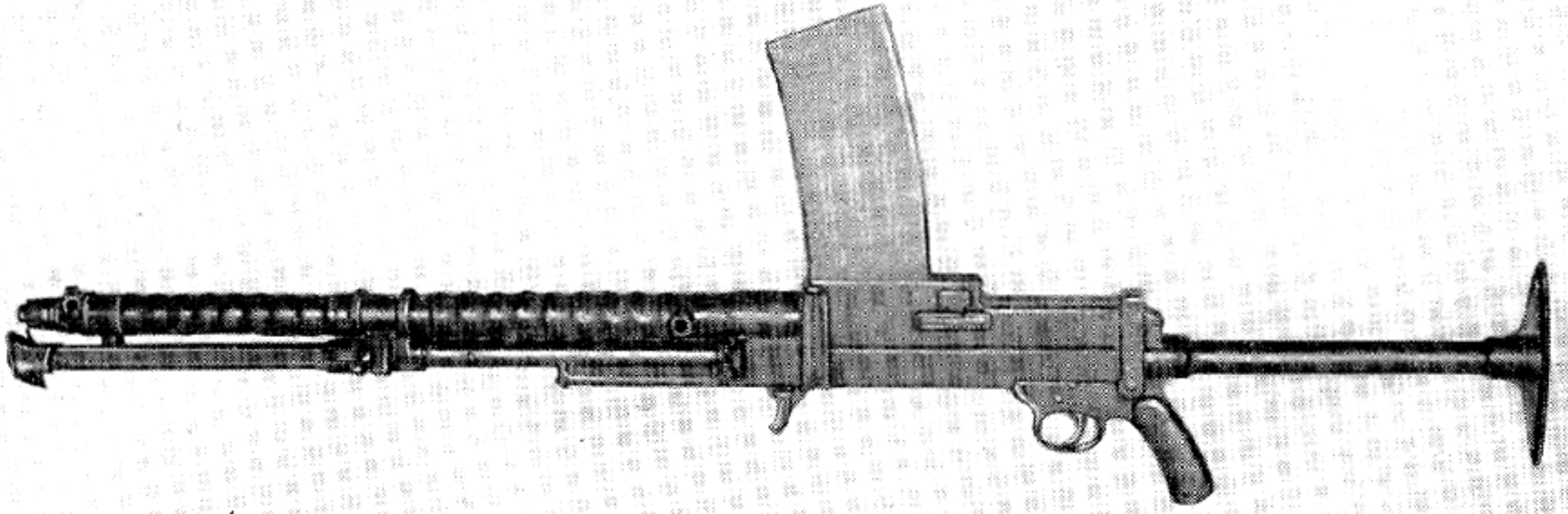

Berthier Machine Gun, Water Cooled.

dental to reaching its extreme forward travel, the rear of the bolt goes slightly beyond a locking step that is machined in the top of the receiver body. The bolt has an opening machined in its rear portion in which is riding the camming lug of the cross arm. This is all connected or a part of the gas piston. When the bolt reaches its locking recess, the speed and inertia of the piston cause the camming lug of the cross arm to engage a corresponding angle inside the bolt body, pivoting the rear of the bolt up and against the locking step in the receiver body.

This swinging, or propping up, of the rear end of the bolt removes the obstruction that has been holding back the cross arm on which the firing pin is attached. Being forced by the sudden pivoting of the rear portion of the bolt body, the cross arm and firing pin can continue to advance with great speed for one half inch. The firing pin then enters its tunnel and its tip smashes into the primer of the chambered round.

After the powder charge explodes and the bullet has passed a port about two-thirds of the way up the barrel, gas is admitted through a controlled orifice that acts on the face of the gas piston. The latter's first movement rearward withdraws the firing pin tip from the primer, and after the cross arm is driven back approximately one-half inch it disengages the two cams that are holding the rear of the bolt against the locking step. The rear of the bolt assumes the horizontal in its slideway and starts to the rear.

A spring-loaded extractor withdraws the empty case and holds it close to the bolt face until the ejection slot is reached in the receiver. At this time the ejector fastened in the receiver collides with the base of the cartridge, pivoting and throwing it through the opening and to the right. The spring-loaded magazine pushes another round in position and the recoiling parts continue on against the loading forces of the driving spring. Full recoil takes place when the moving parts make contact with a spring-loaded buffer that not only absorbs the surplus energy but accelerates the operating mechanism during counter recoil. If the trigger remains to the rear, the return movement results in repetition of the cycle.

During the years between the weapon's conception and World War I, there was only enough interest shown by the various governments to which it was demonstrated to keep it from being totally forgotten. Many countries made inquiries and experimented at odd times with this machine rifle. However, France, the home of the inventor, seemed to go to great lengths to ignore it.

In 1916 Berthier, who had risen to the rank of general in the French Army, came to the United States to develop the weapon further, more by refinement of components for the purpose of being mass-produced than anything else, as the operating principles remained the same. On its first official trial by the United States

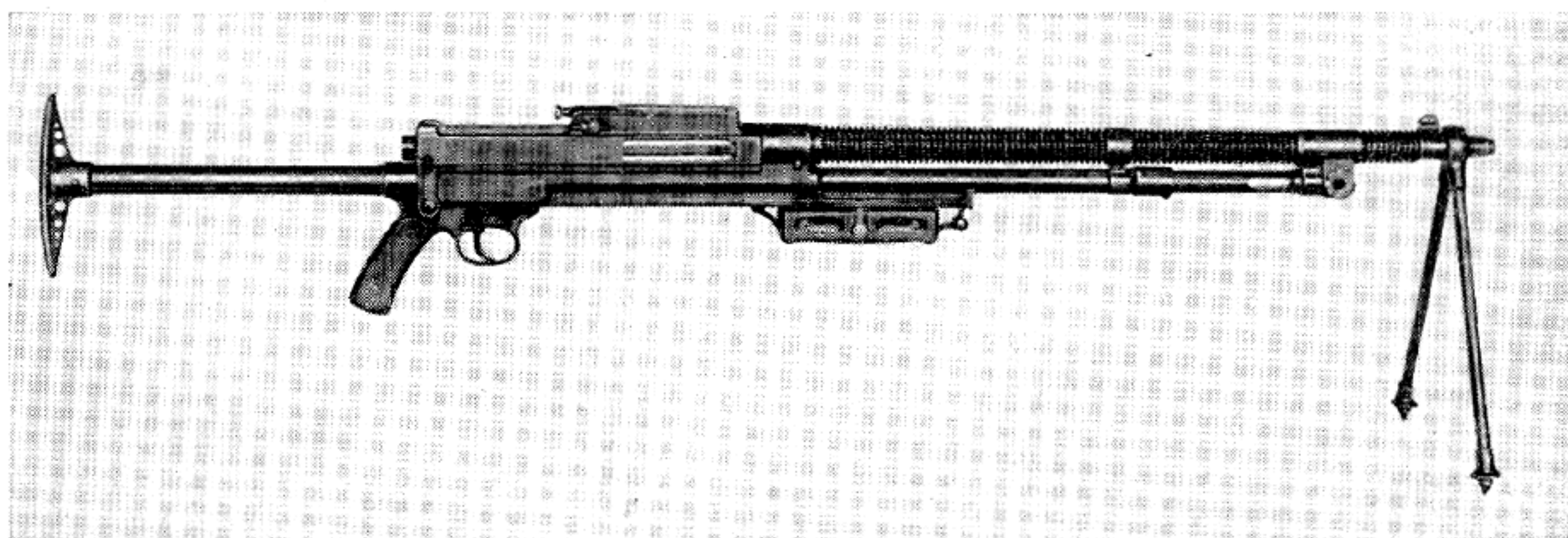

Air-Cooled Berthier Machine Gun Tested by the United States Army, 1917.

Army in May 1917 the gun did not meet requirements. On 29 June of the same year, the Marine Corps after a very comprehensive test, reported it suitable for its use. The Ordnance Board tested the weapon again shortly after the Marine Corps made its report and this later Army board concurred with the Marines, who had again conducted trials that resulted in another favorable report.

The Army then ordered, on 2 October 1917, the manufacture for issue of 5,000 of these guns chambered for our caliber .30/06 infantry cartridge, provided the order did not conflict with other machine rifle production that was being planned. It was found that the Hopkins & Allen Co. of Norwich, Connecticut, was under contract by foreign interests that controlled the Berthier manufacturing rights. It was estimated that the firm could start producing within 8 months, as it was 80 percent tooled up. Contracts were given for the Army's 5,000 guns. An additional 2,000 were ordered by the Navy for the Marine Corps, and given the designation Mark IV. This division of Hopkins & Allen had been incorporated, after receiving the contract, under the name of the United States Machine Gun Co. But financial and other complications arose and the parent firm was forced to drop all plans for manufacturing the weapons. As no other source was

available that could give any promise of delivery within a reasonable time, all contracts were canceled. Consequently the guns were never manufactured in the United States, except for a few handmade pilot models.

This weapon is one of the best examples of a good idea developed at a time of peace when its perfection was cut short by lack of interest and money for development. When it was urgently needed in war, it had still not been proved to a point that justified the expensive and time-delaying job of tooling up to make the components with the precision demanded of such a weapon.

Had any country, at the introduction of the Berthier 1908 model, seen fit to function fire and correct the inevitable errors of design that appear during this experimental stage, it undoubtedly would have had in its possession at the beginning of World War I one of the world's most reliable and efficient machine rifles. There is very little question that the mystery of mass production to Europeans, and especially the French, was the contributing factor that made them treat the gun as being simply non-existent. That the basic principles were sound is shown by the fact that at a much later date several battle-tested light machine guns and rifles have used identically the same operating features first presented by Berthier in his two designs of machine rifles.



## KJELLMAN MACHINE GUN

Sweden made the next contribution to automatic weapon development with a very interesting automatic machine gun. Officially known as the Kjellman, it was the result of what could be called "two-stage" progression. Originally designed for the 6.5-mm Swedish Army rifle cartridge, it was water cooled, belt fed, recoil operated, and had a rate of fire of 500 to 600 rounds per minute. The weight of the weapon, minus water in the jacket, was only 28 pounds, which puts it in the lightweight class. The rear-scarfed firing mechanism left it at the end of a burst in a cocked-bolt position. The operating energy derived from what is known as the short recoil system.

By "two-stage" development, it is meant that the basic operating principles were originally conceived and patented by Lt. D. H. Friberg of the Swedish Army as far back as 1870, in an attempt to design for his country an efficient manually operated machine gun. His endeavors resulted in the development and patenting of many features, especially the locking system. His death, however, cut short any attempt at actu-

ally producing a shooting model of his designs. In 1907, 37 years later, a civilian gun mechanic, Rudolf Henrik Kjellman of Stockholm, Sweden, in trying to enter the automatic machine gun field, became interested in Friberg's basic principles. In line with the Swedish lieutenant's conception, he made a pilot model of an automatic firing mechanism that employed short recoil to actuate the components.

On the Kjellman-Friberg automatic machine gun, the barrel and bolt recoil securely locked together for a distance of 18 millimeters. At this point the bolt is unlocked from the barrel and continues to the rear, accelerated by a pivoted lever. Two projections at the point of unlocking hold the barrel and barrel extension to the rear against the barrel return spring and the bolt continues to compress the driving spring. The fired cartridge case is extracted by a T slot on the face of the bolt and the empty brass travels with the bolt to the extreme rear position. It is ejected on counterrecoil by the introduction of the incoming round in the T slot, plus contact with a gradual angle that engages the empty core during this part of its forward movement.

The round being chambered is first positioned by a movement of a sliding bolt face very similar to that of the Maxim. When the counterrecoiling bolt has reached a distance of 18 millimeters from battery, it strikes the pivoting breech locks. This simultaneously releases the barrel and barrel extension and locks them to the bolt, and all continue as a unit towards battery. If the trigger is held back, the firing pin is automatically released just before the entire recoiling mass makes contact with the receiver. The safety feature is also controlled by the breech locks which serve as an adequate obstruction in the path of the firing pin until the firing mechanism is securely locked.

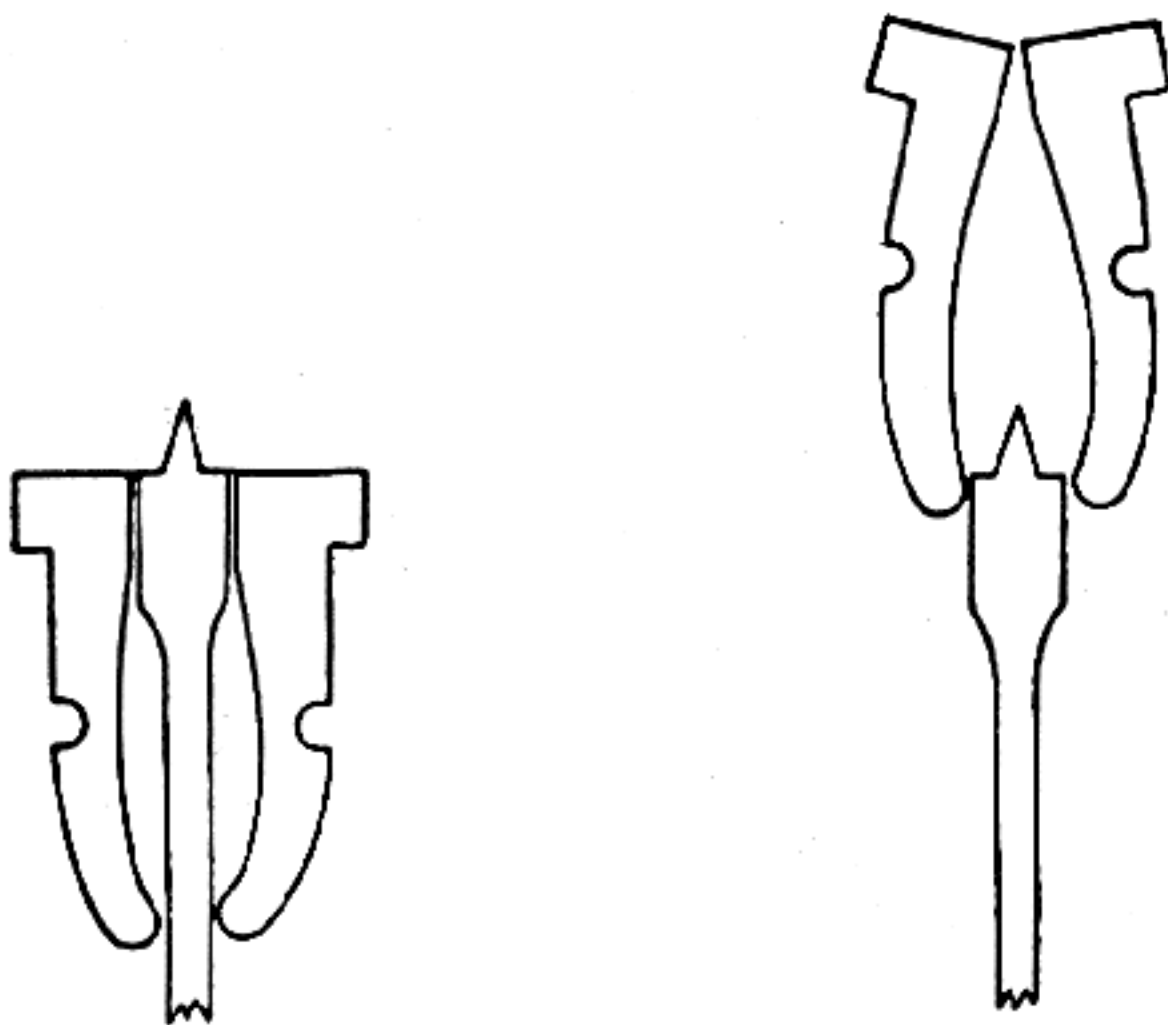

Locking System Designed by Friberg and Used by Kjellman.

A fire regulator is located on the left side of

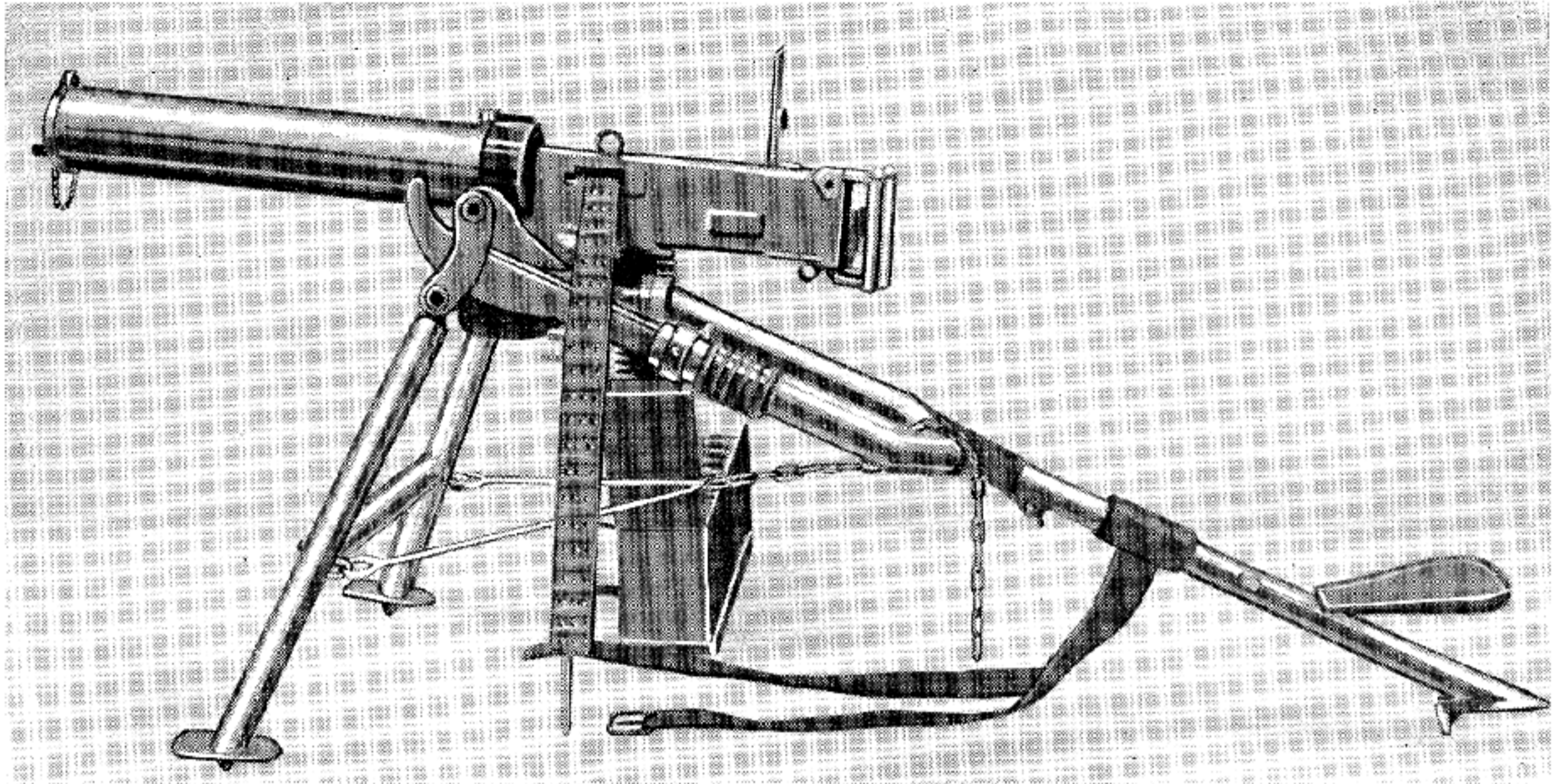

Kjellman Heavy Machine Gun.

the weapon. It permits the operator to choose automatic or single shot. Due to the gradual camming effect on the empty cartridges, the cases, while positively ejected, are done so without being thrown forcibly from the gun. This unusual method caused Kjellman to incorporate, as an accessory to his gun, a metal receptacle that

fitted in a slot beneath the receiver. This box has a trap in the top and each round, as ejected, is cammed through this opening. The bottom of the container slides between two right angles. It is spring loaded and at the end of a long burst or after cumulative firing, the gunner can pull back on a metal tab and dump the empty cases.



Kjellman Light Machine Gun Being Fired by the Inventor.

When the last round has been fired from a belt, the operating mechanism is automatically seared to the rear. This feature facilitates loading as the bolt has to be in a retracted position when the first round is positioned. The conventional fabric belt is employed. It holds a total of 250 rounds, already packed in a light wooden container.

This weapon was given official consideration by the Swedish Army. Extensive trials were held and, for its stage of development, it held up remarkably well. Sweden, however, like the United States, not only had long been at peace, but saw no immediate prospect of war. Nothing but tests by the Army and a passive Government interest, as shown by the purchase of less than half a dozen of these weapons, ever resulted from the combined efforts of the two inventors.

Kjellman, thinking he could possibly arouse more interest if he refined the weapon to a point

where it could be used by the infantryman as a machine rifle, did reduce the profile and streamlined the gun by adding a lightweight stock and tripod. For some unknown reason he retained the water-cooling feature with its bulky jacket. Had he chosen to make an air-cooled gun along these lines, he no doubt would have given the Madsen machine rifle severe competition.

Captain Lindengren, of the Swedish Army, who was considered one of the leading authorities on small arms, made many complimentary statements in writing about both weapons after witnessing the official trials. He wrote an article pointing out that, while the gun employed a very short recoil to work the mechanism, it was more securely locked than any other known automatic arm. To prove his statement he showed by spark photography that the bullet was 98 feet from the muzzle of the weapon before unlocking of the breech began.

## REVELLI MACHINE GUN

A young Italian inventor in the year 1908 applied for his first patent on machine guns. It was to be followed by many others during the years in which his name was practically synonymous with Italian automatic weapon design. This prolific designer, later to become a high ranking military officer, was Bethel Abiel Revelli, a resident of Rome.

The automatic firing mechanism he had developed was a water-cooled machine gun with a box magazine, chambered for the 6.5-mm service rifle cartridge and weighing 38 pounds without mount. The maximum rate of fire was officially

set at 500 rounds per minute. It was one of the few medium-weight machine guns to employ a magazine instead of the customary belt. Its unique method of feeding employed a metal box with 10 compartments of 5 rounds each, making a total of 50 shots per magazine. The ammunition container, when inserted in the feedway, was so constructed that, after the first five shots, the magazine itself was indexed over one compartment. When these additional five rounds had been fed through, the process was repeated until the entire contents were expended without interruption of fire. An oil pump for automatic



Revelli (Fiat) Machine Gun, Model 1914, Cal. 6.5 mm.

lubrication of each round was an integral part of the receiver.

There being no immediate prospect of war, nothing was done about the manufacture of the weapon except for the few handmade working models produced locally by the inventor. Revelli early became associated with the Fiat automobile plant located at Turin, Italy, and it was this company that first became interested enough to make a few demonstration models. There is an official record of the submission of a Revelli machine gun to an United States Army board in 1911, and in 1913 a test report by the Italian Government stated the weapon was suitable for service use. The gun employed at the time a 100-round magazine in lieu of the 50-round device. While it functioned satisfactorily, it was thought to exert too much weight at the left side of the mechanism when first positioned in the feedway, and restoration of the smaller box was recommended.

Italy's entry into World War I gave Revelli and his theories of machine gun construction a great opportunity, of which he took full advantage. This water-cooled model was turned out in great numbers by the Fiat Co. along with many other designs by this creator of Italian machine guns. The main Italian automatic infantry weapons stemmed from the earlier trial and development projects initiated by Fiat. The tests had been personally conducted by Revelli, who by this time held a captain's commission in recognition of his being instrumental in furnishing Italy with a machine gun of native origin.

To fire the weapon, the selector switch is moved from "Sicura" (*safe*) to "Rapido" (*fast, or full automatic*) and the trigger button pushed forward, bringing the sear out of contact with the bolt. This permits the striker to be thrust forward under compression of its driving spring, sending the firing pin into the primer to explode the powder charge in the cartridge. As the bullet travels down the barrel, the rearward action of the gas pressure against the cartridge base pushes with corresponding force against the breechblock.

The barrel sleeve and breechblock move back locked together for a distance of a half inch. The barrel extension is stopped at this point by a cross bar fixed to the receiver. Unlocking now

begins by means of a wedge which starts to rotate about a fixed axis at right angles with the bore. As the breechblock goes back, the wedge is forced to swing to the rear.

The wedge passes through a slot in the underside of the sleeve at an angle that cams the sleeve and barrel to the rear. This slight delay permits the bullet to clear the bore and the gas pressure to drop to a safe operating limit. At this point the wedge is moved entirely out of engagement with the breechblock. The latter travels backward under the momentum imparted to it by the blow-back gases. A nose on the under side of the breechblock holds the wedge down for the remainder of the rearward action. During the retracting movement the extractor guides the empty cartridge case out of the chamber, holding it to the face of the bolt until its base collides with the ejector which hurls it through the top opening in the gun. As each magazine compartment is emptied, the projecting tip at the rear of the compartment raises a pawl which permits the feed ratchet arm to index the next compartment of the magazine.

A strong coil spring, which is extended during the rearward motion, provides energy for return. It is attached to a connecting rod, one end of which hooks to a claw on the bottom of the rotating wedge and the other end to an adjustable spring fastened to the frame of the gun.

As the breechblock continues traveling to the rear, its spring is compressed against the head of the receiver. When the force of the recoiling action has been dissipated, the spring attached to one end of the frame in the lower part of the receiver exerts tension on the clamp at the bottom of the wedge. The sleeve and barrel are drawn forward as the firing-pin spring acts to force the breechblock forward at the same time that the sear holds the striker back out of engagement.

In counterrecoil the breechblock strips the cartridge from the magazine, then positions, and finally chambers it. The operating parts are now in battery, ready for the release of the firing pin, which will start the cycle all over again.

An unusual feature of the Revelli is that the cocking handle is incorporated in the rear portion of the bolt, and protrudes unhoused from the rear of the gun. It is shaped like a cross per-

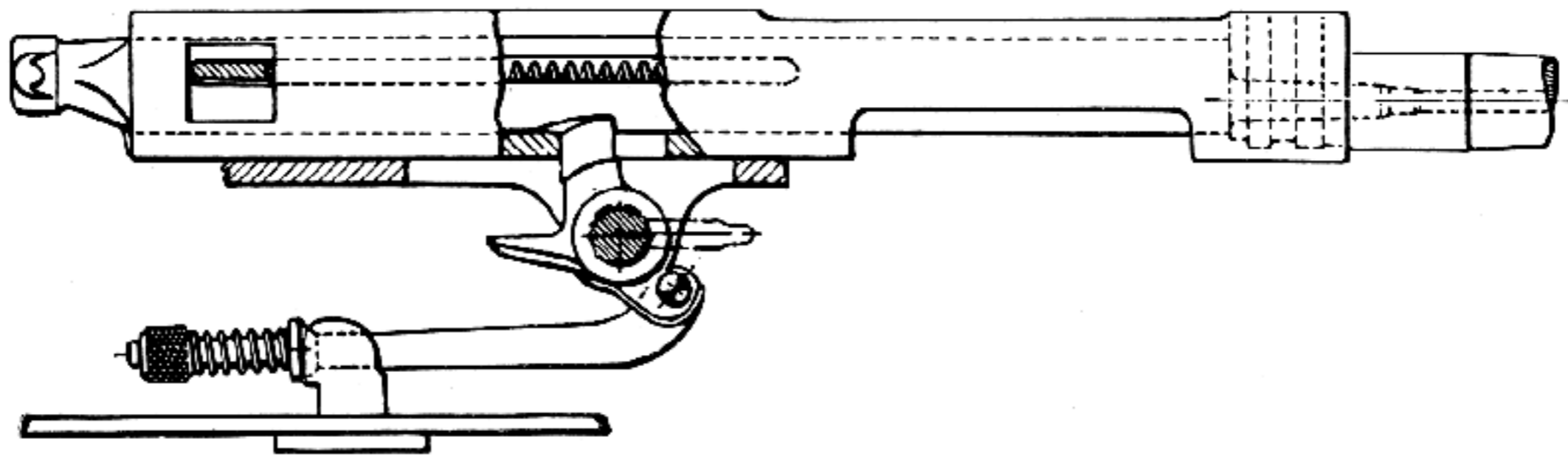
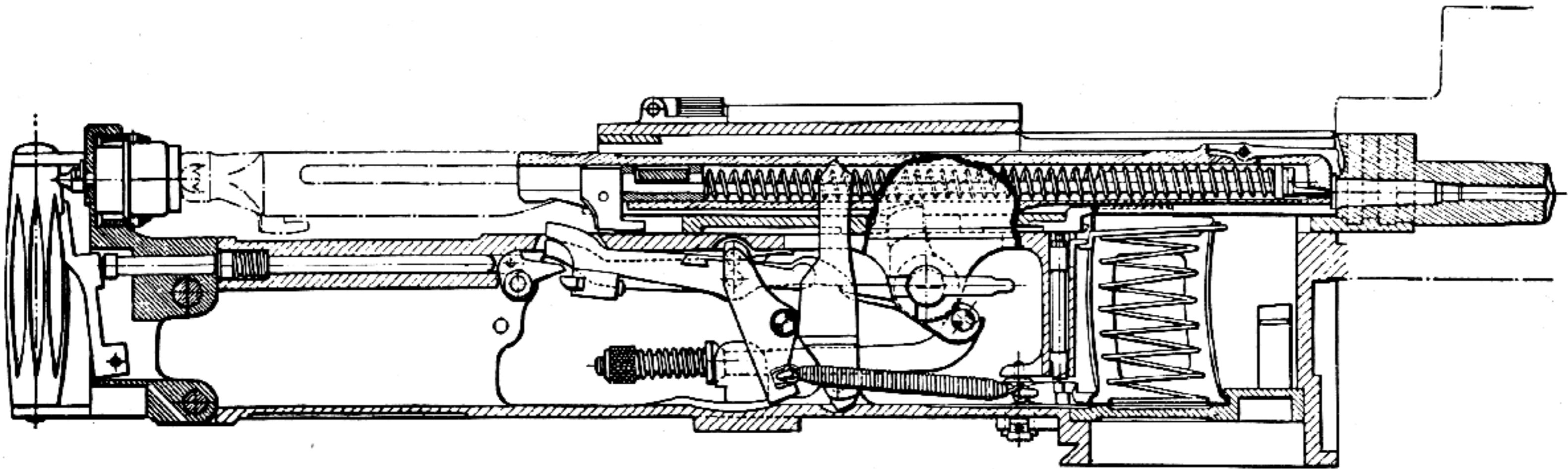

Section Drawing of Revelli Mechanism.

mitting the fingers to be locked around both semicircular projections so that it may be drawn back against the tension of the firing-pin spring. This allows the gunner to cock the piece independent of the recoil action.

There is also a lever device, located directly above the thumb trigger piece, which permits both single shot and automatic firing at the will of the gunner. When single shots are desired, the selector switch is moved to "Lento" (*slow*) on the left side of the safety switch, permitting one shot to be fired each time the trigger is pressed. Pushed to "Rapido" (*fast, or full automatic*) at the extreme right, it fires automatically as long as the trigger is depressed. The vertical center position of the lever is marked "Sicura" (*safe*).

To load the magazine, the Revelli uses a trick magazine feeding system known as the "mouse-

trap action." In theory, the device provides far more flexibility than is possible from a belt-fed mechanism. The magazines are small and compact. They can be inserted rapidly and are expelled automatically from the gun when empty. In actual warfare, however, it was found that the magazines damage very easily. This alone offsets the apparent advantage of the system.

A tip on the magazine follower on each section protrudes from the back. This part may be pressed down by the thumb of the left hand while the base of the cartridge is forced down in front of the follower and slides in under the locking lips of each section. Five cartridges may thus be fed into each of the magazine wells, thereby replenishing the ammunition without removing the box from the gun.

To install the magazine, it is inserted in guides



American Troops Receiving Instructions on the Revelli Model 1914.

in the feedway from the left-hand side of the gun. As each cartridge is chambered, the individual spring in the compartment forces the next cartridge up the line to be picked up by the forward motion of the breechblock. When the fifth and last cartridge in the compartment has been fired, the tip protruding from the back of the magazine engages a part of the mechanism. The latter shifts the box over to the right far enough to bring the next magazine compartment into line with the counter-recoiling bolt. When completely empty, the magazine is expelled from the gun on the right side.

A hinged plate covers the ejection slot on top of the gun. When ready to fire, the operator lifts

it up to allow the empty cartridge cases to be thrown out through the opening.

The method of operation employed in the Revelli is known as "recoil and blow-back," or, in other words, retarded blow-back. The rearward thrust of gases in the firing chamber acting against the case pushes it back against the breechblock, causing a slight delay in unlocking. In the true sense of the word, the weapon is at no time securely locked, as in recoil-operated mechanisms, but utilizes hesitation to drop the gas pressure to a safe operating limit. The breech is then opened by the rotating wedge which connects the breechblock and barrel during the first stage of recoil movement to the rear.



## LAIRD-MENTEYNE MACHINE GUN

On 15 September 1913 a test of an English-made machine gun was ordered at Springfield Armory, Springfield, Mass. In the trial that followed it failed so miserably that it is mentioned here only to straighten out the classification of the weapon. It has been referred to as the Coventry machine gun, the C. O. W. rifle-caliber machine gun, and the Laird-Menteyne automatic gun. The first two designations were acquired because the Coventry Ordnance Works of Coventry, England, manufactured and promoted it in the testing at Springfield. A representative of the company was present to fire the piece.

The mechanism really was the invention of two French mechanical engineers, Paul M. Menteyne and Pierre A. Degaille, who as early as 20 October 1909 filed for a patent on the newly designed gun. Lacking capital, they spent 4 years before they finally interested a responsible gun manufacturing company in making a working model. The Coventry Ordnance Works produced two guns and offered them for trial by the United States Army. Charles W. Laird, a British engineer, was associated with the firm's development of the gun.

The weapon is best described as an air-cooled, magazine-fed, recoil-operated machine rifle using our standard service cartridge. The bolt is re-

volved to lock and unlock by engaging cams in the receiver, and the gun was loaded from beneath. It was so arranged that when the last cartridge was fed into position for chambering, the empty magazine automatically detached itself and fell to the ground. A fully loaded one was then inserted. It could be fired single shot or full automatic by the movement of a post device that was located directly in front of the trigger. A safety feature was incorporated in its construction whereby the cams that rotated the bolt for locking also revolved into alignment the firing pin with its tunnel in the bolt body. It was an impossibility to fire the weapon before the action was securely locked. The large main spring served also as firing-pin spring, since the inertia of the mass going into battery drove the end of the firing pin into the primer after cams turned the lugs on the bolt into the mating recesses in the receiver.

Considering the date of application for patent, this weapon had many advanced features that were used successfully in later guns, despite the failure of the Laird-Menteyne when subjected to the vigorous Springfield Armory test. The inventors stated in their claims that the mechanism was more adaptable to a larger shell gun than to the commercial rifle caliber as demonstrated.

PART IV

AIRCRAFT AND AIR-BORNE WEAPONS

## EARLY AIRCRAFT DEVELOPMENTS

## Aerial History Before Kitty Hawk

The development of the automatic machine gun was so far ahead of the rest of the mechanical world that shortly after the turn of the twentieth century, as if by a predetermined agreement, progress in this field of endeavor temporarily ceased. It seemed to be waiting for a companion achievement, the airplane, to join in a combination that would result in man's most devastating instrument of war.

Of all the classes of society, perhaps the highly practical gun designer heaped the most ridicule on the "crackpots" who continually tinkered with horseless carriages and contraptions with wings. During this era some of the world's most skilled mechanics worked on the perfection of weapons, since this work represented a certain means for inventors to be reimbursed financially for their efforts. Having accomplished themselves what heretofore was considered impossible, they very humanly did not credit others with being able to do the same. The ability of man to fly in the air was thought to be hardly more than childish fantasy, but patience and ingenuity were at last making a fact of the unbelievable.

As early as the vision of the wonders of flight itself came premonitions of the inevitable horror that would surely follow the phenomenon. Even the early legends of India contain prophecies that in time there would be built "an aerial chariot with sides of iron and clad with wings which hurled down upon the city missiles that destroyed everything on which they fell."

During and following the ancient and medieval ages, men wrote boldly of flying but did little or no experimenting. Most of their theories during these sterile centuries were naturally based on the flight of birds. Roger Bacon, of gunpowder fame, described in his writings an "instrument to flie withall so that one sitting in the

midst of the instrument doe turn an engine by which the wings, being artificially composed, may beat the ayre after the manner of a flying bird." Leonardo da Vinci, another prophet of the future, conceived the parachute, "a domed roof of starched linen, 18 feet wide and 18 feet long," by means of which a man could "throw himself from any great height without fear or danger." Theoretical discussion of flying continued to increase throughout the sixteenth, seventeenth, and eighteenth centuries until at last something practical in the way of flight was attempted.

On 19 September 1783, the Montgolfier brothers of Paris, France, built the first successful hot air balloon. Their gas-filled envelope was sent aloft with a sheep, a rooster, and a duck as passengers before the assembled court of Louis XVI. Three days after all had returned in good shape, a brave individual named Jean François Pilâtre de Rozier became the first human aerial passenger. He had hardly landed safely when M. de Vilette, a representative of the *Journal de Paris*, went aloft with de Rozier. While the newspapers made much of a Frenchman being the first human being to make an ascent, greatest emphasis was placed in pointing out the advantages the balloon would give to an army on land and to a navy at sea. In short order, books were being hawked on the streets of cities in every land close to France predicting that the French would descend upon them some still night, with troops being transported by noiseless balloons. This psychological scare seemed to excite almost everyone about the possibility of the balloon in warfare except the French, who took it simply as a great national achievement and very little else.

A more important discovery took place across the channel in England in 1810 when Sir George Cayley built the world's first glider. It worked to the extent of successfully carrying a man in the

air. The glider was a brilliant achievement in that it not only lifted a man in free flight and landed without killing the operator, but also laid down the first sound aerodynamic principles upon which heavier-than-air machines are based. For in order to be successful, Cayley had to master many complex problems that worked in direct opposition to each other, such as cross-wind stresses, drag, and the constant pull of gravity. Sir George patiently sought by experience just how things actually worked instead of going by mental calculations that were based for the most part on hypothesis. Like many others before him he died thinking himself a failure, whereas in reality he left a great contribution in his chosen field. He undoubtedly was the pioneer in the study and development of elementary aerodynamics.

Although Cayley proved that a man-carrying heavier-than-air machine could be kept aloft by air currents, practically all effort in this direction was dropped in favor of the balloon, the popularity of which was growing by leaps and bounds. The French Revolution gave it its greatest impetus and its first use as a military device. Scarcely a war followed in which the gas-filled bags did not play a conspicuous part.

In this country a Professor Lowe organized the United States Army's aeronautical corps, which saw much active service during the Civil War. The professor himself logged more than 3,000 ascents in captive balloons, often staying aloft all day to observe movements of the Confederate troops. One of his companions on numerous ascents was a young German military attaché, Col. Ferdinand von Zeppelin, who at the time was serving as an observer for his government. He seemed to be more interested in the possibilities of the balloon in warfare than in the tactics employed by the opposing forces.

Its desperate position in the Franco-Prussian War caused France to authorize the formation by Felix Nadar of the "Ballon Poste" in order to float mail and passengers out of the besieged city of Paris. Later, the entire French Government used this method of escape when it seemed certain the city would be captured.

It was during the blockade of Paris that American citizens were first subjected to anti-aircraft fire. W. W. Reynolds, an agent for the Reming-

ton Arms Co., and C. W. Way, a New York merchant, were caught in the siege. They persuaded the authorities to build them a balloon, and on 7 October 1870, they ascended, accompanied by two French aeronauts. The basket was heavily loaded, mostly with French gold in payment for armament sold to the Emperor Napoleon, and failed to rise properly. As it drifted low toward the German lines, it was shelled by Prussian artillery, sniped at by infantry and followed by troops of galloping horsemen. After several perilous escapes they were finally blown out of range of their pursuers and landed safely beyond the Prussian lines in a field near Amiens.

With the development of a power source known as the gasoline engine, the construction of balloons made with a longitudinal lattice framework of ribs with a light aluminum skin followed. The name "dirigible" was given to this type of airship. The designers believed the day had at last arrived when a balloon could be guided by an outside power source to and from any destination and not be dependent on changeable currents of air for its motive power.

An airship of this type was devised by the French in 1897 but it was far from successful. Two years later Germany developed the first practical aircraft along these lines. Santos-Dumont, a Brazilian living in France, working on different principles from the German inventor, also succeeded in constructing a successful lighter-than-air ship.

The French Army, however, had other ideas concerning aircraft and paid little attention to the successes of the dirigibles. As early as 1891 it had commissioned Clement Ader, considered the foremost aeronautical enthusiast in France, to build for the army its first military heavier-than-air plane. Ader, an electrical engineer by profession, was closely associated with the development of the telephone in France. In observing the activities of balloons at that time, he thought the nation could best protect herself by the construction of flying machines. After selecting the bat as the best model to imitate, he started to build a craft similar in appearance to this creature, which he called the "Avion." It was provided with a 40 horsepower motor driving 2 propellers.

The whole project was kept in great secrecy.

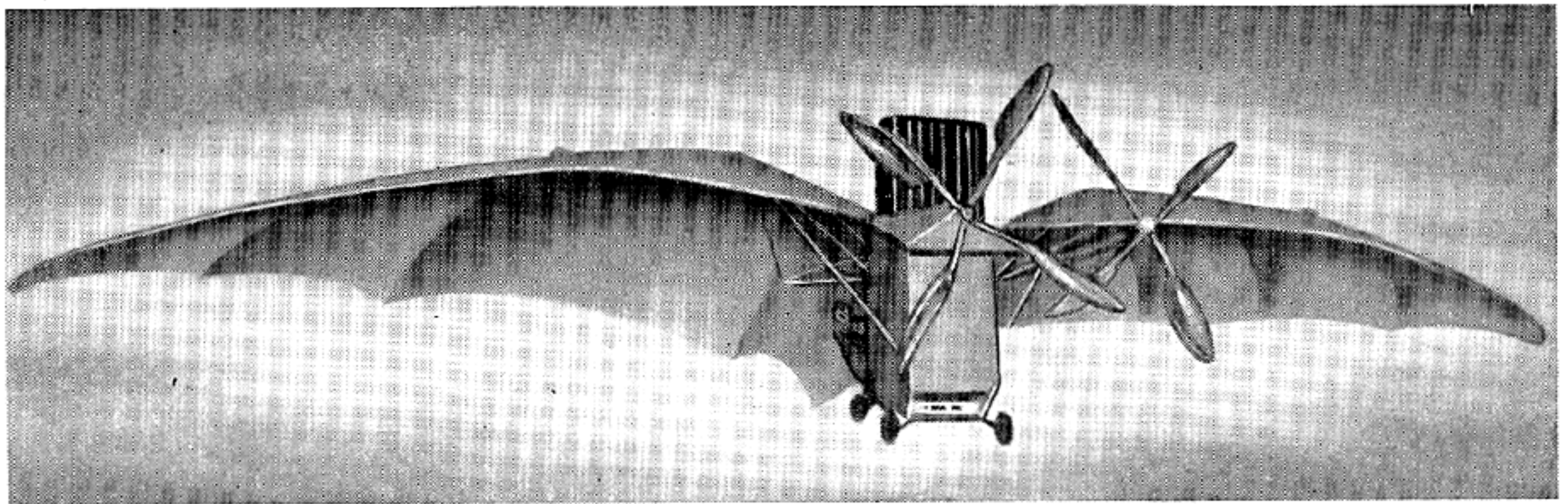

Ader's Avion, the First Government-Sponsored Flying Machine.

The French Government, considering the Ader flying machine already an accomplishment, appropriated \$100,000 for the founding of an arsenal to construct and subsequently arm a fleet of the planes. The plan proved disastrous to both Ader and his military backers, for on 14 October 1897, after 6 years of hard work, the aircraft was completely wrecked in its initial attempt at flight and the authorities refused to advance any more money for further experiments. No doubt the government was anxious to avoid criticism over its already vast expenditure which had nothing to show for it beyond a totally wrecked aircraft.

Sir Hiram Maxim, who originated the world's first successful automatic machine gun, was approached by the British Government which agreed to finance the building of a flying machine if Maxim would design it. The inventor, never a modest man about his ability in any field, agreed to construct a large aircraft of the multiplane type with a wing spread of 120 feet. He provided it with 2 steam engines, each capable of generating 175 horsepower. The completed assembly weighed 7,000 pounds, but like Ader's plane it too was wrecked in its first attempt to fly and the project was abandoned. The British Government, evidently expecting perfect performance as in the case of Maxim's first model of his machine gun, was disappointed and withdrew its support.

Ader's and Maxim's efforts can best be summed up as serious efforts to fly but with no proved results. However, Maxim did contribute one thing to aviation. He argued successfully that an airplane, because it was intended to fly, did not

necessarily have to flap its wings like a bird. As he stated, "If airplanes should be constructed like birds to be more efficient, then by the same token locomotives should be built like horses."

Samuel P. Langley was a great pioneer in American aviation who was continually harassed by bad fortune. This former architect, in association with Charles E. Manly, built several contraptions called "Aerodromes" and while they never managed to fly, present-day authorities have adjudged them magnificent failures. That is, they were of sound construction and as advanced as it was possible to be at the time, especially in respect to motive power.

Langley was fortunate in having the services of Manly, a typical American inventive genius. He had designed gasoline engines, weighing only 125 pounds and capable of developing 52 horsepower, which were far in advance of anything known at the time. One of these engines officially generated 1 horsepower to 2.4 pounds in weight. It was successfully run in spite of the assurances of many eminent engineers and experts that it was impossible for a power plant to be designed under eight pounds per horsepower. The five-cylindered liquid-cooled motor ran, in an official test, 10 hours without stopping. This happened during an era when it took practically that much time to get the conventional automobile engine started.

In 1903 the Board of Ordnance and Fortification of the United States Army directed Langley to construct a large model of his Aerodrome and appropriated \$50,000 to defray the cost of the experiment. This craft with its 52-horsepower

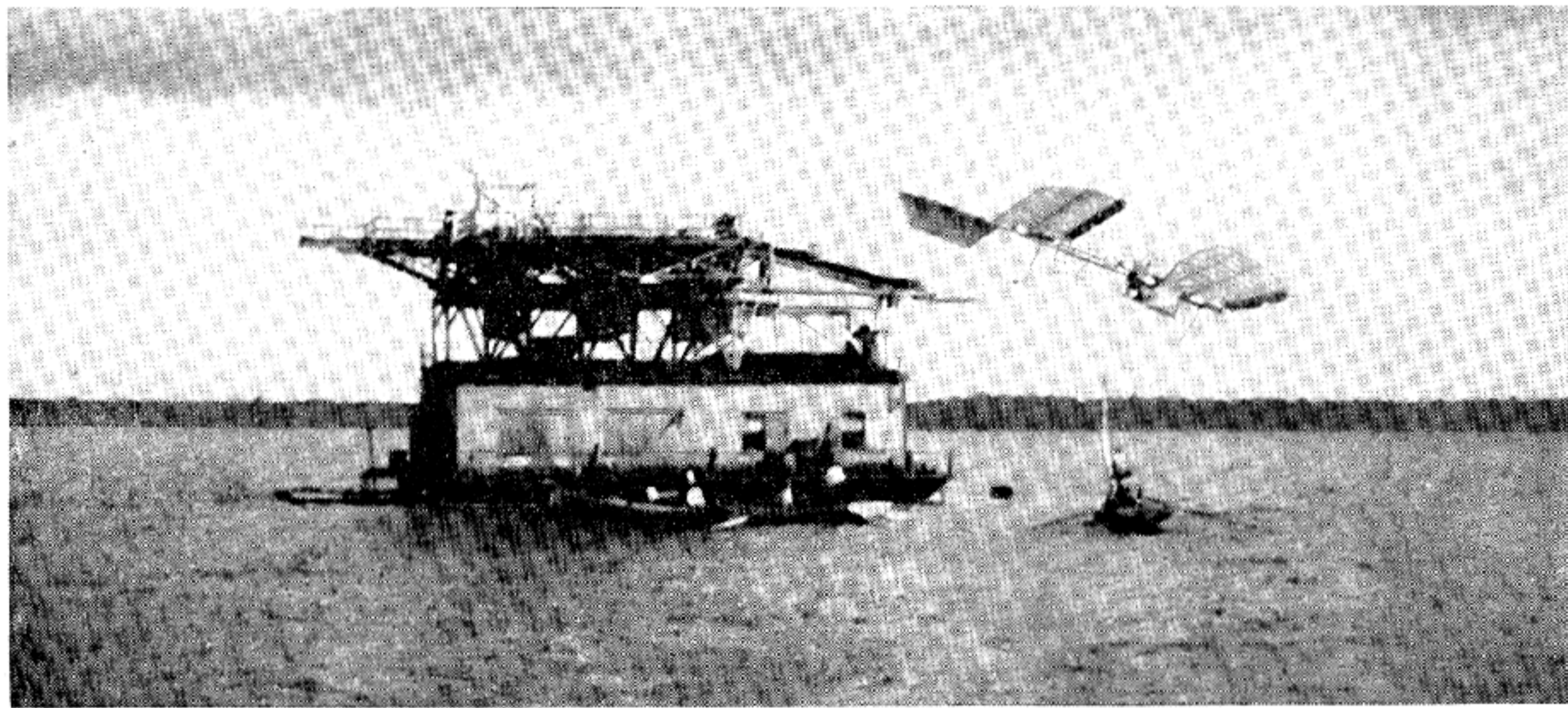

The Launching of Langley's Aerodrome, 7 October 1903.

engine weighed only 830 pounds. Its dimensions were 48 feet in width and 52 feet in length. Two attempts were made to launch the craft from Langley's houseboat on the Potomac River, near Washington, D. C., on 7 October and again on 8 December 1903. During both efforts, according to witnesses, the Aerodrome became entangled in the launching gear and fell headlong in the Potomac. Following the last attempt, the press ridiculed the whole project so much that Congress refused to vote any more money for the venture. Regardless of its apparent good design, the fact remains that it did not fly and each effort to do so resulted in the complete wreckage of the craft in an inglorious manner. As one of the spectators put it, the Aerodrome "slid into the water like a handful of mortar."

### The Wright Brothers and Other Early Pilots

It became the lot of two modest young men, Orville and Wilbur Wright, whose background consisted mainly in the building of bicycles, to fulfill the age-old dream that had bested mankind from the earliest days to the twentieth century. For on 17 December 1903, their "contemptible orange crate," held together with glue and wire and powered by a wheezing 4-cylinder gasoline engine, became air-borne after being

launched into a 27-mile wind at Kitty Hawk, N. C. Orville Wright was at the controls through the element of chance, the brothers having tossed a coin as to which one would have the signal honor. Wilbur had won, but the first attempted launching 3 days earlier had been unsuccessful because of a broken guy wire at the time of take-off, and it was now Orville's turn. This act, like almost all others of world-shaking importance, took place in the humblest of surroundings, as the sand dunes on this bleak shore were hardly an appropriate backdrop for what was destined to become both the wonder and the scourge of civilization.

In a halting erratic flight of 120 feet, aviation as we know it today, came to life. The 12-second phenomenon was witnessed by five heretofore skeptical local residents and by a confident Wilbur Wright. The watchers were John Ward, a boy of 16, John T. Daniels, W. S. Dough, and A. D. Etheridge, all of the nearby Kill Devil life-saving station; and W. C. Brinkley, a lumber buyer. Three of the five had come only to give help in case of disaster, but all had attended the most astounding event of the twentieth century.

Three other flights were made that day. The final one, with Wilbur piloting, started at 12 noon. The distance covered was 852 feet and the time of flight 59 seconds. Immediately following a successful landing, a sudden gust of wind blew

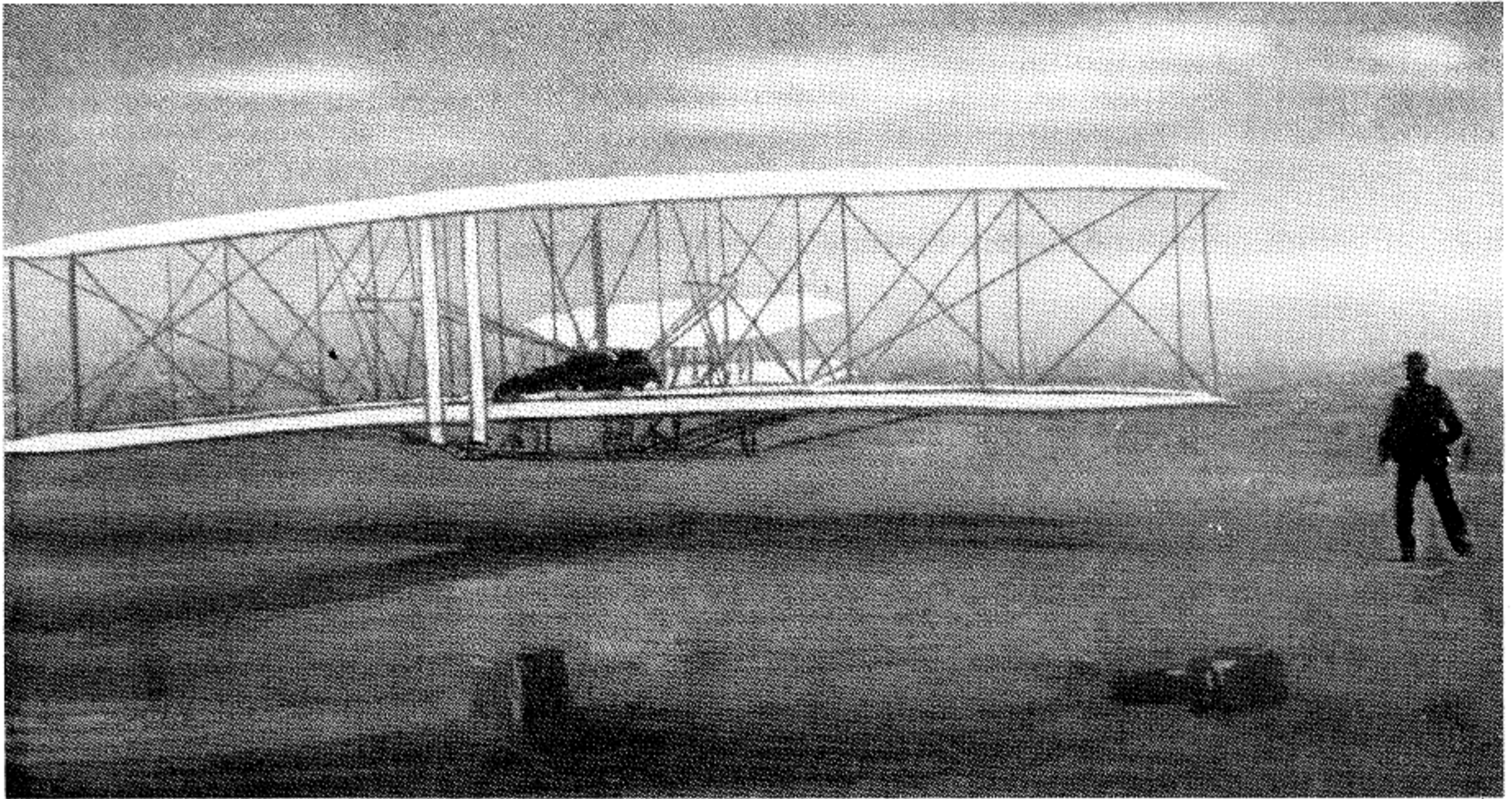

The First Flight by Man. The Wright Brothers at Kitty Hawk, 17 December 1903.

the airplane over and damaged it so severely it was never flown again.

The Wright brothers' accomplishment was no accident. Their great advance was not in the building of a superior power plant, as Manly, by every known standard of comparison, had surpassed them in the Langley plane. Rather, the real basis of this success was their brilliant achievement in obtaining balance in flight and control of direction by means of wires which acted as rudders and warped the wings of the biplane in any manner desired.

The inventors had prepared carefully for the eventuality of flight, having taken advantage of what little trustworthy science was known on the subject. They then set about to solve for themselves heretofore unmastered difficulties by dogged persistence and great natural aptitude. For example, in constructing their propellers, they profited from what they considered a mistake in Langley's propeller design, and built a homemade wind tunnel to prove the professor's scientific approach on this feature was wrong.

Likewise they gained much from the earlier glider studies of Sir George Cayley and the great German experimenter, Lilienthal. They actually built and flew identical gliders in order to see

for themselves how these men had arrived at their basic principles of aerodynamics. That they were ever watchful for any possibility of betterment in design can best be judged by Orville Wright's statement that he got the idea of wing warping (a means of lateral control in lieu of ailerons or wing flaps) from twisting the top on a cardboard box when wrapping a package in his bicycle store.

The brothers from the first realized that, if they ever got an airplane into the air, they must learn to control it. "We thought," said Wilbur, "that if some method could be found by which it would be possible to practice by the hour instead of by the second there would be hope of advancing the solution of a very difficult problem."

The Wrights decided that the best way to do this was to find some place where the wind commonly blew at about 20 miles an hour, which they estimated was the best velocity in which to practice. They found such a place at Kitty Hawk in the late summer of 1900.

Using various models of gliders, they observed the effects of speed, lift, and pull in varying positions so that they slowly began to learn exactly what to expect when they first attempted to fly.

They experimented with new shapes of wings and found that, by twisting its surface in conjunction with a pivoting rudder, the glider could be balanced in flight.

When not making glider flights, the Wrights utilized all kinds of wing surface materials in the wind tunnel they had made for themselves. Thousands of tests were conducted in this device, 16 inches square and 6 feet long. During the greater part of 1902 they not only sought to find the most efficient manner in which to construct a propeller, but actually designed and built an engine to drive it.

The first aircraft to be successfully air-borne was a mixture of bicycle manufacturing knowledge with considerable aeronautical experience, plus a large measure of genius. Its total weight, including the pilot, was 750 pounds. The motor was officially rated at 12 horsepower, and carried air-borne 63 pounds of weight per horsepower. It had a maximum motor revolution of 1,020 per minute, while each of the 2 propellers had a revolution of 340 times per minute when in flight.

The event was heralded in the press with banner headlines and the public accepted it with both skepticism and awe. People were hardly able to visualize man flying through the skies when the roads and streets were cluttered by "cranks" trying to nurse the "one-lungers" of their horseless carriages back to life. At the same time many individuals realized the military potentialities of aircraft if refinement did follow and a reliable motor could be made that allowed such a device to be used for these purposes. That is, practically everyone realized this but military men themselves, who seemed very content to tinized nitroglycerin with cellulose to form a progressive burning propellant.

This situation was true in all countries, doubtless as a result of the earlier failures of craft designed by Ader, Maxim, and Langley. Nevertheless, the successful flight of the Wright airplane was destined to affect warfare, and especially machine-gun design, just as much as did Vieille's discovery of smokeless powder by rolling gelatinized nitroglycerin to form a progressive burning propellant.

In 1904 the Wright brothers continued their experiments on Huffman Prairie, near Dayton,

Ohio, with a new machine. Over a hundred flights were carried out. In 1905 distances up to 24 miles were covered. In the next 2 years the brothers devoted a great deal of their energies to the construction of new machines and to business negotiations. Still very little attention was attracted to their remarkable flights.

In the fall of 1907 the Aerial Experiment Association was organized by Dr. Alexander Graham Bell, inventor of the telephone. Commencing in 1908, simultaneously with the Wright brothers' activities, the association carried on its experiments, with headquarters at Hammondsport, N. Y. The organization was composed of Dr. Bell, Glenn H. Curtiss, Thomas E. Selfridge, F. W. Baldwin, and J. A. D. McCurdy, the latter two being Canadians.

The association built a number of machines, the design of each being credited to an individual member. The first plane constructed was the "Red Wing," which covered a distance of 319 feet on 12 March 1908. Selfridge was given credit for its general plan although the test flights were conducted by Baldwin.

On 8 August 1908, Wilbur Wright captured the imagination of Europe when he flew his machine over a race course near Le Mans, France. Actually there had been earlier short flights in Europe. Alberto Santos-Dumont, for instance, had flown his biplane for a distance of 150 feet in October 1906 and made other brief hops the same fall. And in 1907 Henry Farman had piloted a Voisin machine at Issy, France, in a circular flight of 1 kilometer.

At Le Mans, Wright was air-borne for only a minute and forty-seven seconds, but 3 days later he was aloft for 4 minutes, during which time he executed all kinds of maneuvers. On 21 September 1908, he remained in the air for more than an hour and a half, flying a distance officially estimated at 42 miles, and afterwards made many other prolonged flights.

The successes of the Wright brothers started a frantic renewal of effort on the part of European inventors and flying machines were constructed in every major country of Europe. The next 5 years were spent in attempts to create new air records. In the middle of 1909 flights of unusual proportions became an everyday occurrence.



Men like Bleriot, Santos-Dumont, Farman, Latham, and Voisin were among the most prominent to contribute to the rapid growth of aviation. They flew great distances and at unbelievable heights in their rickety contraptions. On 15 July 1909, Bleriot crossed the English Channel from Calais to Dover, a distance of 31 miles, in 37 minutes. He landed in a meadow only a few feet away from the spot where Blanchard and an American doctor, Jeffers, had ascended in their balloon for the first aerial channel crossing 120 years before. On 16 November 1909, Farman covered 134 miles in 4 hours, 17 minutes, and 53 seconds.

An American, Glenn Curtiss, carried away the Gordon Bennett prize when an air show was staged at Rheims, France. He did it in a plane of his own construction that averaged the unheard-of speed of 47 miles per hour over the whole course. Curtiss came back to America and won \$10,000 offered by the *New York World* for the first flight from Albany to New York down the Hudson River. By this time he had invented and patented a system whereby a movable hinged aileron controlled a machine in flight, a feature considered by many to be one of the greatest contributions to aviation.

### Beginnings of Military Aviation

In this country Congress, having already sponsored a signal failure, was reluctant to give aid to aviation, but in 1908 the Army did show an interest. In October of that year the first test flight for the United States Army took place at Fort Myer, Va. It reserved the right to pay the designer \$25,000 provided the machine met certain specifications, which were incidentally above and beyond anything thought remotely possible. One was that the aircraft's speed must hold a continuous 40 miles per hour and fly a distance of 100 miles. The Wrights were the only applicants to submit a complete machine and fulfill the requirements. In the official test the Wright plane flew slightly faster than the specified speed and covered the maximum distance of its fuel load, a total of 125 miles. The entire trial was conducted without any serious mishap. Specifications for the machine, prepared in the administration of Theodore Roosevelt, father of the

modern Navy, gave the United States Army the first airplane ever used for military purposes.

This test, purposely carried out over Washington, D. C., where all could see for themselves, created much more of a sensation than did the Kitty Hawk flight 5 years earlier. In fact the press could hardly find sufficient adjectives to describe this new tool of war. Enthusiasm was dampened greatly a few days later by an untimely and tragic accident when Orville Wright, with Lt. Thomas E. Selfridge as co-pilot, on taking off from Fort Myer entangled his propeller with a guy wire, causing the plane to fall to earth. Selfridge became the first airplane fatality, while Wright was severely injured. The public was brought face to face with the sobering fact that, although flying was at length accomplished, the price for future advancement would have to be paid for in blood by its pioneers.

The year 1909 also marked the beginning of aeronautics in Russia. It was started principally as a sport. A private school, located in Moscow, was operated by a civilian named Maslenicoff. It was soon taken over by the government and known from then on as the Aviation School of the Moscow Imperial Aeronautic Association. Later another school was organized at Odessa, and at each army manuever held after this, officer graduates were invited to show their piloting skill. Any proved ability was recognized by promotion. The training became so popular with the army that a third government flying school was established at Sebastapol. The honor graduates of the earlier classes of the Imperial School, Captain Ulianin and Lieutenants Rudneff, Piotrovsky and Matsievitch, were placed in charge, after first having been ordered to France to observe the latest techniques in the art of handling planes.

The Russian Army Aviation Force was a part of the Engineering Corps, known as the General Military Technical Department, with headquarters at Petrograd. The Russians have always been air minded and their progress was steady throughout this early development period.

The specifications set by the United States Army in 1908 for testing aircraft formed the standard by which the rest of the military world judged the value of planes until 1910. The French then organized what was called the

French Military Competition, which was originated to further the refinement and betterment of design of airplanes in that country.

The conditions to be met by the competing aircraft and the prizes to be awarded the winners were based on the following requirements:

The airplane and engine must have been constructed in France and be capable of a flight of 180 miles without stop, carrying at the same time 660 pounds above the fuel load; the speed must average a minimum of 37.3 miles per hour; and if this much of the test is completed successfully, then altitude flights must be made during which the machine must rise with a full load to a height of 1,460 feet within 15 minutes of taking off.

The machine turning in the best performance would be bought by the Ministry of War for the sum of 100,000 francs, and the manufacturer given an order for 10 additional machines of identical design at 40,000 francs each. An extra bonus of 500 francs would be allowed for each mile an hour reached above the 37.3 minimum.

The makers of the machines turning in the second and third best performance would receive orders for six and four machines respectively, at the same price. If only one machine came up to specifications, the designers would receive an order for all 20 aircraft.

Encouraged by the monetary inducements offered, 16 French producers designed and constructed special types of airplanes, 34 in number, for trial in the 1911 Military Competition. The final test was over the 496-mile course between Rheims and Amiens. Eight planes passed the test, the winner being a pilot named Weyman, flying a Nieuport monoplane with a Gnome motor. He had an average speed of 73 miles per hour.

This unique plan to give an incentive to aircraft development proved the most beneficial thing that could be done for aviation and, as it turned out, was the salvation of France. The French proceeded from this point to outstrip the world in aircraft design, especially with respect to military types, which were tried as an aid to scouting during army maneuvers. Trials under field conditions showed the officers the minimum amount of service that a plane could contribute while still being of value to the ground

forces, and the requirements that would have to be met by an airplane in order to be suitable for general military work.

France's great strides forward in aeronautics were watched closely by her old enemy, Germany. When it became apparent that the French were leaving everyone else far behind in this field, the Kaiser, on 27 January 1912, offered a prize of 50,000 marks as an incentive to improve aviation for German military use. The contest was to be arranged and awards made by members of the Imperial Automobile Club, Imperial Aero Club, members of the German Automobile Constructors' Association, and delegates of the Navy and War Departments.

This gesture from the Kaiser was the signal for the German nation to concentrate on aviation. The Aerial League of Germany started a public subscription which brought in 7,234,506 marks the first year. The plan of the league was to train the largest number of pilots in the shortest time in order to form an adequate reserve, thus encouraging civilian interest in the scheme. Its success was out of the ordinary; by the end of 1912, 230 military pilots were registered and by the next year 600 were graduated. The number of builders grew from 20 in 1912 to 50 the following year. These successes of the Aerial League were instrumental in causing the Reichstag to pass a bill authorizing 35,000,000 marks for military aeronautics for the next 5 years.

This was all that was needed to bring German aviation to a point of efficiency where record after record began to fall. The year 1913 saw the endurance mark raised by Reinhold Boehm to 24 hours and 12 minutes, and an altitude figure set by Heinrich Oelrich at 26,246 feet. In this one year over a hundred other records were established. For instance, an aviator named Landsmann covered 1,335 miles in a single flight which was at the time the longest distance ever traveled by man in one day. The secret of the plane lay in the design of its Mercedes motor, which was a direct result of the interest created by the Kaiser's award to encourage inventors.

After the accident that cost the life of Lieutenant Selfridge, there was a stalemate in American military aviation. The next official flight took place at Fort Myer again, although not until

July 1909. The machine, which was another Wright, successfully passed the tests and was bought by the Government. Lts. Frank P. Lahm and Benjamin D. Foulois were assigned to receive flying lessons from the Wrights. An aviation field was established at College Park, Md., and a young captain, Charles DeForest Chandler, then disbursing officer of the Signal Corps, was made officer in charge of the Aeronautics Division of the Signal Corps.

Wilbur Wright served as the instructor and taught Captain Chandler and Lts. F. P. Lahm, Benjamin D. Foulois, Frederick E. Humphreys, T. DeWitt Milling, H. H. Arnold, and George

C. Sweet, the latter being assigned to the school for instruction by the Navy Department.

The next venture by the Army in aviation was the acceptance of its first dirigible in October 1909. It was commanded by Capt. Thomas G. Baldwin. It too was initially tested at Fort Myer, with Lieutenant Lahm in charge. After successfully meeting all requirements, it was flown to Omaha and turned over to Lts. R. S. Bamberger and John G. Winter, both of the Cavalry.

These developments were followed by the failure of Congress to allow adequate appropriations for aviation. Again things came to a standstill as far as the Army was concerned through 1910-11,

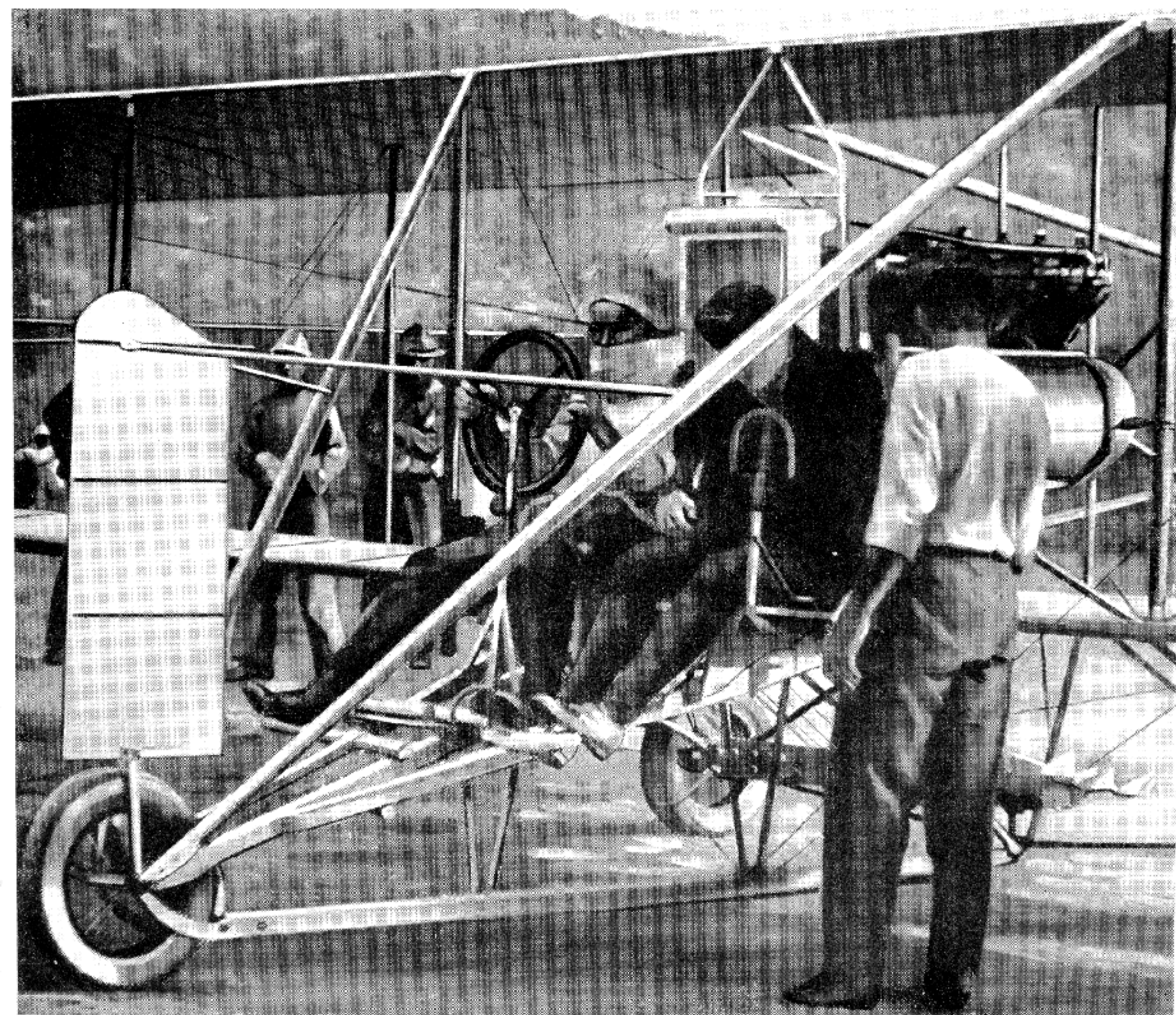

One of the Airplanes Used by the Constitucionalistas in Mexico to Bomb Federal Gun Boats.

while officers of the newly formed Army Aeronautics Division attended voluntarily nonmilitary aviation meets and followed the literature on the work done by civilian enthusiasts.

European countries were in the midst of preparing for the day when airplanes would be used in conflict, but to Mexico goes the distinction of being the first country to employ aircraft in warfare. During the Constitucionalista campaigns against the Diaz regime in late 1910, a conglomerate assortment of aircraft was purchased from civilian builders in the United States and American aviators employed to fly the planes. In spite of the questionable quality of the flying matériel that was assembled and the still more dubious military value of the aerial maneuvers, this small flying force did do patrol and reconnaissance work, particularly in locating guerrilla troops in their mountain retreats. With the victory of the Constitucionalista regime, the American professionals were released and the Flying Corps of the Republic of Mexico formed.

During the Mexican border incident of 1911 the United States Army found itself without a single plane to send to the troops in the field. This greatly agitated the few aeronautically minded officers who were in the service, as they could see that any good work done at this time by a flying machine would be invaluable in future planning and a wonderful incentive for asking Congress to appropriate desperately needed funds.

With air development left in the hands of civilians and with military authorities still taking a dim view of the role aircraft could play in warfare, by an odd quirk of fate the United States was still the first government to use an airplane under conditions that approximated war between major powers. The border incident with Mexico was a logical opportunity for this to occur and the ever-alert civilian promoters did not let it go unheeded. A Wright flying machine, the personal property of Mr. Robert J. Collier, president of the Aero Club of America, was loaned to the United States Government for use on the border. With this machine Lt. B. D. Foulois and a civilian, Mr. P. O. Parmalce, made a number of flights along the border carrying messages between officers in command.

## Pioneer Attempts at Aerial Armament

Civilian enthusiasts in the United States were aware of the fact that without Government backing they could never progress beyond the novel stage of flying. They continuously planned events calculated to impress or at least interest the military high command. This was often done with the aid of aeronautically minded Army personnel who willingly donated their services whenever possible to further the cause.

One of the most colorful of these demonstrations, which was to have a far reaching effect, was carried out before a crowd at Sheepshead Bay race track on Long Island, N. Y. in August 1910. A pusher plane piloted by Glenn Curtiss, an aviation pioneer second only to the Wrights, also carried 27-year-old Second Lt. Jacob E. Fickel, who had won a reputation as an expert marksman in his 3 years of military service since enlisting as a private.

All afternoon the tense crowd had been watching the antics of the flimsily constructed flying machines. The spectators had been promised an act that had never before been attempted, and they waited patiently as the young soldier climbed aboard carrying with him a regular caliber .30 Springfield infantry rifle.

Lieutenant Fickel's intention was to fire the first shot from an airplane in flight at a target on the ground. Because of his proved marksmanship he was chosen to perform in the opening act of a drama the final outcome of which no one can even imagine.

With Curtiss at the controls and Fickel clutching the rifle with one hand and a wing strut with the other, the plane took off. After gaining an altitude of 300 feet it circled the target that had been erected in the center field of the race track. Four times the young officer, when he was not clinging for dear life, took aim and fired. Two of his four shots were bull's-eyes. The startled crowd roared its admiration of his skill and at the same time must have sensed the beginning of things certain to follow.

At the time just to keep a machine airborne was a feat in itself, but to possess also the power to bring an adversary to earth stimulated the imagination, and the press made the most of it. Soldiers were pictured being transported by

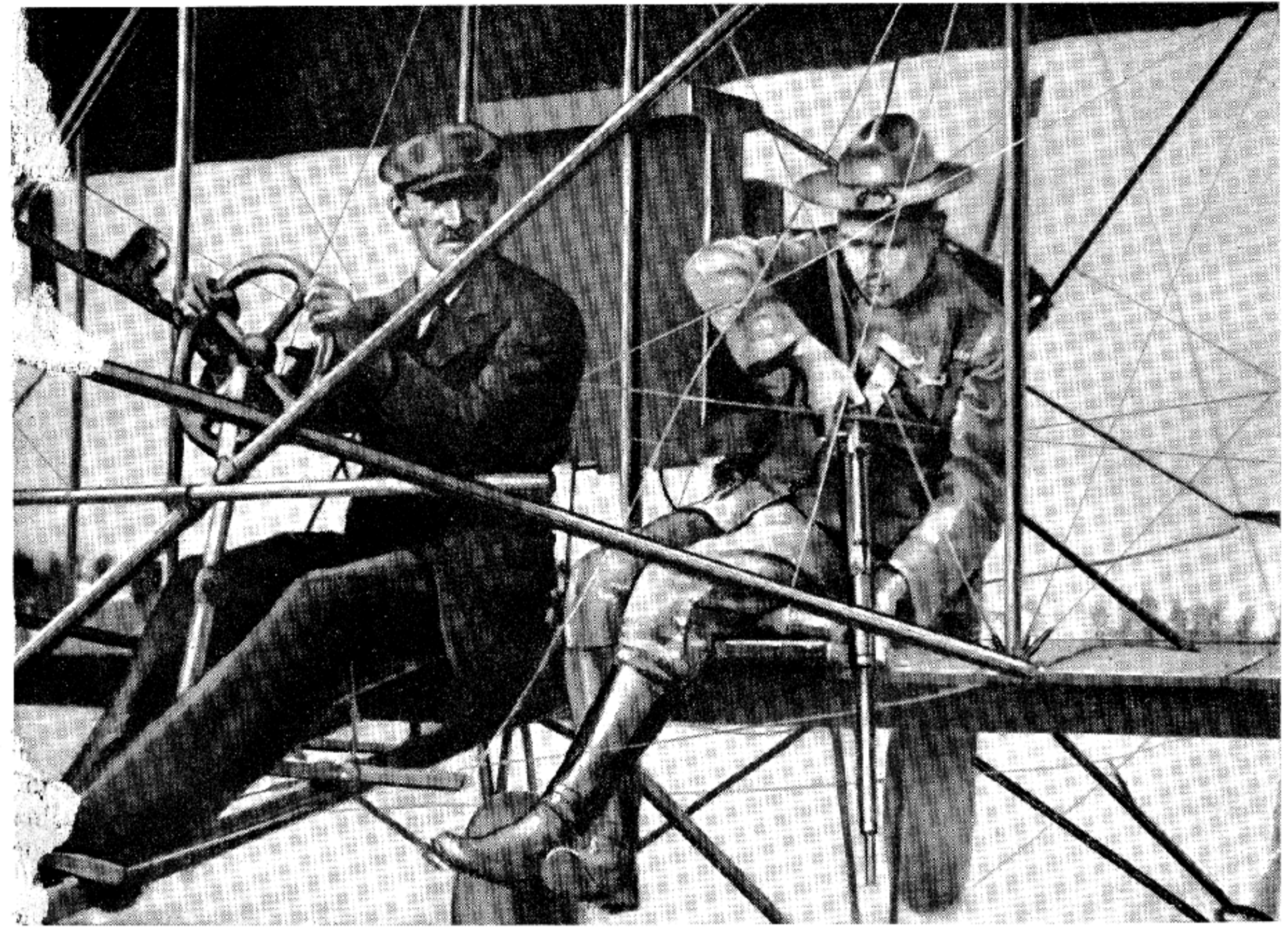

The First Shot Fired from an Airplane. Glenn Curtiss, Pilot, and 2nd Lt. Jacob E. Fickel Holding the Rifle.

planes or silent gliders and noiseless invisible wars were predicted by the use of smokeless powder and rifle-muffling devices. The impact on the public was terrific, but military minds remained skeptical. They mustered mathematical calculations to prove that nothing but a rifle could be fired from a plane, one shot at a time, and under certain conditions only since successive and rapid explosions would upset the plane. And under no conditions could any great weight be dropped in flight since its sudden release would be certain to make the plane fall out of control.

The development of speedy aircraft was also discounted by the "experts" as being wholly unnecessary as far as their use for war was concerned. Those who expressed the possibility of equipping airplanes with two motors were laughed at loudly. A principle of aerodynamics

was claimed that, if two engines were mounted, one would exert a mere fraction of its power due to its proximity to the other. It was happily concluded that no single engine could possibly lift the additional one, and that, in case such an impossibility was accomplished, failure of one motor would force the plane into a power-driven spin. But these theories and calculations soon went the way of most expert advice from people who have been educated beyond their own capacity for intelligence.

On 14 November 1910, a Curtiss plane piloted by Lt. Eugene Ely took off from the United States cruiser *Birmingham* and on 18 January 1911, another Curtiss plane, also piloted by Lieutenant Ely, landed on the quarter deck of the armored cruiser *Pennsylvania*, anchored in San Francisco Bay. A crude arresting gear, with hooks fastened on the under carriage of the plane

and an ingenious arrangement of ropes attached to sand bags stretched across the wooden deck, brought the machine to a stop within 30 feet after landing. A half hour later the pilot raced his machine down the boarded landing strip and became air-borne before reaching the edge of the deck.

This was the first step to adapt aircraft to naval use. A week later, on 26 January 1911, Glenn Curtiss, after one unsuccessful attempt to make a hydroplane out of his machine, the "June Bug," put floats under another plane and took off after a short run. A Frenchman, Henri Fabre, on 28 March 1910, had previously arisen from the water and flown about 1,000 feet but was completely wrecked in trying to land. Curtiss made the first successful take off and landing.

On 17 February 1911, Curtiss made another advance in naval aviation, for on that date he flew his pontoon-equipped aircraft alongside the *Pennsylvania* in the harbor at San Diego, Calif., and was hoisted aboard with the ship's crane. After a short stay aboard the vessel, the machine was lifted over the side and Curtiss flew it back

to its hangar on North Island. The system of hoisting a seaplane on board and putting it over the side with a crane is still followed by British battleships and cruisers.

While development in land planes was unquestionably greater in several other nations, the American Navy was making her bid for world supremacy in naval aviation. An aeronautical school was established on the academy grounds at Annapolis, Md. The study of getting an aircraft into flight from a battleship's deck was the first major problem taken up at the school.

It was the opinion of United States naval architects that a more practical method of launching an aircraft than putting it over the side was needed if the airplane itself was to play a dominant role in future wars. The daily papers, approximately 18 months after Curtiss made his novel experiment, announced the successful test of a launcher for catapulting planes from the deck of a ship. The device was constructed at the Navy Yard, Washington, D. C., and a successful trial was held there on 12 November 1912. Naval authorities announced through the

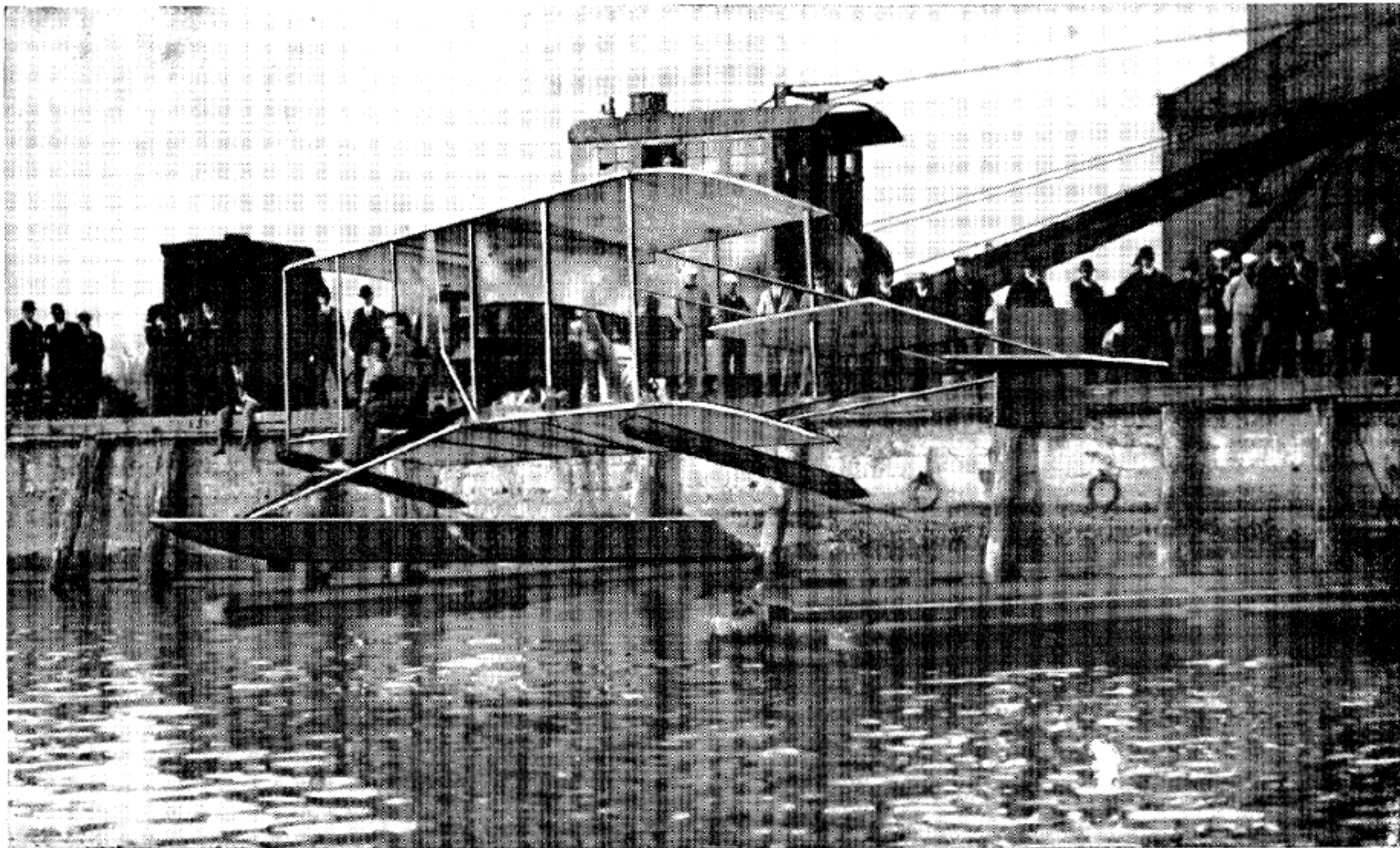

The Successful Trial of the Chamblis Catapult at the Washington Navy Yard, 12 November 1912.

press that the device would make possible the use of older and outmoded ships as floating hangars and launching platforms. Planes from these vessels could be used profitably in conjunction with the main fighting units of the fleet for scouting and spotting work.

Navy mathematicians also brought out the startling information that if an aircraft so used could maintain a speed of 47.4 miles per hour it was absolutely safe from enemy anti-aircraft fire. Such phenomenal speed would at the same time render the craft useless for anything other than close observation work. No rifleman in the aircraft, they said, could possibly hit anything from an object moving at such a rate, and, as they further pointed out, any sudden release of a heavy object would be certain to upset the plane. Dropping a bomb was thus out of the question, and as there was no possibility of damaging a battleship, the airplane in warfare seemed to qualify only as a harmless nuisance.

The Italians were the first to destroy the myth that heavy bombs could not be dropped. During the Italian-Turkish War of 1911, they not only used heavier-than-air ships initially in actual warfare between major powers, but also were the first to drop bombs on an enemy. Previously, Lt. Myron S. Crissy, United States Army, in January 1911, had dropped a small bomb in San Francisco Bay, and gained the distinction of dropping the first such projectile from the air. His pilot was a civilian, P. O. Parmalee.

Italy had already made secret tests to determine the effect on airplanes of releasing heavy objects while in flight. Capt. Alessandro Guidoni of the Royal Italian Navy, considered in his country a leading authority on aerodynamics, was in charge. The plane used was an English-built Farman capable of lifting torpedoes weighing 700 pounds. Captain Guidoni became so efficient in this type of launching that he is recorded as making 9 direct hits out of 10 tries on a target a mile and a half distant. He exploded the accepted theory that a plane is upset by the sudden release of a heavy object in describing his plane's reaction during the successful torpedo droppings.

"When the motion forward is uniform, there is a dynamic equilibrium between the different forces. As soon as the launching has taken place,

two resultants will act upon the plane, one vertical due to the difference between the lift and the weight and one horizontal due to the difference between the thrust and head resistance.

"Owing to these two forces the plane acquires two corresponding accelerations until the dynamic equilibrium is regained, the vertical acceleration giving a rising motion to the machine. Thus there always exists an equilibrium between the applied force when the forces of inertia and the resistance meet in the ascending motion."

The Italians first put this information into application by dropping sizable bombs on the Turks. The damage was slight because of the fact that no sight other than the aviator's guess was employed in putting the bombs on the target. The event contributed nothing other than a glimpse of the kind of warfare that was to follow.

The year 1912 in the United States found our Army interested in establishing aviation in the Philippines. Lt. Frank P. Lahm, with a single Wright plane, was sent to the islands for the purpose of establishing a flying school. This was again followed by a lack of congressional appropriations and even such meager plans were prevented from being put into effect. What a few years before promised to be the nucleus of an air force had by now practically ceased to exist.

Finally on 24 August 1912, Congress did appropriate \$100,000 for the purchase, maintenance, and operation of Army aircraft. Twelve planes were contracted for in that year, and Maj. Samuel Reber was put in charge of the so-called Aeronautics Division. The appointment came close to being an empty honor. When an inventory was taken nearly a year later in June 1913, it showed the exact distribution of machines and pilots to be: Texas City, Tex., 11 pilots, 6 training machines and 4 suitable for military use; North Island, San Diego, Calif., 5 pilots, 1 training plane, and 1 military plane; Philippine Islands, 1 pilot, 1 training plane and no plane suitable for military use. The general equipment of this handful of aviators consisted of the barest necessities, as the allowance made by Congress was too slight to afford more than the most necessary spare parts, with a few tents to house both matériel and men.

The next fiscal year's appropriation was scarcely better, being only \$125,000. This made

it impossible to acquire the motor trucks, repair shops, extra motors, and other equipment considered absolutely vital.

With so little money the Signal Corps was unable to extend the aviation branch beyond a mere hand-to-mouth existence. Progress in this branch of the service naturally ceased, although it was able to muster two machines and five pilots for the war maneuvers held in Connecticut beginning 24 August 1912. This represented the first official use of aircraft on United States Army maneuvers. The pilots were Capt. F. B. Hennessy, and Lts. B. D. Foulois, Harold Geiger, T. DeWitt Milling, and Harry Graham.

Lieutenants Milling and Geiger barely averted a serious accident when their plane was slow to get airborne after take-off with the wind, and missed a head-on collision with a stone wall by inches. An alert Signal Corps cameraman recorded the incident for posterity. An investigation later proved the near accident was due to the manner in which Army engineers had built the field. The only way pilots could take off was to the north, since the south end came to an abrupt end flush with a forest of tall trees. Unfortunately the prevailing winds were such as to be always behind the craft. The Army learned from this experience that air fields had to be con-

structed with the winds taken into consideration.

The British Admiralty, which must have known about the successful dropping of aerial torpedoes by Italy, did not accept completely the American Navy's theory that the battleship could not be harmed by the airplane. In order to come to a definite conclusion, the British built at Hendon, England, a mock battleship and then bombed it with exact duplicates of the Italian high explosive and incendiary bombs. The latter did the most damage to the dummy vessel. The report on the incident shows more than anything else the size and over-all damage potentialities of the bombs.

"The harm done by bombs dropped from airplanes on battleships is still little more than a theory. There are some who think the battleship still adequately protected from aerial bombs, but we must not take for granted that aerial bombs will never be made heavier than 10 or 15 pounds, and an airplane will never be able to drop a weight heavy enough to harm a battleship without losing its control. Actual experiments have shown that such a weight up to 175 pounds can be dropped without the plane being thrown out of control, and, needless to say, a bomb or a similar load of explosives from 26 to 100 pounds can do harm to the most heavily armored battleship."



A Curtiss Airplane, the First to Accompany the Army in Maneuvers, Clearing a Stone Wall.



This report showed for one thing that the British, aware of both the Italian weight dropping and the contradictory theory of the Americans, were still as confused at the end of the experiment as they were at its beginning.

College Park, Md., had become the United States Army's chief aeronautical experiment station. When the possibility of bombing became an accepted fact, it was approached from the typical American viewpoint. What good was the dropping of high explosives unless they could be placed where they would do the desired damage? First Lt. R. E. Scott, U. S. Coast Artillery, was ingenious enough to find a workable solution to the problem. For he originated a device that could be aimed at the target. It made a simple computation whereby speed, drift, and time of fall were calculated and the world's first practical bombsight came into being. What is now known as the timing-sight principle was used.

As early as October 1911, Scott made experimental bomb droppings from an airplane at College Park, piloted by Lt. T. DeWitt Milling. Scott simplified the problem of air bombing by combining a gunner's quadrant, a telescope, and a stop watch. With this device he could determine ground speed quickly and with the known altitude, transpose from a set of tables the proper angle at which to aim the telescope. The bomb was released when the target appeared in the sight and reasonable accuracy was assured.

The telescope was mounted on gimbals and could be pivoted along the graduated arc from vertical to a horizontal position. To operate the bombsight, Scott, when approaching the target at a known altitude, read from a barometer, would first find his ground speed. He did this by setting the telescope at  $45^\circ$  and sighting an object. The telescope was then swung to the vertical position and the stop watch clocked the time interval necessary for the object to reappear. With this information he would read from a chart the proper angular setting of the telescope to hit the target. When the target then passed in view, the bomb was released.

From the experience of hundreds of drops, Scott made himself a set of prepared tables that took in practically every speed and height that were commonly used and accepted in bombing tests. The most difficult was the obtaining of

accurate data from which he could compute the angular table for determining the exact instant of drop.

Following these experiments, Army aviators who witnessed them agreed that the device was a complete success, and that only target practice was needed. It was also decided that the pilot's skill would play no small part in the successful hitting of targets and that a reasonable degree of accuracy could be obtained from altitudes exceeding 3,000 feet. Below this height it was not thought that an airplane would be sufficiently immune from hostile fire to warrant its use.

When this practical sighting system had been developed, the Army found that further trials were not possible on its small appropriations and all experiments were ordered discontinued. Scott, being very disappointed at this turn of events, carried his sight abroad where it aroused great interest. He entered the Michelin competition held in France, which offered as much as \$30,000 in prizes for the best bomb drop on a target 20 meters in diameter at various altitudes from 200 to 1,000 meters. Scott won first prize at the 200-meters altitude by placing his bomb within  $1\frac{1}{2}$  meters of the target center. He hit in the target at every height up to 1,000 meters.

Scott was faced with the decision many other American inventors before him were forced to consider. He realized that inducements abroad were such as to preclude wasting his time on further developments of a device that was not wanted at home. Patriotism alone could not contribute sufficient material inducement for staying in the service of his own government and he reluctantly resigned his commission to exploit his invention overseas.

The Navy at its aviation station at Annapolis also made a great contribution to flying at this time. On 26 July 1912, the first wireless message ever sent from an aircraft was transmitted from a hydroplane to the United States torpedo boat *Stringham*. The message, radiocast by Ensign Charles Hamilton Maddox from a height of 300 feet and a distance of 1 mile, consisted of, "We are off the water, going ahead full speed on course for Naval Academy."

The entire apparatus was designed by Maddox and had many new improvements over previous

unsuccessful experiments. Besides making it much lighter, a few other features were added that included a new type of aerial and a shielding device that overcame the noise of the engine. The achievement was truly remarkable as the lifting capacity of hydroplanes was so limited it was thought to be impossible to design a light enough sending set capable of transmission.

This weight factor was so critical that the Army was searching for a substitute for radio, then being used universally on land. The efforts to develop another means of aircraft communication resulted in consideration and testing of a device that today can hardly be taken seriously.

This gadget was known as the Means Smoke Telegraph System. The signal apparatus, fastened on the leading edge on the upper wing of the plane, was first tried out at Signal Corps Aviation Field in College Park. A trigger arrangement was located beside the pilot who

could control the length of time for opening a valve that allowed dense smoke to be expelled. The aviator could then fly along puffing out dots and dashes, a long puff for the dash and a ball of smoke for the dot. Much publicity was given the contrivance by the promoter and even the conservative *Literary Digest* predicted that bulky wireless instruments, and perhaps even the conventional telegraph, were doomed by this clever machine.

It may be true that the Army's test of the Means smoke telegraph today has a humorous angle, but most certainly the next experiment successfully carried out by the Army at its College Park flying field has proved anything but funny. From the day of its conception it has presented to every nation on earth one of the most serious problems to confront it. For the combination of machine-gun fire with mobility of aircraft then made its first appearance.

## LEWIS AIRCRAFT MACHINE GUN

### The First Aerial Machine Gun

A week after the world was saddened by news of Wilbur Wright's death from typhoid fever on Memorial Day, 1912, an event concerning aviation took place on 7 June 1912, that would in time directly affect mankind far more than did the pioneer flight at Kitty Hawk. For on this day, Capt. Charles DeForest Chandler successfully fired a full automatic weapon from an aircraft in flight for the first time in aviation history.

The experiment was carried out unofficially. Lt. Col. Isaac N. Lewis, Coast Artillery, United States Army, had devised a weapon for the Automatic Arms Co. of Buffalo, N. Y. Feeling it was a most progressive step in machine-gun construction, he visualized its use in the most promising development of the day, the flying machine. With this in mind and knowing that success of his experiment would guarantee endless favorable publicity, he arrived at College Park with no introduction other than his rank. The suggestion that the weapon be air fired as an incentive both to aviation and machine-gun development was placed before Captain Chandler, the commanding officer at College Park. The latter not only granted the request but offered to fire it personally.

This early model of the Lewis air-cooled automatic machine gun weighed 25 pounds, 6 ounces, and was chambered for the caliber .30/06 United States Army infantry rifle cartridge. The ammunition was contained in a circular drum that slipped over a post on top of the receiver. The rate of fire of the weapon was given as well above 750 rounds per minute. For this trial, however, it was slowed down by putting unusual tension on the return spring. Lewis thought the best rate for the occasion to be 500 shots a minute, allowing the gunner to empty the drum in 6 seconds. The gun had no sighting arrangement other than looking along the top of the unusually large aluminum barrel jacket.

Chandler, after being shown by Lewis how to operate the weapon and being made familiar with the kick and amount of jump when operating it full automatic, took his place in the Type



Lt. Col. Isaac N. Lewis, U. S. A.

B Wright pusher plane with the muzzle of the gun resting on the cross bar upon which pilot and observer placed their feet. It had been agreed that the firing was to take place a short distance in front of the hangar. In the interest of safety a decision was made to fly at a low altitude.

A target, consisting of a piece of cheesecloth 6 by 7 feet in size, was laid on the ground. Lewis calculated that the plane would travel over the length of the target in one-tenth of a second. Lt. T. DeWitt Milling, who was piloting the plane, made three approaches at an altitude of 250 feet. Each time a short burst was fired. Examination showed five hits on the target and several bullet holes directly in front of the cheesecloth. Chandler could not see where the bullets were hitting on the ground and when circling over some adjacent fish ponds, he fired the remainder of the drum into the water to observe the spacing of the bullets by the splashes.

This unscheduled burst caused the colonel much concern. Thinking that Chandler may have fired the weapon accidentally, he asked the observers to take cover in the hangars as a precautionary measure. He concluded that if the trigger had been pulled once accidentally, it might be done again. Later Lewis was much relieved by the captain's explanation for firing into the pond.

Realizing they had contributed to aviation history, they jubilantly planned another trial the following day. This time a target 2 yards wide and 18 yards in length was used, and again the 2 officers, Chandler and Milling, took off. From experience gained the day before, they decided to raise the altitude to 550 feet. Even at the increased height, 14 shots out of 44 fired hit the target, and the remainder of the bullets left holes in the ground close by. As the limited space allowed the gunner practically no traverse, accuracy depended much on steering the machine steadily over the target.

For once the newspapers were caught by surprise and although the firing was done almost within sight of the Nation's capitol, the news did not reach the public until the following day. Had it not been for an enthusiastic amateur photographer named MacCartee, who journeyed to College Park and asked Captain Chandler to pose with the gun in the plane, no picture of the

event would be in existence today. At the time, Lieutenant Milling was away on duty and Lieutenant Kirkland had to "stand in" as the pilot when the picture was being made.

Newspapers and magazines everywhere carried the picture and much was written about the future of aircraft in warfare. The experiment proved that sustained fire would not upset a plane's balance, as the experts had accepted as a certainty. In accordance with a customary journalistic privilege, reporters assigned to the War Department used the incident to interview a spokesman of the General Staff. They came away with a very clear understanding from the high command that aircraft were suitable for scouting only. Any dream of aerial conflict was simply the product of a too fertile imagination, a failing often found in younger men with insufficient service to recognize certain things as utterly absurd. Besides the experiment had been run without official sanction, which, as far as the military authorities were concerned, left it in the category of having never happened.

There is no desire at this point to take advantage of the hindsight that the passage of time affords. The limited flying and erratic performance of aircraft in the United States had impressed officials only with their possibilities for scouting and message carrying. On the other hand, officers, mentally capable of mastering the problems of staying aloft with their intricate machines, were also the type who had not only vision but the means of extending it to reality. Even so, it was extremely doubtful if a single officer at College Park at the time could foresee the mighty surge of aircraft armament development that was to occur in the next 5 years, particularly in Europe where war was only months away.

If the high military authorities had any idea of dampening Lewis's enthusiasm for the potential uses of his machine gun in aircraft, they certainly overlooked his reputation. The colonel was a man who did not discourage easily. When dedicating himself to a purpose, he was no respecter of person, rank, or position in life, and he had already acquired the title, "the stormy petrel of the service." Having been a successful inventor throughout his military career, he had the utmost contempt for those who could not see the



Captain Chandler, the First Man to Fire a Machine Gun from the Air, with Lt. Kirkland, His Pilot, at College Park, Maryland.

obvious possibilities of anything that had required so much of his time and labor to conceive and construct.

### Early Development of the Lewis Gun

Isaac Newton Lewis was born at New Salem, Pa., on 12 October 1858, and was taken west by his parents while he was still a child. He was appointed to the United States Military Academy from Kansas in 1880 when 21 years of age. He graduated eleventh in a class of 37 in 1884, and was commissioned a second lieutenant in the Coast Artillery. From 1894 to 1898 he was a member of the board on regulation of Coast Artillery fire in New York Harbor. In 1898 he became recorder of the Board of Ordnance and Fortification of Washington, D. C., and the following year made a study of weapons in Europe. This led to the reorganization and rearmament of our field artillery. He later invented a number of rangefinders and mechanical and electric instruments used for controlling artillery fire. From 1904 to 1911 he was instructor and director of the Coast Artillery School at Fortress Monroe, Va., and rose to the rank of lieutenant colonel.

In the early part of 1910 Lewis was approached by officials of the Automatic Arms Co., Buffalo, N. Y., in relation to assigning him substantial stock in the company if he would produce a machine gun based either on patents they already owned or on anything he cared to originate. He

agreed to the proposal and joined the firm. This business union resulted in his devising an air-cooled machine gun. In 1911 when the prototype reached a stage he felt was advanced enough to be exhibited, he brought a handmade model to Washington, D. C., and showed it to Maj. Gen. Leonard Wood, then Army Chief of Staff.

A short time later Lewis made four more guns patterned after the prototype he had shown the Army Chief of Staff. These weapons were also presented in person to the Secretary of War and other high ranking Army officers. He fired them many times before these dignitaries on the Fort Myer rifle range and, while in no ways was it an official test, many were distinctly impressed. The guns were chambered for the standard United States infantry rifle cartridge caliber .30/06.

After the College Park demonstration of aerial firing, the weapons were formally presented to the Board of Ordnance and Fortifications for consideration. When no definite decision was reached by the Board, Lewis became annoyed by what he called "a strictly negative attitude," and like practically all successful machine-gun inventors before him, he turned to Europe for a ready market and appreciation of his effort. He asked for leave of absence and in January 1913 sailed to Liège, Belgium, taking with him the four guns manufactured originally for testing by the United States Army.

These weapons were exhibited in various countries in Europe and resulted in the forma-



Lewis Machine Gun, Cal. .303, British.

tion in Liège of a company known as the "Armes Automatiques Lewis." While manufacture was originally centered at Liège, the whole program was later removed to the British Small Arms Co., of Birmingham, England, which at the time was the world's largest producer of small arms. Its officials, after having seen the demonstration of the Lewis gun and the enthusiasm of the generally conservative British officers, immediately offered to erect necessary buildings and take over large-scale fabrication of the weapons. The proposal was agreeable to the president and stockholders of the Automatic Arms Co., who did everything possible to help the English company to attain mass production of the lightweight automatic weapon.

Just as Maxim was the first to introduce the full automatic gun, so Lewis was the father of the lightweight automatic machine gun. Its weight and self-contained feed system holding 47 or 96 cartridges without use of links or belting made it possible for one man to represent the threat formerly offered by a three- or four-man machine-gun crew.

Without detracting from the skill Colonel Lewis showed in assembling one of the lightest and most reliable firing mechanisms ever devised, it must be remembered that the basic operating principles were already the property of the Automatic Arms Co. before Lewis became a member of the firm in late 1910. At the time of the firm's organization Samuel Neal McClean assigned to it all patent rights to his machine gun, better known as the McClean-Lissak automatic rifle. The producers of the weapon made several unsuccessful attempts to interest the Government in it but McClean, like many other inventors, could not leave well enough alone. Having the basic principles for a reliable automatic machine gun, he added various other gadgets until the assembly was so overburdened it lost practically all value as a compact and efficient military weapon.

Lewis deserves full credit for concentrating on the problem at hand and refining the original idea down to the barest necessities that would permit reliable operation, especially for lengthy bursts. The McClean gun was originally made to use both water and air cooling and to be tripod mounted. The gun could also be detached for

shoulder firing. This intended all-purpose weapon, as is usually the case, was too bulky for any specified purpose.

Lewis's own originality and inventive ability were displayed when he overcame obstacles in the difficult task of improvement. His solutions to the various problems were patented and assigned to the Automatic Arms Co. Among the most notable innovations were the cooling jacket, the clock-type spring and the rate-of-fire regulator. The finished weapon is rightfully called the Lewis gun, as the colonel redesigned, assembled, refined, and, in some features, created an automatic machine gun that soon became the most discussed instrument of war of its day.

After 25 years of active duty in the Coast Artillery, Lewis retired in order to be able to devote his entire time to further improvement and promotion of his gun. When he left, he held the rank of colonel.

## The Lewis Gun in World War I

A Serbian student named Princip, armed with an American-designed auto-loading pistol, on 28 June 1914, assassinated Archduke Francis Ferdinand of Austria to start what might well be called the First Great Machine Gun War. The automatic weapon had heretofore been employed only in minor conflicts, which had served to show its potentialities. In the 1914-18 war it was estimated that 92 percent of all casualties were inflicted with this highly lethal type of weapon.

After the declaration of war, the entire capacity of the Birmingham Small Arms Co. was turned over to the production of Lewis guns. It was estimated by the manufacturers that six Lewis guns could be made to one Maxim-Vickers. Lewis must be credited with knowing the value of being able to produce a weapon quickly in an emergency. To this end he worked diligently, simplifying all components that required skill above normal to fabricate.

The demand of the British and Belgians for Lewis guns was so great that their factories could not begin to keep pace with the use, and the Savage Arms Corp., of Utica, N. Y., was contracted with to make the weapons in the United States. The Savage Co. was organized in 1894 to manufacture a hammerless repeating high-power

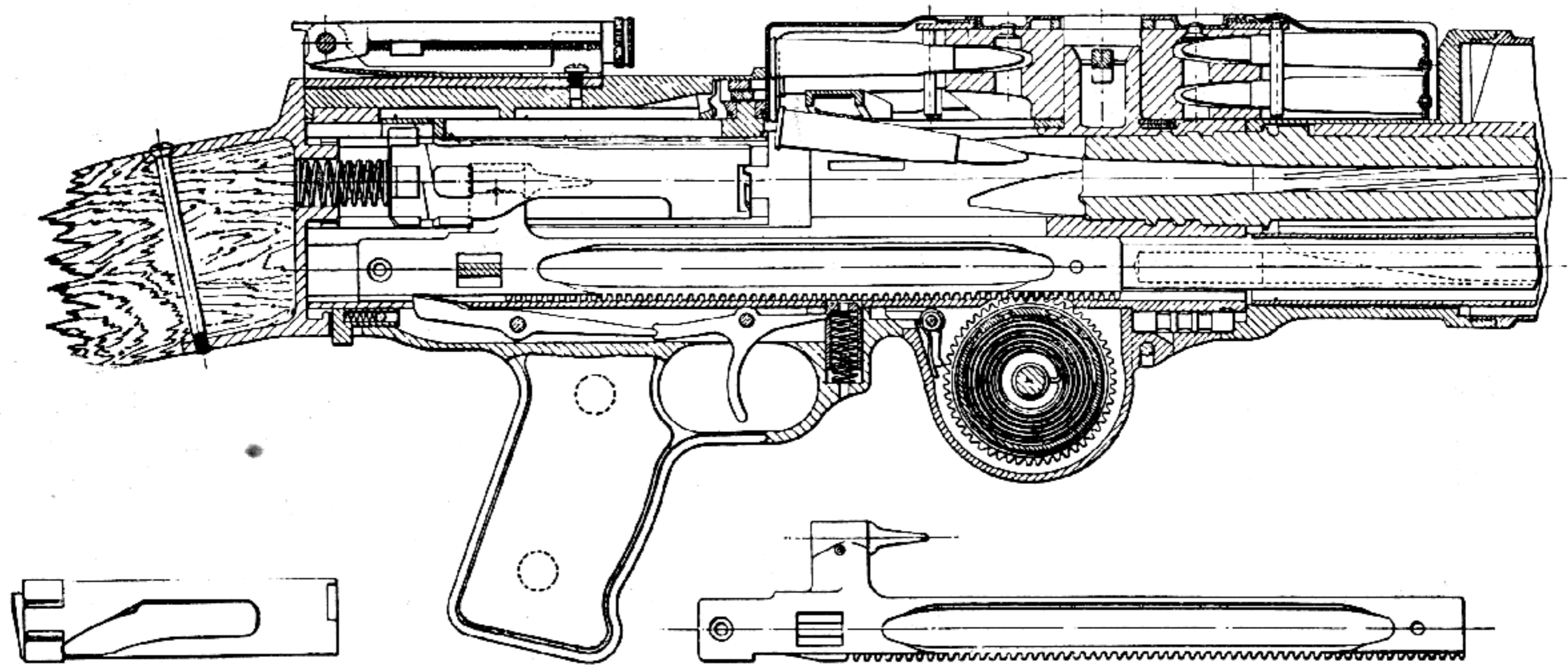

Section Drawing of Lewis Machine Gun.



rifle invented by Arthur Savage, a rifle designer far in advance of his time. By 1915 it was manufacturing, in addition to high-power rifles and ammunition, several .22 caliber rifles and an automatic pistol. In that year the corporation was merged with the Driggs-Seabury Ordnance Co., which held a number of basic patents on automatic arms.

In 2 years, this plant reached an output of 400 Lewis guns per week. After production was well under way and thousands had been delivered, the Lewis was adopted by the British as its first-line light machine gun. By that time all modifications were established and the weapon was made without any basic changes throughout the war.

The action of the weapon is quite simple. The locking of the breech depends upon the semi-circular movement of locking lugs at the rear of a rotating bolt, a principle first used by the Mannlicher straight-pull rifle and later by the Schmidt-Rubin. The striker is located on a post fixed at the rear of the gas piston and reciprocates in a helical slot cut in the bolt body.

When the piston is engaged by a sear, the bolt is held retracted in what is known as the cocked bolt position. Upon its release by pulling rearward on the trigger, the piston and bolt are driven forward by the stored energy of the clock-type return spring. The face of the bolt shoves the already indexed cartridge ahead of it into the chamber.

At this point the striker post is held securely in a recess at the rear of the bolt slot, with its left side bearing against an inner portion of the curved part of the slot. The locking lugs on the bolt engage with the guide grooves on the action body and prevent the bolt from being rotated until such time as the lugs are opposite their locking recesses. The continued forward motion of the striker post along the curved portion of its slot rotates the bolt body and lugs in their recesses, while the striker continues on along a straight path in the slot until its point smashes into the primer of the chambered cartridge.

The barrel, bolt, and piston are all securely locked until the bullet has passed an orifice in the barrel at which point gas is bled into a cylin-

der and force brought to bear on the head of the gas piston. By the time the action begins a rearward movement, the bullet has safely cleared the bore and the gas piston is then suddenly thrust back with great force.

This movement of the piston withdraws the striker and next the rotation of the bolt unlocks the action. The extractor holding to the base of the cartridge then withdraws it from the chamber and a pivoting ejector knocks the empty case to the ground. The continued action rearward of the gas piston actuates the circular drum type feeder, by means of a lug, causing it to rotate a fraction of a revolution and index the incoming round in position to be picked up by the bolt for chambering.

Some of the distinctive features of the weapon are the positive safeguard against firing until the bolt is securely locked, and the design of the return spring mechanism. The latter consists of a clock-type spring mounted inside a pinion which engages a rack on the under side of the gas piston. The entire spring mechanism is mounted in a casing on the pistol grip unit. The advantages of this simple and ingenious arrangement are many. The easily accessible spring is located out of the way of the reciprocating parts. It is practically impossible to get dirt and other foreign matter into its housing. The whole unit can be removed in a matter of seconds along with the trigger assembly, also located on the pistol grip. Any desired amount of tension can be attained without stopping the gun, as the clocklike spring can be wound externally until the desired result is reached. This permits to a limited degree the control of rate of fire. The trigger assembly also has a very simple design with very low inertia. An unusual feature is that no provision is made for firing single shots, the weapon being designed for full automatic only.

Another radical departure from conventional machine-gun design is the unique feed system. Although Maxim in 1889 successfully used such a cartridge container and the American Government likewise had tested the Carr gun with a similar flat rotating drum feed, it remained for Lewis to lighten it by practical design. By using a reasonable cartridge content of 47 for ground use and 96 for air, both weight and profile are held to a minimum. The Carr drum held as many

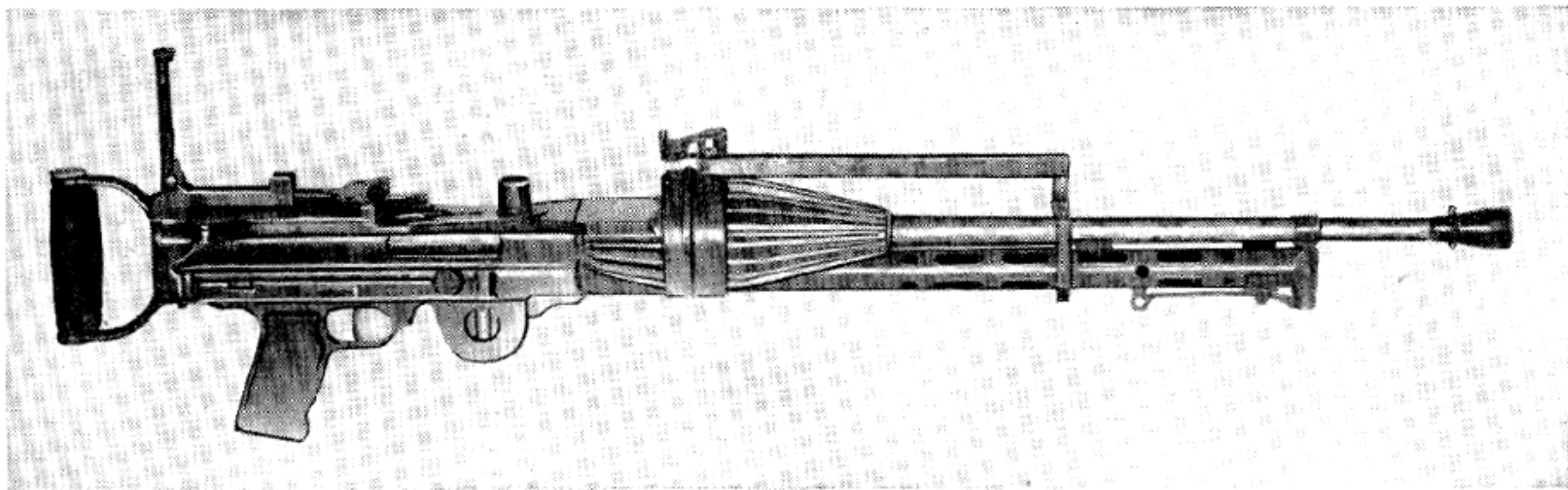

Lewis Aircraft Machine Gun, Model 1914, Cal. .303, British.

as 305 rounds, which made the gun too clumsy and breech heavy to be handled without tripod.

The standard Lewis drum holds 47 rounds in two circular rows and is fastened horizontally by a clip to a top post located to the rear in line with the chamber. During operation the drum is rotated counterclockwise by a ratchet pawl working off the reciprocating piston body. It can be exchanged in a few seconds, in fact so fast that only a slight pause in a long burst is apparent, since belt or links are not required and firing is generally interrupted anyway after 50 shots. This is one of the weapon's many desirable features for military service.

The British made a slight change in the gun by using a closer-fitting metal tube of aluminum in place of the conventional radiator in order to lighten the weapon for aircraft use. This model was employed in the first aerial firing of a machine gun in England. (A similar exhibition, made by Belgian pilots with the Lewis gun at the Brasschaet Military Aeronautics Grounds in Belgium in December 1912, was the first official demonstration of its kind in Europe.) The British plane, a Graham White biplane, was piloted by Marcus D. Manton, a civilian, and the demonstration took place above the Bisley airfield on 27 November 1913. A machine gunner, from an improvised platform located between the pilot and the landing gear, fired repeated bursts with the Lewis machine gun at targets on the ground and despite his precarious position scored a substantial number of hits.

Although the above test was made a full 10 months before the start of World War I, the only British aircraft equipped with machine guns at

the outbreak of hostilities were two seaplanes of the Royal Navy Air Service, and even then they were not permanently mounted. All planes sent to France by the Royal Flying Corps were unarmed when the first British pilots crossed the channel on 13 August 1914. Aircraft at the time were constructed far too lightly to carry very heavy armament. The planes were regarded as of value only for scouting and observation work, without being suitable for inflicting damage on the enemy. Aerial warfare was as yet unknown, although sometimes a pilot took with him a rifle, revolver or a few hand grenades, with which to answer the derisive and obscene gestures usually tendered at such an encounter.

German observers, besides carrying standard military bolt-action rifles, sometimes found it convenient to be provided with a self-loading arm. The most popular one was the highly advanced gas-operated Mondragon, the invention of a Mexican officer, Manuel Mondragon, patented on 8 August 1904, and adopted by his country's army in 1911. It was manufactured in Switzerland by the Schweizerische Industriell Gesellschaft at Neuhausen on the German border. At the beginning of World War I, all production was diverted to Germany. Large numbers of specially designed magazines holding 30 cartridges each were made up and issued to the observers. They remained in use only until the mounting of flexible full automatic guns.

On 22 August 1914, two young British pilots, Lts. L. A. Strange and Penn Gaskell, helped to make aviation history. These two officers, acting on their own initiative, placed a Lewis gun aboard their aircraft and took off looking for the

enemy. In a very short time, at an altitude of 5,000 feet, a German Albatross was seen approaching. Using every known means of coaxing their aircraft along, the aviators could not get closer than an estimated 1,000 yards. Seeing that they were being outdistanced, Gaskell took aim with his Lewis gun and fired an entire drum at the German plane. The pilot and observer of the German aircraft flew on unharmed and perhaps never knew they were the party of the second part in another of aviation's historical events. For this was the first record of a machine gun being fired at an enemy in the air.

After returning to their home field the officers recorded their initial attempt in a full report of the incident. They stated that, although they did not inflict any visible damage to the enemy, there was every reason to believe that machine guns could easily replace the rifles, bricks, pistols, etc., then carried by practically all pilots on both sides.

Strange and Gaskell were in for a rude awakening if they thought progress would come from their dramatic effort. The report resulted in an order by the High Command prohibiting the use of machine guns in aircraft. Such a practice would only cause the pilot to seek out other enemy planes to try out this newfangled idea, thereby diverting his attention from watching troop movements and spotting artillery fire. The latter, it was pointed out, was the primary duty of the pilot and observer and the excuse for the aircraft's existence in warfare. For a brief time this directive stopped such unorthodox practices as far as the British were concerned. Such an attitude is surprising since the British originally became interested in the Lewis gun as a superior aircraft weapon, and England was one of the first European countries to fire a machine gun from the air. It is perhaps logical to assume that the British did not desire to be the first to introduce a type of warfare that could easily have unpredictable consequences.

In any case the order did not stay in effect too long. Before it was rescinded, British aviators had brought down a few German aircraft by plane-to-plane rifle and pistol fire and, in one instance, by a shotgun loaded with buckshot. Only a few days later a machine gun was used by Lts. C. W. Wilson and C. E. C. Rabagliati to

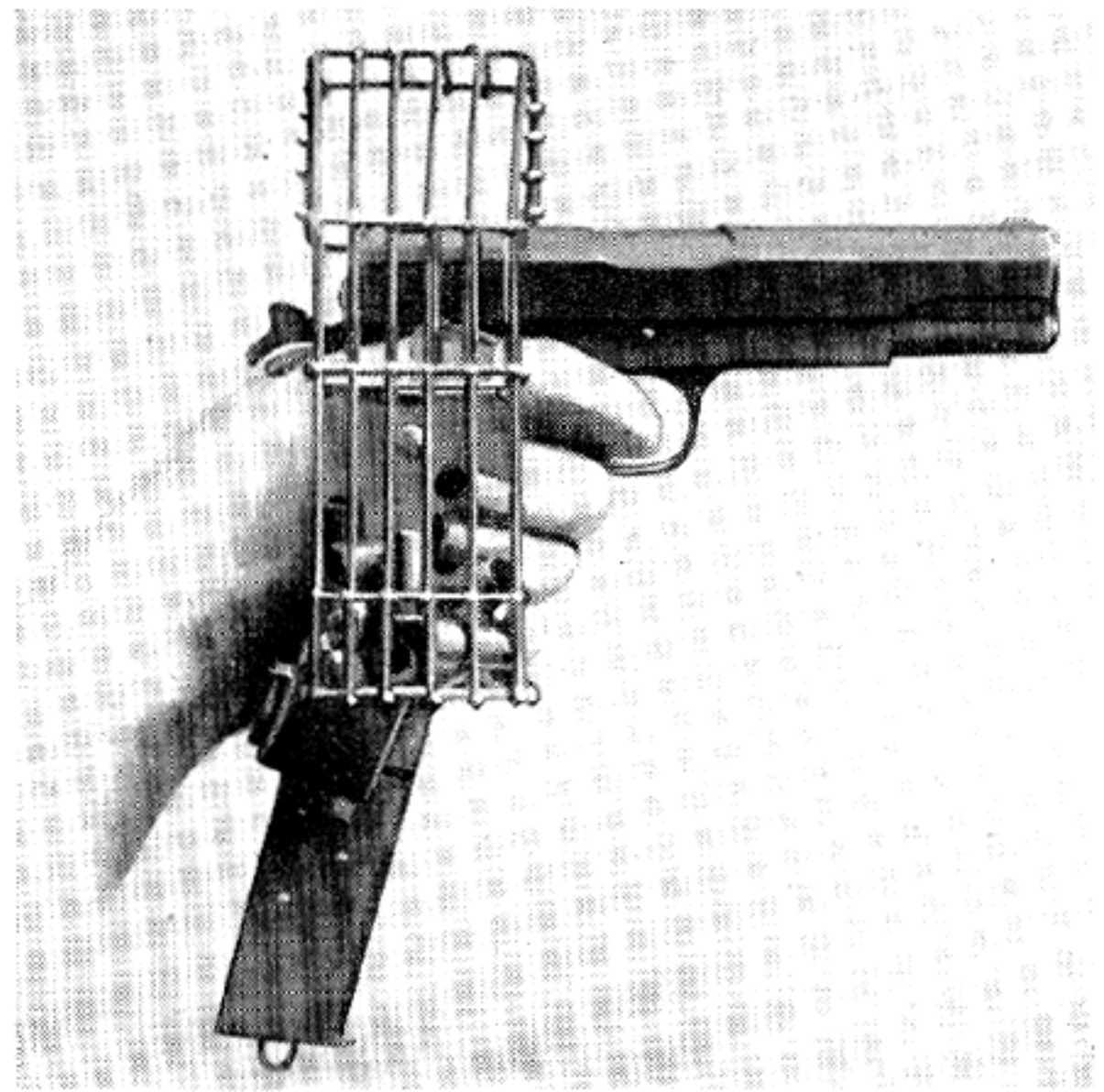

A Cartridge Catcher, Designed to Keep Spent Cartridges from Striking the Airman or his Ship when Firing at the Enemy.

shoot down a German plane at Le Quesnoy behind the British lines. By the end of September 1914 a few British aircraft began to arrive at French flying fields each armed with a single Lewis free gun.

The weapons were mounted to fire only backwards, downwards, and upwards; forward firing was prohibited by the whirling propeller of the tractor-type plane. Because of this factor the pusher plane was given high priority in development for fighting purposes, although the tractor in every other respect was much to be preferred. Soon afterwards Lewis guns were mounted on brackets outside of the propeller arc of tractor planes. The weapon was fired by a mechanical triggering device operated by either the pilot or the observer.

From the start the Lewis gun was considered a superior weapon for use in the air. Dirt and foreign material were precluded from getting in the operating parts, and its extreme lightness made it an ideal free gun. Issuance to the air force of a 96-shot drum in place of the 47-shot one furnished a much needed ammunition reserve and gave British pilots the assurance of the best possible aircraft weapon.

Shortly after the larger drum made its appearance during the Somme offensive of 1916, the

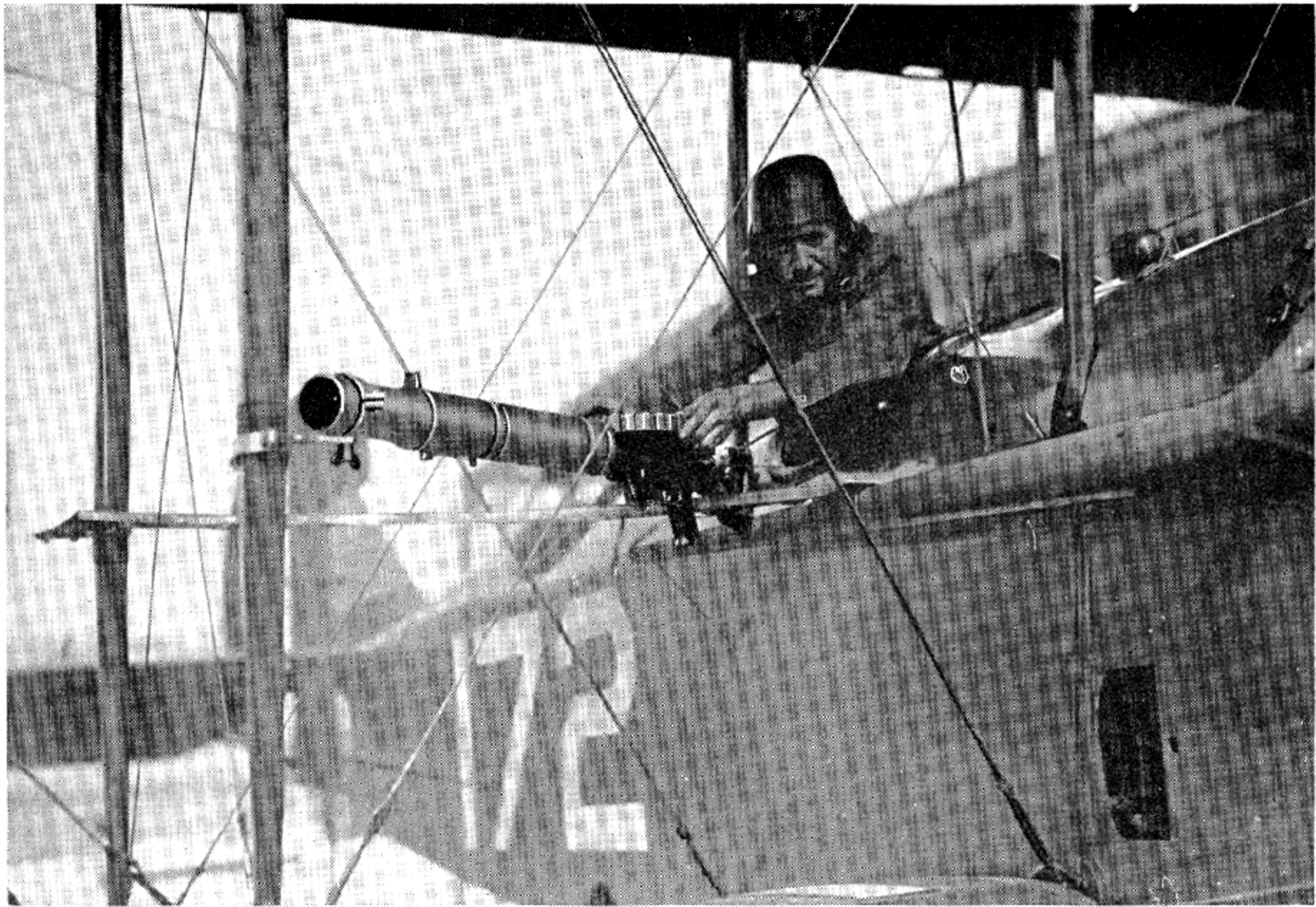

Forward-Firing Lewis Machine Gun Mounted on a Pivoting Bracket so the Magazines Can Be Changed.

stock was removed and spade grips were substituted. This made a better balanced gun and the change was met with enthusiasm by the English flyers. The drum-fed gun, when used on a free mount, could be maneuvered suddenly at any chosen angle without fear that the belt of cartridges would swing loose, as in the case of a belt-fed device.

Lewis, encouraged by the success of his weapon, informed the United States Navy, through Commander J. P. Jackson, on 23 May 1916, that he intended to design an automatic machine gun somewhat similar to the one in current use. The finished product, however, would weigh only half as much and have the general appearance and silhouette of the United States infantry rifle. It would be clip fed and fire full automatic. He pointed out that such an automatic rifle would be invaluable not only for aircraft armament, but also for quick assaults as executed by Marine landing parties, since it

gave a small body of men the fire power of many their number. Lewis further stated that, when completed by the use of a device to reduce the kick or recoil, it could be fired full automatic from the shoulder of a comparatively strong man. It seemed also to be his plan to permit the new gun to be fired single shot, as he described it as being as accurate when fired singly as our conventional army rifle. It is not known whether Lewis ever undertook such a weapon. Certainly all evidence seems to indicate he did not.

The great powers fighting Germany used the Lewis gun with such satisfactory results that their leaders, both civilian and military, seemed pressed for words to praise adequately its reliability under battle conditions. Even the Germans complimented its deadly performance by nicknaming it the "Belgian Rattlesnake," because of Belgian tactics in waiting concealed with the Lewis and firing without warning other than the sudden hail of bullets.

## The Controversy over the Lewis Gun in America

It is a matter of record that Great Britain, Belgium, and France bestowed many honors on Lewis, together with financial backing in producing his weapon. At the same time a dispute arose between Lewis and this country's Ordnance Department on the merits of the gun. Regardless of who was at fault, no one but the future enemy benefited from it and an appalling state of unpreparedness for machine-gun warfare resulted. While the colonel complained bitterly that his weapon was being considered with a "strictly negative attitude," written reports of the office of the Army's Chief of Ordnance indicate that it was just as upset over inability to get the Automatic Arms Co. to submit one or more weapons for testing. It wished to give the guns fair field and endurance trials in accordance with Army regulations.

A memorandum from the Chief of Ordnance at the time is given verbatim in order to show that a conflict of opinion existed. It should be remembered that well before the report was written, 40,000 Lewis guns had already been battle-tested both on the ground and in the air and acclaimed by their users the "greatest single contribution to the Allied cause." The report of General Crozier, Army Chief of Ordnance, dated 17 June 1916, is as follows:

"1. The Lewis Machine Gun was first offered to the Board of Ordnance and Fortification by a letter dated 2 May 1912, from the Automatic Arms Company, inviting attention to an air-cooled, gas-operated, automatic machine gun, and asking for a field test. Mr. R. M. Calfee, attorney, and Mr. Huberty, machinist of the company, appeared before the Board and exhibited the model of the gun. Arrangements were made for the Board to witness a firing test of the gun at Fort Myer, on May 3. . . .

"2. *The Board, on June 6, 1912*, resumed consideration of the letter dated May 2, 1912, from the Automatic Arms Company, presenting an automatic machine gun and asking for a field test. Members of the Board witnessed a firing exhibition of the gun at Fort Myer, on May 6.

"3. The Board recommended that the Auto-

matic Arms Company be informed that 'the kind of test proposed by them has limitations which the Board does not care to accept, for the reason that the field test proposed usually follows tests made to determine the mechanical suitability of a weapon; but if they will submit a gun for such tests as seem suitable to determine its fitness for the service, it will be subjected to the tests usual for guns of this class under the Ordnance Department, including a field test. Their representatives will be permitted to be present during the tests, and the company will be furnished with a copy of the report.'

"4. *The Board of Ordnance and Fortification*, at a meeting on July 2, 1912, considered a letter dated July 1, 1912, from the Automatic Arms Company, requesting reconsideration of the action in regard to a field test of their gun. The Board recommended that 'the Automatic Arms Company be informed that after careful consideration of their letter the Board is of the opinion that the usual procedure should be followed, namely, the gun must be submitted to a technical test by the Ordnance Department. During this test, the representatives of the company will be permitted to be present and, preliminary to the test, to give such an exhibition of the performance of the gun as they may see fit, in the presence of the representatives of the Ordnance Department charged with the technical examination of the gun. After this demonstration is completed the gun will then be submitted to such tests as the Ordnance Department may deem necessary. Ammunition for such exhibition and tests will be furnished by the Government.

" 'The parties representing the gun may have the privilege of declining to subject it to any portions of the test which may be proposed to which they may not wish to have it subjected at the time, but in respecting their wishes in this regard the report of the test will, of course, state the facts.

" 'In the course of the complete test, the gun will have the kind of field test which they desire, and copies of all reports in regard to the test will be furnished the company.

" 'It is also recommended that the company be informed that the Board has no objection to the gun being fired at Monterey, before the



British Troops with Lewis Guns Resting Between Attacks.

School of Musketry, or at College Park, by the Signal Corps, but such tests will have no weight whatever until the technical tests have demonstrated the structural efficiency of the gun.'

"5. *The Board of Ordnance and Fortification*, at a meeting on March 6, 1913, considered a letter dated March 5, 1913, from the Automatic Arms Company, presenting for consideration with a view to its adoption as a type for use in service, their .30-caliber, air-cooled gun, and requesting that the gun be given a thorough competitive test by a board of officers from the several arms of the service engaged in the manufacture and tactical use of machine guns. . . .

"It is recommended that the Board of Officers be appointed as requested by the Automatic Arms Company, the Board to carry out a competitive test of all models of machine guns submitted. . . . The Board should also make such tests as will determine the value of the guns for use for war purposes from airships, and the suitability of guns and mounts for use for attacking airships from the ground. . . .'

"6. In the above record, no mention is made of the fact that the gun submitted by the Automatic Arms Company is the 'Lewis Machine

Gun.' However, in view of the fact that Mr. Calfee represented the Lewis gun at the test, there can be no question but that the gun referred to in the correspondence with the Automatic Arms Company is the Lewis Machine Gun.

"7. The Board convened for the competitive test of automatic machine guns submitted to it, met at the Springfield Armory on September 15, 1913. The Lewis gun submitted to this Board and tested by it, was one of two model guns manufactured in England (serial numbers 39,153 and 39,930). It is presumed that the guns were manufactured by the Birmingham Small Arms Company, of Birmingham, England, in view of the fact that on July 18, 1913, Mr. Calfee, as Secretary of the Automatic Arms Company, acknowledged receipt of rifle tools and gages shipped to Colonel I. N. Lewis in care of the Birmingham Small Arms Company.

"8. In the 1913 test, seven different makes of automatic machine guns were considered and tried out. The Board consisted of two officers of the Infantry, one of the Cavalry, one of the Field Artillery, and an Ordnance officer. The arsenal test narrowed the competition down to the present service machine gun—the automatic machine

rifle, caliber .30, model of 1909, and the Vickers Rifle Caliber Gun, Light Model. It was not desired to adopt a gun on simply an arsenal test, and three additional Vickers guns and four automatic rifles, caliber .30, model of 1909, were submitted to the Board for an extensive field test, which was held at Texas City and Leon Springs, Texas. As a result of this test, the Board recommended the adoption of the Vickers Rifle Caliber Gun, Light Model, and the Vickers Tripod, Model J.

"9. The new gun differs in one essential from the present gun in that it is water-cooled instead of air-cooled. It is slightly heavier when filled with water than the present gun, the weights being about 29 pounds and 36 pounds, respectively. The cost of the new gun is about twice that of the present gun, unless a tripod be added to the latter, in which case it would be about one and one-half times as great.

"10. This test, in so far as the Lewis gun is concerned, indicated that the mechanism had not been developed to a satisfactory stage, having, in the endurance test, 206 jams and malfunctions, 35 broken parts, 15 parts not broken but requiring replacement, as against respectively 23, 0 and 0 for the Vickers gun, and 59, 7 and 0 for the [Benét-Mercié] automatic machine rifle, caliber .30, model of 1909.

"11. The Board concluded, after a careful consideration of the data collected, together with the knowledge of the suitability of the various designs of machine guns gained by observation during the tests, that 'the Lewis Automatic Machine Rifle, as at present designed, is not considered superior to the service automatic machine rifle, on account of failure to maintain continuous fire, the large number of parts that were broken, and the large number of jams, many of the latter being reduced only after much difficulty and considerable time.'

"12. The Lewis gun was therefore not given the field test, in view of the fact that the Board recommended a competitive test of this nature for the Vickers gun and the Automatic Machine Rifle only.

"13. On the conclusion of the field tests at Texas City and Leon Springs, the Board expressed the opinion that 'when the present service machine rifle (automatic rifle, model of



A Device for the Lewis Gun Allowing It to be Fired from the Shoulder with Ease.

1909) was originally tested some seven years ago, it was then without doubt the best type of machine gun in existence, but during the past seven years the Vickers Company have developed a gun which not only overcomes all the serious defects inherent to the service type of Maxim gun (model of 1904), but compares very favorably in weight with the automatic machine rifle, caliber .30, model of 1909.

"The service machine rifles furnished the Board for test were well made and finished, and only a small number of parts were either broken or replaced during the test, indicating that the large number of jams and stoppages of fire which occurred, particularly during the field firing, were not due to either defective material or workmanship.'

"14. Effort has been made from time to time,

within the past year and a half, to obtain a Lewis Machine Gun for further test. These efforts have not been successful until recently, when satisfactory arrangements were made with the Savage Arms Company, of Utica, New York, the American manufacturers of the Lewis Machine Gun, to submit a gun to tests similar to those held in the competitive trial of machine guns, in 1913. The Board testing this gun was composed of one officer of Cavalry, one officer of Infantry, and one officer of the Ordnance Department. . . .

"15. In order to further test this weapon, arrangements have been made for the purchase of three Lewis Machine Guns, chambered for British ammunition, which it is intended to mount on aeroplanes on the Texas border and in Mexico. These weapons have been procured with a view to determining whether this particular type of gun has peculiar and special adaptability for aeroplane work."

Very few things in American military history have produced as much controversy and as many

contradictory opinions from people in high office as did the failure to procure the Lewis gun for the services. A few quotations are given to show the position held by defenders of the Lewis gun against the Army's claim that it was unserviceable when tested by it.

Sidney Brooks, a British publicist and correspondent, wrote in the *Philadelphia Public Ledger* on 14 February 1917:

"... But there has recently been an even more striking instance of the discrepancy between British experience on the one hand and the views of American officialdom on the other. I refer to the controversy over the Lewis machine gun. Here again I speak simply as a layman and not at all as an expert. But I do know, and every Englishman knows, that the following statements are facts:

"*First.* That the present war is so largely a war of machine guns—I remember Mr. Lloyd George stating that more than ninety percent of the casualties were due to them alone—that whereas at its beginning we had only two to each thousand men, we now have thirty-two.



Flexible Lewis Machine Gun Mounted on a Scarff Ring.



"Second. That of all the machine guns in use in the Allied armies the Lewis gun is by far the most popular and the most effective.

"Third. That some 4,000 officers and about 400,000 men use it exclusively, and that in the British, French, Italian and Russian armies there are at this moment nearly 40,000 in actual and daily operation.

"Fourth. That virtually all our aeroplanes are armed with Lewis guns, and that of the seven Zeppelins we have accounted for six were brought down by the Lewis gun.

"Fifth. That both on Salisbury Plain and at the machine-gun school in France most of the instruction is done with the Lewis gun.

"Sixth. That it owes its pre-eminence partly to its mobility, partly to its light weight, partly to its capability of being used in any position and partly to the simplicity of its working; and that after fully two years of daily experience in the battlefield it stands higher than ever in the judgment of the British armies.

"Yet this is the gun the American Government virtually turned down. I have heard all sorts of explanation of its action, mainly of a personal or political character. But I have never yet heard it asserted that the Lewis machine gun was rejected by the authorities at Washington on its merits or that they have any better gun or any that is as good up their sleeve.

"Incidents such as these have a somewhat more than depressing effect on an Englishman, who has seen at first hand the terrible effects of a state of unpreparedness and who has no dearer wish than that the United States may be wise in time."

Maj. Gen. Leonard Wood, commander of the Department of the East, declared, "In my private opinion, the Lewis Machine Gun is the best light-type gun yet developed for troops in the field." He added that he favored "having . . . a reserve supply of 25,000 machine guns as in the end one in ten men will carry a 26-lb. machine gun as he now carries a rifle."

Will Irwin, war correspondent for the *Saturday Evening Post*, declared:

"Modern warfare had developed a real necessity for machine guns both light and heavy, but as far as I saw, the Lewis Gun far outnumbered

all other machine guns of the light type among the Allied armies.

"In the last engagement I saw in the recent Somme offensive, whole detachments were going into the trenches with every man carrying a Lewis gun as one would carry an ordinary rifle."

Charles Edward Russell, an American sociologist, wrote in the *Cleveland Press*, in October 1916:

"Nothing the whole war had brought out has been of so much real use to the British Army as the Lewis machine gun. It has done wonders. It has almost counteracted the British aversion to tactics. . . .

"The merits of the Lewis gun are long past any discussion in British army circles after so many months of testing. It has also added a much-needed redeeming quality to the fame of American products in general.

"One odd little fact is that they nearly all believe the American army to be equipped with the Lewis guns. 'But then you have your Lewises.' British army officers would say to me when the United States was trying to get an army to the Mexican border. 'Rum country, rum country,' they would say when I told them we hadn't."

And from the *Army and Navy Register* of 30 December 1916 is quoted:

"It appears to be conceded that between sixty millions and seventy millions have been spent for these guns by the Entente Powers, and they are used in all the French and English armies for the first line trenches. Heavier, more durable and water-jacketed machine guns being preferred for the second line. Are all the war authorities of France, England and Russia at fault? If not, why is not the Lewis gun good for the United States?"

There must have been a logical reason for the failure of the Lewis gun to meet the Army's requirements. The most probable explanation was brought to light years later. If valid, it serves as an outstanding example of how certain minute dimensions, which are only slightly out of adjustment, can ruin the performance of a weapon.

When Lewis presented his gun to the Board of Ordnance and Fortification in 1913, it must

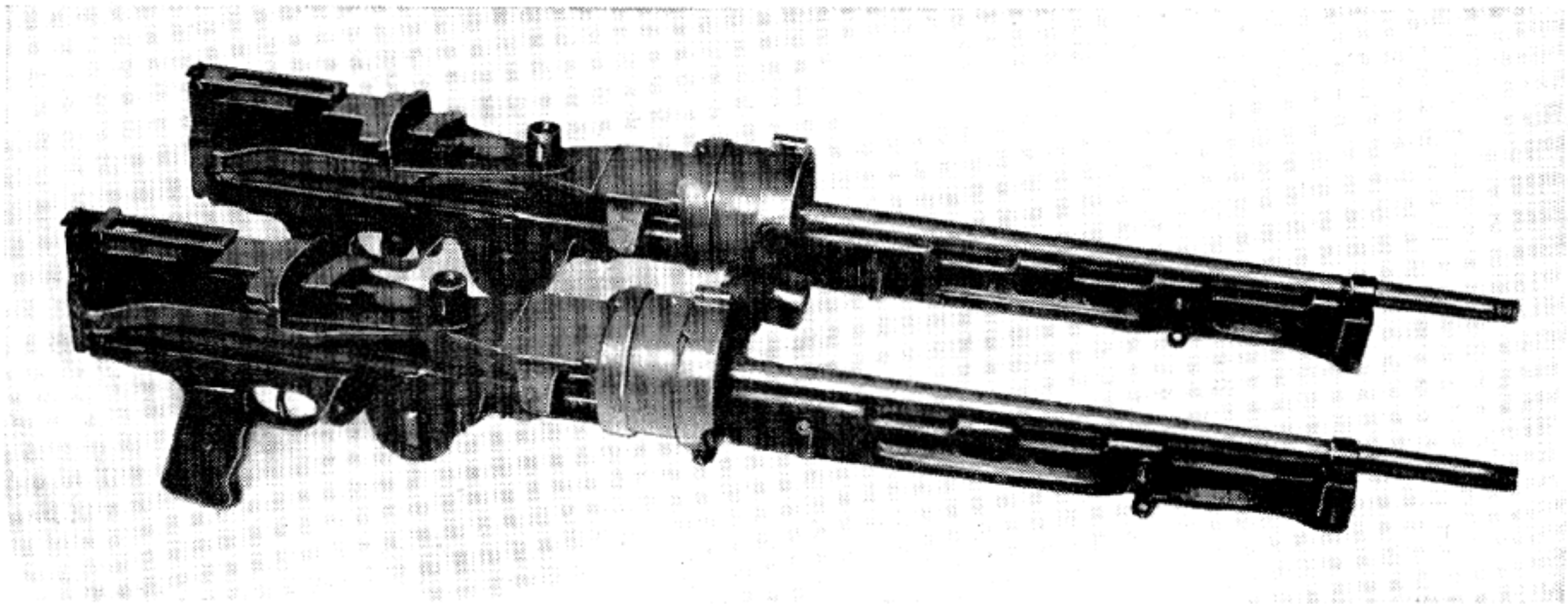

Lewis Aircraft Machine Gun, Model 1914, Cal. .303, Twin-Mounted, French.

be remembered that it represented a handmade product in its earliest prototype stage. Constant experimentation was daily being carried on in an attempt to perfect the mechanism. Construction of the gas-operated gun required the attachment of the barrel and receiver so that the orifices in the barrel are at an exact place underneath it. The weapon could then be mass produced and the components quickly assembled. This precluded the conventional means of adjusting head space by screwing in or out on the barrel, as head space was permanently fixed with respect to the barrel and receiver. The only remaining adaptable factors were the angle of the locking cam on the bolt and the straight portion cut in this piece that allowed the piston to recoil a certain amount before unlocking action commenced.

This very critical dimension in first firing attempts has always been determined by trial and error. About the only help engineering can give is to furnish calculations for a safe starting point. The first Lewis guns submitted to the Board were still in highly experimental stage and the gas piston had been designed for the highest rate of fire possible. After the bullet passed the orifice and gas pressure was brought to bear on the piston, the latter had a free movement of 0.875 inches. The spiral cam of the bolt was then engaged by the lug on the gas piston, causing it to rotate and unlock.

The distance of the free movement was such as to give the first weapons an unusually high

rate of fire, since unlocking took place while a residual pressure too high for practical use remained in the barrel. The free travel of only 0.875 inches hastened unlocking and caused the bolt to withdraw its support from the base of the cartridge. This slight easing back of the bolt had the same effect as too much head space, and many resulting malfunctions thus occurred. Too, the completed unlocking was done under such pressures that when the empty cartridge cases did not stick or rupture, the bolt was carried rearward with such force from the added blow-back as to overstrain the other recoiling components. This resulted in a parts breakage that was all out of proportion.

Impatient at the delay of the Army Board, Lewis sailed for Europe taking his four guns with him. During his demonstrations abroad, British and Belgian ordnance officers pointed out that his rate of fire was far above what was considered ideal for battle use. In order to reduce the rate, the straight portion of the cam slot was redesigned until it had a free travel or "dwell" of 1.0625 inches. The additional free movement permitted the chamber pressure to drop before the bolt started to relax behind the base of the cartridge. It also established an average rate of fire of around 600 shots per minute when used in conjunction with a fixed gas orifice of .130, a dimension that produced a satisfactory rate of fire and the smoothest performance.

As England was at war and the most trivial

thing concerning machine-gun construction was considered top secret, it is easy to understand why information on this redesigned part was not made available. In fact it is possible that the change may have been made by engineers of the Birmingham Small Arms Co. when the manufacturing drawings were converted from our measurements to the metric system and that Colonel Lewis did not even know of it. When the Savage Arms Co. contracted to make the weapons here in the United States, this change from the original drawings was noted for the first four guns.

It was felt at first that the weapon would not handle the United States infantry rifle cartridge because of its higher velocity, chamber pressure, etc. However, the theory was exploded when the Savage Arms Co. produced its version of the gun. It was basically the same as the unsuccessful earlier models with the exception of the added dwell before the bolt unlocked. The Lewis guns made by the Savage Co. stood the test.

### Later Development and Production of the Lewis Gun

General use of the Lewis gun in the air led to the construction of many accessories that made it even more efficient. It was determined by actual battle use that the wind blew the cartridge case deflector and canvas bag back and that sharp maneuvers of the plane closed up the bag, causing stoppages in the ejection chute. As a result, a satisfactory sheet metal deflector and receptacle was designed, which was later replaced by an even better device made of die-cast aluminum.

For aircraft mounting it was found convenient to cut into the gear case above the pin to allow sufficient clearance from the receiver locking pin. Removal of the casing without unscrewing the receiver from its locking piece was thus facilitated. To permit the fitting of an adequate sight, the gas chamber was modified so that the front sight base could be mounted on top with a dovetail fit and retaining screw.

The most urgent demand from Lewis gunner pilots was for a simple indicator to show the number of rounds, if any, left in the drum at the

end of a burst or engagement. Many devices were tried, the most successful one being designed and made by the Veeder Manufacturing Co., Hartford, Conn. The counter was mounted on top of the magazine plate and operated by a small gear, the teeth of which engaged in the notches of a latch lock located in the spacer ring. The indicator was set at zero when the drum was filled; after firing commenced, the revolution of the magazine's rim operated the indicator through its gearing. When only 19 rounds were left in the drum, a luminous figure "one" appeared and stayed until only 9 rounds remained. The number then disappeared and a red marker came into view to indicate to the gunner that the drum should be changed at the first opportunity.

This reliable counter was very ruggedly constructed and was considered the most useful accessory on the Lewis gun. Its acceptance by airmen was of such an enthusiastic nature that one of the indicators was sent in each carton containing six spare drums. The early style drums that were not designed to work with the indicator were soon properly altered.

On 28 May 1918, the Office of the Chief of Ordnance, United States Army, received the following cable from General Pershing: "Request information as to what experimental work has been done towards speeding up Lewis gun in the United States. French are at present doing considerable experimenting along this line; methods pursued being first to increase duration of gas pressure acting on piston by fitting muzzle attachment, which is approximately equivalent to increasing length of barrel by increasing spring tension, adding more length to barrel, and by adding buffer spring in rear end of racks to soften blow against butt tang. Suggest this matter be taken up with Savage Arms Company and reports forwarded to this office."

The Office of the Chief of Ordnance made an inquiry to ascertain the new French rate of fire and how much was desired by the American Expeditionary Force, and received the following reply:

"The rate of fire of Lewis guns should be as high as possible consistent with reliable performance of the gun. The French at present have produced a reliable speed of about 850

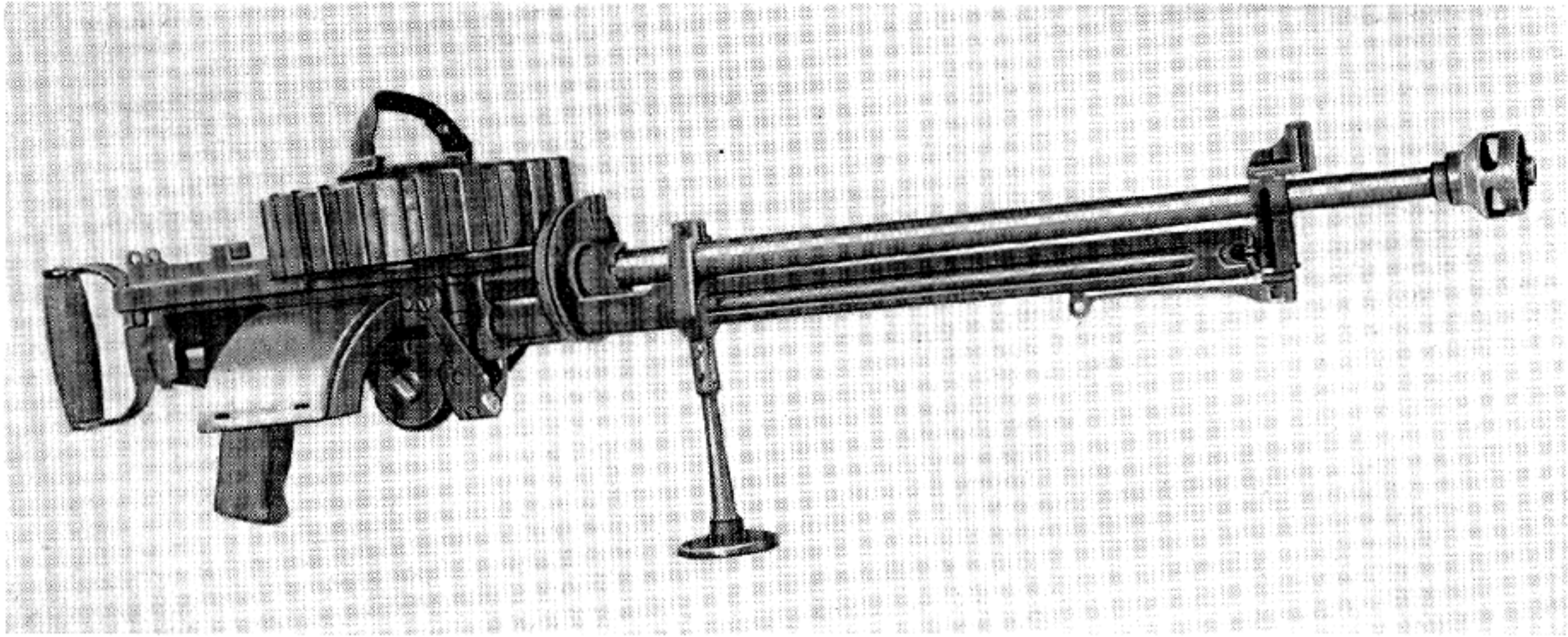

Lewis Aircraft Machine Gun, Model 1918, Cal. .30, with 97-Round Magazine and Muzzle Booster.

shots per minute. A speed of over a thousand per minute has been attained but performance of gun has not been satisfactory."

No attempts had been made in this country to speed up the gun, as it had just been adjusted to work satisfactorily at its normal speed. But upon General Pershing's suggestion an order was placed with the Savage Arms Co. for experimental work of this nature. It was recommended that a rate of fire of 900 rounds a minute would be acceptable. The company made up a special spade grip, with two buffers having heavy springs to act against the end of the feed operating stud and rack. A hardened buffer plug was added at the end of this part. And to increase the force of recoil of the gas piston greatly the orifice was opened up from .130 to .190. The latter change was found upon test to be far too great for smooth performance. It resulted only in having the extractor tear through the rim of the empty case which was still under terrific gas pressure. The company officials were unable to fire a single full drum of ammunition without some serious malfunction or parts breakage.

Without expending further effort, the Savage Arms Co. asked permission to give up the experiments as an impossibility. The Ordnance Department was not so easily discouraged. It ordered Savage to reduce the gas orifice from .190 to .150 and put the Hazelton attachment on the muzzle. The device trapped the gas momentarily after the bullet had cleared the muzzle. A high

residual pressure was held in the bore to add greater operating power and recoil to the piston stroke. This modified assembly increased rate of fire greatly but it resulted in wearing off the stop, rebound and feed pawls, after the firing of a few magazines. Innumerable failures to feed resulted.

The fault was finally overcome by continued firing and experimental heat treatment of the affected parts until the breakage stopped. Thereafter one Lewis gun was fired as much as 8,000 rounds, when the rate of fire was 800 to 850, without what was considered excessive wear. As many as 1,000 shots a minute were obtained by restricting the orifice in the muzzle attachment, but a high percentage of broken parts again resulted when the orifice was thus choked. It was decided that a maximum of 800 to 850 rounds per minute could be fired without affecting the reliability of the gun's action. The most serious difficulty encountered at the latter rate of fire was the tendency of the powder gas to blow back into the operating parts and clog or foul up the recoiling mechanism. It was remedied by drilling three holes, 0.0625 inch in diameter, through the cylinder and casing a little ahead of the rear-most position of the piston head on recoil.

All modifications were officially approved and 5,000 muzzle boosters were ordered from the Savage Arms Co. to be attached overseas to Lewis guns already in action. Before this was done, it was found more desirable to complete the

speeded-up gun at the factory, since it had been apparent that the ramps on the receiver needed a milled-out cut. This could be done in a satisfactory manner only in a well-equipped manufacturing plant. After the modification was done, only a limited number of the improved guns were actually delivered.

The Savage Arms Co., having been a large and efficient armament factory for half a century before the war, was considered well equipped to furnish all the standard-type Lewis guns needed for United States military service and no contracts were made with other plants. The original order for the ground gun was placed during the latter months of 1917. By May 1918 more than 16,000 had been produced and delivered. Over 10,000 of these were of the aircraft type; the other 6,000 were delivered to the Navy for Marine Corps use. By August 1918, 25,000 of the aircraft type alone had been made and by Armistice Day, 34,000 of this model had been delivered.

The Savage Arms Co. must be credited from the very start with keeping production ahead of requirements and overseas supply was held up only because of shipping difficulties. There were comparatively few insoluble manufacturing problems in the production of the weapon. This can be rightfully attributed to the foresight of Colonel Lewis in emphasizing simplicity of manufacture.

Because the bolt was held in a cocked position, the Lewis gun could not be synchronized to fire through the propeller arc as could front-seared machine guns. This limited its method of mounting, although many novel ways of firing outside the propeller arc were tried, a number of which were successful.

The main use of the Lewis was as a free gun. At first it was necessary to modify the ground weapon to mount in a plane, but an aircraft model was soon issued that could be easily adapted to any kind of mounting desired. It was first installed on biplanes over the observer's seat by means of a tourelle. Often two guns were placed together in a yoke and the torque action of the yoke combined with a knuckle arrangement permitted a perpendicular action of the mounting. Aiming in all directions was thus made possible. Both guns could be fired simul-

taneously by means of a Bowden connection. A recoil reinforcer was sometimes added to the mounts to make the operating action more positive and to increase its rate of fire to a limited extent.

When certain altitudes were reached, freezing up of guns was a common complaint. In this situation various methods were employed to heat the operating parts. An electric heater, obtaining its power from the motor's generator, was usually attached under the feed cover.

The front sight was originally made of bronze but combat conditions proved the metal too soft to be satisfactory, as the set screw could not hold the sight in place. The easily burred material allowed the base to loosen. Steel sights had to be made to replace the original ones.

A simple set of magazine rim and spacer pin gages for use in the field by ordnance men was developed. Their intended purpose was to give a quick means of checking accurately the critical dimensions of these two parts. On the standard gun firing at 600 rounds a minute, it was thought a recoil check or muzzle brake, used over the muzzle, would result in smoother performance by eliminating the kick. However, when a test was made with such a brake designed by the French, so much carbon and fouling was found in the mechanism that the idea was dropped.

### Use of the Lewis Gun by the Navy

One of the most peculiar things about the Lewis controversy is that the Navy did not concur in the belief that the weapon was unreliable. The Navy, in its effort to supply the Marine Corps with an adequate light machine gun, had the Marines test the weapon. Complete satisfaction with its performance was expressed.

In September 1917, an officer from the Aviation Ordnance Section, Lieutenant Commander Stone, who had been sent abroad to collect data and specimens of foreign aircraft ordnance, returned to the Bureau with voluminous information and a quantity of English and French aircraft armament, among which was a British Lewis gun.

The Navy ordered the Savage Arms Co. to modify the standard Lewis gun to conform to the sample submitted so that it would be iden-

tical with those used by Great Britain and France for both aviation and ground use. These instructions were complied with and large quantities were delivered to the Navy by 1 January 1918. From that date the Navy never suffered for lack of machine guns. Since there was an ample supply for training the Marines at home and outfitting them before going overseas, they were the only American troops to arrive in France armed with Lewis guns. Other units were given whatever the French and English high command could conveniently spare, the Chauchat being offered in most cases.

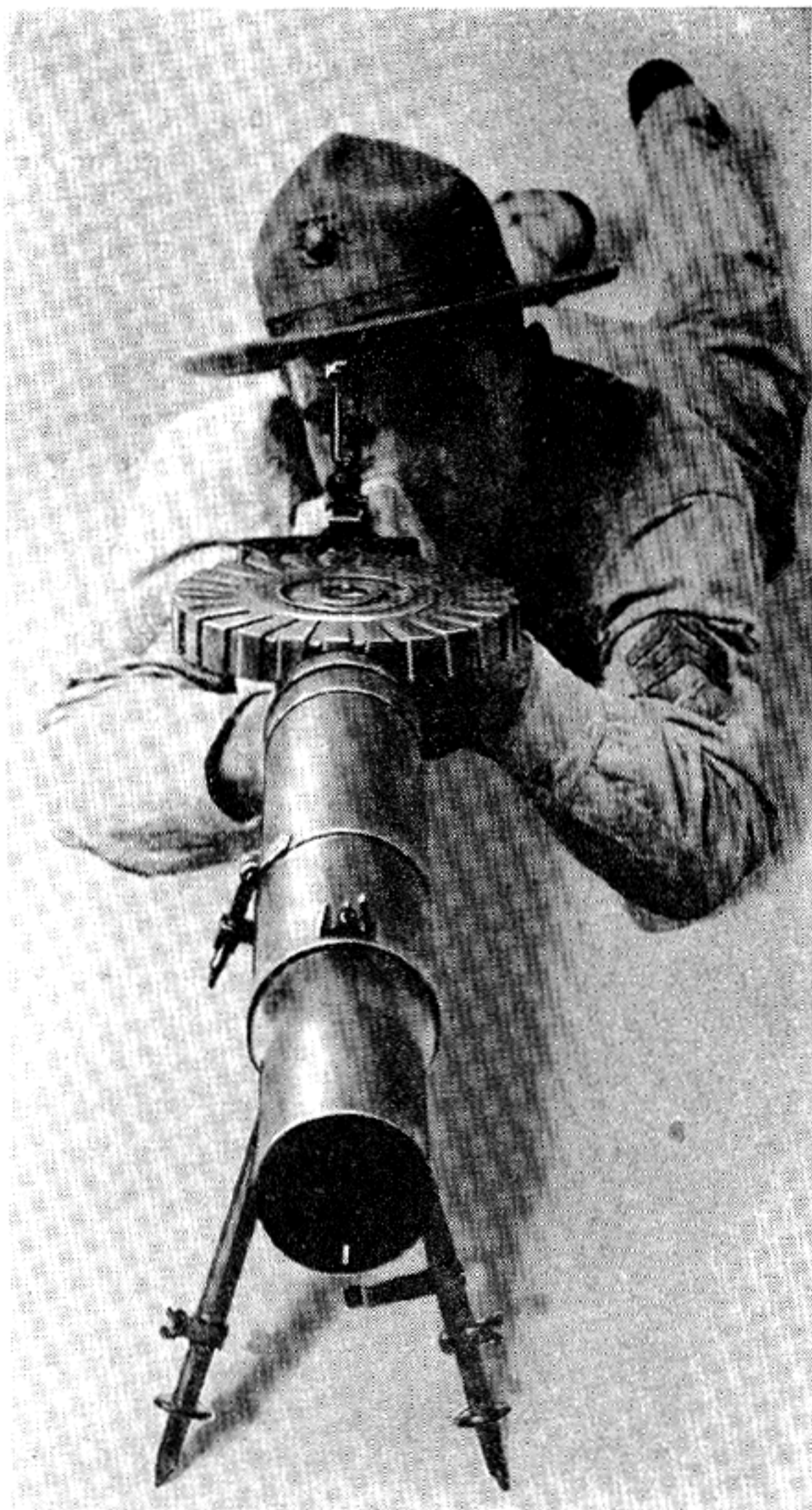

U. S. Marine Training with a Lewis Gun, 1917.

The Navy was long an interested party in machine-gun development. It had adopted the Colt '95 model while other branches of the service still clung doggedly to the hand-cranked Gatling. It was realized early that the Lewis gun would best suit Naval needs in World War I for both land and air use. Having previously been satisfied with its performance, the Navy ordered enough weapons, in advance of the war, to give it an adequate supply for training purposes. Once this need was met, an ever-increasing flow from the factory kept ahead of the demand.

Such foresight was due to a large extent to the efforts of the newly formed Naval Aviation Ordnance Section, created after 6 April 1917, as a subsidiary of the Gun Mount and Small Arm Section. On 1 October 1917, the unit became officially known as the Aviation Ordnance Section. The section had under its cognizance responsibility for obtaining machine guns, sights, mounts, ammunition, bombs, and pyrotechnics, along with any other large caliber guns as long as they were intended for use in aircraft. After war was declared, Lieutenant Commander Stone, an officer from this section, was sent to the front, as mentioned above, to gather samples of the best weapons with which to fight an aerial war.

While the new section's complement was very small and its quarters cramped, it certainly proved competent in every respect. The reason for its existence was best stated in its letter of organization:

"To plan and develop by years of experience, the needs of Naval aviation and base its requirements under conditions of war, and never upon those of peace. The principal function of this organization is to harness authority and responsibility so that they can never be separated . . . so that a designer cannot design a gun, then throw credit or blame onto the producer, or later escape the final issue and responsibility therefor. One man is to be responsible for each bit of material or development from its start to completion . . . its issue, its service performance, and later its overhaul or repair. Given this responsibility, he is to be clothed with the requisite authority over all its details."

One of the unit's first acts was to place contracts for the Lewis gun. It had expressed dissatisfaction with the heavy water- and air-cooled

automatic weapons that had been previously tested. The Savage Arms Co., already tooled up for the caliber .303 Lewis gun for the British, had been approached as early as 5 February 1917 (before the section was set up) on the production of sufficient caliber .30/06 guns for Marine Corps testing. Through the hard labor of an already overworked factory at the urgent insistence of the Navy, this was done and by 5 April 1917, one day before declaration of war, successful acceptance tests were run by both Navy and Marines. On 25 April 1917, the first contract with the Savage Arms Co. was given for 3,500 guns. A second followed on 22 June 1917, for 350 more; a third on 6 April 1918, for 2,500; and a final one on 13 June 1918, involving 3,000 additional guns.

A total of 9,350 guns with spare barrels and accessories was delivered in time for actual service before Armistice Day. All reports concerning use of the Lewis gun under combat conditions stated it was indeed most reliable, and could be fired and serviced by a single gunner. Although jams and stoppages were infrequent, little difficulty was experienced in clearing them when they did occur.

One of the most inexplicable acts of World War I, and one that curtailed American combat use of the Lewis guns, happened when the Marine divisions arrived in France, fully equipped with the weapon. They were soon attached to Army units and under the command of the latter, they were ordered to turn their Lewis models in. Greatly inferior Chauchats were issued as replacements.

### The Routing of the Zeppelin Menace

If the Lewis gun had not fired another shot during World War I, its part in breaking up the Zeppelin raids over England would have more than compensated the Allies for the cost and effort expended on its production. The German aircraft was named for its inventor, Count Ferdinand von Zeppelin. He was born on 8 July 1838 in Constance, Baden, Germany, and after over 30 years of service in the German Army retired in 1890 with the rank of general. He announced his intention of devoting the remainder of his life to the study of aeronautics and the

building of lighter-than-air machines. His decision was influenced partially by his term as military attaché in the United States during the Civil War, at which time he made his first balloon ascension with Professor Lowe to reconnoiter the Confederate forces.

Unable to find financial backing at first, Count von Zeppelin sold his family estate and all other valuables in order to raise the \$150,000 needed to conduct his first experiment. Within 2 years the inventor had his first airship, using a 16-horsepower Daimler motor for power, ready for flight. After a short trial in the air, it was destroyed by an accident, as were also Zeppelins II, III, and IV. The indomitable count was financially ruined after so many failures and very low in morale, when the German Government agreed to finance the next airship, to be known as the *Deutschland*. Through tireless effort on the part of the inventor and his assistants, a craft was produced capable of carrying passengers with comparative safety. In 1910 it made such a flight for a distance of 300 miles. This feat stirred the imagination of the German people and over \$1,500,000 poured in for the purpose of more experimentation.

The *Deutschland* was also wrecked by a sudden and violent wind as it attempted to land, but the government now had implicit faith in the Zeppelins. Further experiments showed that greater engine power was needed, and one of the dirigibles powered with 75-horsepower engines successfully rode out a storm for 3 days with gales at times of 80 miles per hour. Between 1900 and 1914 the Zeppelin Corp. constructed over 115 airships of the rigid type.

Up to this point Germany had practically a monopoly on dirigibles as other European countries had dropped them in favor of heavier-than-air models. The German military command realized that it had at its disposal what might constitute a powerful weapon, as the Zeppelins could stay aloft hours longer than conventional airplanes. They could also reach a greater altitude than any plane. Their speed, especially with a favorable wind, was far in excess of that of standard military aircraft. Best of all, the designers reasoned that the huge area and unlimited carrying power of the dirigibles furnished a platform upon which to mount weapons. This would

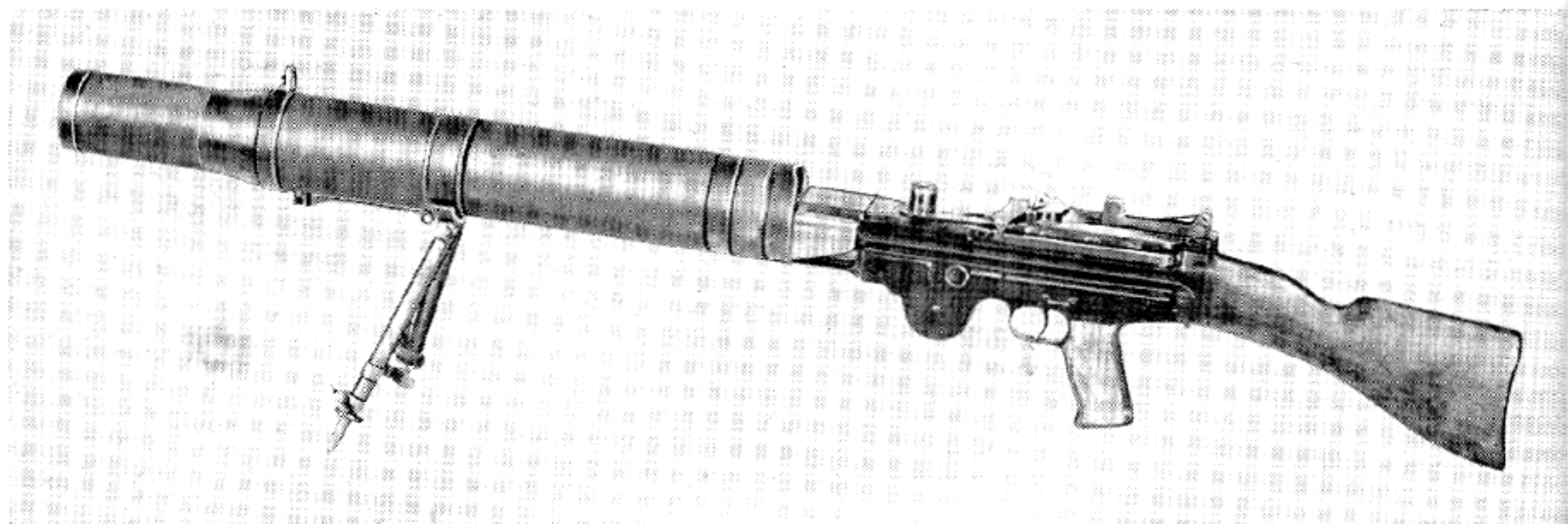

Lewis Machine Gun, Model 1917, Cal. .30.

allow them to fight off anything that dared approach the flying arsenal.

As one very enthusiastic supporter explained, "For an airplane to engage a Zeppelin with the limited armament the plane could carry would be like a canoe attacking a battleship." Since the Zeppelin could reach prohibitive altitudes and needed no weight limitation on the number of machine guns and even cannon that could be mounted, the arguments of its supporters seemed to be too one-sided even to be logically disputed.

Although Germany had built up a mighty Zeppelin fleet, she most certainly had not done so at the expense of her heavier-than-air machines. Her military leaders knew, however, that every other major power in Europe had an air force of conventional-type planes equal and, in some instances superior to, her own. They earnestly believed that the Zeppelin was Germany's ace weapon and that, when "the day" arrived, the mighty ships would cruise unmolested to and from strategic targets deep in enemy territory.

This belief was not a German monopoly, as the French and British begrudgingly accepted it in every respect. Such a generally conceded point of superiority gave the Germans a psychological weapon in itself. From the outbreak of hostilities, they released propaganda building up horror in the Allied countries that Zeppelin raids and the destruction of unprotected cities were certain to follow.

As a result of constant predictions of impending doom by journalists and military experts, the general public was left in a state of near hys-

teria at the mere thought of the inevitable Zeppelin raids to come.

It was fortunate that the Germans also believed in the invincibility of their "Air Armada." Feeling so secure, they disregarded observations supplied by their secret operatives that British pilots had been firing in their Lewis guns newly designed ammunition recently patented by George Thomas Buckham of London.

The first Zeppelin assault on England took place at Great Yarmouth on 19 January 1915. It resulted in minor damage and was considered merely a token raid, a dress rehearsal for the main event. An English newspaper made the statement: "What made the people indignant was not so much the ruthlessness of the Germans, but the failure of their own naval and military to offer any protection . . . or even to harass them when they came."

It took years in time and millions in money to build up the Zeppelin myth, but it was shattered quickly when British airmen found the fatal weakness of the huge airships. The following report on bringing down a Zeppelin, the L-53, by Lieutenant Culley, of the Royal Air Force, illustrates a typical encounter:

"The naval units informed me at 8:30 a. m. there was a Zeppelin approaching from NE at an estimated 15,000 feet altitude. I got my 'Camel' into the air at 8:41 a. m., and with the sun at my back, I climbed upwards. When first sighted, the airship was broadside but evidently having sighted me it had turned end on and had climbed to 19,000 feet. As we approached, the Camel sat tail down unable to climb another



inch of altitude. At this close point the airship started to pass slowly overhead. I pressed the trigger of my two Lewis guns mounted above the wing and after firing a long burst observed the bullets strike and flash as they hit the metal in the under belly structure of the huge ship.

"A propeller on an engine on the port side was seen to stop and as nothing else seemed to happen I dived my plane, followed a moment later by an explosion as the whole airship exploded in flames. One of the crew succeeded in jumping with a parachute and was saved."

Lieutenant Culley could have mentioned the fact that he was using the new Buckham incendiary bullets in his guns.

Destruction of the Zeppelins with the deadly combination of the Lewis gun and incendiary bullets gave English and French morale its greatest boost of the war. The weapon with its highly inflammable ammunition literally shot the dirigibles out of the air. Of the 12 Zeppelins destroyed in attacks over London, the Lewis is officially credited with shooting down 10 of them.

The Buckham incendiary bullet consisted of a flat-nosed cupro-nickel jacket, containing in its nose an 8-grain charge of yellow phosphorus. The charge was held in place by a serrated plug of lead backed up by a larger base plug of the same material. A small hole through the jacket, located near the junction of the two plugs, was filled with a low fusible alloy. The latter melted as the bullet passed through the bore and permitted the phosphorus to ignite.

The yellow phosphorus, when brought into contact with the highly flammable hydrogen gas-filled envelopes of the great airships, resulted in immediate fire and explosions. The metal framework inside the dirigibles increased the hazard as the flat-nosed bullets, upon striking a support member, had a tendency to rupture and scatter the flaming mixture over a wide area.

Thus in a comparatively few months the death knell was sounded for the great German menace, the Zeppelin. The people of Great Britain and France, being relieved of the horror of mass annihilation by the successful employment of the Lewis gun, looked upon it with more admiration than is usually accorded a common weapon of war. They felt their governments could not give too much official praise and credit to it.



Colonel I. N. Lewis, U. S. A. (Retired).

## Conclusion

It would be possible to write an entire book on why the United States seemed to ignore the Lewis weapon when machine guns were so desperately needed. Regardless of who was right or wrong, or for what particular motive, other than intense patriotism, the fact remains that Colonel Lewis sent to the Secretary of War certified checks for over a million dollars, representing his portion of the royalties on Lewis guns bought by the United States, during and following hostilities. Lewis's notation was "I will not accept one cent of royalty for a single Lewis gun purchased by the government of my country."

Even the acceptance of the colonel's first check covering his royalties on guns sold to the War Department involved him in a characteristic dispute with General Crozier, the Army's Chief of Ordnance. The check, which was for \$10,889.17, was sent for deposit to the credit of the United States Government on 16 February 1917. Mr.

W. G. McAdoo, the Secretary of the Treasury, asked the War Department for an opinion on the propriety of accepting the donation, especially since the Savage Arms Co., which paid the royalties to Lewis, was still competing for Government orders. General Crozier prepared a memorandum saying that acceptance of the check would not embarrass the Department in dealing with the Savage Co. Then he continued with some adverse comments on Lewis's claims that he had never sought pecuniary recompense from the United States Government for his inventions, and that he had never had any assistance or encouragement from the Ordnance Department.

Colonel Lewis was advised by the Secretary of War, Mr. Baker, of the general's comments and his reply follows:

"No. 1 RUSSELL TERRACE, MONTCLAIR, N. J.,  
May 12, 1917.

"THE HONORABLE THE SECRETARY OF WAR,  
Washington, D. C.

"MY DEAR MR. SECRETARY: Your letter of April 29th, with its inclosed memorandum from the Chief of Ordnance, has been received and very carefully considered.

"I do care to have the money represented by the check sent you in my letter of February 16th, 1917, deposited in the Treasury of the United

States simply on the ground stated in my original letter, without any understanding that you are now examining or undertaking to determine any controverted question as to the breach of relations between me and the War Department or any branch or division of it, and I now have the honor to request again that you so accept and deposit it.

"My letter of February 16th, 1917, was sent you solely for the reasons stated therein and for no other.

"I can see no possible embarrassment to the War Department nor to the Ordnance Department in the acceptance of my check. It is possible, however, that your acceptance and deposit of the check may embarrass the present Chief of Ordnance personally.

"The memorandum from the Chief of Ordnance to which you invited my attention is so widely at variance with what I know from personal knowledge to be the facts in the case that I can not fairly consider any of the questions raised by Gen. Crozier therein without controversy, and I understand it to be your wish and direction that there be no further controversy.

"In the present very grave national emergency I am directly instrumental in supplying, delivering, and putting on the actual firing lines against the fighting enemies of my country more machine guns each week than the present Chief of Ordnance has supplied for the use of our

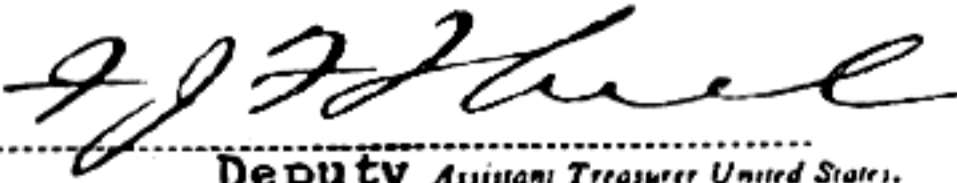
TO BE RETAINED BY THE DEPOSITOR.	No. - 6802	<b>Treasury Department,</b>	\$10,889.17
	DUPLICATE <sub>G</sub>	OFFICE OF THE TREASURER OF THE UNITED STATES.	
	Washington, D. C.,		June 15 1917
	<p>I certify that Isaac N Lewis Colonel USA Rtd (By letter dated June 12 1917--Chf of Pub Moneys Dvsn) has this day DEPOSITED TO THE CREDIT OF THE UNITED STATES Ten thousand eight hundred eighty-nine 17/100 Dollars, on account of Donation to the Government</p>		
	for which I have signed duplicate receipts.		 Deputy Assistant Treasurer United States.
	<small>TREASURER'S OFFICE—FORM 5259. CASHIER.—Ed. 10,000 9619—F. C., May 10-16.</small>		15 A 41pa

Royalties Returned by Colonel Lewis.

own Army of defense during the whole of the 14 years that he has been in office. I have done, and am doing, this without one penny of assistance and without one word of encouragement or acknowledgment from anyone connected with the Ordnance Department and in spite of the long-continued and active opposition of that department.

"I am therefore content to now rest the matter with you simply as a personal appeal for justice.

"Very respectfully, your obedient servant,

"I. N. LEWIS,

*Colonel, United States Army (retired)"*

General Crozier found no objection to accepting the colonel's check and it was deposited in the United States Treasury in the name of Isaac N. Lewis, on account of "Donation to the Government." No such difficulties accompanied later refunds made by Colonel Lewis.

As might be expected, the Lewis gun did not go out of existence following World War I. It saw much use in the hands of the United States Marines in the Nicaragua campaign, and it was the favorite infantry arm for many smaller countries long after the major powers sought to replace it with a more efficient weapon. The Norwegians made it under license in a 6.5-mm caliber and it is the only light machine gun definitely known to be used by their army. Japan

produced it under the designation Models 1929 and 1932.

In fact, the Lewis gun, although it had undergone practically no change for three decades, was still on hand by the thousands in this country at the beginning of World War II, a fact that was most fortunate for the Allied cause. When the Germans practically disarmed the British army in the debacle at Dunkirk, 80,000 Lewis guns were purchased by England from the United States and other friendly powers. And when the Japs struck at our fleet on 7 December 1941, the first pictures rushed back from Hawaii showed the old reliable Lewis being used as a makeshift antiaircraft gun.

After the arms situation in Britain got back to normal, the thousands of Lewis guns were given to the home guard and to small units in the fleet. It is recorded that on more than one occasion the outmoded guns brought down planes that made the fatal mistake of coming within range of the gunners, who in many cases were veterans of the first World War and no strangers to the Lewis gun.

### Models of the Lewis Gun

The various models of the Lewis gun and the countries using them were too numerous to list in the text. As a handy reference, they are tabulated herewith:

Country	Designation	Bore
<i>(1) Ground</i>		
U. S. Test	Model 1911, (one, handmade)	.30/06
U. S. Test	Model 1912, (4 manufactured)	.30/06
Belgium	Model 1913, Liège (A few were made in Belgium during this year, before contract was transferred to Birmingham Small Arms.)	.303
Belgium	Model 1914, B. S. A. (This was called "the Belgian Rattlesnake" by the Germans.)	.303
Belgium	Mark VII, B. S. A.	.303
Belgium	Mark VIII, B. S. A.	.303
Great Britain	Mark I (Model 1915, B. S. A.) <sup>1</sup>	.303
Great Britain	Model 1915 (Savage) <sup>1</sup>	.303
Great Britain	M1916 (Savage) <sup>1</sup>	.303

<sup>1</sup> Between the world wars all these were modified to Mark I except those sold as surplus.

Country	Designation	Bore
Great Britain	Model 1916 (Mk VII, B. S. A.) <sup>1</sup>	.303
Portugal	Model 1917	.303
U. S. Army	Model 1916	.303
U. S. Army	Model 1917	.30/06
U. S. Navy	Mark VI (also Mk VI Mod 1)	.30/06
Honduras	Ex-U. S. M1917	.30/06
Nicaragua	Ex-U. S. M1917	.30/06
Commercial	Model 1919	.303
Holland	Model 1920	6.5 mm
France	Model 1922	8 mm
Russia	Same as British Mk I	7.62 mm
Japan	Model 1932	7.7 mm
<i>(2) Aircraft</i>		
Great Britain	Mk VII Model 1916	.303
Great Britain	Mk II	.303
Great Britain	Mk III	.303
France	Model 1916 (Darne)	.303
U. S. A. F.	Model 1917	.30/06
U. S. A. F.	Model 1918	.30/06
U. S. A. F.	Model 1919	.30/06
U. S. Navy	Mark X	.30/06
Italy	Same as British Mk II	.30 & .303
Russia	Same as British Mk II	7.62 mm
Japan	Model 1929	7.7 mm
Japan	Model 1932	7.7 mm

<sup>1</sup> Between the world wars all these were modified to Mark I except those sold as surplus.

## VICKERS AIRCRAFT MACHINE GUN

In the early months of 1916 the British Royal Air Force first attempted to adapt the Vickers-Maxim rifle caliber machine gun to aircraft use. Heretofore planes had in most instances served as flying platforms upon which weapons were mounted to be aimed and maneuvered by the operator. The propeller served as an effective barrier against mounting guns permanently to shoot straight forward. If the latter could be accomplished, it would change the craft into a gun-laying device, as had been done previously by Roland Garros, the great French air fighter. The plane's flight attitude would then govern at all times the bullet trajectory of the forward-firing weapons. The R. A. F. was very conscious of this unused firing area and tried in many ways to put it to use.

By actual test in late 1914 it was found that only 2 percent of the shots fired by a machine gun through the arc of an air screw would hit the blade and that it then required quite a number of caliber .303 bullets to weaken the propeller to the point of being unserviceable. This, the authorities thought, justified the mounting of one Vickers machine gun to fire straight ahead for use in an emergency only. As a result, every pilot upon engagement with the enemy naturally considered it an emergency situation and used the weapon upon all occasions. The arrangement turned out to be a faulty makeshift, for in more instances than deemed necessary a gunner pilot had started home after a victorious fight only to have his propeller disintegrate from bullet holes of his own making. Crash landings resulted, with numerous fatalities or capture by the enemy of valuable ace fighters.

Since the Vickers was belt fed and therefore of little use as a free gun, its part in the early stages of aerial warfare of 1914 was indeed limited. Its streamlining though had been undertaken from the start, many things having been

done to cut down its weight and make it more efficient for air use. An example was the replacement of the water jacket with a skeletonized tube and cap to allow cooling by air circulation. This device not only supported the barrel adequately but reduced the weapon's weight to 30 pounds. The handle block was replaced by a flat plate and the front and rear of the covers were milled out to permit various triggering installations. One of the most radical changes was the redesign of the left-hand cartridge box and feed to allow the mounting of two guns adjacent to each other. As another refinement a retracting handle was added which allowed adjustment of the return spring's tension from the rear end of the gun.

But the device that made the Vickers machine gun a superb aircraft weapon was the invention of a reliable synchronizing gear. This brilliant achievement came from the efforts of George Constantinesco, a Rumanian engineer living in London, who had specialized in devices for transmitting power by impulse.

Actually the Rumanian was only one of many attempting to solve this problem. There came into being at about the same time the Scarff-Dibovsky synchronizing gear, developed by Warrant Officer Frederick William Scarff, R. A. A. S., who had made aviation history by inventing the Scarff gunners' ring, and Lt. Victor V. Dibovsky, of the Imperial Russian Navy. It was a mechanical gear consisting of cogs and teeth operating off the propeller shaft. Another such contrivance was invented by Maj. A. V. Bettington, commanding officer of the Aeroplane Repair Section No. 1, Aircraft Depot. This was known as the "Arsiad" synchronizer, the name arising from the initials of the major's command. It also was an arrangement of gears, cams, and levers attached from the propeller shaft to the machine-gun trigger. Still another was the Vickers trigger



Vickers Aircraft Machine Gun, Model 1915, Equipped for Synchronizing. Mount is for Purposes of Photographing Only.

actuator, designed by George H. Challenger, an engineer of the Vickers establishment. The number of approaches from various angles shows the great importance placed upon a solution to this vital problem.

All three of these synchronizing gears depended on mechanical means for firing the gun at the requisite instant. The main operating principle was that a cam driven by the engine and working through a series of push rods and levers tripped the trigger at intervals and was so regulated that the revolving propeller was clear of the line of fire. The mechanism was set in action with a trigger controlled by the pilot. Although effective, these devices were crude and

mechanically unreliable, since adjustment of the rods had to be extremely accurate and continued firing might jar the original setting.

The Constantinesco synchronizer, however, did not employ such features in its design. It was based on one of the inventor's earlier patents concerning the operation of a hydraulic rock drill. The impulses transmitted through a column of nonfreezing oil under pressure in a pipeline furnished the energy to depress the trigger at intervals regulated by the position of the blades. A cam on the propeller shaft engaged a lug on an oil pump at the instant the trailing edge of the propeller was clear of the bore of the gun and continued to hold the trigger actua-

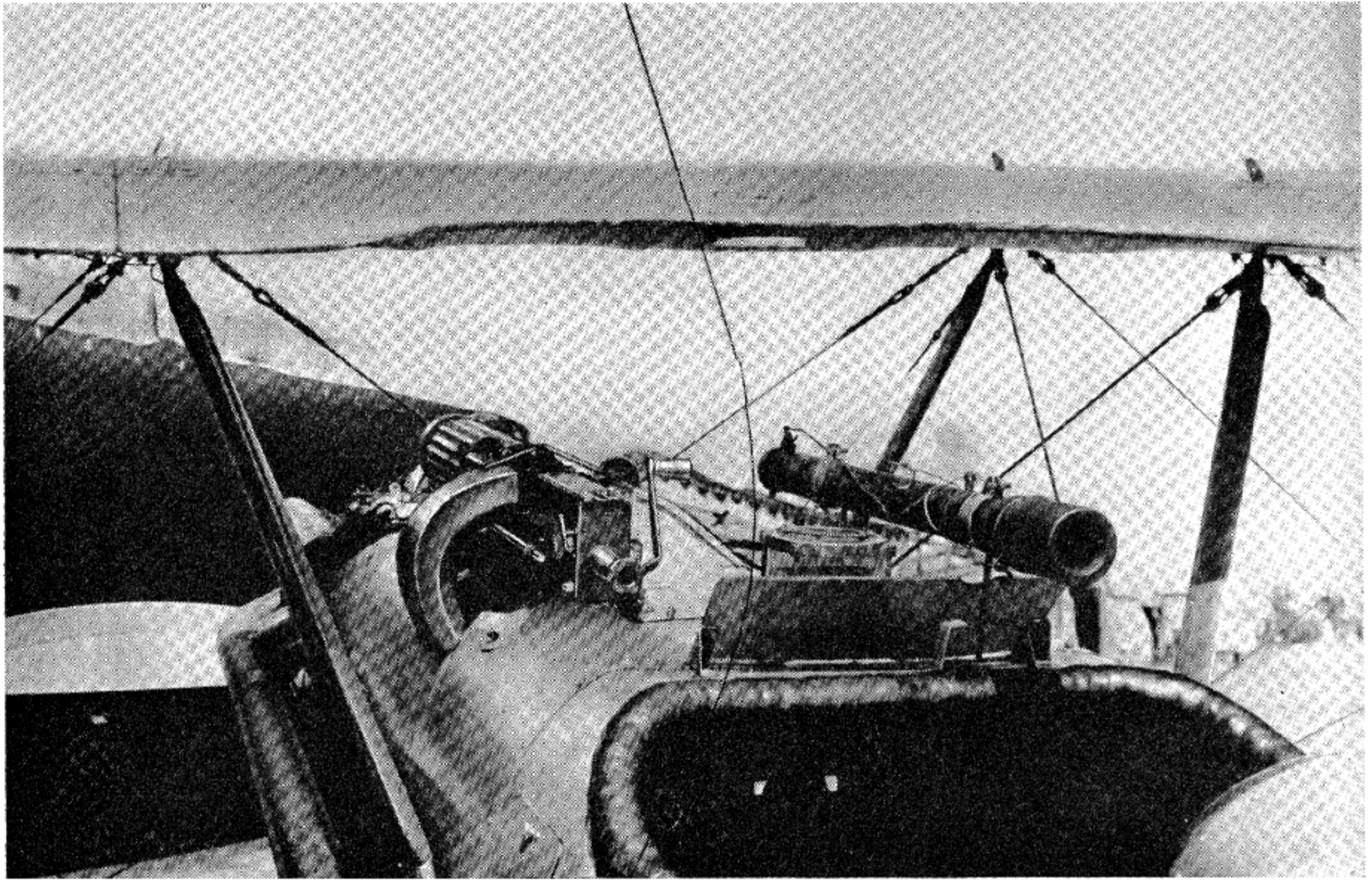

Vickers Machine Gun, Synchronized with Propeller in a Pursuit Plane, World War I.

tor down until the leading edge approached. The lug then ran off the cam and the spring-loaded trigger depressor let up on the sear interrupting the fire. The device was operated by a simple oil pump that furnished pressure until the leading edge of the propeller started to line up with the gun muzzle. At this point it released tension only to take it up after the blade passed.

Overnight all mechanically operated synchronizer gears were obsolete. Manufacture was started at once by the Vickers Co. and the first model made by this firm was successfully demonstrated on a BE2C in August 1916. It showed perfect reliability and was adaptable to any type of airplane engine. From then on until the end of the war, the units were fitted to all aircraft as fast as both could be produced. Over 6,000 were installed on British planes alone between March and December 1917, and 20,000 more were added between January and October 1918.

The first planes to go into combat with the hydraulic synchronizer were a squadron of

DH-4's which arrived on the continent on 6 March 1917. Two days later two groups of Bristol fighters were fitted with the same arrangement. From then on aircraft with this aid to fire power were delivered at regular intervals. Now the planes could fire straight ahead, in addition to maneuvering one or two machine guns on a free mount.

At first the Constantinesco gear was designed to fire only one machine gun, but it was soon adapted to operate two mounted parallel to each other. The Sopwith "Camel" was the first plane so equipped. It had a fire power of 1,600 shots a minute or, as the British figure it, 40 pounds of projectiles in the same period.

The synchronizing device was so successful that it became a must in British aircraft armament. It was placed in all subsequent models as fast as they appeared. As a result of its introduction on the DH-4s and Bristol fighters, the Allies recaptured supremacy of the air from the Germans, and while there were times when it was

gravely in jeopardy, it was never relinquished for the remainder of the war.

The Vickers gun was ideal for synchronizing because it employed a spring-loaded firing pin. This was released only when the weapon was in battery and the bolt securely locked.

The next officially adopted modification was a speeding-up device invented by Lt. Comdr. George Hazelton of the British Navy. It consisted of a specially designed sleeve and conical spring between the followers and barrel discs. The only other change in the gun was the hardening of the front left recoil plate and the substitution of a much heavier roller washer pin. The latter change was necessitated because experimental firing showed that the ordinary pin vibrated loose.

While the Hazelton attachment accelerated firing up to 1,000 rounds a minute, and one Vickers, so modified, went 14,000 rounds on a test before the first critical break of a component part, this rate was thought to be too high for reliable performance. The booster was then altered to slow the weapon to 850 shots per minute, which was the optimum speed decided upon officially.

The first British planes equipped with the fully modified speeded-up Vickers guns were ordered not to fly beyond their own lines as the changes were classified as "Top Secret" and the Royal Air Force wished to battle-test the improvements thoroughly behind its own lines before beginning mass production. It did not want the Germans to salvage one of its test planes through being shot down behind enemy lines. No doubt memories were still vivid of the forcing down of Roland Garros in German territory and the capture of his bullet deflector which resulted in the reliable Fokker synchronization system.

Another increased rate-of-fire attachment under consideration at the time of the Hazelton device was the invention of Lieutenant Dibovsky of the Russian Navy, who had earlier been unsuccessful in getting his synchronizer adopted. While his booster did get the Vickers well over 1,000 rounds per minute, the action of the gun was so violent that it required many other compensating adjustments to keep breakage from being prohibitive. The parts of the Dibovsky attachment were also very complicated to manufacture. Since the speeds of both the Dibovsky and the Hazelton were practically identical, it was logical that the British adopted the latter.

Both devices utilized the blast following the bullet's clearance of the muzzle to add to the recoil forces and furnish surplus energy to accelerate the recoiling mechanism. The trapped gas expanded in the chamber and, acting on the face of the barrel, shoved it rapidly to the rear.

A great deal of difficulty was experienced in using cloth or fabric ammunition belts in air firing the Vickers, because during a "dog fight" the empty end of the belt would blow back in the pilot's face or become entangled with some part of the plane. The problem was remedied by the adoption of the metal link disintegrating belt. As each cartridge was extracted and fed into the gun, the link would separate from the rest of the belt and either drop in a canvas bag or fall harmlessly over the side. This unique but practical method of feeding the Vickers was invented in 1917 by William de Courcey Prideaux of Weymouth, England, a French civilian who at the time was residing in Great Britain. One of the best features of the disintegrating links was that all Vickers could be modified to use them simply by changing two small parts in the feed system.

As each new problem in aerial warfare pre-

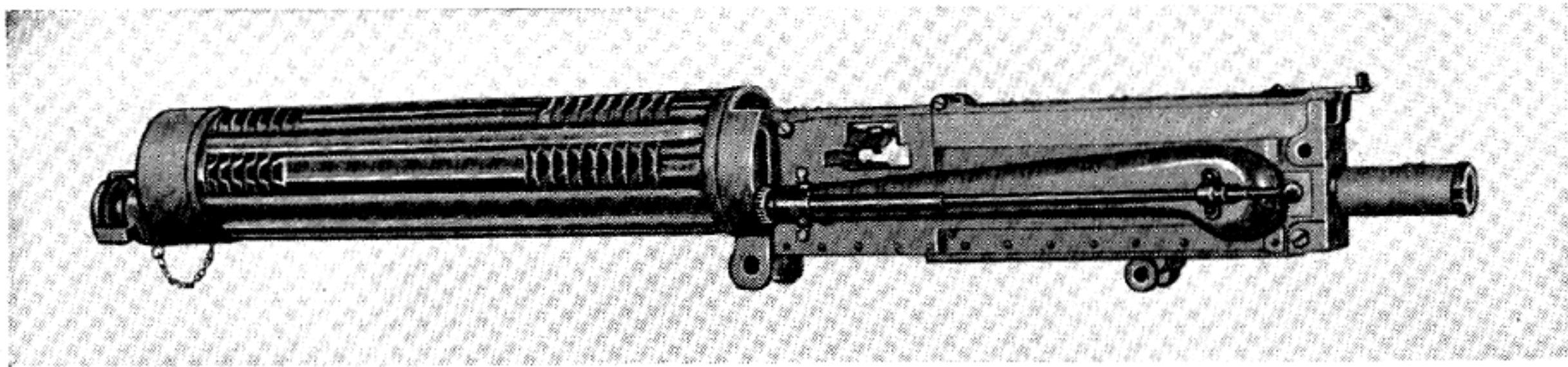

Vickers Aircraft Machine Gun, Model 1918, 11 mm. Manufactured by Colt's Patent Fire Arms Co.



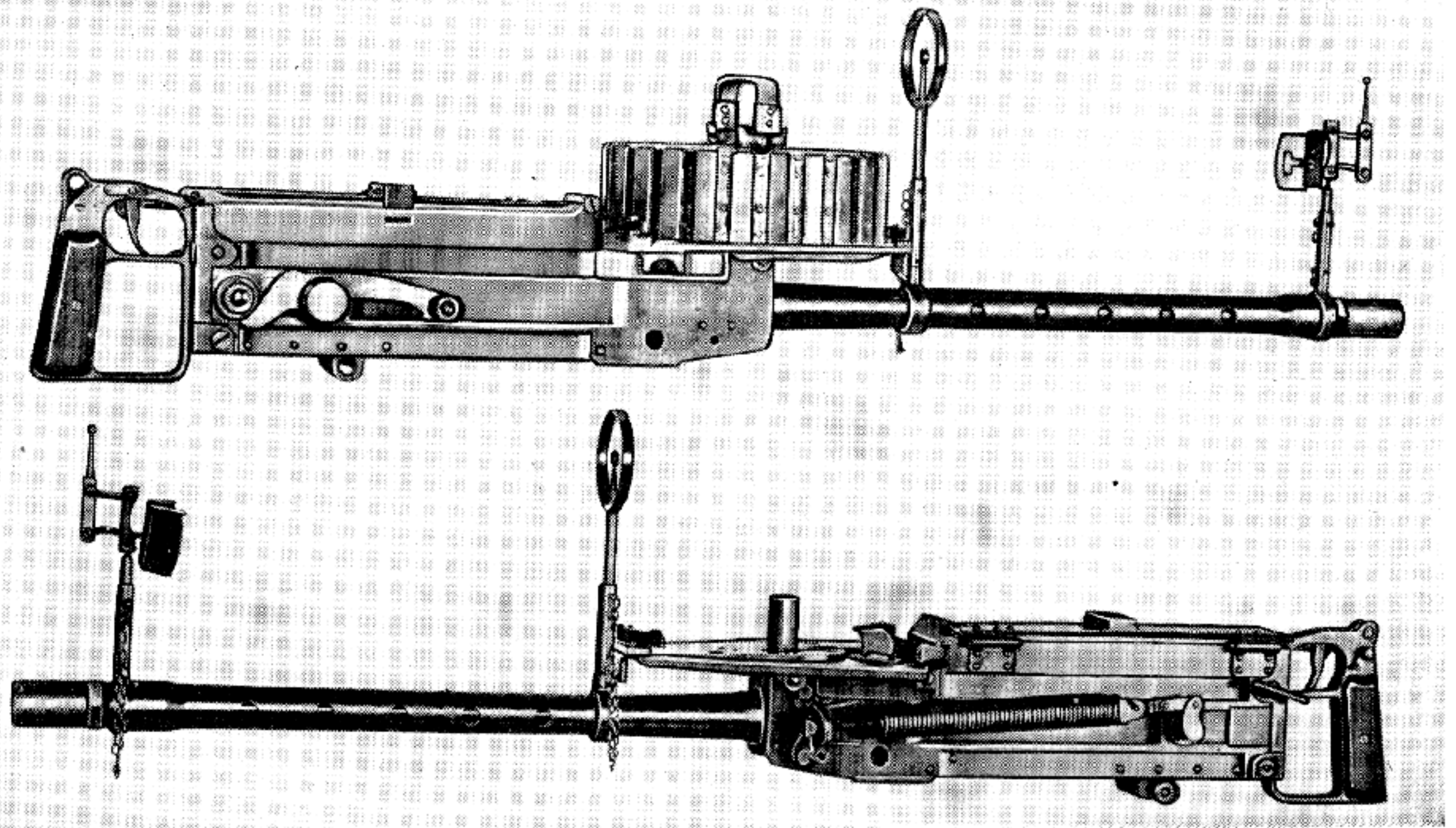

Vickers Aircraft Machine Gun, Class "F", Cal. .303.

sented itself, it was solved by some eager inventor. Difficulty in sighting was overcome by the appearance of tracer ammunition in which the base of the bullet contained a mixture that ignited when going through the bore and provided a luminous trajectory from the muzzle to the target. The mixture first used consisted of barium oxide, a very high oxidizing agent, combined with powdered magnesium, a substance that burns rapidly with a visible flame. This, like the other refinements, only added to the deadliness of the weapon. The tracer not only allowed the gunner pilot to correct the course of his plane until his bullets made contact, but in many cases, it ignited gas or inflammable surfaces upon hitting the plane and the victim plunged to earth in flames.

Within a few months armament on all fighting planes had increased tremendously without basic changes merely by refinement of an existing machine gun. The effectiveness of air combat increased proportionately. This short period removed for all time the early semicomical aspect of military aviation; in fact it was an unusual month after January 1917 that did not bring

either some radical refinement or an accessory that contributed to the deadliness of air warfare. The machine gun was already far ahead of aviation and only needed application of various theories to make it as efficient in the air as it was on the ground.

During 1917 the Allied air command saw need for an aerial machine gun larger in caliber than the conventional rifle bore for use against observation balloons. The French were the first to modify the Vickers to take their 11-mm Desvignes cartridge in order to provide more of the tracer and incendiary elements.

The Russians were using a larger caliber Vickers than the other Allies and this fact made it the easiest of the various Vickers to modify for the large French cartridge. An order was placed with Colt's Patent Fire Arms Co., Hartford, Conn., to alter a thousand Russian guns to shoot the 11-mm cartridge. When this was done, early firing tests showed that the rifling pitch was too pronounced and threw the tracer element out of the bullet soon after leaving the muzzle. The difficulty was caused by the rifling which cut the bullet jacket too deep and made the rear of the

bullet fan out. When the pitch was changed from one turn in ten to a complete revolution in 22 inches, the performance of the bullet was satisfactory.

The design of the weapons, except for the caliber, was identical with that of the smaller bore guns, and they were accepted with such enthusiasm that large orders were placed both in England and America. An additional order was placed with Colt for 1,700 guns after the company had filled the initial order. The weapon fired at a rate of 600 rounds a minute with an effective incendiary tracer range of 1,850 yards.

American ammunition factories were also ordered to make the new French incendiary bullet. This cartridge and the conventional gun made an excellent combination for attacking observation balloons and firing the gas tanks of fighter planes.

The Russian Vickers was chosen to be altered largely because at this time a revolution was raging in Russia and the Colt Co. could not deliver weapons ordered by the Czarist Government. The Allies, knowing they would have to rechamber the barrels anyway in order to use them, felt they were the most logical ones to alter for the larger cartridge.

The inferior French ammunition, inadequate

as it was in some respects, showed aviation authorities that a large bore machine gun or automatic cannon was a necessity in air warfare of the future.

The Vickers-Maxim mechanism was so reliably constructed that an attempt was even made to convert it to an observer's gun, in spite of the fact the Royal Air Force believed it already had the world's best gun of this type. The conversion consisted in putting a 97-shot drum feed on the weapon although belted cartridges could be used if need be. The drum was actuated by recoil of the barrel and barrel extension which engaged a lug with a cam on the circular feed and rotated it enough to index a round in line with the rising T slot on the bolt face.

This large drum protruding above the already high receiver did not make a very compact weapon. Most certainly it could not compare with other machine guns which were more in keeping with conditions of limited space and maneuverability. The location of the drum across the line of sight also made necessary an unusually high and unsatisfactory sighting arrangement. The weapon remained in a prototype form for a few years following World War I.

When motors capable of high altitudes were

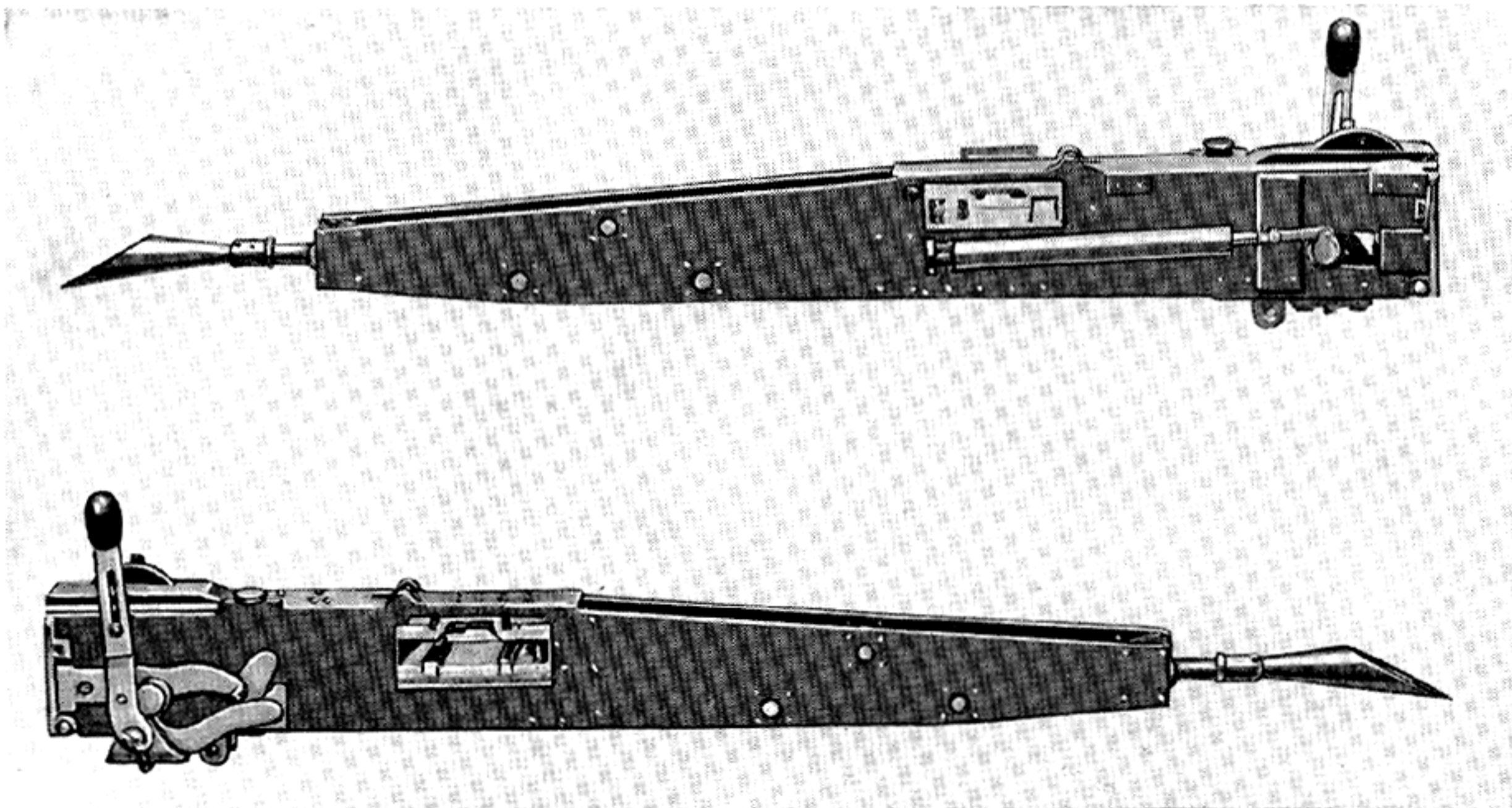

Vickers Machine Gun, Mark C, Cal. .50.

finally designed, naturally air fights took place at the new heights and pilots began to have new kinds of malfunctions that were traced to the extreme cold at these altitudes. Reports of stoppages became so prevalent that electric heaters were improvised by ordnance mechanics in collaboration with field electricians. Finally when a heater was made that proved adequate, manufacturing drawings were sent to the Vickers Co. and it was mass produced.

The greatest percentage of stoppages at high-altitude firing came from the gumming up of oil on the mechanism and the resulting sluggish movement caused excessive jams. To correct the situation, the parts were heated by copper pads on each side of the weapon, held in place by the same bolts that secured the cam. As all the moving parts were at one time or another brought into contact with the cam, it was felt that, if the latter was kept hot, it would in turn keep them warm enough to function smoothly under any

cold encountered. The weapons were also aided by the type of mountings used. In most cases they were placed in recesses in the cowling with only the top half of the jacket and the bore of the barrel uncovered.

To operate the Vickers high-speed aircraft machine gun, the pilot gunner first places the brass tag end of the cartridge belt, if a fabric belt is used, through the feed block from the right side. With the left hand he pulls it through as far as it will go. At the same time the crank handle is rocked back on its roller to its full limit, and while in its rearward position the belt is again pulled one more space, indexing the incoming round.

The crank handle is now released and flies forward under its spring tension. The sliding face on the bolt moves up when all parts are in battery, allowing its T slot to slip over the cartridge rim. Again the handle is pulled rearward and at the same time the ammunition belt is pulled over the space of one round. When the

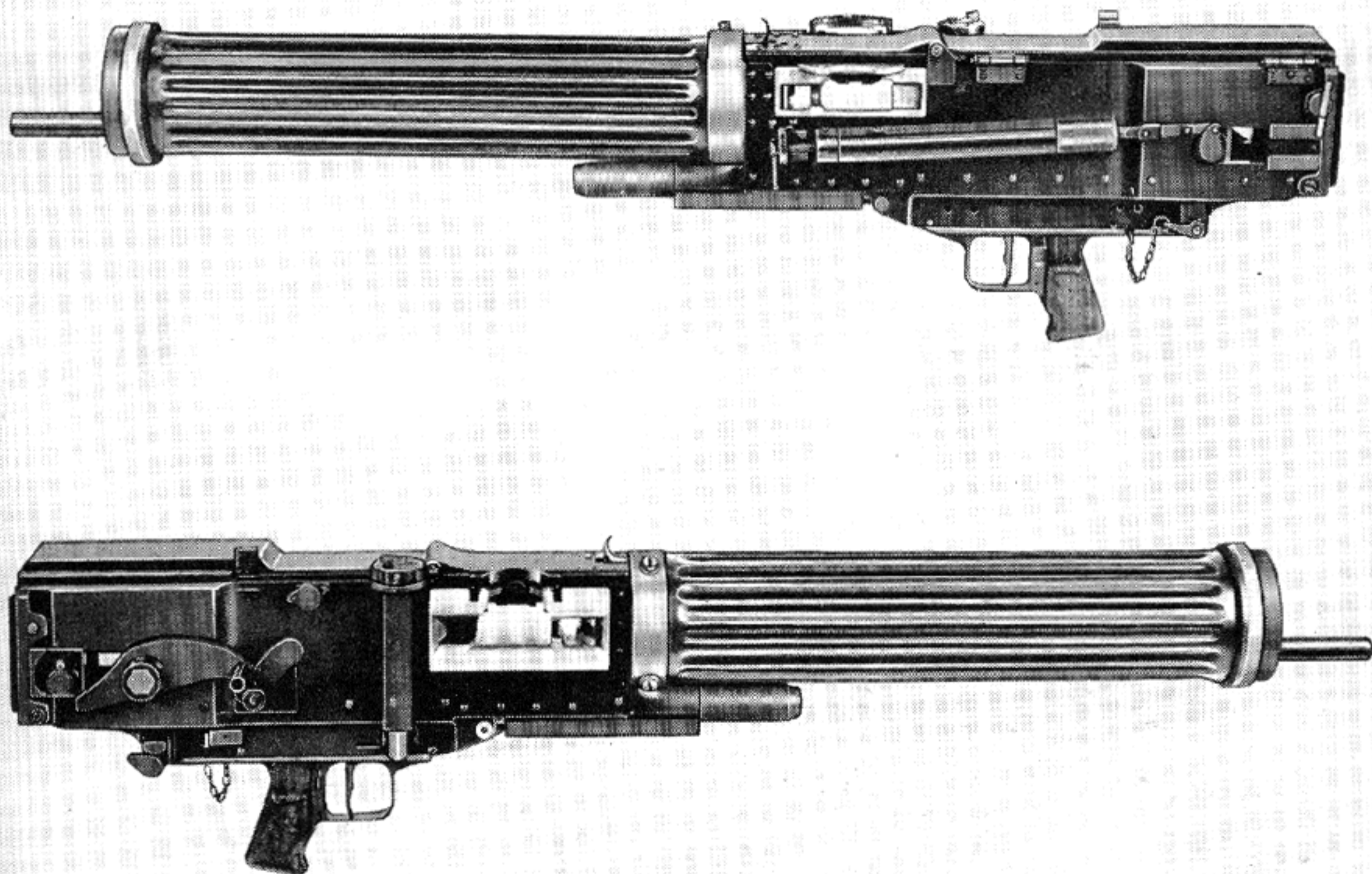

Vickers Machine Gun, Mark V, Cal. .50.

belt moves left as far as it will go, the handle is released.

This second cycle places the first cartridge in the chamber and the T slot is over the incoming round in the feed belt. The weapon is now charged for firing. The pilot, when ready, depresses the trigger fastened on his stick and by either a mechanical or oil pump arrangement the synchronizing device sears off the first shot, with the powder gases driving the bullet down the bore. The barrel and bolt remain locked together until the bullet clears.

The Hazelton device is located on the end and as soon as the bullet leaves the muzzle, it enters an orifice that is slightly larger than the bore. The gas that has been driving the bullet expands in the trap back of the orifice, and acts on the face of the barrel. It accelerates the rearward action, not only hastening unlocking but greatly speeding up the recoiling parts.

As the weapon's toggle joint is being broken to unlock, it exerts initial extraction on the empty case and loosens it in the chamber. By the time it unlocks, the cartridge case is free as the T-slot extractor carries it rearward. The T slot withdraws the incoming round from the belt and the bolt face is forced down by action of the side cams. When the recoiling parts reach the extreme rearward position, they encounter the modified buffer which returns the mechanism at high speed. As the bolt moves to battery, the live round is put into position for chambering and at the same time knocks the empty case free of the T slot through the opening beneath the receiver. In the last fraction of travel into battery the T slot is cammed up over the rim of the incoming round. The sear is released when the toggle locking joint advances beyond the center line. As

long as the sear remains depressed, the cycle is repeated.

Following World War I, a vast number of Vickers aircraft machine guns were left in stock, but their manufacture had been such that the interchangeability of parts could not be assured. They had been fabricated by many different companies under war conditions. With the let-down in ordnance development that followed the conflict the difficult task of overhauling these guns was undertaken, including the modification of certain parts to improve reliability and insure the ease of changing parts.

The guns, when completely gone over, were designated Mark V. It took from five to eight of the earlier models to make one of the improved versions. England finally wound up with a sizable quantity of the weapons and felt secure as far as aircraft armament was concerned until the decision was made to arm its future fighters with eight guns apiece. Then the director of equipment realize that the guns in storage would not last any time in the event of war.

The Vickers-Maxim guns on hand at the beginning of World War II included the outmoded class E of World War I vintage, and the class F observer's gun that fed from both drum and belt. Both weapons were in rifle caliber. In caliber .50 were the Mark C, a peculiarly designed weapon intended for use against armored vehicles and for anti-aircraft work and the Mark D for anti-aircraft use. The latter fired a high velocity projectile having a rate of 3,000 feet per second.

While these weapons were admittedly out of date, they were not replaced by better aircraft guns until after they had carried the Royal Air Force victoriously through the battle of Britain in a decisive struggle for air supremacy from the Allies' point of view.

# GERMAN MAXIM-TYPE AIRCRAFT WEAPONS

## Early Adaptations

The German Government had prepared well for the inevitable conflict known as World War I. It decided early that machine guns would play a dominant role and concluded from secret tests that the Maxim machine gun, as it was still known in Germany, was the most reliable firing mechanism yet designed. The Model '08 Maxim was adopted as its first line machine gun. A later refinement to the standard '08 model resulted in a lighter version known as the '08/15. The water-cooled weapon was still fairly heavy and its 50-round belt with container could be attached on the side. A shoulder stock was also

added together with a lightweight bipod of 2½ pounds. The total weight without water but with bipod was 31 pounds. The '08/15 differed from the '08 gun principally by its method of cooling. On this version the water jacket was simply filled and the jacket plug screwed in. There was no way to circulate the water as provided for in the heavier gun.

The weapon was produced in unusually great quantities as its modification from the original '08 model was comparatively easy. Allied intelligence agents estimated that at the outbreak of the war Germany had at least 12,500 Maxim-type guns stored in huge warehouses and 50,000 more on order. That the nation's existence was

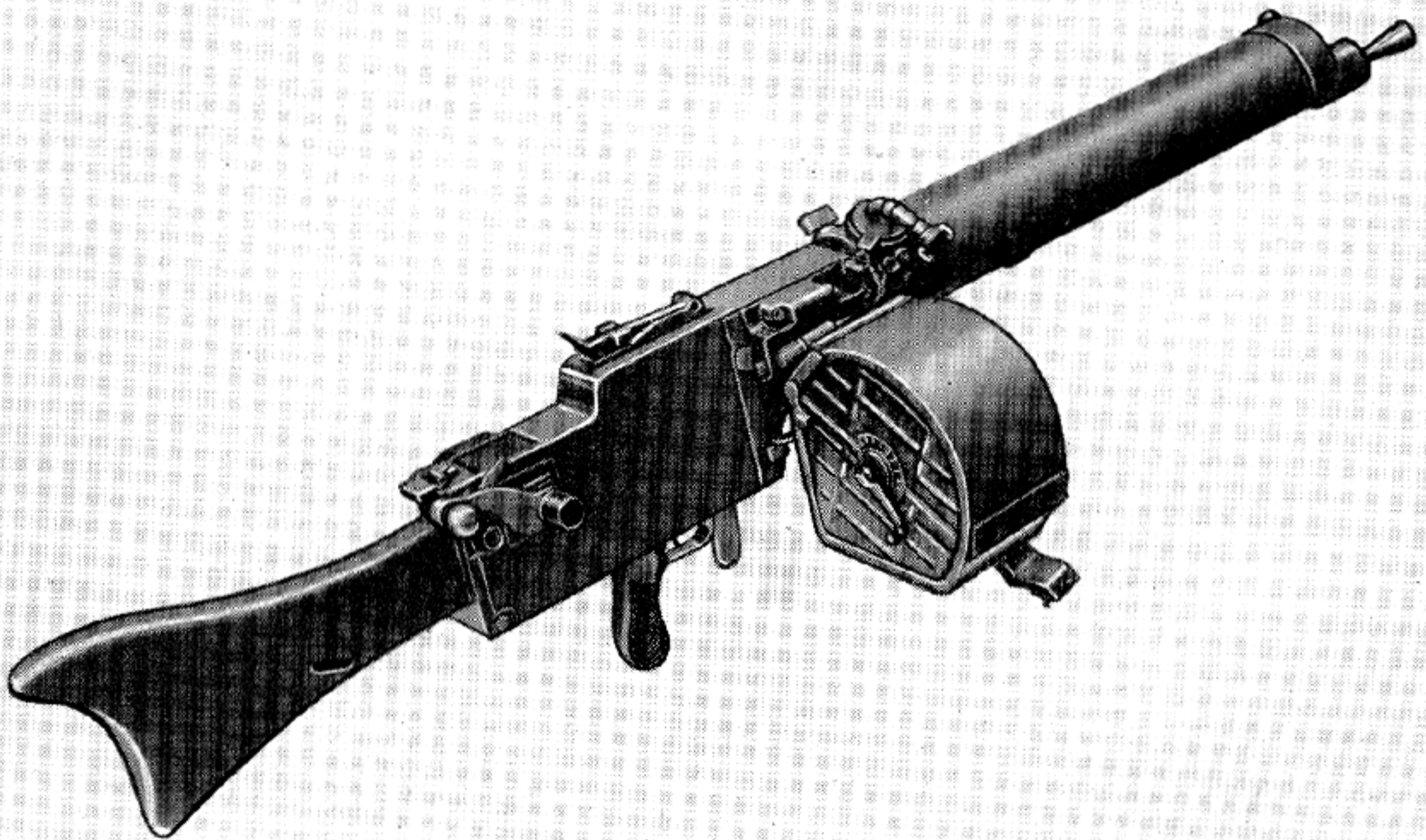

Maxim Machine Gun, Model '08/15, 7.92 mm, German.

entrusted to this one type of machine-gun mechanism shows the extent of German confidence in the principles developed by an American, Hiram Stevens Maxim.

The '08 and '08/15 models were both used extensively in arming Zeppelins against hostile aircraft. The Germans felt that the tops of the dirigibles made unusually stable platforms from which to fire bursts of any length desired, thanks to the water cooling of the barrels. The lack of a critical weight factor with the Zeppelins allowed German airship commanders to install water-cooled Maxims both on the top gun platforms and along the sides of the gondolas.

As early as a year before the war, the German press publicized the remarkable successes scored by machine gunners firing from the decks of Zeppelins. Part of a story appearing in September 1913 is here quoted to show the confident attitude of the crews that manned the airships:

"As could be foreseen from the absolute stable nature of that gun platform and from the entire lack of vibration and swaying, these tests were almost as successful as they would have been had the machine been discharged from the top of a mountain. The writer speaks from experience having made tests in aiming from the window of the cabin of the Zeppelin in flight. . . . We can depend upon seeing cannon appear on the large dirigibles in strict accordance with this stage of development by the enemy just as we saw machine guns appear which are now ample protection against airplanes."

But with all their planning, the Germans did not foresee the incendiary bullet and its effects. The British shot the Zeppelin and its superior armament out of the sky by puncturing its huge hydrogen-filled envelopes with flaming bullets. In a few short months the reign of the much-dreaded airship ended.

### Parabellum Machine Gun

The German Government a good many years prior to the war placed large orders for machine guns with its main arms-producing factory, the Deutsche Waffen- und Munitionsfabriken, located in Berlin. This company had unquestionably the greatest staff of gun experts to be found in any country. Its original head engineer had

been an American, Hugo Borchard, the inventor of a pistol afterwards erroneously named for his assistant and successor, Georg Luger. Early in 1911 a gun designer, Karl Heinemann, joined the firm. He had already made a name for himself in the field of automatic weapons. Heinemann was given the all-important job of refining the Maxim gun. His resulting achievement was one of the most outstanding efforts to come from World War I. The German Army, committed to the Maxim gun which was already under production, specified the mechanism must be of this type. It requested a lightweight high-speed gun that would fire the same 7.9-mm Mauser cartridge as did its heavy machine guns and infantry rifle. To make a definite improvement on such a time- and battle-tested weapon required the utmost skill and Karl Heinemann proved equal to the occasion.

The product of his effort was labeled the "Parabellum," which was the code name of the D. W. M. plant when referred to in correspondence. This superb weapon, like so many of its contemporaries in other countries, did not attract the attention it deserved until the necessity of war gave it a place among the finest automatic firing mechanisms.

Heinemann made the toggle joint break up instead of down, as in the original Maxim. The return spring was placed centrally against the crank and stored energy during the recoil stroke. The act of feeding was performed by a pawl working off the lock instead of by vertical movement of the lock itself. A differential action was also incorporated to speed up feeding of the next to the indexed round. This was done by forcing the barrel forward by cams before the recoiling lock had reached its extreme travel rearward. A faster rate of fire was made possible by such utilization of the feed pawl. The feed belt was made of cloth or fabric wound on a spool fastened to the gun's receiver, thus allowing it to swing with the gun. In contrast with the earlier model the fusee spring was not adjustable.

This refinement by Karl Heinemann was the lightest Maxim-action gun ever designed. It weighed only 22 pounds without accessories, with a 700-round-a-minute rate of fire. Needless to say, it was the very thing the German Air Force



Parabellum Aircraft Machine Gun, Model 1913, 7.92 mm. This Early Type Used the Water-Cooled Jacket Slotted for Air Cooling.

was looking for when its Zeppelin threat was exploded by British machine-gun fire. The Parabellum was the German first-line aircraft machine gun throughout the war. A few have also been found equipped with water jackets for ground use or perhaps more logically for Zeppelin mounting.

The following cycle of operation of Karl Heinemann's Parabellum, or refined Maxim gun, is given:

When the cartridge is fired, the whole inside portion travels backward with the breechblock

still firmly locked to the barrel until the outside crank comes in contact with the resistance roller. The crank then begins to turn downward, carrying with it the connecting rod, the other end of which draws the breechblock away from the barrel.

The weapon has a sliding T slot that also recedes, with the live cartridge drawn from the belt and the empty case from the barrel. It is guided and supported by the projections extending sideways from its upper end, which ride over the straight part of the side cam, riveted to the side

plates, until the cartridge just drawn out of the belt is clear of the feed way. Then the projections follow the downward-curved edge of these cams, guided from the top by an inversely curved cam, formed on the guide piece for the breechblock and riveted to the under side of the cover.

During this period the connecting rod in its downward movement presses against the tail of the tumbler, which, in its turn, draws back the firing pin and compresses the mainspring. The sear engages into a notch in the tumbler and the safety sear re-engages with a shoulder on the firing pin. When nearly at the end stroke of the breechblock, the T slot's projections leave the points of the side cams and the T slot drops into its bottom stop by its own gravity assisted by the guide directly above it.

This aligns the cartridge with the chamber of the barrel, which pushes the empty case clear of the bolt face and through the slot in the bottom of the receiver. The crank, having now completed its rearward turn, begins its return stroke, and the advancing breechblock forces the live cartridge into the chamber.

In this operation the Parabellum's T slot is steadied, as its projections are kept in contact with the lower surface of the side cams. As the crank returns toward its horizontal position, projecting cams, or side levers of the connecting rod, come in contact with the ends of the lifting levers, pivoted to the breechblock and thereto by the pin. The other ends of these lifting levers are engaged between two lugs on the carrier. When they are pivoted by leverage of the cams on the connecting rod, the carrier rises with a steadily increasing velocity and the lower part of the upper stop slides over the head of the live cartridge in the chamber. At the same time the upper part of the T slot slips over a fresh cartridge in the feed way and retains it in position between the grooves of the T slot and the upper and lower parts of the stop.

When the T slot arrives at the top, the end of a leaf spring, riveted to the right-hand recoil plate, drops into a notch cut on its side and keeps it in that position until, in its rearward travel, the projections slide onto the side cams and support it.

The crank and connecting rod, having resumed their firing position, brace the breech-

block hard against the breech. At the last moment the connecting rod lifts the safety sear. The effort of the mainspring is thrown upon the hand sear. If now the trigger bar at the bottom of the gun casing is held to the rear by continued pressure on the trigger connected thereto, the tail of the sear will strike against the lug at the free end of this bar and set free the firing pin, the point of which will pass through its tunnel in the bolt face and explode the primer. The cycle described will continue as long as the trigger is kept depressed.

### The Fokker Synchronizer

Since the action of the Parabellum was front seared, it was ideal for synchronizing when employed as an observer's gun. It was used in such a manner after Antony H. G. Fokker, the famed aircraft designer, developed a mechanical method of firing safely through the propeller blades.

He conceived his idea when shown the crude arrangement of a French plane that had been shot down when attempting to fire through the air screw. Bringing his inventive genius to play after examining the enemy device, Fokker produced an interrupter gear. While he was acclaimed for his feat, his invention was actually based on a patent issued in 1913 to Franz Schneider, a Swiss aeronautical engineer, who had offered his invention to the German Army as early as 1912. After examination, it had been rejected as unnecessary, since there was no possibility that the airplane would ever become a fighting machine. At the time the Zeppelin so dominated the German mind as the perfect aerial weapon that the value of Schneider's patent could not be foreseen. It was only in an hour of desperation that Germany was provided with Fokker's version of the Schneider synchronizer.

Antony Fokker was born in Batavia, Java, in 1890 and at an early age showed a genius for invention. This brilliant Netherlander was already an experienced aviator and airplane designer when World War I broke out. He had previously offered his designing talents to his own country, then to France and to Britain, only to be ignored by each. Germany accepted his services at once and the resulting relationship came within a hairbreadth of costing the Allies the war. Eng-



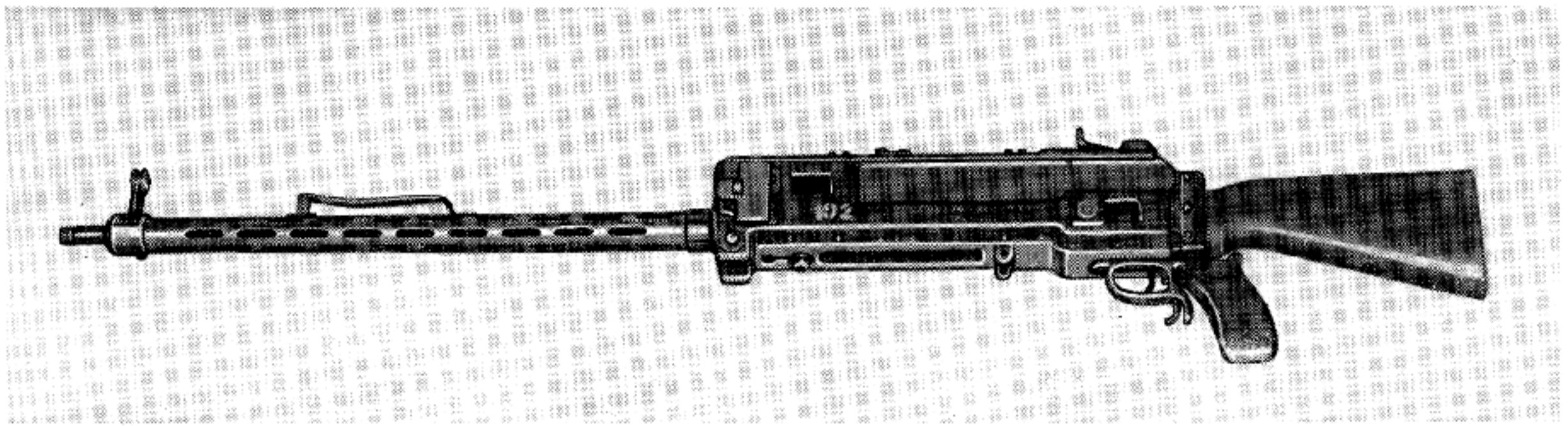

Parabellum Aircraft Machine Gun, Model 1913, 7.92 mm, with Refined Barrel Jacket.

land, which had paid no attention to the "young fanatic," later secretly offered him £2,000,000 for his services.

It is hard to believe that this man who gave Germany domination of the air for 6 months was barely 24 years old at the time. The act that accomplished it was but incidental to his really notable work in the design and construction of the Fokker fighter planes. Within 48 hours after examining the makeshift French device, he produced a reliable interrupter gear based on Schneider's patents. It added a hundredfold to the deadliness of the superb fighting craft of his own design. The fact that he had never handled a machine gun before in his life made his feat even more astounding. The German staff was highly incredulous that he could turn out anything worthwhile in such a short time, and Fokker gained its confidence only by repeated demonstrations with a motor on the ground.

The first German pilot to use the synchronizer against the enemy was Lt. Oswald Boelke, later to become Germany's pioneer ace in great part because of this device. The next flyer to install one on his plane was Lt. Max Immelmann, also destined to become a great air fighter. After hesitation in the beginning, the General Staff became wildly enthusiastic about the new weapon. They had a right to be as the synchronizer gave them a superiority that took many months for the Allies to overcome.

While there was great similarity between the German and the later British mechanical firing devices, except the Constantinesco type, the secret of the Fokker-Schneider system was that the interrupter gear kept the trigger depressed while the propeller arc was clear. It let up on the

scar at the approach of the leading edge of the blade which acted as an interrupter only in a burst. The British device worked just the opposite in that it tried to release the sear by a series of lugs striking cams. This allowed bullets to hit the blade if anything worked loose or if anything happened to change the timing of the weapon, since each individual impulse fired a shot. The German synchronizer fired a continuous burst except when the approach of the propeller and its corresponding lug on the shaft interrupted fire until the trailing edge of the blade had cleared.

The German fighting plane's propeller in normal flight rotated 1,200 times per minute, and as this made the blades pass a given place 2,400 times, it can readily be understood that the timing device must be foolproof in design. With a 6-inch space passing a given point 2,400 times a minute, the fundamental fact underlying the successful operation of any synchronizer is the relatively greater velocity with which the bullet is traveling to that of the turning blade.

The first Fokker planes, the E1, E2, and E3, equipped with the Dutch inventor's interrupter gear, appeared on the Western Front in December 1915. They gave the Allies a decided setback and caused many casualties until something as efficient was produced as a countermeasure. The Fokker fire interrupter was one of the German Air Force's top secrets, although in April 1914 Franz Schneider not only had allowed the New York publication, the *Scientific American*, to print an article describing the device, but had furnished drawings showing its construction. The Allies, however, did not realize its value until much later.

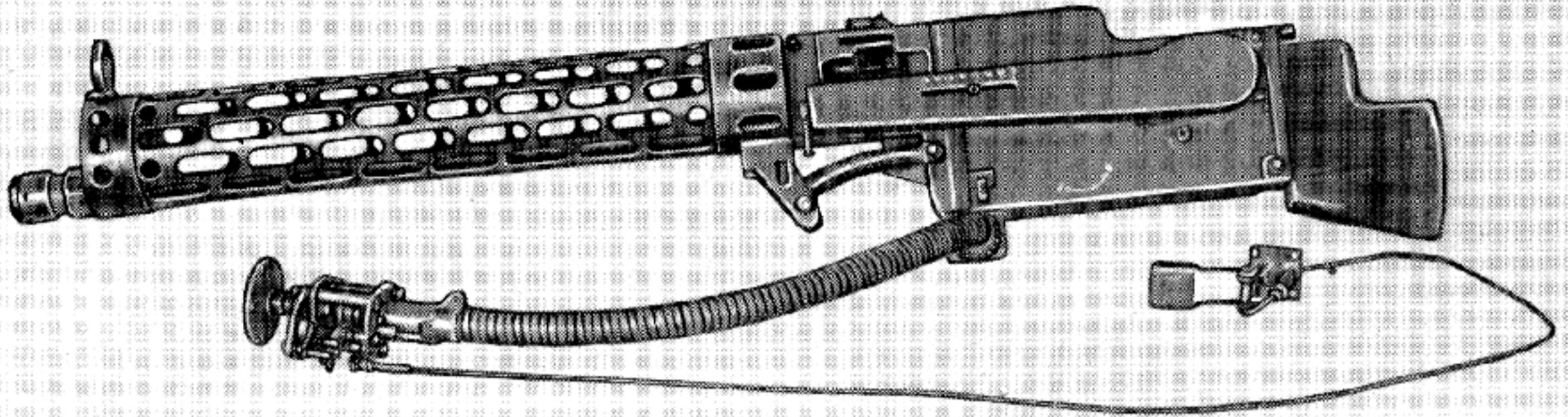

Maxim Machine Gun, Model 08/15, 7.92 mm, Modified for Synchronizing. This Weapon Manufactured at the Spandau Arsenal is Often Called the Spandau Machine Gun.

In connection with the first test of the synchronizer, the following graphic story is told in Fokker's own words:

"While I was flying around about 6,000 feet high, a Farman two-seater biplane, similar to the ones which had bombed me, appeared out of a cloud two or three thousand feet below. That was my opportunity to show what the gun would do, and I dived rapidly toward it. The plane, an observation type with propeller in the rear, was flying leisurely along. It may even have been that the Frenchman didn't see me. It takes long practice and constant vigilance to guard against surprise air attack, for the enemy can assail one from any point in the sphere.

"Even though they had seen me, they would have no reason to fear bullets through my propeller. While approaching, I thought of what a deadly accurate stream of lead I could send into the plane. It would be just like shooting a rabbit on the sit, because the pilot just couldn't shoot back through his pusher propeller at me.

"As the distance between us narrowed, the plane grew larger in my sights. My imagination could vision my shots puncturing the gasoline tanks in front of the engine. The tank would catch fire. Even if my bullets failed to kill the pilot and the observer, the ship would fall down in flames. I had my finger on the trigger. . . . I had no personal animosity toward the French; I was flying merely to prove that a certain mechanism I had invented would work. By this time I was near enough to open fire and the French

pilots were watching me curiously, wondering, no doubt, why I was flying up behind them. In a moment it would be all over for them.

"Suddenly I decided that the whole job could go to hell. It was too much like 'cold meat' to suit me. I had no stomach for the whole business, nor any wish to kill Frenchmen for Germans. Let them do their own killing!"

### Introduction of Armored Planes

In 1917 the Gotha Waggonfabrik Co. designed and built for the German Air Force a battle plane that had great influence on future machine-gun design. This aircraft was known as the Gotha biplane, a huge affair with a wing span of 78 feet and an over-all length of 41 feet. The motors were encased in nacelles resting in the lower wing. It was a three-seater, with space for two observer gunners and a pilot. The armament consisted of three machine guns, two Parabellums and a water-cooled Maxim. The latter was mounted in an ingenious tunnel under the aft part of the fuselage so that the rear gunner could fire with an unobstructed view below and to the rear of the machine.

Having great lifting power and with weight not being a critical factor, the Gotha had armor placed over vital parts in the engine and around crew members. The unusual fire power, armor and absence of unprotected blind spots made it a formidable foe to encounter. The Allies lost many pilots who tried to attack the ship from

beneath only to be cut down by the concealed gunner, using a water-cooled gun that permitted bursts of any necessary length.

Quentin Roosevelt, an American pilot and son of ex-President Theodore Roosevelt, was killed while attacking one of these Gotha planes from below. Witnesses of the fight saw many of Roosevelt's tracers hit the Gotha only to bounce harmlessly off the armor. The young pilot's death and the impotency of his guns made our ordnance officers realize something had to be done at once to overcome this tremendous advantage.

The caliber .30 was definitely outmoded from then on. The first thing done was to use the principle of Thorsten Nordenfelt and produce an armor-piercing bullet. The next was to demand the design of a larger caliber higher velocity cartridge and a machine gun to fire it. The Gotha battle plane was the first incentive for larger bore guns. It was only a few days after Quentin Roosevelt's death that Gen. J. J. Pershing cabled our Ordnance Department giving minimum specifications that he considered necessary for an adequate machine gun. In this correspondence he stated that the velocity should not be under 2,750 feet per second and the caliber be a minimum of one-half inch. While the passing years have proved the general's wisdom, it was the German Gotha biplane which showed to all concerned that the day was over when an infantry type machine gun could bring to earth a military fighting ship.

### The T. u. F. Machine Gun

The Germans, being the first to armor their own planes, knew that by doing so their existing rifle-caliber machine guns likewise would be made obsolete for aircraft use. They proceeded with typical thoroughness to prepare for the day when their airmen would have to contend with armor on enemy planes. This vital need for a machine gun firing a bullet large enough and with enough velocity to penetrate heavy armor was brought to their attention in a more forceful way by the British use in 1917 of heavy armored motor-propelled land vehicles called tanks.

To combat this new weapon, the Germans quickly scaled up their 7.9-mm infantry rifle cartridge to 12.7 millimeters, having a 770-grain boat-tailed bullet with a muzzle velocity of 2,650 feet per second. When a tungsten steel core was used, to their agreeable surprise it penetrated the sides of captured British and French tanks easily at 100 yards. The armor was in some places as much as one and a fifth inches in thickness. The newly designed cartridges were then being fired in a clumsy bolt-action single-shot rifle, employed through desperation as an antitank weapon. It was realized that, if an automatic firing mechanism could be produced capable of handling the new ammunition, the British advantage from the use of armored tanks would be quickly overcome.

As the Maxim Model '08 caliber 7.9-mm machine gun was Germany's main standby in its highly efficient automatic weapon units, and as the German ordnance designers had seen the identical mechanism used in a shell gun of 37-mm bore, called the "pom-pom," the most logical solution for the problem seemed to be the designing of a Maxim action between these two extremes that would successfully handle the high-velocity 12.7-mm antitank rifle cartridge. In early 1918 this was done in great secrecy and with a manufacturing priority second only to that of the high cyclic rate Gast aircraft machine gun. The latter weapon was counted on to give the nation air superiority.

The German high command felt that the large caliber machine gun would simply annihilate the armored units of the enemy both on the ground and in the air. Consequently they named their new and deadly devise the "T. u. F." (*Tank und Flieger*, meaning *Tank and aircraft*) machine gun. The intended use was clear from its name. But regardless of the excellence of the idea, the fabrication of components did not reach a stage where it ever saw action against the enemy. There were 4,000 T. u. F. machine guns on the point of delivery when the Armistice was signed.

With the coming of the army of occupation, the German Army's ordnance section, which supposedly did not exist, according to the Versailles treaty, but was nevertheless highly active, or-

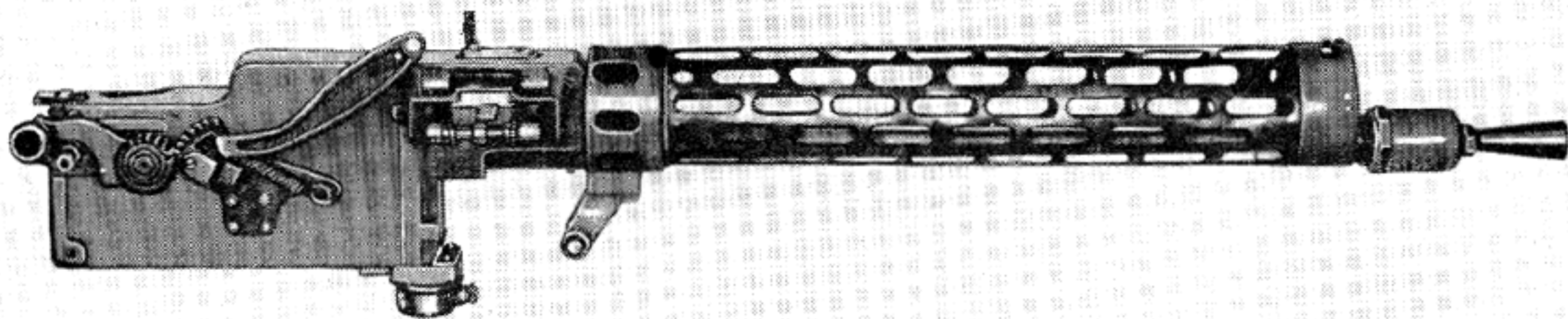

Maxim Machine Gun, Model '08/15, 7.92 mm, Modified for Aircraft Installation.

dered that the weapons be hidden and that all correspondence concerning them be done in code.

Two of the code designations given the weapon were "Machine gun 08" and "SS machine gun." The Germans believed that the Allied intelligence had knowledge of the development of a super antitank and aircraft machine gun, but felt the weapons could be concealed since none had ever been on a battlefield. The designation "Machine gun 08" was used to create confusion with the ordinary 7.92-mm infantry-type machine gun. During the war numerous model '08 Maxims were altered to take a Schwere cartridge having a slightly different shaped bullet, and these guns were marked with a large letter "S" on top of the receiver to show modification. The Maxims so labeled were known in an unofficial way as the "S" machine guns. The Germans hoped that the addition of a second "S" in their code for the T. u. F. would obscure its existence.

Photographing of the gun and its movement to storage without first being covered were not permitted. However, an Allied commission sent into Germany not only learned of the existence of the weapons but also seized all correspondence between the underground German ordnance group and the companies that manufactured and assembled the components. They found beside the 4,000 originally promised for fall delivery that an additional 2,000 had been ordered as late as October 1918. Thus the German Army expected to have on hand 6,000 such weapons to

meet the well-advertised Allied spring offensive that the Armistice canceled.

The T. u. F. was made up of 250 components, manufactured by 60 different companies. These parts were delivered to the Maschinenfabrik Augsburg-Nuremberg, which was especially charged with assembling and mounting the weapon. All steel used in this high priority work was delivered exclusively by the Siegen-Solingen-Gusstahl A. V., located in Solingen.

The Germans succeeded, after finding that the Allies had possession of all facts concerning the gun, in destroying practically all assembled ones and it was with the greatest difficulty that ordnance men of the United States Army in August 1921 finally located a T. u. F. with 82 cartridges. This gun, along with the small amount of ammunition, was eventually shipped to Springfield Armory for test. There being only the few cartridges available at the time, no conclusion as to its merit could be reached. Besides, there was under development by Colt's Patent Firearms Co., of New Haven, a caliber .50 machine gun that was considered by all to be a genuine improvement on the German version. The cartridge used by the American gun, however, was later copied from the one fired by the T. u. F., it having better ballistic characteristics than the one being developed in this country.

The unusually high regard the German authorities had for the weapon is shown by the following: Even after practically all of the supply had been destroyed, as a result of the Inter-Allied Control Commission's discovery, the out-

lawed German ordnance authorities notified by telephone the 60 plants previously engaged in making the components not to stop fabrication of these parts. A written order was later found that guaranteed payment to the companies for the finished parts even if they were seized by the Allied occupation forces, and that directed them to "continue to manufacture them at all costs." The Allies in due time stopped all production on the gun in Germany but it took several years to accomplish it.

In 1923 it was reported to the United States Army Ordnance Department that German patents had been granted on the design of the T.

u. F., which had been sold to Czechoslovakia by Mr. A. Ten Bosch, a civil engineer of the Hague, Holland, to whom they had been assigned. Ten Bosch had retained the rights for production of the weapon in the United States, but the Army was not interested.

### Models of Maxim Guns

At the conclusion of the discussion of Maxim-type weapons in this publication, a tabulation is given, for ready reference, of the various Maxim systems and models used by the nations of the world:

System	Country	Designation	Bore
Vickers	Holland	Model 1918	7.92 mm
Maxim	Germany	Model 1899	7.92 mm
Maxim	Germany	Model 1901	7.92 mm
Maxim	Germany	Model 1908	7.92 mm
Maxim	Germany	Mod. '08/15	7.92 mm
Maxim	Germany	Mod. '08/18	7.92 mm
Parabellum	Germany	Model 1914	7.92 mm
Parabellum	Germany	Model '14/17	7.92 mm
Maxim T. u. F.	Germany	Model 1918	13 mm
Maxim DWM	Germany	(circa 1902)	37 mm
Maxim	United States	Model 1904	cal. .30
Vickers	United States	Model 1915	cal. .30
Vickers AVN.	United States	Model 1918	cal. .30
Vickers AVN.	United States	Model 1918	11 mm
Vickers AVN.	Japan Navy	Type 97	7.7 mm
Vickers AVN.	Japan Army	Type 89	7.7 mm
Vickers	Japan	Type 98	7.7 mm
Vickers A. A.	Japan	Model 17, Type 1	40 mm
Maxim (captured)	Greece	German type	7.95 mm
Vickers TNK.	Greece	British type	7.9 mm
Maxim	Austria-Hungary	Model 1889	8 mm
Maxim	Austria-Hungary	Mod. '89/04	8 mm
Maxim (F. N.)	Belgium	Model 1911	7.65 mm
Maxim <sup>1</sup>	Belgium	Model 1908	7.65 mm
Maxim <sup>1</sup>	Belgium	Mod. '08/15	7.65 mm
Vickers AVN.	France	British type	7.7 mm
Vickers AVN.	France	British type	11 mm
Vickers	France	Model 1909	7.7 mm

<sup>1</sup> Converted German.

System	Country	Designation	Bore
Vickers .....	France .....	Model 1909 .....	8 mm
Maxim (ex-German) .....	{ Poland .....	Mod. '08 .....	7.92 mm
		Poland .....	Mod. '08/15 .....
Maxim .....	Chile .....	Model 1902 .....	7.92 mm
Maxim .....	China .....	Model 1935 .....	7.92 mm
Maxim .....	Italy .....	Model 1906 .....	6.5 mm
Vickers-Maxim .....	Italy .....	Model 1911 .....	6.5 mm
Maxim .....	Peru .....	Model 1901 .....	cal. .301
Maxim .....	Peru .....	Model 1911 .....	cal. .301
Maxim .....	Great Britain .....	(circa 1891) .....	cal. .45 (Martini-Henry)
Maxim .....	Great Britain .....	(circa 1893) .....	cal. .303
Maxim .....	Great Britain .....	(circa 1899) .....	cal. .303
Maxim conv. Mk I .....	Great Britain .....	(circa 1902) .....	cal. .303
Maxim conv. Mk II .....	Great Britain .....	(circa 1898) .....	37 mm
Vickers .....	Great Britain .....	Mark I (circa 1912) .....	cal. .303 <sup>2</sup>
Vickers .....	Great Britain .....	Mark I .....	cal. .303 <sup>3</sup>
Vickers TNK. ....	Great Britain .....	Mark VII .....	cal. .303
Vickers TNK. ....	Great Britain .....	Mark IVa .....	cal. .303
Vickers TNK. ....	Great Britain .....	Mark IVb .....	cal. .303
Vickers TNK. ....	Great Britain .....	Mark VI .....	cal. .303
Vickers TNK. ....	Great Britain .....	Mark VI* .....	cal. .303
Vickers AVN. ....	Great Britain .....	Mark II .....	cal. .303
Vickers AVN. ....	Great Britain .....	Mark IIa .....	cal. .303
Vickers AVN. ....	Great Britain .....	Mark III .....	cal. .303
Vickers AVN. ....	Great Britain .....	Mark V (rebuilt from Mk IIa and III.) .....	cal. .303
Vickers AVN. ....	Great Britain .....	Mark VI (new mfg.) .....	cal. .303
Vickers AVN. ....	Great Britain .....	Mark VI* (converted circu- lator) .....	cal. .303
Vickers AVN. ....	Great Britain .....	Mark VII (new mfg.) .....	cal. .303
Vicker TNK. ....	Great Britain .....	Mark I .....	cal. .50
Vickers TNK. ....	Great Britain .....	Mark II .....	cal. .50
Vickers TNK. ....	Great Britain .....	Mark IVa (converted Mk I) .....	cal. .50
Vickers TNK. ....	Great Britain .....	Mark IVb (converted Mk I) .....	cal. .50
Vickers TNK. ....	Great Britain .....	Mark V .....	cal. .50
Vickers Naval .....	Great Britain .....	Mark II .....	cal. .50
Vickers .....	Portugal .....	Model 1917 .....	7.7 mm

<sup>2</sup> Ground.<sup>3</sup> Air, converted from ground.

System	Country	Designation	Bore
Vickers	Portugal	Model 1930	7.7 mm
Vickers	Portugal	Model 1937	7.92 mm
Maxim	Switzerland	Model 1894	7.45 mm
Maxim	Switzerland	Model 1900	7.45 mm
Maxim	Switzerland	Model 1911	7.45 mm
Vickers AVN.	Czechoslovakia	British type	7.92 mm
Maxim (former German).	Turkey	Model 1908	7.92 mm
	Turkey	Mod. '08/15	7.92 mm
Vickers	Turkey	British type	7.92 mm
Maxim (former German).	Lithuania	Model 1908	7.92 mm
Maxim	Esthonia	German type	7.7 mm
Maxim	Finland	Model 1932	7.62 mm
Maxim	Russia	Model 1905	7.62 mm
Maxim	Russia	Model 1910	7.62 mm
Maxim Tokarov	Russia	(circa 1924)	7.62 mm
Maxim Kolesnikov	Russia	(circa 1924)	7.62 mm
Vickers	Bulgaria	British type	7.7 mm
Maxim	Serbia	Model 1909	7 mm
Maxim	Bulgaria	Model 1909	8 mm
Maxim	Yugoslavia	Model M8M <sup>4</sup>	7.92 mm

<sup>4</sup> Converted spoils of war. Serbian and Bulgarian Model 1909 Maxim, 7 and 8 mm, respectively, both changed to 7.92 mm.

## MARLIN AIRCRAFT MACHINE GUNS

The mounting of Browning-designed machine guns in aircraft dates back to the Colt-Browning model, nicknamed the "Potato Digger" by the infantry because the operating lever after each shot swung down in pendulum fashion underneath the barrel. Due to a scarcity of machine guns, a few of these were placed in French and British pusher-type planes during the early stages of World War I. When this country entered the conflict, there was desperate need for any kind of machine gun. The type that could be mounted readily in aircraft without demanding too much of the already limited space or requiring any protruding accessories was especially in demand. While the swinging lever of the '95 model gun had the advantage of giving smoother action and exceptional reliability in ground operation, it was found to be very much in the way for aerial firing.

The Marlin-Rockwell Corp., New Haven, Conn., which had been given the contract to

produce many thousands of the Colt-Browning '95 model for infantry use, undertook to remedy the situation and make the weapon acceptable for aircraft use. Marlin was no new name in the gun manufacturing business. In 1870, the founder, J. M. Marlin, began making single-shot pistols and revolvers under the Ballard patents in a small New Haven shop. Later he brought out the J. M. Marlin-Ballard single-shot rifle that became one of the world's outstanding target arms because of its simple strong action and deep Ballard rifling. In 1880 Marlin himself designed a repeating lever action rifle that has been a specialty of the plant ever since.

Ten years later the Marlin Firearms Co. introduced a silent side-ejection big game rifle that was a notable contribution to safety and convenience. This lever-action magazine repeating arm created a sensation. Sturdy yet light, it was amazingly simple and practical in design and a reliable, accurate repeater.

In 1915 the firm was taken over by the Marlin-Rockwell Corp., which was established in New Haven for the production of machine guns on a vast scale. Carl G. Swebilius was placed in charge of experimental work. The Swedish-born Swebilius came to America in 1896 at the age of 16, taking a position with the Marlin Co. Beginning as a gun-barrel driller, he soon became one of the outstanding American firearm designers.

In World War I, Swebilius modified the Colt-Browning gun by doing away with the lever and substituting a straight-line gas-actuated piston. Such a change presented problems of its own. Instead of giving a slow and gradually accelerated backward thrust through a connecting rod arrangement, as in the case of the lever-operated weapon, the piston was driven back hard at the very beginning of its stroke. This caused a loss of initial extraction and resulted more often than not in tearing off the cartridge head instead of extracting the empty case. The fault was soon



Carl G. Swebilius.



remedied by further modifying the action through the addition of greater weight to the piston. The first rearward movement of the bolt was thereby somewhat retarded.

Swebilius deserves great credit for accomplishing this most difficult task, especially since it was performed in a few weeks' time. In this short period he made the Marlin gun a reliable automatic arm that was used throughout the war and for 3 years afterwards as the principal synchronized automatic machine gun of the American air force. Later it was also adapted to tank use. The weapon met with considerable enthusiasm on the western front as the following cablegram from A. E. F. headquarters in February 1918 shows: "Marlin aircraft guns have been fired successfully on four trips from 13,000 to 15,000 feet altitudes at a temperature of -20 degrees Fahrenheit. On one trip guns completely covered with ice. Both metallic links and fabric belts proved satisfactory."

Development of the Marlin aircraft gun was primarily one of modification and refinement from the gas swinging lever Colt '95 model. Marlin was so successful in the undertaking that new features were constantly being added. On 1 January 1918, the Signal Corps requested the design of a different firing mechanism that would permit single or automatic shots when used with four-bladed propellers and with the new and improved Nelson mechanical synchronizing gear. An arrangement whereby the hydraulic and mechanical trigger motors could be attached to the front of the lock container was also desired. The lock container was to be redesigned and the hammer materially lightened to increase the rate of fire.

An informal test was held on 27 December 1917, at which time another type of hydraulic synchronizing gear, also manufactured by the Marlin-Rockwell Corp. and similar to the Constantinesco gear, was tried out at rates varying from 200 to 600 rounds per minute with a total angle of dispersion of 63°. It was the closest and most accurate synchronization accomplished in this country with any type of machine gun so far. The Marlin aircraft machine gun has the distinction of being the first gas-operated weapon to be synchronized successfully.

The arm employed either a fabric or a disintegrating metal link belt that could be made up with as many as 500 rounds. Actually metallic links were generally used in aircraft throughout the war because of the inconvenience of disposing of the fabric belt's loose end after firing.

On 8 January 1918, a conference was held by the Army Ordnance Department at New Haven to decide on changes to be incorporated in the firing mechanism. Both the Signal Corps and the Marlin-Rockwell Corp. submitted new designs. Tests in the last days of that month proved the Marlin-Rockwell device satisfactory and the Signal Corps design a total failure because of easy breakage of parts. This was accountable for both by inferior material and by generally poor construction. A new hydraulic trigger motor was adopted at the same time and a contract for 15,000 motors and modified firing mechanisms was placed with Marlin-Rockwell. By this time the alteration and redesign of so many parts meant that they were not interchangeable with similar components of the old guns. To distinguish it in nomenclature from its original parts,

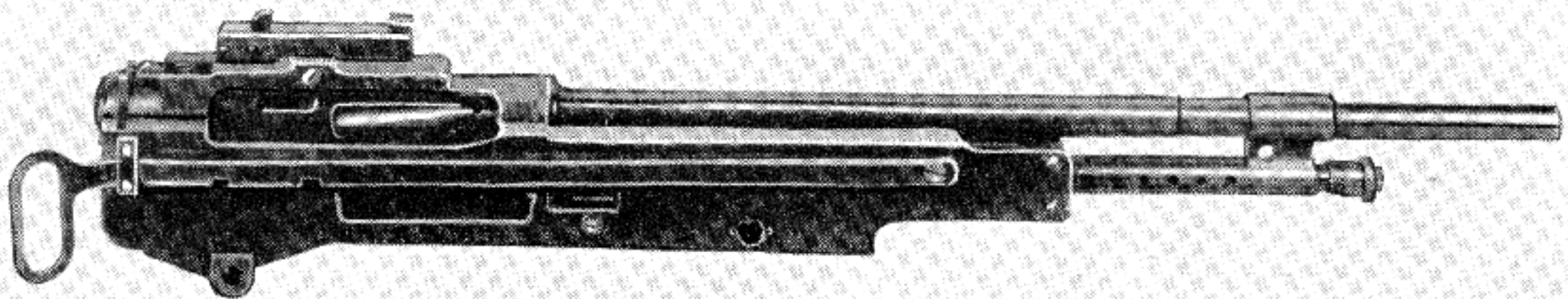

Marlin Aircraft Machine Gun, Model 1917, Cal. .30.

the improved product was called the Marlin Aircraft Machine Gun, Model 1918.

The modified weapon's principal point of difference from the 1917 model lay basically in its ability to be adapted to fire single shot or full automatic. This permitted much closer synchronization than full automatic alone. At the conventional propeller speeds of the day, however, the rate of fire was almost as great as with the automatic principle.

One of its main points of difference from the components of the 1917 model was a reduced gas pressure in order to cut down the parts breakages and stoppages caused by recoil. It was accomplished by enlarging the size of the gas piston and by drilling out less of the gas adjuster screw. The latter increased the volume of expansion of the gas chamber in the cylinder and cushioned its action. By milling three slots about one sixteenth of an inch in diameter through the side of the gas adjuster barrel, a vent was provided for the gas in the cylinder. It could be opened or closed at will by means of the adjuster. The double purpose was thus achieved of satisfactorily cushioning the recoil and also affording a wide range of adjustment of gas pressure acting on the piston. The increased recoil power necessitated a change in the bolt's cam slot pin to eliminate excessive breakage. More stock was added to the rear end of this piece to strengthen the cross section at a point where fracture was most frequent.

The fin was also given a glass-hard treatment followed by spot annealing. Material of the bolt pin was changed to chrome nickel steel to increase its durability as breakage often resulted from the severe wear on it after the first few hun-

dred rounds. The newly designed and more powerful hammer action also proved too strenuous for the firing pin assembly and the pin had to be redesigned with a long gradual taper throughout its entire length. This made it not only stronger but at the same time more flexible.

In order to eliminate accidental firing by contact of the firing pin with the extractor, a three sixteenth inch piece of stock was added at the top of the latter's lug employed to support the front of the bolt. It was also found necessary to bevel off the end of the receiver on the left hand side directly behind the ammunition belt. Interference at this point with the base of the cartridge had a tendency to twist the belt and cause stoppage. A hole was drilled through the right side of the lock container in which a key, known as the functioning operating cam, was inserted. Rotation of this key raised the trigger, thus enabling the gun to fire full automatic for testing and firing without the synchronizing gear.

An interesting device added to the new Marlin was known as the jam preventer. It consisted of a small steel stamping which was applied without further alteration to the ratchet lever in place of the ratchet lever pin washer. Its function was to prevent the lever's pawl from engaging the feed wheel when the cartridge was in the act of feeding and thus blocking the stop against further rotation of the wheel. The device would have been more appropriately named an anti-double-feeding device. According to reports from the field a reduction of stoppages resulted from use of the jam preventer. Unloading of the gun could also be accomplished by this arrangement without removing the belt as was heretofore found to be necessary.

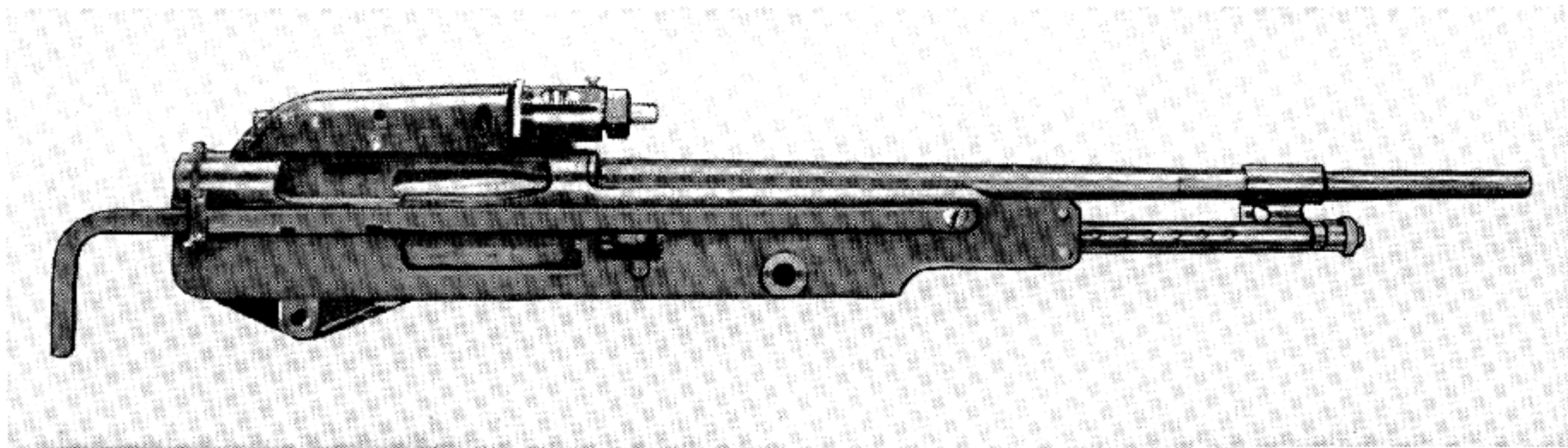

Marlin Aircraft Machine Gun, Model 1918, Cal. .30.

One more improved feature was the placement of the trigger motor at the forward end of the lock container and connecting it with the trigger by means of a timing gear. With this attachment the bolt could be removed without dismounting the trigger motor and carrier as was necessary with the 1917 model.

The gun's wide range of gas adjustments made it very dependable and it would fire positively under the most extreme conditions. Although originally adopted as a temporary substitute, the gun was improved by continued effort to such a highly satisfactory degree as to be pronounced the equal of the Vickers and other aircraft machine guns in excellence, synchronization and general reliability. Its success overseas was phenomenal. It was enthusiastically received by both the A. E. F. and the French as soon as pilots had mastered its few idiosyncrasies. The following reports bear witness to its competence.

"Pershing. 810-2. 3-29-18. Further test Marlin guns with both flexible and synchronized mounting made at 20,000 feet altitude, temperature below zero. Both guns functioned perfectly throughout the test."

"Pershing. 859-6. 4-12-18. Nine flights made to date with Marlin machine guns at altitudes ranging from 10,000 to 20,000 feet. Temperatures ranging from zero to well below zero Fahrenheit. Total rounds fired 1700. Guns used on both standard fixed and improvised flexible mounts. Both metallic and fabric belts used. No difficulties encountered and no stoppages. Recommend shipment of this gun continued rapidly as possible."

Various aerial squadrons added their praise with such words as the following: "In fact, all pilots have expressed a decided preference for the Marlin, as they shoot faster than the Vickers and are easily cleared of feed troubles." "The four Marlins we are using have kept up their perfect record." And "Thus far no Marlin guns have jammed in the air and they are in high favor among all pilots."

A report from the Chief Ordnance Officer of the A. E. F., dated 23 November 1918, stated that 22 squadrons at the front were either partially or fully equipped with Marlins having both hydraulic synchronizing gear and mechanical synchronizing gear. They gave thorough satisfac-

tion, being used on various planes such as the U. S. D-4, Spad 8, Spad 7, Salmson, and Breguet observation planes. Some difficulty was encountered in adapting the Marlin to planes bought from the French and British Governments since the fittings of these planes already had feeding arrangements intended for caliber .303 Vickers. But this trouble was soon overcome and in August 1918 the first squadron of French planes equipped with Marlin guns arrived at the front.

The last gun of this type made, which was the thirty-eighth thousandth, was taken from the assembly line and subjected to an endurance test of 10,000 rounds without a single stoppage or malfunction. At the end of the test it was found that only the replacement of a cracked shell extractor was necessary. There had been no appreciable increase in headspace and the condition of the gun after this firing was apparently as good as at the beginning. It passed inspection and was shipped as a new gun.

The first large shipment of 2,000 was sent to France on 11 October 1918, one month exactly before the end of the war, but it was not received in time for use at the front. The development of the Marlin as a flexible gun was also undertaken with promising success. The war was over, however, before much could be done with this type of gun.

All model 1918 Marlin aircraft guns were supplied with a trigger motor attached to the lock container, adapted for connections with both the Nelson and the C. C. synchronizing gear. The trigger motor, consisting of a piston and spring, was contained in a bronze cylinder which was screwed into the forward end of the lock container. The cylinder was provided with a coupling nut and tube into which the main pipe leading from the synchronizer could be soldered. A small vent screw located on top of this cylinder allowed the release of air from the system by bleeding. The C. C. synchronizing trigger motor was very similar to that used with the model 1917 aircraft gun.

These weapons also had electric heaters in order to prevent oil gumming up at the low temperatures accompanying extreme altitudes. The heaters were developed for both models of the Marlin aircraft machine gun. Each unit consisted of a resistance grid surrounded by insulat-

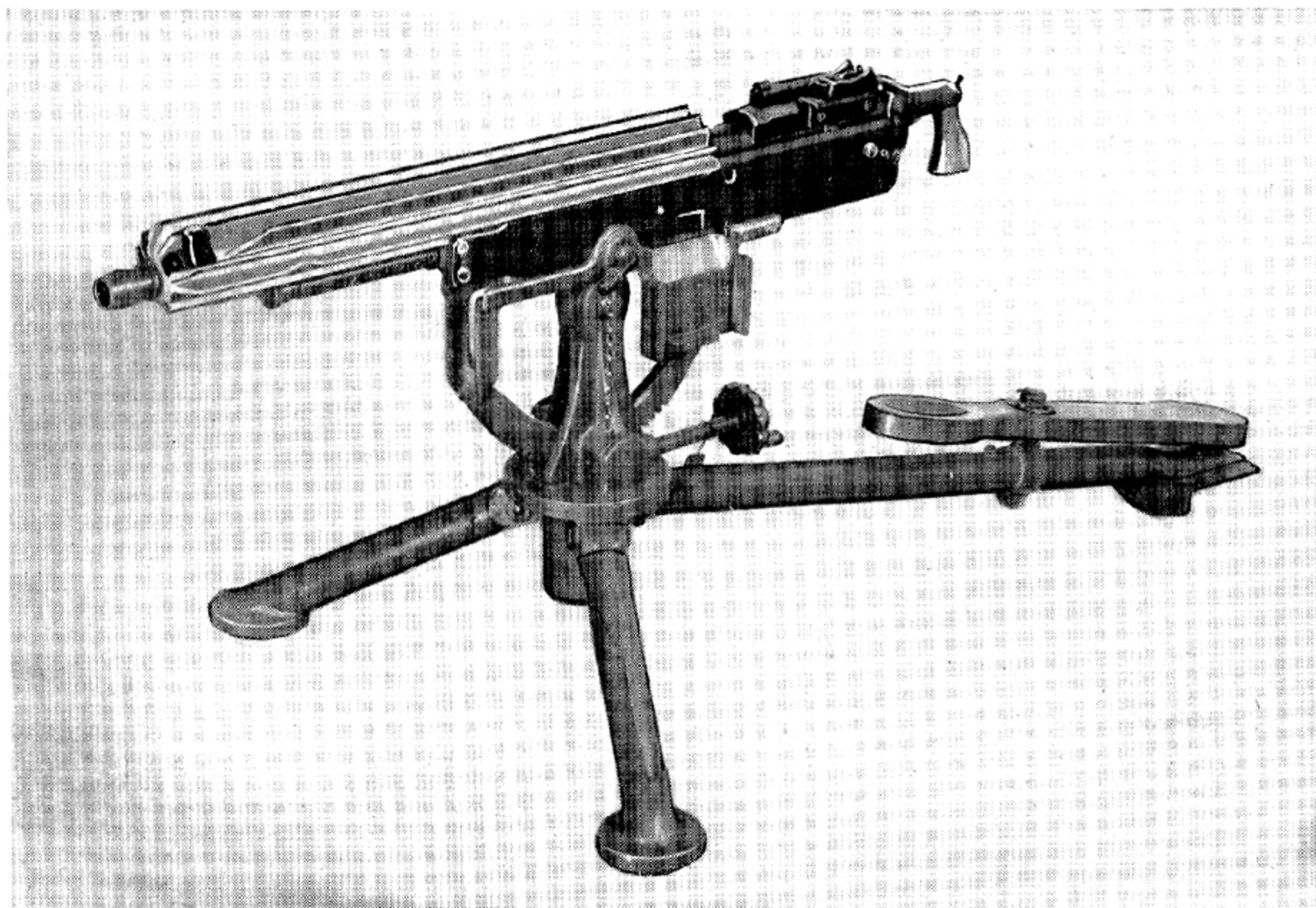

Marlin Tank Machine Gun, Model 1918, Cal. .30.

ing material and was riveted to the inside of the gun's bottom plate. It was connected with a bayonet plug on the under side of the bottom plate providing connection with the leads. The heater consumed 60 watts at 12 volts and was fed from the generator supplying the plane's lighting and heating system.

The Marlin gun, as issued, was belt fed, gas operated, and air cooled. It had a weight of 22½ pounds and without any speeding-up accessories normally fired 630 shots a minute.

To place the weapon in operation, a brass tip of the loading belt usually containing 250 rounds is inserted through the belt opening in the left-side plate and the first cartridge is forced up into position on the feed wheel. By pulling the charging handle lever twice to the rear, the cartridges are forced first into the feedway and then into the chamber. The gun is now ready for firing. When the trigger motor releases the sear, the nose of the trigger is disengaged and the hammer

forced forward by the spring tension, striking the firing pin and firing the piece.

When the bullet passes the gas port near the muzzle on the barrel, a small portion of the live powder gas goes through the port and through a corresponding aperture in the gas chamber. There it strikes the piston forcing it to the rear and compressing the action spring. The spring then furnishes power for the forward movement. The lug on the slide strikes the feed lever forcing it to the rear. A pin located on the lever operates in the cam slot of the ratchet lever to force it upward, while the ratchet lever pawl becomes engaged in the feed wheel. As the slide which is fastened to the piston rod moves to the rear, it carries with it the bolt and extractor. The extractor claw withdraws a cartridge from the belt and places it on the carrier for chambering. The bolt pin working in the cam slot underneath the bolt forces its aft end upward and unlocks the piece. As the recoiling parts go to the rear, the

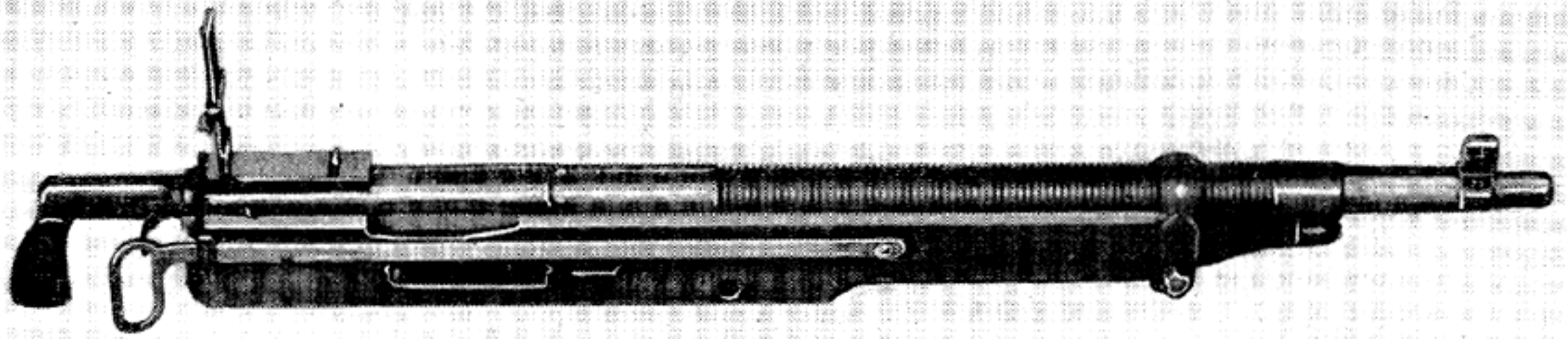

Marlin Ground Machine Gun, Cal. .30.

empty shell is pulled from the chamber by the extractor.

The base of the cartridge case during this movement strikes the shoulder of the ejector, and it is thrown out of the ejection slot on the right side of the receiver. The bolt on its continued backward motion strikes the hammer and forces it upward, compressing the strong hammer spring. The hammer then rides on the bolt for the balance of the recoil movement which ends as the slide strikes the springs on the buffer block. At this point counterrecoil movement begins, actuated by the force of the compressed action spring. The slide starts to move forward carrying the bolt with it. The cam on the bottom of the slide working against the carrier dog forces the carrier upward and aligns the cartridge in front of the bolt. Continued movement forward then positions the round in the chamber.

As the bolt locks securely, the extractor cams itself over the rim of the cartridge case. At the same time the lug on the slide strikes the feed lever forcing it forward. During this final movement the feed lever pin working in the cam slot in the ratchet lever forces it downward. As a result the ratchet lever pawl turns the feed wheel. This action places the incoming cartridge in position to be engaged by the extractor.

The extractor claw then takes its position over the rim of the cartridge in the belt. Just before the bolt drops into the locked position, the hammer engages in the sear and trigger notch, provided the sear is not depressed. If the trigger is held down, the cam cut on the slide works on its

corresponding lug on the firing mechanism forcing it out of engagement. This frees the sear from its notch and allows the hammer to strike the firing pin which discharges the cartridge. The cycle of operation continues until the trigger is released or the ammunition is exhausted.

If the trigger is released before all the cartridges have been fired, the bolt closes over a shell in the chamber but the hammer does not go forward. If the trigger is held down until the ammunition is exhausted, the bolt closes over an empty chamber.

The total number of the 1918 model Marlin manufactured was 15,000, as compared with 23,000 of the 1917 model. Conclusion as to whether the Marlin 1918 model machine gun was the U. S. Army's first line aviation weapon in World War I can be drawn from the report of a board of officers convened in 1920 by the War Department. The board was to meet as often as necessary for the purpose of considering the development of aircraft machine guns and aircraft cannon. The meetings took place regularly over a period of years until 1925 when it made its final report from which the following is quoted:

"The Board recommends that the Marlin machine gun, model of 1918, be continued in service, but that no further steps to improve the development of the gun itself be undertaken, in view of the present state of its development and a desire on the part of the Board to have all funds available for development work expended on the Browning aircraft machine gun.

"It is further believed that this gun is a satis-

factory air service weapon, although its limitations are acknowledged. It is not so efficient as to ease of assembly. Its clearances are smaller. It is more sensitive to dirt and rust than other guns examined by the Board. And it must be removed from its mountings for the purpose of cleaning and repairing in the airdromes. It is made to function with the Nelson mechanical gear and aside from the Browning aircraft machine gun no other machine guns have been made with that end in view. And these are the only two weapons now in the possession of the United

States which as issued will so function. The question therefore solves itself, as the Marlin aircraft machine gun, model of 1918, is the only gun at present which can be issued to function with the Nelson gear. In the event that a more satisfactory type of gun passes successful tests and is accepted by the Air Service as a satisfactory machine gun for their use, upon completion of the redesign and tests now in progress it is recommended that these Marlin models of 1918 be withdrawn from service and held in reserve for emergency use only."

## BROWNING AIRCRAFT MACHINE GUNS

## First Attempts at Air Firing

The caliber .30 Browning aircraft machine gun, which was designated the Model 1918, did not see combat service during World War I. The reason was that the poor choice of metals used in its construction and the demand for a high rate of fire caused the front lower part of the receiver to spread after comparatively few bursts and become unserviceable. The fault was ordered remedied by the addition of a stirrup at the affected part to give greater strength. As the Armistice followed shortly after delivery of the first guns, this failure and its subsequent correction seemed of small importance at the time.

Following the war the Army, which was charged with development of this weapon, set about to make the necessary modifications. Since there was no longer the critical time factor of the war years, the matter was closely studied. In order to produce a machine gun that would be adequate for years to come, many changes were found to be necessary. Some of the modifications were trivial, while others were so costly that it was sometimes felt the designing of a completely new weapon would have been more economical.

For like all aircraft machine guns it too evolved from a ground gun with one part changed, another lightened, and so on until the numerous alterations fitted the circumstances at

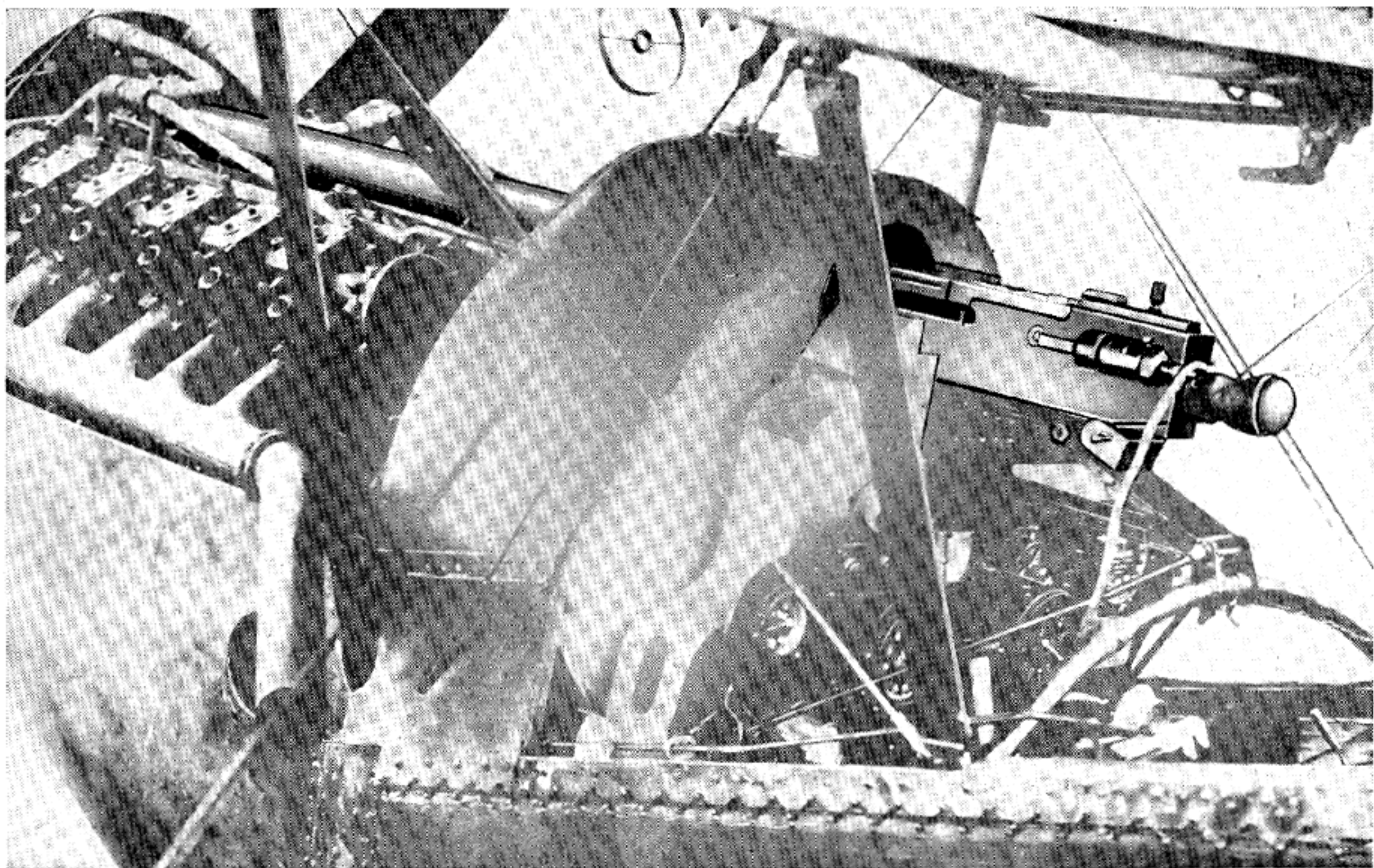

Browning Aircraft Machine Gun Mounted on a Bristol Fighter in England for First Test of the Browning in the Air.

hand. Then if the devisement did work, an increased rate of fire was demanded. This last feature almost invariably brought disaster to the successor of a once reliable, slow-firing, water-cooled, easily serviced gun.

This most certainly was true as far as the first Browning aircraft machine gun was concerned, as it had the same basic principles of the heavier infantry model lightened on a drawing board until it met a theoretical requirement.

Since a major overhaul was imminent, it was wisely concluded that all possible corrections should be made at the same time. As a result an Aircraft Armament Board was formed in 1920 and given power to make any changes thought necessary to meet future requirements. The report made by this board on the Browning guns tells in no uncertain manner all the modifications needed, along with what was considered desirable in the larger caliber aircraft machine guns that soon should be making their appearance.

The general report of the Aircraft Armament Board which convened to study the aviation ordnance question gives a most graphic description of the existing state of affairs. It first met on 29 March 1920, and after numerous sessions made its final report 5 years later. Its section on the Browning aircraft guns is here extensively quoted.

(It is hard to believe that 2 years after World War I the United States air force had no machine gun suitable for combat save the modified Colt '95 model gun, known as the Marlin Aircraft Machine Gun, Model 1917-18. Attention is invited to the number of new parts that had to be added and old ones reworked on the short-recoil-operated weapon Model 1918 before it was considered serviceable.)

### The Aircraft Armament Board Report

#### "Browning Caliber .30, for Aircraft Use

"(1) This Browning machine gun belongs to that class of automatic weapons known as short recoil operated, air cooled and belt fed. It is chambered for the standard caliber .30 U. S. ammunition. The force of recoil is utilized to perform the mechanical operations of feeding, load-

ing, extracting, cocking and ejecting the empty cartridge cases through the bottom of the receiver while the buffer and driving spring returns the counter recoiling mechanism to battery position. The weight of this gun is 23.5#, being intermediate between the Marlin and the heavy Browning water-cooled machine guns. . . .

"(2) As the Browning aircraft caliber .30 machine gun now stands, the 2,576 plus 491 guns, as delivered by Westinghouse Company and the Marlin-Rockwell Corporation respectively, are faulty in their construction and have not been issued to the Service for general use. The Ordnance Department has undertaken the alteration of these guns and a remedy of all existing defects as well as adding certain parts necessary for convenience in mounting and ease of operation. This work is now in progress at Springfield Armory and has been reviewed by the Board which has witnessed the firing of some of these guns and has examined the drawings of the machine guns being tested. The Board recommends that all existing guns be modified to conform to the developed models and that enough squadrons be armed to give the gun as thorough an air test as is possible during times of peace. The remainder of the guns to be stored subject to Air Service requisition.

"(3) This gun is capable of firing standard .30 caliber ammunition at approximately 2,700 feet muzzle velocity and is effective against the ordinary targets incident to airplane combat. This gun, as modified, is capable of being mounted in such a way that its mechanism is readily available to the operator for the purpose of reducing jams and clearing stoppages. The gun itself does not develop during fire any particular stresses on the airplane to such an extent as to render its mounting difficult. One of the most commendable features of the gun is its high rate of fire, about 1,000 rds. per minute. It is thought this is the highest rate of fire that the gun can stand, on account of the character and weight of its construction, and it is not thought necessary to initiate any further development tending to give a higher rate of fire.

"(4) The gun is capable of being used with the Nelson Synchronizer and as modified renders its connection with this attachment a simple mat-



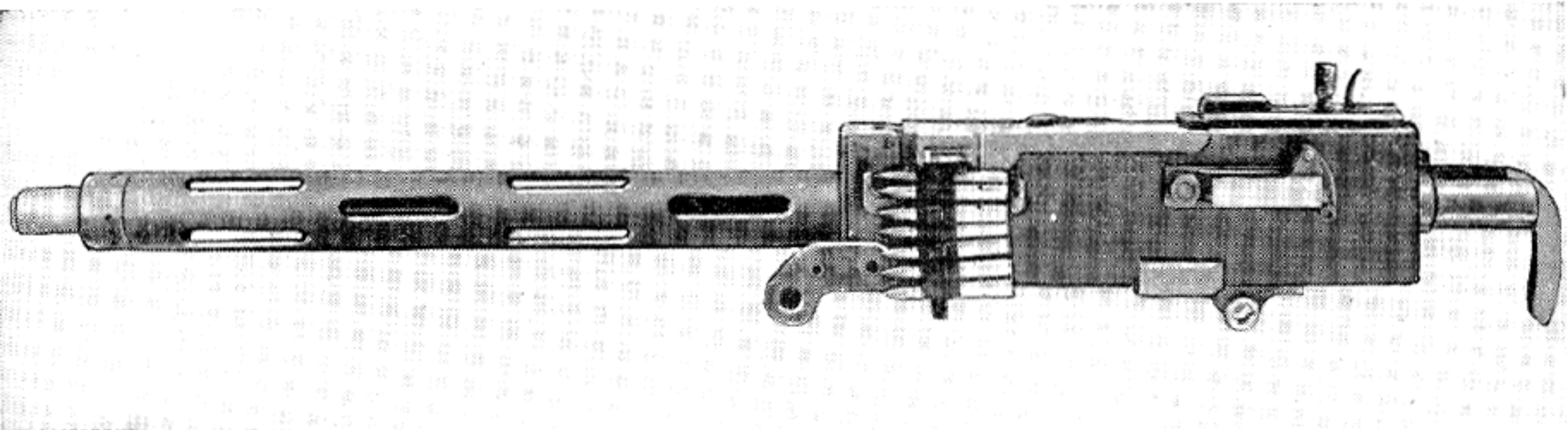

Browning Aircraft Machine Gun, Model 1918, M1, Cal. .30.

ter. Its firing mechanism is of such character as to make it the equal of any synchronizable gun so far as its synchronizing properties proper are concerned. Its effective range is sufficient for present and future needs. Its cooling device is designed for use in aircraft and is satisfactory. The gun will withstand for a reasonable length of time storage on the plane itself and does not require the great care that other machine guns do on account of its large clearances and small number of working parts.

"(5) The gun can be disassembled and assembled in a comparatively short time and does not require an expert to keep it in proper working condition. The gun can be cleaned and repaired without removing it from its mounting and so not disturbing the sights. The gun is not sensitive to the action of dust and grit on account of the closed construction of its receiver.

"(6) It is regarded as possible to develop a right and left hand feed for the Browning aircraft machine gun for use with the existing gun. The Board recommends that this development be initiated and that when said development has

been concluded it be given a thorough test, both on the ground and in the air.

"(7) The feeding device of the Browning aircraft gun is considered to be superior to all others.

"(8) The gun is capable of being fired from any position and will fire through an arc of 360 degrees except from a horizontal upside-down position, when the cartridges falling back in the receiver will probably cause jam.

"(9) The interchangeability of parts is sufficiently standard.

"(10) Although some of the major parts of the gun are interchangeable with corresponding parts of the Browning machine gun used in the ground service, the majority of parts are not interchangeable. Nearly all the differences in the two guns, however, have been dictated by a desire to obtain higher efficiency of the gun in the air and it is thought that no attempt should be made to accomplish an interchangeability between the ground and air Brownings. The Ordnance Department had initiated a project involving the manufacture of a new model Brown-

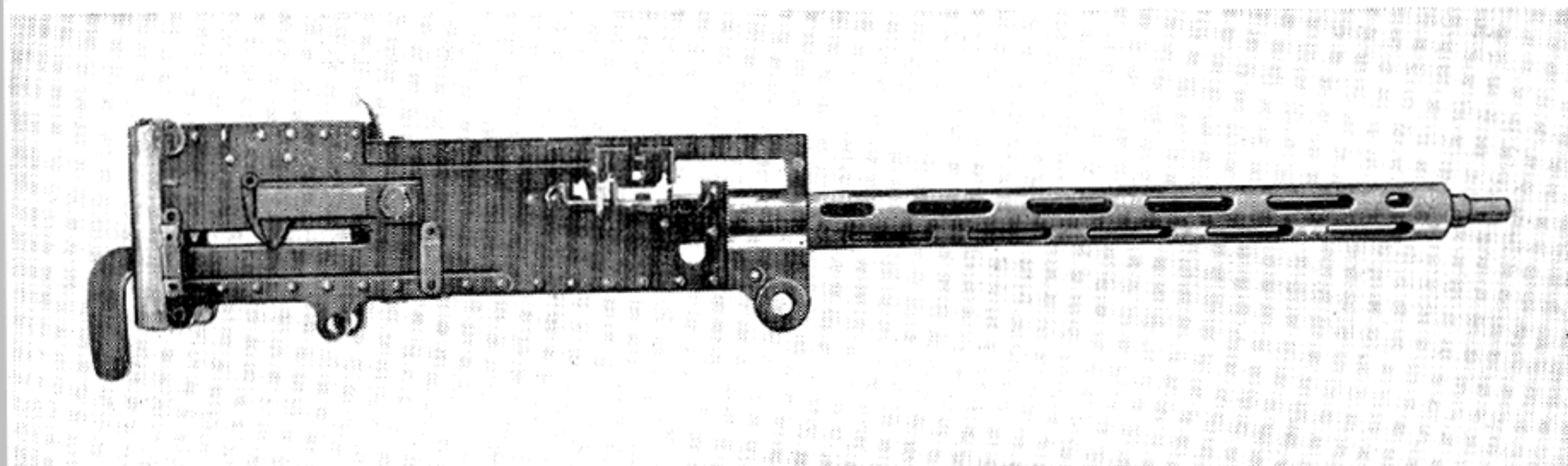

U. S. Aircraft Machine Gun, Model 1921, Cal. .30, Fixed.

ing aircraft machine gun, which shall avoid all the faults in design made apparent in the first lot of Browning machine guns manufactured on drawings prepared during the war. The Board is of the opinion that this project is correct and recommends that it be carried to its completion, that a sufficient number of model guns be constructed to give a thorough service test and that all data relative to tools, gauges, fixtures and manufacturing drawings, methods involved, etc., should be completed and filed in the Office of the Chief of Ordnance and held available for future manufacture.

"The following changes have been found necessary in the Browning aircraft machine gun as at present manufactured and these changes are being incorporated in the re-development project now being followed out by Springfield Armory.

"(a) Adapters. These properly locate the mounting pins in respect to the feedway. The rear adapter includes also the stirrup for the support of the bottom plate and the forward one includes a bearing for the rocker shaft unit of the Nelson synchronizing gear.

"(b) Operating slide and handle. To permit greater accessibility, so far as loading arrangements are concerned, to the pilot.

"(c) New firing mechanism.

"(d) Modification of latch to include a positive lock. It is very necessary, as in the event of the gun flying open under the vibration of necessity encountered in airplanes, a failure to fire would result and consequent stoppage.

"(e) Addition to link guide to the front cartridge stop.

"(f) Removal of front.

"(g) Provision of means to hold the cover extractor spring in place.

"(h) Alteration of the angle of the breech

lock cam and corresponding surface of the breech lock.

"From the original gun the following parts have been eliminated: (a) Mount adapters and rivets; (b) Elevating brackets and screws; (c) Cartridge stop, front and sear slide.

"The following parts are modified: (a) Barrel extension; (b) Bolt; (c) Cocking lever; (d) Cover; (e) Ejector; (f) Extractor cam; (g) Extractor cam plunger; (h) Latch; (i) Side plates; (j) Top plate; (k) Latch spring.

"The following new parts are added: (a) Bolt stud; (b) Cartridge stop, front, including link guide; (c) Included in (f); (d) Latch lock; (e) Operating slide and guides; (f) Firing mechanism; (g) Stirrup and rivets; (h) Trunnion adapters and rivets.

#### "Browning 11-mm Machine Gun for Aircraft Use

"A project has been initiated by the Ordnance Department . . . to develop a Browning 11-mm aircraft machine gun. The efficiency of this weapon depends entirely upon the efficiency of the ammunition. It would be a single purpose gun, probably used for the destruction of kite balloons. A short description of the 11-mm tracer incendiary ammunition, which would be the principal ammunition used with this gun, is as follows:

"The tracing incendiary composition consists of Barium Nitrate, Barium peroxide, powdered Magnesium and Carnuba Wax. The composition is contained in a round case bullet of brass hollowed out to receive it and is of such bulk that the bullet not only traces but has excellent incendiary properties. The muzzle velocity of the bullet is low, being about 2,000 feet per second, and the maximum trace is approximately 1,850 yards, varying from 1,300 to this figure. The

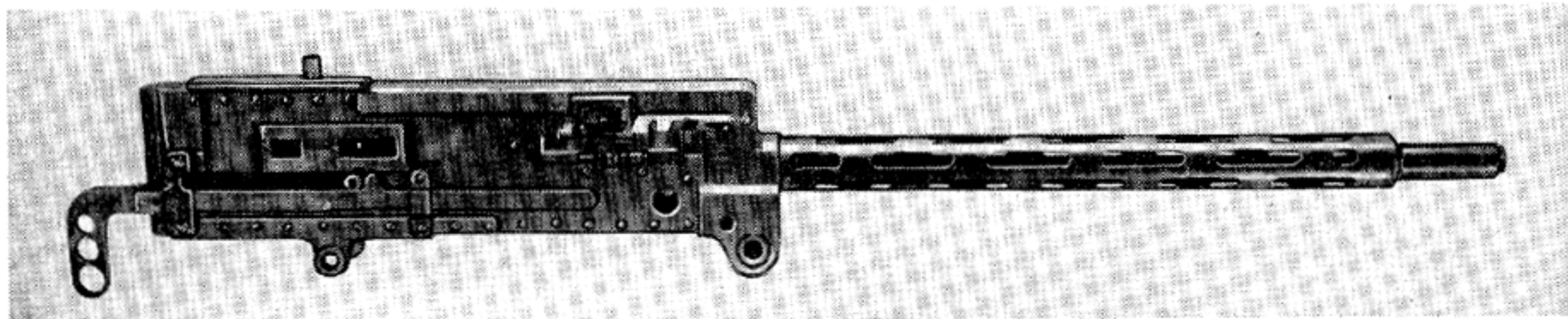

U. S. Aircraft Machine Gun, Model 1922, Cal. .30, Fixed. This Weapon Was Designed to Feed from the Left or Right Side.

maximum powder pressures developed are low, not exceeding 20,000 # per square inch. The case is of brass and has a flanged edge for extraction. The facilities exist in the United States for the manufacture of this cartridge and there are on hand 1,182,580 rds. of 11-mm ammunition which will become useless in the event that the 11-mm machine guns (Vickers) are recalled from service. Considerable experiments have been continued on the 11-mm ammunition. By virtue of the bulk of the projectile, it has been possible to develop a highly efficient explosive bullet.

#### "Browning Caliber .50 Aircraft Machine Gun

"A project for the development of the Browning caliber .50 aircraft machine gun has been initiated by the Ordnance Department and a contract has been placed with Colt Patent Fire Arms Company, of Hartford, Connecticut. The specifications of this gun as at present defined, give the following characteristics:

"Weight—50 #.

"Rate of Fire—500–600.

"Muzzle Velocity—2,700 ft/sec.

"Weight of Ammunition—1,830 grs. (about) (800 gr. bullet).

"Pounds per hundred rds.—26 (without links).

"Penetration—A. P. 1½" armor plate at 25 yds.

"This gun probably comes in a class of machine guns not peculiar to Air Service alone, and which are intermediate between the .30 caliber machine gun and small cannon. The tactical reasons for its development are as follows:

"(1) By virtue of the bulk of the projectile fired from this gun and the muzzle velocity with which it can be fired, it is anticipated that a

much more efficient armor piercing, tracer and incendiary bullet can be effected. An explosive bullet can also be developed much more easily than in the case of a smaller bullet, like the 150 gr. .30 caliber now in use.

"(2) It is to be anticipated that a machine gun to be efficient against aircraft of the future must be efficient against light armor plate. Armored planes were coming into being at the close of the war, both on the part of the Allies and Germans. Against armor capable of being carried by aircraft our .30 caliber ammunition would be of doubtful utility and of necessity we must go to higher calibers and higher muzzle velocities to obtain an effective ammunition for such combat.

"This statement might be thought to be incompatible with some of the recommendations of the Board. It should, however, be borne in mind that aerial combat in the future may consist of several kinds of aircraft specially built to attain certain altitudes: that is,

"(a) High flying scout planes which may attain an altitude from 15,000 feet up and of necessity must carry light weapons and light ammunition to keep down the military load and to obtain a maximum effectiveness from the motor at altitudes at which they may be expected to fly.

"(b) Other low flying pursuit, aerial surveillance and artillery observation and day bombardment planes, medium pursuit planes, not intended to fly at such heights may be able to carry heavier weapons and a heavier weight of ammunition. These planes are the ones which may be expected to encounter armored airplanes, and consequently should be equipped with guns having the characteristics of the proposed .50 caliber Browning aircraft machine gun. It will be seen then that this weapon is not

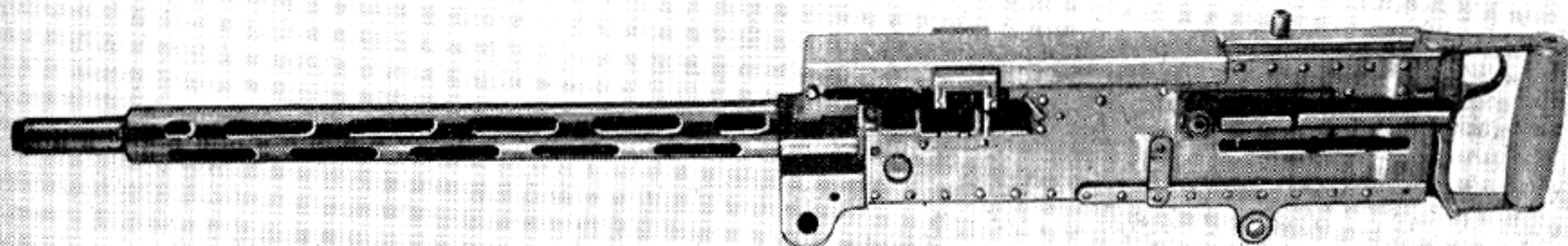

U. S. Aircraft Machine Gun, Model 1922, Cal. .30, Flexible. This Weapon Fired Over 20,000 Rounds in Test and Was Still Serviceable.

meant to replace the present existing .30 caliber weapons except in the case of planes working under 15,000 feet and so, as far as the general Air Service is concerned, should be classed as a special and additional weapon for which there will be a great deal of necessity. Work upon this gun has been undertaken by the Ordnance Department in connection with the development of a .50 caliber gun for ground and antiaircraft purposes. A priority has been established and approved by the Ordnance Committee as follows:

"(1) Aircraft .50 Caliber Browning Machine Gun.

"(2) Ground type .50 Caliber Browning Machine Gun.

"(3) .50 Caliber Tank Machine Gun.

"This priority is correct and it is thought that the aircraft gun should be given all possible preference.

"This development is not in such state now as to afford good grounds for any prophecy as to its ultimate efficiency. The Board has, however, examined all drawings available of the gun and of its ammunition and submits recommendations. . . ."

### Browning Aircraft Machine Gun, Caliber .30

Before the Armament Board's report had even been put in rough form, work was well under way to correct one of the main faults with the original models. This bad feature was that the weapon fed only from the left, no provision

being made to bring the cartridge belt from the opposite side. This made installation in planes quite a problem, especially where it was desired to place the weapons side by side.

Using one of the first guns completely modified according to specifications recommended by the Board, the project was begun at Springfield Armory. In a comparatively short time a prototype was finished to the point where its originators considered it ready for test. While the trial that soon followed showed numerous weaknesses: it did fire 10,000 rounds and, in order to avoid confusion, it was given the nomenclature, U. S. Aircraft Model 1921, Caliber .30.

Continued work was authorized not only to perfect the operating mechanism but also to incorporate a method of releasing the sear from the sides in order to synchronize by means of a solenoid. A second model embodying the desired features was ready in due time and 10,000 rounds were fired with only two breakages that require replacement. Half the ammunition was fed right hand and then the direction of feeding was reversed without incident.

This modified weapon was then sent first to Aberdeen Proving Ground, and following a successful trial, to McCook Field. After 20,000 rounds were expended, it was shipped again to Springfield where it was examined and found to be in good working condition. The experimental department recommended that with a few minor changes the model could be considered practically complete as far as specifications for this type of weapon were concerned. The only

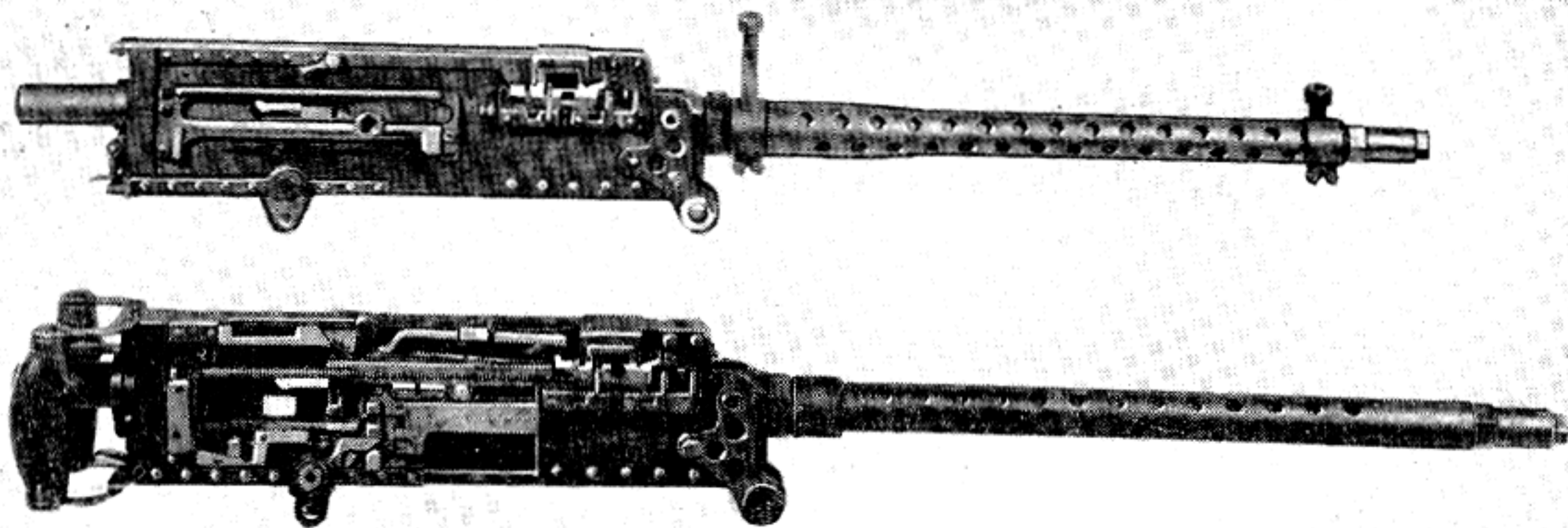

Top: Browning Aircraft Machine Gun, M2, Cal. .30, Fixed. Bottom: Browning Aircraft Machine Gun, M2, Cal. .30, Flexible (Sectionalized).

suggestion for further improvement was the addition of a rounds counter to inform the pilot of the amount of ammunition left in his feed boxes.

The weight of the gun was now 20 pounds and the rate of fire was officially set at 1,000 rounds a minute. In order to facilitate installation, numerous features were standardized so that it could be used fixed or flexible by changing the mounts. A method of placing twin guns on a Scarff ring was also worked out and specifications were written to take care of all future production.

During the period from 1927 to 1930 when Wright Field, Springfield Armory, and others continued to work on a light caliber .30 high-speed aircraft machine gun, no concise requirements had been prepared for inclusion in an official specification to cover military characteristics. These facts, as shown by the record, indicate considerable controversy as to what was wanted. When a real demand was shown in 1929 for such a gun to perform under the approved military demands, the Colt's Co. brought out the fully developed right- and left-hand feed gun that was later standardized as the Browning Machine Gun, Caliber .30, M2.

In developing this improved gun, every effort was made to retain the best features while simplifying manufacture. The type of steel that proved best was specified. Rivets were standardized, all being made with oval countersunk heads, wherever possible. Almost all basic dimensions were kept at an even fractional part of an inch and parts were designed for complete interchangeability in quantity production.

Everyone who worked on the project resulting in this M2 caliber .30 weapon deserves great credit for his contribution. By the late 20's it was a successfully tested weapon, capable of firing at the rate of 1,000 shots a minute. It could be fed from either right or left and seared off from the side by an electrically operated solenoid.

It is indeed fortunate that this work was done at the time, as practically all machine gun development stopped shortly afterwards, that is, as far as the United States was concerned. It was partly due to lack of funds but more from the

peaceful lethargy that invariably settles on this country after each war. In 1938 the caliber .30 Browning gun, better known as the B. A. M. G., was still being made in very limited quantities with the same specifications as the original Model M2. As a larger caliber machine gun was still looked upon by the Air Force as a special objectives weapon, the caliber .30 was its first-line machine gun for both fixed and flexible mounting as late as 7 December 1941.

### Browning Caliber .50 Aircraft Machine Gun

The Germans put a heavily armored plane into service during the closing days of World War I. This act made obsolete for all time the rifle-caliber machine gun for aerial use. Some countries were slower to accept the fact than others but nevertheless it cannot be disputed. The United States was among the first to come to this realization. The dramatic incident that caused it was the shooting down by such an aircraft of the young pilot, Quentin Roosevelt.

Gen. John J. Pershing, commander in chief of the American Expeditionary Forces, was among the first to see that the lightweight rifle caliber bullets would be ineffective against armored planes. With his characteristic promptness, he cabled the Army Ordnance Department to begin immediate development of a machine gun having a bore of at least a half inch with a minimum muzzle velocity of 2,700 feet per second.

At the time there was already under way an effort to use an 11-mm French cartridge in a Browning action, but when Pershing was informed that the velocity was not up to his requirements, he ordered renewed effort on the development of a larger cartridge and a higher bullet speed. The Browning caliber .50 machine gun that resulted was first made as a water-cooled weapon that later was lightened enough to be acceptable for aircraft use. The latter became known as the Browning aircraft machine gun, caliber .50, 1921. The water-cooled version also had the same model designation. In other words, for test purposes both a water-cooled and an aircraft caliber .50 gun were available and, while



First Trials of Browning Cal. .50 Machine Gun in Colt's Pasture. Fred Moore Firing the Weapon and John M. Browning Standing.

operating parts were interchangeable to a limited degree, this did not hold true for most of the costly and vital components.

This condition existed until Dr. S. G. Green (colonel during World War II), who is now chief of the Engineering Section, Small Arms Branch, Industrial Division of the Office of the Chief of Ordnance, Department of the Army, conceived and put into effect the design of what is known now as the Browning Machine Gun, Caliber .50, Basic M2. This devisement allowed the manufacture of one receiver that could be used on seven different types of guns: Army and Navy anti-aircraft water cooled, ground and turret-type heavy barrel, and fixed, flexible, and turret aircraft guns.

Dr. Green was awarded the Exceptional Civilian Award for his work prior to the war and the Legion of Merit for his outstanding commissioned service in World War II. There is no way to estimate the value of his contribution to

the Allied cause, as it allowed wholesale production of a single type of receiver that could be adapted in a matter of minutes to any specific use required.

The caliber .50 machine gun initially developed by John M. Browning at Winchester and further refined by Browning and Fred T. Moore at the Colt's plant resulted in its standardization in two forms, the Browning aircraft machine gun, caliber .50, M1921, and the Browning machine gun, caliber .50, M1921, water-cooled. The guns were manufactured and used experimentally as aircraft and anti-aircraft weapons between 1921 and 1937. They both had relatively lightweight barrels and the feed mechanisms were so arranged that the belts were fed from the left-hand side only. This meant that, when installed in pairs for either aircraft or anti-aircraft use, the mounting was unduly complicated. The caliber .50 ammunition available during this same period had a velocity of ap-

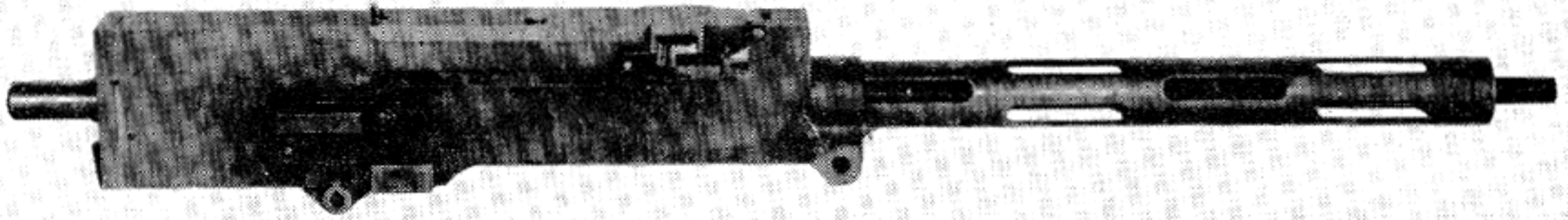

Aircraft Machine Gun, Model 1918, Cal. .50, Manufactured by Winchester Arms Company.

approximately 2,700 feet per second, identical with that of the caliber .30 ammunition.

The barrel of the water-cooled gun extended some 2 inches forward of the water jacket, which resulted in the muzzle becoming overheated when long bursts were attempted. The light barrels used on the aircraft caliber .50 machine guns also caused overheating after relatively short bursts. The weapon's limitations revealed in the early service trials of the water-cooled version raised a serious doubt with the Army and Navy during the period from 1927 to 1933 as to its potential worth either as an aviation gun or for anti-aircraft use.

In the years from 1927 to 1930 the armed services made many studies on the employment of Browning weapons for all conceivable uses. Many comparative trials were conducted in aircraft with the Browning aircraft machine gun, caliber .30, M1921, and similar anti-aircraft tests were made with the Browning machine gun, caliber .50, M1921, water-cooled. Limited experiments were also made with a heavy barrel type of the caliber .50 M1921 for arming combat vehicles.

No requirements were forthcoming prior to 1933 for an improved type of caliber .50 machine gun. The results of the past years were appraised and the problems given intensive study by Dr. Green between 1927 and 1932. The innovations disclosed were applied to a basic receiver and operating mechanism, which was so designed that seven principal types of caliber .50 Brownings could be readily assembled by the substitution of such parts as barrel jackets, barrels, and other items on aircraft, anti-aircraft, combat vehicle, or ground-type machine guns. The elements replaced or added to the assembled weap-

ons to adapt them to the specified use could be interchanged without the use of machine tools. No compromise, such as combinations, was made, and each complete assembly resulted in a superior gun for the required purpose.

The basic receiver had all the improved features, such as the right- and left-hand feed, and a new means was provided for obtaining a mechanical advantage in retracting the bolt. The strength of the driving spring and the weight of the barrel was increased to permit use of a more powerful cartridge, which allowed a longer barrel for maximum velocity and greater durability. The receiver and the fundamental operating mechanism were patterned after the caliber .50 heavy-barrel gun, developed earlier by Colt. It was indicated in 1932 that these advanced features developed by this firm, as represented by the pilot gun, and those developed by Dr. Green could be combined into a composite weapon that should and did give superior performance when used for the intended needs.

The Ordnance Department lacked funds in the period from 1927 to 1933 (as evidenced by the fact that not a single machine gun was manufactured in 1928) to undertake the development and production of a new type of caliber .50 gun for two basic reasons:

(a) The depression severely curtailed available funds.

(b) No requirement had been established for the development or manufacture of such a series of guns.

Consequently the limited funds available to the Army could not be spent for such a project. The Colt's Co., using components it developed on the heavy-barrel, air-cooled gun and the new

features developed by the Government, manufactured for the Ordnance Department in early 1933 two modified Browning machine guns, caliber .50 (later known as M1921A1); two Browning aircraft machine guns, caliber .50 (designated the M1921E2); and two improved Browning machine guns, caliber .50, heavy barrel. These were the first weapons to represent the combined innovations of the two models. They were tested at Aberdeen Proving Ground, Frankford Arsenal, Fort Monroe, and Wright Field, and were also demonstrated at the Naval Proving Ground, Dahlgren. Test results were most favorable and interest in the improved caliber .50 Browning was greatly intensified. When invited to furnish a complete set of ordnance drawings, the Colt's Co. suggested that their preparation at Springfield Armory from the firm's drawings, would be more economical.

During 1932 Gen. Samuel Hoff, Chief of Ordnance, Army, after observing concentrated activity on Dr. Green's part day after day, jokingly asked for an explanation. He replied that an attempt was being made to solve a problem having great bearing on the future of the caliber .50 machine gun, even though no requirement had been presented to the Ordnance Department. In order to do so, it might be necessary to apply the famous quotation by Thomas Car-

lyle framed on Dr. Green's desk—"He who would accomplish much must concentrate to such an extent that to the idle observer it borders on insanity." The general was also shown another saying, credited to Edison, which read: "I always do my best work when other people tend to their own business by going to sleep."

The Army, in 1933, without funds to carry forward the development of a complete series of new caliber .50 machine guns, interested the Navy in the results of the previous tests of both the aircraft and antiaircraft, water-cooled models. With the approval of General Hoff and Maj. Julian S. Hatcher (now major general, retired), Chief of Small Arms Division, Manufacturing Service, Ordnance Department, contact was made by Dr. Green with Commanders John J. Mahoney, Edgar R. McClung and Forrest P. Sherman (now admiral, Chief of Naval Operations), all of the Bureau of Ordnance, Navy Department, to determine whether they would be interested in the improved weapons. They responded enthusiastically and arranged for an early demonstration at the Naval Proving Ground, Dahlgren, Va. Commander Malcolm F. Schoeffel (now admiral) and Commander George F. Hussey, Jr. (later chief of the Bureau of Ordnance, Navy, now admiral, retired) were most interested in testing the new guns and aided

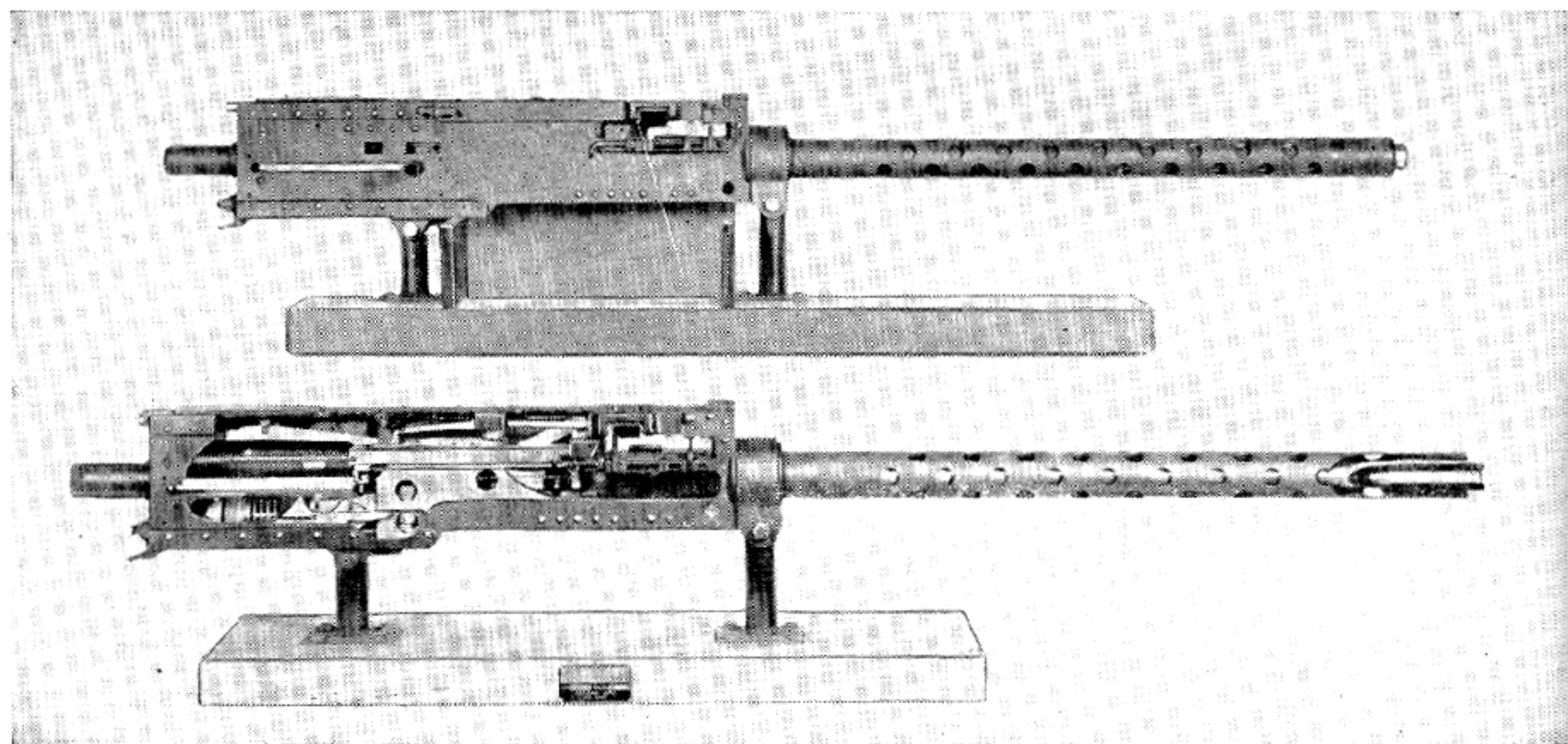

Top: Aircraft Machine Gun, Cal. .50, M2, Fixed. Bottom: Aircraft Machine Gun, Cal. .50, M2, Fixed (Sectionalized).



materially in their early standardization for both the Army and Navy.

Further conferences were held with Commanders Sherman and Mahoney, who took the matter up with Admiral E. B. Larimer, Chief of the Bureau of Ordnance, Navy. The latter not only approved assistance in further research on aircraft and antiaircraft caliber .50 M2 machine guns but authorized an immediate expenditure in 1932-33 of approximately \$150,000 to be used in the development and supply to the Navy of as many weapons as possible with the funds available. The Navy placed orders early in 1933 with the Ordnance Department of the Army for the manufacture by Colt of the basic M2 type improved caliber .50 machine guns. Navy funds were used for compiling data needed for drawings, manufacturing requirements, such as descriptions of procedures, technical notes, etc., later to be used in training manuals and maintenance work. These data were obtained by War Department personnel at the Colt's plant, where the many problems relating to production and manufacturing improvements were solved jointly by company and government representatives.

The support given by the Navy in the program was of material benefit in compiling instructional material, such as standard nomenclature lists, training manuals, specifications, and Government drawings during the development period at the Colt's Co. and at Springfield Armory. The funds made available by the Navy made it possible to set up a firm policy for preparing, first, basic drawings, and then establishing tolerances to govern both manufacture and final inspection. Colt's contribution with respect to the latter was outstanding, as evidenced by the very successful use of the Government drawings during World War II. More than eight major manufacturers produced interchangeable machine guns and components that gave outstanding performance, even though they were made in great quantity.

The development, pre-manufacturing study and production engineering during the initial manufacture of the caliber .50 M2 Browning machine gun were made possible by the unexcelled teamwork among Navy and Army Ordnance personnel, Springfield Armory, and the Colt's Co. The interest and support given by

Admiral Larimer, Commanders Sherman, Schoeffel, Mahoney, and McClung, and by Navy financing made it possible to prepare a comprehensive and positive program to cover all phases of the problem. The work of Fred T. Moore, general works manager of the Colt's Co., and many of its production and design engineers, and by Maj. Guy H. Drewry (now general, retired), Mr. Hopkins, Mr. Ambrose, and other engineering personnel at Springfield Armory, was outstanding in the preparation and coordination of engineering data obtained for the most part from Colt's Co. and from Dr. Green, who worked at Springfield and at Colt's in directing the over-all program.

The restudies made during production engineering reviews included a consideration for the first time of building into an automatic weapon a measured reserve to insure reliable functioning under adverse conditions. A belt lift of 17 pounds was established as a minimum, it being appreciated that longer belts would be needed to obtain the full potential of this new type of gun. This was the first time that any automatic weapon had included in its specifications and drawings a definite measurable performance. This requirement was later increased to some 35 pounds by the Colt's Co. and the High Standard Manufacturing Co., working with Captain Adams of the British Service, when the increased throw of the belt feed slide was provided along with a wider cover.

The back plate was also replaced by one of much larger diameter, using Belleville washers of the type developed by the Colt's Co., the Fabrique Nationale, Mr. Hopkins of Springfield Armory, and Dr. Green.

Highly favorable reports were received from the battle areas of North Africa, Sicily, and on the continent of Europe on the caliber .50 guns, which showed that they were most reliable and their performance outstanding. A typical report is one received from the commanding general of the Army Air Forces (in November 1943) which states in part:

"1. The Commanding General of the Army Air Forces, with the full realization of the many outstanding achievements of the Ordnance Department in developing and producing large

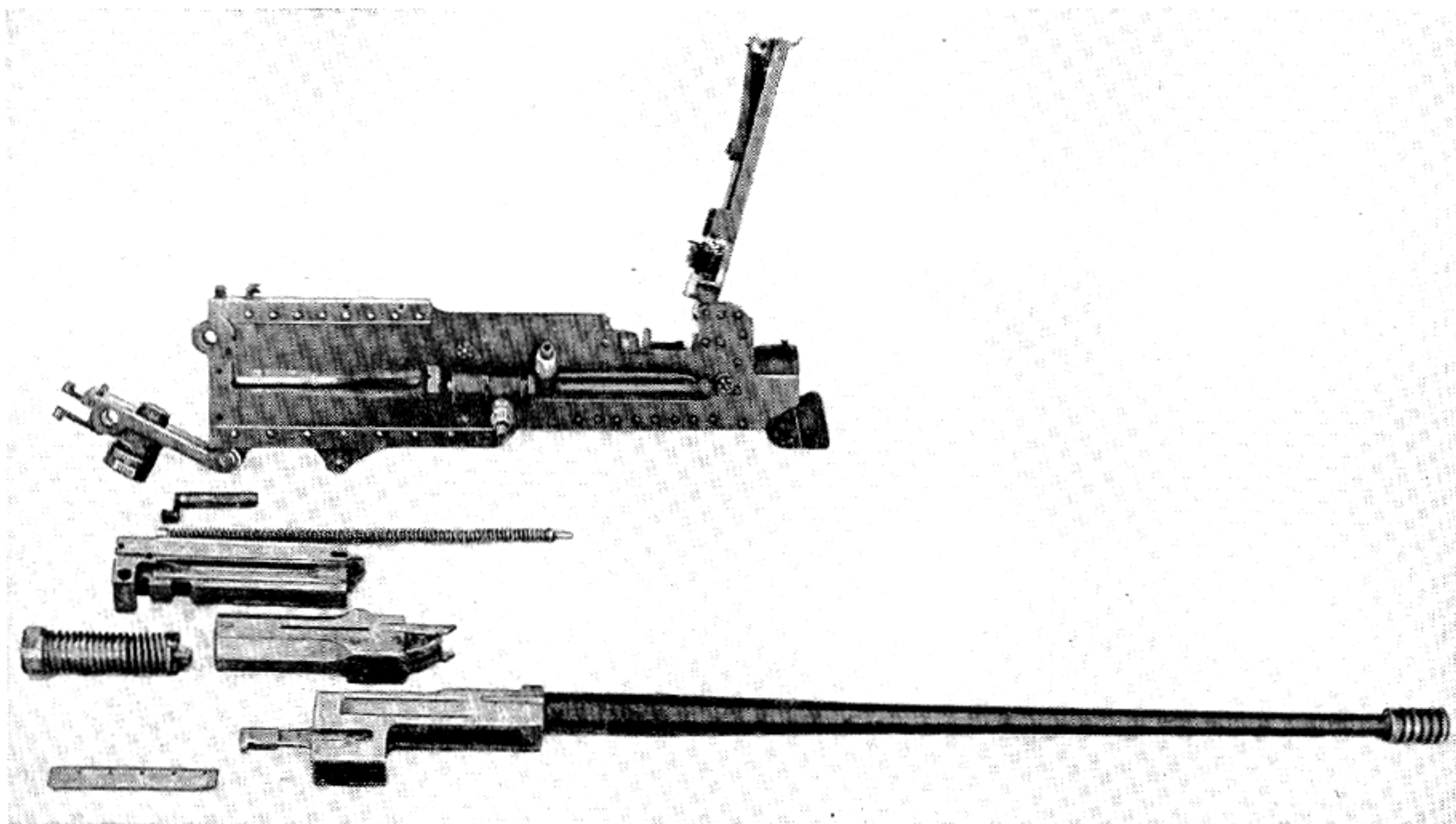

Japanese Copy of the Browning Aircraft Machine Gun, Cal. .50, Type 1941, Fixed.

quantities of outstanding equipment for the United States Forces, wishes to specifically commend the Ordnance Department of the Army Service Forces for the magnificent achievement in furnishing the Army Air Forces with the most outstanding aircraft gun of World War II, namely the Caliber .50 Aircraft Machine Gun.

"2. This weapon, together with its ammunition, is the backbone of offensive and defensive guns for American aircraft and was brought to such a state of perfection by the Ordnance Department during the years of peace prior to the present conflict that it has enabled the Army Air Forces, the U. S. Navy, and Marine Corps to show a definite superiority in aircraft gun power throughout this global war."

Similar reports were received from the Army Air Forces Matériel Command during the last phase of the Tunisian campaign, where 72 enemy airplanes were destroyed with less than 200 rounds per gun expended on 35 fighter planes without a single machine-gun stoppage. M2 guns mounted on trucks also gave a good account of themselves and often supplied the sole means of protection of small supply convoys. A typical action shows that the drivers brought down two

of five attacking enemy planes and scattered the remaining three.

The Navy and Marine Corps also had many reports of the Browning's excellent performance at Bougainville, Guadalcanal, and all other major operations. One such observation was the report of Capt. Malcolm F. Schoeffel (now admiral) to the Bureau of Ordnance, Navy, which showed that during a cruise of the *Saratoga* some 200,000 rounds of caliber .50 ammunition were fired with only two serious jams, and two dozen stoppages of all types. Captain Schoeffel declared that, although one of the purposes of his inspection trip in the Pacific was to locate troubles, he had difficulty finding them because of the high performance of the weapon.

A typical comment from the Armed Services Joint Report was:

"It is gratifying to note the acclaim with which the Caliber .50 Machine Gun is being received, for it is felt that this reflects, in a great measure, the efforts that have been expended in producing and accepting only quality weapons."

In World War II the M2 was produced by the following industrial firms: Colt's Patent Fire Arms Co., High Standard Co., Savage Arms

Corp., Buffalo Arms Corp., Frigidaire, AC Spark Plug, Brown-Lipe-Chappin, Saginaw Divisions of General Motors Corp., and Kelsey Hayes Wheel Co.

The translation of the new designs into a producible and dependable series of weapons by mass production methods showed that the groundwork and coordinated effort by the Army, Navy, and Industry team were well done and in a comprehensive form. Even though the production engineering data, drawings, and other information were in excellent shape, industry made a real contribution by applying new techniques with improved machinery, such as high speed broaching and multiple tools for performing rapidly many operations previously done separately.

### Cycle of Operation

The following cycle of operation is for the Browning machine gun, caliber .50, basic M2, but with minor deviations to compensate for a difference in caliber, it will also cover the entire family of Browning short-recoil-operated machine guns.

When the trigger is pressed, the trigger bar pivots on its pin, causing the front end to press down on the tip of the sear. Its notch is disengaged from the shoulder of the cocked firing-pin extension, allowing it to fly forward and fire the chambered round. At this instant the barrel, barrel extension, and bolt, known as the recoiling portion, are in battery position.

The bolt is held securely in place by the breech lock, which extends up through the barrel extension into a notch in the underside of the bolt. After the powder charge explodes and the bullet starts to travel through the bore, the force of the explosion drives the operating parts rearward. During the first three-quarters of an inch of travel the breech lock is pushed off the breech lock cam step and out of the notch in the bolt by action of the breech lock depressors. This frees the bolt. As the recoiling portion continues to move back, the barrel extension rolls the accelerator rearward. The tip of the accelerator claws strikes the lower projection on the bolt and speed this part to the rear. The barrel and barrel extension have a total rearward travel of



Loading Cal. .50 Ammunition on an F6F Aboard the USS Saratoga.

$1\frac{1}{8}$  inches at which time they are completely stopped by the oil-buffer body assembly.

During this movement the oil-buffer spring is compressed by the barrel-extension shank. The spring is locked in this retracted position by the claws of the accelerator which are moved against the shoulders of the barrel-extension shank. The action of the oil in the buffer tube aids the spring to cushion the shock of recoil of the barrel and barrel extension. During the rearward travel the piston head is forced back from the forward end of the oil-buffer tube. The oil at the rear of the tube under pressure of the piston head and valve escapes to the front. Its only path is through restricted notches between the edge of the piston-rod head and the oil-buffer tube.

The bolt travels rearward for a total of  $7\frac{1}{8}$  inches. During this movement the nested driving springs are compressed. The rearward stroke of the bolt is finally stopped as it strikes the buffer plate and compresses the fiber discs to the

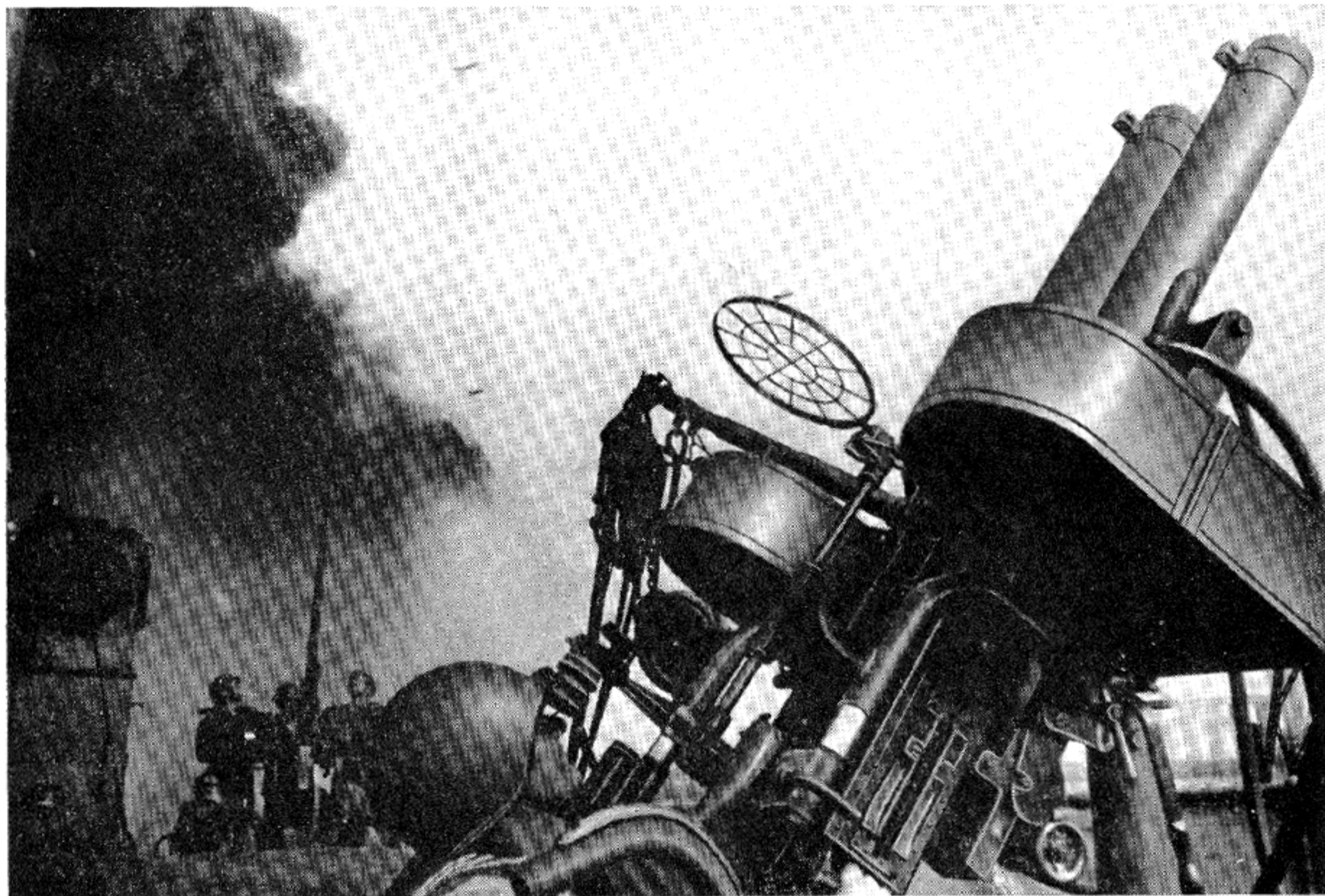

Browning Machine Gun, Cal. .50, Water Cooled, in Action as Antiaircraft Defense.

extent of one-eighth of an inch. Thus, part of the recoil energy of the bolt is stored in the driving springs and the remainder in the back plate buffer assembly.

After completion of the recoil stroke the bolt is forced forward by the energy stored in the driving spring and the compressed buffer discs. When the bolt has moved forward about 5 inches the top of the accelerator is struck by a projection on the bottom of the bolt. As the accelerator rolls forward from this blow, its claws are moved away from the shoulders of the barrel-extension shank to release the oil-buffer spring. The energy of the spring shoves the barrel extension and barrel ahead.

No restriction to motion is desired on the forward or counterrecoil stroke of the barrel and its extension; therefore, on the stroke additional openings for oil flow are provided in the piston rod head of the oil buffer assembly. The piston valve is forced away from the piston rod head .050 inch as the parts move forward, uncovering

other openings. The resulting larger flow permits oil to escape freely through the ports in the piston valve as well as at the edge of the piston next to the tube wall.

As the barrel extension moves forward, the breech lock contacts the breech lock cam and is forced upward. The bolt, which has been continuing its forward motion after striking the accelerator, has now reached a position where the notch on its under side is directly above the breech lock, thus permitting the latter to engage its locking recess. The bolt is thereby locked to the breech end of the barrel extension three-quarters of an inch before the counterrecoiling parts reach their final forward position.

The act of cocking the gun is begun as the bolt starts to recoil immediately after firing. Thus the tip of the cocking lever, which is in the V slot in the top plate bracket, is forced forward. The lever is pivoted so that the lower end forces the firing-pin extension rearward. The firing-pin spring is thus compressed against the sear-stop

pin. The shoulder at the back end of the extension is hooked over the notch at the bottom of the sear under pressure of the sear spring. During the final forward motion of the bolt the tip of the cocking lever enters the V slot of the top plate bracket. This action swings the bottom of the lever out of the path of the firing pin extension, allowing space for the pin to snap forward to fire the cartridge.

When the counterrecoiling portion is one-sixteenth of an inch from battery, the gun is ready to fire. If no trigger action is given at this instant, the operating parts assume final forward position and the gun ceases operation.

The belt-feed mechanism is actuated by the bolt. The ammunition belt is pulled into the

gun by the pawl which is attached to the belt-feed slide. When the bolt is in battery, the belt-feed pawl has positioned a cartridge directly above the chamber. The belt-holding pawl is in a raised position behind the incoming round to prevent the ammunition belt from falling out of the gun.

As the bolt recoils, the belt-feed slide is moved out over the belt, and the belt-feed pawl pivots so as to ride over the next cartridge. At the end of the recoil stroke the throw of the belt-feed slide is sufficient to permit its pawl to snap down behind the incoming link in order to pull the belt into the gun. As the bolt moves forward on counterrecoil, the belt is pulled into the gun by the leverage exerted on the belt-feed pawl. The

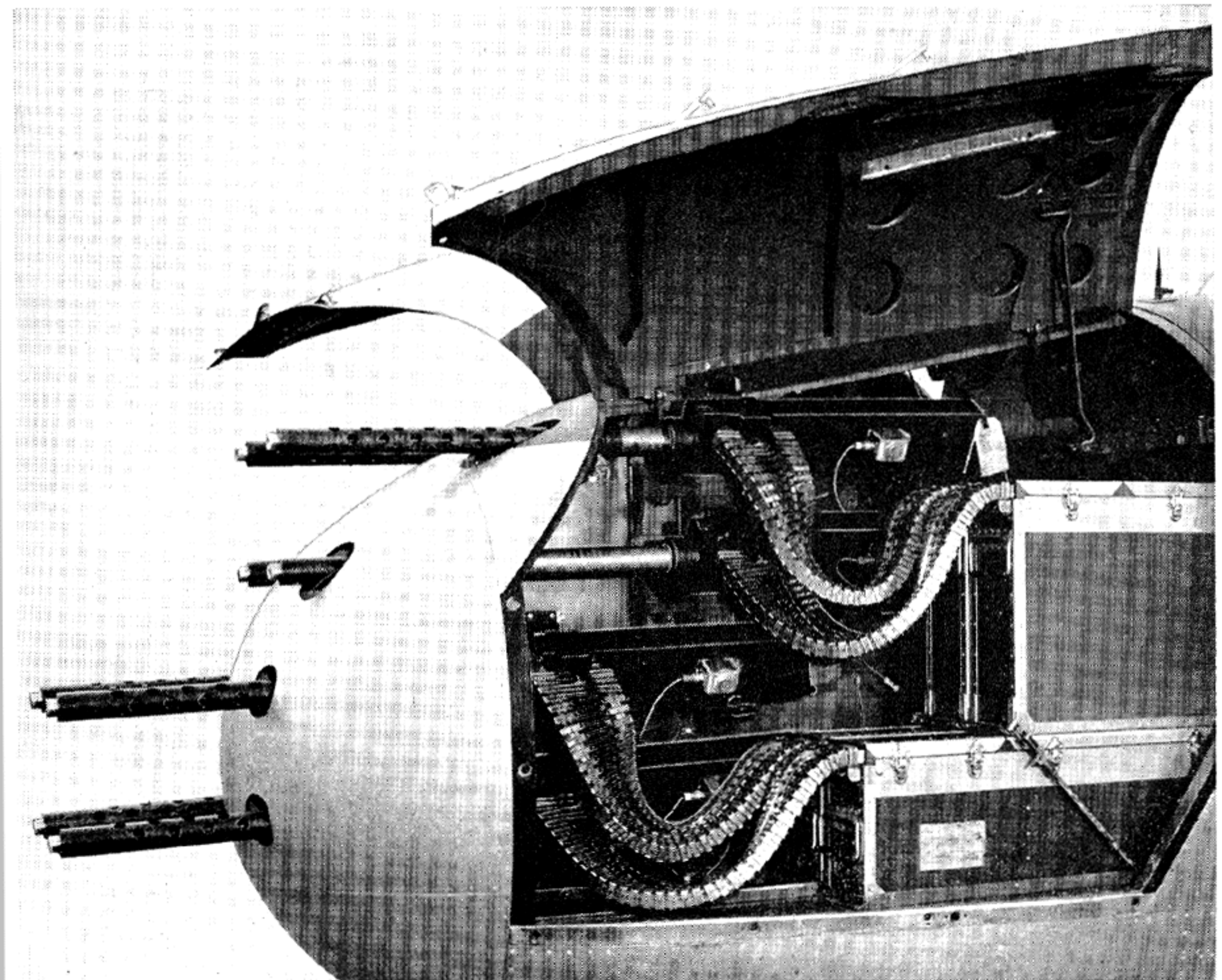

"Eight-Gun Nose" Installation for B-25 Aircraft. Each Browning Cal. .50 Is Provided with 400 Rounds of Ammunition for Ground Strafing.

belt-holding pawl is forced downward as a cartridge is pulled over it. When the forward stroke of the bolt is completed, the belt-holding pawl snaps up behind the next round and performs the function of retaining the belt in the gun.

As recoil starts, a cartridge is drawn from the ammunition belt by the extractor claw. At the same time the empty case is withdrawn from the chamber with its cannellure held in the T slot on the front face of the bolt. The empty case, having been expanded by the force of explosion, tends to stick to the walls of the chamber and the case may be torn if withdrawal is too rapid. To prevent this and to insure slow initial extraction, the top front edge of the breech lock and the front side of the notch in the bolt are beveled. Thus, as the breech lock is totally disengaged, the bolt first creeps away from the barrel and barrel extension in a gradual manner.

The cover-extractor cam now begins to force the extractor down, causing the round to enter the T slot in the bolt. As the extractor is moved, the lug on its side rides against the top of the switch, causing it to pivot downward at the rear. Near the end of the bolt's movement the extractor lug overrides the end of the switch, which then snaps back to its normal position.

On counterrecoil the extractor is forced farther down until halted by the extractor stop pin as the lug then rides forward under the switch. The incoming round in the T slot ejects the empty case. The extractor stop pin in the bolt serves as a means of positioning the incoming round, so that the cartridge, assisted by the ejector, enters the center of the chamber. When the cartridge is nearly seated, the extractor rides up its cam, compresses the cover extractor spring and its claw snaps over the cannellure of the cartridge in the feedway.

For automatic firing the trigger is pressed and held down. The sear is depressed as its tip is carried against the beveled surface of the trigger bar by the forward movement of the bolt near the end of the counterrecoil stroke. The notch in the bottom of the sear releases the firing pin, thus automatically firing the next cartridge at the completion of the forward stroke. The gun will operate automatically as long as trigger action is maintained and until the ammunition supply is exhausted.

## The B. A. R. Since World War I

Following World War I, the exclusive rights to manufacture the B. A. R. (Browning Automatic Rifle) reverted to the Colt's Co. The Belgian Fabrique Nationale d'Armes de Guerre at Herstal, Belgium, was licensed in 1920 to manufacture and distribute the weapon in Europe, under the name Herstal light machine gun, along with many other Browning-designed guns.

In 1922 the United States Army brought out the Cavalry model 1922 machine rifle. This version of the B. A. R. had a heavy ribbed barrel, a bipod and an adjustable stock rest. A different rear sight from that of the model 1918 was utilized. The gun was never issued in great numbers.

Colt put the gun out in two commercial models. One was a military-type gun, equipped with a pistol grip and a light bipod fastened to the gas cylinder at its junction with the barrel. A number of foreign governments purchased this arm in considerable quantities. Another model of the B. A. R., called the Colt Monitor, was offered in 1933 as a police and bank-guard weapon. It was modified by a shortened barrel, the attachment of a Cutts compensator and addition of a vertical pistol grip. A number of these weapons appear to have fallen into the hands of criminals, judging from seizures made by the F. B. I.

Numerous foreign governments have employed the B. A. R. The Fabrique Nationale produced in 1921 a Swedish Army 6.5-mm model, having a vertical pistol grip and a slightly curved magazine. It is reported that a limited number in caliber 7.5-mm were manufactured by the Belgian plant for France or Switzerland or for the oriental trade.

After the 1914-18 war and up to 1936, the British tested the weapon and in 1922 provisionally designated it as the light machine gun to be produced in the event of another war. Later the Bren gun was standardized for the caliber .303 cartridge to fit this need. England's home guard was fitted with B. A. R.'s from the United States during the invasion peril of 1940 and 1941.

The Polish Army was supplied with the FN model 1928 B. A. R., firing the 7.92-mm Ger-

man Army type cartridge. And B. A. R.'s bearing the patent date 1932 were captured from the Japs in the 1942 Philippine campaign. These weapons had a 21-inch barrel of 7.7-mm caliber. The principal difference from American types was the hinged piston rod and forearm, permitting rapid removal of the gas cylinder.

The latest version of the B. A. R., which was supplied to United States armed forces in World War II, is the B. A. R. Model M1918A2. Weighing 19 pounds, it is heavier than the earlier models and is fitted with a flash hider and a medium-weight bipod at the muzzle. A conventional butt-stock without pistol grip is used. A decelerating device which can be thrown on and

off allows a high and low cyclic rate of fire. There is no semiautomatic fire from this model, but the low rate of fire is such that single shots can be discharged easily by pulling and quickly releasing the trigger. There is no readily changeable barrel, so delivered fire is limited to what one barrel can stand in any brief period.

#### Models of Browning Recoil-Operated Machine Guns

The following tabulation lists the various models and bores of Browning recoil-operated machine guns that have been produced for use by the nations of the world:

Name	Country	Designation	Bore
Browning ground	U. S. A.	Model 1917	.30/06
Browning ground	U. S. A.	Model 1917A1	.30/06
Browning training	U. S. A.	M1	.22
Browning tank	U. S. A.	M2	.30/06
Browning training	U. S. A.	M3	.22
Browning training	U. S. A.	M4	.22
Browning tank	U. S. A.	M1919	.30/06
Browning tank	U. S. A.	M1919A1	.30/06
Browning cavalry	U. S. A.	M1919A2	.30/06
Browning gen. purp.	U. S. A.	M1919A3	.30/06
Browning gen. purp.	U. S. A.	M1919A4 early	.30/06
Browning gen. purp.	U. S. A.	M1919A4 later	.30/06
Browning tank	U. S. A.	M1919A5	.30/06
Browning ground	U. S. A.	M1919A6	.30/06
Springfield ground	U. S. A.	Experimental	.30/06
Rock Island ground	U. S. A.	T13	.30/06
Colt ground	U. S. A.	Experimental	.30/06
Browning ground	U. S. A.	M1919 w/c	.30/06
Browning aircraft	U. S. A.	M1918	.30/06
Browning aircraft	U. S. A.	M1918	11 mm
Browning aircraft	U. S. A.	M1918M1	.30/06
Browning aircraft	U. S. A.	M1919	.30/06
Browning aircraft	U. S. A.	M1921	.30/06
Browning aircraft	U. S. A.	M1922	.30/06
Browning aircraft	U. S. A.	M2	.30/06
Browning infantry	Mexico	M1919	7 mm
Browning infantry	Argentina	M1928	7.9 mm
Browning infantry	Poland	M1930	7.9 mm
Browning	Bolivia	Commercial type	7.65 mm

Name	Country	Designation	Bore
Browning infantry	China	Commercial type	7.9 mm
Browning ground	Norway	M1929	7.9 mm
Browning ground	Norway	M1929T	7.9 mm special
Browning ground	Sweden	M1936	6.5 mm
Browning ground	Sweden	M1936	7.9 mm
Browning ground	Guatemala	M1924	7 mm
Browning ground	Guatemala	M1942	.30/06
Browning tank	Japan	Type 4	7.7 mm
Browning tank	Japan	Type 97	7.7 mm
Browning aircraft	Norway	M1929	7.9 mm
Browning aircraft	Greece	M1937	7.9 mm
Browning aircraft	France	Commercial type	7.5 mm
Browning aircraft	England	Mark II	7.7 mm
Browning aircraft	England	Mark II*	7.7 mm
Colt ground	Commercial	MG 38	Various
Colt ground	Commercial	MG 38B	Various
Colt aircraft	Commercial	MG 40	Various
Colt ground	Commercial	MG 52	.50
Colt ground	Commercial	MG 52A	.50
Colt ground	Commercial	MG 52-2	.50
Colt aircraft	Commercial	MG 53	.50
Colt aircraft	Commercial	MG 53A	.50
Colt aircraft	Commercial	MG 53-2	.50
Browning	Commercial	FN	.50
Browning	Commercial	FN	13.2 mm
Browning AA	U. S. A.	M1921	.50
Browning AA	U. S. A.	M1921A1	.50
Browning AA	U. S. A.	M2	.50
Browning AA	U. S. A.	M2 Navy special	.50
Browning aircraft	U. S. A.	M1921	.50
Browning aircraft	U. S. A.	M2	.50
Browning aircraft	U. S. A.	M2 Navy special	.50
Browning ground	U. S. A.	M2 HB	.50
Browning	U. S. A.	M2 HB Navy special	.50
Browning aircraft	U. S. A.	M2 TT	.50
Browning aircraft	U. S. A.	M3	.50
Browning ground	Guatemala	M1924	.50
Browning ground	Guatemala	M1942	.50
Browning aircraft	Japan	Model 1	.50



## HOTCHKISS AIRCRAFT MACHINE GUN

## Aerial Uses of the Hotchkiss

The French were in many ways leaders in military aviation. One of their most creditable achievements was not being misled by the blind faith in dirigibles that was sweeping other countries. While the civilian population was terrified by them, military men always contended that the huge size of the airships would bring about their own destruction. In the matter of arming aircraft, while not the first to fire a machine gun from a plane, the French most certainly capitalized early on this accomplishment.

Two years before World War I a French Deperdussin monoplane had a machine gun permanently mounted on a post arrangement from which the observer located in front of the pilot could rise and fire over the propeller arc. As the gunner stood inside the rail, he was also partially protected by 4 millimeters of steel armor. This contrivance was originated by a M. Loiseau. Later the first public demonstration took place in February 1914 before high army officials at Villacoublay near Paris. The pilot for the occasion was Lieutenant Prevost, with M. Loiseau, the designer, acting as observer gunner.

The arrangement consisted of a machine gun attached in a yoke to a support braced to the mast and fuselage, with a high enough support to enable the gunner to fire forward over the propeller even with considerable depression. The operator was encased in a shield of light armor and had a light railing around the sides and rear. Even with these safety precautions he was still in danger, not only from falling out of the airplane, but from exposure to enemy fire.

The pilot's view was likewise obscured, even with small sections cut out of the trailing edges of the wings adjacent to the fuselage to allow him more visibility downward. Regardless of its clumsy appearance, it was at least an attempt to mount a machine gun permanently on a war

plane. It was thought to be the only possible way to maneuver a weapon so as to fire forward of the propeller.

Even this method was not altogether original. There had been earlier experiments with a Nieuport plane where the observer merely stood up in his seat, braced his elbows on the upper wing and fired a repeating shot gun or military rifle forward in the same manner. However, in the Deperdussin plane the weapon was a mounted machine gun and the date, 11 February 1914, marked the first instance of a military plane with a permanently installed forward-firing machine gun. The weapon selected as the most suitable for aviation use was the light, or

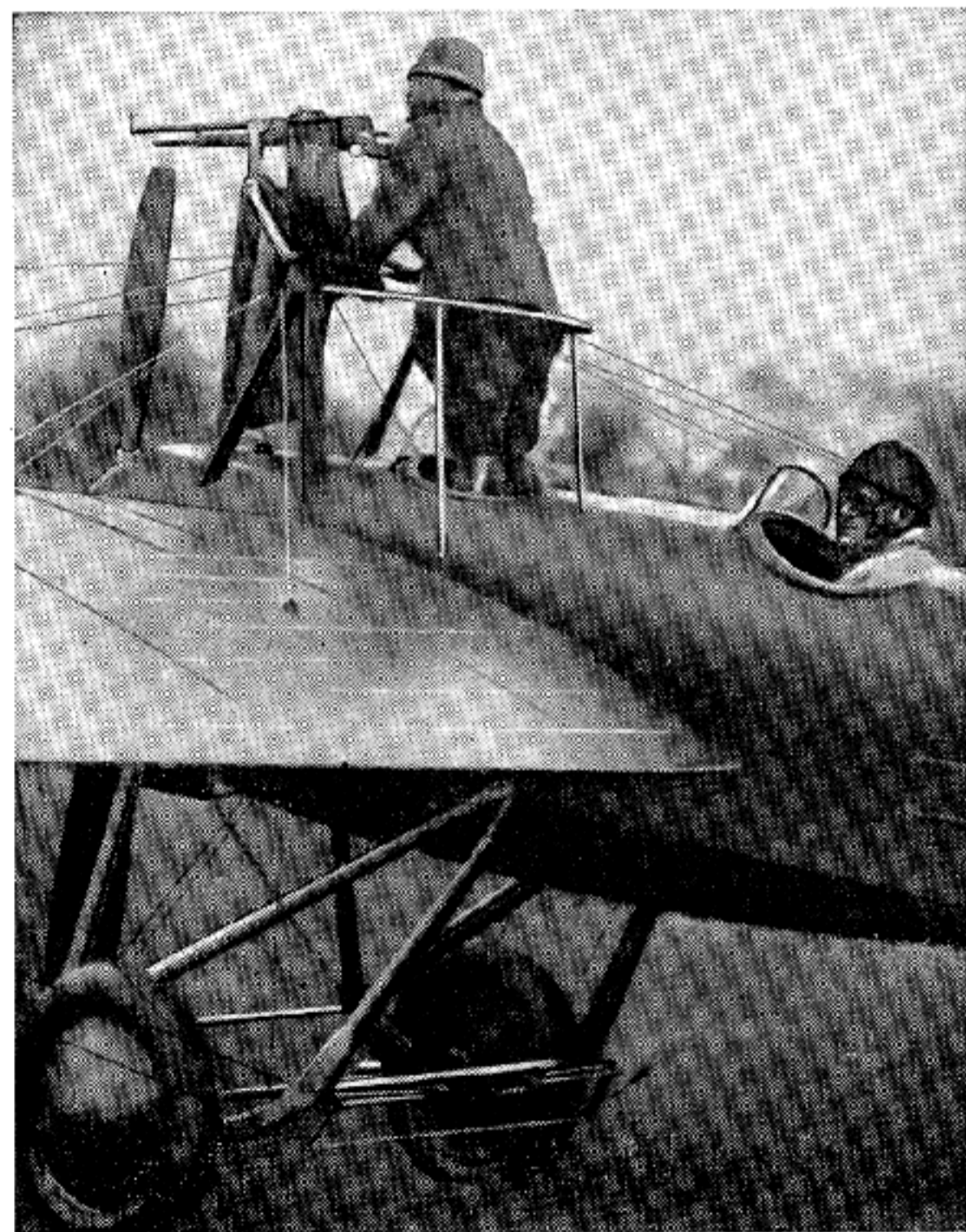

Firing the Benét-Mercié Machine Gun from a Deperdussin Airplane, 1914.

"portative," Hotchkiss, better known in the United States as the Benét-Mercié.

Nothing was done to the weapon itself to make it more adaptable for aircraft use, but in other instances it was modified to feed by a belt in lieu of the strip feed. The time-honored system of having the belt and cartridges rolled on a drum and all attached to the weapon's receiver was used so as not to interfere with its flexibility.

An interesting sidelight in connection with this test is the relationship of the Deperdussin plane to the famous Spad machine, the finest Allied fighting aircraft in World War I. Armand Deperdussin was a French silk dealer who was reputedly very wealthy. He took to making fast airplanes as a hobby in 1911 and spent so much money on them that he went bankrupt. When his affairs were investigated, he was sent to jail for fraudulent transactions in silk.

Deperdussin was languishing in prison when

one of his machines won the Gordon Bennett Cup in 1913 for flying at the record-breaking speed of 124.8 miles per hour. The pilot and others of the racing team sent a sentimental telegram of congratulations to their "bon patron" behind the bars.

Soon after the outbreak of the war M. Bleriot another famous French pioneer of the air, took over the Deperdussin business to preserve the organization and staff of the firm. It then became known as the Société Pour les Appareils Deperdussin, from which the initials S. P. A. D. are derived. The plane was developed and perfected so that it became the one machine that assured the Allies air superiority in the war. It was fitted with an eight-cylinder Vee-type water-cooled Hispano-Suiza motor. This solid, fast and highly maneuverable plane carried twin synchronized machine guns and later was outfitted with one of the first air cannons.

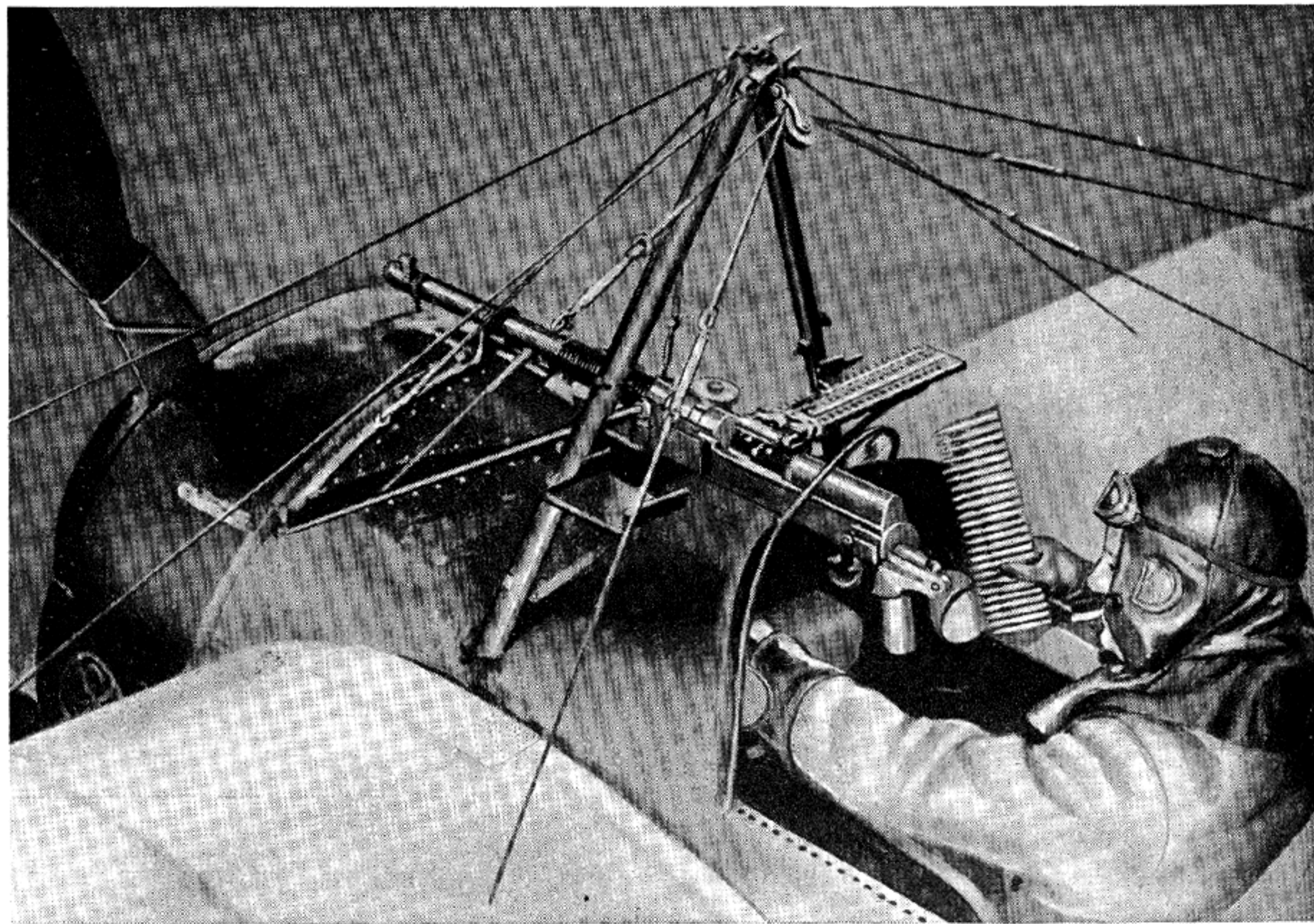

Benét-Mercié Machine Gun Firing Forward. The Propeller is Protected by a Deflection Plate Originated by R. Garros.

The science of military aviation was much farther along in France than it was with her English ally when war was declared by Germany in 1914. This was true not only with respect to the facilities at hand but likewise to pilots.

Of the earliest French fighter pilots one of the outstanding figures was Roland Garros, an airman of superb skill and daring. As early as 1912 he set an altitude record of 15,000 feet. During the war he had many exciting aerial fights ranging from the throwing of missiles to the use of the machine gun. It did not take him long after carrying the Hotchkiss Portative with him as a free gun to see the great possibilities of being able to fire straight ahead through the propeller arc. All pilots no doubt had noted the same thing before, but Garros was the type to do something about it immediately.

Early in 1915 he had his ordnance men mount directly in front of him a clip-fed Hotchkiss Portative machine gun. He had found out from confidential British reports on firing a machine gun forward through the air screw arc that with a normal rate of fire only 2 percent of the bullets struck the blade.

To the practical-minded Garros the solution of the 2-percent factor seemed simple. He fashioned two tempered pieces of triangular metal that could be clamped on the propeller so that when the blade was turned until the metal pieces faced the bore of the gun, it formed a pyramid. The sharp-pointed top of the triangular pieces then was bore-sighted with the center of the barrel. When a burst was fired, 98 percent went safely by the space between the blades and the other 2 percent ricocheted harmlessly off the hardened angles of the metal attachment, leaving the propeller unharmed.

Unfortunately for the Allies, Garros was forced down behind the German lines with motor trouble, although not before he had shot down many German planes with his device. His crude bullet deflector was shown to Antony Fokker, Germany's leading aircraft designer, who at once visualized an improvement and set about devising a reliable mechanical fire interrupter for his planes. The operation of the Garros deflector was one of the most sought-after secrets of the war, as the Germans could not fathom how he fired steadily through the air

screw without injuring it. Garros later escaped to fight again, but by then his idea had been bettered and German planes began to appear with the fire interrupter that was to give them air supremacy for at least the next 6 months. Garros, nevertheless, was the first man to mount a machine gun in such a manner that maneuvering of the plane made it a gun-laying device instead of merely a flying platform.

The French, at the very outbreak of war, were ready with a secret weapon that made the world realize the effective use of the airplane against large movements of ground troops. Odd as it may seem, machine guns were not employed in the first ground strafing. The French high command had for several years prior to the war secretly practiced dropping bundles of steel arrows that separated on the downward flight. A bundle of a thousand arrows gave good coverage over a half acre of land. The missiles were very tiny and light, being 6 inches in length and brought to a needle point at one end. Tests made with them showed that, when dropped from 1,500 feet, one of them would go through the body of a horse. The Germans soon learned



An Early Front-Gun Spad with False Nose to Accommodate Gunner.

that dispersion on the approach of a plane was the best defense against the arrows and they soon were replaced by machine guns for ground strafing.

In order to regain air supremacy from the Fokkers with the fire interrupter, the French attempted to solve the problem of firing through the air screw of a tractor-type plane by equipping a Spad with a false nose in front of the propeller. It housed a gunner and a swivel-mounted Portative Hotchkiss. A wire guard kept the gunner's head out of the propeller in the event he thoughtlessly leaned back. This scheme only showed the desperation of the French at the time.

In 1916 the French developed another unusual fighting plane which was called the "Mechanical Owl." Its intended purposes were for night fighting, or more specifically, to seek out observation balloons, and for any other missions that required night flying. This plane was

a pusher-type Maurice Farman, mounting a 11-mm belt-fed Hotchkiss in the forward part of the cockpit. It was felt that the large bullet held enough incendiary mixture to set fire to any observation balloon or hydrogen-filled dirigible. As further armament the large plane also carried six rockets, three on each wing, that could be fired electrically by the pilot. The rockets were considered extremely accurate up to 400 yards. The craft represented a formidable weapon against hydrogen-filled airships, both the fast-moving dirigible and the anchored observation balloon. Primarily designed for night fighting, the planes were equipped with a battery of headlights fastened above the landing gear and below the pilot. These searchlights served the dual purpose of lighting up the runway when the pilot returned at night to his home air base, and of illuminating the target once he could approach close enough to detect the huge balloon in the dark.

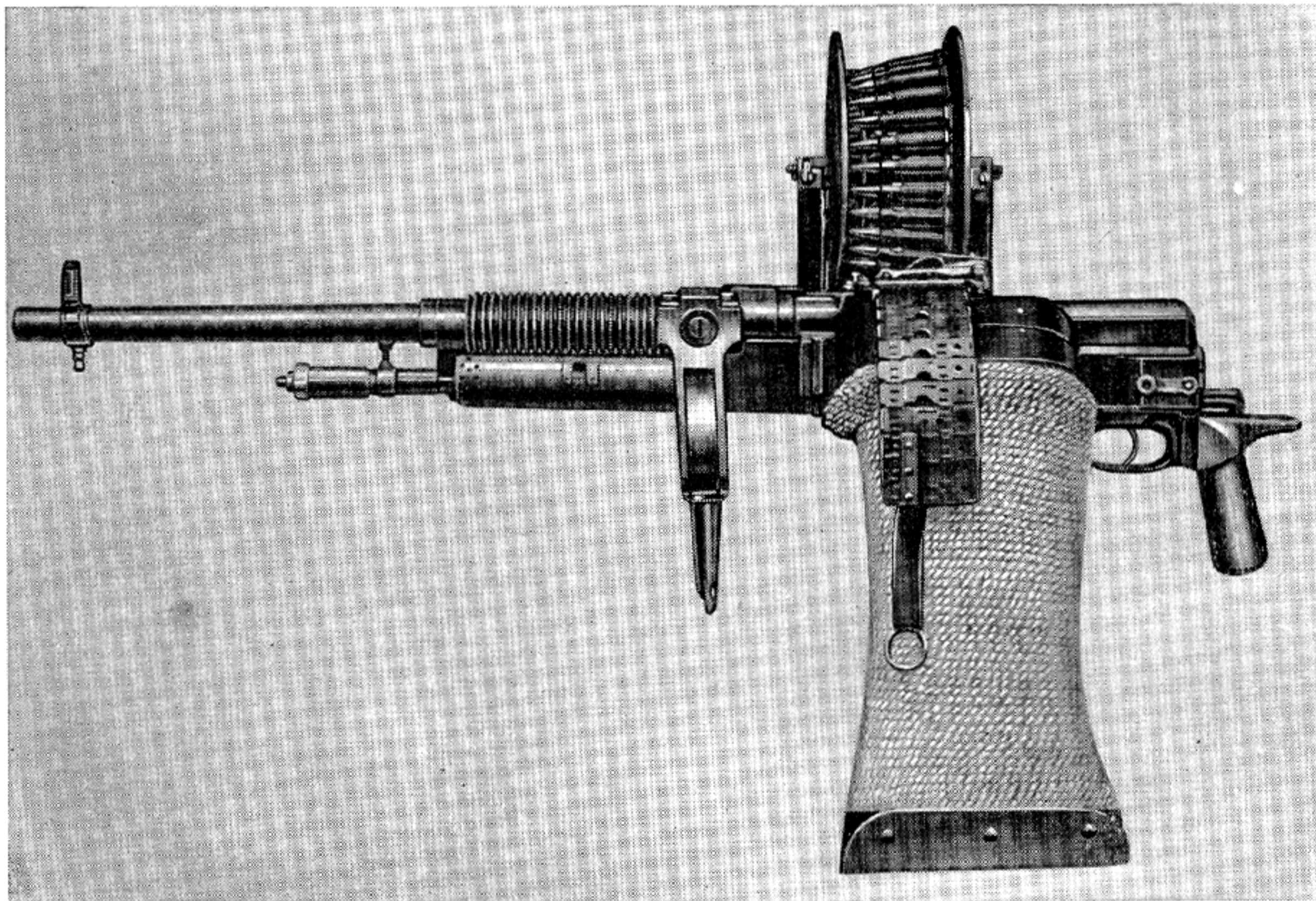

Benét-Mercié Machine Gun Adapted as an Aircraft Flexible Mount.

The rockets used on this plane were the invention of a French naval officer named Le Prieur and, while their use was restricted to observation balloons and Zeppelins, they had great potentialities in other fields. One of their most notable successes was the day before the great Somme offensive in 1916 when French pilots practically cleared the sky of the big hydrogen-filled bags, leaving the German artillery without observers.

The Le Prieur rocket was powered by ballistite. While the body was short and contained only a small amount of propellant, it was accurate for a reasonable distance after which it would wobble badly. This made it impossible to hit anything much beyond a 400-yard range. However, it was considered adequate for its intended use on the huge sides of a hydrogen-filled target.

Hotchkiss machine guns did not see much service in World War I as aircraft weapons. When the war came, France was desperately in need of heavy infantry-type machine guns and for this purpose the Hotchkiss was considered among the best. As fast as produced, they were sent to the front. The weapon, because of its design, could not readily be adapted to aircraft use, since feeding was done by inserting long metal trays of cartridges from right to left. This made plane installation practically out of the question.

Another reason for the sparing use of Hotchkiss guns was the fact that the British had two superb aircraft machine guns for free and synchronized installation. France, recognizing this, depended upon her ally to furnish armament for her planes. This is no reflection on the Hotchkiss. It was not originally designed for aircraft and some of its best features as an air-cooled infantry weapon made it impossible to convert to aerial use without practically complete redesign.

After the Armistice there was no immediate development work on machine guns at the Hotchkiss plant, but in 1922, at the suggestion of military authorities of other governments, the company did start experimental work on a large caliber automatic weapon designed primarily for aircraft use. Its operating mechanism was similar to the older models and a few fea-

tures were added to compensate for the increased shock due to the high rate of fire demanded for such a weapon.

On the 13.2-mm aircraft Hotchkiss, cartridges were fed by means of a disintegrating metal belt that came in lengths of 100 to 150 cartridges. Although the quick-disconnect barrel was chambered for a cartridge with a tremendous powder charge, the design was so thorough that the great load was not excessive.

While produced at the suggestion of foreigners, as soon as this model made its appearance and showed promise in early firing tests at the Hotchkiss company's range, the French Government put its development in secret status. This act did much to retard progress on the arm and no doubt kept it from being used throughout the world by other powers.

The French air force visualized the 13.2-mm Hotchkiss as an ideal engine gun and mounted it experimentally to fire through the propeller hub of a Hispano-Suiza engine. When so installed in aircraft a compressed air cocking system was employed for both charging and solenoid operation. The rate of fire was 600 rounds a minute and the fast recoiling parts were buffed by a heavy spring-loaded plunger attached to the back plate. The bolt and piston assembly remained in the retracted position at the completion of a burst.

When thus mounted, the ammunition container was located above the receiver with a flexible cartridge guide extending over to the feedway. This ideal arrangement provided practically a gravity flow of ammunition into the gun once firing was started.

After the French had officially tested the gun at Calais until they were satisfied that they had an adequate machine gun for any aviation work that required a heavy high-velocity armor-piercing bullet, they then adapted it to be used on their own armored vehicles. A mounting arrangement was provided that gave the gunner a high degree of maneuverability. This particular Hotchkiss machine gun is little known because in the years between the two great wars the French, confident that it was their chief aviation machine gun for the future, suppressed all information concerning it. Before they could get

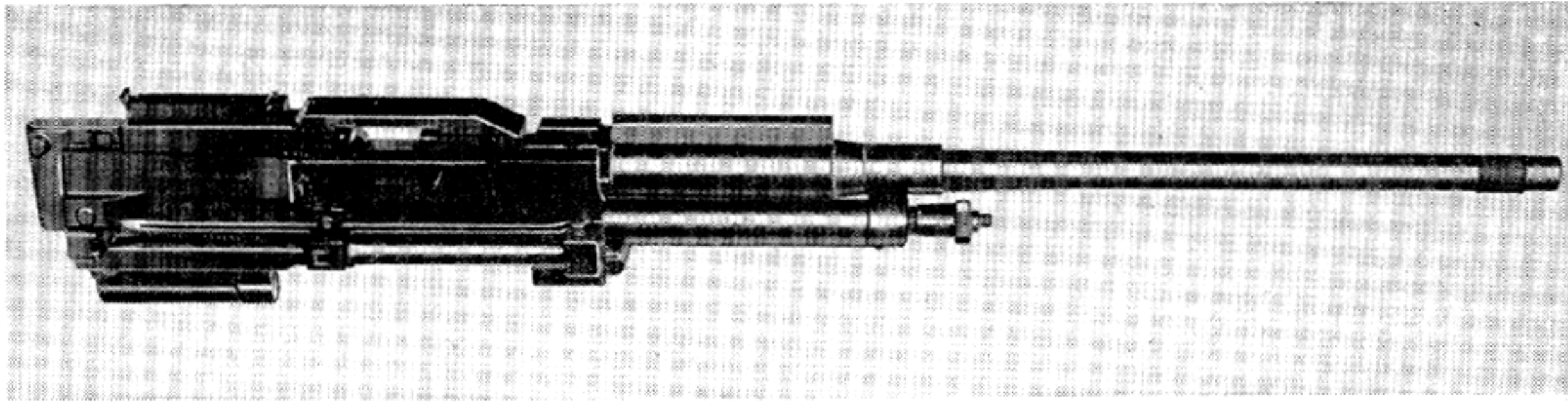

Hotchkiss Aircraft Machine Gun, 13.2 mm.

it into use on any large scale in World War II, however, the country was overrun by the Germans. The conquerors, already equipped with aircraft armament they felt superior, made no attempt to utilize the 13.2-mm Hotchkiss machine gun.

The basic principle being the same, the cycle of operation was naturally identical with that of other well-known Hotchkiss guns.

On 28 April 1927 representatives of the Okura manufacturing concern in Japan began negotiations with Hotchkiss for the purchase of manufacturing drawings for a large caliber anti-aircraft machine gun. This gun was suitable for both shipboard and ground installations, having been developed from the aircraft 13.2-mm model. The French authorities permitted Hotchkiss to offer this same mechanism and caliber, withholding only information on the compo-

nents that made it adaptable for aviation use. They specifically insisted that no means of belt feeding be revealed. The result was that the Japanese acquired the rights to make a 30-shot clip-fed weapon using the same operating parts as the original gun, but designed solely for anti-aircraft use. It was a heavy-barrel weapon with radial fins for cooling that had a maximum rate of fire set at 450 rounds a minute. The Japs gave this devise the official designation, 13.2-mm A. A. Machine Gun Model 93 (1933), and it was used extensively by them all through World War II.

In the Russo-Japanese War of 1904-05, which was the first major conflict in which both sides employed machine guns, the Japanese were armed with the Hotchkiss, which they found reliable and efficient. Since they were the victors and the Hotchkiss machine gun contributed to

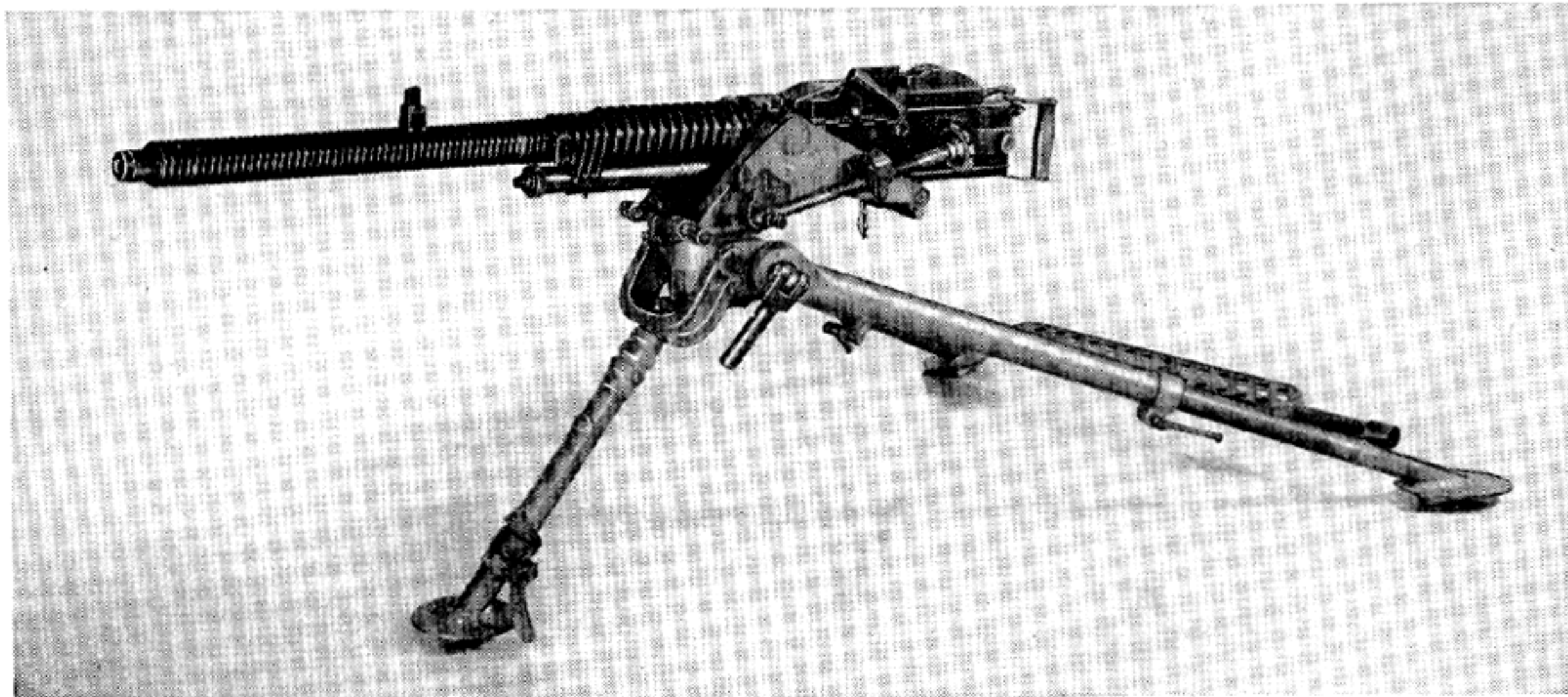

Hotchkiss Ground Machine Gun, 13.2 mm.

the war's hasty conclusion, Japanese military men retained a highly favorable opinion of the weapon.

It was natural that Japan, in planning future offensives, placed the Hotchkiss high on the list to be adapted to its specific needs. Thus many Japanese machine guns were produced with strange appearances, designations, model numbers and physical outlines that actually housed Hotchkiss mechanisms.

These adaptations and straight copies ranged from lightweight infantry machine rifles to larger caliber antitank versions. Even standard ground Hotchkiss models, in a variety of calibers and provided with almost every conceivable feed system, were converted to aircraft use. Supply officers had seven distinct small arms cartridges to provide for troops that used such machine guns. In Japanese logistics it seemed to mean nothing if two machine guns were designated 6.5-mm; it was possible that the only identical thing about the caliber referred to was the bore dimension. In most cases each weapon had to have its own particular cartridge.

A fairly safe procedure of classifying a strange-looking Jap gas-operated machine gun was to look upon it as some form of Hotchkiss until proved otherwise. A few of the first-line Jap weapons that were undeniably Hotchkiss are given in the following table:

Model	Type	Year	Caliber
Light machine gun . . . . .	11	1922	6.5 mm
Light machine gun . . . . .	96	1936	6.5 mm
Heavy machine gun . . . . .	3	1914	6.5 mm
Heavy machine gun . . . . .	92	1932	7.7 mm
Antiaircraft machine gun	93	1933	13.2 mm
Tank machine gun . . . . .	91	1931	6.5 mm
Aircraft machine gun ..	89	1929	7.7 mm
Aircraft machine gun ..	97	1937	7.7 mm
Aircraft machine gun ..	100	1940	7.92 mm
Aircraft machine gun ..	3	1943	6.5 mm

#### Tabulation of Hotchkiss Machine Guns

The following tabulation is intended as a ready reference of the various Hotchkiss models used by the nations of the world:

Name	Country	Designation	Bore
Hotchkiss . . . . .	Experimental . . . . .	Model 1895 . . . . .	8 mm Lebel
Hotchkiss . . . . .	Chile . . . . .	Model 1896 . . . . .	7 mm Mauser
Hotchkiss . . . . .	France . . . . .	Model 1897 . . . . .	8 mm Lebel
Hotchkiss . . . . .	France . . . . .	Model 1900 . . . . .	8 mm Lebel
Hotchkiss . . . . .	France . . . . .	Model 1914 . . . . .	8 mm Lebel
Hotchkiss . . . . .	Mexico . . . . .	Model 1896 . . . . .	7 mm Mauser
Hotchkiss . . . . .	Venezuela . . . . .	Model 1896 . . . . .	7 mm Mauser
Hotchkiss . . . . .	Guatemala . . . . .	Model 1896 . . . . .	7 mm Mauser
Hotchkiss . . . . .	Spain . . . . .	Model 1907 . . . . .	7 mm Mauser
Hotchkiss . . . . .	Spain . . . . .	Model 1914 . . . . .	7 mm Mauser
Hotchkiss . . . . .	Brazil . . . . .	Model 1896 . . . . .	7 mm Mauser
Hotchkiss . . . . .	Ethiopia . . . . .	Model 1914 . . . . .	8 mm Lebel
Hotchkiss . . . . .	Belgium . . . . .	Model 1906-1912 . . . . .	7.65 mm
Hotchkiss . . . . .	Norway . . . . .	Model 1898 . . . . .	6.5 mm Krag
Hotchkiss . . . . .	Norway . . . . .	Model 1898T . . . . .	7.9 mm Jung TL
Hotchkiss . . . . .	Sweden . . . . .	Model 1900 . . . . .	6.5 mm Mauser
Hotchkiss . . . . .	Commercial . . . . .	Model 1899 . . . . .	As desired

Name	Country	Designation	Bore
Hotchkiss .....	Commercial .....	Model 1903 .....	As desired
Hotchkiss (Navy) .....	Portugal .....	Model 1914 .....	7 mm Mauser
Hotchkiss .....	Japan .....	Model 1905 .....	6.5 mm Arisaka
Hotchkiss .....	Japan .....	Model 1914 .....	6.5 mm Arisaka
Hotchkiss .....	Chile .....	Model 1920 .....	7 mm Mauser
Hotchkiss .....	Japan .....	Model 1932 .....	7.7 mm
Hotchkiss .....	Japan .....	Model 1941 .....	7.7 mm
Hotchkiss .....	France .....	Balloon gun (World War I)..	11 mm
Puteaux .....	France .....	Model 1905 .....	8 mm Lebel
St. Etienne .....	France .....	Model 1907 .....	8 mm Lebel
St. Etienne .....	France .....	Model 1907 T .....	8 mm Lebel
St. Etienne .....	Italy .....	Model 1907 F .....	8 mm Lebel
St. Etienne .....	Turkey .....	Model 1907 (converted) .....	7.9 mm Mauser
St. Etienne .....	Greece .....	Model 1907 .....	8 mm Lebel
St. Etienne .....	Yugoslavia .....	Model 07/15 .....	8 mm Lebel
Benét-Mercié guns:			
Hotchkiss LMG .....	France .....	Model 09/13 .....	8 mm
Hotchkiss Army .....	USA .....	Model 1909 .....	.30/06
Hotchkiss Army .....	USA .....	Model 1910 .....	.30/06
Hotchkiss Navy .....	USA .....	Mark I .....	.30/06
Hotchkiss Navy .....	USA .....	Mark I Mod 1 .....	.30/06
Hotchkiss LMG .....	England .....	Mark I .....	.303
Hotchkiss LMG .....	England .....	Mark I* .....	.303
Hotchkiss LMG .....	Spain .....	Model 1922 .....	7 mm
Hotchkiss LMG .....	Norway .....	Model 1911 .....	6.5 mm



## NAMBU AUTOMATIC WEAPONS

Between World Wars I and II, Japan constantly surveyed the development and experimental work of all nations in an attempt to provide for her own armament the best in automatic weapons these countries had to offer. The Japanese have long been noted for their lack of originality and their meticulous effort in copying, and later refining, those things in which they had special interest. Weapons were by no means an exception to this rule, since it was one of the first major powers to use machine guns in combat in the Russo-Japanese War of 1904-05. The automatic weapon used to such good advantage was the French Hotchkiss and the country naturally leaned towards this very reliable system of gas operation as a model for its future machine guns.

However, research was constantly directed towards the improvement of all makes of standard automatic weapons to meet specific needs of the armed forces. Manufacturing difficulties and metallurgy problems were often overcome by accepting a lower muzzle velocity, even the solution to muzzle flash being approached from this

angle. Such sacrifice of bullet speed and the corresponding chamber pressures made it possible to get satisfactory operation from lower grade materials.

Since the trend was for the simplification of already existing weapons and the substitution of inferior metals, the development of aircraft machine guns and automatic cannon showed little or no originality, all being close copies of similar armament of other countries. One of their most popular aircraft cannon was a Browning aircraft machine gun scaled up to 20 millimeters. Other arms were patterned after the German Rheinmetall and Italian designs.

One of the most discussed of Japanese automatic weapons was the so-called Nambu machine gun, devised by Lt. Gen. Kijiro Nambu. This officer first began the study of automatic weapons in 1898. In 1904, he designed a pistol, which, however, was not accepted by the Japanese Army. After modification, it finally became in 1925 an official side arm, being given the designation, Type 14 pistol. In the meantime he had turned his attention to machine guns. In his pistol he

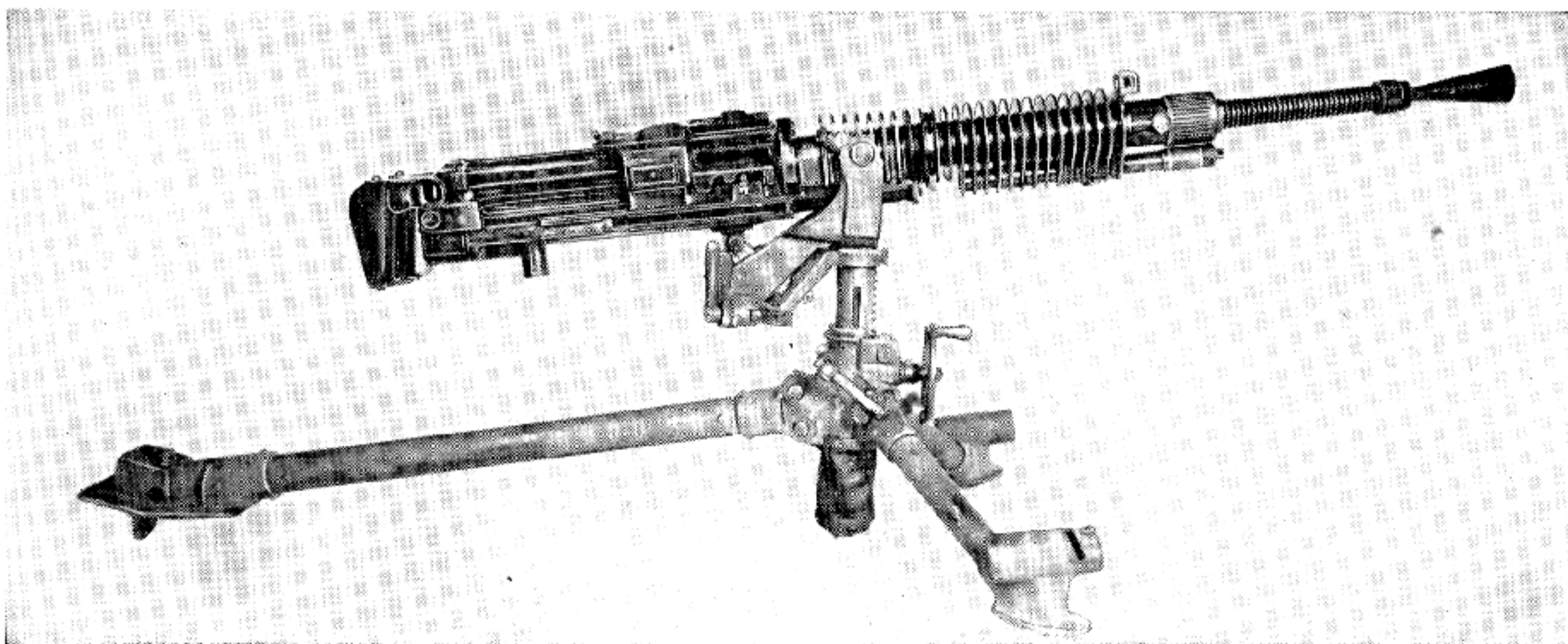

Machine Gun, Model 3 (1914), 6.5 mm, Japanese.

did show some originality but his machine guns were straight Hotchkiss systems, with a few physical and external modifications to suit special conditions.

The first Nambu machine gun appeared in 1914 and was known as the Type 3 heavy machine gun. In 1922 it was improved and became the Type 11. General Nambu founded a rifle company bearing his name at Sankomaje-Nakano, Tokyo, in 1927. At this place he developed what was to become later the Type 92 medium machine gun which superseded the Type 3 in the Japanese Army. He again modified this medium gun as the need for its improvement had become obvious, producing the version known as Type 96.

In 1937 the Nambu Rifle Works merged with the Chuo Kogyo Kaisha Co. of Tokyo, and 2 years later he introduced the Type 99 light machine gun. Until his retirement in 1943 Nambu acted as an ordnance consultant to this firm. From 1939 to 1945 the Chuo Kogyo Kaisha plant manufactured 4,794 Type 96 and 1,179 Type 99 machine guns.

All Nambu machine guns were gas operated and air cooled with many radial fins giving more surface for cooling. The earlier models had rectangular gravity oil reservoirs so that as rounds were fed into the feed opening they engaged a spring-loaded lubricator. This action caused oil to flow through perforations onto the cartridge

cases. Such lubrication was needed because manufacturing the components to such close tolerances as to permit a workable head space had not been possible at the time. The oil permitted the cartridges to slip back against the bolt until lock clearance was taken up, thereby eliminating the danger of a ruptured cartridge case.

The ejection system in these guns is the only deviation from the Hotchkiss, it being an exact duplication of the Lewis method of pivoting a piece over the bolt body. During forward movement of piston and bolt the bolt head raises the nose of the ejector upward out of the body, which forces the tail of the extractor to descend through the opening in the bolt. On rearward movement the aft end of the ejector lifts, causing the nose to descend through the opening in the bolt and strike the cartridge at its base. The case is then knocked through the opening in the side of the receiver. The rate of fire can be adjusted by means of five different sized orifices. The gas regulator has a positioning catch with a spring-loaded plunger that engages slots in front of the gas cylinder. Initial extraction takes place during the first phase of unlocking after the locking piece has risen and the bolt commences its first movement rearward. Full extraction occurs when the piece is unlocked and the gas piston and bolt assembly are driven back together. The extractor is the conventional flat-spring type with a recess cut in the back end of the barrel to ac-

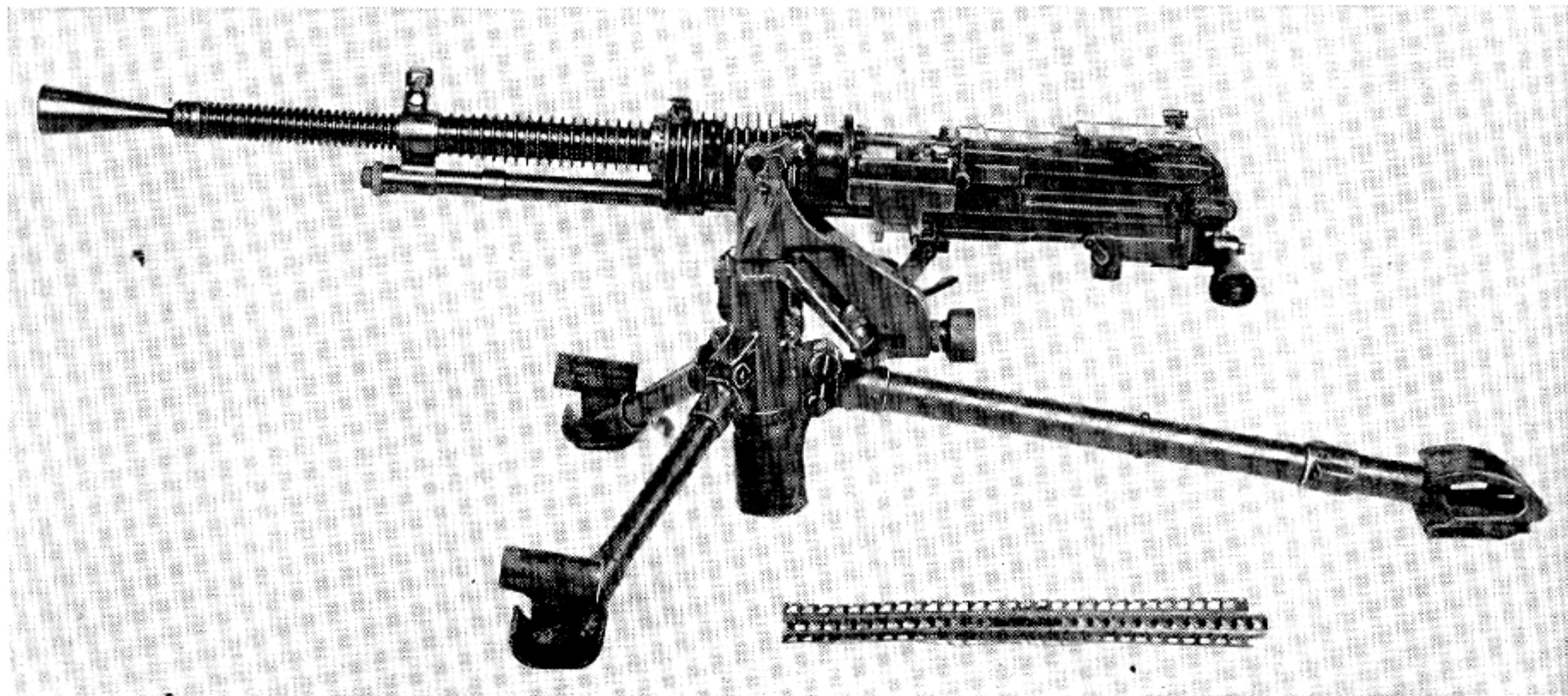

Machine Gun, Model 01 (1941), 7.7 mm, Japanese.

commodate it when the bolt is all the way in battery.

The Model 99 Nambu 7.7-mm light machine gun is undoubtedly the most familiar Japanese automatic weapon. The main refinement was in the machining which permitted better head spacing and consequently did away with the necessity of oiling the ammunition.

A new spring-loaded clip magazine was used that gave the gun the appearance of the well known Bren. Four different types of the Model 99 were tested before the weapon was fully standardized and adopted in May 1939.

To fire the Nambu Model 99 machine gun, the operator, generally prone, first snaps into its recess on top of the receiver a loaded clip. He cocks the gun by pulling back on the charging handle until the recess of the piston engages the bent of the scar, which holds the bolt back under driving spring compression. When the trigger is pulled, its nose depresses the scar, disengaging it from its recess in the piston. The bolt and piston now fly forward under energy of the compressed driving spring. During this movement the face of the bolt picks up the first round in

the magazine mouth and starts it toward the chamber.

The bolt arrives home first and completely chambers the cartridge. With the extractor lip camming itself over the rim of the case, the piston, still moving forward, raises the back end of the bolt into its locking abutment by means of a linkage arrangement, and the projection on the end of the piston strikes the firing pin to explode the propellant.

As the bullet is driven out of the barrel, a portion of the gas is vented through the gas regulator into a cylinder to strike the piston head a sharp blow, driving it rearward. When the piston has traveled  $\frac{3}{8}$  inch, the bolt is free to unlock, forcing the aft end of the bolt out of engagement with the locking step.

The first recoiling movement begins initial extraction of the empty cartridge case and withdraws the firing pin. Continued movement brings ejection and full compression of the driving spring. A small spring-loaded buffer at the rear of the receiver absorbs all surplus energy and starts the operating parts back into counter-recoil. The cycle is repeated as long as the trigger remains depressed.

# REVELLI AIRCRAFT MACHINE GUN

The Italian Air Force during World War I was so desperate for an adequate rifle-caliber machine gun of native origin that it ordered the lightening of the water-cooled 1914 model Revelli. This was accomplished by the removal of the water jacket and use of an air-cooled barrel with longitudinal ribs. It not only gave more cooling surface but also strengthened the barrel, cutting down dispersion. The rate of fire was increased by use of ammunition more thoroughly lubricated by means of a built-in oil pump. While the modifications definitely improved the ground gun, it was still far from an ideal aircraft weapon. After limited use the Italians went back to the reliable synchronized Vickers for fixed installations and the Lewis gun for flexible mounting.

As soon as hostilities were ended, Italian military authorities immediately turned their energies towards the development of a light machine gun for both infantry and aircraft use. This trend was hastened by the British decision to stop exporting Vickers ammunition. They negotiated for the purchase of a thousand Darné guns from France but these proved unsatisfactory. The Italians wanted, if possible, for infantry use to combine the advantages of a light machine gun with the ruggedness of the heavy; and for the air force, to employ it both for flexible and fixed mounts.

They wished to raise the caliber to eight millimeters or even more, but were plagued by the presence on hand of huge stores of the outmoded 6.5-mm ammunition produced during the war. This obstacle forced them to do the next best thing, namely to improve what was already in use and if anything was designed in the future to be certain to chamber it for the readily available 6.5-mm cartridge.

Italy has always used the unique ordnance development method of giving contracts to different companies for machine guns based on identical specifications and then holding competitive trials to see which company has turned out the best gun. This odd system of government-sponsored competition makes identification very confusing, for one often finds practically identical guns, marked in some instances with the same model numbers, that are named for the various plants that produced them.

The Fiat Co., the first manufacturer of Revelli's guns, offered to the Italian Government for trial in 1926 a lightweight machine gun that it contended would fill all demands placed upon it. It was designed, according to its producers, to take into account reliability of action, minimum weight, simplicity of construction and ease of handling, all being factors that must be taken into consideration in order to have a practical unit. The principal parts were given as receiver,

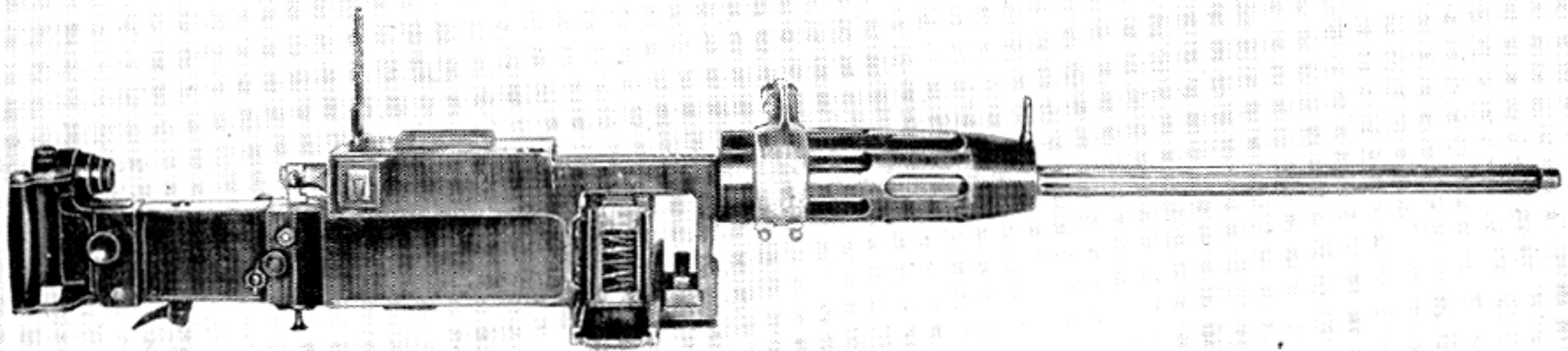

Revelli (Fiat) Aircraft Machine Gun, Model 1914, 6.5 mm, Flexible.

barrel extension, bolt, breech lock, barrel, jacket, and ammunition box.

The receiver is square in shape. In its front there is an integral threading into which is screwed the cylindrical sleeve where the recoiling barrel slides. The operating or spade grip handle is fixed to the extreme rear of the receiver. The oil reservoir is located at the upper part of the receiver and is provided with a small hinged door for filling. On the right side of the piece an ejection slot is cut, while the left part has a portion milled out to admit the ammunition box.

The inside of the receiver has a longitudinal square cut in which the bolt and barrel extension slide during recoil. A rectangular transversal hole located in the middle accommodates the key that limits the sliding movement of the barrel and its extension. Another such slot near the handle serves for the key holding the spade grips into position.

The barrel extension is a square section with interrupted threads in the front part for quickly attaching the barrel. Its upper part has a rectangular opening through which the bolt lock is inserted. An opening on the left side admits the loaded round and on the right side there is a similar opening for ejecting the case. Internally the piece has a longitudinally square opening that serves as a slide way for the bolt.

The bolt is made square to fit into the barrel extension with a wider portion left on the aft end to engage the retracting hook at the bottom and the rear sear at the top. Internally it has a cylindrical hole of two different diameters into which the firing pin moves to perform its func-

tion. In the bolt face is a recess to accommodate the base of the cartridge. On the left side is a rib that engages the incoming round from the ammunition box and forces it into the chamber, while the extractor is fastened on the right of this piece. There is also a device housed in the bolt body called the safety lever. It prevents release of the firing pin before the breech lock is in battery position, since it cannot be removed from the path of the firing pin until its recess is reached which is coincidental with the locking action.

The bolt lock has a hole through which it is secured to the receiver by means of a pin, and around which it partially rotates during its function. The front flat part of this lock rests in the recess in the upper part of the bolt and the rear part on the barrel extension. On the upper part is a heavy spring-loaded curved rod to which is pinned the breech lock. The firing pin is cylindrical having two different diameters and is fitted with a rib which acts as a guide in the slot cut in the left side of the bolt. This rib has a cammed angle that causes it to be jacked back slightly by the first movement of recoil and at the end of the bolt's farthest travel rearward it is retracted fully. The weapon is fired automatically when the safety lever pivots down in the recess at the end of counterrecoil, releasing the cocked firing pin.

The barrel has externally cut longitudinal cooling ribs. It is attached to the barrel extension by insertion in the chambered section and is held fast by means of a four-tooth interrupted thread. A lever prevents the barrel from rotating and

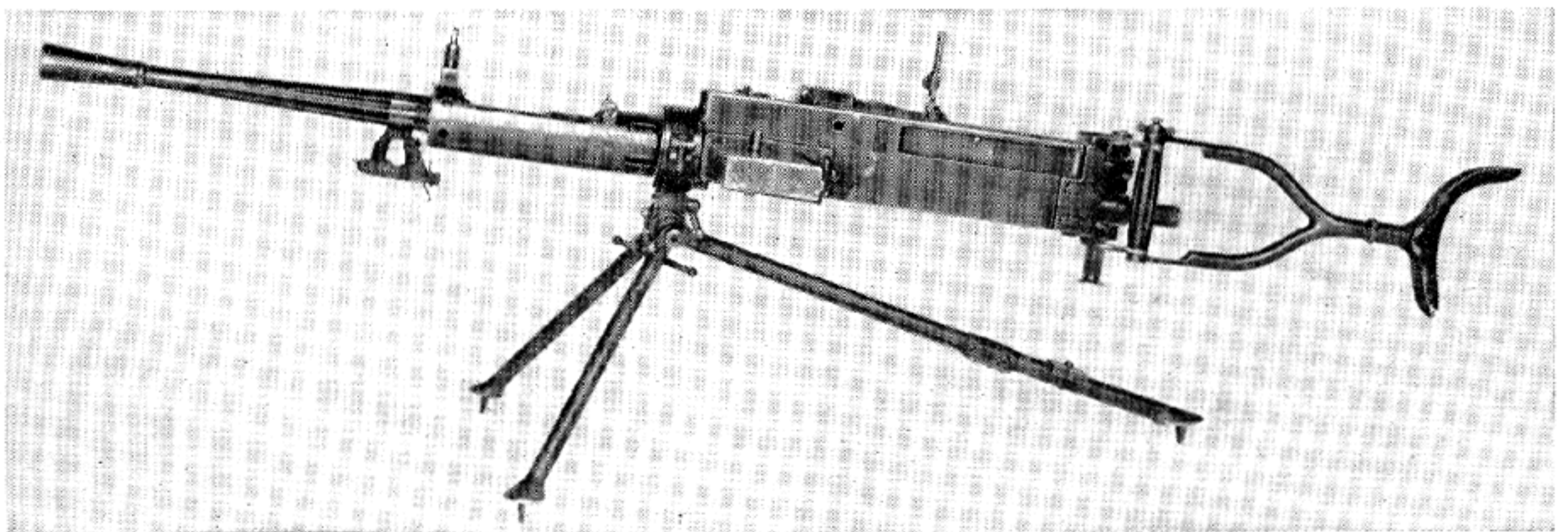

Revelli (Fiat) Machine Gun, Model 1926, 6.5 mm.

consequently disconnecting itself from the barrel extension. This arrangement permits a quick barrel change and a short asbestos-lined handle is provided to facilitate this necessary action.

The weapon is hand charged by means of a handle that protrudes through the back plate with connecting slides that engage the rear end of the bolt at its rearmost projection. This permits hand cocking, as well as complete retraction of all recoiling parts.

The ammunition feed on the 1926 Revelli is a metal holder attached to the left side of the receiver. This device, which is normally removed during transportation, holds 20 rounds of ammunition and is held in place after insertion by a latch near its mouth. The ammunition is placed in the feed after first being inserted in a special metallic loading device. After this loading container is discarded, the last round to enter goes over a cartridge-holding pawl that retains it in position in the feed mouth. The rib on the bolt then picks it up for chambering.

The producers of the weapon recommended that the barrel should be changed after every 200-round burst and before firing suggested that the mechanism be worked back and forth manually a few times in order to lubricate thoroughly the ammunition before commencing to fire.

In order to fire the weapon, the following steps had to be undertaken to prepare it properly for reliable operation:

Check oil reservoir to ascertain if sufficient lubricant is in tank; pull rearward on the charging lug until rear sear engages bolt; push charging handle all the way home manually until it is locked by its detent; insert magazine in left side and lock in position; open trap door on right side to permit empty cases to be ejected; then introduce through this opened trap on the right side 20 cartridges from their metallic holder, pushing cartridges across the feedway until the last one crosses the holding pawl.

When the magazine was thus loaded, the container was discarded and the weapon was ready to fire.

The Fiat Co. appeared to have produced an entirely new machine gun but closer examination of the operating parts showed it to be just another version of the earlier 1914 Revelli with refinement being merely external. The basic op-

erational features were the same as the original model. While the Italian Government did not adopt the "new" gun, it did encourage development by buying 2,000 for general use. This was enough financial incentive for the Fiat Co. to continue with its experimental work.

The manufacture of the 2,000 weapons that the Government agreed to buy was turned over to a newly formed corporation at Turin. Basically Fiat was an automobile manufacturing plant but since it found machine gun production a profitable sideline, a separate plant was built exclusively for the fabrication of automatic weapons. The new establishment was known as the Società Anonima Fabbrica Armi Torino, which accounts for the 2,000 weapons, officially designated the Fiat, Model 1926, having a Safat nameplate.

It having been plainly pointed out to Fiat that all branches of the service were disappointed in the lack of new operational features in its 1926 model, the firm again proceeded with intentions of redesigning and manufacturing a suitable arm. As an incentive the Government withheld adoption of an official model, and development could be undertaken with the knowledge that appearance of a superior product could result in complete outfitting of all branches of the service with a suitable automatic firing mechanism.

The result of this second effort was the Fiat Model 1928. It had many features not to be found in previous designs. The caliber naturally remained at 6.5 millimeters and the rate of fire was the same, as was the feed system. This time the changes were internal and not external, as had been the case with the 1926 machine gun, the main modifications being in the locking components. The company, after many years of production, had finally dropped Revelli's retarded blow-back system and incorporated in this mechanism a positive locking arrangement invented by Giuseppe Mascarucci, an engineer in the employ of Safat. By this method the barrel and bolt were positively locked for the first fraction of an inch of recoil and at a predetermined distance the linkage pinned to the breech lock was raised, pulling the lock out of engagement with its recess in the bolt. This changed the action from retarded blow-back to straight recoil operation. The remainder of the recoiling parts, however,

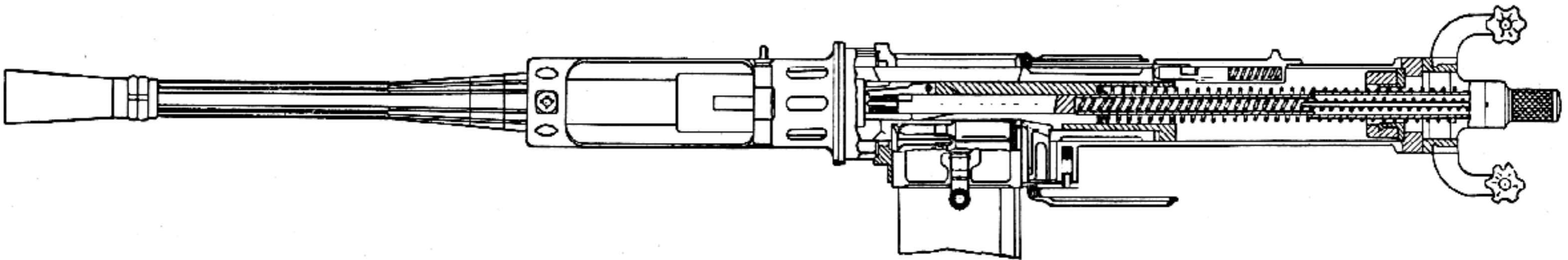
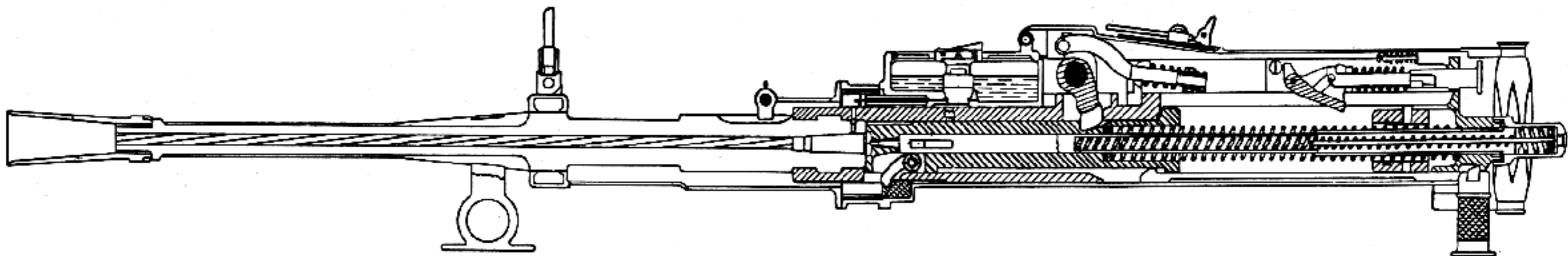

Drawing of Fiat Model 1926, 6.5 mm.

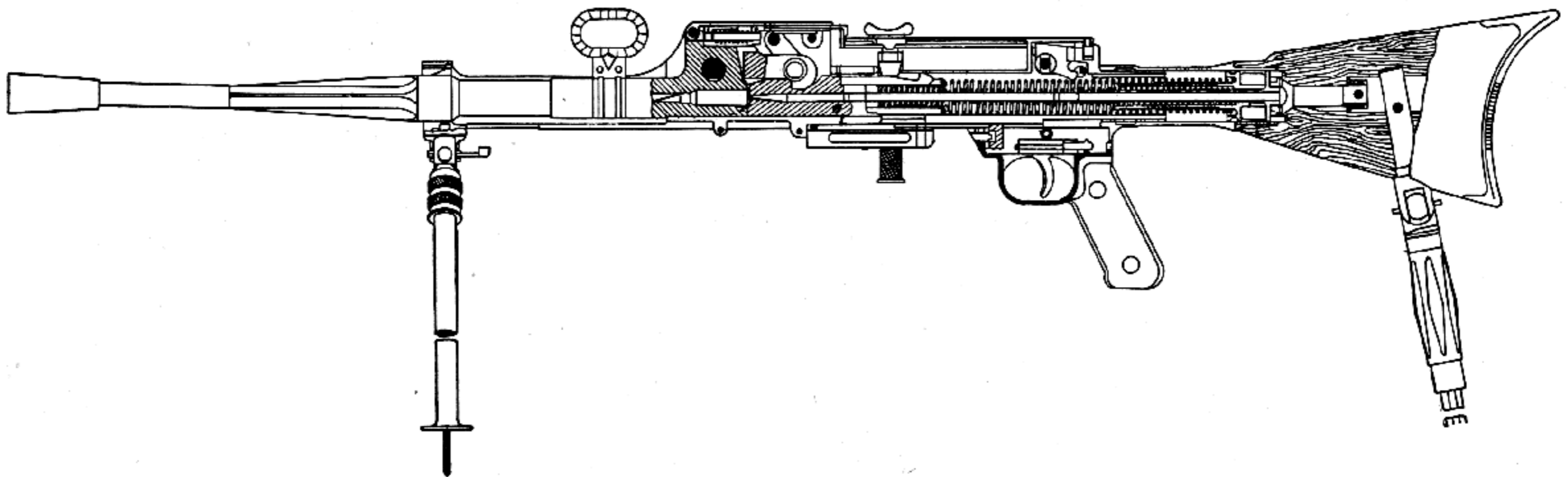

Drawing of Fiat Model 1928, 6.5 mm.

were very similar in appearance to standard Revelli components.

The purchasing of the Mascarucci patents caused Revelli to terminate his business connections with Fiat after nearly 20 years' association. Although the company lost the services of one of Italy's most prolific automatic weapon inventors, there is no question that the Mascarucci lock was a worthwhile improvement and the army immediately ordered it into test status for the purpose of adoption. By early 1929 over 200 had been delivered to various proving grounds.

In the 1928 Fiat, the action was securely locked until the gas pressure had dropped to a safe operating limit, making lubricated ammunition unnecessary. The weapon, when correctly head-spaced, no longer had ruptured cases from the retarded blow-back type of operation whereby the lock seeks to become disengaged even while gas pressure is at its peak with bullet in the barrel. The minute opening between the bolt face and the breech end of the barrel resulted in separated cases when a point beyond the elastic limit of the brass was reached.

The weight of the gun without tripod or shoulder piece was 21 pounds. One of the most exorbitant claims ever made for a machine gun barrel was the producer's statement that with bursts of a length prescribed by proving ground regulations, the barrel could be depended upon to give accuracy for 20,000 rounds. The implication was made that some advanced heat-treat process was responsible for the phenomenal feat.

Disassembly without the aid of tools could be accomplished in a matter of seconds. Simplicity and the use of few moving parts were most certainly taken into consideration, as the bolt, firing pin, and two springs were all operating parts that could be withdrawn with the removal of the back plate buffer.

To fire the weapon, the operator is generally prone. After the box magazine is snapped into position on the left side, the bolt handle is grasped with the right hand and drawn to the rear. The rear searing device then catches in the notch in the aft end of the bolt, holding it in the cocked position. The firing pin is also retracted by this movement.

The special metal loading device holding 20 cartridges, inserted from the right hand side of

the feedway and shoved in until the last cartridge is so loaded, passes over the cartridge-holding pawl. The metal charger is then withdrawn and put aside. The magazine now being loaded and the firing mechanism cocked, the weapon is ready to fire. If the pistol-grip trigger is used, it is pulled to the rear and with the aid of a bar raises the sear, allowing the action to be thrust forward by the energy of the compressed driving spring.

As the bolt goes home, the projection on its left side shoves the positioned cartridge in front of it into the chamber. The barrel and barrel extension are held to the rear, a half inch out of battery, by a small spring. When the locking notch in the bolt is directly under the locking lever, the whole assembly is then driven all the way into battery by the greater force of the driving spring. As the entire assembly moves forward, the link arrangement cams the lock into positive engagement with the recess in the bolt. This last forward travel of the bolt also brings into alinement the firing-pin recess controlled by the trigger bar. The open sear allows the firing pin to snap forward automatically and strike the primer of the cartridge.

While the peak pressure is in the chamber, the bolt latch securely holds the bolt, barrel extension, and barrel together until a half-inch travel is reached. The link now begins to raise the bolt latch slowly and then suddenly releases the recoiling parts with a small spring housed in the top of the receiver holding the barrel and extension in a retracted position. This gradual unlocking makes possible the slow pulling and loosening of the cartridge case by the extractor before total unlocking. The bolt is now free to travel rearward, assisted by considerable residual pressure in the bore acting on the face of the bolt. The extractor holds the base of the cartridge in position to strike the ejector and be thrown through the ejection slot in right side. At the first movement of recoil a cam surface action on the firing pin lug retracts it slightly beyond the bolt face. By the time two-thirds of the recoil stroke is accomplished, this piece is retracted. At the completion of recoil, the driving spring, being fully compressed, starts the bolt assembly forward to repeat the cycle of operation. However, if trigger pressure has been re-



leased, the sear in the upper rear of the receiver snaps down and engages its mating notch in the bolt body holding the firing mechanism in a cocked position.

The Fiat Co. also made an attempt at this time to produce a 12.7-mm machine gun along similar lines, but did not get beyond a few working models that were tested by the Italian Navy for shipboard use against torpedo plane attack. It too was clip fed, a detail in itself that rules out its usefulness.

The next Fiat design was in the form of a larger caliber aircraft weapon. It was chambered for 7.7-mm rifle caliber ammunition with the use of a disintegrating metallic link belt in place of the box magazines that had by now become something of a permanent fixture with all Italian machine guns. While the operating principle was identical with the '28 model infantry gun, the rate of fire was later increased to 800 rounds a minute by the addition of a muzzle-booster recoil-actuated accelerator and a star-wheel recoil-actuated feed system. Otherwise all components were basically the same as those of the light machine gun.

The stepping up of the cyclic rate at first was not looked upon with favor by pilots and observers, who expressed themselves as preferring lower rates, with well regulated and reliable mechanism, to the faster firing. They argued that inaccuracy and waste of needed ammunition were the only results when a weapon was fired faster than it could be aimed properly. This viewpoint had much to do with the reluctance of the Air Ministry to specify anything beyond a normal operating speed for the armament of aircraft. However, when the 800-shot-a-minute gun did prove reliable to a certain degree, it did not take long for the flyers to reverse their former opinion.

Little was done in machine gun development in Italy until the mid-thirties when Fiat brought out another model at a time when the nation was faced with war.

No single action portrays so vividly the misguided helplessness of the Italians after a quarter century of effort to produce an adequate machine gun of native design than did the appearance of the Fiat Model 1935. This gun was but



Fiat Machine Gun, 12.7 mm, Antiaircraft.

a rehash of the 1914 model Revelli, which was considered basically wrong from the start as an automatic weapon, since its locking system was operated by retarded blow-back. This meant that, from the instant of firing, the bolt, in trying to unlock, created a variable head space. Such a condition would result in ruptured cartridge cases unless lubrication were applied to allow them to slip in the chamber and follow the partially opened bolt rearward. Needless to say, the Fiat Model 1935 retained this feature. In fact many of them were actually modified weapons of the 1914 series, although some were of new manufacture.

The gun's chief modification consisted in the

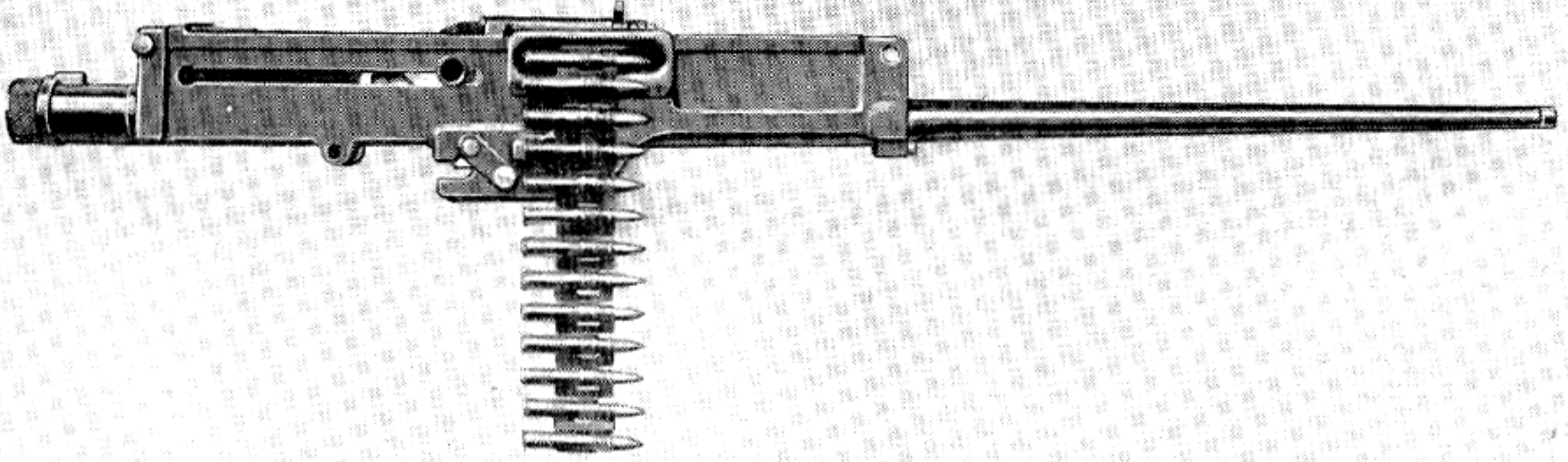

Fiat Aircraft Machine Gun, Model 1928 A, 7.7 mm

addition of a heavier barrel chambered for an 8-mm cartridge. Its chamber was fluted to aid in extraction of the case, since the splines in the chamber allowed gas to leak between the cartridge case and chamber walls. According to Revelli's patents, which he had assigned to Fiat before leaving the organization, the fluting would insulate the case from the chamber as adequately as oil. Such a theory must have been arrived at without test for rapidity of fire. There

was no oil pump on the model, such as had been incorporated in the receiver of the earlier model. The change proved to be a mistake, as the fluted chamber functioned only at slower rates of fire when time was allowed for the high chamber pressure to drop before unlocking.

In order to keep the new weapon functional, there was added a device called the de-accelerator, that worked just as the name implied. It slowed the cyclic rate from a normal 500 to 120

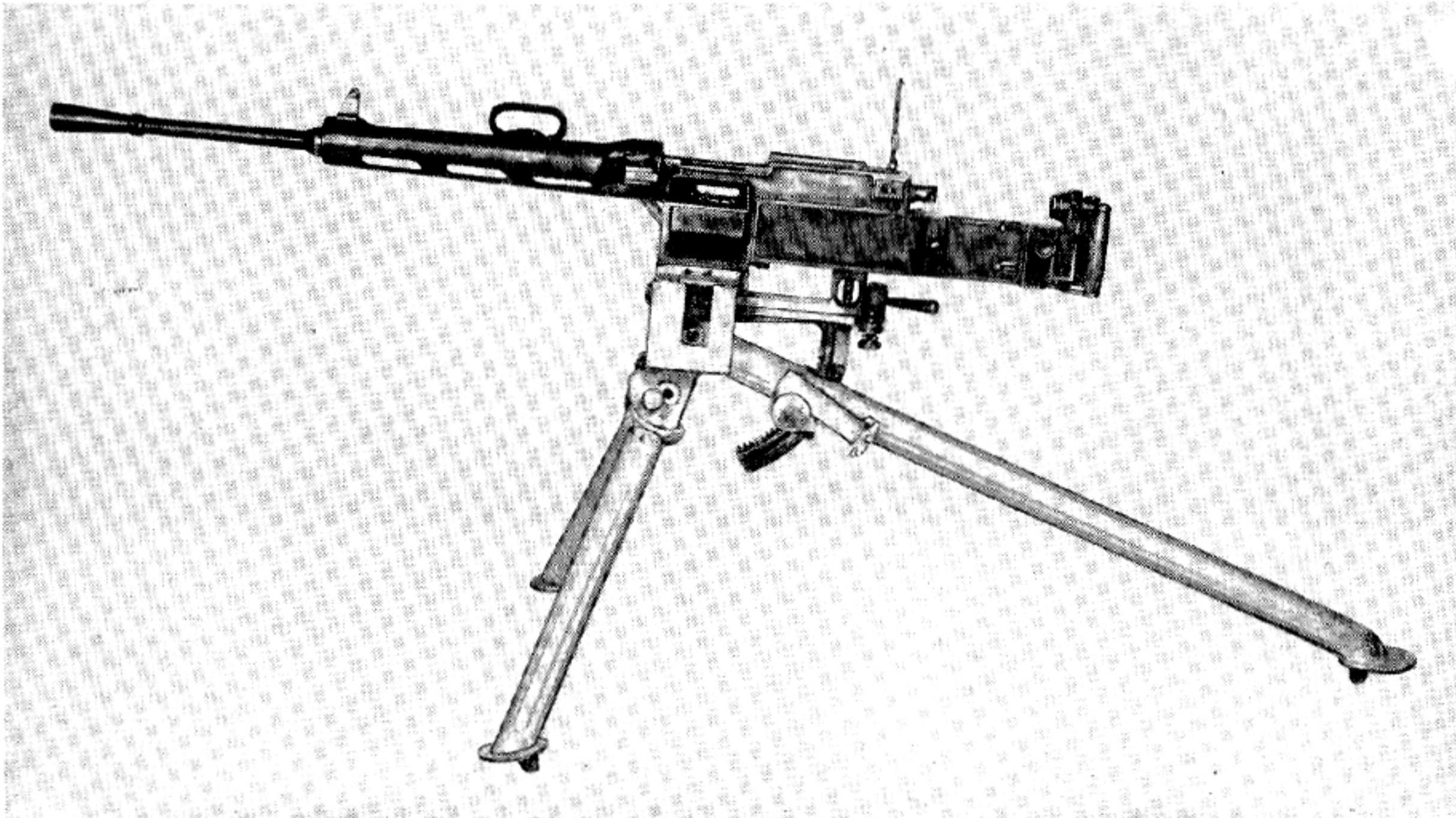

Fiat (Revelli) Machine Gun, Model 1935, 8 mm.

rounds a minute. On the few guns that did not incorporate this feature the ammunition was lubricated by brushing on the oil externally before being loaded into belt or can. The feed box with its compartments could also be removed and an attachment substituted that allowed a non-disintegrating metal belt holding 300 rounds to be used if desired. Some guns were modified to feed from the left and eject to the right, and others made to do just the reverse.

A combined safety catch and charging lever on the rear cross-piece allowed both single-shot and automatic fire. A slotted or skeletonized barrel jacket with the front sight mounted on top was also added.

Another feature that will ever remain a mystery was incorporated. It was modified to fire

from a closed bolt, an act that also showed adoption without ample proof firing. The latter would undoubtedly have revealed that any burst of great length through the air-cooled barrel, before letting the bolt go home on a live round, would result in a cook-off. The position of the combination bolt end and cocking piece was so located that if the gunner attempted to withdraw the live round from the hot chamber to prevent such a dangerous situation and the weapon did fire, as would be very likely under such conditions, the hand of the operator would be between the back of the bolt and the rear buffer.

The Fiat Model 1935 was perhaps the greatest known example of misapplied talent and inadequately tested theories in ordnance history.

## BERGMANN, DREYSE AND MG-13 MACHINE GUNS

## German Light Machine Gun Models in World War I

The German high command early in World War I realized the need for a light companion arm for the heavy, water-cooled machine gun that lacked mobility for modern offensive infantry tactics. True, they had the ideal weapon in Heinemann's Parabellum but this weapon was in such demand by the air force that the thousands needed by the army were not available. The German ordnance department was also greatly concerned with producing the desired weapon as cheaply as possible with simplicity of design for easy mass production.

In early 1915 a conference was held and the best known German automatic arms designers were assigned the task of developing the proposed weapons. The Rheinische Metallwaren und Maschinenfabrik of Dusseldorf and the Bergmann Industrie Werke Abt. Waffenbau of Suhl were the companies selected for the undertaking. Rheinmetall was to produce the light

highly portable machine gun for infantry use, while the latter plant would develop an aircraft version especially adaptable for flexible mounting. If this should prove reliable, it would free thousands of Parabellums urgently needed for fixed installations.

Rheinmetall, which owned Louis Schmeisser's patents upon which the action of the Dreyse machine gun was constructed, attempted to solve the problem simply by modifying the already existing Dreyse Model 1912. The parts were lightened together with a little redesign and a change in metal. The result, which used Schmeisser's pivoting lock, was given the factory designation, Dreyse Machine Gun, Model 1915. The change in manufacturing procedure and, in particular, the poor selection of metal resulted in a bad showing by the weapon during subsequent tests. It was practically dropped as a project until 1918 when more pains in manufacture and a better choice of steel resulted in a reliable gun that became known as the Model 1918. However the war was too close to its end to draw

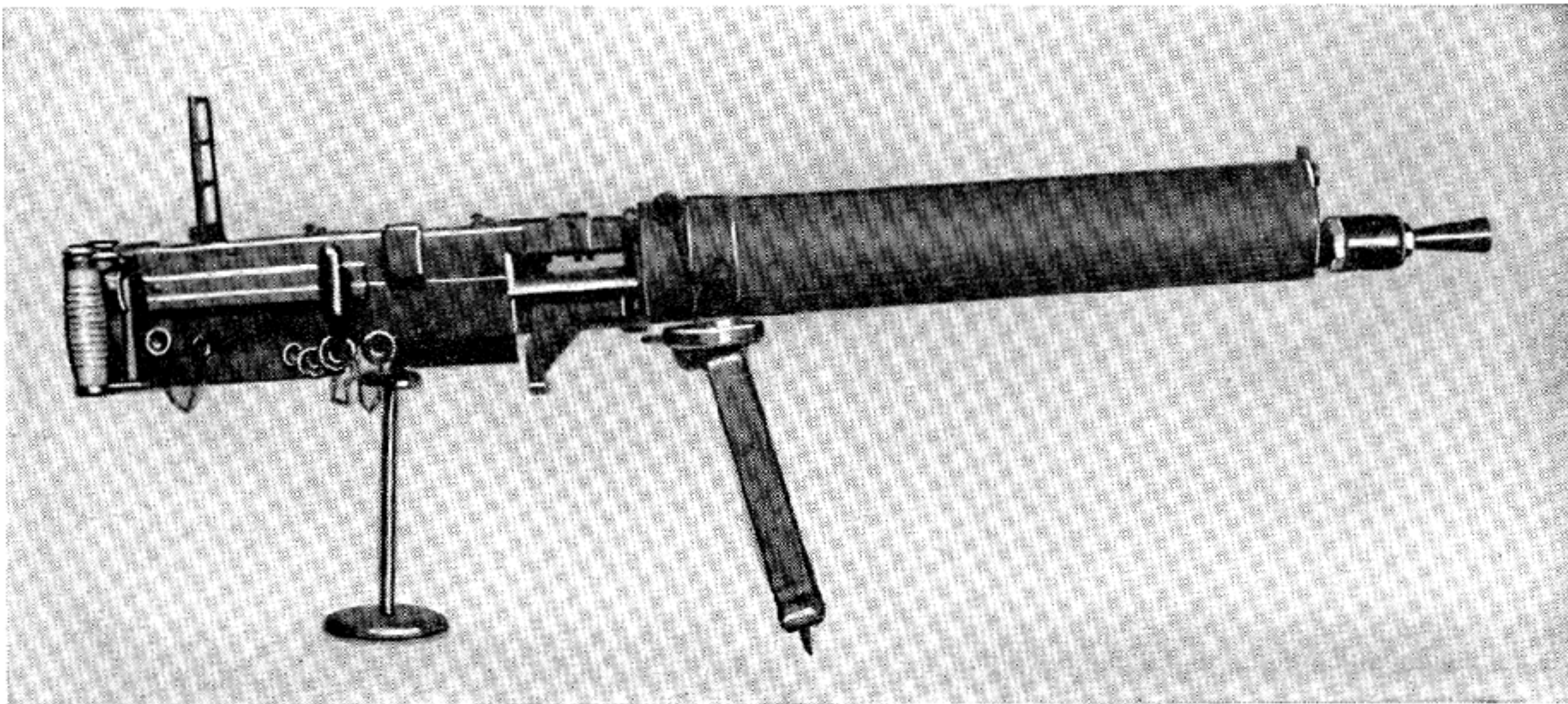

Dreyse Machine Gun, Model 1915, 7.92 mm.

any conclusions beyond proving ground reports, which showed it to be an unusually good weapon.

The Bergmann Co. was more successful with its assignment. It likewise used the simplest approach by lightening the receiver and components of its well-known Bergmann action. Good engineering paid big dividends, as the improved design was successful from the start. But the failure of Rheinmetall to furnish an adequate gun forced the use of this weapon for infantry, because the critical need for this type of weapon gave it priority even over air force requirements.

When both companies were ordered to produce their respective models, it was understood that either could use any patented features belonging to the other. For this reason the guns have been frequently confused because of similarities in a few respects.

#### Bergmann Model 1915, N.A., Machine Gun

A prototype of the successful Bergmann World War I gun could appropriately be called the Model 1915. This weapon had a few features that were found by test to be unnecessary. It had larger holes in the barrel jacket, which was itself of greater dimensions. The so-called 1915 gun was rear seared and at the end of a burst a spring-loaded device caught and held the bolt in the cocked position. A pull on the

trigger would release the firing mechanism to go into battery and fire the round.

The weapon that soon followed was given the designation, Bergmann Model 1915, N. A. (Neu Art, or new type). This weapon was equipped with a short shoulder stock and slotted barrel jacket for air cooling purposes. On the right side attached to the receiver was incorporated a curved sheet metal ammunition box holding 200 rounds of caliber 7.9-mm ammunition belted in either a web or a non-disintegrating flexible metal belt.

The weapon fired from the closed-bolt position, making a cook-off in an air-cooled barrel possible due to overheating of the chamber. Just why the rear searing of the prototype gun was not used cannot be readily understood, as it would have eliminated a very objectionable feature.

The main advantages found in the weapon were its simple but solid breech construction and the straight-line movements of all working components. The entire mechanism consisted of 81 pieces, and by raising the top cover all moving parts could be readily inspected or worked upon, if necessary. Although of rugged construction its weight still placed it in the light machine gun class. In the Model 1915 N. A., the use of a light barrel gave an increase in recoil speed over the one formerly used when it was water cooled. This hastened unlocking, thereby

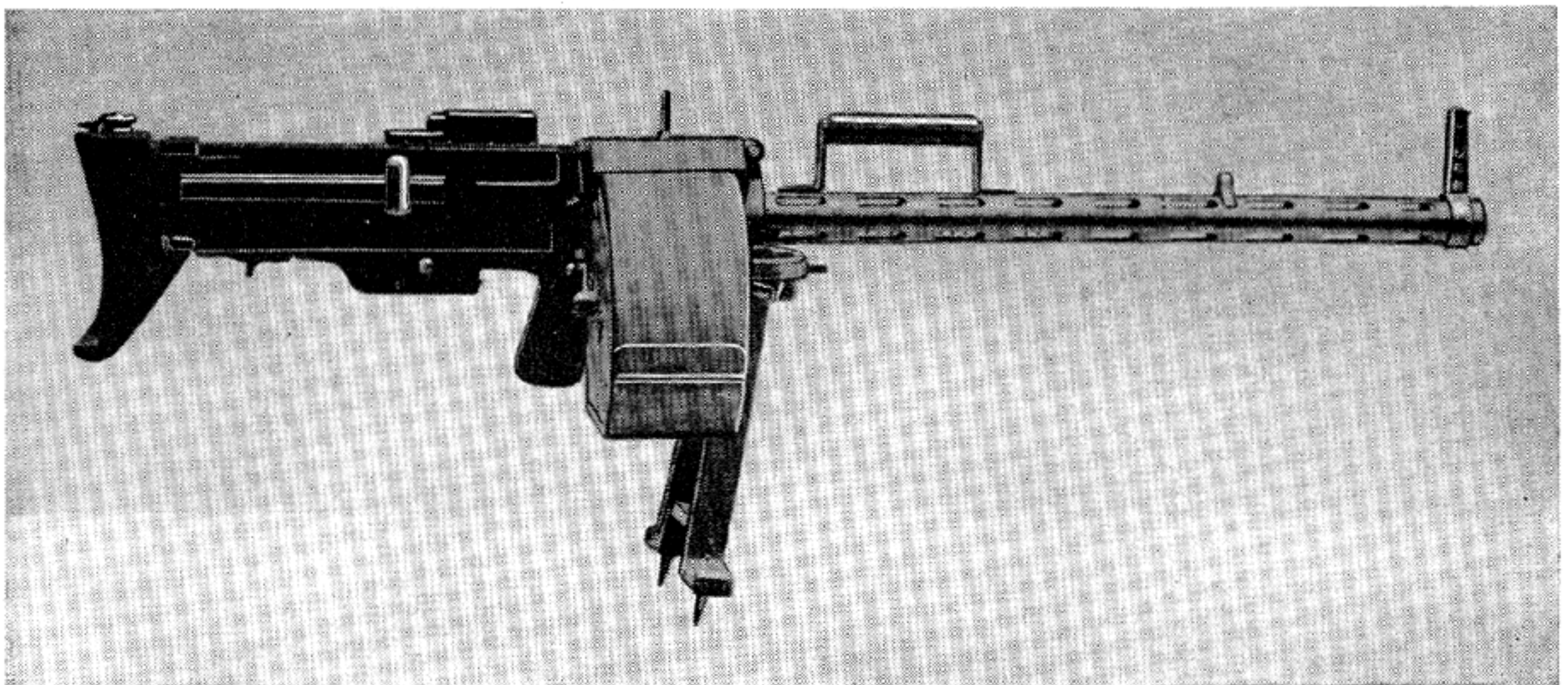

Bergmann Machine Gun, Model 1915, N. A., 7.92 mm.

adding materially to speeding up the cycle of operation.

The action was operated by a system known as short recoil employing the typical Bergmann lock where a rising block, vertically positioned under the bolt, locked and unlocked by a cam. To increase the rate of fire further, an improved accelerator similar to that of the Dreyse was used. It consisted of a curved lever vertically pivoted to the receiver with its free end resting against the rear of the bolt. When the gun recoiled to the point of unlocking, the semi-circular portion of the accelerator was struck by the barrel extension's rearward traveling shoulder at the exact moment the depressed locking piece was disengaged from its recess in the bolt. This sudden blow and the mechanical advantage of the accelerator hastened the bolt rearward and gave a cyclic rate of 800 rounds a minute.

A redesigned and stronger rear buffer, housed in the short shoulder stock, was placed on this model to compensate for the increased speed. By checking the previous designs of Bergmann machine guns it appears that the German engineers took a few good features of other mechanisms and after further refinement added them to their own action.

The ammunition belt runs in a slot and its movement is governed by a ratchet slide block. The movement of the block is actuated by the recoil of the barrel. During the rearward travel the feed slide is carried to the right to be positioned behind the cartridge. During counter-recoil movement of the barrel, the slide block returns to place, causing the round to be moved over one space.

In order to facilitate movement and to avoid binding with the barrel caused by pulling the loaded belt over one space each time it feeds a round, the slide block is continuously forced to the left by a strong spring which is compressed by the barrel during its recoil movement. In the earliest of the Bergmann automatic firing mechanisms the locking of the breech is accomplished by means of a block capable of taking up motion in a vertical plane, this movement being regulated by guides in the receiver body. The block upon rising locks the bolt to the barrel extension.

The very earliest model Bergmann used a special push-out metal belt that permitted the

cartridge to be shoved out of the link into the chamber. The Model 1915 N. A. employs either a metal or web belt that requires the pulling of the round out of its pocket to be carried rearwards slightly beyond its overall length before it could be positioned for firing. For this purpose a spring-loaded extractor claw in the feed slide removes the round and draws it to the rear. Another finger-shaped device, acting under influence of its spring, forces the cartridge down in front of the counter-recoiling bolt.

The Bergmann Model 1915 N. A. was of excellent design and had many features that made it highly adaptable for both aircraft and infantry use, but it was not so well known as other German machine guns. American ordnance officers in 1919, after the occupation of Germany, conducted a thorough test with the gun and reported it to be "well made, reliable and very light for a weapon of such rugged construction, but it did not show any outstanding features that were not already known nor was it considered as better than many other light machine guns of similar appearance." That the Germans counted heavily on the weapon is attested by the fact that after the Armistice the Inter-Allied Control Commission found over a thousand guns of this model in the Bergmann plant at Suhl.

To fire it, a loaded cartridge belt is placed in position and the tip is pulled to the left until the first round snaps behind the belt-holding pawl. The retracting handle is withdrawn all the way and released, only one pull being necessary to withdraw the cartridge from the belt and chamber it. The trigger is now pushed in to pivot the sear back, releasing the striker. Upon flying up, the latter hits the firing pin and detonates the powder charge. After the barrel extension, barrel and bolt recoil a distance of less than a half inch, the breech lock is cammed down by the angular surface in the bottom of the receiver. This forces down the front part located under the bolt, allowing it to recoil free of the heavier parts.

Actuated by the stud on the barrel extension, the accelerator then drives the bolt to the rear. The striker is caught by the bolt lock and held in its rearmost position by the safety sear. The base of the cartridge strikes against the right guide which serves as the ejector and kicks the

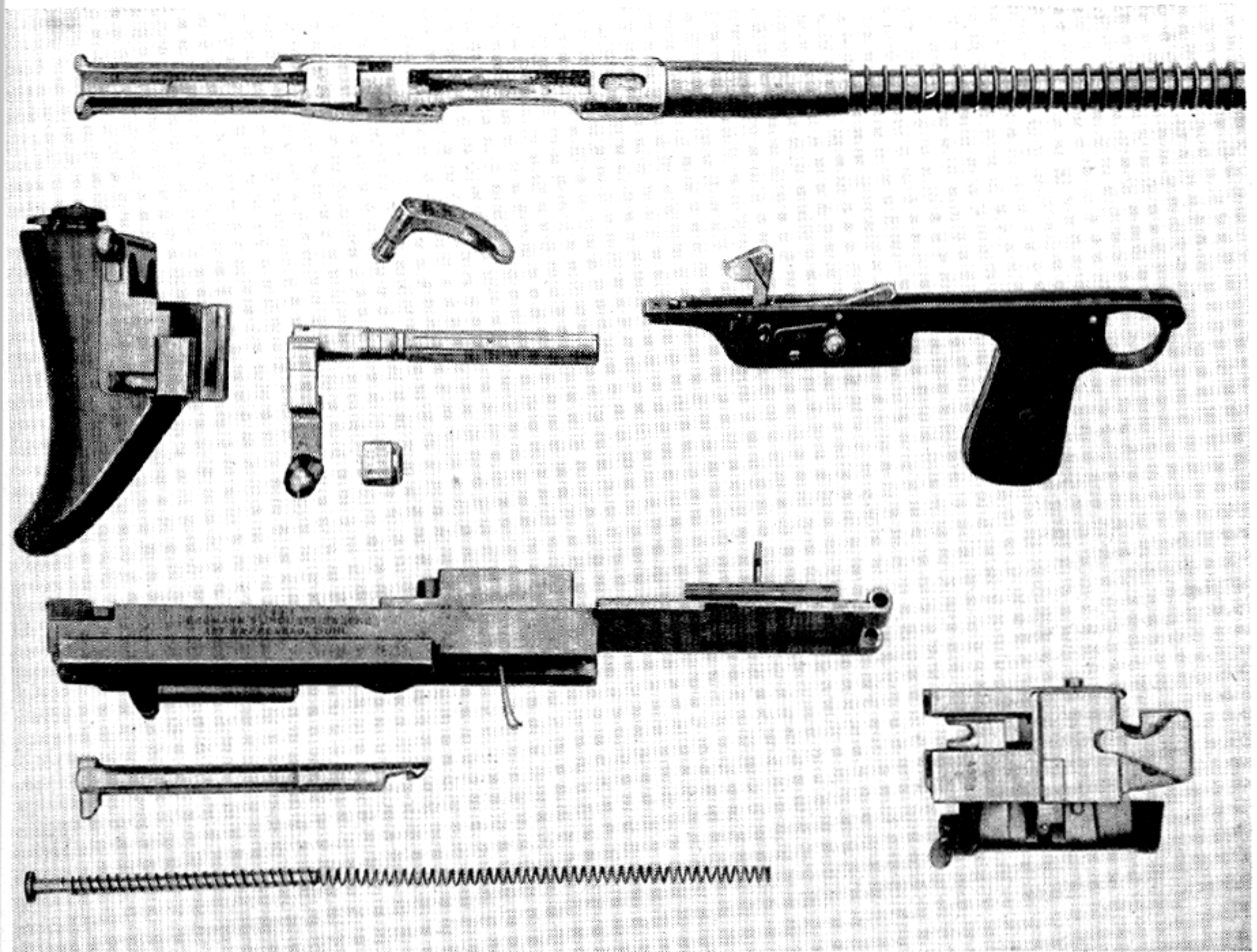

Components of the Bergmann Machine Gun, Model 1915, N. A.

empty cartridge out the left side of the gun at a downward angle. The claws on the main spring housing draw the new cartridge from the belt, and the housing, continuing to travel to the rear, contacts the feed lever by means of a stud. The longitudinal movement is thus translated into transverse motion, actuating the feed slide over one space, and positioning the incoming round.

The belt-holding pawl at the same time slips behind the next cartridge in the belt and holds it for the next phase. The claw on the main spring housing depresses the withdrawn cartridge into the feedway. The recoil stroke having reached an end, the stored energy in the driving spring then starts the firing mechanism forward. After chambering the round, the accelerator now releases the barrel and extension from a retracted position to go into battery. The locking block

which is then raised by the cam on the bottom of the receiver locks the barrel, barrel extension, and bolt together.

The stud on the main spring housing carries the feed lever in all the way to place the incoming round against a cartridge stop in position for the extractor claw to slip over the cannelure of the cartridge. A projection on the barrel extension will trip the safety sear if the trigger is still depressed. And the last forward movement of the locked bolt and barrel releases the cocked striker that drives the firing pin forward to fire the next cartridge.

### MG—13

After the Armistice the German ordnance department, when it found it was possible to ig-

nore the restrictions placed upon it by the Versailles treaty, attempted to develop an extremely light, short-recoil, air-cooled machine gun that could be transported and operated by the individual infantryman. Tactical changes had shown them that the lengthy bursts that only a water-cooled gun could perform were no longer necessary.

The Dreyse Model 1918 water-cooled machine gun, being one of the lightest and most advanced weapons of its type to date, was considered the most desirable to alter for this purpose, especially since a large number was on hand. There is a record that the Allied occupation commission found 3,000 finished weapons in water-cooled form in one factory as early as 1919. They showed

great refinement over the earlier 1915 model. These much improved weapons had been given the designation Dreyse Model 1918 in the closing days of the war.

The guns did not see action against the enemy. They represented the best effort the Germans had made toward light machine guns and little was done to change them from their original form until Hitler came into power. Then all Dreyse machine guns in existence were immediately ordered to be reworked for the purpose of lightening and streamlining as much as possible. The firm of Simson & Co. of Suhl, Thuringia, was given the main contract to modify and refine the weapon.

It is very difficult to recognize the weapon

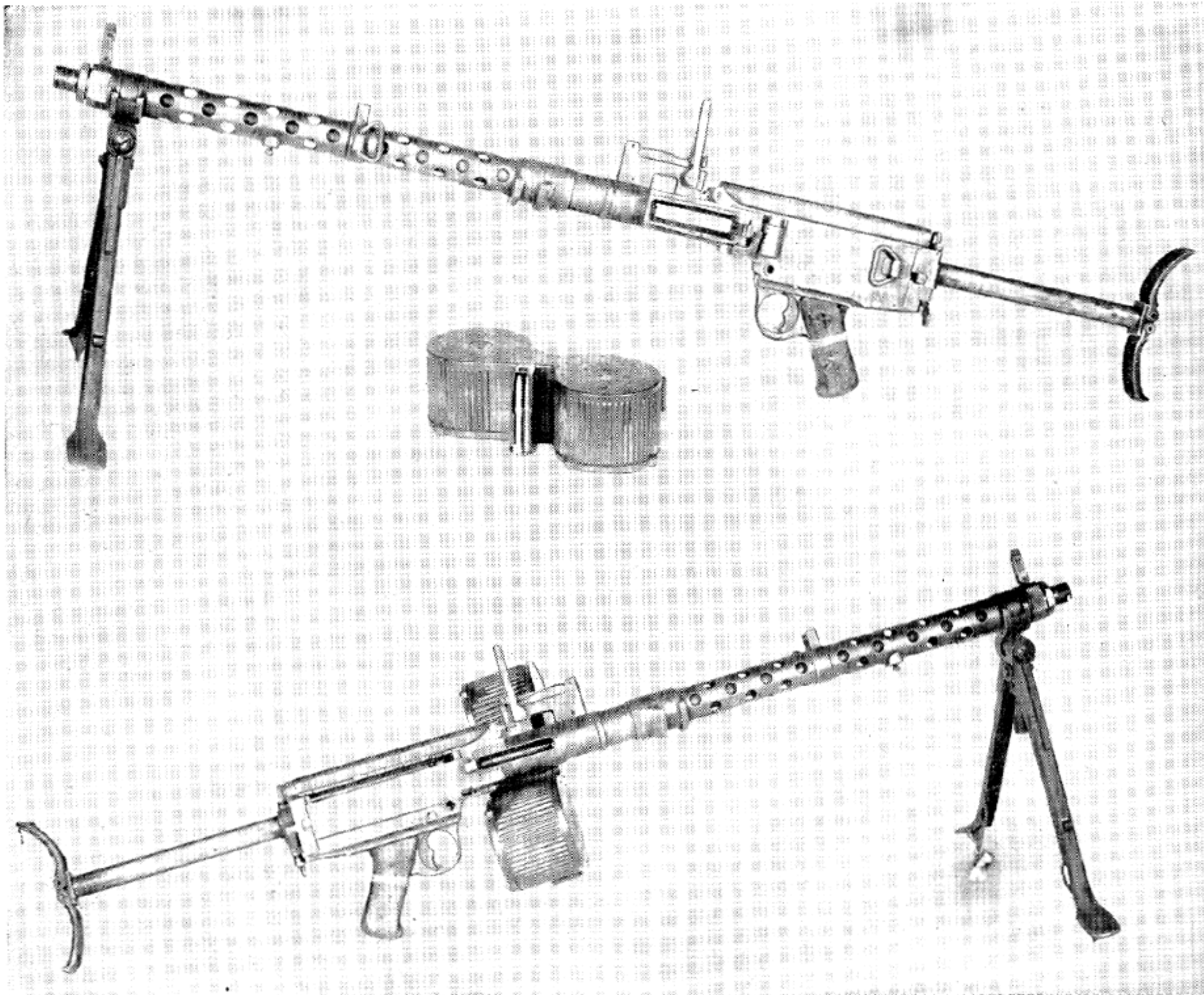

Machine Gun, Model 13, 7.92 mm.



visually as a modified Dreyse Model 1918. It is further confusing that under the Hitler regime all automatic weapons were given a number and no other form of identification. This particular weapon became known officially in Germany as the MG-13 and as late as 1935 it was the main machine gun for German infantry units and engineers and for anti-personnel use on tanks, armored cars, and motorcycles.

The principal changes on the MG-13 from the parent gun were the replacement of the water jacket with a ventilated air-cooled one, the addition of a lightweight shoulder stock and pistol-grip trigger housing, the elimination of the belt feed and the substitution of a spring-loaded slightly curved 25-shot magazine that could be filled directly out of the five-shot cartridge clips. When the last shot in the magazine had been fired, the firing mechanism was held back in the rear position by the slide catch. The cover group opened up as in the old Dreyse but the rear end or back plate was hinged down. These two opera-

tions made all working parts instantly available for inspection or maintenance by first swinging the accelerator out of the way. It also permitted dropping the hot barrel out the rear end in the event a quick change was needed. A selector switch located on the left side of the receiver over the trigger guard gave the gunner a choice of either single shot or automatic fire by mere pressure of the finger.

A combination muzzle booster and flash hider was used on this version. The booster, added to the recoil forces, gave a maximum rate of fire of 750 rounds a minute. A saddle-shaped drum magazine was later designed that held 75 cartridges and was mounted underneath the receiver. This design was resorted to in an effort to be able to carry enough ammunition in a magazine for a substantial burst and still not have the heavy loaded magazine too far off the center line of action. This would result in poor dispersion during automatic fire.

The gun's main importance lay in its use as a



German Troops Training with the MG-13.

training weapon for Hitler's new army while German manufacturers and inventors were working desperately to produce a more perfect instrument. The Dreyse MG-13's were eventually withdrawn from service and held in reserve until

just before World War II. The bulk of them were then sold to Spain and Portugal. Spain retained the German designation but Portugal called them the Dreyse 1938 after the year of acquisition.

## VILLAR-PEROSA AIRCRAFT MACHINE GUN

On 8 April 1914 Bethel Abiel Revelli, then a major in the Italian Army and residing in Turin, applied for patents on a machine gun designed primarily for aircraft use. This very interesting weapon was the forerunner of a number of aviation weapons invented by this officer. Revelli's claim to fame is originality of design, as is evidenced by his other machine guns the novel features of which have since been copied and adapted for present day weapons.

Revelli's attempt became internationally known as the Villar Perosa, because he assigned patent rights to a company of that name in Pinerola, Italy, which manufactured the unusual-looking gun. It was double barreled and could be fired simultaneously or separately at will. It may be classified as a retarded-blow-back, magazine-fed, air-cooled, dual-mounted aircraft machine gun. The short barrel version weighed only 14 pounds 4 ounces with the loaded 50-round magazine attached. The barrels were chambered for the 9-mm Parabellum pistol cartridge which was at the time being used in the Italian Army's service pistol.

The reciprocating parts, bolt and striker, were

very light, weighing only ten ounces and had a travel of only  $1\frac{3}{4}$  inches. This factor tended to give the weapon a phenomenally high rate of fire, it being officially rated at 3,000 rounds a minute, or 1,500 per barrel. Many guns were converted to ground use where they proved more successful than for aircraft. The small pistol-type cartridge did not have sufficient aerial striking power. Utilization of these weapons by infantry is said to have started the design of submachine guns for such a purpose.

A large number of Villar Perosas fell into the hands of the Germans and Austrians following the Italian disaster at Caporetto in October 1917. The Germans immediately set to work producing their version of a machine pistol that they felt was adequate to the needs of their infantry troops. It is odd indeed that the first weapon to be designed solely for aircraft failed in that department but showed a need for such a gun for ground troops.

Major Revelli, in presenting his weapon before an ordnance board for an official test, described its action in the following manner:

"The Villar Perosa consists of two distinct but

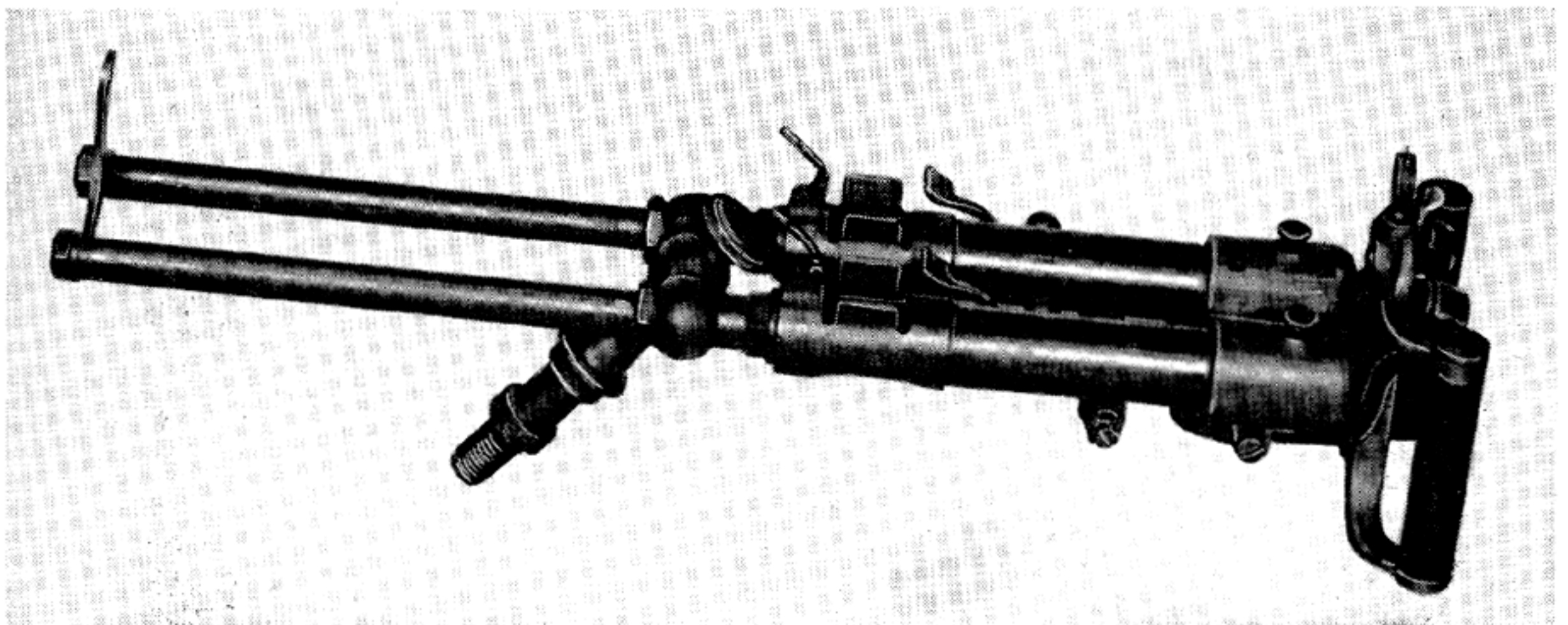

Villar-Perosa Aircraft Machine Gun, 9 mm.

identical breech and firing mechanisms and is provided with barrels connected by a cross bar. It has two fixed handles one of which serves for training and the other for elevating purposes. Each of the breech and firing mechanisms comprises a hollow cylindrical casing provided with a lower lug and screwed to the corresponding rifle barrel.

"In the breech casing a block provided with a projection carrying a handle slides longitudinally with a small rotary movement. The front and rear faces of the shoe or projection are each formed with a right-handed helical surface. It slides in a slot formed in the breech casing and is rectilinear for the major portion of its length, but helicoidal at its forward end wherein the projection is guided by two helical faces. The breechblock is hollow and within it slides a cylindrical percussion pin or striker provided with a projection to guide it in the rectangular portion of the slot. The front face of the tooth is formed with a left-handed helical surface bearing on the helical face of the breechblock in order to insure the passage of the striker beyond the head of the block when the latter is rotated in its closed and locked position. The percussion pin or striker is hollow and contains in its interior a coiled spring that controls it. This spring is mounted on the guide rod of the closure plug screwed to the breech casing.

"Around the forward end of the breech casing a sleeve is rotatably mounted provided with projections serving to fix the magazines during firing. A spring-controlled stop maintains the said sleeves in both positions. The breech is provided with a stationary or fixed ejector adapted to engage a corresponding slot formed in the breechblock. The latter has a levered extractor pivoted and actuated by a spring.

"The mechanism of each gun is naturally identical. Being in duplicate, they are connected at the forward end by means of a bent cross member with the front sight at the forward end of the cross bar. The butt end carries the rear sight, which has a graduated opening for the different distances to be used in firing. This latter cross member is fastened at its forward end to two cylindrical cavities into which the two breechblocks are inserted, and held in place by means of pins. Below this piece two triggers are

mounted, each having an L-shaped projection on the upper arm. This member also has a safety lever with spring stops governed by the controlling handle. Two lateral locking arms, according to the position of the handle, engage underneath the safety buttons and prevent firing or leaving the said buttons exposed to accidental contact."

Each magazine is provided with a socket having projections with which the sleeve engages as soon as it is rotated for fixing the magazine. The latter is somewhat curved in order to account for the slight conicity of the cartridges so that the latter, although superimposed in variable number, constantly present themselves in front of the barrel opening forming a certain angle with respect to the barrel. The magazine may contain 25 or 50 cartridges in double rows, whichever number is found necessary. It consists of a rectangular casing with rounded-off edges and terminated at the bottom with two lips that curve in such a manner as to retain the cartridges.

In order to fire the Villar Perosa, the breechblock is drawn backward by the retracting handle until it automatically engages its sear. Subsequently the safety lever is brought into the locked position. The cartridge magazine is then placed on the breech casing and secured thereto by means of the sleeve. The gun is trained, the safety is then rotated into a releasing position and the button depressed for firing. The breechblock and the striker advance simultaneously under the action of the driving spring and the former pushes a cartridge from the feeder into the chamber. At the end of its rectilinear travel the breechblock is forced to turn to the right under the action of the helical part of the slot formed in the breech casing. At the same time the striker continues to advance with respect to the block.

The sliding of the helical surface of the tooth on the corresponding face of the notch formed in the breechblock results in firing the shot. The gases of the explosive charge start the projectile through the bore while they tend to push back the breechblock. The latter offers resistance for a moment in view of the inertia of its mass and the resistance offered by the helical notch formed in the casing. Subsequently, it recoils completely withdrawing the empty cartridge with the ex-

tractor until the cartridge strikes the ejector and is thereby expelled.

If the firing button is kept in a depressed position, the weapon fires continually until the cartridge magazine is exhausted. One of the most outstanding features of the Villar Perosa is the simultaneous closing of the breechblock with the advancement of the striker. The rear shoul-

der of the helical notch acts as a stop during the movement of parts into battery and as a friction brake to reduce the speed of unlocking during the first stage of recoil. The combined system has only a single degree of freedom, so that any displacement of either one of these two elements (the breechblock and the firing pin) definitely constrains the movement of the other.

## S. I. A. AIRCRAFT MACHINE GUN

One of the early Italian designs of an automatic firearm was originated by Giovanni Agnelli, of Turin. Although he applied for a patent on 17 February 1914, the weapon lay dormant for several years. Agnelli's rights were assigned to the motor firm, Società Italiana Ansaldo of Turin, and hence acquired the designation, S. I. A. Near the close of the conflict the government of Italy placed an initial order with the Fiat Co. of Turin for 10,000 aircraft machine guns utilizing Agnelli's S. I. A. design. Each gun, complete with necessary spare parts and 15 magazines, was to cost \$320 at the factory.

The weapon was chambered for the 6.5-mm model 1891 infantry rifle cartridge. This specification in ammunition was considered very important in Italy since its other machine guns were chambered for several different calibers making the burden of supply heavier. Great Britain had heretofore furnished ammunition for Italy's automatic weapons and it was felt that should England not be able in the future to export this crucial item the situation would be desperate. It was therefore decided to standardize, beginning with this machine gun, all future design in order that the Italian infantry rifle cartridge could be used.

In early tests the S. I. A. aircraft model gave what the authorities termed "satisfactory re-

sults," both as a free gun and fixed installation. When used as a free gun, it was invariably mounted in pairs. It did not, however, give good enough performance to take the place of the English Vickers then being used in the fixed forward firing positions. Still, the S. I. A. was modified to take the Vickers synchronizer in the event a change-over should prove necessary.

Neither the S. I. A. aircraft gun nor its ground model saw service in World War I. Although 2,000 were manufactured for the air force and 3,000 for the ground forces in the summer of 1918, the actual date of issue was immediately after the Armistice. It is believed that the Italians were holding them until perfected so they could be thrown into the big spring offensive planned for 1919. Immediately following the end of hostilities the army, confident of its superior design, issued the S. I. A. as its standard light machine gun and it was so considered throughout the twenties. It had a maximum rate of fire of 700 rounds per minute.

The vertical-type magazine held 50 cartridges for ground guns and 100 for aircraft use. Its body was rectangular in shape and made of stamped sheet steel, the cartridges fitting into place in an oblique angle five cartridges in width. This unusually wide magazine located in the center of the receiver made the weapon unwieldy, es-

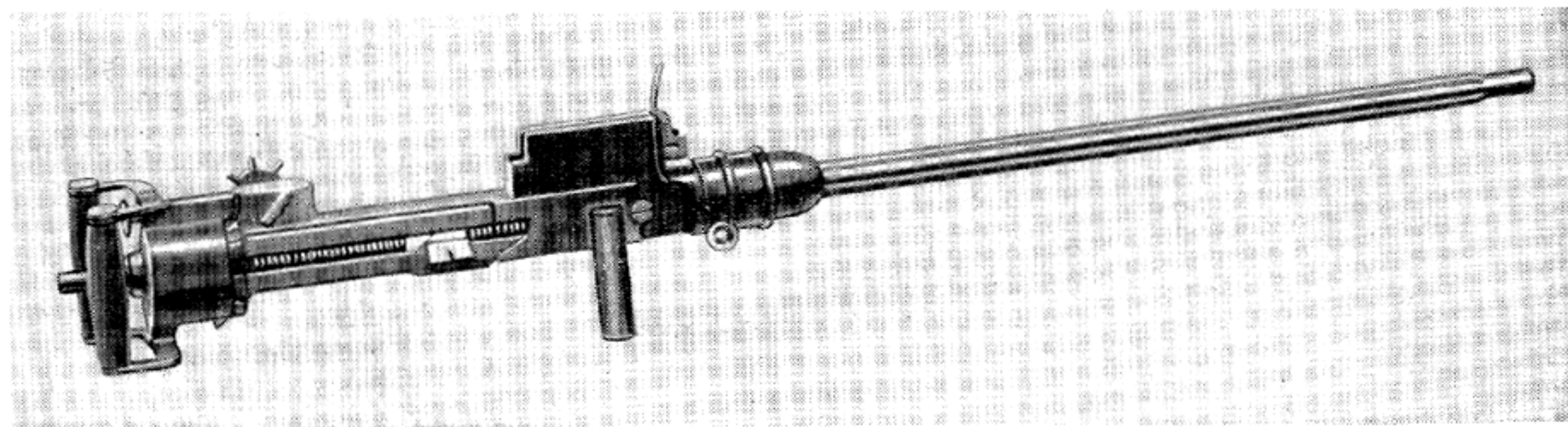

S. I. A. Aircraft Machine Gun, 6.5 mm.

pecially with the 100-shot version, while sighting had to be mounted in a well offset position to compensate for the magazine.

Both the aircraft and ground guns had spade grips and all other features were identical, except for the cooling system. The aircraft model had long splines cut the full length of the barrel. This advanced feature not only gave greater radiation surface but also strengthened the barrel greatly, cutting down dispersion. The ground gun employed a heavy barrel together with unusually large circular aluminum fins, that extended all the way to the flash hider. For some unknown reason these fins remained the same size the entire length of the barrel, giving the weapon an extremely heavy appearance. On another style of barrel assembly the radial fins increased in size as they went forward, creating the

most awkward silhouette to be found on any machine gun.

A collar shaped device located on front of the trunnion joined the barrel and trunnion by a quarter turn rotation. The funnel-shaped breech end of the barrel served as a cartridge guide. The sight arrangement, which was offset to the left of the magazine, consisted of a rotating three-part affair graduated at 300, 700, and 1,000 meters. The charging handle was located on the right side and after full retraction it was shoved forward by the gunner until it locked in its spring-loaded detent.

The safety, located on the upper right rear on the receiver, was marked *S* (for *Safe*) and *F* (for *Fire*). The S. I. A. had no provision for single shots and when the gunner pushed selector button *F*, full automatic fire was accomplished. The

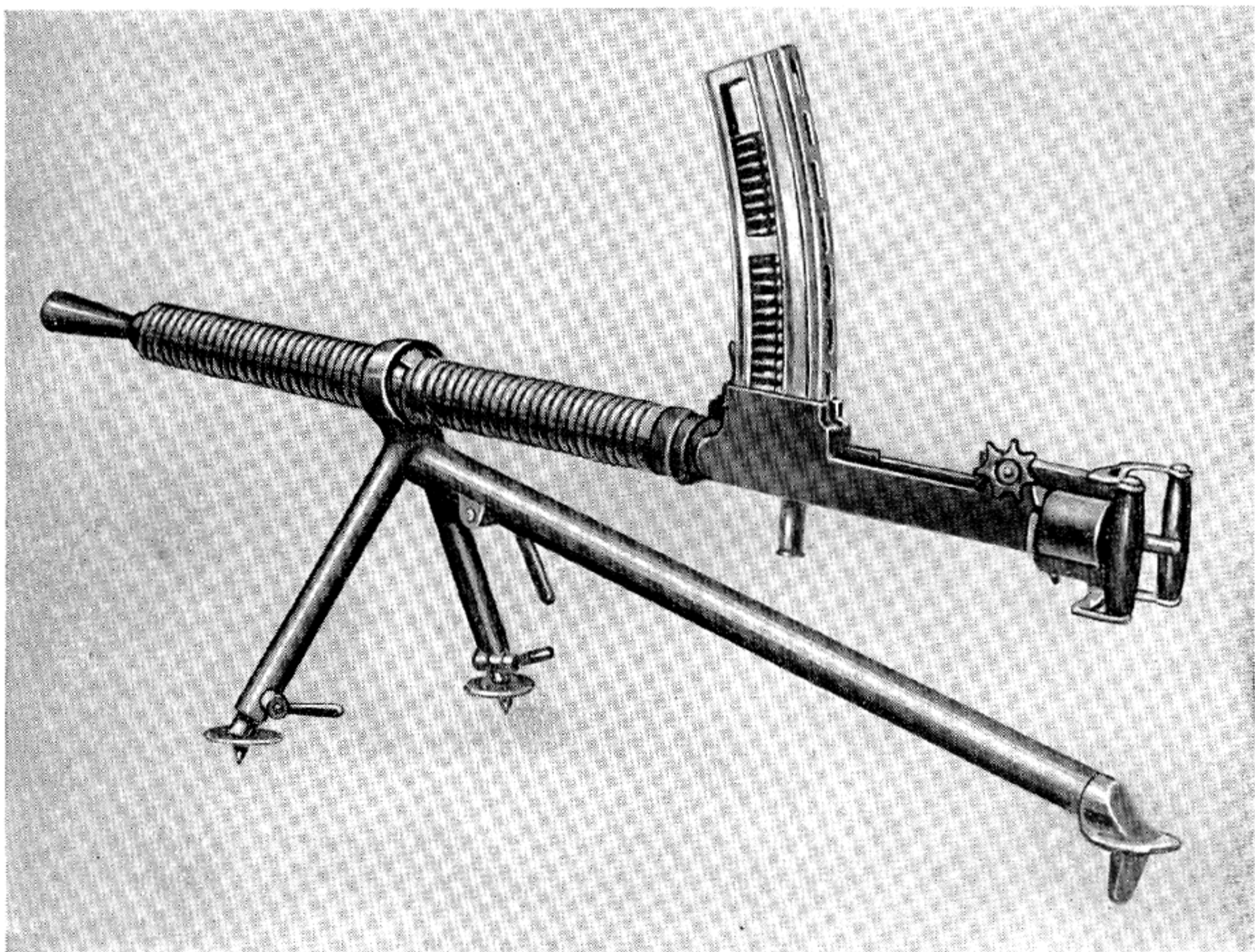

S. I. A. Machine Gun, 6.5 mm.

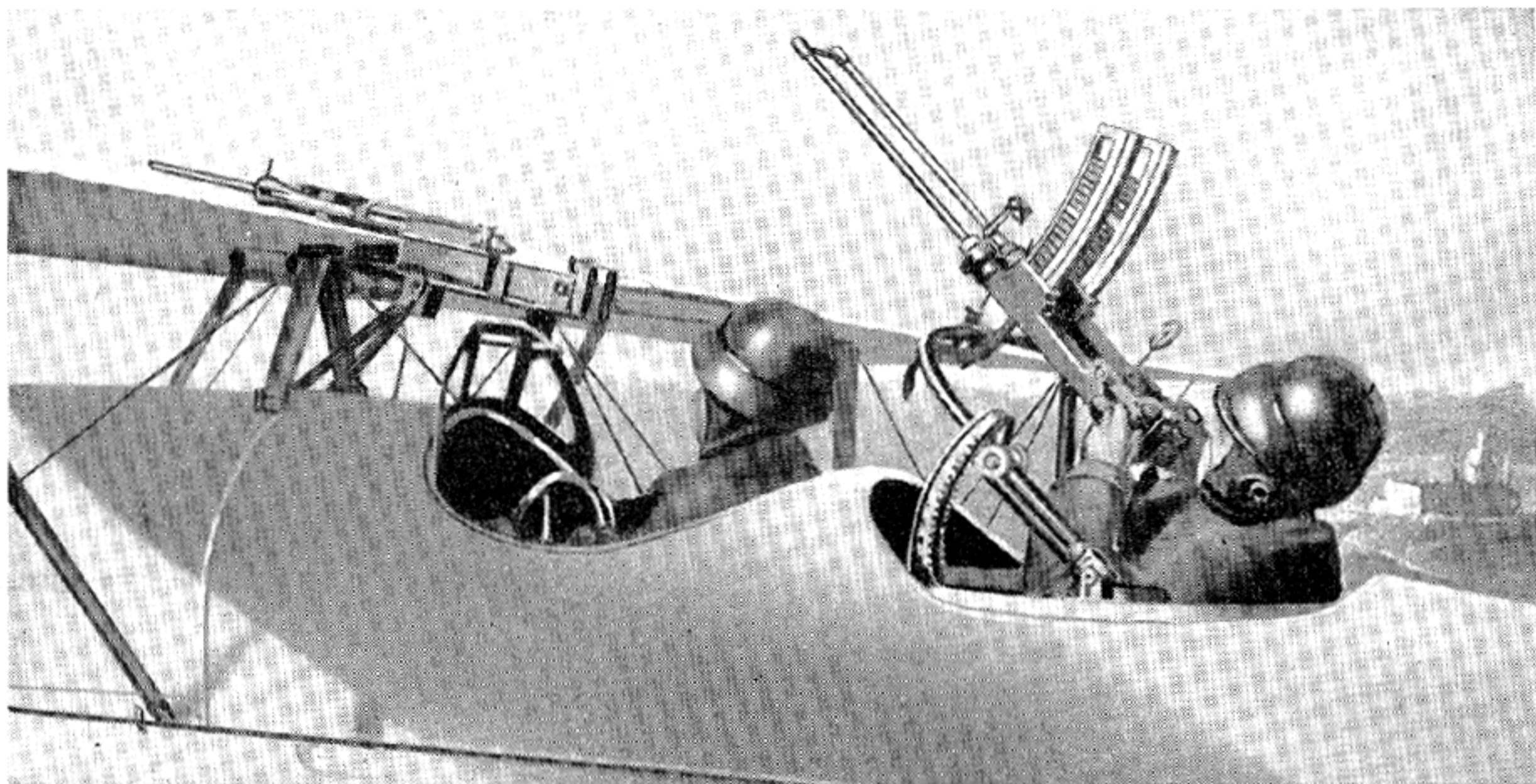

S. I. A. Aircraft Machine Gun, 6.5 mm, Dual Flexible Mount.

ejector, which was fastened in a T slot in the receiver body, passed through a slot in the bolt body. A recess was cut in the rear of the bolt to furnish a relief at the point where it turned to lock.

The sides of the ejection slot in the bottom of the receiver were machined to permit the addition of a container to catch the empty cartridges. This arrangement was used when the gun was mounted as a free gun to prevent flying brass from injuring tail surfaces of the aircraft or hitting other friendly planes in formation.

The bolt was round on its rear portion with its front half cut away to form a flat surface a little above the center line of the firing pin. On the right side appeared the locking lug, a beveled projection that traveled in a slideway until it was cammed down in the receiver body's locking recess by the advancement of the firing pin lug housed centrally in the bolt body.

To fire the S. I. A., the operator installs a loaded clip in its recess on the receiver until the release lever on the front of the bracket clicks, shoving it securely in position. Then as the charging handle on the right is grasped, it is freed of its detent-holding pawl and pulled rearward. The front bottom piece of the retracting

assembly has a cam angle cut at this point that engages the locking lug and frees it from the receiver to which it has been locked. This movement also jacks the firing-pin assembly back to the cocked position by partial rotation of the engaging cams. With the weapon unlocked and firing pin retracted, the recoiling assembly is pulled rearward until the searing device in the upper part of the receiver drops into its recess. All parts are held to the rear under tension of the driving spring that has been compressed by the retracting movement.

The charging handle is then shoved all the way forward until it is locked in place by a short spring-loaded detent. Such locking is very necessary before firing in order to prevent faint strikes.

If the selector has been set on *F* and the trigger button pushed forward, the entire firing mechanism is impelled forward by the large driving spring. As the upper bolt face passes the rear of the magazine, it strips the positioned round and starts to chamber it. Continued forward travel carries the nose of the bullet into the funnel-shaped recess in the barrel's breech that guides the ammunition into the chamber.

When the lug on the bolt has reached a place above the locking recess in the receiver, the round has been fully chambered. The 45° angle



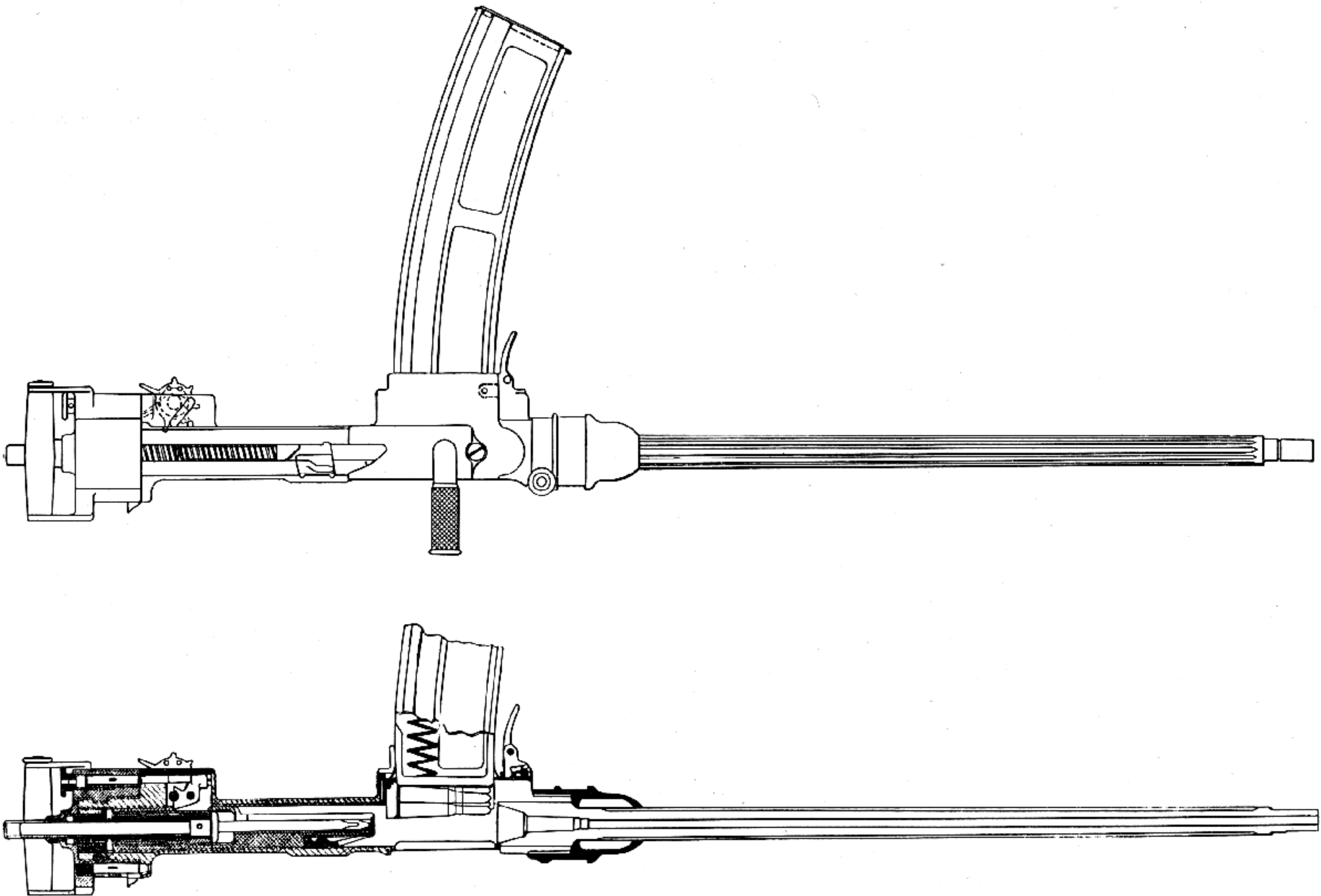

Section Drawing of S. I. A. Aircraft Machine Gun.

on the firing pin, riding in engagement with the corresponding angle in the bolt body, rotates the bolt a fraction of a turn downward, freeing the firing pin to continue advancement under influence of the operating spring. This drives the firing pin into the primer to discharge the weapon.

Until the bullet is out of the bore, the gun is secured by the locking lug of the bolt. Its disengagement with the face of the locking recess in the receiver is thus slowed. This slight hesitation is known as retarded blow-back, as the locking angles hold only long enough to permit the bullet to clear the muzzle. The weapon then unlocks

and the blow-back, or high residual pressure in the bore, further actuates the mechanism.

The bolt starts rearward, carrying with it the lubricated cartridge case, held by the extractor at its base until it collides with the ejector that is riding in a groove in the bolt body. When struck, the base of the round is pivoted down out of the ejection slot in the bottom of the receiver. The strong driving spring, the only spring working during operation of the weapon, is being compressed all the time until it stops the bolt before it reaches the rear of the receiver. If the trigger button remains pushed in, the cycle of operation will repeat itself.

## GAST AIRCRAFT MACHINE GUN

After the successful conclusion of World War I as far as the Allies were concerned, it was found the Germans had been desperately trying to put into action a secret weapon, namely a machine gun capable of firing at a rate of 1,600 shots a minute. In order to turn out this high-speed gun, it was given the highest priority of manufacture, even over aircraft. The weapon first produced in January 1916 by Carl Gast of Barmen, Germany, was very similar in principle to an automatic machine gun patented by Bethel Burton in Great Britain 22 March 1886 (No. 4,008). It was a double-barrel machine gun of the recoiling type. The object was to provide an improved means of operating the firing mechanism and in doing so, to produce a cyclic rate higher than is found in standard automatic weapons.

In order to accomplish this, the two barrels were combined in such a manner that each recoiling breech and firing mechanism furnished the energy to lock and fire the other. The whole system was based on the fundamental idea that with the explosion of each shot, the recoiling force from one barrel could load, fire, extract, and eject the rounds in the other barrel. In this

way a series of uninterrupted shots could be obtained. In trials the Gast fired at rates of 1,600 rounds per minute, as issued, and with a spring-loaded recoil adapter to buff the action and hasten its return, cyclic operation was stepped up to a rate of 1,800 shots per minute. There was also a means of firing single shots if desired, and the construction was such that should one barrel be put out of commission, the other barrel could fire single shots.

The ammunition was not fed in belts of disintegrating links, as was customary, but in magazine drums that were fastened by slipping them into position on the sides until the holding latch snapped into place. These flat circular drum feeds were placed on the sides in order to make ejection possible from the dual mounting. Each drum, which contained a strong spring that was compressed tighter as each cartridge was placed in position, had a maximum capacity of 180 rounds of the standard German 7.9-mm rifle caliber machine gun cartridges. The changing of the feed devices was accomplished by an experienced gunner in a matter of seconds. The light weight (60 pounds without ammunition) and the

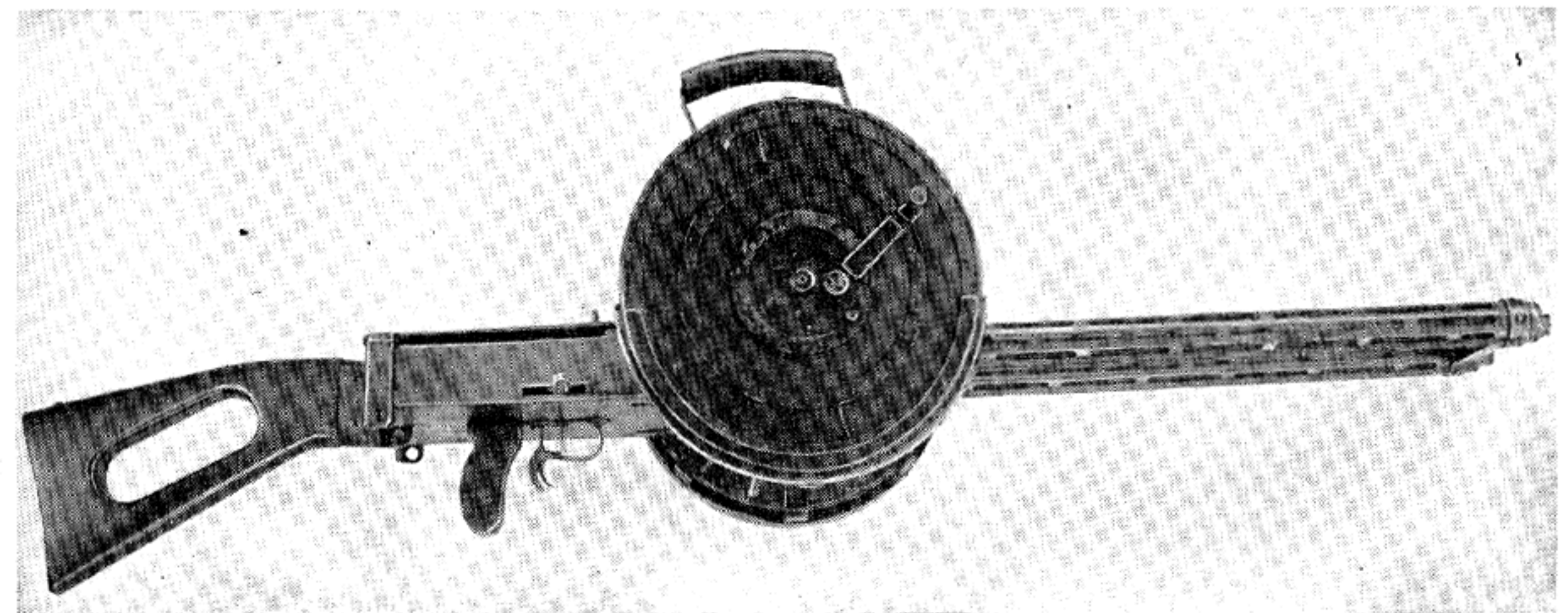

Gast Aircraft Machine Gun, 7.92 mm.

phenomenally high rate of fire made the German air force feel that the Gast was the perfectly designed aircraft gun and according to all available records it was expected to sweep the skies clear of opposition if enough could be installed in time.

For aircraft installations a high-power telescope with cross hairs for sighting was mounted on the receiver midway between the magazines. Another attractive feature was that all working parts were instantly accessible by the application of thumb pressure on the back plate latch. One minute was all the time required to field strip the piece.

Following a successful demonstration of the Gast, promoted by Vorwerk and Co. of Barmen on 22 August 1917, ordnance representatives were so impressed that the company was immediately given an order for 3,000 guns with necessary spare parts and ten drums for each gun. They were likewise given the highest production priority. A price of 6,800 marks per unit was set, including the drums.

Vorwerk agreed to the terms and promised to furnish 100 complete units by 1 June 1918 and to increase delivery by 100 a month until September; after that it was estimated 500 a month could be delivered. Records show the contracting company delivered far more than promised. Such results can be accounted for by every effort being made to supply vitally needed materials to the firm for production, sometimes at the expense of other badly needed equipment. This fact shows that the authorities looked upon the Gast as the one thing that could change the desperate situation of the Germans when they lost air supremacy to the Allies.

The following letter from the commander of

the German Trial Section for Arms dated 20 September 1918 to Vorwerk indicates the desperate pressure being put on the company:

"Referring to my repeated telephone conversations of these last days with your firm, I request you once more to deliver Gast machine guns with the greatest possible speed.

"The strained situation on the battle fields urgently requires the use of superior and most modern arms. The Gast gun is being used with great success on battle-planes, for scouting as well as for anti-aircraft. I therefore urge the firm to deliver these guns in large quantities and with the greatest possible speed.

"Changes in construction are not necessary on account of the present favorable results and the reliable working of the guns. A further order of about 6,000 guns will be passed shortly by the office involved.

"With a view to the favorable reports which reached the commanding general about the Gast gun and his request for more machine guns, I feel obliged to point out to you the necessity of the prompt delivery of large quantities.

"(Signed) LOCHTE,

*"Commander of the Trial Section for Arms."*

While records show they had limited use in actual warfare, the secret was kept so well by the Germans that not until 3 years after the Armistice did agents of the Inter-Allied Control Commission uncover a secret hiding place near Königsberg, where 25 Gast machine guns, ammunition, and manufacturing drawings were found. They were turned over to the Aeronau-

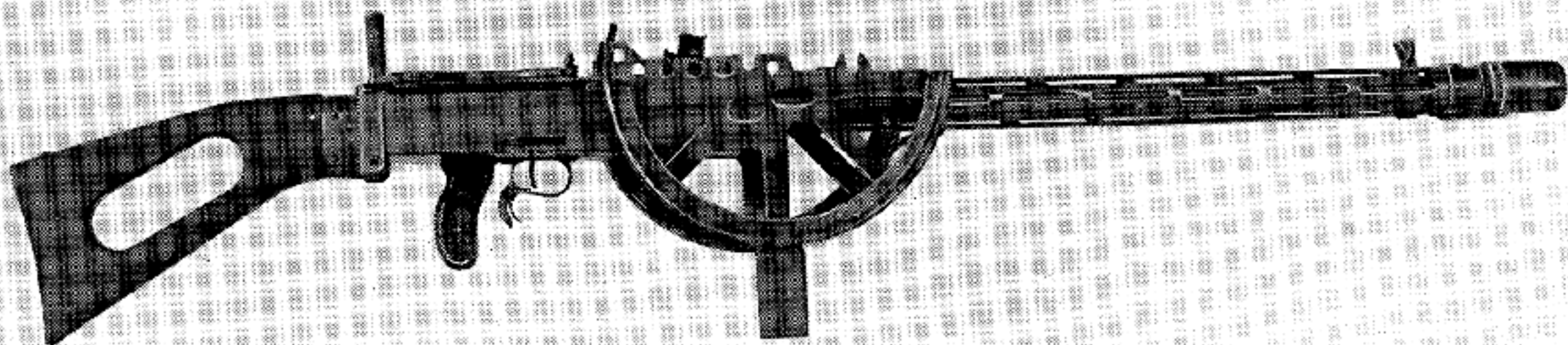

Gast Aircraft Machine Gun, 7.92 mm, With Feed Drums Removed.

tical Control Commission in Paris for study and test.

Army Intelligence a short time later gained possession of a letter from the German office of aeronautics, an agency that according to the Versailles Treaty was not supposed to be in existence. This agency, operating secretly, as can be readily seen from the contents of the translated captured documents, was not only functioning but was also trying to arm Germany with the last word in aircraft machine guns for the day she would again take the field against the world. This letter to Vorwerk & Co. from the underground German bureau is given verbatim, as it shows better than any other medium of expression not only its high regard for the Gast gun but also its careful preparing for another war:

“CHARLOTTENBURG, Nov. 18, 1921.

“The firm Vorwerk & Co.,  
Barmen.

“The Gast gun made by you having become of no use any more at the front, I feel obliged to state that at the present moment we still consider the gun of the latest type. The accuracy of the work and the firing were never, not even approximately, attained by the other hitherto existing machine gun systems.

“We may say that the Gast gun may be qualified as the ideal of the aeroplane armament. We also declare that you can further continue delivering the remainder of the complete order for 3,000 guns.

“If, with a view to the *present circumstances* some doubt might have arisen as to this delivery, I certify herewith that we shall fulfil the obligations of the contract. I enclose herewith certificates from the command of the trial section at Döberitz as also from the officer in charge of the Air Service who gave his instructions for the use of the weapon in flying planes at the front.

“Thanking you for having provided the Aviation troops with such a remarkable gun, I shall also be very much obliged to you if you will also thank the constructor, the engineers and workmen who handled this arm.

“(Signed) BUFE.”

After the uncovering of the Gast guns and

manufacturing drawings the American Ordnance Department requested that the Allied Commission make available for test and evaluation at least one of the guns and 4,000 rounds of ammunition. After exchange of much correspondence, on 14 March 1922 one Gast gun, serial number 156, and 3,838 rounds of 7.9-mm rifle caliber ammunition were received by the property officer of the Munitions Building in Washington, D. C. However someone negligently forgot to send the drum magazines and there was another long delay before the weapon could be officially tested at Springfield Armory, Springfield, Mass.

In the meantime the War Department was notified that United States patent rights had been assigned by the inventor to a mechanical engineer, Mr. H. C. Isenberg, of the George W. Goethals Co., New York City, and that, if the Army was interested in the gun for purposes of adoption, Isenberg would represent Carl Gast. After limited firing on the Springfield range the following conclusions were reached by the examining board which met on 17 August 1923:

“The Ordnance Department having tested the 7.9-mm machine gun is now familiar with its construction, operation and functioning. . . . The gun is practical mechanically and operates reliably. It is sturdy and a good type of recoil operated machine gun. However, it offers no advantage over standard types now in use in the United States Army, and if adopted would require entire new facilities for its production. As it is not believed to be superior to the Browning gun, and as there are ample manufacturing facilities for the Browning gun, the recommendation is made that no action be taken looking into the acquirement of any rights in manufacturing the Gast gun or acquirement of additional ones for further test.”

The report was signed by J. P. Wilhelm, Assistant to the Adjutant General, U. S. Army.

The American representative, Mr. Isenberg, feeling that the weapon had not been subjected to enough test to warrant rejection on the grounds stated above sought through the Secretary of War to have the board submit to him a written statement as to the reason for rejection on evidence gathered from actual test. He insinuated that it was not proper to come to a

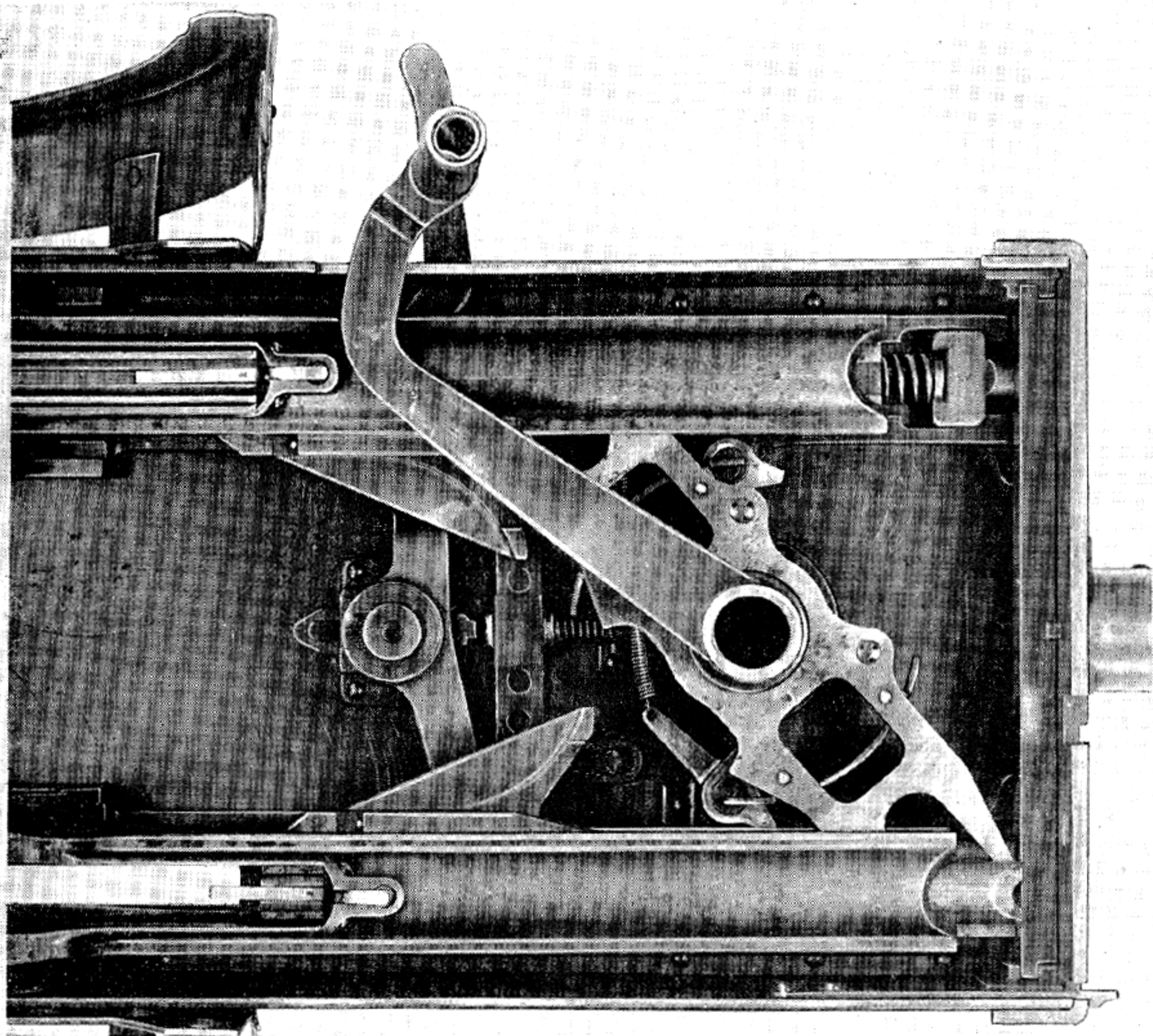

Breech Mechanism of Gast Aircraft Machine Gun.

conclusion that a weapon had no value to the Army when it did everything claimed on submission for testing. The Secretary of War refused this request and nothing more was done about the Gast in the United States.

To fire the Gast machine gun, the operator first places into position two loaded drums and pulls the loading lever with the right hand smartly to the rear until the firing mechanism, then in its most retracted position, goes fully into battery. On the way forward the bolt face forces the incoming round into the chamber and the firing pin is compressed by means of a

stationary collar contacting the U-shaped projection to which it is attached.

During the last portion of forward travel the release pin of the charging lever strikes against the slide stop and swings it out in such a manner as to disengage the charging lever, so that it will remain stationary during firing. This slight motion of the stop slide causes the locking discs to strike their camming angles, thereby rotating them until the rear face of the discs is arrested and the bolt and barrel are securely locked to the extension. While the firing mechanism is in battery and ready for firing, the bolt

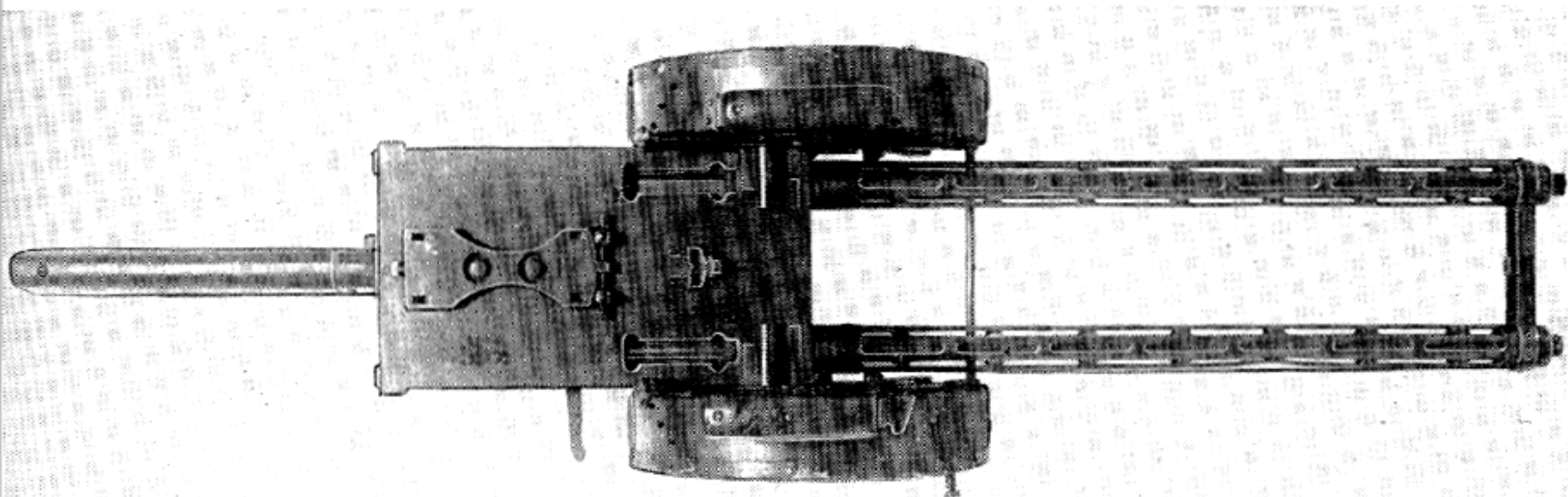

Gast Aircraft Machine Gun, 7.92 mm. Top View with Feed Drums in Place.

assembly of the opposite barrel is at the extreme distance rearward it can travel.

A single trigger operates both mechanisms through a trigger bar contacting each sear, which, upon being pulled to the rear, allows the spring-loaded firing pin to fly forward and fire the chambered round. The barrel, bolt, and breech slide (barrel extension) recoil together for a short distance, at which point unlocking begins. Complete unlocking of the breech lock from the breech slide is caused by the face of the locking discs striking the fixed cam. The timing is such that the tip of a lug will strike the breech-lock lever at the moment of unlocking. The impact of the lug on the lever at a place near the pivot gives a greatly accelerated motion to the piece which is in turn transmitted to the already recoiling bolt. The latter begins

to move rearward more rapidly than the breech slide, while at the same instant the other bolt, formerly in a retracted position, is correspondingly shot forward.

The sudden forward motion of the counter-recoiling bolt is of sufficient force to strip a round from the feeder and cock the firing-pin spring, while simultaneously the recoiling bolt with its extractor carrying the empty cartridge case makes contact with the ejector. The latter strikes the base of the empty case pivoting and knocking it free of the gun through the ejection slot in the bottom of the receiver. As the recoiling bolt continues rearward, the other bolt approaches battery until the round is chambered and the mechanism is securely locked. At this point, if the trigger continues to be depressed, the cycle of operation begins all over again.

## DARNE AIRCRAFT MACHINE GUN

About halfway through World War I the French brought out an aircraft weapon that had been manufactured with great secrecy. The weapon was the invention of Regis Darne and his son, Pierre. Their factory was in the town of St. Etienne, located in the coal mining area lying between the Loire and Rhône valleys. At the time this company had the Government contract for manufacturing all the Lewis guns made in France, its capacity then being 5 a day. The first Darne gun was introduced in 1916 and a few were issued in 1917. It attracted the attention of the French military high command to the point that in August 1918 the factory was ordered to produce all possible Darne-type machine guns for the planned spring offensive.

With the coming of the Armistice shortly afterwards, the Darnes were requested by their government to continue development of automatic weapons with the understanding that the technical services of both French artillery and air force would furnish data on new requirements. This company bent every effort towards standardizing and simplifying the various components in order to accelerate production in the event of an emergency. This, they thought, would not only facilitate instruction in ordnance classes whereby the weapon would be comparatively easy for gunners to master, but also make easy its manufacture, thereby creating the large reserve stock of spare parts so necessary for actual combat.

For over 15 years following World War I, this company manufactured high-grade shot-guns and hardware to remain solvent, but it likewise experimented on a large scale with its machine gun. At the end of this time, it not only standardized the weapon but also produced enough to issue to many French units in Africa and to several Balkan States for their air forces which subjected them to severe field tests. That they passed the rigorous conditions laid down

in the official specifications is best judged by the fact these countries reordered several times.

At Cayaux in August 1932 at an altitude of 25,000 feet with a temperature of  $-18^{\circ}$  C, a pair of Darne guns were mounted on a Scarff ring and the weapons fired by remote control. The test was to subject them to low temperature and exposure. Records show they functioned satisfactorily.

The weapon was gas operated, as were all French machine guns, with no provision made to regulate the amount of gas bled from the bore to the face of the piston. The company placed a port of predetermined size leading to the gas chamber and made it so that the individual gunner could not get it out of adjustment. That the largest possible orifice was used is attested by the fact that the aviation model Darne had an abnormally high rate of fire.

The weapon can be fed by both metallic strip or fabric belt, the system being so constructed that by rearrangement of parts it can be fed either right or left handed. The aviation model had both a pistol grip with a trigger device actuated by a rearward movement of the finger and a synchronizing device that mechanically released the sear and controlled the firing of the weapon through the propeller. When the gun is fired and pressure is exerted on the piston by the gases, this piece is driven forcibly to the rear. At the same time the gas piston starts to compress the driving spring. If the trigger bar continues to be held down, the piston cannot be caught by the sear at the end of its backward movement and the driving spring reacts in turn to throw the whole group forward, repeating the firing cycle.

These alternating movements of the gas piston shuttle the firing mechanism in the longitudinal slideways of the receiver. The breechblock covers the upper solid part of the gas piston of which it is an integral part. The rear spur of





Darne Aircraft Machine Gun, 7.5 mm. Dual Flexible Mount.

this piece is set in a recess corresponding to the aft end of the upper portion of the piston. When the latter moves forward under the impulse of the driving spring, the sliding movement of the recoiling mechanism in that direction is stopped at the end of its slideway. The piston with attached firing pin continues on its course.

The projection comes in contact with the corresponding cam on the breechblock which is opposite it. The breechblock is thus jacked up at the rear and held in this position placing the piston in alinement necessary for its forward movement. This rising of the breechblock brings it into its seat in the oblique recess made above its upper portion.

The rear face of the breech is then buttressed against the supporting part at the aft end of the recess securely locking the mechanism. This piece is specially heat treated as it has to stand the shock which will be produced by the exploding powder gases. The locking mechanism thus raises the bolt in the rear making way for the gas piston to continue its forward movement. The latter is provided in the front portion of its solid part with a firing pin which comes forward to strike through the opening in the bolt face against the primer of the cartridge. The round cannot be fired until the gas piston has raised all parts into battery and the arm consequently is safely locked.

As pressure builds up in the bore and the piston is thrust backwards by the impact of the gases, one of the two cams borne on its upper solid part comes in contact with the lock. The effect is to bring the rear of the breech into the axis of the upper slideways of the receiver.

As the unsupported breech no longer opposes the sliding movement, the piston pulls the breechblock rearward, at which point the extractor withdraws the empty cartridge case from the chamber. In this recoiling movement the breechblock strikes near the end of its course, the rear stud of the ejector forcing it to pivot. This oscillation brings the front stud into the path of the cartridge case, throwing the empty case through the ejection slot in the receiver. The piston and its components then reach the end of their course, at the same time compressing the main driving spring.

During this part of the cycle the cartridge carrier has previously seized between its claws a cartridge at the base of the case, and pulling it to the rear extracts it from the belt. At this moment the rear face of the claws is buttressed around the rim of the incoming round. During the first fractional inch of pulling the cartridge, the bullet pusher, actuated by its strong spring, presses against the front end of the bullet and follows it as it moves backwards. Thus the effect of inertia is neutralized with a view of avoiding

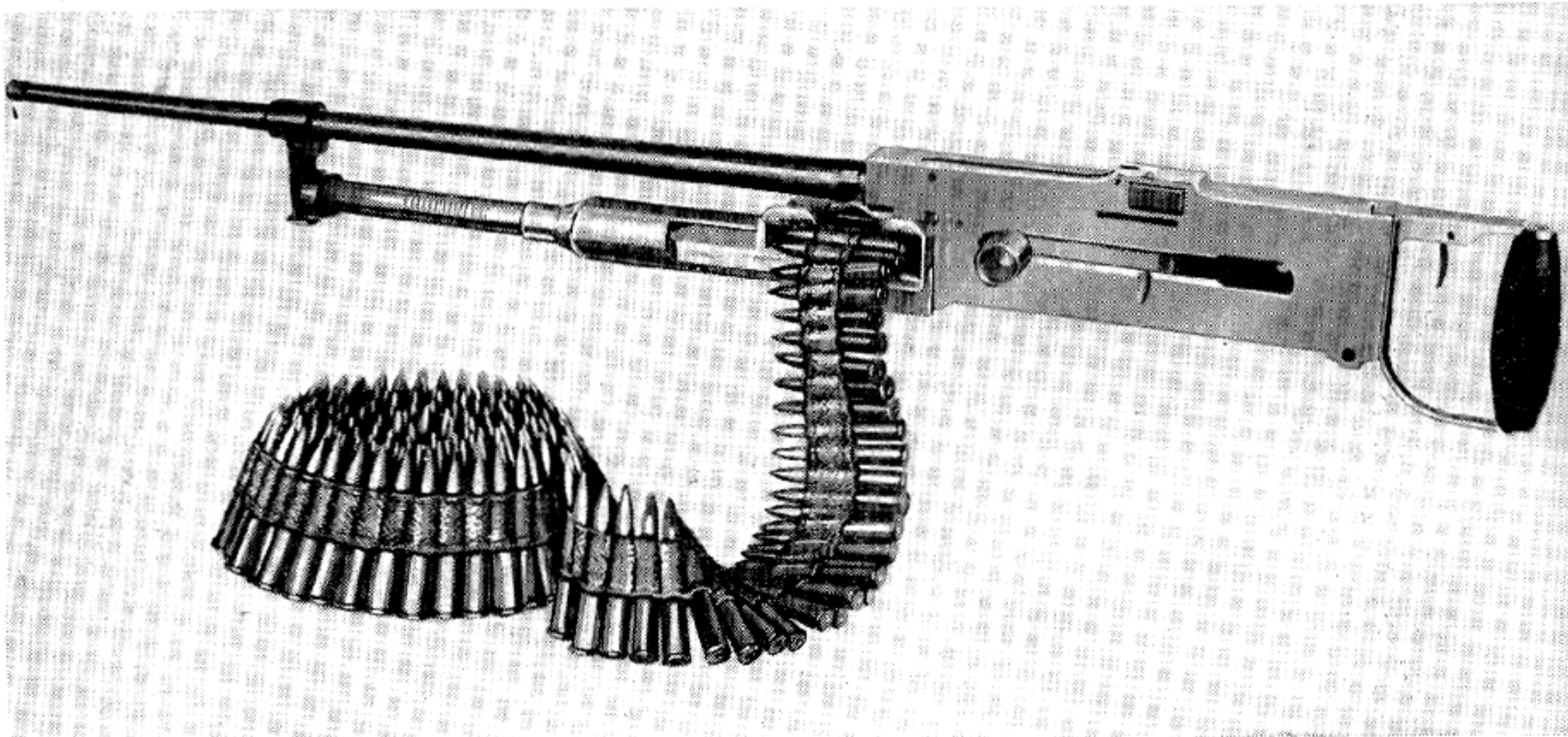

Darne Aircraft Machine Gun, Model 1918, Cal. .303.

the malfunction commonly known as a short round.

After having exerted its action, the bullet pusher is cammed forward again by the transverse movement of the next cartridge sliding into the feed slot. As soon as the point of the bullet has passed into the clear, the bar actuated by the cartridge carrier spring raises the incoming round at its middle part. The cartridge at this point assumes an angle of approximately  $45^\circ$  with the point of the bullet resting a little above the axis of the bore. During this final movement the front boss of the feed cam strikes the free end of the small rod carrying it towards the rear and the round is chambered. The action in battery is ready to repeat the cycle if the trigger remains depressed.

The Darne has often been erroneously referred to as another type of Hotchkiss machine gun because of its physical appearance and the fact that both are gas operated. Many things in the basic design of the Darne machine gun, however, are to be found only in this weapon. The feed system is indeed unique both as to position and method of operation. The two claws attached to the gas piston withdraw the incoming round from the feedway after it has been pushed from its link by an odd device that cams the cartridge positively back by pushing with great force on the nose of the bullet. They also prop the round up on a 45-degree angle, with two fingers attached to the gas piston, without relinquishing its hold. This unusual method of feeding has many good features, such as performing all its necessary functions on the powerful recoil stroke of the piston where there is surplus

energy. The design also makes possible a short bolt stroke. These two features contribute much to the weapon's high rate of fire, that has been vouched for by competent American observers to be as high as 1,700 rounds a minute when the 7.5-mm rifle cartridge was used.

The French mania for economy may have been the biggest factor in the lack of success of this gun, as the Darne Co. did everything possible to cheapen its construction, offering as an argument the short life of an airplane which made it foolish to build a gun that involved too much expensive machining. These guns were furnished to the French Government in 1931 for 700 francs, then equivalent to \$28. Such a price was more in keeping with the cost in America of a good single-shot rifle than it was for an aircraft machine gun. At this attractive price the company, in the period from 1918 to 1931, sold 11,000 machine guns in all. Serbia got 2,500, Italy 1,000, Spain 1,200, Brazil 150, and the remainder were delivered to France at a rate of 10 a day.

The aircraft version was also adopted by Lithuania following a competitive test held in December 1934. In May 1935 a British commission arrived at the Darne plant to witness a test of the guns for the purpose of buying license rights to manufacture them in Great Britain. The weapon passed the French test but failed at a later trial in England.

The Darne Co. took great pride in the fact that the weapon did not have a single piece of forged steel in its construction, making possible production of an inexpensive yet reliable gun.

A tourelle magazine was also designed for avi-

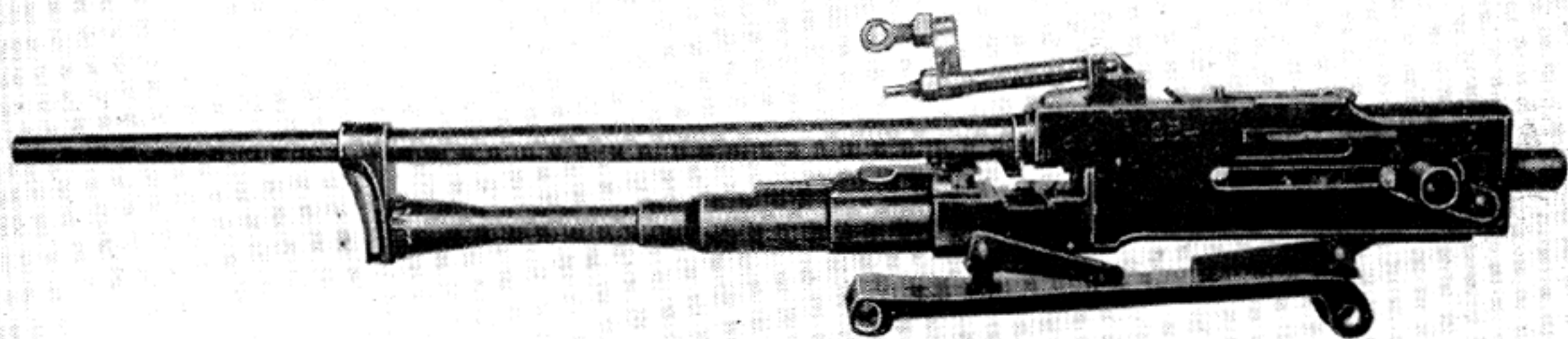

Darne Aircraft Machine Gun, 7.5 mm. This Is a Fixed Gun for Synchronizing.

ation use, having the unusual capacity of 500 rounds available for continuous fire. The double-barrel Gast machine gun, which was then held in such high esteem by both German and Allied ordnance officers, had a maximum cyclic rate of fire of 1,800 rounds a minute. By mounting two Darne guns side by side to resemble the much heavier Gast, the arrangement gave a minimum of 2,400 shots per minute. The company was proud of this system of mounting and catalogs appeared in many languages showing its alleged superiority.

Several hundred guns were sold to Spain which were used in the Moroccan campaign. On these weapons was installed the load indicator, a device that showed the gunner not only if the gun was loaded but the amount of ammunition left in the feed box.

Following what it considered the success of the aircraft model, the Darne Co. then developed a light machine gun, a heavy one for infantry use, and an antitank automatic gun chambered for the 11-mm military cartridge.

All Darne machine guns were rough in appearance, being produced in this manner intentionally since refinement in appearance would only add to the cost. Cheapness and ease of manufacture were the main points considered in their design.

The barrel was made with exterior projections and the gas port had a conical exit into which the gas tube fits. The piston had only three bearing surfaces, one at the front where the force of the gas was taken in and two at the rear where it fitted loosely in the guides of the receiver. The

feed mechanism was one of the most positive known, being actuated by the recoil stroke of the gas piston. The two fingers holding the cartridge in position for chambering were indeed unique.

Initial extraction was employed to loosen the empty cartridge case before the extractor snatched it from the chamber. Ejection also was satisfactory. The heavy bolt was securely locked during firing by a shoulder on the gas piston, camming the rear of the bolt up into the locking recess milled into the receiver body. Had many of the ingenious methods employed in this cheaply constructed weapon been given refinement and placed in a well-designed receiver, it no doubt would have been among the best of the gas-operated type.

The Darne Co., in 1935, also tried designing a 25-mm aircraft motor cannon with rounds being fed to it from a belt with metal clips. This weapon was placed in secret status by the French Government and, when France was overrun by the Germans in World War II, it, with all data on its performance, fell into enemy hands. This weapon was reputed to have fired at a rate of 750 shots a minute. Experiments were also made with a triple 7-mm rifle caliber machine gun, but it, like the 25-mm automatic cannon, never got beyond the prototype stage.

Darne machine guns have been mentioned both favorably and otherwise, but on two things everyone is agreed. The most outstanding features about the factory were the outmoded machinery the company used and the poorly illuminated, cramped quarters in which 400 men had to work.

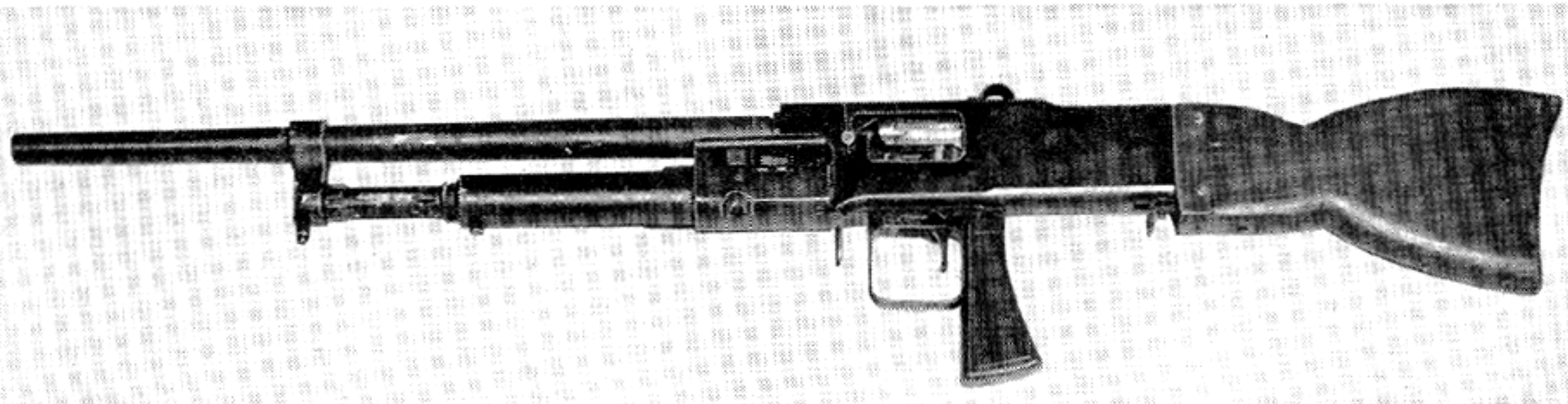

Darne Machine Gun, Model 1929, 7.5 mm.

# BEARDMORE-FARQUHAR AIRCRAFT MACHINE GUN

The Beardmore-Farquhar machine gun was one of the lightest machine guns ever constructed, weighing only 16¼ pounds with a 77-shot drum magazine attached and loaded with the .303 British service cartridge. This weapon was the invention of Col. Moubray Gore Farquhar, of Birmingham, England, and was manufactured by Messrs. William Beardmore & Co., also located in Birmingham.

Many special features were claimed by the promoters, such as its cheapness to manufacture, the practically jam-proof mechanism, perfect breech locking and a safety feature making it impossible to fire the weapon without the breech being securely locked. It was recommended that no oil be used on the highly polished close-fitting mechanism, thus making it an ideal weapon for an observer in a plane where great altitude gummed up the working parts of similar firing mechanisms that demanded lubrication. The makers of the gun also claimed the heat of the barrel did not affect the other parts, as they would continue to function properly even if the barrel was red hot during the entire time of operation.

The weapon was similar in appearance to other drum-fed observer guns that had been used so successfully by the British Royal Air Force during World War I. The manufacturers, however, considered it to be a real improvement over similarly constructed ones because of its unusual method of operation.

The most unique feature of the gun is the extensive use of springs for its operating energy. It is placed in the unusual classification of being actuated by both gas piston and spring. The power of the exploding powder charge does not act directly on the bolt's unlocking mechanism but compresses and stores up spring energy until the bore pressure drops to a safe operating limit. The bolt is then unlocked by the smooth action of the strong spring, which gives positive unlock-

ing without the jarring effect of a straight gas-piston-driven mechanism. The piston is contained in a cylinder which is fastened to the barrel and connected to the bore by a drilled orifice. The main driving spring is housed in the front end of a part known as the spring tube, with a kind of sear device also located in this part. The front of the housing is held in position by a tube cap and fore end piece.

The design of this peculiar weapon also has what is called the bolt-closing spring. It is placed around a central rod, and when installed, is located at the rear of the spring tube underneath the barrel.

When the cartridge is fired and the bullet passes the orifice in the barrel, gas is bled into the gas-cylinder chamber forcing the piston rearward and compressing the main spring until it is held in this position by the catch or sear. The spring is thus compressed between the catch and head of the tube. It remains compressed until the resistance to turning the bolt head, caused by the pressure of the gas in the chamber working on the locking lugs against the body, is so reduced that it can be overcome by the strength of the compressed spring.

The main spring held securely by the sear, with its firm abutment against the holding washer, extends rearwards carrying with it the bolt carrier to which the bolt is attached. The force of the main spring, upon opening the bolt, extracts and ejects the empty cartridge case and compresses the bolt-closing spring. The main spring, now being fully extended and no longer pressing against the sear and catch, disengages, allowing the now-compressed bolt-closing spring to start counterrecoil movement of the parts. They in turn strip a fresh round from the feeder and return the main-spring-sear washer and piston to battery position and in the final movement forward lock the bolt securely to the barrel.

The breech action is of the straight-pull type



Beardmore-Farquhar Aircraft Machine Gun, Cal. .303.

whereby the bolt carrier slides in slots outside the body. The carrier is provided with an internal cam slot which engages the bolt arm. The bolt is composed of a non-rotating cocking piece and a rotating bolt head. The locking lugs are at the front of the bolt head and engage with corresponding resisting shoulders located in the receiver directly behind the chamber. When the lugs have entered the body, the arms engage its face. The bolt arm, continuing its forward movement, is turned by the cam slot until the lugs engage the resisting shoulders and the bolt is securely locked in battery. The extractor, in its final movement forward, cams itself over the rim of the chambered round.

The ejector consists of a pin supported by a spring and housed in the bolt, with the point of the ejector pin protruding through the face of the bolt. When home over the face of the cartridge, the ejector pin is depressed flush with the bolt face. But if the empty case has been extracted far enough that the front end is not supported by the chamber, the ejector pin jumps smartly forward throwing and pivoting the

empty case through the ejection slot in the left side.

The bolt always remains locked in the Beardmore-Farquhar until the force required to unlock it is less than the strength of the compressed main spring. This makes it impossible for any extra amount of gas pressure to hasten unlocking, or for that matter, affect the operation in any way.

The feed mechanism is also very interesting in that it is a rotary affair holding two layers in the drum. The cartridges are put under spring tension and likewise indexed and stopped by a spring-loaded catch. The entire drum can be unloaded manually in an instant by depressing the two feed stops simultaneously.

It was claimed that the operating mechanism was not as likely to heat up from barrel heat as other guns of similar design. Since the connecting parts of the metal were of reduced section or skeletonized to a great degree, the heat was thus confined only to the barrel.

To simplify further the construction of the weapon, there were no radial fins or like ar-

rangements on the barrel for cooling purposes. On an official test the weapon fired 640 shots in rapid succession without jamming from overheating. The manufacturer contended a weapon of such design would never be called on in air combat to equal or exceed this. Therefore, he could not see the logic of adding to the weight by placing more metal into the barrel.

The inventor demonstrated on every possible occasion the good features of his weapon and personally fired it. The colonel must have been a good marksman as well as an ingenious inventor, as he once placed 75 hits on a target with a one-drum burst, at the required military range distance.

On 14 November 1919 the Royal Air Force gave the Beardmore-Farquhar machine gun an official aerial test. The weapon was presented by Colonel Farquhar and immediately fitted in a Bristol fighter machine on a Scarff-ring mounting. Firing trials were then carried out at high altitudes. The pilot was Flight Lieutenant Rea and the gunner, Flight Lieutenant Pynches. Twenty rounds were fired automatically at 4,000 feet and the gun functioned perfectly. At 18,300 feet, 320 rounds were fired at various angles of elevation, depression and training.

Up to a maximum firing position it was reported the gun was very easy to handle at any desired position and no difficulty was experienced in shipping and unshipping the rotary magazine. The rate of fire at the maximum altitude attained, 18,300 feet, was figured at 430 rounds per minute, which was considered the limit for ground firing. The angles of elevation,

depression, and training in a firing position were the same as obtained by other guns that had been previously tested on the same mounting.

The cartridge cases were ejected about 6 feet out of the gun and carried by the slipstream past the fuselage of the aircraft. Only in one instance did the ejecting of an empty cartridge case fail. This occurred in the last round of the first magazine when firing at the maximum elevation in altitude. The cartridge case was eventually extracted by alternately withdrawing and releasing the bolt about 20 times. The case was unfortunately ejected overboard but it was thought by the gunner that the jam was due to faulty ammunition, probably to an over-sized rim.

No other stoppages or jams occurred during the remainder of the test. During the flight, loaded magazines had been placed flat on the floor of the aircraft and the vibration released the spring-loaded cut-off in the feed which opened it and emptied the ammunition on the floor. Ordinarily during flight these magazines or drums would have been stowed on a stud. It was agreed that excessive vibration fouled the cut-off projection during the stowing of the magazine, thus causing the loss of the ammunition.

The authorities in charge of the test recommended that a stop on the magazine be placed immediately behind the cut-off to eliminate the above possibility, as it was sometimes customary for pilots to carry the drums on the floors of their planes. It was also suggested that the flat steel rod connected to the reciprocating breech mechanism should have a guard over it, since it was possible for the gunner's fingers to be in the

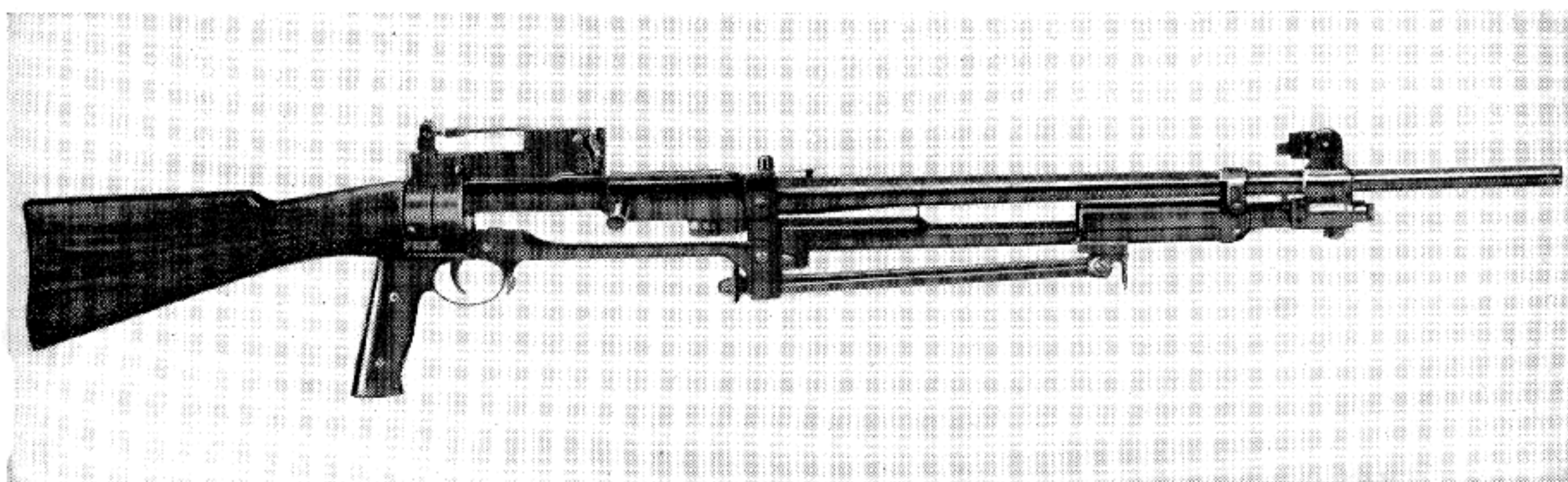

Beardmore-Farquhar Aircraft Machine Gun, Cal. .303.

way of the recoiling breech. The guard would also prevent oil thrown out by the engine from getting into the working parts of the weapon. Another recommendation was that an additional handling advantage could be obtained by adopting a round section handle projecting to port about two inches and bent downwards to form a hand grip instead of the present method of handling.

The testing board's conclusions were that the gun compared very favorably with other weapons of similar design, with the additional advantage of having less kick. The rate of fire was not quite as high as similar designed guns. The weapon was lighter and less liable to jams. A much more extensive trial would however be necessary before a definite conclusion could be

arrived at on the foregoing points as well as the behavior of the gun after ordinary long service usage. It was further noted that the 77-round drum could be detached and a 5-round magazine, using the infantry cartridges in their present clips, could be placed on in a matter of seconds, converting it quickly from an aircraft gun to a lightweight automatic rifle for infantry use. The rapid-change barrel system employed by this weapon was also commended.

After tests conducted at a later date the British Government decided that the weapon was not so much superior to others of similar nature already in existence as to justify its over-all adoption as the Royal Air Force observer gun, and with this decision all work and development stopped.



## BRIXIA MACHINE GUN

The Brixia machine gun Model 1920 was devised by engineers of the Brescia Metallurgical Works, formerly the Tempini-Brescia Company, producers of 40,000 Fiat machine guns under Italian Government contract. From their background and a comparative study of all known machine gun mechanisms, they developed what was considered an improvement that "fulfilled in all respects the requirements suggested by experience of five years of war." In the weapon's design special attention was paid to: (1) Lightness, yet reliability of construction; (2) simplicity and solidity of component parts; (3) maximum ease in stripping and assembling; and (4) safety and ease of operation.

One of the Brixia's most unusual features was the complete housing of the recoiling parts to

prevent introduction of sand, dust or other foreign matter that would hinder operation. In the event of premature explosion of a cartridge the operator was fully shielded by the encased receiver. The method of feeding was also claimed by the producers to be much simpler than that of other machine guns. The gun was fed automatically by metallic loaders formed into rectangular boxes and attached to the receiver.

There was also incorporated in the weapon a means of regulating rate of fire while the gun was in action. Cooling was accomplished both by air and water. When water cooled, the conventional jacket was used, but in the aircraft model the barrel was cooled with radiation of the flanges that were an integral part of the barrel. For the water-cooled version the barrel was



Brixia Machine Gun, 6.5 mm.



It passes when in battery, rests upon the rear of the projection. Directly above it is a hole to house the safety spring. The latter holds the locking lever up in line with the slot cut for its path when the breech lock is removed from its path by being in the locked position.

In addition, a slot is cut high up on the left side of the receiver for the ejection of empty cartridges and an opening on its lower right side provides for the introduction of ammunition by means of a magazine. The ejector is a portion of the receiver made to butt into the base of the empty cartridge. It recoils rearward while being held by the extractor, which is peculiarly located on top of the bolt.

The trigger arrangement consists of a button, the movement of which is limited by the rate-of-fire regulator, a goose-neck-shaped bolt inserted and held transversely in the receiver. While in various positions and in conjunction with the trigger mechanism, it lengthens or shortens the travel of the recoiling parts. This unusual firing device is provided with a thumb piece that pro-

trudes from the left side of the receiver and, by means of finger pressure, controls the speed of operation. The regulator itself is an eccentric bolt. The cylindrical part is moved along an axial plane while the periphery of the other half has two grooves which are at variable distances from the axis of rotation, and in which rest the tops of the middle fingers that serve to accelerate the recoiling action rearward. Pushing down the regulator on the left side of the gun with trigger button depressed at various levels controls the distance of movement fore and aft.

To operate the Brixia, a loaded magazine is inserted in the corresponding slot until the loosening of the restraining catch shows it to be completely seated. With his right hand, the gunner draws the charging handle attached to the loading bar back smartly for the maximum distance and releases it. The recoiling parts are then sent forward with great speed by the compressed driving spring. On the way to battery they strip from the magazine attached on the right lower side a live round and by the employment of two



Brixia Machine Gun, 6.5 mm.

lower flanges guide the cartridge into the chamber. When this is accomplished, the loading bar carried by the recoiling parts returns to its original position, locking itself on its catch. The breech lock, being pushed forward from the breech, is inserted between the loading bar and recoil mechanism to insure complete locking before the act of firing.

The firing pin, held back by the front part of the cocking lever, is now in the cocked position. By pushing forward on the trigger button, the round is fired. The pressure of the exploded powder charge causes the recoil of barrel, bolt, and bolt extension all locked securely together for a distance of about 5 millimeters. At this point the weapon begins to unlock as the breech lock turns over backward and by doing so acts as an accelerator.

After the short recoil the barrel extension is stopped by a buffer. The bolt, now unlocked from the barrel, continues to the rear, carrying the empty cartridge case gripped at the top of its

rim by the extractor. At a distance slightly greater than the over-all length of the incoming cartridge, the base of the brass case hits the ejector projection that is an integral part of the receiver and kicks the expended case out the upper left side of the receiver. The recoil movement is stopped by a buffer housed in the back plate and under the influence of the driving spring and the buffer starts the operating parts into counter-recoil. The magazine-fed cartridge slips into position in the carrier and is lifted up in line for the incoming bolt to strike and thrust it into the chamber.

The bolt is now locked to the barrel and extension and the firing pin remains in a cocked position provided the firing button is not depressed. In order to execute continuous fire, the firing lever must remain pressed down as far as possible. The lever is then placed at the bottom of the inclined face and will allow the weapon to fire automatically. When so held, a maximum rate of 600 shots per minute is attained.

## MENDOZA LIGHT MACHINE GUN

Señor Rafael Mendoza, a foreman at the National Arms Co., Mexico City, D. F., in 1920 started the design and development of a light machine gun. Twelve years later he felt his working model was at a point of perfection that would justify testing by the Mexican war department for official adoption.

The gas-operated weapon had a non-recoiling air-cooled barrel and a 30-shot spring-loaded double-column magazine. Its maximum rate of fire was 500 shots a minute and its weight was 18½ pounds. It could be fired both semi- and full automatic, the bolt remaining open after the trigger was released. The magazine was located on the top right side of the receiver which did not necessitate the offsetting of the sight system.

The standard Mendoza gun came with bipod but it could be instantly adapted to antiaircraft mounting. The barrel, which had cooling fins, was chambered for the Mexican infantry Mauser 7-mm rifle cartridge and could be changed in a

matter of seconds when necessary. A flash hider was always incorporated in the design. Barrel removal in the field was accomplished in the following manner: First the gun was cocked, after which the barrel latch on the forward end of the receiver was pressed in; the large lug holding the barrel to the receiver was freed; and the barrel could then be pulled forward.

The weapon was constructed with only 22 working parts. This fact alone showed great skill in design and planning, as such simplicity eliminated many malfunctions.

In October 1932, at the Rancho del Charro, D. F., the Mendoza, along with several other light machine guns, was officially tested under strict security by a board of officers representing the Mexican Government. They were greatly impressed by the performance of this Mexican-designed and produced light machine gun. After consulting with Mendoza, the government in June 1933 invited M. H. Thompson, a well-known New York engineer who had previously

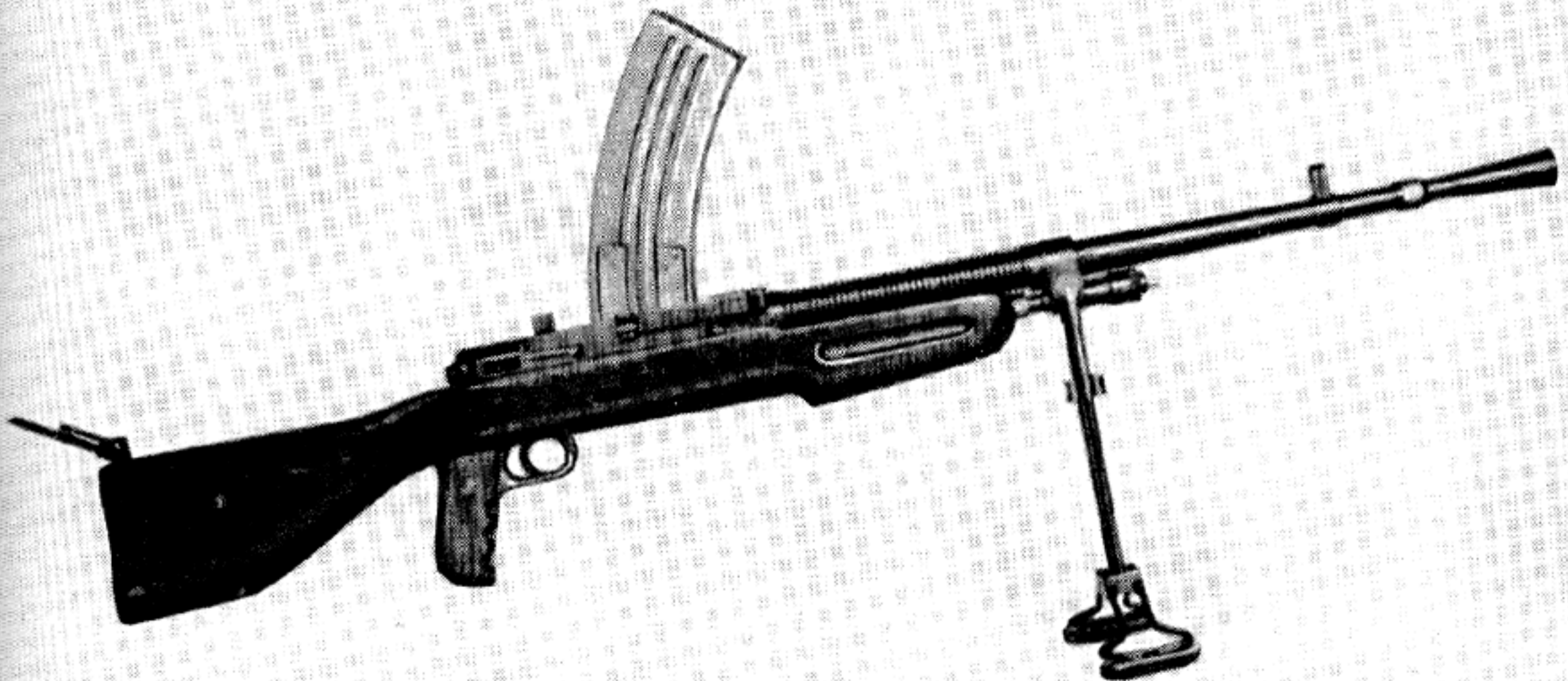

Mendoza Machine Gun, 7 mm, Right Side.

done ordnance work for Mexico, to visit the National Arms plant for refinement of the weapon. This was done and in August 1933 the president of the republic ordered the limited manufacture of the improved gun for further test and experimental purposes.

This work was carried out in great secrecy, even to its adoption as the Mexican Army's standard light machine gun in December 1933. On 6 June 1934, after all tests and experiments were successfully concluded, the National Arms Factory was ordered to proceed with full production on these efficient lightweight weapons. The government took over Mendoza's invention, paying him well both in money and honors and applied for a patent in the United States in his name. The first twenty guns were issued to the 48th Infantry Battalion, then stationed at Chapultepec.

The Mexican Commission of Military Studies requested that as soon as delivery was made of the Mendoza machine guns they be distributed to the tactical units, as follows: 18 guns to each cavalry regiment and 24 to each infantry battalion. They were to replace the automatic weapons with which the troops were armed at the time, namely—Hotchkiss, Colt, and Vickers, all of which were eventually withdrawn and put in reserve as the new Mendozas were received.

After the army had already been armed se-

cretely with this weapon, the Mexican war department published the following bulletin:

**"Order No. 42, 6 December 1934.**

"By order of the Substitute Constitutional President of the Republic dated 31 October 1934 the Mendoza machine gun rifle ('fusil ametrallador') and the Mendoza light machine gun are hereby declared regulation in the Mexican National Army and Navy. The War Department has already taken the necessary steps that the corresponding armed units may be equipped with this material with as little delay as possible."

The weapon has many advanced features, although the main principles of operation are as old as automatic firing mechanisms. Basically and from an operational standpoint it is a Lewis action but this system is noticeably improved by incorporating a double cam slot. The device did much to equalize the torque and consequently reduce the locking friction, so common when the bolt face is held securely behind the cartridge base.

Although the gas cylinder greatly resembles the Hotchkiss, the conventional method by which it encloses the piston is not employed. Instead, a cuplike arrangement in the gas assembly houses a short and separate piston which after a brief stroke rearwards allows the powder gases to dissipate into the air. This is exactly the

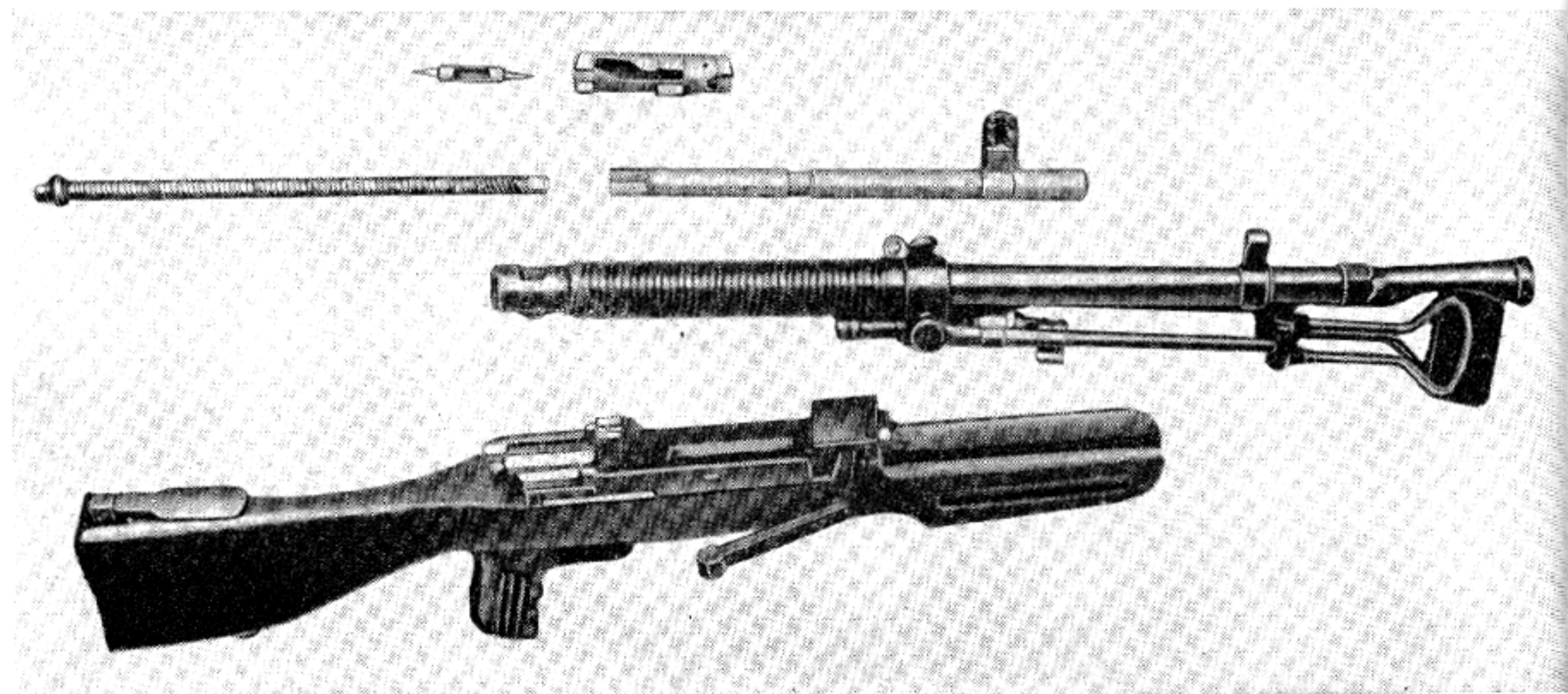

Components of the Mendoza Machine Gun.

reverse of the ordinary gas-operated firing mechanisms.

The selector switch is located on the left side of the receiver above and slightly in front of the trigger guard. A most unusual cocking method is employed. On the left side near the end of the firearm projects a small piece to be pulled by the left hand directly to the rear until the sear engages and holds the gas piston and bolt in a retracted position.

The firing pin is unique in construction. Driven forward into the primer of the cartridge by its attachment to the bolt extension, it is made with two identical protrusions so that when a tip is broken off it may be remedied simply by reversing the ends.

Another interesting feature is the ejector, a long finger pinioned in the right side of the receiver and an integral part of an assembly which includes a bolt-hold-back device. The rear end of the bolt is used as a cam on the right side so that as it moves to the rear it noses the ejector and hold-back device out of the way. But as the aft end of these members is struck, the cammed surface forces the ejector's nose back into a slot in the forward part of the bolt, while the nose of the hold-back moves into a notch on the bolt's right side.

No provision is made for head spacing as neither barrel nor receiver has the necessary threads. The barrel is simply inserted into the receiver, its rear end being slotted to take the locking key. The latter also passes through the receiver and is held by the same retaining pin. On the last shot a three-cornered stop attached to the magazine follower protrudes past the lips of the magazine into the receiver, blocking the movement of the hold-back pawl. Thus the empty magazine holds the bolt to the rear with the expenditure of the last cartridge. When a fresh magazine is inserted, it releases the rear sear, at the same time letting the bolt come forward just enough for it to engage the notch in the actuator. This makes instant action possible with the weapon after a loaded magazine has been placed in position.

To fire the Mendoza Model C-1934, the operator, generally prone, inserts a loaded magazine into its locking recess on top of the receiver. If automatic fire is desired, the selector switch is moved forward from its safety position. The charging handle is pulled with the left hand all the way to the rear until the hold-back sear engages its notch in the bottom of the bolt extension, the short gas piston remaining in its housing under the gas port.

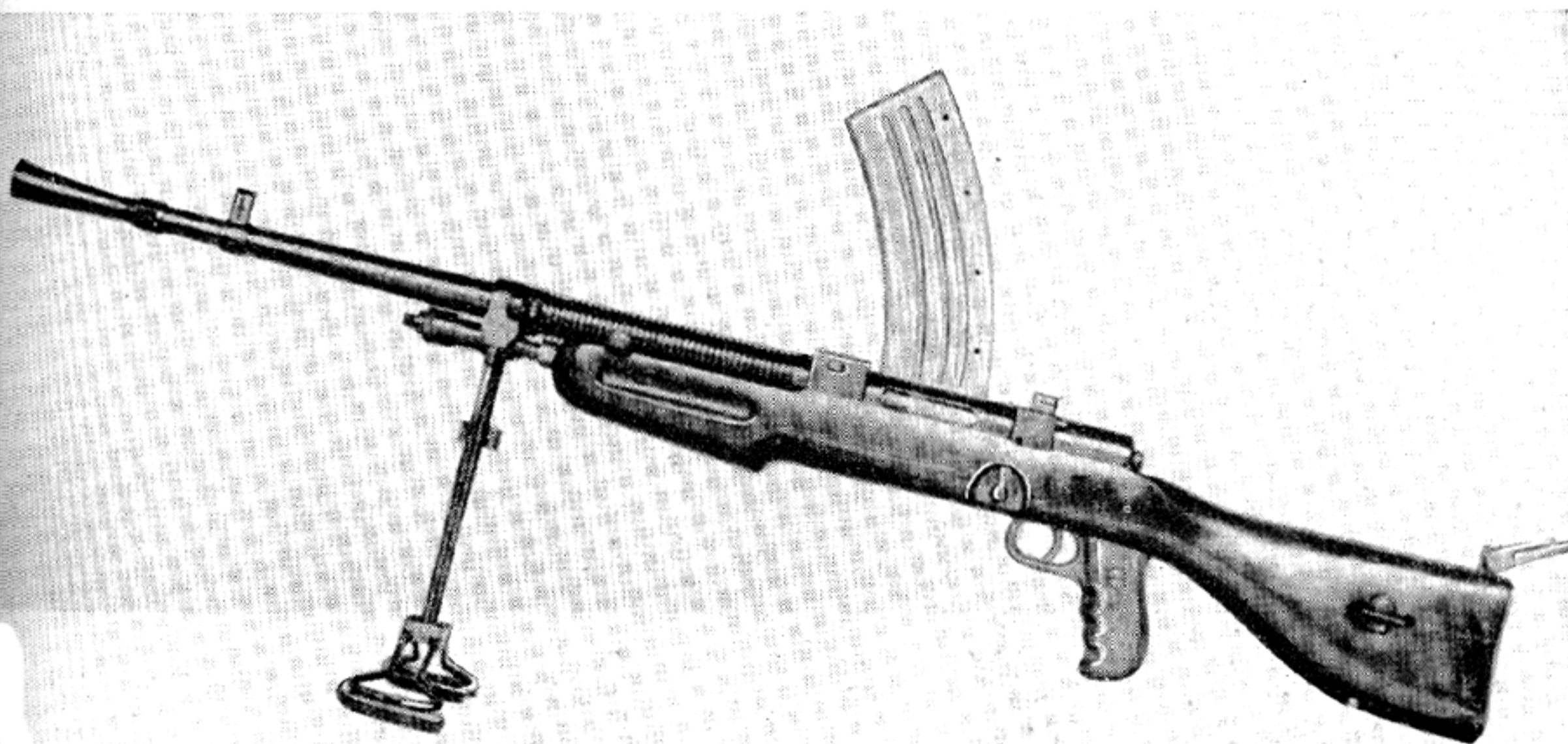

Mendoza Machine Gun, 7 mm, Left Side.

Being cocked and with a cartridge in place for stripping, the weapon is now ready to fire. A pull of the trigger to the rear disengages the sear and the operating parts are driven forward by the tension of the compressed driving spring. As the bolt face passes the rear of the double column-type magazine, it pushes the first cartridge from the lower right edge of the magazine as the extractor cams itself over the cannelure of the cartridge. When the cylindrical bolt has chambered the round and stopped, the eight locking lugs of the bolt are in line with the fixed lugs. The bolt extension, still three-fourths inch from battery, continues forward, rotating the bolt and locking it to the receiver.

The rotation removes the obstruction from the path of the firing pin. This piece, attached by a lug on the bolt extension projecting vertically through the firing pin and bolt, can now be driven forward to fire the round. As gas pushing the bullet through the bore reaches a port 11 inches from the breech end of the barrel, a portion is released into the short gas piston. The bolt extension moves rearward about three-fourths inch before its lug strikes the cam in

the bolt slot. The firing pin, which is a cylinder with a point on each end, starts backwards with the actuator.

The continued movement of the extension rotates the bolt, unlocking it and carrying it to the rear. The extractor in the left side of the bolt body withdraws the empty cartridge case from the chamber. As the bolt and bolt extension keep on, the ejector contained in the right side of the receiver strikes the cartridge case at its base, knocking it through the left side of the slot in the receiver. The full energy of the moving parts is absorbed by compression of a driving spring. At the completion of the recoil stroke the whole assembly is started into counterrecoil movement to feed, lock, and fire each round.

Mexican military authorities were justly proud of the Mendoza, as it was very efficient and served the purpose for which it was designed. The Mexicans have always been admirers of fine weapons and their history includes inventions that have contributed much to the art and development of automatic arms. On this list Rafael Mendoza's contribution ranks high.



## CHATELLERAULT MACHINE GUN

The French, ending World War I with the realization that they had been armed throughout the conflict with the worst automatic weapon ever designed, the Chauchat, were the first of the Allies to adopt a post-war machine gun. This new arrival was the Chatellerault, named after one of the French Government arsenals, Manufacture d'Armes de Chatellerault. It was in design very similar to both the Berthier and the American (Browning) B. A. R., having many features of each.

It first made its appearance in prototype stage in 1921 but was not officially adopted by the French Army until 1926; and then only after many modifications had been made on the original, giving it even more Browning characteristics. About the only basic difference was the employment of a box magazine holding 30 rounds inserted from the top that made unnecessary the forked piston used on the B. A. R.

The Chatellerault had two triggers housed by a

guard, the forward one for single shot, the rear for automatic fire. A gas device, that could be regulated, worked in conjunction with an adjustable back-plate buffer to permit variable rates of fire at the control of the gunner. The top magazine arrangement made necessary an awkward off-setting of the sight.

The French had found from earlier attempts at machine gun design that their 8-mm Lebel rifle cartridge with its stubby and steep conical rimmed case was most certainly not the best-shaped cartridge for automatic use. Therefore included in the plans for this gun were drawings for a completely new round of ammunition. The result was a 7.5-mm rimless cartridge case with practically no taper on it, very similar in appearance to the Swiss Army cartridge from which it was closely copied even to the boat-tail 149-grain cupro-nickel bullet.

The Chatellerault weighed slightly under 20 pounds and was not only heavier but much more



Chatellerault Machine Gun, Model 1923, 7.5 mm. This is a Prototype Gun, Serial Number 11.

expensive to make than the Chauchat, since the latter gun was more of a plumbing assembly than a precision-made automatic weapon.

The French, as usual, had very little money for development and production of machine guns. As it has always been a policy of theirs to encourage adoption of their own weapons by friendly powers and prospective Allies, their military attachés who were located in such countries were instructed to spread favorable reports on the performance of the Chatellerault machine gun, even before it was officially tested, and to indicate it would be available for purposes of adoption if the authorities could be interested.

In 1925 the Yugoslav Government was carrying on a competitive trial in which several European-made machine guns were tested. The Hotchkiss Co.'s entry made the most satisfactory showing and was on the verge of being contracted for when the French attaché offered the Chatellerault gun at the ridiculously low price of 2,000 francs, although it had not been entered in the competition. He intimated that it had successfully met all the demands of the French proving grounds.

A Yugoslav commission was then sent to France to investigate the claims of the Chatellerault. It was found the price quoted could not be met but, although higher than first stated, it was still considerably less than the market price of similar machine guns. The catch this time was that only a few pilot models were in existence as their manufacture on a large scale had

not yet begun. The Yugoslavs, desiring an early date of delivery, called for another competitive test. This time they did not find either the Chatellerault or the Hotchkiss acceptable, the contract going for a machine gun made by another country.

A similar situation arose with the Rumanians who also sent their commission to France. However, they demanded and arranged a test before consideration of purchase. During one of the demonstrations, with one of the group firing the weapon while other members stood by, an explosion occurred in the receiver of the gun. The operator was seriously injured, as well as several others of the commission.

The Rumanians were told that through sabotage a cartridge with only enough powder barely to drive the bullet into the bore, caused two bullets to be present in the barrel for the next round, causing the regrettable incident. No explanation as to how the sub-loaded cartridge had gotten into the feed was forthcoming. The Rumanians, not quite satisfied with the explanation, in the presence of the French military attaché, produced the same condition with a Hotchkiss machine gun. The result was a swollen barrel but no violent explosion occurred.

After the weapon's adoption by the French Army, a number of explosions of identical nature took place, and quite a few soldiers were injured. As the blame could not be placed on defective ammunition, but rather on the weapon itself, it is easy to understand that the French

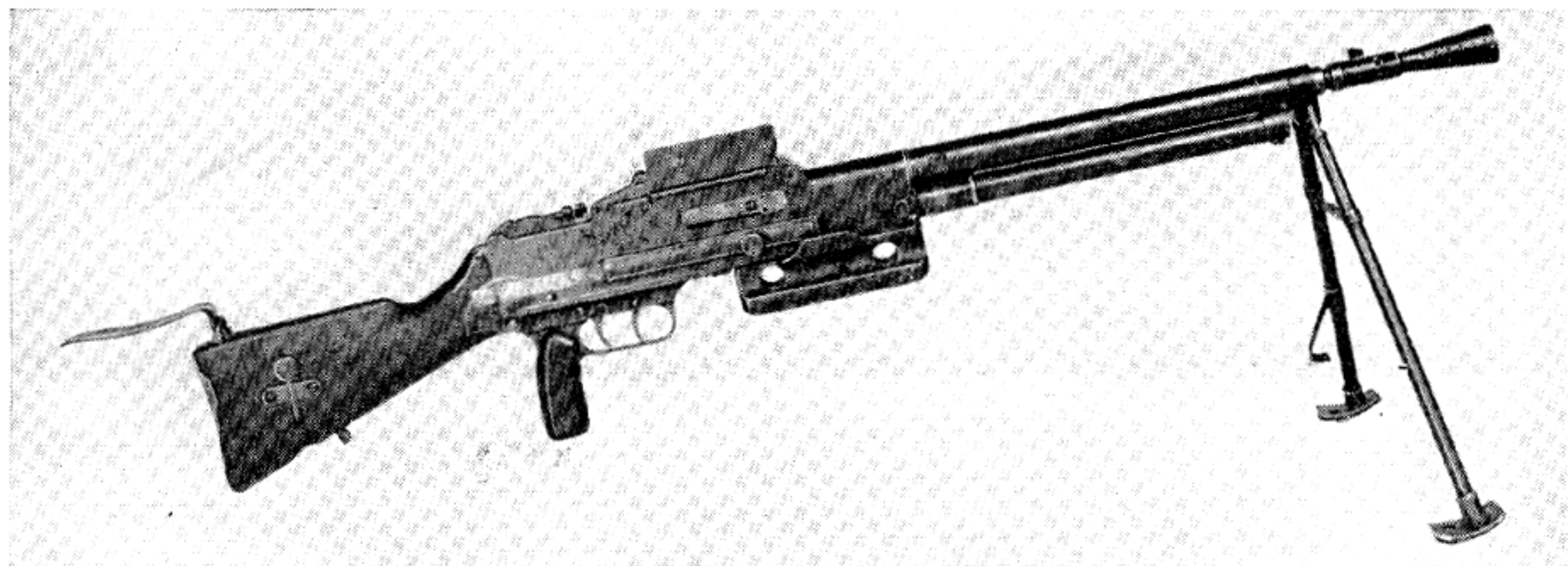

Chatellerault Machine Gun, Model 1924 29, 7.5 mm.

soldiers were considerably exercised over its dangerous characteristic. The troops in the field asked that they be issued the heavier and outmoded Hotchkiss in place of the Chatellerault.

The country's high command was brought to the realization that development work, if any, must be paid for by France and not by some smaller country, and that modification should be made without delay as the weapon had made such an unfavorable impression even among French troops. Necessary redesign was finally done, but, as is usually the case, once a weapon gets the reputation for unreliability, its bad name outlives by years the correction that remedies the malfunction.

It was also a severe blow to the sensitive pride of French military engineers that they did not seem able to copy either the B. A. R. or Berthier, both having proved reliable weapons, especially since, just before the weapon was tested, newspapers heralded the new gun built in great secrecy and now ready to be shown to the public for the first time. A sample follows of such advance publicity, as written by a reporter for the *Paris Echo* on 6 February 1924:

"A machine gun, the Chatellerault, said to be the invention of a French artillery officer . . . is equal or superior to its competitors with respect to its manner of operation, and is far ahead of them in regard to facility with which it can be handled and its principles taught to recruits—factors which are more and more important to recognize owing to the short time of military service and the considerable amount to war material, the handling of which all has to be taught to recruits . . . French arsenals are now working overtime to supply a large part of the French infantry with the new Chatellerault automatic rifle. A soldier can fire 30 shots from one burst from the shoulder with the new rifle and the French authorities consider it the most effective weapon of any army of the world. Eventually every French soldier will carry the new rifle."

It later came to light that nothing was basically wrong with the design of the weapon. The main fault lay in the pressure brought to bear by the two government arsenals, Chatellerault and St. Etienne, on high officials to have all developments done at these two army-controlled factories. It was pointed out by personnel of these

government plants that they had successfully produced weapons for the army since their date of establishment. But money always being a big factor, these places were constantly restricted by their lack of appropriations, making it questionable whether superior metals and proper heat treatment were always used.

The phases of operation with this machine gun are divided into rearward and forward movement. The stages that take place on the rearward movement are compression of the driving spring, action of the gas, movement of the bolt and the slide to the rear, unlocking, withdrawal of the firing pin, extraction of the empty cartridge case, ejection of the empty case, and cocking. The operations that occur on the forward movement are decompression of the recoil spring, feeding, locking, and firing.

To fire the 1924 model Chatellerault, the operator first attaches a loaded magazine in position and pulls smartly rearward on the charging handle until the gas piston and bolt are held in a cocked position by engagement with the rear sear. If automatic fire is desired, the selector is placed on *F* (*Fire*) and the rear trigger pulled, releasing the sear which allows the compressed driving spring to thrust the bolt and gas piston forward. The feed rib on top of the bolt enters between the lips of the magazine and shoves the bottom round forward. The nose of the bullet strikes the bullet guide in the top front portion of the receiver, guiding the incoming round down towards the chamber. As the slide and bolt continue forward, the base of the cartridge is forced by the magazine spring down onto the face of the bolt behind the extractor, thus aligning the round with the chamber.

The nose of the bullet has now entered the chamber which acts as a guide from there on until the cartridge is fully seated. When the slide is three-eighths inch from being fully forward, the bolt strikes the bridge of the receiver stopping its advancing movement. The slide, however, continues on and the lower bolt link pin moves forward with the slide, causing the bolt links to rotate around the upper bolt link pin. The bolt is pushed up and locks the shoulder in the rear to the top of the receiver. Before the bolt links complete their rotation, the firing pin, which is moving forward with the slide, advances



Components of the Chatellerault Machine Gun.

through the bolt face striking the primer of the cartridge.

The powder charge having been ignited, the bullet starts forward under pressure of the expanding gases. When the bullet reaches a point four inches from the muzzle, the gases pass through a port in the bottom of the barrel into a cylinder housing the gas piston. The action of the gas is that of a severe blow on the head of the piston, moving it back approximately three-eighths inch, after which the gas escapes through slots in the gas-cylinder tube. During this movement the piston and slide move to the rear.

This action tends to pull the bolt down at the rear out of engagement with the locking shoulder in the top of the receiver. The bolt and slide are now free to move to the rear. During the first quarter inch unlocking movement there is no movement of the bolt, but the slide and the gas piston withdraw the firing pin from the face of the bolt. During the last eighth inch movement the bolt moves back, slowly pulling the empty cartridge case free in the chamber before unlocking. This initial extraction takes place while the

bolt links are rotating and the bolt is dropping down from in front of the locking shoulder.

With the continued rearward movement the empty case is pulled out of the chamber and held against the face of the bolt by the extractor. When the mechanism has traveled approximately five inches, the rear left portion of the base of the cartridge strikes the ejector which is an integral part of the buffer housing. This forces the empty case to pivot around the extractor and fly out through the ejection slot cut at the right of the receiver. At the termination of the movement the rear of the slide strikes the sear buffer compressing its release spring.

When the sear buffer release moves back, it allows the buffer plunger spring to force the sear up and catch the slide, holding it to the rear. This occurs only in semiautomatic fire.

In full automatic fire the slide strikes the sear buffer release which flies back compressing its spring. In this case the rear of the sear has locked the buffer down so that it will not catch the slides. Therefore the slide goes back and forth over the sear and its buffer, never making



Chatellerault Aircraft Machine Gun, Model 1934-39, 7.5 mm, Fixed.

contact until the pressure on the trigger is released.

The safety is shaped so that, when turned to *S* (*Safe*), the two ribs on its shaft prevent either or both of the triggers from being pulled. When set on *F* (*Fire*), the two ribs are freed allowing either trigger bar to release the sear.

The dual-trigger system is very unique. When the rear trigger is squeezed, it rotates on its pin camming the front end of the sear up and forcing it to rotate, thus bringing the rear of the sear down. This action compresses the sear spring and disengages the sear from the slide, allowing it to go forward under the tension of the compressed recoil spring. This action constitutes full automatic fire.

When the front trigger is squeezed, it rotates on its pin. A disconnecter is attached directly to the trigger. Its rotation causes the front end to be depressed, which forces the disconnecter up against the under surface of the front of the sear.

When pressure on the trigger is released, this action forces the disconnecter down against the forward face of the sear. It is thus snapped out of engagement with the trigger, permitting single shots to be fired.

In order to utilize the Chatellerault for other than infantry use, the mechanism was modified for feeding with belted ammunition in lieu of the spring-loaded magazine. Further redesign resulting in faster operation made it adaptable for aircraft use. These changes made their appearance in what was designated the Chatellerault Tank, Armored Car, Fortress, Model 1931. Essentially the gun was the same as the 1924-29 models with the exception of better heat treat-

ment of parts and the substitution of a huge magazine-driven feed for the clip.

The tank- and armored-car gun had a post and feed drum somewhat like the Lewis projecting horizontally from the right side plate only. For fortress use only, as in the Maginot line, the same feed could be fastened on either the left or the right side with ejection through the bottom of the receiver. The weight of the gun was 36 pounds and the empty drum weighed ten pounds. These figures show the unusual weight of the drum in relation to the gun. Its capacity of 150 rounds naturally made it much more out of proportion when loaded and secured to the side of the gun.

For fortress use, the Chatellerault had as an accessory an unusual cooling device that operated from the recoil and counter recoil of the bolt to inject from the chamber end a small jet of water into the barrel between extraction and loading. The French kept this feature secret, claiming that from a fixed position like the Maginot line where water was available they could fire bursts of unheard-of lengths without overheating the barrel.

After the 1931 model had definitely corrected the bad features of the 1924-29 gun, the French air force, in seeking a lightweight high speed gun, ordered the Chatellerault Arsenal to improve the design further. In a relatively short while the Chatellerault Aircraft Machine Gun, Model 1934, A, TO and 39, was produced. Again it was basically the same as previous models. The "A" was for "Aile" or wing mounting; "TO" for tourelle installation, both drum fed; and the "M 34/39" was a belt-fed version for wing mounting.

The rate of fire on the aircraft guns was officially given as 1,500-1,600 rounds per minute but American representatives in France credited it with not more than 1,300 rounds a minute. The 1934 version had a much longer feed post than the Fortress model, since the magazine held 500 cartridges. The circular feed was gear driven by the gas action of the gun, with a ring gear encircling the upper portion of the magazine which had the abnormal depth of 16 inches in order to accommodate the 500 cartridges. The ring gear was attached to a rack that engaged teeth on the body of the gas piston. To be installed in a plane, the weapon had to be placed with the left side plate down. The magazine support post attached to the right side plate made mounting on its sides difficult in fixed positions.

The French kept all work and development on

the Chatellerault aircraft gun in highly classified status, but it was learned that a 1934 model had also been successfully synchronized and that a new driving spring was employed that gave results far in excess of anything previously used. The idea was by no means original since, according to M. Brisorgouil, Assistant Director and Production Manager of Chatellerault Arsenal, "the new type of spring has a life at least double that of the usual type."

He considered that "the new spring provides a radical improvement in automatic weapon functioning. The design is attributed to the Russians. It was discovered by examination of Russian aircraft machine guns used in Spain. . . . In place of forming the spring by coiling a single wire, the spring is formed by coiling three lengths of smaller diameter piano wire which have been twisted together."

## MADSEN AIRCRAFT MACHINE GUN

## The Aircraft Version of the Madsen

The Danish Recoil Rifle Syndicate of Copenhagen in 1923 assigned its chief engineer, a Mr. Hambroc, the job of redesigning the existing Madsen rifle-caliber infantry-type machine gun to aircraft use. Because of its flat profile, the weapon was comparatively easy to adapt to plane installation. The only significant change made was the addition of a muzzle booster with considerable restriction in its throat and a heavy spring buffer to dampen out the shock of the accelerated recoil the booster gave to the operating parts.

The rifle-caliber aircraft version weighed 18½ pounds and had a cyclic speed of 1,000 rounds a minute. One of the main selling points with

this machine gun was that it could be synchronized for fixed installations and still be light and maneuverable enough for successful flexible mounting.

The Junkers aircraft plant in Denmark, which assembled its planes from components made in Germany, bought thousands of the weapons for use in its products. This firm was German-owned but in order to operate and be free of Allied control, it had assembly plants in Denmark and Sweden. It sold fighter craft equipped with Madsen machine guns of varying calibers to any country interested.

Chambering the barrels to handle any rifle-caliber ammunition desired was comparatively easy for the Danish gun company, as it had already produced over a hundred different models

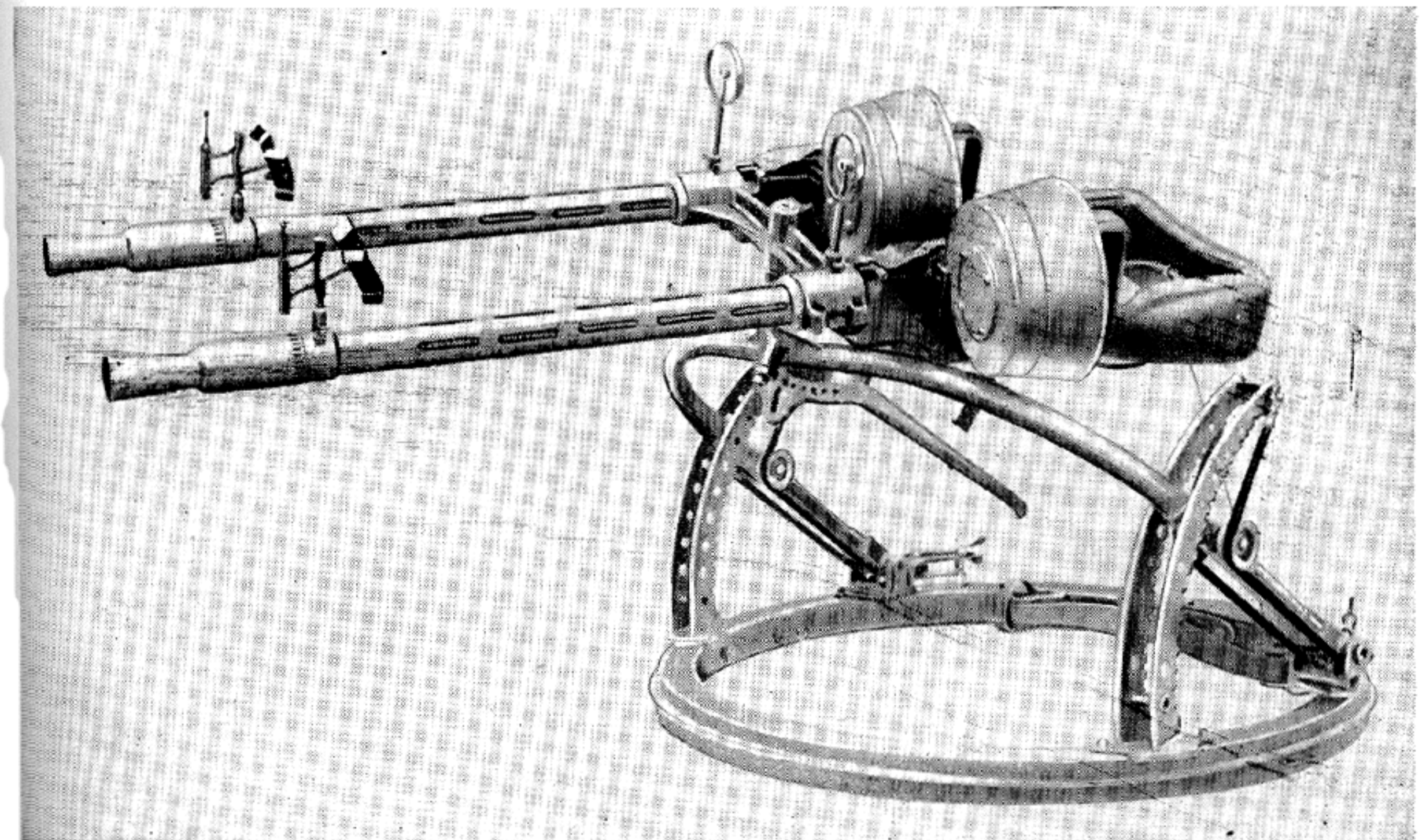

Madsen Aircraft Machine Gun, 7.92 mm, Flexible Twin Mount.

for infantry use ranging in caliber from 6.5 mm to 11.35 mm and using both rimmed and cannelure-type cartridges.

The caliber 11.35-mm machine gun had an oil buffing arrangement to slow the heavier but equally fast barrel and its extension. It too had a rate of fire officially stated as being 1,000 shots per minute. The first successful working model of this type of weapon was proofed at the company's range near Copenhagen in 1926.

The mounting of the Madsen as a flexible gun was very unusual in appearance as the shoulder stock in some form was retained. Installation was done in pairs on the conventional Scarff ring with a bar arrangement connecting the two rifle butts shaped in such a manner that the gunner could use its center as a brace for his chest.

Both triggers of the guns were operated from a single trip mechanism. The feeds were peculiarly shaped drums with carrying handles in the rear. Each gun had its separate aircraft-type

ring sight so that the weapons could be operated independent of each other. Everything considered, it was a very clumsy arrangement and was never popular outside of small countries that had to have low-cost aircraft armament.

The Danish Recoil Rifle Syndicate prided itself that its fine machinery, as well as its system of shop management, were of American origin. The owners claimed that it was the only arms producing plant on the continent capable of mass production equal to that of a similar factory in America.

The cycle of operation for each model is identical. When the belt-fed automatic machine gun version is prepared for firing, the ammunition belt is started into the left side. The disintegrating links used in the feed belt are of peculiar design. The front of the link fits over the shoulder of the round which has to be pulled through it by the feeding action. The rear portion of the link is of the type known as the push-out or half-link, in that it does not go all the way around the

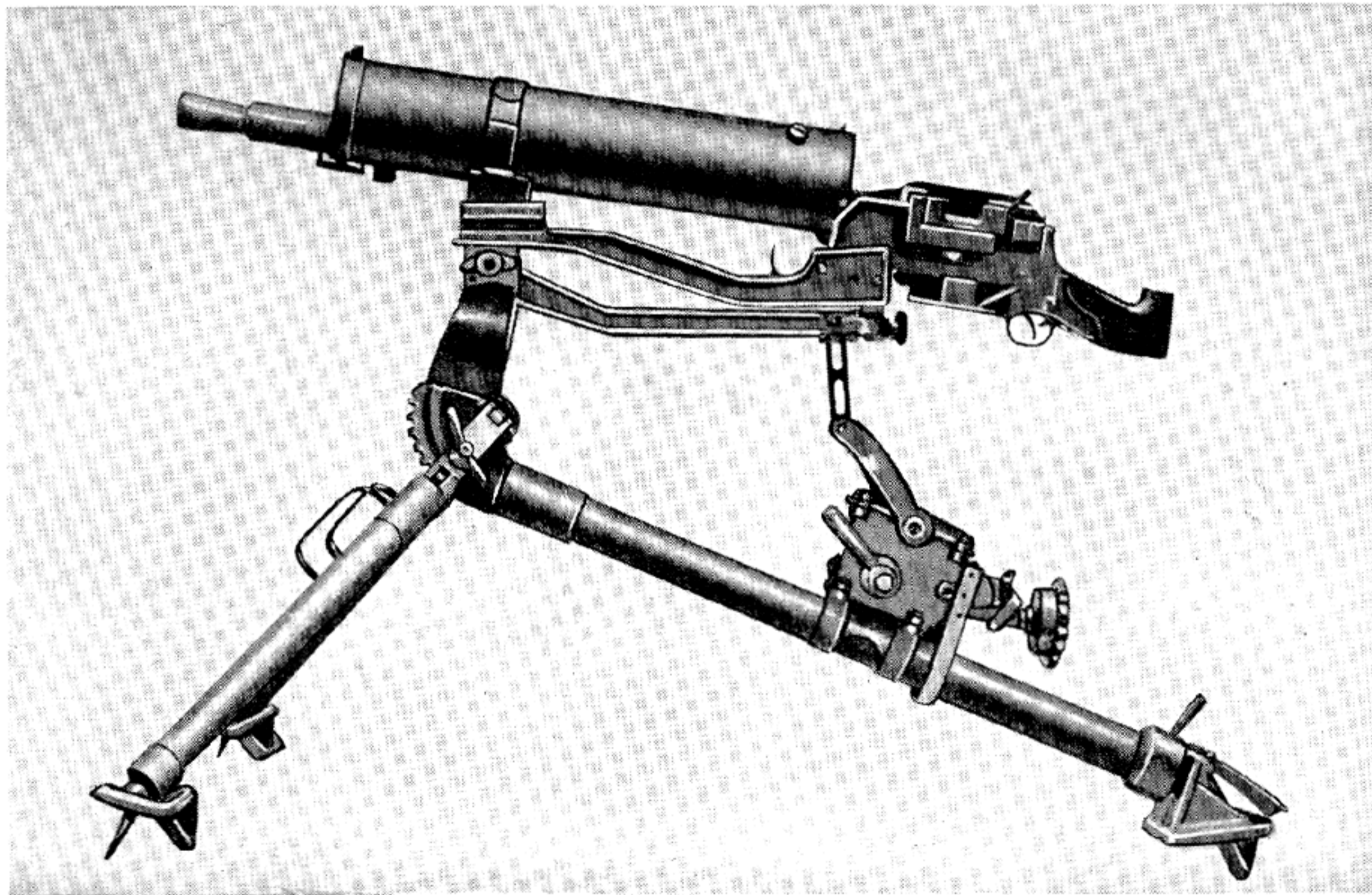

Madsen Machine Gun, Model 1926, 7 mm, Water Cooled.



base of the cartridge. A sharp claw of spring steel holds the case firmly until it is finally withdrawn.

Once the weapon is cocked and the first cartridge is placed under the belt-holding pawl, the large charging handle on the right side is pulled back. This action moves the barrel extension a considerable distance to the rear after the bolt rises. The pawl holding the cartridge in position is carried to the right by the camming action taking place between the barrel extension and the piece supporting the incoming round until the cartridge is forced through the feed slot in the receiver.

At this time a spring-loaded claw snaps over the rim of the cartridge. The pivoting of the feed arm actuates the claw rearward and withdraws the cartridge from the belt, positioning it in the feed trough in the top of the bolt. The pivoting lever has by now taken its place behind the round. Upon release of the cocking handle the energy of the compressed driving spring sends the lever forward. The front end of the bolt is pivoted down below the bore in the barrel. Further movement forward of this lever causes it to strike the base of the cartridge, ramming it into the chamber. The final pivot movement raises the breechblock full behind the bolt and the weapon is ready to fire.

The rearward pull of a trigger releases the large striker which flies upwards in an arc against a firing pin, detonating the primer. During recoil, the barrel, barrel extension, and bolt are securely locked for one-half inch, until the trigger bar is struck by the rear of the recoiling

bolt mechanism. This frees it, allowing the striker to be forced back to the cocked position and the spring-loaded firing pin is withdrawn into the bolt body. The guide stud then passes out of the horizontal groove and travels up the top cam of the switch plate to pivot the bolt face upwards. The base of the empty cartridge case is thus uncovered, permitting the recoiling extractor to apply a sudden mechanical advantage as it strikes the lug in the bottom of the receiver. The extractor claw, in one rolling motion, not only withdraws but ejects the empty case from the chamber. The case is guided out of the receiver by the curved contour of the bolt until it falls clear to the ground.

During the last of the recoil movement the barrel extension has cammed another round into the receiver feed slot, and the pivoting feed and operating arm positions it in the trough formed by the machined recess in the top of the bolt. Counterrecoil, originating in the stored energy of the driving spring when it starts the entire operating assembly back to battery first depresses the bolt and then drives the cartridge into the chamber.

The bolt and barrel extension are then accelerated forward by this spring acting through the medium of the cammed pivoting of the radial operating arm. When the counterrecoil movement is almost completed and the base of the cartridge is fully covered by the rising of the pivoting bolt, a cam on the arm automatically releases a sear if the trigger is still held rearward. The striker again flies up to continue the cycle.

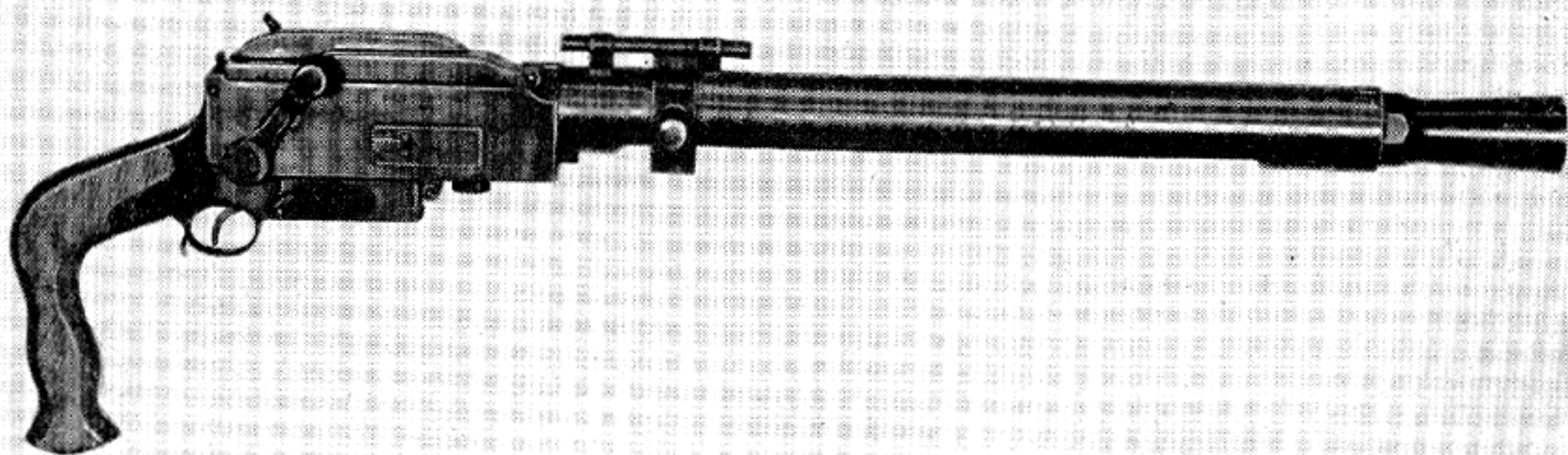

Madsen Tank Machine Gun, 7.5 mm.

## Models and Users of the Madsen

Perhaps no machine gun has been made in so many different models and bought by so many countries as the Madsen. The following tabulation covers five decades of the weapon's distribution throughout the world:

Country	Model	Bore
Argentina	1910	7.65 mm
Argentina	1925	7.65 mm
Argentina	1926	7.65 mm
Argentina	1928	7.65 mm
Argentina	1931	7.65 mm
Argentina	1935	7.65 mm
Bolivia	1925	7.65 mm
Brazil	1908	7.00 mm
Brazil	1913	7.00 mm
Brazil	1916	7.00 mm
Brazil	1925	7.00 mm
Brazil	1928	7.00 mm
Brazil	1932	7.00 mm
Brazil	1934	7.00 mm
Brazil	1935	7.00 mm
Brazil	1936	7.00 mm
Brazil	1946	7.62 mm
Bulgaria	1915	8.00 mm
Bulgaria	1927	8.00 mm
Chile	1923	7.00 mm
Chile	1925	7.00 mm
Chile	1926 w/c	7.00 mm
Chile	1928 w/c	7.00 mm
Chile	1940	7.00 mm
Chile	1946	7.62 mm
China	1916	7.92 mm
China	1930	7.92 mm
China	1937	7.92 mm
Czechoslovakia	1922	7.92 mm
Czechoslovakia	1923	7.92 mm
Denmark	1904	8.00 mm
Denmark	1916	8.00 mm
Denmark	1919	8.00 mm
Denmark	1924	8.00 mm
Denmark	1939	8.00 mm
Denmark	1946	7.62 mm

Country	Model	Bore
England	1915	7.69 mm
England	1919	7.69 mm
England	1929	7.69 mm
England	1931	7.69 mm
England	1939	7.69 mm
Esthonia	1925	7.69 mm
Esthonia	1937	7.69 mm
Ethiopia	1907	7.92 mm
Ethiopia	1910	7.92 mm
Ethiopia	1934	7.92 mm
Ethiopia	1935	7.92 mm
Finland	1919	7.62 mm
Finland	1920	7.62 mm
Finland	1921	7.62 mm
Finland	1923	7.62 mm
France	1915	8.00 mm
France	1919	8.00 mm
France	1922	8.00 mm
France	1924	8.00 mm
Holland	1919	6.5 mm
Holland	1923	6.5 mm
Holland	1926	6.5 mm
Holland	1927	6.5 mm
Holland	1934	6.5 mm
Holland	1938	6.5 mm
Holland	1939	6.5 mm
Honduras	1937	7.00 mm
Honduras	1939	7.00 mm
Hungary	1925	7.92 mm
Hungary	1943	7.92 mm
Italy	1908	6.5 mm
Italy	1910	6.5 mm
Italy	1925	6.5 mm
Italy	1930	6.5 mm
Italy	1931	6.5 mm
Lithuania	1923	7.92 mm
Mexico	1911	7.00 mm
Mexico	1934	7.00 mm
Norway	1914	6.5 mm
Norway	1918	6.5 mm
Pakistan	1947	7.69 mm

Country	Model	Bore	Country	Model	Bore
Paraguay	1926	7.65 mm	Sweden	1906	6.5 mm
Peru	1929	7.65 mm	Sweden	1914	6.5 mm
Portugal	1930	7.69 mm	Sweden	1921	6.5 mm
Portugal	1936	7.69 mm	Turkey	1925	7.92 mm
Portugal	1942	7.69 mm	Turkey	1926	7.92 mm
Portugal	1936	7.92 mm	Turkey	1935	7.92 mm
Portugal	1940	7.92 mm	Turkey	1937	7.92 mm
Portugal	1947	7.92 mm	Thailand	1925	8.00 mm
Russia	1904	7.62 mm	Thailand	1930	8.00 mm
Russia	1915	7.62 mm	Thailand	1934	8.00 mm
Salvador, El	1934	7.00 mm	Thailand	1939	8.00 mm
Spain	1907	7.00 mm	Thailand	1947	8.00 mm
Spain	1922	7.00 mm	Thailand	1949	8.00 mm
			Uruguay	1937	7.00 mm

## B. S. A. AIRCRAFT MACHINE GUN

During the latter days of World War I the British realized that with the advent of armor on planes a machine gun capable of canceling this advantage had to be developed. They first tried to raise the caliber of the very reliable .303 Vickers, which was done with questionable results. The next attempt was in January 1924 when the Birmingham Small Arms Co., which had produced the successful Lewis gun in great quantities in the war years of 1914-18, presented its design of a larger caliber machine gun somewhat along the lines of the justly famous Lewis. In fact, the resemblance was so striking that the weapon has often incorrectly been classified as a caliber .50 Lewis.

However, with physical appearance all similarity ends, for the B. S. A., as it is officially known, is a recoil-operated weapon that could be cooled by both air or water depending on the jacket used. It employed, in lieu of the metal link belt, the drum-type feed that held 37 caliber .50 cartridges. The weapon was simple in construction, and could be fired either single or full automatic. The components were very strong, and disassembly and assembly could be performed manually without the aid of tools. The need for a larger caliber free gun for observers was thought necessary as a companion arm to the forward firing ones in the wing installations.

The B. S. A. made its first appearance in 1928 and was tested by both the Royal Air Force and the British Navy. The aircraft version was cooled by radial fins on the barrel and by large holes bored in the jacket allowing circulation of air. The water-cooled gun had a conventional barrel jacket that allowed water to be pumped through the system by means of flexible hoses leading to a simple supply pump.

While the feed system was visually the same as used by the Lewis, it had a feature not to be found on any other such type of feed. The drum with but a 37-round capacity could by no means

be considered adequate. Through spaces cut on top, however, the gunner could replenish his supply without interfering with his readiness for instant action, as removal of the drum from its post for recharging was not necessary. Cartridge cases were ejected from underneath the action. This was a distinct advantage for aircraft use, especially from an observer's standpoint, since the empty brass would be thrown on the floor of the cockpit and not out into the windstream to hit other friendly ships in a formation. Both spade grips and slide chargers could be placed on the receiver for aircraft use if desired by the operator.

To fire the caliber .50 B. S. A., the loaded magazine is placed on its post with the first cartridge positioned at the cam mouth of the magazine center. The charging handle is pulled to the rear until the bolt engages the sear holding the entire recoiling mechanism in a cocked position. The selection lever is then placed on single shot or automatic, as desired. When the trigger is pulled, the operating mechanism goes forward under the stored energy of the compressed driving spring, strips the round from the feeder and chambers it. The spring-loaded firing pin is tripped by the rotation of the bolt sleeve, locking it to the barrel. The firing pin is thereby allowed to fly forward and fire the chambered round.

The recoil action that follows the building up of the powder gases from the exploded charge finds the barrel, barrel extension, bolt, bolt sleeve, and two pieces called extension rods, all locked together for a  $2\frac{7}{8}$ -inch recoil. At the end of this travel the unlocking lug has revolved by means of an engaging cam. This causes the lug to revolve the bolt sleeve enough to unlock the bolt from the extension and barrel.

The rearward movement of the barrel is stopped by the front extension collar coming in contact with its buffer. The barrel is then brought back by its stout return spring to its

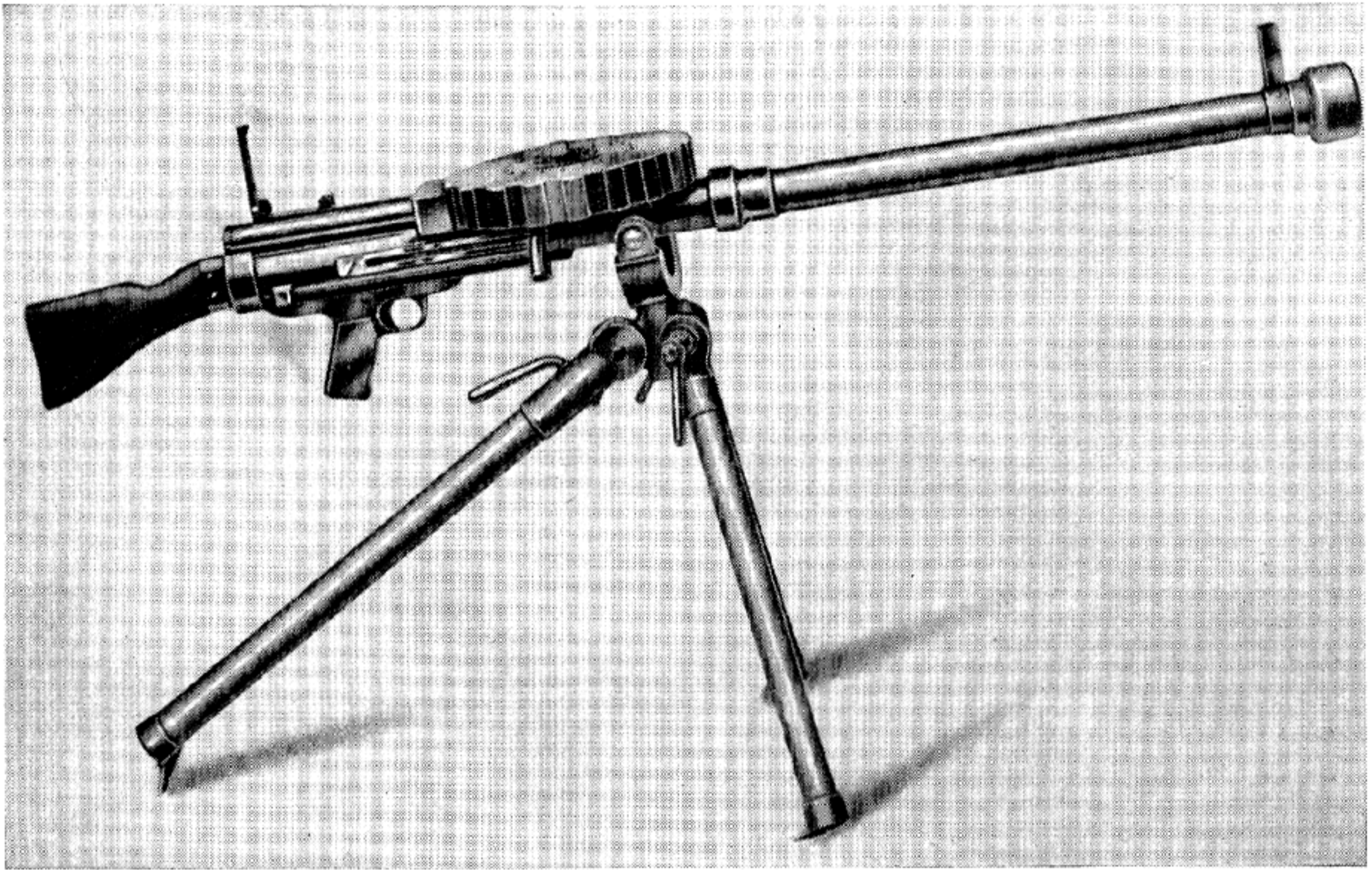

B. S. A. Aircraft Machine Gun, Cal. .50.

forward or normal position. The bolt, its sleeve, and striker all continue rearwards. The slow unlocking action permits initial extraction and when the bolt is nearing the end of its backward stroke, the front face of the end of the slot in the upper side strikes the protruding end of an ejector piece. The latter is slidably located in an inclined slot in the upper resistance lug in the bolt head and ejects the spent cartridge case in a downward direction through openings in the under side of the receiver.

In order that the breech bolt sleeve, breech bolt, and striker may be held in a cocked position until the barrel and barrel extension have reached battery position, the weapon has a safety lever device incorporated in the trigger guard frame. One lever is pivoted to the fulcrum pin of the sear, while its rear end is so constructed as to be moved by a spring into engagement with the bent on the bolt sleeve while its forward end is mounted on the fulcrum pin of the trigger. A second lever in this complicated arrangement engages a cam in the underside of

the barrel extension and when the latter is returned to battery, this depresses the trigger bar and permits firing only when all operating parts are securely locked.

The inner construction of this gun is very unusual. In the sides of the barrel extension are found open-sided slots, in which move what are called resistance lugs located on the head of the bolt sleeve. Near the front end of the barrel extension piece are shoulders that engage the resistance lugs. This operation is effected during the limited independent longitudinal movement of the bolt sleeve in relation to the bolt body.

The bolt body is provided at its rear end, on its upper and lower sides, with flat bearing surfaces that engage its slideway in the barrel extension. The front end of the bolt sleeve has lugs that engage the open-ended slots formed in the sides of the barrel extension.

The hollow bolt body houses the striker which is connected to the sleeve by means of a cross bar arranged to pass through a helical slot in the body. The slot is designed to permit a limited in-

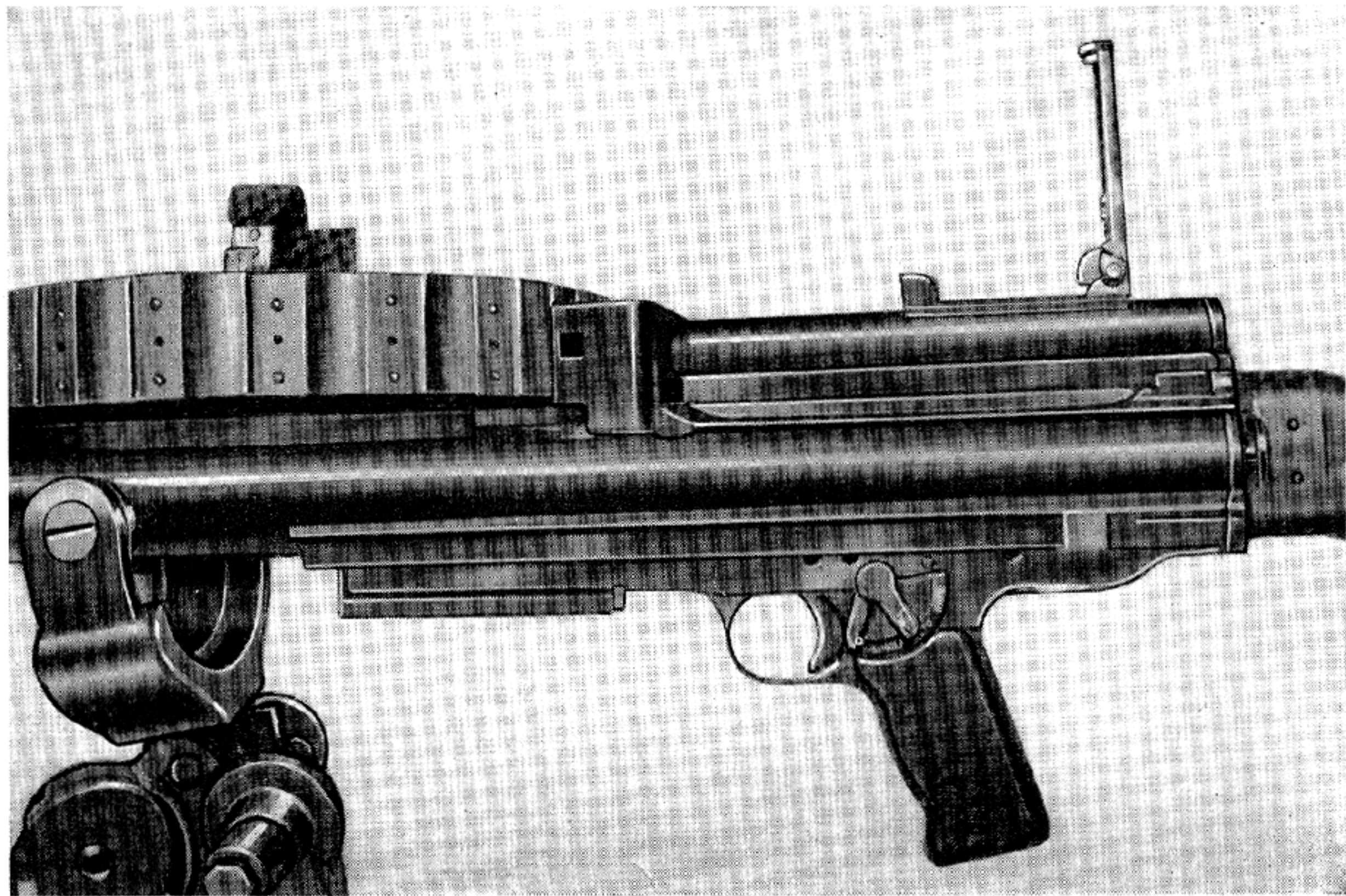

Receiver, Grip and Feed of B. S. A. Aircraft Machine Gun, Cal. .50.

dependent longitudinal movement of the bolt sleeve and striker, during which a part rotative movement is imparted to the bolt to effect locking and unlocking by the resistance shoulders in the barrel extension piece engaging the resistance lugs.

Two such B. S. A. weapons were manufactured. One was turned over to the Royal Air Force and the other to the British Naval Air Force, for testing purposes. The ammunition was the same as used successfully in the Vickers caliber .50 gun and was manufactured by the Kynoch Co. of Birmingham, which cooperated with B. S. A. to produce an adequate round of ammunition. The velocity of the 813-grain projectile was officially set at 2,600 feet per second.

The trial was held at Hythe, England, and proved very disappointing. After the low rate of fire, namely, 400 rounds per minute, the most criticized feature was the capacity of the drum. It was suggested that this be increased to a mini-

imum of 97 rounds. The long travel of  $2\frac{7}{8}$  inches before unlocking made it practically impossible to speed up the gun without complete redesign.

The  $2\frac{7}{8}$ -inch recoil travel before unlocking is an inexplicable feature on the B. S. A. This movement is the longest known for such a recoil-operated mechanism. Technically, it comes under the classification of short-recoil operation, since the travel does not exceed the over-all length of the cartridge. It remains a mystery why the British slowed down the cycle of operation with such a long unlocking stroke, as it had been proved in earlier machine guns using the same cartridge that unlocking the recoiling parts after  $\frac{3}{4}$  inch rearward travel was safe.

Its faults, coupled with the fact that power-driven turrets were beginning to take the place of the observer and his free gun in aircraft, left the B. S. A. with no future in British aircraft weapon design.

The gun is an outstanding example of what

generally happens when a machine gun that has been used to good advantage in the past for a specific purpose is copied to any extent when a weapon serving another function is needed. The Lewis gun, which was so similar in appear-

ance to the B. S. A., was quite satisfactory as a light free caliber .303 gun for open cockpit observers. When weight was added for the large caliber, it became too unwieldy and the rate of fire was prohibitive.

## BREDA MACHINE GUNS

The locomotive works known as the Società Italiana Ernesto Breda of Brescia, Italy, during the emergency created by World War I, commenced production of machine guns for the Italian Government. Plans and specifications were furnished the Breda firm by order of the military authorities. The first automatic weapon so made was the water-cooled Revelli, Model 1914, the manufacturing drawings being farmed out to it by the Fiat Co., holder of the patents. Breda built a separate plant adjacent to its locomotive works which, during the war and immediately thereafter, engaged in manufacturing and delivering thousands of the above-mentioned Revelli guns.

Following the Armistice, as with other arms companies in Italy, work came to a near halt with only enough government orders for modifications on existing models to keep a skeleton force active. However, all service branches were in need of an Italian-designed lightweight machine gun for infantry and a heavy one that could be used both as a heavy ground machine gun and with a modified mechanism for aircraft installation. Such a weapon could be mounted both as a synchronized fixed gun for forward firing and as a free one for observers.

The first Breda attempts at securing the lucrative government contracts, then being offered as an inducement by General Buffi, the assistant director general of all machine gun experimental work, was the production of the Breda 1924 model. The weapon introduced at this time was chambered for the 6.5-mm caliber cartridge and weighed slightly under 20 pounds. The rate of fire was officially credited as being 500 rounds a minute. The feed system had an oddly designed magazine that pivoted for charging. The barrel could be changed instantly as it connected to the barrel extension by means of heavy interrupted threads. The rear of the receiver was round while the center part over the feedway was flat, giving the weapon an unusual silhouette.

A skeletonized barrel jacket gave the necessary support for recoil of the moving parts and also served as a base for the front sight. Large flanges on the upper part of the barrel body acted as guides, while a flash hider was attached to the muzzle end. A graduated rear sight was placed on the receiver. It could be either elevated or depressed without need for the gunner to rise from the prone position generally taken when this weapon was fired. A large oil reservoir was built into the top of the receiver, directly over the



Breda Machine Gun, Model 1924, 6.5 mm. The Operator is Loading the Weapon.



feedway. This lubricator was operated by the recoil and counterrecoil movement of the barrel and barrel extension, squirting oil with each complete cycle on the rounds then being positioned on the floor of the feedway.

To operate the Breda 1924 light machine gun, the gunner is generally in a prone position with the stock at his shoulder. The magazine is first released by its latch holder and the end pivoted towards the muzzle. This exposes the rear of the magazine so that the cardboard container holding 20 rounds of ammunition is positioned in the mouth and by a forward movement of the finger the cartridges are shoved into the magazine until the last round has been secured behind the holding pawl. At this time the cartridge container is discarded and the loaded magazine is swung into position with the last cartridge in place to be picked up by the bolt.

The charging handle is grasped by the right hand and pulled all the way to the rear, compressing the driving spring and cocking the

piece. At the rearmost position the charging handle is released and it and the operating parts are all driven forward by the energy of the driving spring. On the forward travel of the bolt a feed rib on the side contacts the base of the first round in the magazine, forcing it towards the chamber. For approximately one-half the length of the magazine the cartridge slides forward held by the lips. When the round is slightly over half-way out of the magazine, under pressure of the spring-loaded follower it is kicked out of the feed system into alignment with the chamber. During this movement the nose of the bullet is guided by the bullet ramp on the bolt lock. Continued travel forward chambers the round, and the extractor snaps over into the cannellure of the cartridge case.

When the bolt is  $1\frac{1}{2}$  inches from home, it begins to enter the locking ring, and at a point  $\frac{3}{8}$  inch from its battery position, the bolt strikes the breech end of the barrel. The force of the strong driving spring causes the bolt, barrel, and

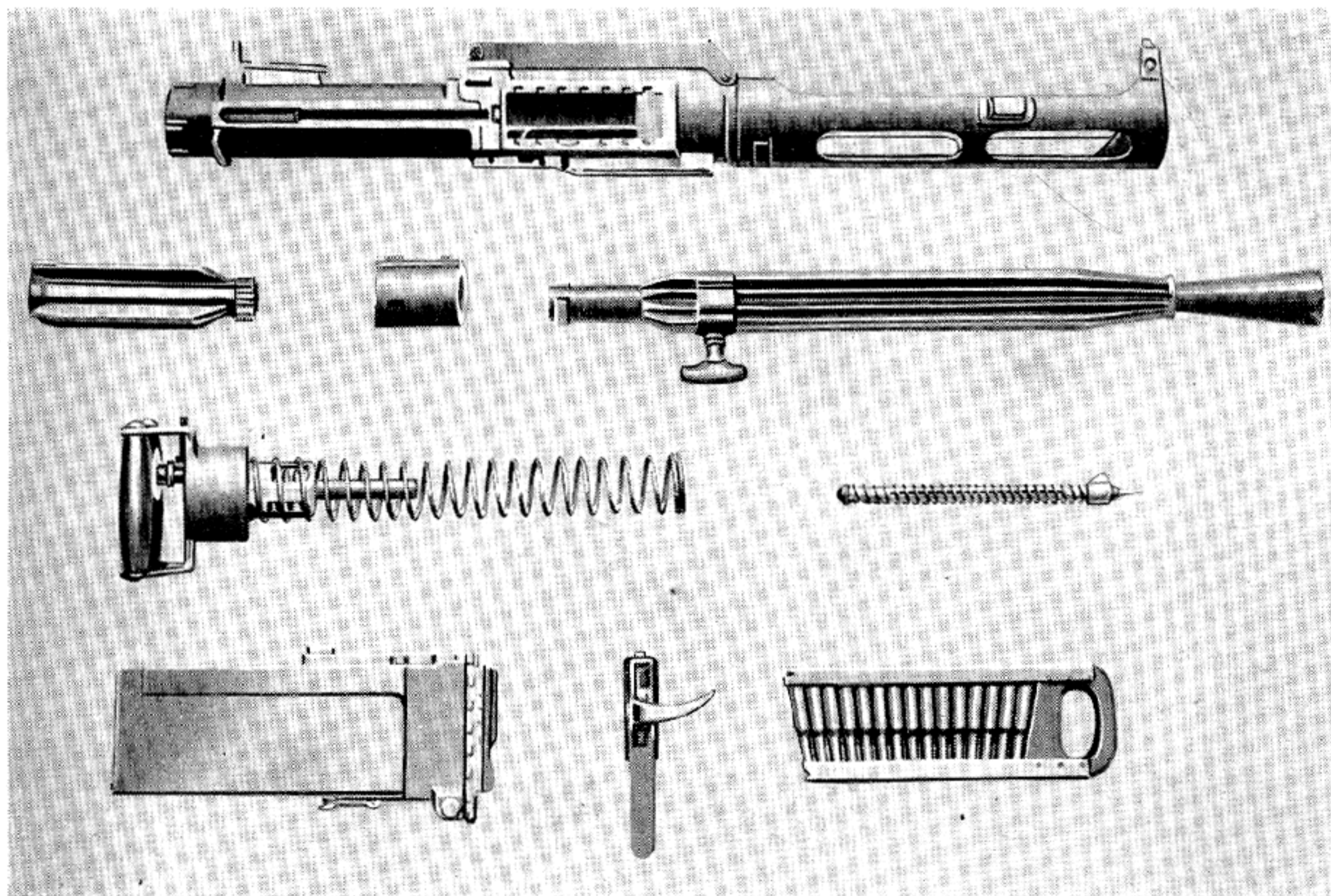

Components of the Breda Machine Gun, Model 1924.

lock to move forward. This motion causes the rear lug on the locking ring to engage the fixed cams in the receiver forcing the lock to rotate partially around the end of the barrel and the locking lugs on the front of the bolt, thus locking these two pieces positively into position. The Breda is now ready to fire.

Pressure on the trigger forces the sear release forward compressing its spring. The sear is cammed down out of engagement with the notch in the rear end of the firing pin which flies ahead to strike the primer detonating the powder. As the pressure from the explosion starts to build up, the locked barrel and bolt move together  $\frac{3}{8}$  inch to the rear. During this recoil the front lug on top of the locking ring engages the fixed unlocking cam in the receiver, causing the lock to rotate. The bolt is suddenly unlocked without benefit of initial extraction.

The extractor snatches the empty cartridge case from the chamber and holds it on the bolt face. The ejector riding on the right side of the bolt pivots out under tension of its spring. The extractor holds the case firmly against the ejector until it is snapped out when the ejection slot in the left side of the receiver is reached. As the bolt continues on to strike the buffer it also carries with it the firing pin. The rear end of the pin passes through the buffer into the sear housing. At this point the firing pin spring is fully com-

pressed and the sear drops in its recess, holding it back under full tension.

On counterrecoil the bolt and all other operating parts are driven forward by the energy of the driving spring and the rebound of the recoiling parts off the buffer. As the bolt passes the magazine, it picks up a round and chambers it. When securely locked, if the trigger is still pulled back, the rear end of the bolt cams the firing pin safety sear out of the path of the pin, allowing it to go forward and fire the gun again.

On counterrecoil the bolt and all other operating function. The oiler piston is cammed up into the oil cylinder by the bolt. As the piston is raised, it creates a pressure, squirting the lubricant out of a small spout on the right side of the cover. The latter is fixed directly in line with the mouth of the magazine so that incoming rounds are oiled as they are positioned in the feedway. On the recoil movement of the bolt, the piston rides in a groove on top of the bolt until it is approximately one inch from its rearmost position, at which time it has reached the end of its beveled cam. All pressure is released, and air taken in for the return stroke.

When the safety is placed on *S*, a guard shaped like the letter *U* is dropped over the trigger to prevent rotation. When changed to *F*, this part is removed and the trigger is free to move. As this weapon fired from a front-seared bolt and held



Breda Machine Gun, 6.5 mm, Showing Ease of Barrel Change.

a cartridge in the hot chamber after a long burst, a rear sear device was placed on this gun that allowed the gunner to pull the charging handle to the rear and hold the operating mechanism until cool enough to resume firing. To release this arrangement, the bolt handle had only to be retracted beyond its catch point.

The Breda Co. soon after the introduction of the 1924 model made several external refinements and brought it out in competition to the Fiat owned Safat plant which was at the time producing a machine gun that also carried the same designation and was known as Model 1926. The two guns were tested together and the Breda proved the best, although neither was adopted at the time. The Breda firm, however, was given an order for 2,000 not only to pay for time and effort spent in producing this gun but also to encourage continued development. Feeling that this sizable order warranted further improvements the designers 2 years later made a few minor changes in the appearance of the gun and gave it the official nomenclature of Breda Model 1928. The operating mechanism was, however, practically identical with the earlier models.

The firm also began production of a 12.7-mm aircraft machine gun in 1928 but did not get beyond a working model. Following unsuccessful trials on its own test range, the company abandoned the project.

Late in 1930 the Breda Co. took over from

the Fiat Co. all machinery, patents, etc., for the manufacture of small arms such as machine guns and automatic rifles. Plans were made for the construction of a plant, called Breda-Fiat located at Piacenza, Italy, near the Fiat tractor factory.

The next venture was the 1930 model light machine gun made in 6.5, 7, and 7.92 millimeter bores. While given different model designations the mechanisms and methods of operation were identical with the 1921 model except for minor refinements and an assortment of calibers. This weapon was sold to other countries, Portugal and some of the Baltic states buying the 7.92 model. Development continued until the appearance of the 13.2-mm 1931 model gas-operated machine gun designed for anti-aircraft and tank use.

The 1931 model Breda was a radical departure from previous designs. Early firing tests proved it to be basically sound. During the following years efforts were begun to scale the large caliber gun down to use the 8-mm cartridge.

This attempt culminated in the Breda model 1937. The gas-operated weapons of this type had many peculiar features. One of the most outstanding was the placing of the empty cartridge case back in the feed tray after firing and ejection of the whole tray. The breech lock was cammed straight up into its recess by action of the inclined surfaces on the piston extension, so that the projection on its upper surface engaged in an opening in the top of the body. The car-

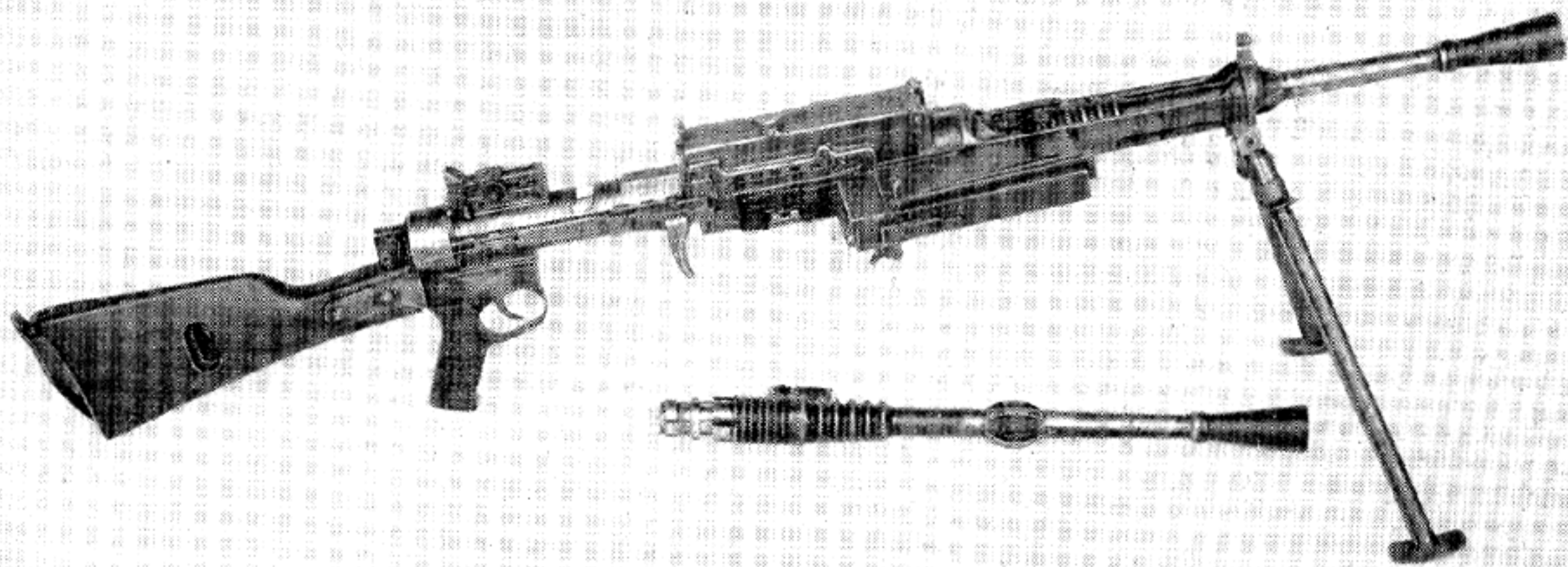

Breda Machine Gun, Model 1930, 6.5 mm.

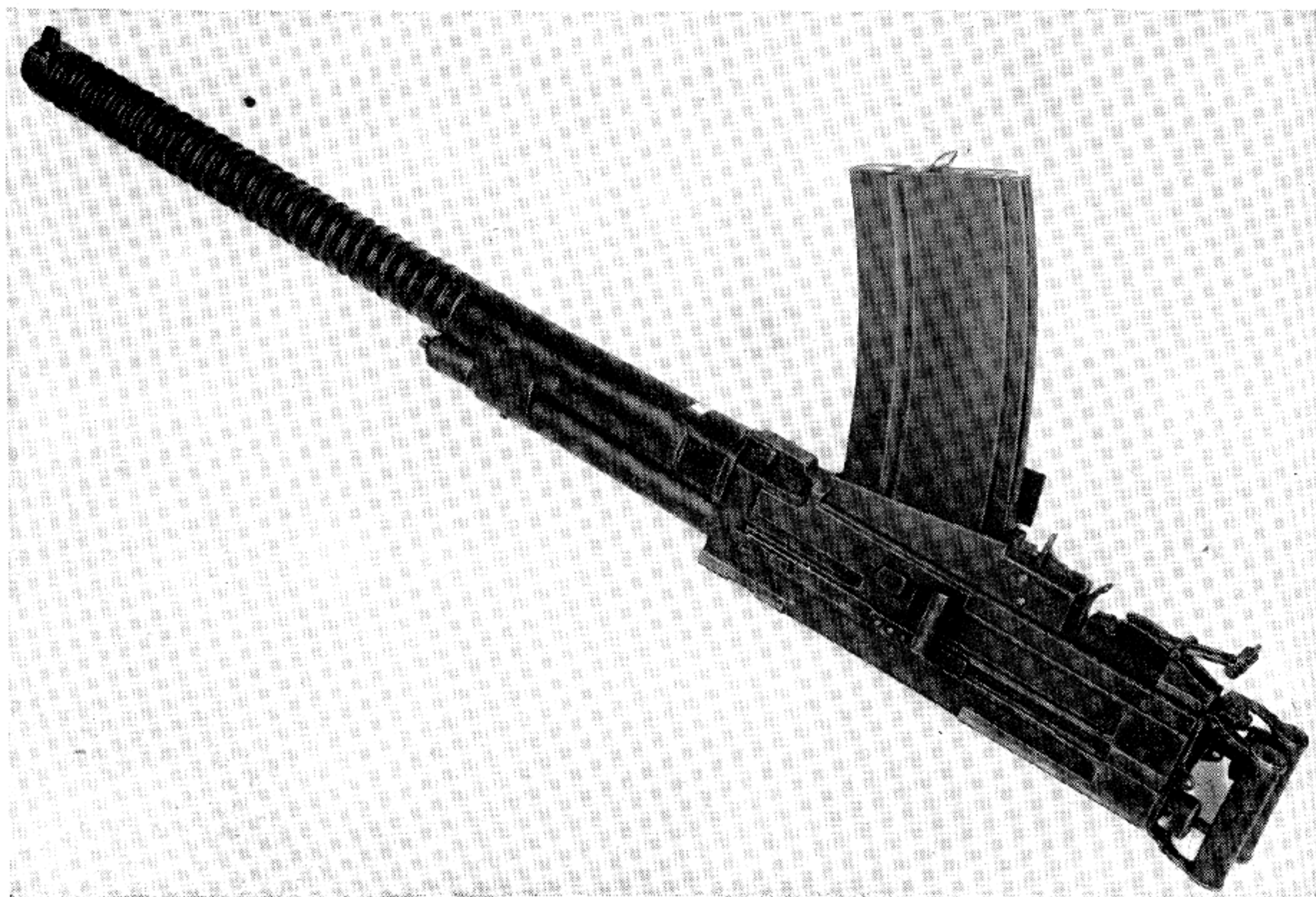

Breda Machine Gun, Model 1931, 13.2 mm.

tridges were fed from plate chargers holding 20 rounds, each round being housed in a separate compartment.

No provision was made for single-shot operation. When the safety was removed, the weapon would fire full automatic only. A special clamp permitted quick barrel change, and the piston was made with an interchangeable head. Cyclic rate could be controlled by ten different settings of the gas regulator.

Like all Italian machine guns oil was used freely on the ammunition since head space was not adjustable on the weapon. The fixed relation between the front face of the breech-lock receiver and the gas port in the barrel made impossible rotation of the barrel in order to advance or retract the chamber for correct head space. The oiling of the ammunition was resorted to in this case in order to compensate for the above condition.

The firing mechanism was held in the cocked

position by a rear searing device. When the pressure had been removed from the trigger button, the device dropped in position at the full-recoil stroke of the gas piston holding the entire assembly aft. The barrel was of unusually heavy construction ( $9\frac{7}{8}$  pounds) permitting the discharge of quite a long burst before overheating caused bullets to "tumble," with resultant loss of accuracy and effectiveness.

To fire the Breda Model '37, the operator inserts a loaded tray holding 20 cartridges in the feed slots in the left side of the receiver and the charging handle on the right side is pulled back as far as it will go. A searing device engages the gas piston locking the whole firing mechanism in the cocked position. When the operating parts are moved rearward by pulling back on the retracting handle, the feed tray is indexed over one space positioning a round. If the trigger is taken off *safe* position and the button pushed in, the sear is disengaged from the gas piston and the as-

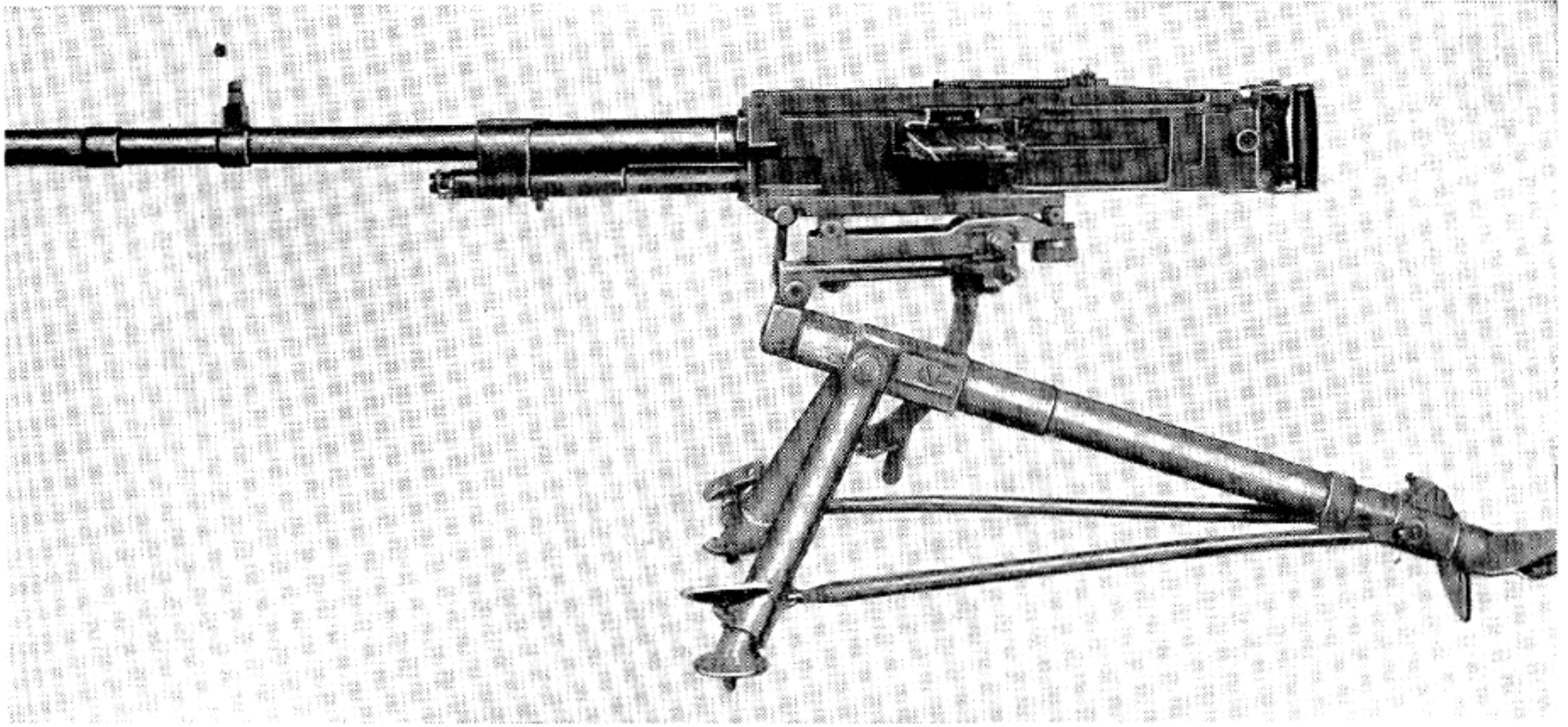

Breda Machine Gun, Model 1937, 8 mm.



Breda Machine Gun, Model 1938, 8 mm.

sembly goes forward, pushing the cartridge out of its container in the feed tray into the chamber. When this is accomplished, the bolt stops and the gas piston continues forward, forcing the breech lock up into the locking recess in the top of the receiver. On the last movement forward of the gas piston after the mechanism is locked, a projection on top of the gas piston strikes the firing pin which in turn hits the primer to detonate the propellant charge.

The expanding gases forcing the bullet out of the bore enter a gas port on the underside of the barrel at a point two-thirds of the distance from the breech end. The gas upon entering the gas cylinder exerts a sudden pressure on the face of the piston housed by the cylinder. The impact force drives the piston to the rear. The piston movement pulls the firing pin back and the breech lock down, freeing the bolt. Its first stage of unlocking jacks the bolt back a few thou-

sandths of an inch, loosening the empty case before fully unlocking.

The bolt and piston then start rearward with the extractor holding the cartridge case to the face of the bolt. At a point directly under the feed tray, a dog on the receiver stops the rearward motion of the case; at the same time a cam forces the empty case up into the space it formerly occupied in the feed tray. Continued recoil of the bolt and gas piston causes the next round to be indexed by a movement to the right of the ammunition clip. When all 20 rounds have been fired, the clip containing the empty cartridges is thrown clear of the gun on the right side after the last shot is fired.

The bolt and piston after striking the spring-loaded buffer start into counterrecoil and, if the trigger button remains depressed, the mechanism will continue forward to fire the next round.

This model of the Breda, chambered for the

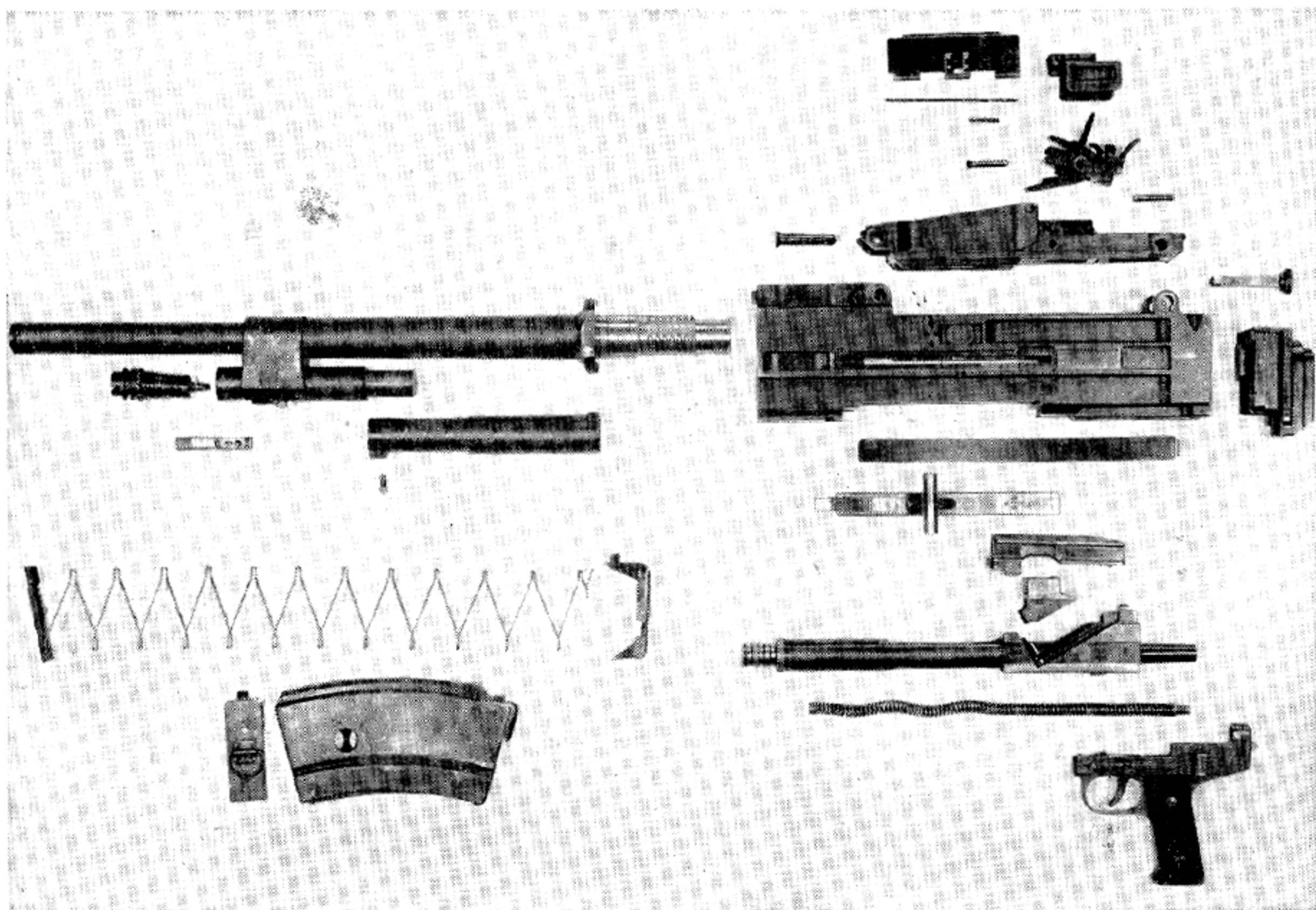

Components of the Breda Machine Gun, Model 1938, 8 mm.

rifle caliber cartridge, showed only the weak points of an otherwise well-designed automatic firing mechanism and these features were corrected at once. It was felt the system of feeding was unsatisfactory; and the following year the 1938 model, having an overhead clip feed, was introduced. It ejected the cartridges out of the bottom of the receiver. The weapon also had a pistol grip. The operating parts and all other principles remained identical with the two preceding models.

A short while before the first of the gas-operated ground machine guns made its appearance, production of all automatic weapons was put under the direct control of the government and Breda was given the assignment of developing an adequate aircraft machine gun. By the middle thirties Safat, the arms division still under control of Fiat, had made a few successful working models that employed the breech lock patented by Mascarucci. The mechanism was later im-

proved by Breda engineers, who inverted the lock, putting it on the bottom, and added a muzzle booster and a recoil-actuated accelerator. These completed modifications were looked upon so favorably by the Ministry of Air that it ordered the immediate production of the gun. To expedite what was considered a superior aircraft weapon, after considering Safat's prior arms commitments, the government directed the Breda Co. to start making the weapon from drawings furnished by the originating company.

These guns were then designated Breda-Safat, Model 1935, to include both designer and manufacturer. They were made in three bores: 7.7, using the same cartridge as the Vickers and Lewis guns, 7.92, and 13.02, for use against armored aircraft and vehicles. The last cartridge was to have had an explosive bullet but it was found to be a violation of international law.

The 7.7-mm aircraft machine gun weighed only 27 pounds with a rate of fire of 800 rounds

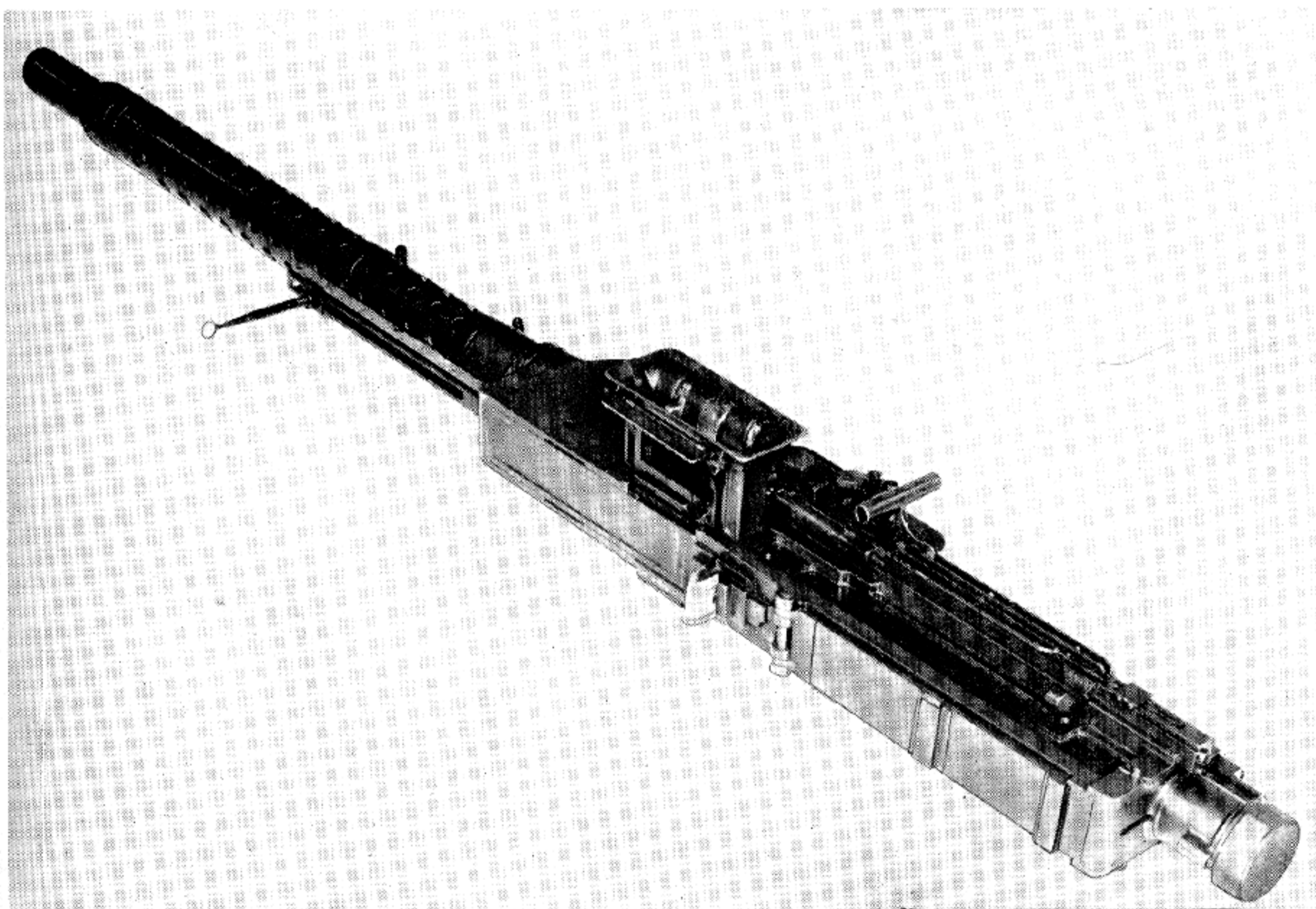

Breda Aircraft Machine Gun, 12.7 mm.

a minute. Feeding was done by means of a metal disintegrating belt and was interchangeable from one side to the other. An extractor claw withdrew the loaded round and knocked out the empty case through the ejection slot in the bottom of the receiver. Charging was accomplished by means of a T-shaped handle fastened on the right side of the receiver. There was no provision for single shots. When the trigger was actuated, automatic fire resulted as long as it was held back. If mounted on a flexible gun, a pistol-grip handle with trigger guard was used. An arrow-shaped safety device was placed on top of the receiver, just behind the feed opening. British ammunition, caliber .303, would function satisfactorily in this gun. The chamber was fluted to facilitate extraction by allowing the high-pressure gas at the instant of firing to cushion or float the empty case.

When mounted as a fixed gun in a wing, a hydraulic charger was added. The weapon was carried in a cocked bolt position, allowing cool air to circulate through the bore after a burst. The muzzle booster allowed the expanding gas after the bullet had cleared the muzzle to be brought to bear on the face of the barrel. Thrust was thus added to the recoiling parts and in so doing unlocking was hastened. All of these factors together resulted in a higher cyclic rate.

While there was very little similarity in appearance, this Breda-Safat gun was the direct outgrowth of the first Fiat mechanism using the Mascarucci locking principle. The cycle of operation remained basically the same but later was refined and modified by adding accessories until it resulted in the standard aircraft machine gun of the Italian air force, regardless of manufacturing designation.



## FURRER MACHINE GUN

Col. Adolf Furrer, when serving as director of the Swiss Government's small arms factory at Berne, Switzerland, applied for a patent in 1924 on a machine gun that was to affect the automatic weapons used by Swiss soldiers for years to come. And while it was produced in great quantities in calibers ranging in size from rifle to cannon, the basic operating features remained identical.

His first gun was known as the model 1925 Furrer and was a lightweight (18 pounds) air-cooled ground gun with a shoulder stock. It was clip fed by a 30-shot magazine, and chambered for the 7.5-mm infantry rifle cartridge used in the Swiss army for over 40 years. The barrel had longitudinal ribs to give strength and cut down dispersion, besides allowing more radiation surface for cooling purposes. It was constructed of steel that had been given a special heat treat to insure greater life. These barrels were manufactured by Rudolf Hammerli of Lenzburg, Switzerland, who also made a number of the weapons under contract.

Colonel Sonderegger, then Chief of Staff of the Swiss Army, was impressed by the performance of the simple mechanism of Colonel Furrer's design and ordered its manufacture on a limited scale until fully corrected by firing and endurance tests. By 1928, however, 5,150 weapons of the 1925 model had been made and delivered to the army. The French, being skeptical of Swiss claims that the barrel could fire 25,000 rounds and retain a semblance of accuracy, bought one gun, several barrels and enough ammunition to test it. They reported that the barrels could fire as much as 18,000 rounds "without appreciable loss in accuracy of fire."

The normal rate of automatic fire for the ground gun was 450 rounds a minute maximum. Every gun was furnished with 34 spare magazines holding 30 rounds each. It was necessary to stop and allow the barrel to cool after 400 shots had been fired full automatic. A device working

in conjunction with the safety permitted the operator to fire single shot or full automatic as desired. It was recommended that the gunner fire the weapon in bursts of six or eight shots until the magazine was empty.

The 1925 model was closely followed by a 13-mm version, having a rate of fire of 300 rounds a minute with a muzzle velocity of 2,624 feet a second. This gun weighed 66 pounds and was adaptable to both antitank and aircraft. One of the most novel features in the construction of the Furrer weapon was that the barrel was changed by pulling it, with the entire firing mechanism remaining attached, from the rear of the receiver. A new firing mechanism and barrel assembly were then inserted. This complete change of both operational parts and barrel was quite unique in machine gun design.

Furrer made skillful use of timing his weapon, which was so constructed that the barrel and its extension were held in a retracted position after unlocking. When counter recoil was approaching the end of its stroke, with the barrel and bolt securely locked, the gun fired a few thousandths of a second before the fast moving parts collided with the stationary receiver. This allowed recoil to start before metal-to-metal contact was achieved, giving the weapon a unique buffing action that produced not only smooth performance but added greatly to the longevity of its components.

The locking and unlocking of this mechanism was accomplished through the breaking of a toggle joint by a hinged lever in the rear that was fastened by a pin to the receiver. When the toggle was broken, the locking lugs began to be released and roll about a curved surface until they were completely disengaged. All models had a very strong buffer and driving spring. A flash hider, blast suppressor, and muzzle booster were always incorporated in the construction.

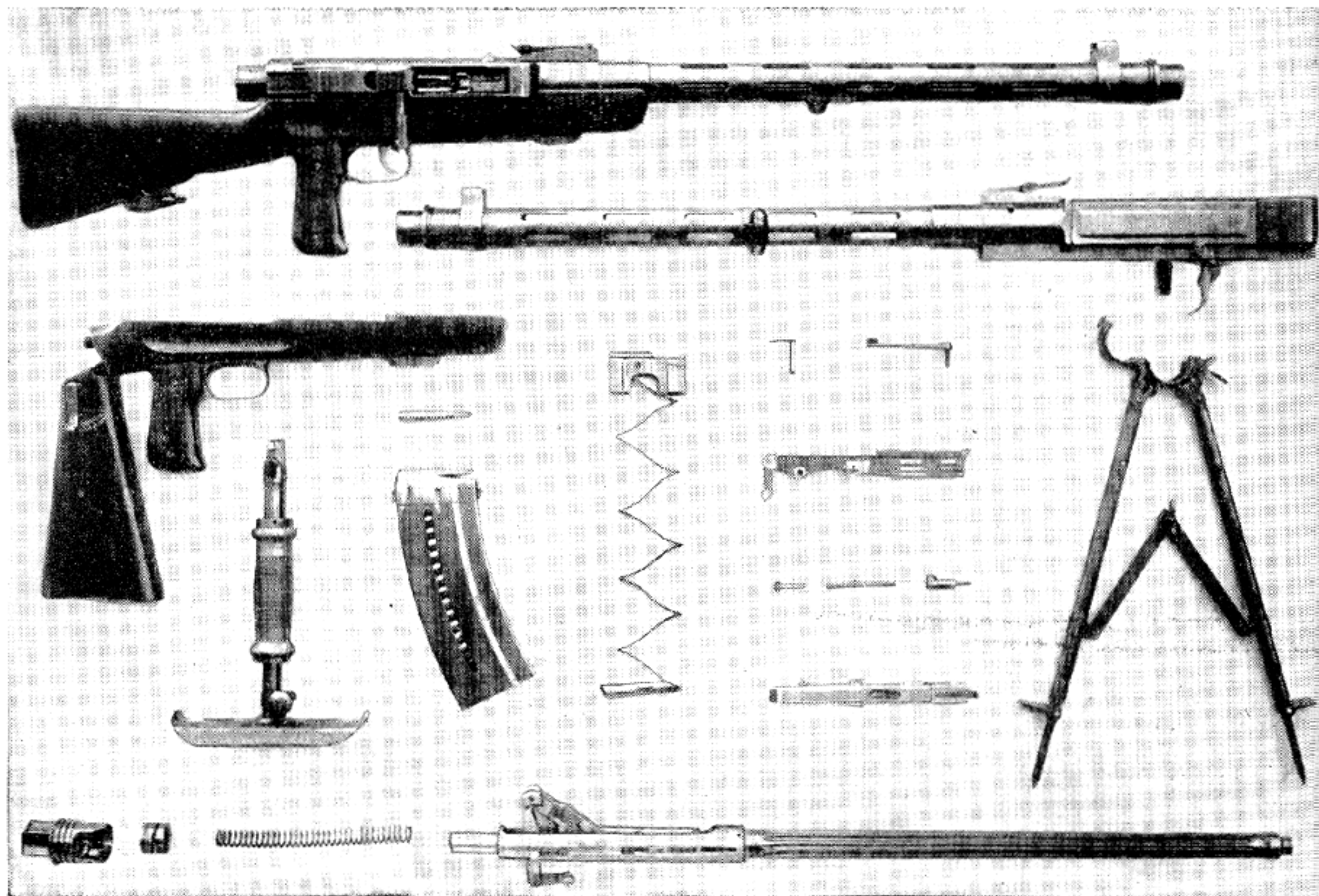

Furrer Machine Gun and Components, Model 1925, 7.5 mm.

For aircraft use the metal non-disintegrating belt was employed. The fixed guns were made to be interchangeable with flexible ones. However, mounting as free guns was always done in pairs with ammunition boxes holding 120 rounds each feeding from above so that ejection would be down into the fuselage or into an empty cartridge-case container.

The Furrer guns were highly characteristic of the Swiss genius for precision-made instruments and equipment. The weapons were made up of a multiplicity of intricate parts that performed unusually well but did not lend themselves to mass production.

The aircraft models had the following interesting details in common: (1) Feeds that were interchangeable from left to right, or vice-versa; (2) mounting of guns for either flexible or fixed use; (3) a rounds counter on the back plate showing the gunner, when firing flexibly, how many rounds were left in the ammunition box; (4) a feed pawl disengagement which halted feeding

in order to leave the bolt in battery on an empty chamber when overheated; (5) a belt that did not disintegrate when a round was withdrawn, being loaded with 120 rounds for flexible guns and 500 for fixed installations; (6) a short muzzle booster and bearing support; (7) longer barrels than those employed on the same mechanisms for ground use; and (8) a single grip on the flexible gun in lieu of the conventional two-grip or spade, type.

The rate of fire of aircraft models using rifle-caliber ammunition was increased to 1,200 rounds a minute by the employment of a special apparatus. This device trapped the still-expanding gas after the bullet left the bore and brought it to bear on the muzzle of the barrel, causing the latter to be thrust suddenly to the rear. The added recoil hastened unlocking which, together with a strong spring-loaded buffer, gave an appreciable increase in cyclic rate. In fixed installations the gun could be mounted in practically any desired position as ammunition was fed in

on one side and ejected from the opposite one.

An example of the ingenuity of the Swiss armament designers is found in the national small arms factory at Berne, where the Furrer guns were produced. The nation realized that a war would make steel in large quantities practically unavailable and an emergency system whereby worn-out infantry rifle barrels could be used as liners for machine gun barrels was developed at the Berne plant in the period prior to World War II.

The following method was used: A worn-out rifle barrel is heated in electric furnaces and drawn out to proper shape. It is then inserted in a deteriorated machine gun barrel which has previously been drilled out to proper diameter. The inserted barrel is then expanded by the auto-frettage method of forcing a series of reamers or wedges through the interior until it has been expanded to the desired dimensions. This cold-working produces a very hard metal and lengthens the life of the lined barrel. The insert is then drilled, reamed and rifled to correct specifications.

Otto Walker, an inventor of firearms and their accessories, residing in Zürich, is sometimes erroneously credited with originating what is known as the Furrer system. However, research does not show any basis for the claim. Colonel Furrer was the creator of the action named for him, despite its close resemblance to the Borchardt, or, as it is more commonly known, the Luger, action.

The cycle of operation on all Furrer-type automatic weapons is as follows: After the belt, or magazine, is put into place, bringing the cartridge in position to be picked up by the bolt face, the action is retracted all the way to the rear. When released, the compressed driving spring gives the firing mechanism a thrust forward. As the bolt face comes abreast of the rear of the feeding system, a loaded round is shoved forward into the chamber. On the last fraction of an inch of forward travel the toggle joint is forced into line and locks, cocking the piece. The weapon is now loaded, ready to fire.

The sear is rotatable in the breech-bolt frame, and upon being actuated, pivots, releasing the

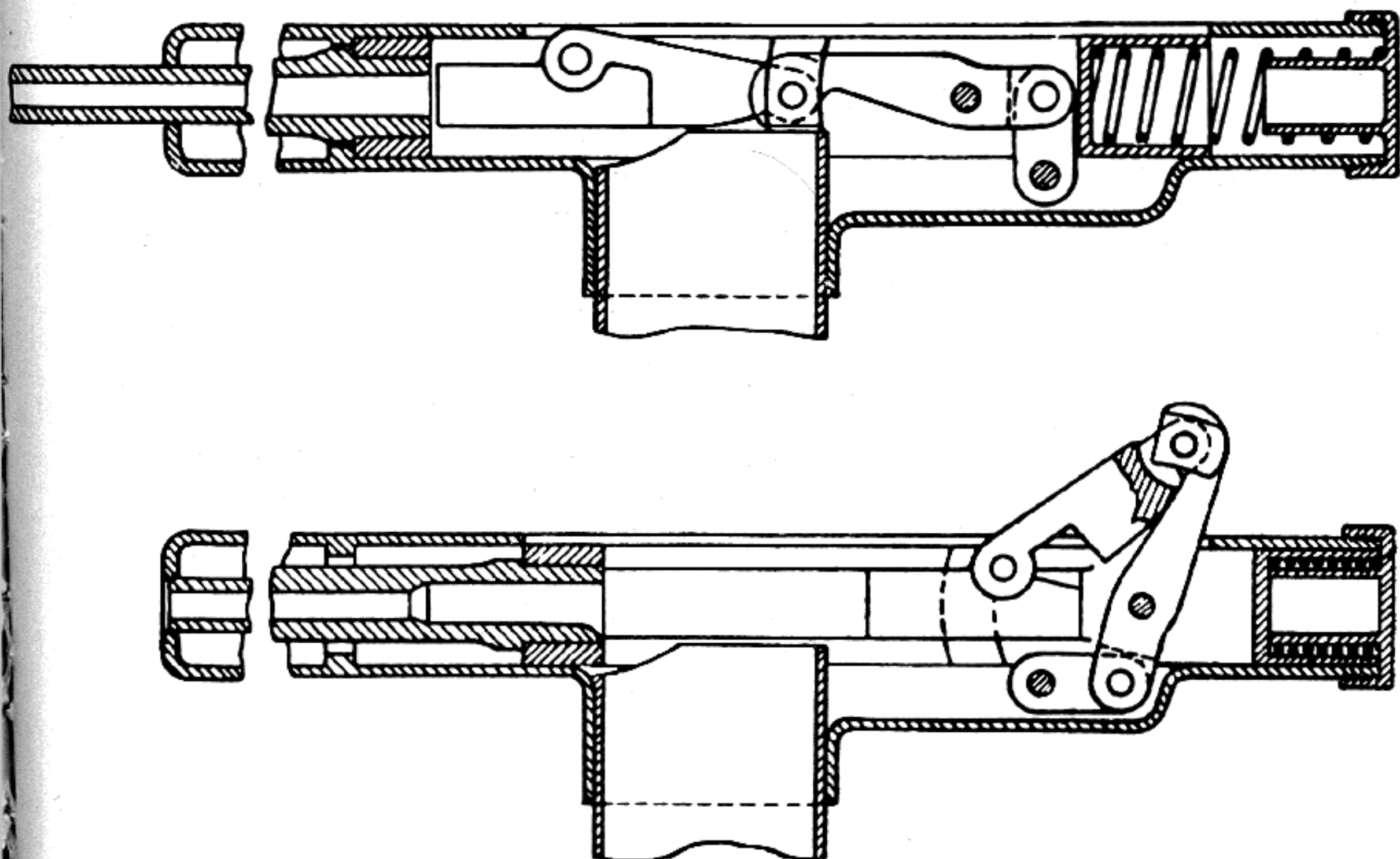

Drawing of Furrer Machine Gun Action.



Furrer Machine Gun, Model 1925, 7.5 mm. Left Side.

firing pin to fly forward under tension of its spring and strike the primer of the cartridge. This in turn fires the charge. For the first fraction of an inch of recoil the barrel is rigidly connected with the barrel extension and bolt. During this time it slides backwards under action of recoil in the guides cut in the stationary receiver. The breech-bolt frame contains the bolt which is also moving rearward. It is connected by a link with the front end of a pivoted member also in the form of a link.

The latter is rotatably mounted in the breech-bolt frame on a pivot. The rear end is connected by means of a pivot pin with one of the supporting links, the other end of which attaches to the barrel extension. The bolt only becomes unlocked from the barrel after the barrel and breech bolt have reached a point where a projection in the stationary receiver breaks the straight-line action of the pivoting links. This allows the bolt to open slowly at first to produce initial extraction and then to complete the function, carrying the fully loosened cartridge case held to its face by the extractor.

The first breaking action of the links withdraws the firing pin slightly within the bolt face. The continued recoil movement not only holds

the firing pin in this position but carries the cartridge to a point where its base collides with an ejector that is built into the receiver. At this point the empty cartridge case is pivoted and ejected through a slot opposite the one through which it was fed. The barrel with its extension being unlocked from the bolt remains in a retracted position. The bolt having completed its full recoil stroke starts counterrecoil movement and the bolt face, when in position, picks up the incoming round out of the feedway ready for chambering.

At this time the projection on the firing pin catches the sear mounted in the barrel extension. In the final act of locking, the bolt compresses the firing-pin spring. When the bolt and barrel are locked, the continued thrust of the driving spring then shoves the retracted barrel assembly into battery. If the trigger remains depressed the sear releases again, firing the chambered cartridge.

The Furrer is so constructed that the firing pin can be released before the locked bolt and barrel strike the receiver, and in this manner the fast-moving counterrecoiling parts are buffered with the start of recoil before making metal-to-metal contact.

## ZB MACHINE GUNS

## ZB Model 1926

The arms producing company, Ceskoslovenska Zbrojovka Akciová Společnost v Brně of Brunn, Czechoslovakia, was first formed in 1922. It began as a stock company, with 75 percent of the shares owned by the government, 20 percent by the Skoda Works and 5 percent by the employees. In its early days it manufactured not only automatic weapons but also military rifles and two-cylinder automobiles.

The first machine gun from the new company was the light Hotchkiss model of 1922, built through the cooperation of French authorities. Relations between the war offices of France and the Czech Republic were extremely close and the manufacture and sale of automatic arms by the new state were encouraged by the French.

In 1924 the firm introduced a prototype weapon of its own design, identifying it by the year of its first appearance. This weapon was less an invention than a devisement, being an application of many sound automatic weapon principles that had been proved by use in other guns such as the Berthier, B. A. R., Hotchkiss,

and Chatellerault. Development continued until it was thought to be perfected to a point where it could meet all demands placed upon it. It became known as the Brno ZB Model 1926, the initials obviously coming from an attempt to reach an intelligent solution to a name foreigners found impossible to pronounce, with Brno being an earlier spelling of Brunn.

Of the many skilled gun designers who contributed to the various models of ZB machine guns, perhaps the most outstanding were the Holek brothers, Vaclav and Emanuel. Both were natives of Czechoslovakia. Other well known designers in the employ of the firm were Anton Marek, an Austrian by birth, and Antonin Podrabsky, a Pole.

Vaclav Holek stood head and shoulders above the rest of these capable men. Starting as an ordinary workman in the Zbrojovka works he showed great interest in machine gun design and produced several working models of his own while still a foreman gunsmith. A demand for a light machine gun by the Czech Army soon after the nation gained her independence gave him the opportunity for which he had been waiting,

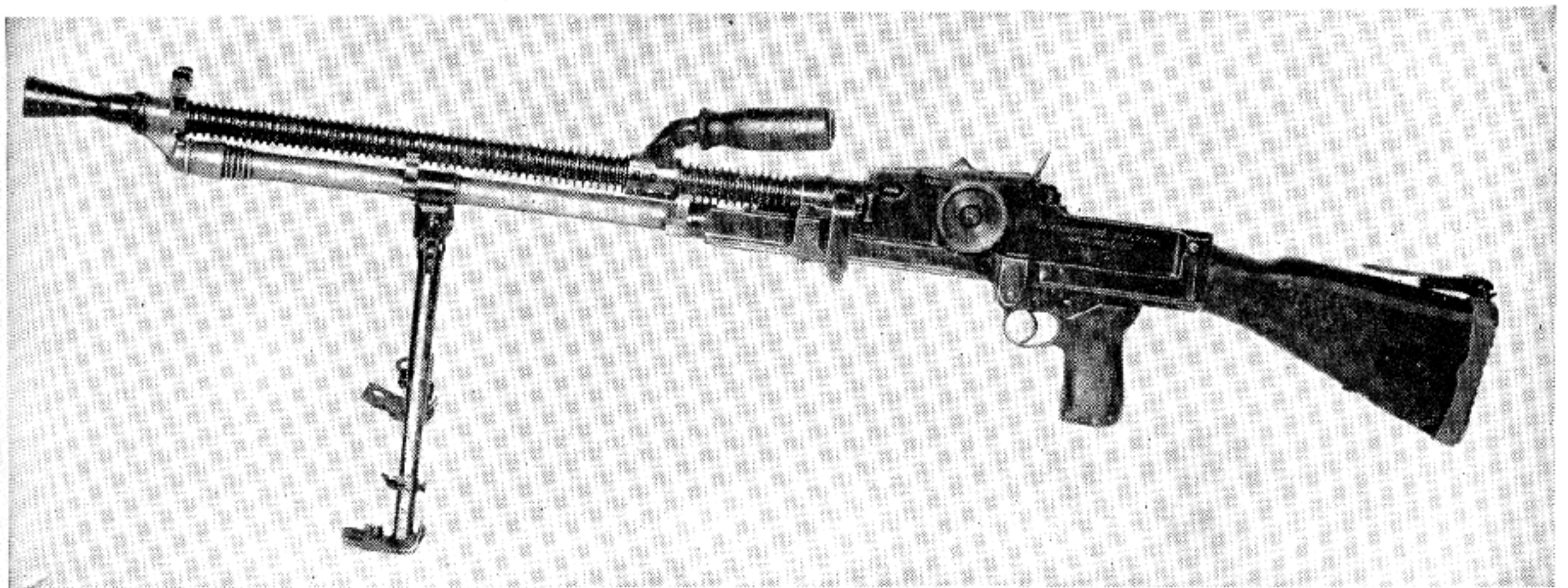

ZB Machine Gun, Model 1925, 7.92 mm.

and he designed the first of the series of ZB light machine guns. Completion of this model took him only three years from conception to finished product.

At the time he was only being paid the equivalent of \$20 a week, but he patented various features in the devisement of the weapon that later not only made him a very wealthy man but saw him quickly promoted to chief of the plant's experimental laboratory. The Czech Army officials put the company's first offering through the most strenuous tests they could conceive. During the trials the rugged mechanism stood up even after being buried in mud or fired until the barrel was red hot and then dropped purposely in a vat of cold water.

The Brno Model 1926 comprised 143 component parts in two categories, fixed and recoiling. To the former belonged the barrel, receiver, trigger mechanism, stock, and magazine. The recoiling parts were the bolt, bolt carrier, gas piston, and driving spring.

The barrel on the model adopted by the Czech Government was chambered for the 7.92-mm infantry rifle cartridge. Its outer surface was

covered with cooling fins. On the breech end there were interrupted threads divided into three sections which permitted solid locking to the receiver by means of a locking nut. On the under side of the barrel was located the port through which the expanding powder gases were directed into the gas cylinder housing the piston. A lug in the receiver was fitted into a slot below the chamber. When locked, it prevented the rotation of the barrel but it forced longitudinal movement forward when loosened. The middle of the barrel had a removable collar to which the carrying handle was attached. If turned to the left, the handle could be grasped by the gunner when firing to stabilize the piece.

The inside of the receiver was milled out square to contain the operating parts. On the forward end was an extension to which the gas cylinder was screwed. The upper part formed the barrel bearing in which the locking nut was bedded in such a manner that it could rotate but could not be displaced. The nut had a tap divided into three sections corresponding to the thread on the barrel and possessed an arm by which, in its vertical position, the barrel coup-

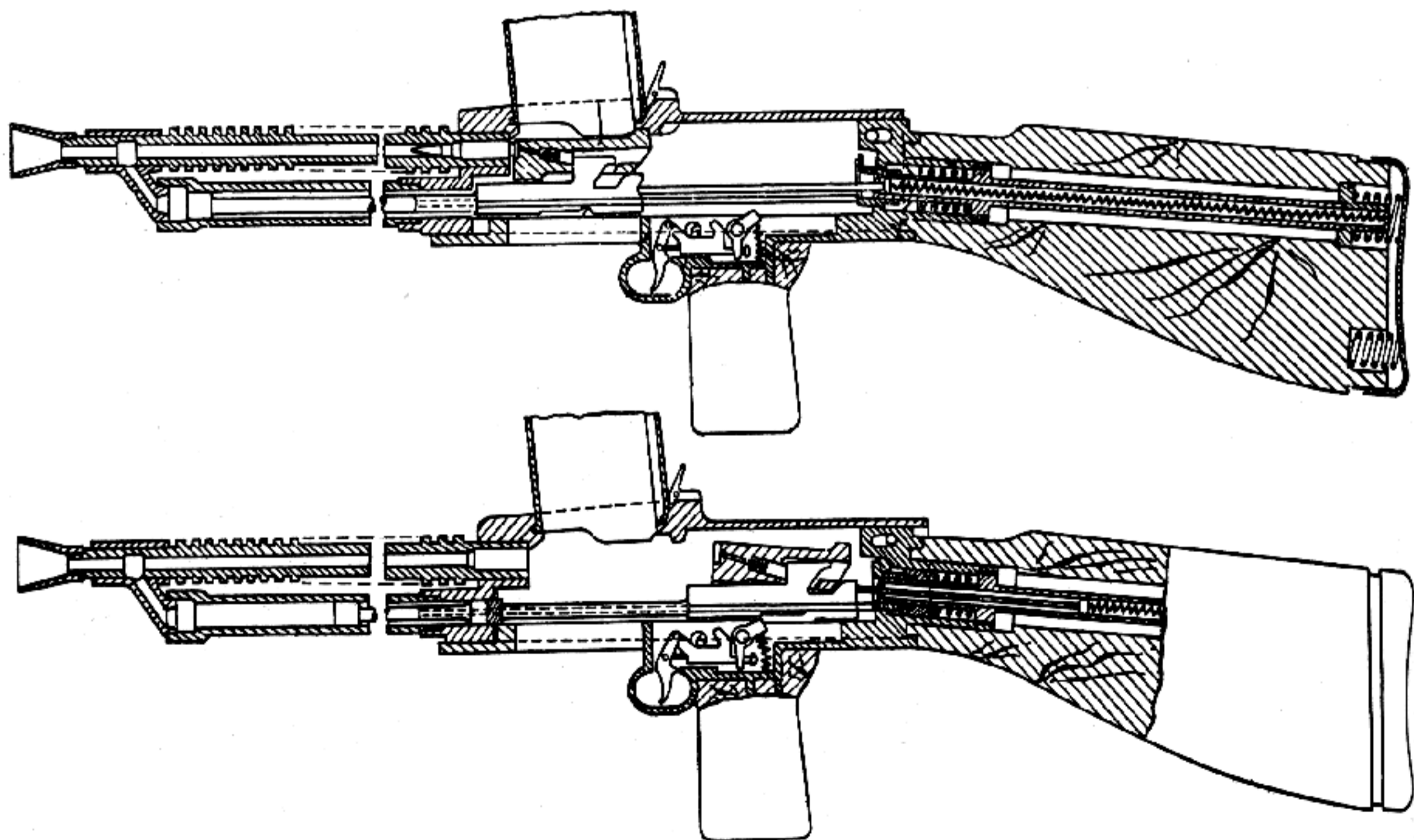

Section Drawing of the ZB Machine Gun.

ling was closed and retained on the receiver by a spring-loaded pawl. When the arm was turned at an angle of 60 degrees, the pawl, acting first on the lever, caused a separation of the barrel and nut, at the same time making the former move forward. It then was easily removable by a pull on the carrying handle.

The extension of the receiver was joined in front to the gas cylinder that extended under, and parallel to, the barrel. This part housed the gas piston, while the top of the receiver had a rectangular opening into which the loaded magazine was inserted by a single operation of the hand. On the rear edge of the opening were a spring-loaded pawl and the fixed ejector. The bottom had an opening through which the empty cartridges were ejected. The opening had a sliding cover which was moved aside at the first firing.

On the right side was the cocking handle. The slideway in the receiver contained a strong spring clip that held the handle in forward position when it was returned after firing the first shot. At the rear and partly below, the stock was joined by two hinged bolts. It contained the driving spring and trigger guard, through which, after the upper hinge was loosened, all the operating parts could be pulled out from the rear of the receiver. This greatly facilitated examination, maintenance, or repair in the field.

The magazine was a simple sheet-metal box into which two rows of 20 cartridges each were staggered. They always were held against the re-

ceiver wall because of pressure from above by the compressed magazine spring.

In the gas cylinder the piston moved on its extension in the bolt carrier housed in its slideway in the receiver. A lug on the bolt carrier, opposite the firing pin in the bolt body, formed the hammer. On the under side of the bolt carrier was a recess into which the sear of the trigger mechanism was engaged. The bolt carrier was the driving part of the bolt and transmitted to this part forced movements back and forth. Locking was caused by two beveled lugs on the bolt carrier engaging two other lugs on the bolt. The lifting into the locking recess was accomplished by the carrier camming these parts up with its locking lugs, the bolt rising on a bearing against the fixed receiver during the instant of discharge and remaining until the bullet was out of the bore.

A device that permitted the firing of single shots if desired was called the interrupter. When the safety was turned for single-shot firing, the interrupter was pressed down during firing by the recoiling bolt carrier. Thereby the sear was liberated from its locked position and engaged the notches in the bolt carrier after the firing of each individual shot, necessitating the pulling of the trigger each time to fire a shot. If the safety were put on automatic firing and the trigger kept to the rear, the sear remained in a down position and would not catch the shuttling bolt and bolt carrier.

The striking of the firing pin by the bolt carrier was accomplished by a system known as

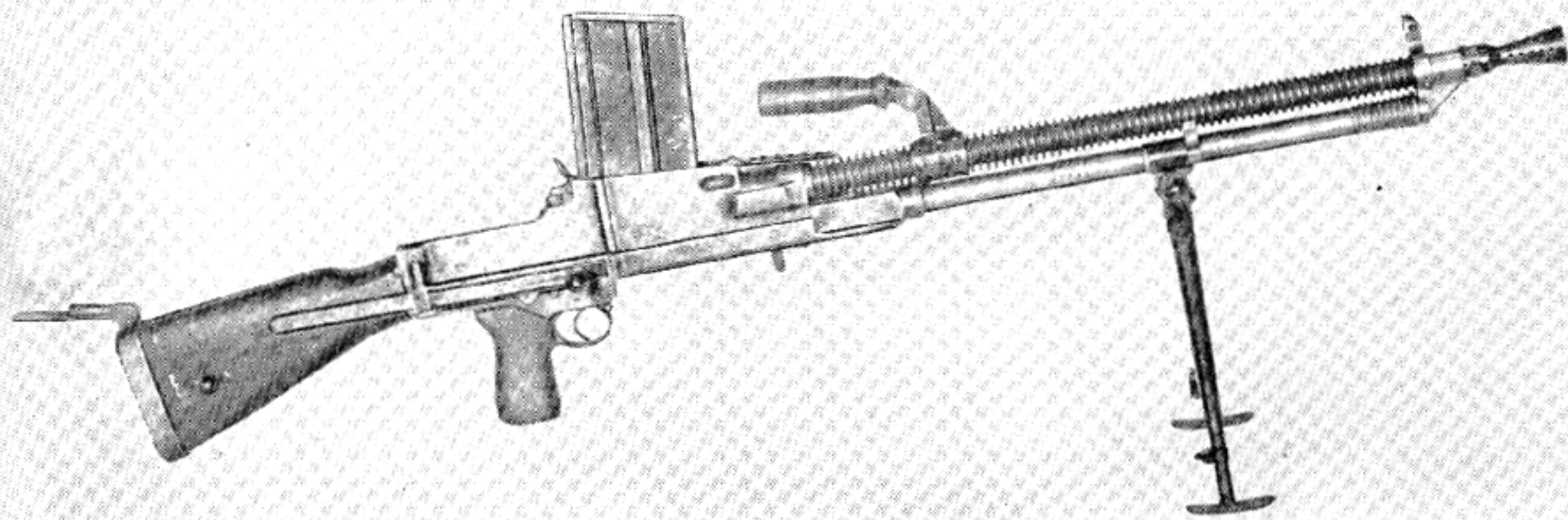

ZB Machine Gun, Model 1926, 7.92 mm.

inertia firing. When the last cartridge had been fired out of the magazine, the bolt and its carrier were held in a cocked position by the feeder plate protruding from the magazine mouth. At the insertion of a loaded magazine, the bolt and carrier moved forward a few thousandths of an inch to be blocked again by the sear. This allowed the bolt to be held ready to fire at the moment the magazine was placed in position.

This light Brno ZB Model 1926 possessed the technical qualifications necessary to satisfy all tactical conditions under which it would be used. The factory was well equipped with the most up-to-date machine tools. Operations were organized on modern principles of mass production so that all machine gun parts made in the factory were interchangeable. The steel used was provided by the world-famous Skoda plant.

The normal effective range of the gun was said to be 1,000 to 1,200 yards. Location of the magazine on top meant that the sights had to be offset to the left. The maximum cyclic rate was 450 to 500 rounds a minute. Each gun came equipped with two barrels and to change them was but a matter of a few seconds. The red-hot barrel could be plunged into cold water without any ill effects. If fire was maintained at a rapid rate, it was recommended that the barrel be changed after every third magazine had been emptied.

### The Bren Gun

In 1932 the British Army, in its quest for a light machine gun to replace the Lewis, became very much interested in its military attachés' reports on the simply constructed reliable machine gun known on the Continent as the ZB Model 1926. A series of trials were immediately begun in which by way of competition some fine and efficient weapons were entered. Among them were the well-known Madsen and Vickers-Berthier. The latter seemed certain to be adopted, but after an exhaustive test the British decided on the ZB weapon. Certain changes were demanded in order to meet British ammunition characteristics. The specifications were drawn and submitted to the parent company. The result bore the temporary designation of Model ZBG.

Two principal changes from the earlier models were made. The removable barrel was chambered for the caliber .303 infantry rifle. It was shortened and the gas port was brought nearer the breech end to compensate for the shorter barrel. The stock was also modified and a recuperator spring added in the recoil mechanism to permit a slight barrel movement rearward. These modifications gave a higher rate of fire and a considerably smoother action. The stock did not hinge, due to a redesign of the recoil mechanism.

In February 1934 the *London Telegraph* carried an article by Capt. B. H. Liddell Hart, from which the following is quoted:

"A start is to be made this year in equipping the British army at home with a new light machine gun. The cavalry are to be the recipients of the much needed replacement of the obsolescent wartime weapons still in use. The new weapon is known as the ZB, a new light machine gun of Czech origin, which has come to the front as a 'dark horse' in recent tests. . . ."

Having obtained a license to manufacture it, the Enfield government arms plant was ordered to begin manufacture of the weapon and in January 1935 the completed drawings from the ZB firm were received. In September 1937 the first gun was assembled and given the name Bren, the first two letters being taken from Brunn, location of the original producer in Czechoslovakia, and the last two from Enfield, the British arsenal. By December 1937, 30 Bren guns had been completed, with 12 already under test. By January 1938 an even 200 guns had been assembled. By July of the same year production had been stepped up to 300 a week and remained at that figure until September 1939, when it was found that the guns were coming off the assembly line at a rate of 400 a week.

The Royal Small Arms factory continued to be the sole producer of the weapon, with B. S. A. and Austin having contracts for the production of spare magazines. The feed systems made by the latter two companies gave considerable trouble because the Czechs designed the magazines to hold rimless cartridges, while the British continued to use outmoded rimmed ammunition for their automatic weapons. The mistake was remedied but not before thousands of magazines





Bren Machine Gun, Mk I, Cal. .303.

had been manufactured. It was found that they would function correctly if loaded with only 29, instead of the customary 30, cartridges. The magazines were marked plainly to this effect. Issued after the outbreak of World War II, the weapon was manufactured in tremendous quantities not only in England but in Canada as well.

#### Japanese Models of the ZB

In the year 1936 a ZB-type gun made its appearance in the Japanese Army and was designated Model '96, 6.5-mm. Research shows that

the weapon actually was produced in a Chinese arsenal which, when captured by the Japs, continued operation and placed many such arms into the hands of the Japanese infantry. The gun was later adopted and produced in Japan, becoming a part of the country's haphazard automatic armament. It appeared as Model '97 (1937) for use in tanks, and as Model '99 (1939), with a lighter construction for infantry and paratrooper use. Both were chambered for the 7.7-mm cartridge.

Some of the tank models were designed to mount a long telescopic sight on top of the re-

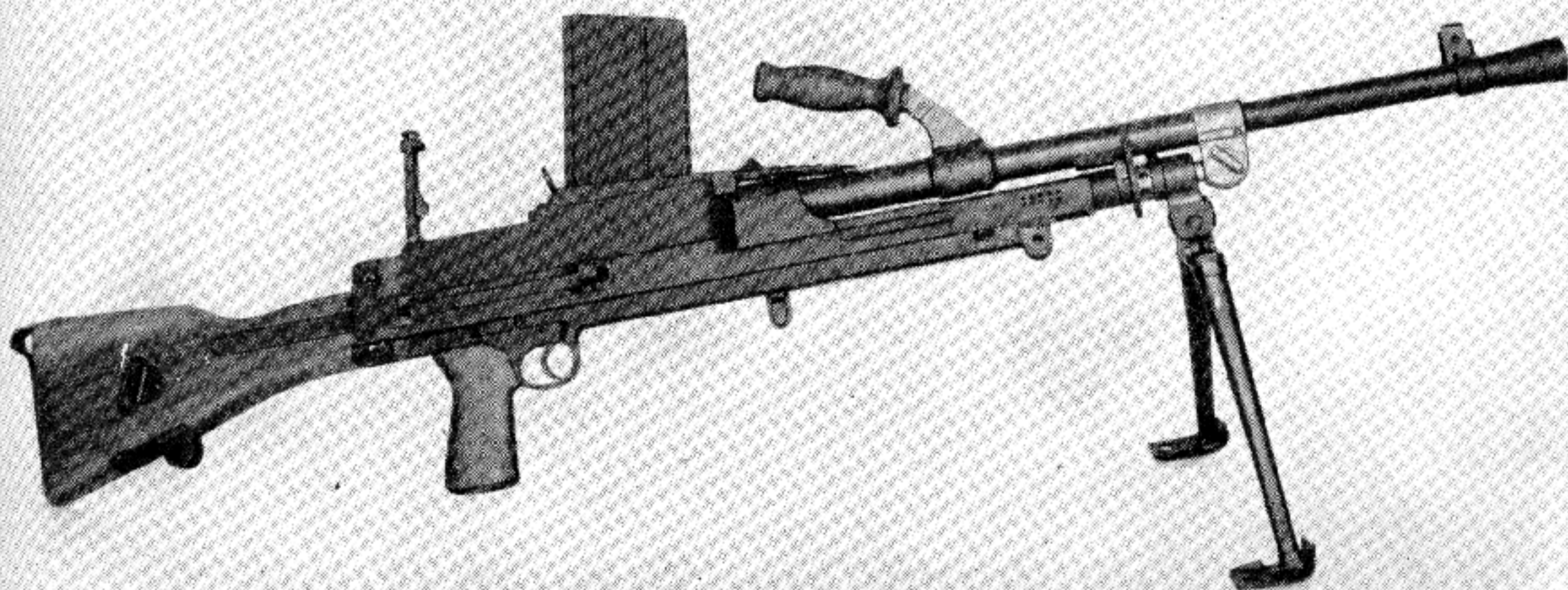

Bren Machine Gun, 7.92 mm. A Czech Weapon Adopted by the British and Manufactured for the Chinese in Canada.

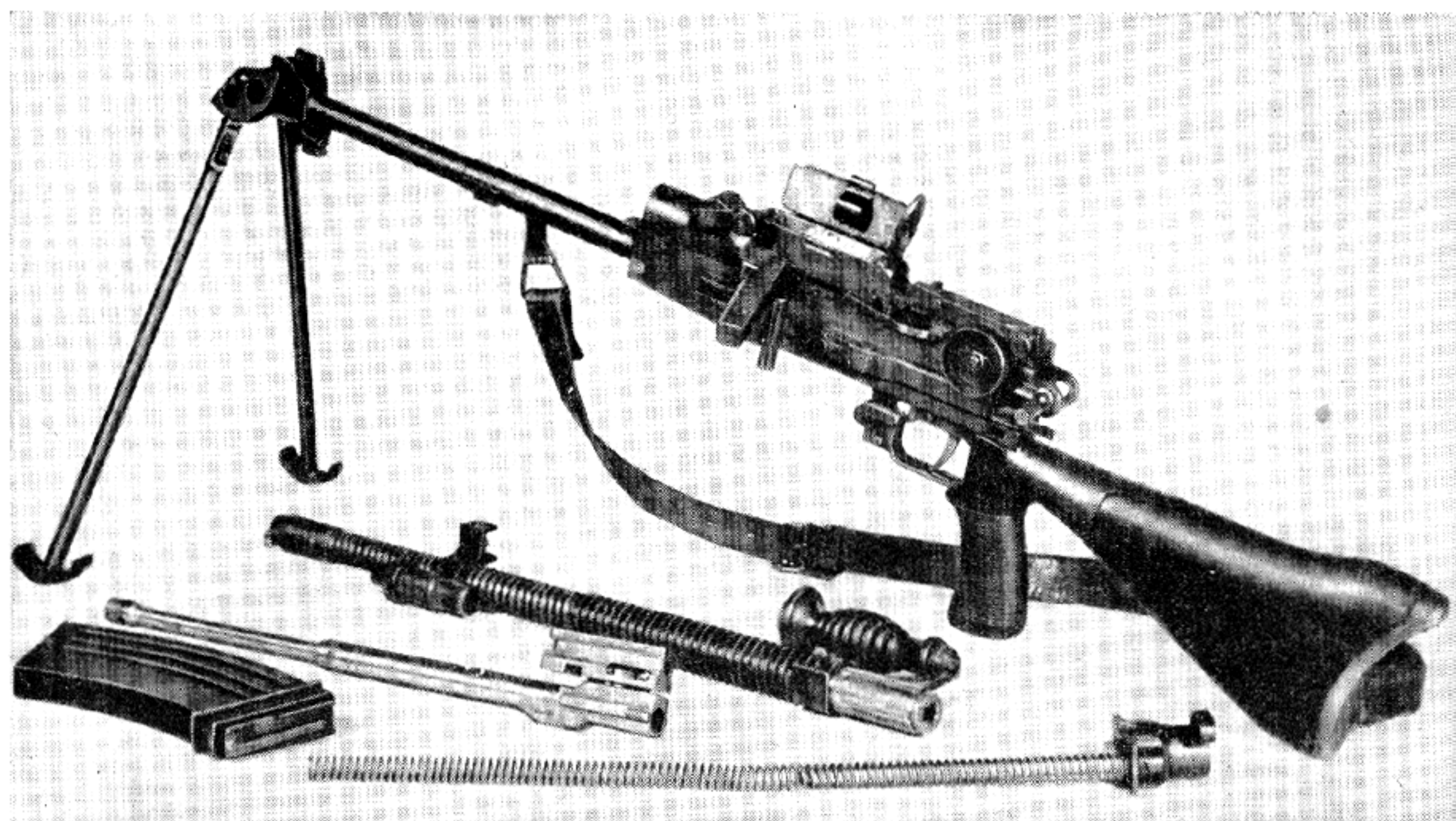

ZB Machine Gun, Model 96, 6.5 mm. A Japanese Copy of the Czech Weapon.

ceiver. A manual captured with one of the guns shows that the weapons were identical with ZB machine guns used practically all over the world. A translated portion of the manual is given below:

"The Japanese Model 97, 7.7 tank machine gun is a gas-operated air-cooled Brno-type machine gun designed to be mounted in tanks. It is equipped with conventional sights and also has a telescopic tank-type sight mounted on the left side of the receiver. The use of conventional sights and a bipod carried separately in the tank allows the gun to be used on the ground as well as in the tank. The weapon has a removable box magazine holding 30 rounds and uses only the Model 99 rimless 7.7 ammunition."

Unlike the original ZB machine guns there was no carrying handle on this particular model and the cooling fins ended  $5\frac{1}{2}$  inches from the muzzle end of the barrel. The operating parts were as identical as it was possible for the Chinese and Japs to copy.

### ZB-50 Machine Gun

The ZB Co., after a number of years' experience with its light gas-operated machine gun that

enjoyed a world-wide reputation for reliability and clean cut design, turned its attention in 1932 to the promotion of a machine gun that operated by recoil forces. In the creation of this new weapon the company advertised that it "made efficient use of all the knowledge and methods which modern technical science puts at the disposal of the successful designer. Painsstaking study and research were undertaken to determine kinetic and dynamic conditions in the mechanism of the machine gun. Cinematopographic research was made use of, and radiation of heat from the barrel was the subject of thorough investigation based on the latest data of the science of thermology."

This weapon was given the official designation of ZB-50 and the main change was that the breech mechanism was operated by utilizing the recoil, and the bolt was cushioned by a strong spring so that this heretofore undesirable feature did not influence the accuracy of the weapon when in the act of firing.

The bolt assembly was very similar in appearance to the earlier gas-operated models, but in lieu of a gas piston actuating the recoiling parts an accelerator was added that transferred energy

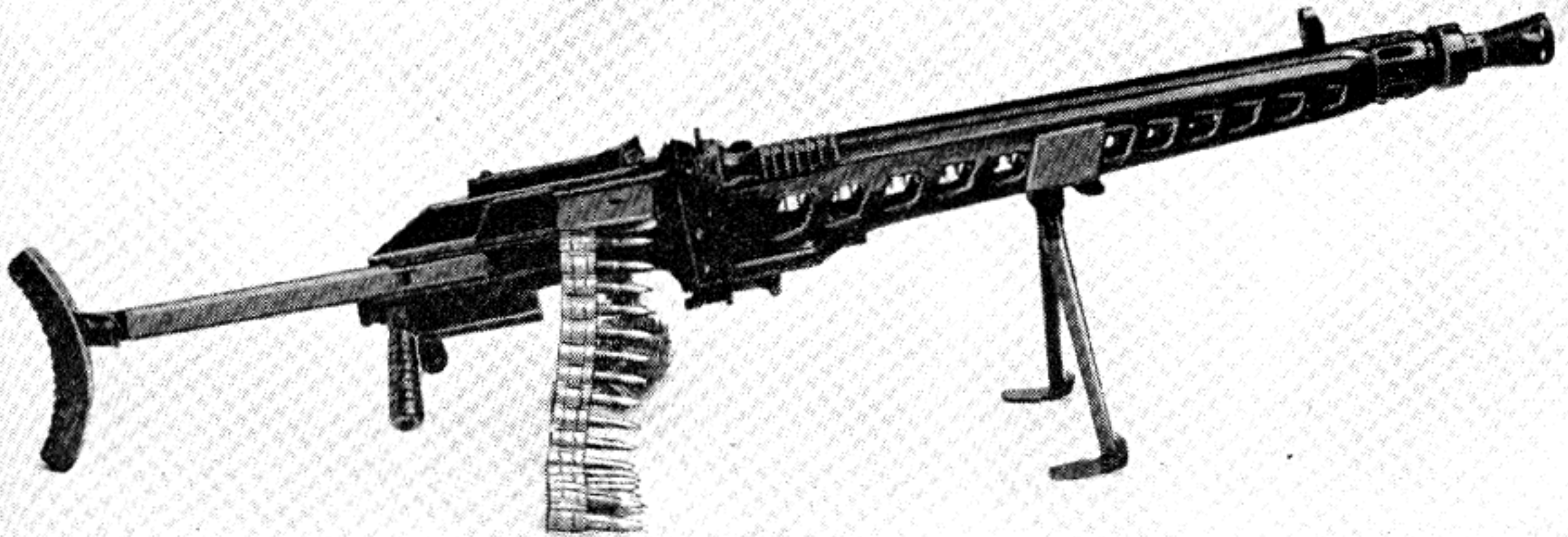

ZB Machine Gun, Model 50-1932, 7.92 mm. The Only Weapon Designed by ZB Based on the Short Recoil Principle.

during the movement of recoil and at the instant of unlocking exerted its full force on the bolt, speeding it rearward. These features were invented and patented by Anton Marek, one of the noted gun designers in the employ of the ZB plant. The accelerator was in appearance very similar to the well-known Browning type.

This model unlike its magazine-fed predecessors employed metal push-out type links to form a non-disintegrating belt for the purpose of placing cartridges in the feedway. After the discharge of the last round the belt fell out the left side and the bolt and its components were held by a stop in the cocked position. When a loaded belt was inserted, the stops were raised and the bolt moved forward a few thousandths of an inch to be caught by the rear sear. This necessitated a pull of the trigger to release.

The only thing needed for complete disassembly in the field was a loaded cartridge, with the bullet point being used to depress certain spring-loaded detents.

The trigger housing was so designed that it slid on the bottom of the breech casing when released from its spring-loaded detents to cock the mechanism manually. The housing had two small grips on each side that acted as the charging piece. The advantage of this arrangement was that the two grips could be used to cock the piece when it became necessary to load the weapon by hand.

A muzzle booster that trapped the powder gas

after the bullet left the barrel was used to increase rate of fire by bringing this pressure to bear on the face of the barrel. This device working in conjunction with the mechanical accelerator gave a cyclic rate of 600 shots a minute. The muzzle booster was also designed so as to act as a flash hider and front barrel bearing.

The safety catch was of unusual design on this weapon, being so constructed that, when it was on, it held not only the sear locked but also threw the point of the incoming round down at an angle so that if by any chance whatsoever the sear did become disengaged and the bolt go forward the cartridge was in such a position that it would not chamber.

Perfect coordination between the counterrecoiling barrel and the moving belt was assured by a specially constructed piece that permitted the return movement of the bolt only after the barrel had gotten into battery.

To fire the ZB-50, the gunner, generally prone, raises a cover in front of the feedway and inserts a loaded cartridge belt from the right side until the first cartridge is under the spring-loaded holding pawl. Then the firing grips are released from their detent and shoved forward until the sear engages the bolt. It is then pulled all the way to the rear. At this point the rear sear engages its recess in back of the bolt, holding the firing mechanism in the retracted position. Rearward motion also compresses the driving spring

and moves the belt over one space in the feedway, thus positioning the first round. When the trigger button is pushed, the sear disengages the bolt which flies forward under the influence of the driving spring energy.

The bolt face, arriving at the rear of the feed, begins the first phase of chambering the round by pushing it out of the link into the guideway that positions the nose of the bullet into the entrance of the chamber. The bolt is made in two pieces. The portion containing the bolt and its rear locking face arrives in battery first with the rear end directly under a locking recess milled into the barrel extension. The second part, which is connected to an extension spring and is held to the rear of the first part by means of the locking lug, is now free to move forward. The angle on the locking lug cams the back end of the bolt up into the locked position. The last forward motion of the bolt assembly's second portion brings the face of the locking lug to bear suddenly on the firing pin housed in the bolt and the weapon is fired.

In the first half inch of recoil, the bolt assembly and barrel are locked to the barrel extension. At the same time they build up tension in the extension-type mainspring. This spring is connected to the accelerator which, upon being activated by the spring, pivots and shoves to the rear the part of the bolt carrying the lug. This unlocks the weapon and also accelerates the already recoiling parts to the rear. The empty case is withdrawn from the chamber and ejected through the bottom of the receiver. When the bolt assembly reaches its rearmost position, coun-

ter recoil will begin, repeating the cycle of operation as long as the trigger button is depressed.

### Besa—ZB-53 Machine Guns

The British modifications on the 1926-30 models that became known as the Bren led the ZB firm to bring out an identical gun in every respect except for the caliber. This was changed from the British .303 to the Czech rifle cartridge, 7.92 millimeter. The greatly improved design was called the ZB Model 1934 and the highly efficient weapon was bought or copied by countries all over the world.

In 1937 V. Holek, the official in charge of the firm's experimental weapon design, introduced and patented a gas-operated firing mechanism that was given the official designation ZB-53 Model 1937. While it had many physical changes, the operating parts remained basically the same as all the other gas-piston-actuated ZB's.

The British were much impressed with this weapon and adopted it at once for equipping their armored vehicles. They proceeded to acquire manufacturing rights, and in a short time it was being produced in England in the Enfield Royal Arms Manufacturing Arsenal and the Birmingham Small Arms plant. This gun produced in England was known as the Besa. ("B" for Brno, "E" for Enfield, and "SA" representing the last two initials of the Birmingham firm.)

British cartridges not being suitable for the action, the barrels were chambered for the 7.92-mm Czech cartridge instead of their own caliber .303

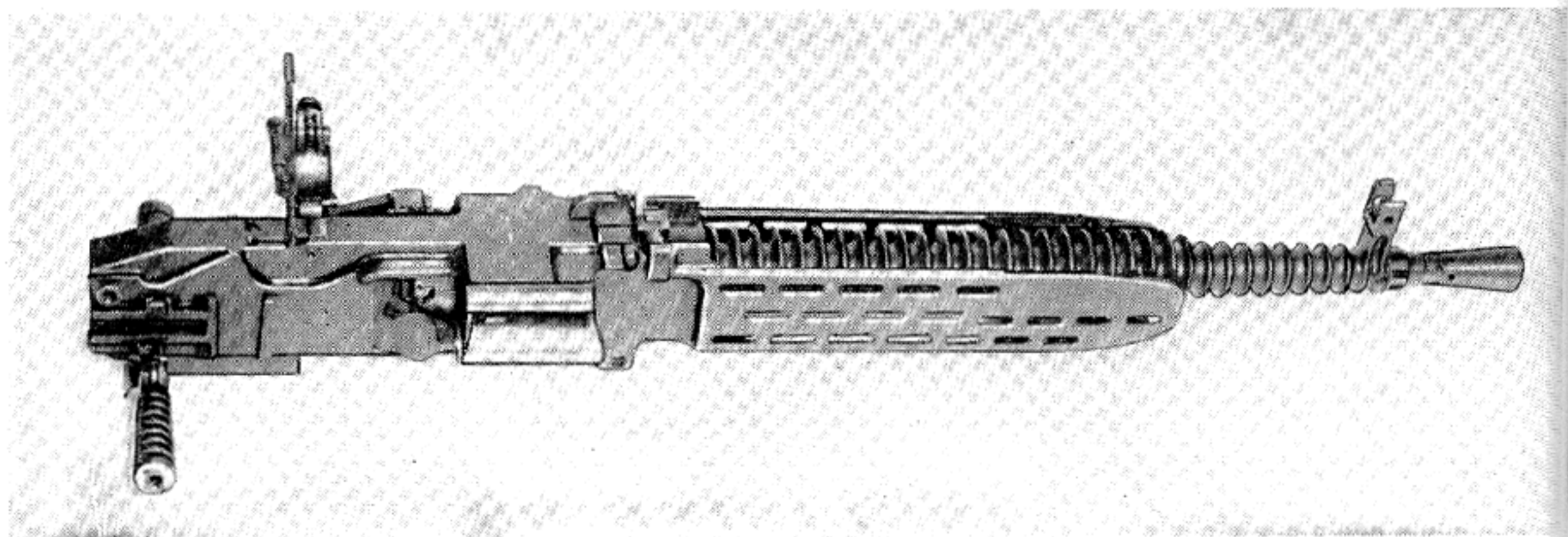

ZB Machine Gun Model 53-1937, 7.92 mm.

Later the same mechanism was scaled up by the ZB Co. to take a 15-mm high-velocity cartridge for anti-tank use. This large bore machine gun was likewise adopted and manufactured by the British. The smaller caliber guns were designated Besa 7.92-mm Mk I and II; the larger weapon was known as the Besa 15-mm Mk I.

The physical appearance of the guns themselves was rather conventional, but a few features most certainly were not. The charging handle for cocking the weapon was the pistol-grip-shaped trigger guard that was shoved forward until a sear engaged the piston extension. The guard was pulled back, carrying the operating parts to the rear sear, after which it was returned to its normal position. Needless to say, the fingers must not be placed inside the guard as pulling back into place would fire the weapon after return of the guard to its former position.

Before the barrel could be removed, the gun must always be cocked. Two different sized orifices were drilled into a circular piece that could be rotated. This was inserted between the port in the barrel and the gas piston cylinder. By turning this part, the gunner could obtain an adequate amount of gas for successful operation.

The Besa-ZB-53 guns were equipped with considerably heavier barrels than most air-cooled machine guns. Bursts of greater duration were thus made possible. They also differed from the earlier ZB-model guns from which they originated in that they had no shoulder stocks and that the rear of the receiver housed a heavy spring-loaded buffer system that could be set to deliver a slow or fast rate of fire. This device could be moved up out of the way. Then the bolt

could not only travel farther on the recoil stroke but had the energy of the compressed driving spring alone to return it. This noticeably slowed the action and, when used with the small orifice, produced a rate of fire of 450 to 500 rounds a minute. If a higher rate was desired the operator snapped the L-shaped heavy buffer in the down position. The stroke was then shortened and the fast recoiling bolt was deflected back to battery at a higher speed. The use of this buffer, often erroneously called the accelerator, gave a rate of fire of 800 to 850 shots a minute.

The principal difference between the rifle-caliber weapon and the 15-mm Besa were the features in the latter that were patented by V. Holek, namely the method for holding the barrel to the rear by a spring-loaded detent. The bolt had to chamber the cartridge slightly out of battery and the firing take place before the fast moving components made metal-to-metal contact on counter-recoil. This allowed the recoil forces to begin just before the stopping of the bolt, barrel, and extension by the receiver. This not only gave longer life to the operating parts but resulted in smoother functioning.

The method used in retracting the barrel was unique in that the cover had to be raised. This actuated a linkage that jacked the barrel back until the detent located on the bottom side slid into its recess. Cocking was done also by the unusual method of releasing the pistol-grip-shaped trigger guard. It was shoved forward until it latched on to the rear end of the gas piston and was then pulled to the rear until the sear engaged it to hold in until released by the trigger. A continued movement rearward naturally

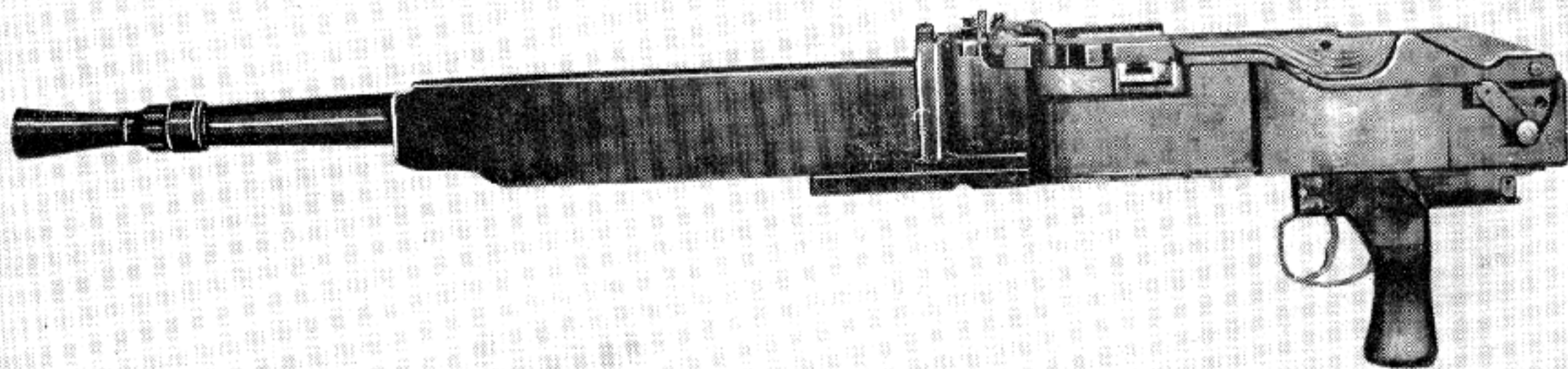

Besa Machine Gun, Mk II, 7.92 mm.

brings the trigger guard back to its normal position.

The so-called accelerator was not incorporated in the design of the larger caliber weapon. The device was in reality a strong spring buffer that could be dropped into position to shorten the recoil stroke and speed up by bolt deflection the rate of fire. The barrel was machined in such a manner as to have three points of contact with the inside of the barrel jacket. This gave sufficient support but did not create undue friction on recoil.

By turning the selector switch to its extreme left position, single shot firing could be accomplished. The feed system used the metal push-out type of link and was fed from right to left. The belt was drawn over one space by a lug on the gas piston which engaged the feed pawl and by a long movement gradually but forcefully pulled the belt over during each movement of recoil.

While the barrel could be readily removed, it was still a two-man job, for one had to hold it while the other raised the carrying handle of the barrel retainer a half inch and pushed the partly freed barrel forward until it could be turned up.

At a distance of 13 inches from the breech end, a special slot was machined for this purpose. The second man then raised the aft end until it cleared the barrel extension. They jointly eased it forward to lift out. The projection guides on the barrel were freed from their slideways in the receiver by the last of the forward motion.

A flash hider was always used on this heavy duty gun as the terrific powder charge in the 15-mm cartridge had enough muzzle flash to impair seriously the aim of the operator unless suppressed by some device.

The cartridges were fed to the gun through a feed mechanism actuated by the piston extension. The latter piece was provided on its lower face with a cam way in which the under arm of the feed lever operated. The upper arm actuated the feed pawl and moved the belt over one space, positioning the cartridge to be chambered. The feed system was not dependent on the action of the breechblock but obtained its operational power from the piston extension. This method insured positive feed as the power stroke was used in place of energy derived from a compressed driving spring.

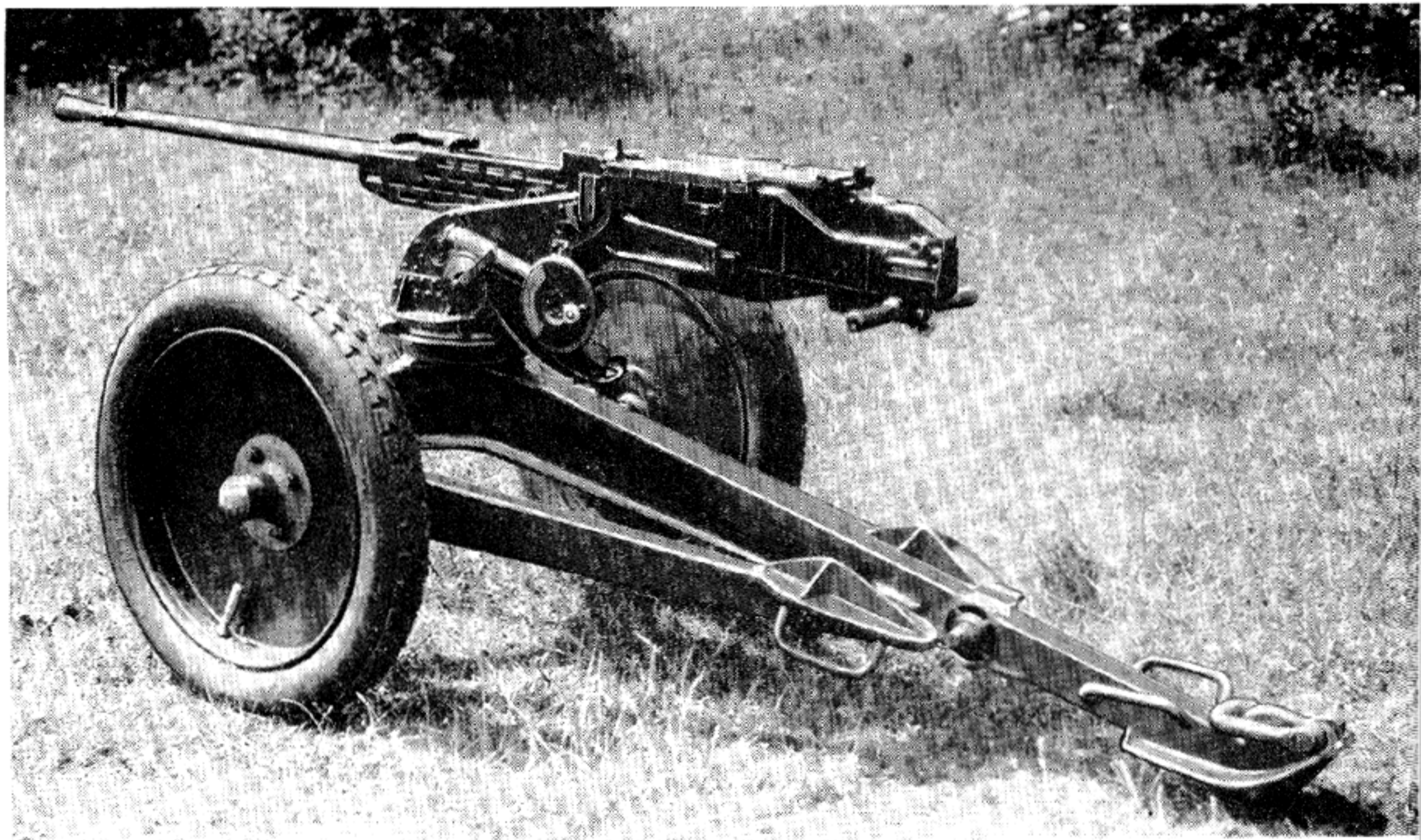

ZB Machine Gun, Model 60-1938, 15 mm.

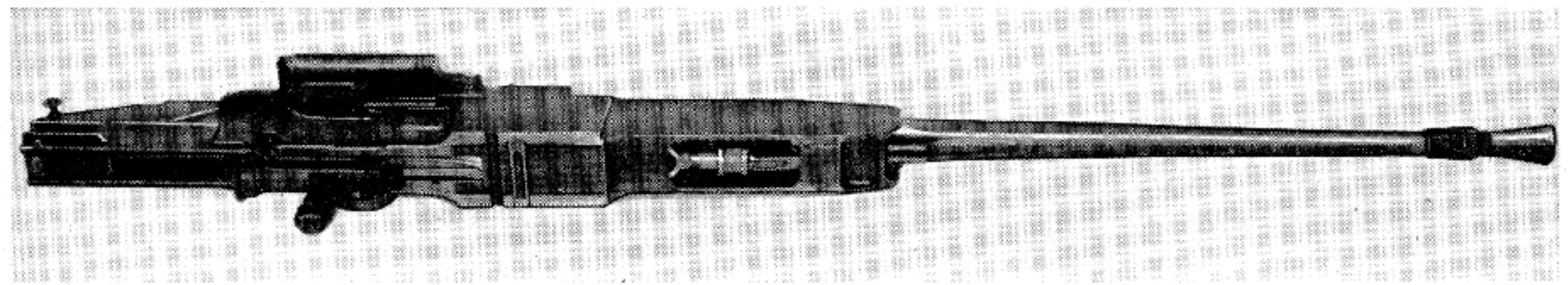

Besa Machine Gun, Mk I, 15 mm, as Viewed from Below.

This weapon was so close in principles of operation as to be nearly identical with the early gas-operated ZB guns but the few new features added from time to time were in themselves radical enough to warrant the presentation of a cycle of operations for comparative purposes.

To fire the 15-mm Besa Mk I or the ZB-60 Model 1938, as the Czech company version was marked, the operator shoves the tab of the metal cartridge belt through the feedway from the right side, which is then pulled to the left until the first cartridge snaps behind the belt-holding pawl.

The detent holding the feed cover group is held down allowing the cover to be raised to the up position and then brought back to position. This movement jacks the barrel back where it is held in the retracted position by a strong spring-loaded catch. The pistol-grip trigger guard is released, allowing it to be slid forward in its slideway until a plunger in its housing is forced into a recess in the piston extension. The trigger-guard housing is then pulled smartly to the rear bringing with it the bolt and the extension.

At the completion of the rearward movement the rear sear engages the notch in the piston extension, holding the entire assembly in the cocked bolt position. The pistol grip that has served as the charging handle is now in place and, if the selector switch is on single shot or full automatic, the weapon is loaded and ready to fire.

The rearward movement of the piston extension also cammed the feed pawl over, thus posi-

tioning a round to be stripped from the link. The release of the sear by pulling the trigger starts the firing mechanism toward battery and a projection on top of the forward part of the bolt passes through the center of the link, shoving the cartridge ahead of it into the chamber. The bolt arrives first into battery with the rear end directly under its locking recess in the bolt extension. The gas-piston extension, being held to the rear by a beveled locking lug, can now continue forward since the lug cams the rear end of the bolt up into the recess and out of its path. The last fraction of an inch of travel of the piston extension releases the barrel holding catch and the entire assembly—bolt, barrel, piston, and extension—start final movement to battery. The faster moving locking lug on the piston extension, however, strikes the firing pin, discharging the weapon and starting recoil movement slightly before all the moving parts strike the stationary receiver.

The main recoiling parts are locked together until the terrifically high gas pressure has dropped to a safe operating limit. At a point in the barrel one-third of the way up from the breech, gas is let through a port into the chamber, where it strikes the face of the piston driving it rearward. The bolt is unlocked as the back of the lug on the piston extension pulls it down out of its recess. At the same time the retracted barrel is held back by its latch. A strong extractor withdraws the empty cartridge from the chamber and holds it until it strikes the ejector positioned in

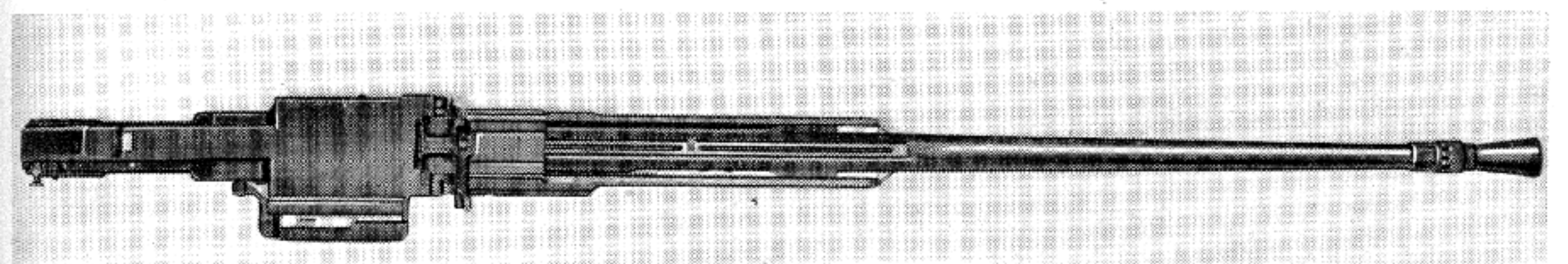

Besa Machine Gun, Mk I, 15 mm, Top View.

the belt guide. It is then knocked downward through the slot in the piston extension and receiver.

Continued rearward movement completely compresses the driving spring and final travel of the recoiling parts is dampened by the heavy spring buffer. The barrel recoil spring positioned in the cover group reduces the upward jump of the barrel's muzzle and in doing so increases accuracy.

This weapon was intended for aircraft use as well as anti-tank work. For the former purpose an explosive 15-mm bullet was developed. Its high muzzle velocity of 3,200 feet a second was used as an argument in favor of its use in place of the larger bore automatic weapons then being placed in fighting planes. For ground work 40 rounds was the normal length of an ammunition belt, but the company was quick to point out that in aircraft installations the length would be governed only by the capacity of the plane.

The very modern and highly efficient ZB automatic arms plant was taken over by the Germans early in World War II and operated throughout the war under the name of Waffenwerke Brunn A. G. The conquerers not only used the excellent ZB weapons already in existence but kept production going in full force. Characteristically they called for many modifications on the weapons, some in the nature of improvement and others merely for adaptation to special purposes.

The most outstanding illustration of the firm's craftsmanship, showing its genius for weapon design to the utmost, was an experimental model of a new type of machine gun that was in prototype stage at the time of the German invasion. Fortunately for the Allies, the model, pictures, and drawings found their way to the United States just before the plant fell into enemy hands. Security reasons do not permit any further mention of this weapon.



## VICKERS-BERTHIER MACHINE GUN

In 1925, the Vickers Co. in England, having acquired the manufacturing rights to all Berthier machine guns, started production on a limited scale. This was done more to keep the personnel of its large Crayford plant employed than to fill the needs of the British services for a machine gun, since at this time the gun-making industry, as far as military types of automatic weapons were concerned, was at a low ebb.

The first such guns produced were in the form of light machine rifles. They were put on the market commercially, engaging in competitive tests in many of the Balkan States and in the Dutch East Indies. The Latvian military authorities adopted the light machine rifle chambered for their infantry rifle cartridge. In the Dutch East Indies test, the Vickers-made Berthier bested

the field but no contract was received because the Dutch Government thought it more economical to manufacture a modified royalty-free Lewis gun in its own government arsenal. Spain bought a number of the weapons for use in Morocco and many South American republics purchased them in limited quantities. They were also adopted officially by the Indian Army. Actually the sum total of sales was only enough to keep this part of the Vickers Co. operating at a bare profit.

It was more from financial necessity than military need that Vickers in these days started to develop an aircraft gun based on the Berthier principles. An effort was made to interest the Royal Air Force in its adoption as an ideal observer's gun. The result is officially known as the

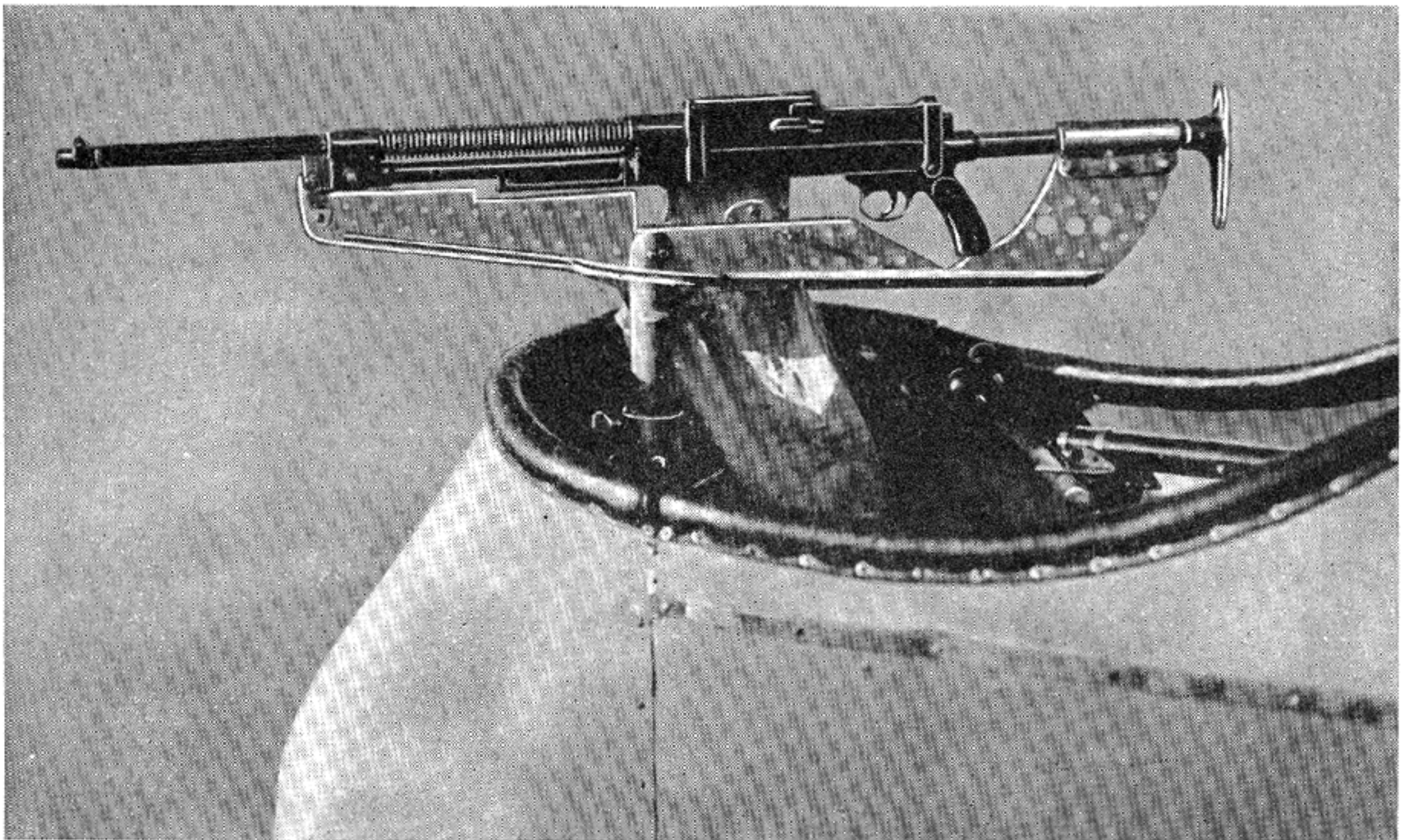

A Berthier Machine Gun, Cal. .30, Mounted as a Flexible Gun in a Curtiss Plane by the U. S. Navy, 1917.

Vickers G. O. ("gas-operated") machine gun, which made its first appearance in 1928.

Its main selling points were the extreme simplicity of its characteristic features and its very light recoil. The principal components could be assembled and disassembled without the aid of tools, and so constructed that they could not be put together incorrectly. The operating parts were housed in such a manner as to protect them from inclement weather. The silhouette was very clean, having no objectionable knobs or handles that would shuttle back and forth while firing.

The recoil was so light that a gunner could get in long bursts without being thrown off his aim. When overheated, the easily detachable barrel could be changed by an experienced operator in five seconds without touching it manually or disassembling other parts of the mechanism. The Vickers Co. recommended that a barrel be changed after a 240-round burst of rapid fire, but held it was possible to continue on if necessary. If it was determined that longer bursts were needed in aerial combat, a heavier barrel could be used and the ability to keep up sustained fire for great lengths of time could be greatly augmented.

All components were interchangeable, and manual manipulation of a device located near the trigger would instantly give the gunner a choice of single-shot or automatic fire.

The Vickers designers, knowing the main difficulties encountered in the maintenance of a machine gun in the air, tried to overcome these objectionable features by making it possible to change the extractor and ejector externally, if broken or damaged during fire, without stripping the gun. If disassembly for any reason was necessary, it could be done in less than 30 seconds. In order to take advantage of all cooling, the breech remained open upon cessation of fire leaving the hot chamber empty. This not only made a cook-off impossible but permitted cold air to circulate through the bore.

A drum-shaped feed of peculiar design, holding 97 rimmed caliber .303 cartridges and weighing 11¾ pounds when loaded, was used. This system, although resembling the Lewis feed in many respects, did not rotate when the weapon was firing, as it was latched securely in place fore

and aft. Each round was positioned by means of a pre-tensioned spiral spring.

A very clever rounds counter was also incorporated in the G. O. gun's design. To wind the spring, a flat piece is located on top with a recess cut for inserting the finger. When the drum is fully loaded, this flat winding lever revolves and the gunner can see at a glance how many rounds remain in the drum. The top of the drum is marked in such a manner that, whenever the combination winding lever and rounds indicator stops, the amount of ammunition left in the feed is revealed.

The addition of accessories necessary for aircraft use was the only difference between the ground machine rifle and the observer's gun. In the latter, however, the rate of fire was stepped up to 950 rounds a minute by a larger gas orifice leading to the gas cylinder chamber and a more efficient heavy-duty buffer to compensate for the faster recoiling parts. When used as an aircraft gun, it was mounted both singly and in pairs on a Scarff ring.

If its date of production is taken into consideration, the Vickers-Berthier was quite advanced, as it proved to be a reliable, easily maneuverable, high-speed machine gun that served the needs of the gunner-observer firing from an open rear cockpit. It is an example, however, of what happens to any piece of aviation ordnance when change in design of aircraft makes it obsolete. This very reliable high-performance rifle-caliber machine gun is practically unheard of today, because, coincidental with preparations for World War II, British aircraft with power-driven turrets to take the place of the rear observer and his free gun were beginning to make their appearance. This act doomed all specially made free guns regardless of their state of perfection, as the turrets were all armed with belt-fed fixed-type weapons with higher speed, mounted in groups of two or more. Although the weapon was outmoded, England was so desperate for machine guns of any type that it was held in reserve for training purposes and the arming of armored vehicles. Manuals were printed on its use and maintenance all through World War II.

To fire the Vickers-Berthier aircraft machine gun, a loaded magazine is slipped into a recess



Vickers-Berthier Aircraft Machine Gun, Mk I, Cal. .303.

on top of the barrel until it engages its holding catches fore and aft. The charging knob, on the left side, is pulled to the rear and then shoved forward. The selector located at the right rear is turned to automatic fire. This cams down one of the two sears that lock the piston. The other is released when the trigger is pulled and permits the bolt to leave the cocked position.

Driven forward by the energy of the compressed driving spring, the upper face of the bolt strips a cartridge from the mouth of the magazine and starts to chamber it. During this act the extractor rides over the cartridge rim and snaps into the cannellure.

Coincidental with reaching its extreme forward travel, the rear of the bolt goes slightly beyond a locking step that is machined in the top of the receiver body. The bolt has an opening machined in its rear portion in which is riding the camming lug of the cross arm. This is all con-

nected with a part of the gas piston. When the bolt reaches its locking recess, the speed and inertia of the piston cause the camming lug of the cross arm to engage a corresponding angle inside the bolt body, pivoting this part of the bolt up and against the locking step in the receiver body.

This swinging, or propping up, of the rear end of the piece removes the obstruction that has been holding back the cross arm on which the firing pin is attached. Being forced by the sudden pivoting of the rear portion of the bolt body, the cross arm and firing pin can continue to advance with great speed for one-half inch. The firing pin then enters its tunnel and its tip smashes into the primer of the chambered round.

After the powder charge explodes and the bullet has passed a port about two-thirds of the way up the barrel, gas is admitted through a controlled orifice that acts on the face of the gas

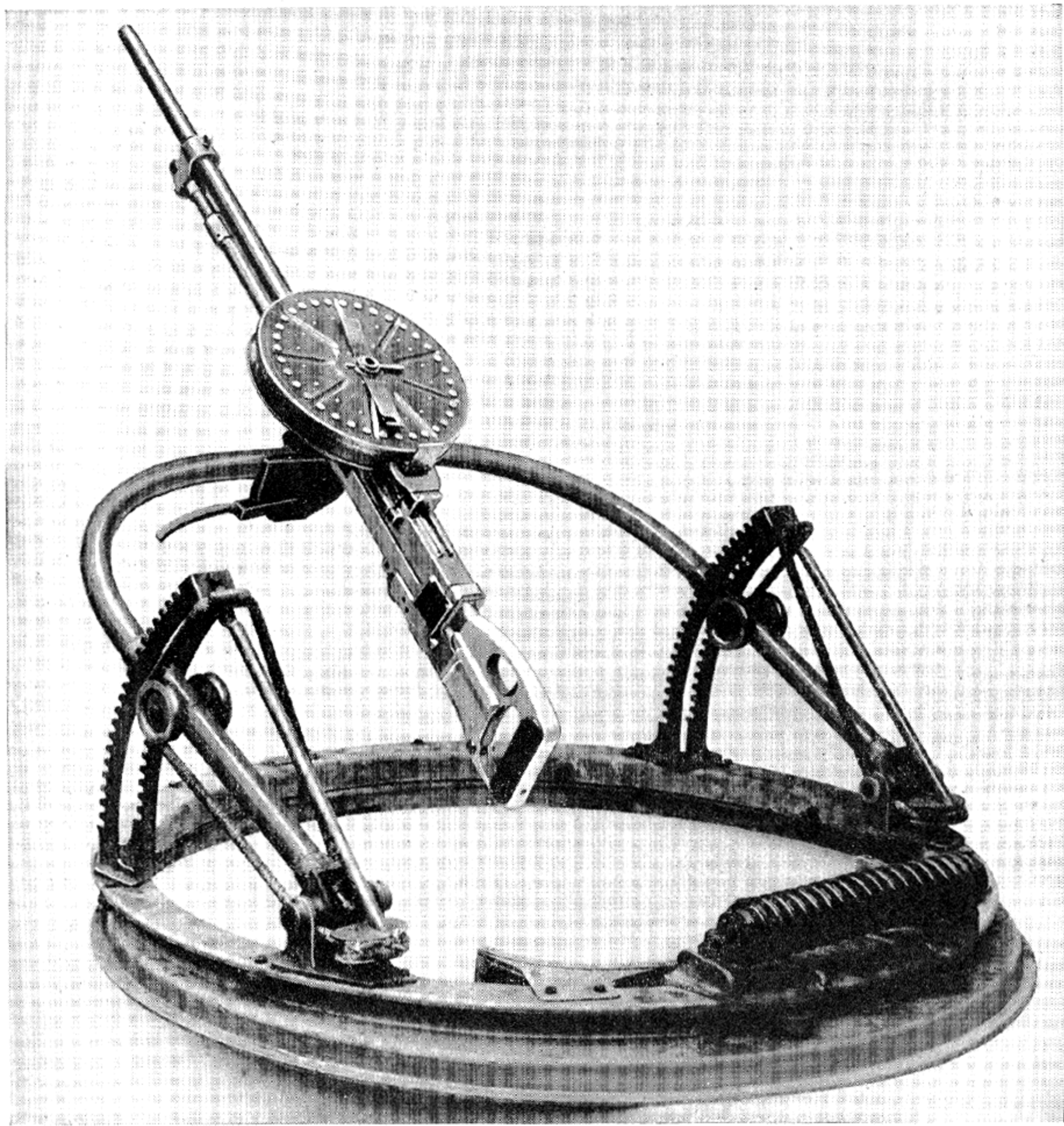

Vickers-Berthier Aircraft Machine Gun, Mk 1, Cal. .303, Mounted on a Scarff Ring.

piston. The latter's first movement rearward withdraws the firing pin tip from the primer, and after the cross arm is driven back approximately one-half inch, it disengages the two cams that are holding the swinging portion of the bolt against the locking step. The bolt assumes the horizontal in its slideway and starts to the rear.

A spring-loaded extractor withdraws the empty case and holds it close to the bolt face until the ejection slot is reached in the receiver. At this time the ejector fastened in the receiver collides with the base of the cartridge, pivoting and

throwing it down through the opening to the right into a deflector for catching the empty cartridge. The spring-loaded magazine pushes another round in position and the recoiling parts continue on against the loading forces of the driving spring. Full recoil takes place when the moving parts make contact with a spring-loaded buffer that not only absorbs the surplus energy but accelerates the operating mechanism during counter recoil. If the trigger remains to the rear, the return movement results in repetition of the cycle.

## LAHTI (SUOMI) (L/S) MACHINE GUN

The Valtion Kivääritehdas (State Rifle Factory) at Jyväskylä, Finland, produced in 1926 a light machine gun that operated on the short recoil system. It was the invention of Finland's most outstanding automatic weapon designer, Aimo Johannes Lahti, who for a number of years was chief of this government arsenal. Lahti originated weapons for his country's use in all sizes from rifle caliber to cannon and, unlike most inventors, did not exploit a single basic system of operation but employed various methods ranging from short recoil to gas.

The Lahti (Suomi), or L/S, light machine rifle was one of his most refined models and was later used extensively by his countrymen in the Russian campaign. It was greatly respected by the Soviets and copied extensively by them. Ironically, while the Finns produced it primarily for sale either to England or to Germany, they were forced to use it first in defense of their homeland. The weapon, as modified in 1932, was given the factory designation, L/S Machine Rifle Model 26-32. It was air cooled and could be fired both full automatic and single shot.

The physical appearance of the weapon was practically the same as a standard army rifle and it was pointed out by the promoters that one in-

fantryman armed with the L/S 26-32 could lay down as much fire power as an ordinary company firing the bolt-action rifle.

This weapon was produced originally for possible sale to the two major powers, England and Germany, which the Finns felt were potential enemies of each other. The weapon was chambered for each country's cartridge and it was especially designed so that, by merely switching the barrel and bolt, either cartridge could be used.

As evidence that the producers of the L/S 26-32 used this method of impartially seeking the business of both sides in any future war, a portion of a promotional booklet dated 1933 is quoted:

"The greatest advantage of this machine gun is that it at last solves the problem of a universal machine rifle of different calibers. It is designed so that after fitting in different operational parts the firing of cartridges of different calibers is possible. At present machine guns with firing mechanisms for British and German army cartridges are being made. During the manufacture, trials have also been made with 7.9-mm and 6.5-mm military cartridges and it was proved then



Lahti Machine Gun, Model 26/32, 7.92 mm.

the functioning and the accuracy of the weapon were equally good as with the above-mentioned cartridges. It is accordingly fully possible to chamber the weapon for every known cartridge powerful enough to operate its mechanism.

"It must be pointed out as a noteworthy fact, that for countries that use cartridges of different calibers, this machine gun has one great advantage in that it is built exactly in the same way for all kinds of cartridges, with the exception of the easily exchanged recoiling parts which must be changed, of course, on account of differences in chamber and bore measurements. To the recoiling parts belong the barrel, barrel extension and bolt.

"It must be remembered that the receiver is absolutely the same for all recoiling units, so therefore the operational parts are changed as one piece, because the barrel is rigidly screwed together with the barrel extension. . . . All bolts are exactly the same in appearance and dimension provided the cartridge rims do not differ too much. In that case the bolt must also be exchanged. For instance, when firing 7.92-mm, 7.7-mm, and 6.5-mm caliber cartridges it is not necessary to change the bolt because the difference in diameter of the cartridge rims is so insignificant with these cartridges that it does not cause any disturbance in functioning.

"There is another advantage which must be observed also and that is that in a state of war, in case of capture of any of the above kinds of cartridges, this machine gun can use the ammunition by putting in other operating parts in their own receivers. . . .

"These changes can be made during the actual fighting and they would only take some eight seconds to perform, provided the necessary operating parts are brought along by the machine gun section. *Every state, however, knows its possible future opponent in war, and what kind of ammunition they will use and can always keep a certain number of exchange systems in stock.*"

The feed system is either a spring-loaded clip that holds 25 British caliber .303 or German 7.92-mm cartridges, or a flat drum magazine with a capacity of 75 rounds of the same ammunition. The weapon is chambered for either the British or German Army rifle cartridge, with a maxi-

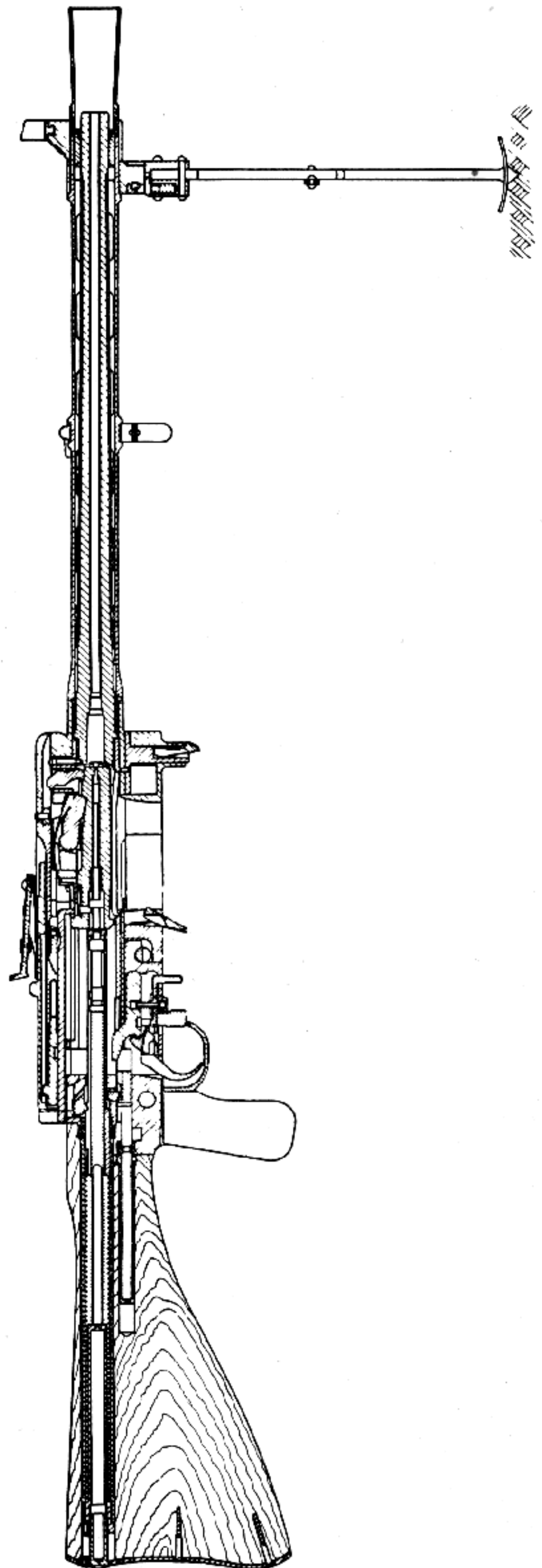

Section Drawing of the Lahti Machine Gun, Model 26/32.

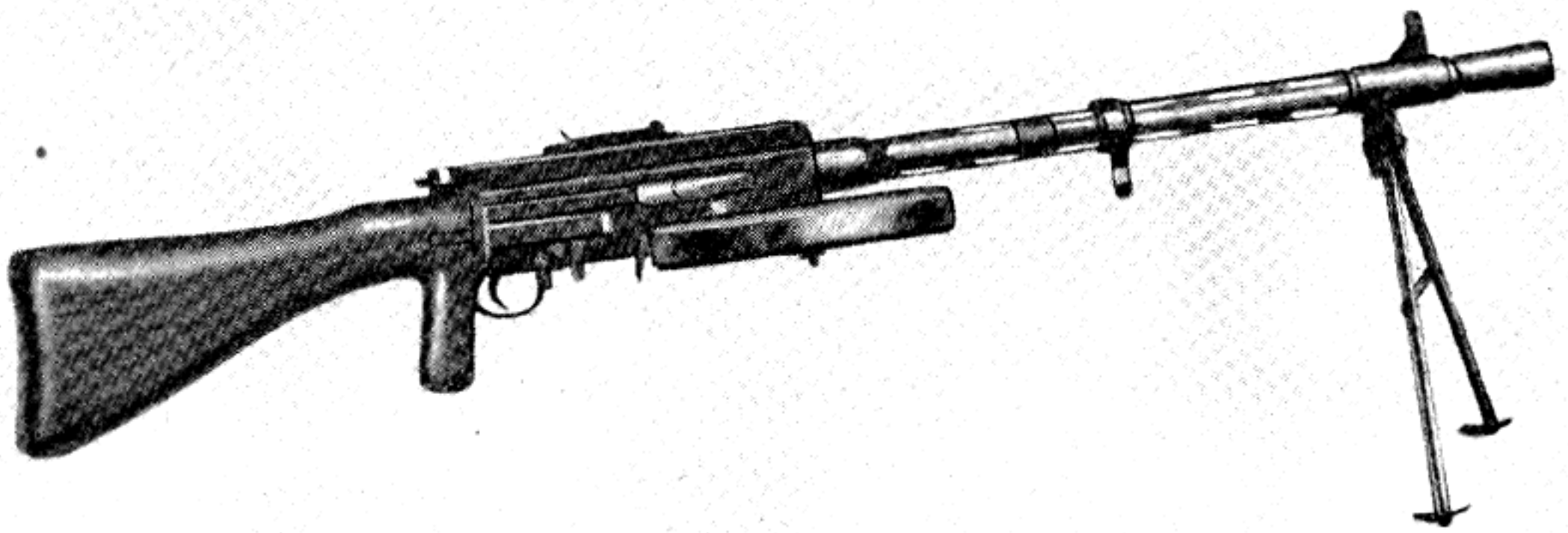

Lahti Machine Gun With Drum Magazine.

mum rate of fire given as 500 shots a minute. The safety device operates so that, when the slide in front of the trigger is pressed back as far as it will go, a projection comes up under the sear. This makes it impossible to pull it down for release until the device is again moved forward.

For semiautomatic fire, the selector switch is moved off the safe position. As the trigger is pulled, the connector moves downward and draws the sear with it, releasing the bolt. Further pull on the trigger causes a nose on the front end of the connector to turn the latter around on the axle, whereby it is disengaged from the sear. This piece, under spring influence, engages its recess in the bolt before going forward to fire another shot.

The operator must release the trigger so that the connector may again engage the toe of the sear. Another pull on the trigger releases the sear to repeat the two distinct movements necessary for single shot firing.

To change either the conventional box-type magazine or the drum-shaped one, the magazine catch is pressed and the empty magazine removed by pulling down. A fresh one is then inserted, after observing that the holding catches are correctly engaged.

A loaded round cannot be left in the chamber of a hot barrel after a burst of long duration, as the bolt is automatically held to the rear after releasing the trigger. This not only prevents a

cook-off but allows cool air to circulate through the open bore.

The barrel may be removed in a few seconds merely by turning the lever 180 degrees. This releases the catch holding the butt stock to the receiver. Then after lifting the receiver cover, the barrel extension with barrel and bolt can be pulled out to the rear. A cool barrel complete with extension and bolt is then inserted in place of the hot one. To prevent disassembly of the barrel and its hot members, the whole operating unit is changed.

To fire the L/S 26-32 light machine gun, the operator, if using the flat 75-shot drum, first removes the magazine support and pushes the drum up until its holding latch snaps. From the prone position, the charging handle is grasped by the right hand and pulled all the way to the rear. At this point the rising spring-loaded sear engages the notch in the bottom of the bolt, holding it to the rear. The weapon being cocked and ready to fire, the selector switch is moved from *Safe* to *Automatic fire* and the trigger pulled.

As the sear disengages the bolt, it is thrust forward by the energy of the compressed driving spring. The feed rib on top of the bolt shoves the first round out of the lips of the magazine and starts to chamber it. At a distance of one-half inch out of battery, the bolt seats behind the cartridge and the extractor claw snaps over its rim. At the same time the bolt-locking piece is cammed



down into its locking notch on the bolt and this act releases the holding device that has been keeping the barrel and extension to the rear.

The locked barrel, its extension and its bolt start final movement forward and at a point one-sixteenth inch from full battery position a pivoting pin in the tip of the bolt body that has been in the path of the retracted firing pin contacts a ramp in the receiver and is levered up out of the way. The firing pin is now released to fly forward, striking the primer. The timing is such that recoil forces of the exploding powder charge are set up before the fast traveling locked mass strikes the solid receiver, thus utilizing these forces to buff the action.

The recoiling parts are locked securely together for a distance of a half inch; the stud on the bolt lock then engages a cam in the receiver that lifts it out of its locking recess. The movement is done in such a manner as to allow the

bolt to creep a few thousandths of an inch rearward before total unlocking. This permits the extractor to break the gas seal and fully loosen the cartridge during this phase. At the instant of firing, energy is transferred from the fast recoiling barrel to the bolt by means of an accelerator, which, upon pivoting, speeds the bolt to the rear with the extractor holding the empty cartridge case. When its rim strikes the solid ejector, it is knocked out of the slot in the right side of the gun.

The first recoil movement starts to jack the firing pin to the rear and continues to do so until its sear in the top of the bolt drops in front of the circular projection over the body of the pin. The barrel and its extension at the moment of bolt release is held in a retracted position by its holding latch. When the bolt has reached its final recoil stroke, compression of the driving spring starts it into counterrecoil to repeat the cycle.

## RHEINMETALL-BORSIG MACHINE GUNS

## Introduction

It is appropriate that the background of Rheinmetall-Borsig A. G., the giant of the German munitions industry in World War II, be outlined in order to help explain some of the reasons for the firm's mushroom growth.

On 12 February 1888 the directors of the already established firm of Horder Bergwerk of Westfalen, Germany, accepted a large contract to produce a new style jacketed bullet for the German Army. At the time it was decided it would be more satisfactory to have production of the bullets carried on by a separate company at another location. Consequently, a factory was completed at Derendorf, a suburb of Düsseldorf, on 13 April 1889. It was named Rheinische Metallwaren und Maschinenfabrik A. G., and on 7 May 1889 actual operations began.

The new company's technical adviser and vice chairman of the board of directors was Heinrich Ehrhardt, formerly a manufacturer of business machines in Düsseldorf and later famous as an ordnance engineer and inventor of gun mechanisms. The company prospered from government contracts for artillery and ammunition. A large volume of business for the same materials was also carried on with foreign governments, and at the outbreak of World War I Rheinmetall was second only to the great firm of Friedrich Krupp A. G. in the field of munitions.

During the conflict the company was engaged to the limit of its capacity in all kinds of ordnance production. It then began for the first time development and manufacture of machine guns, making, as did many other plants, the Maxim Model '08.

After the Armistice Rheinmetall's ordnance and munitions division had to be dismantled in accordance with Articles 168 and 169 of the Versailles Treaty. It was suspected and later confirmed that 23,000 tons of the firm's lathes, dies,

drawings, and patents were shipped at this time to neutral Holland and stored in warehouses in both Delfzyl and Rotterdam.

In accordance with other clauses in the treaty, the Inter-Allied Control Commission authorized the two firms, Krupp and Rheinmetall, to construct a limited number of weapons for the then small German Army and Navy. It was specified that the work was to be divided in such a way that Krupp would build all guns with a caliber over 17 centimeters and Rheinmetall all with this bore diameter and below. Krupp was thus confined to production of naval guns, since land cannon as great as 17 centimeters were forbidden to Germany. Consequently, all army weapon development fell to Rheinmetall and between the years 1925 and 1927 the company was permitted to install, subject to Inter-Allied supervision, the many special facilities necessary to carry on such activities.

From this point on Rheinmetall began to formulate plans that would put it in a position to regain its lost world trade. An attempt was made to establish a subsidiary company in Holland under the name of Hollandische Industrie und Handels Maatschappij (HIH), but this venture turned out to be anything but satisfactory. With the severance of its Dutch connection in 1929, Rheinmetall acquired ownership of a concern then known as Waffenfabrik Solothurn A. G. in Solothurn, Switzerland.

This Swiss plant originated as a watch-making concern. Following the war the company had trouble keeping solvent because of the slump in that industry. It was sold at a sacrifice to a Swiss citizen named von Steiger, who previously had been a director in the Deutsche Waffen- und Munitionsfabrik A. G. of Germany. Von Steiger left the employ of D. W. M. when the enforcement of the disarmament clauses in the Versailles treaty by the Inter-Allied Control Commission ended its activity by completely dis-

mantling this mighty automatic weapon manufacturing company.

The new owner converted his establishment to the making of cartridges for small arms and failed financially a short while later. The factory was then taken over by Fritz Mandl of Hirtenberg, Austria. The Solothurn plant, upon passing into Mandl's control, was immediately converted to the manufacture of various types of small arms. It was with Mandl that Rheinmetall dealt in purchasing the Solothurn plant in order to control a weapons factory in a neutral country free from Allied restrictions.

In accordance with the terms of purchase, Fritz Mandl was retained in 1929 as director of the new subsidiary of Rheinmetall. Since the parent company was 51 per cent owned by a German Government holding corporation, and as 90 percent of the ownership of Solothurn was in the hands of Rheinmetall, it can be readily seen that the German military authorities could control its policy. Through the Rheinmetall offices in Berlin, an agreement was also worked out with a large armament factory in Austria and similar contracts were also made with other manufacturers, particularly in Austria and Hungary, for production of component parts of automatic weapons.

It is incredible that in a matter of months after being taken over by the Rheinmetall firm, Solo-

thurn, with its limited facilities, could have manufactured all the weapons known to have been sold bearing its name. Actually it has been found that Solothurn procured the necessary components from inside Germany and Austria and used the plant primarily as a place of assembly.

In this manner it served the holding company well. It allowed Rheinmetall to sell not only to nations friendly to Germany, but also to politically hostile ones which needed armament but dared not arouse public opinion at home by buying munitions directly from a German firm. Both Solothurn and the customer nation found it agreeable to hide at the moment behind the shield of Switzerland. Apparently only the Germans knew exactly what was going on, as it will be noted they always possessed a weapon superior to the one being offered for sale. In other words, they could see no harm to the Fatherland in allowing the rest of the world to pay for experimental and development work while they prepared for another war.

### Solothurn Model 29

Within 2 months after its sale to Rheinmetall was approved on 4 April 1929 by the stockholders of the old company, Solothurn offered a new machine gun, Model 1929, to the military powers of the world. This would have set an all-time



Solothurn Machine Gun, Model 1929, 7.92 mm.

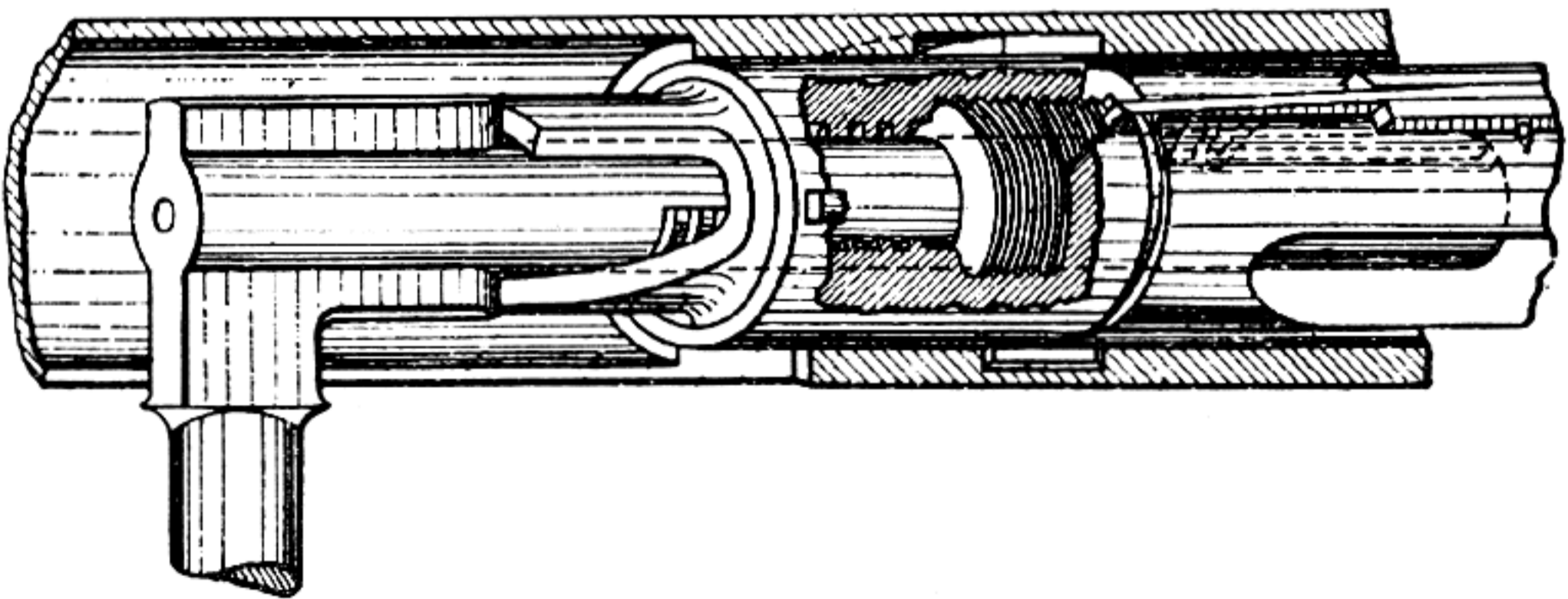
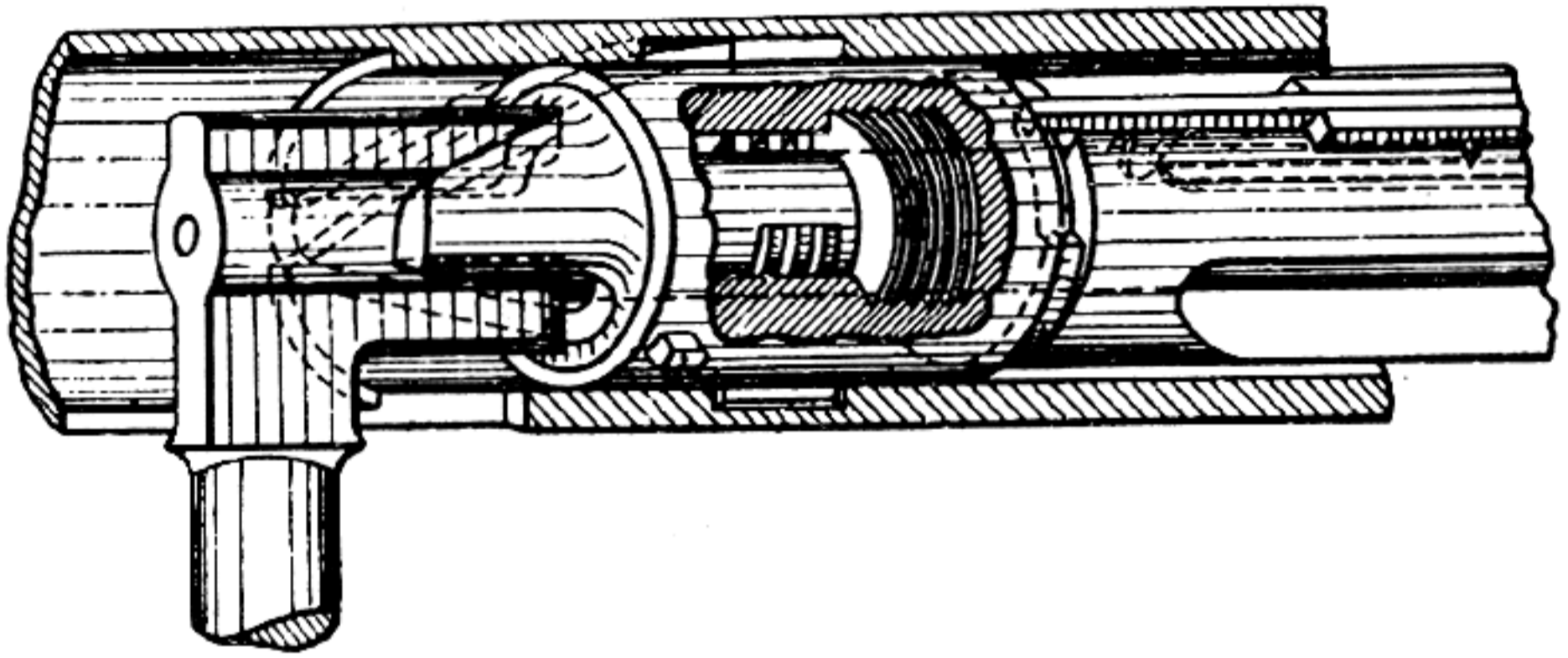
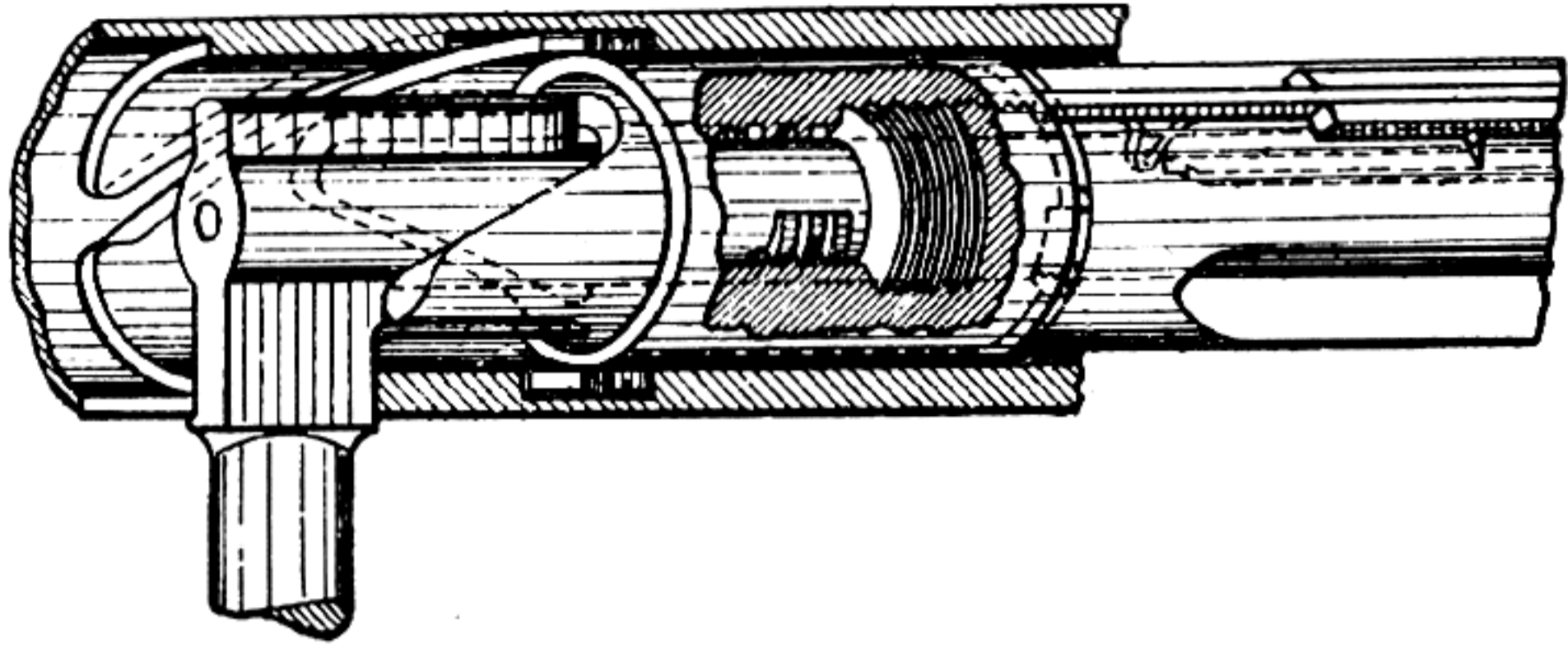

Drawings Showing Stange's Action. Top: Bolt in Battery, Locked, Ready to Fire. Center: Gun Fired, Barrel Recoil Rotating Locking Ring. Bottom: Locking Ring Fully Rotated and Bolt Unlocked.

high for conception, design, and production had the Solothurn craftsmen actually done this. The truth of the matter was that the weapon was originated and developed at Rheinmetall by Louis Stange, who is rated among the best of Germany's many fine automatic arms designers.

Stange first started work in the Theodor Bergmann arms factory at Suhl as an apprentice of Louis Schmeisser, one of the most prolific creators of sound automatic weapon systems in all Europe. They included self-loading pistols and submachine guns in addition to refinements on already existing mechanisms. Schmeisser, like Stange, became affiliated with Rheinmetall and assigned many of his patents to this company.

Most of Germany's other talented mechanics who had shown their ability to produce successful automatic gun mechanisms were also on Rheinmetall's technical staff. The most outstanding of these designers were Karl Heinemann, of Berlin, developer of the Parabellum action in World War I, Fritz Herlach, Karl Voller, Alfred Krum, all of Düsseldorf, and Herman Henning and Wolfgang Rossmanith, of Berlin.

These names are given to show the significance of the following statement made by Solothurn in literature announcing its debut in the gun-producing business:

"The Waffenfabrik Solothurn A. G., of Switzerland, is authorized to copy and reproduce all patterns of construction of the Rheinische Metallwaren und Maschinenfabrik A. G. (Rheinmetall-Ehrhardt), of Düsseldorf, Germany."

With the financial backing and the design genius that was thus made available to the small plant located outside of Allied jurisdiction, there is little wonder that many fine weapons began to make their appearance bearing the name "Solothurn."

The Solothurn Model 1929 was an air-cooled, short-recoil-operated machine gun of very light construction, weighing only 17 pounds. The barrel was chambered for the German 7.92-mm infantry rifle cartridge. It was of extremely simple construction with few component parts. These pieces, as the promoter pointed out, were machined almost exclusively in lathes. Thus the manufacture of spare parts would offer no difficulty to any government that purchased them. South American countries were particularly in-

terested in them because of being able to make needed replacement parts in their own machine shops.

The bolt was cylindrical in shape with a central locking ring rigidly holding the bolt and barrel together by means of six interrupted threads. The striker was enabled, by the removal of the obstruction at the time of locking, to continue on into the primer of the cartridge. This method was known as timed inertia firing. When the magazine was emptied by the discharge of the 25 cartridges, a catch then rose and held the bolt in the cocked position. It also warned the operator that it was necessary to place a fresh magazine in position. The safety was a device that locked bolt and trigger together, allowing the insertion of a loaded magazine with the bolt locked on safe.

Single shots, or automatic firing, of the Solothurn Model 1929 could be accomplished without interrupting the gunner's aim. The operational energy was derived from the recoiling masses. Under heavy strains brought about by abnormal testing conditions, the mechanism proved to be very reliable.

## MG-30

These weapons had hardly been made available when Solothurn—as Rheinmetall's outlet—put on the market a more refined version, designated by the factory the S-2-200, and by the German Army the MG-30. Its method of operation was basically the same as that of the earlier model.

A considerable number were sold to European governments. Austria, for instance, adopted the gun in 8-mm bore, calling it Model 30; while Hungary put it into her service with the designation, Model 31. In the next 5 years these nations alone purchased over 5,000 S-2-200 light machine guns. That the two neighboring countries accepted this type is quite understandable since the Steyr arms factory, in Austria, is credited with furnishing everything about these weapons except for assembly, which was done at Solothurn.

As with the earlier model, when the last shot was fired, the bolt stayed in a retracted position. The loaded magazine could be inserted regard-

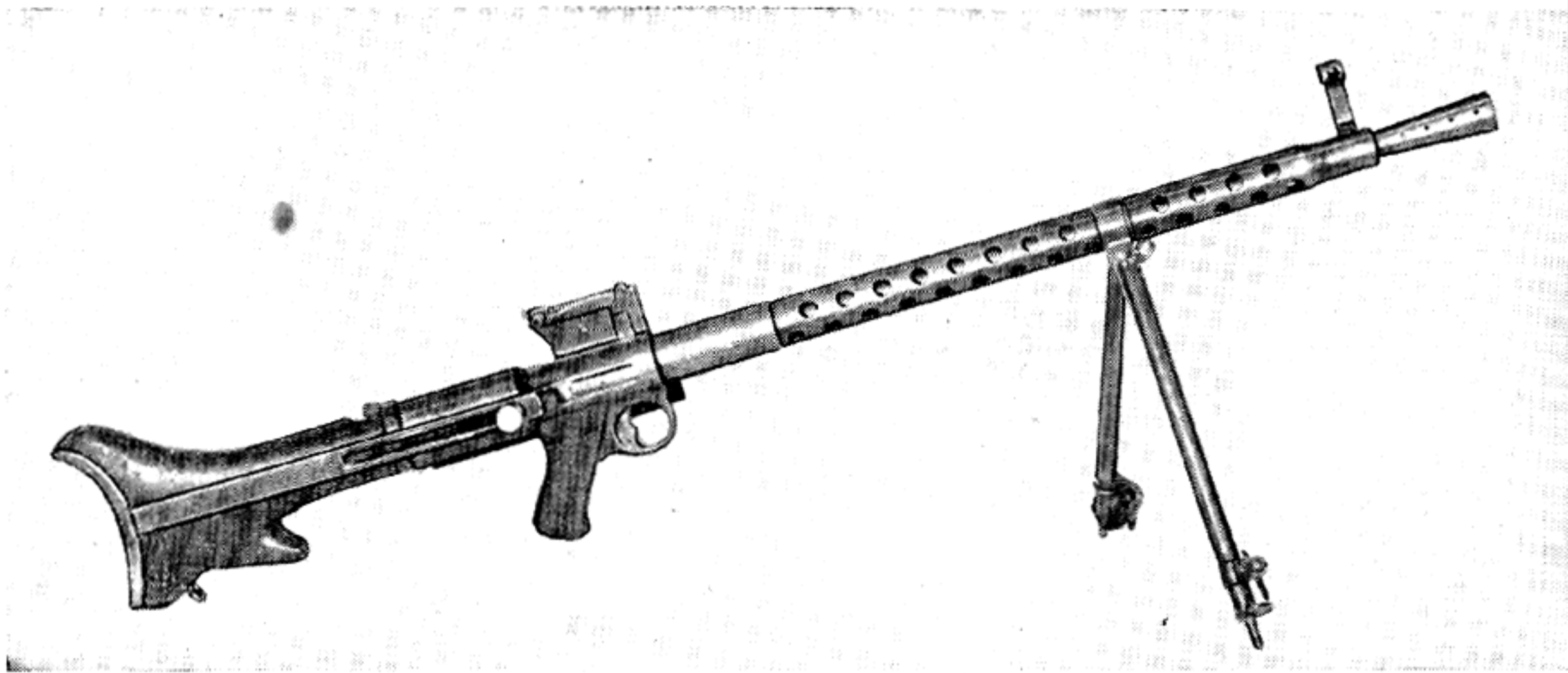

Solothurn Machine Gun, Model 1930, 7.92 mm.

less of the position of the bolt. Two circular depressions were cut one above the other on the front face of the trigger. Pressure on the top one gave single shot operation, while a pull on the lower portion delivered automatic fire. This permitted the operator to change from one to the other without interference with his aim.

The barrel of the MG-30 also was air-cooled, but a different provision from that of the earlier versions was made for changing it. The switch from a hot barrel to a cool one was done in a quick and unique manner. The shoulder piece was moved from the receiver by pressing on a locking spring. The stock was then turned 60° to the left and pulled backward, the driving spring and its guide remaining in the rear housing. The barrel, with the attached bolt and carrier assembly, then were shaken out of the receiver to the rear. The assembly was disconnected from the hot barrel and placed on a cool one. The replacement was then inserted in the jacket and the procedure reversed.

The German Army ran a 100,000-round test on the model and reported very good results. However, it was not adopted for general service, although many were used for drill purposes.

When the MG 30 is fired, the barrel, bolt, bolt extension, mainspring guide, and locking ring move backward under action of recoil as a rigid assembly with respect to the receiver. At a predetermined distance, the rollers on the lock-

ing ring engage the spiral groove in the walls of the receiver.

Further rearward movement turns the locking ring and unlocks the bolt. At this point the recoiling of the barrel, bolt extension, and locking ring is checked by a buffer and they are held in this retracted position. The bolt and mainspring guide now move rearward under the accelerated force imparted by the spiral grooves, as the extractor withdraws the empty cartridge. Further recoil ejects the case and compresses the main driving spring. When these parts have reached the extreme distance they can travel, counter recoil commences.

As the bolt moves forward, it picks up a round from the magazine and chambers it. The bolt, being seated in its carrier, pushes the carrier, barrel, and locking ring forward. The latter, turning under the influence of its lugs, engages the spiral grooves and locks the assembly. When the bolt first starts into counterrecoil movement, a sear engages its notch in the firing pin, holding it while the rest of the assembly continues on to compress the firing-pin spring. The final movement of going into battery automatically releases the firing pin.

## MG-15

In 1932 Rheinmetall presented the German Air Force two weapons that were the outgrowth

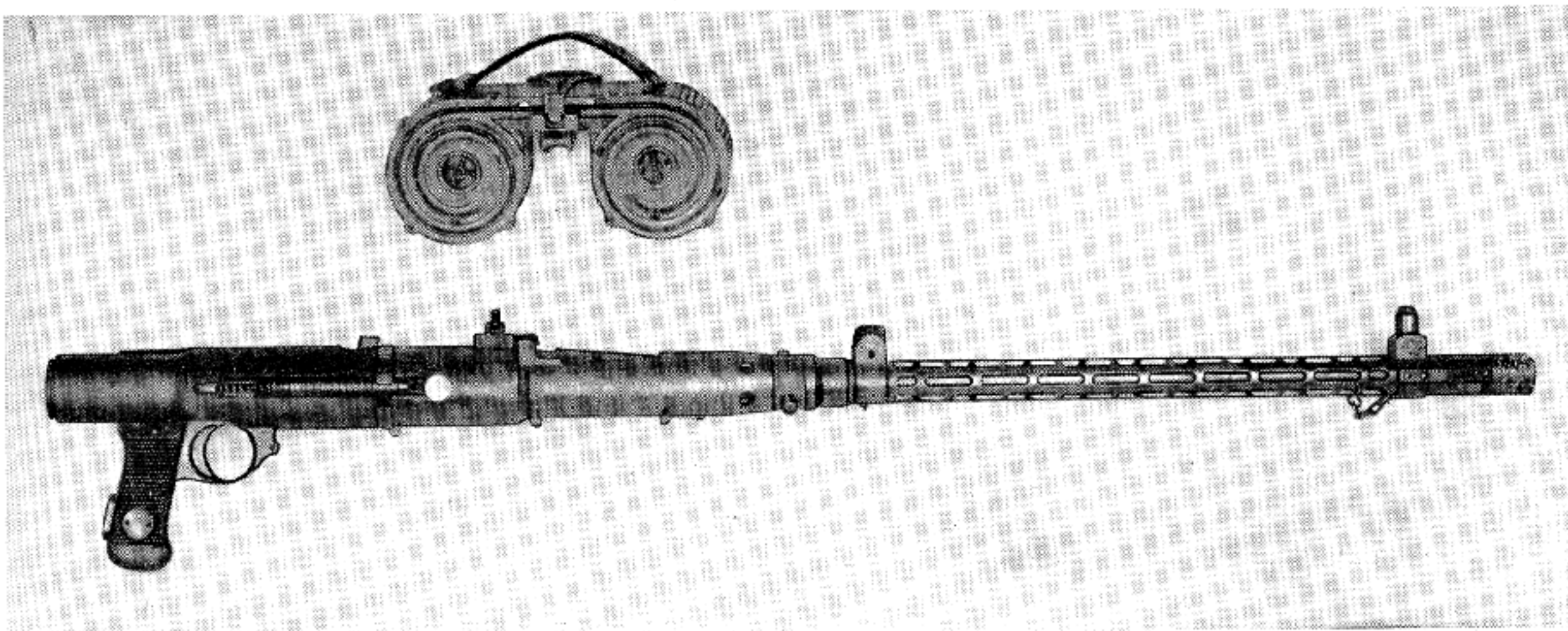

Rheinmetall Aircraft Machine Gun, Model 15, 7.92 mm.

of the MG-30. Both were rifle-caliber aircraft machine guns and were given the designations, T6-200 and T6-220. They were promptly adopted by the German aviation section the following year and officially named the MG-15 Fixed and MG-15 Flexible.

Only minor modifications were made from the MG-30 to adapt them to aircraft use. If examined closely for comparative purposes, there was no difference in the basic action of these weapons and of Stange's earlier models. The rate of fire on the aircraft version, however, was increased from 750 to 1,000 or more shots a minute by the employment of a muzzle booster with a restricted orifice. Ammunition was carried to the fixed gun by means of a metal disintegrating belt. An odd but efficient recoil-actuated ratchet-type feed system indexed each round and could feed from right or left, as desired, by the mere repositioning of parts.

On the MG-15 Flexible gun, ammunition was fed from a twin-drum magazine, holding 75 rounds. The cartridges were lodged in two containers fitted to the right-hand and left-hand sides of the gun. In this system of cartridge feed by twin drums, the two halves of the drum were alternately emptied, so that the center of gravity was not affected by the gradual emptying of the container. The magazine could be changed with one hand in a very short time.

The MG-15 Fixed gun would fire on an average of 200 rounds a minute faster than the one

with flexible mount. This was due to the rigidity in mounting the stationary gun that could utilize more of the recoil force of the exploded powder charge. The fixed gun was also easily adapted to fire between the propeller blades by use of a synchronizer. One particularly bad feature about the wing installation, however, was that, in the event of a condition known as a runaway gun, no provision was made for stopping it and uncontrolled fire would continue until all ammunition was expended.

### MG-17

The German Air Force decided that, while the lightweight high-speed MG-15 had many good features, it could still be made more suitable for aircraft use if it were not rear seared after each burst, since this presented a serious synchronizing problem. The cocked bolt was considered essential in designing ground-type weapons in order to leave the overheated chamber empty after each burst and prevent cook-off of the loaded cartridge. It was not considered a critical factor, however, in aircraft installations. The fixed weapons could be cooled with high velocity air by ventilation and, if a cook-off were to happen, there was little danger of the bullet striking friendly materiel or personnel. In addition, guns were being mounted in the wings outside the propeller arc and were divorced from any attention or maintenance from the pilot

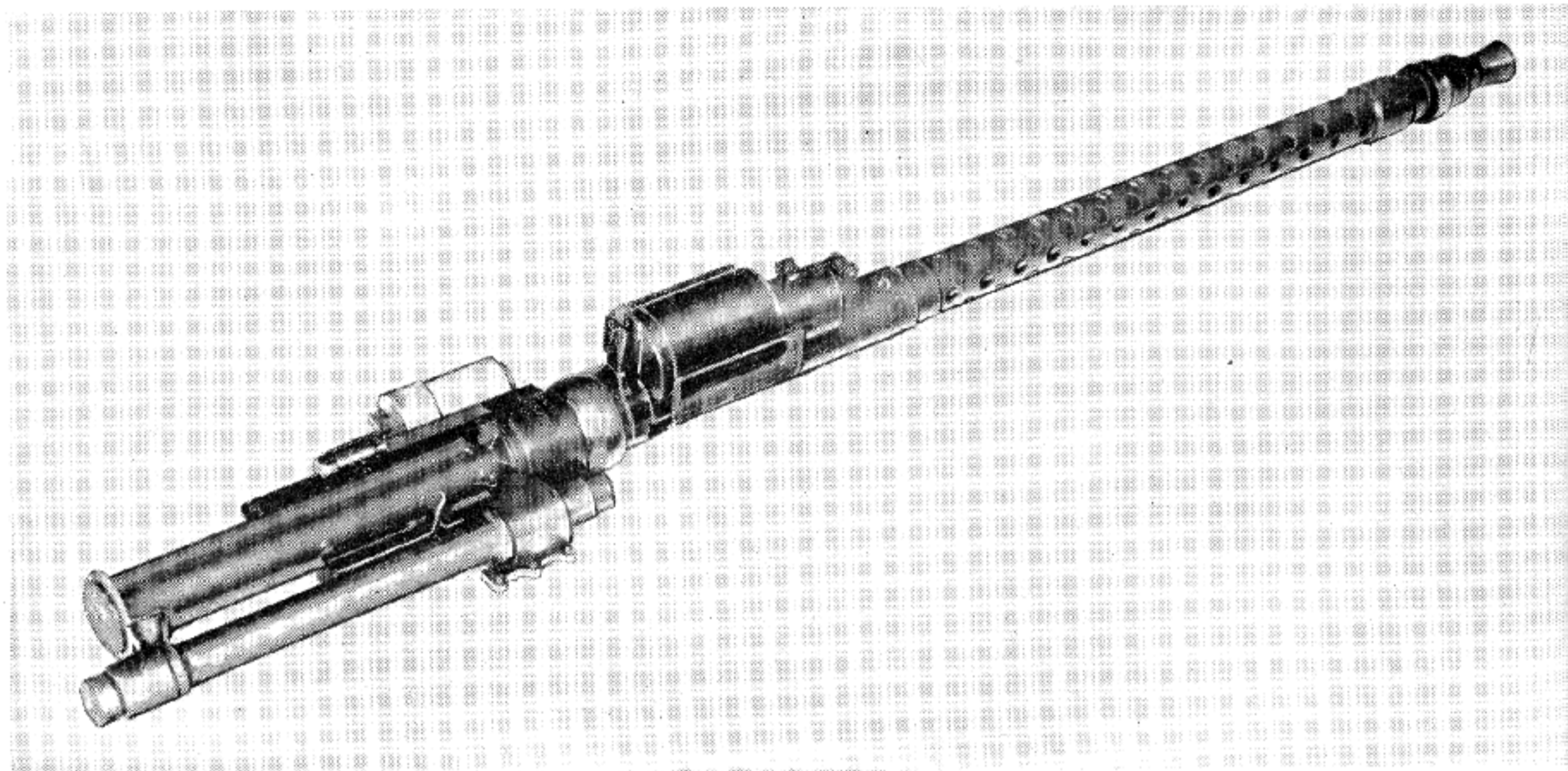

Rheinmetall Aircraft Machine Gun, Model 17, 7.92 mm.

gunner. This necessitated the use of devices that performed the functions of charging and firing the weapons by remote control.

With these problems in mind Rheinmetall designers made several improvements on the original MG-15 by modifying it so that it could be loaded and cocked by means of a charging device. It was actuated by compressed air and

then fired by an electrically controlled trigger contrivance called a solenoid.

In order that this closed-bolt firing version operating by remote control would not be confused with the models not having the above modifications, this machine gun was officially known throughout the German armed services as the MG-17. Other than the refinements mentioned

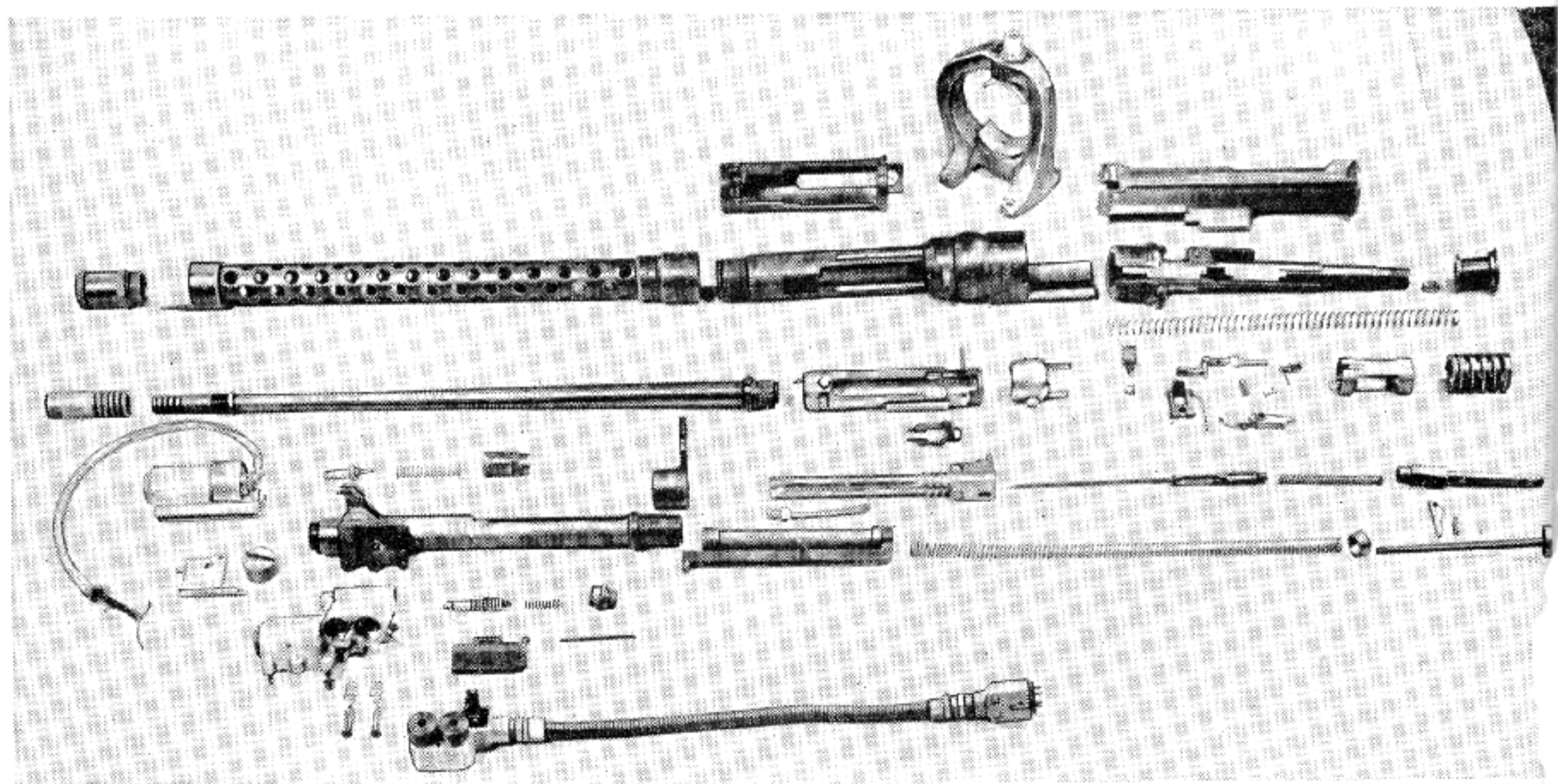

Components of the Rheinmetall MG-17.



there was no difference between it and similar Rheinmetall guns that preceded it.

The abnormally high speeds demanded of aircraft machine guns made head-spacing a critical dimension. Provision was made on this gun whereby an ordnance man in the field could arrive at this measurement quickly and efficiently by use of a case-hardened gage. The instrument was made in the form of a cartridge to be inserted in the chamber. The bolt latch was raised and the bolt lock rotated until pressure was felt. It was also necessary, when head-spacing the MG-17, to make a compensating adjustment on the solenoid. Consequently, they were manufactured with four choices of measurements designed to take care of any permissible head space movement.

The charging device was operated by compressed air, the planes first being equipped with small compressors that operated off the main engine and later with cylinders that were charged on the ground. Carbon dioxide bottles were also used but it was found that, although this method was most efficient under certain conditions, it had a tendency to freeze up the mechanism of the charger, because of the extremely low temperature of the expanding gas.

### MG-131

Shortly after the introduction of the MG-15 by the German Air Force, negotiations were started for the amalgamation of Rheinmetall with then bankrupt Borsig works, which had an enormous well-equipped plant at Tegal, a northern suburb of Berlin. In the past the firm had made locomotives and other heavy steel fabrication. On 1 January 1936 the deal was completed and Rheinmetall-Borsig A. G. first came into existence.

Hitler then held full power over Germany and Herman Goering had been given the responsibility of building up German aviation might. One of Goering's first official acts was to make a former World War I squadron mate chairman of the new corporation's board of directors. This officer was Rettmeister Bolle, a much decorated fighter pilot, and he sought to show the fatherland that he was worthy of the "Pour Le Merite" by introducing improved aerial weapon design.

The German Air Force well realized its need for a high-speed light machine gun chambered for a caliber larger than the standard rifle cartridge. As soon as the restrictions placed upon them by the Allies were lifted, a directive from Goering to the Rheinmetall-Borsig firm ordered it to develop and produce a suitable weapon in this category. The resulting machine gun was given the official marking, MG-131.

This belt-fed, air-cooled weapon weighed only 40 pounds, and had a rate of fire officially accepted as 960 rounds a minute. The most important thing, as far as the Germans were concerned, was that it was chambered for a specially constructed 13-mm cartridge propelling a bullet with the high velocity of 2,560 feet. In addition to being light and reliable for its larger caliber, another advantage was the use, in place of a standard percussion striker, of a spring-loaded firing pin that detonated the primer by means of electricity. The greatest benefit of this method of detonation was for synchronization and fire interruption.

Although Louis Stange first started work on such a gun in 1933, it was not until Germany was on the threshold of war in 1938 that the weapon made its debut, and then in the greatest secrecy. Germany wanted her potential enemies to believe she still had nothing larger than the 7.92-mm aircraft machine gun.

Its initial appearance was in very limited numbers for paired installation in turrets, being the first heavy caliber machine gun to be used in a German land plane. A pair was mounted in a power-driven turret on the DO-217E2. This plane also carried another MG-131 in the rear central position, which, however, was operated manually.

The feed system was interchangeable from left to right, and vice versa, by repositioning of parts. Empty cases were ejected through a slot in the bottom of the receiver, a very necessary feature for aircraft use. Cocking, when done by hand, was accomplished by use of a ratchet handle that required 8½ strokes for full retraction of the parts. When not in operation, the handle, which was the invention of Georg Engel and Alfred Winter, two Rheinmetall engineers, folded down out of the way and was shoved for-

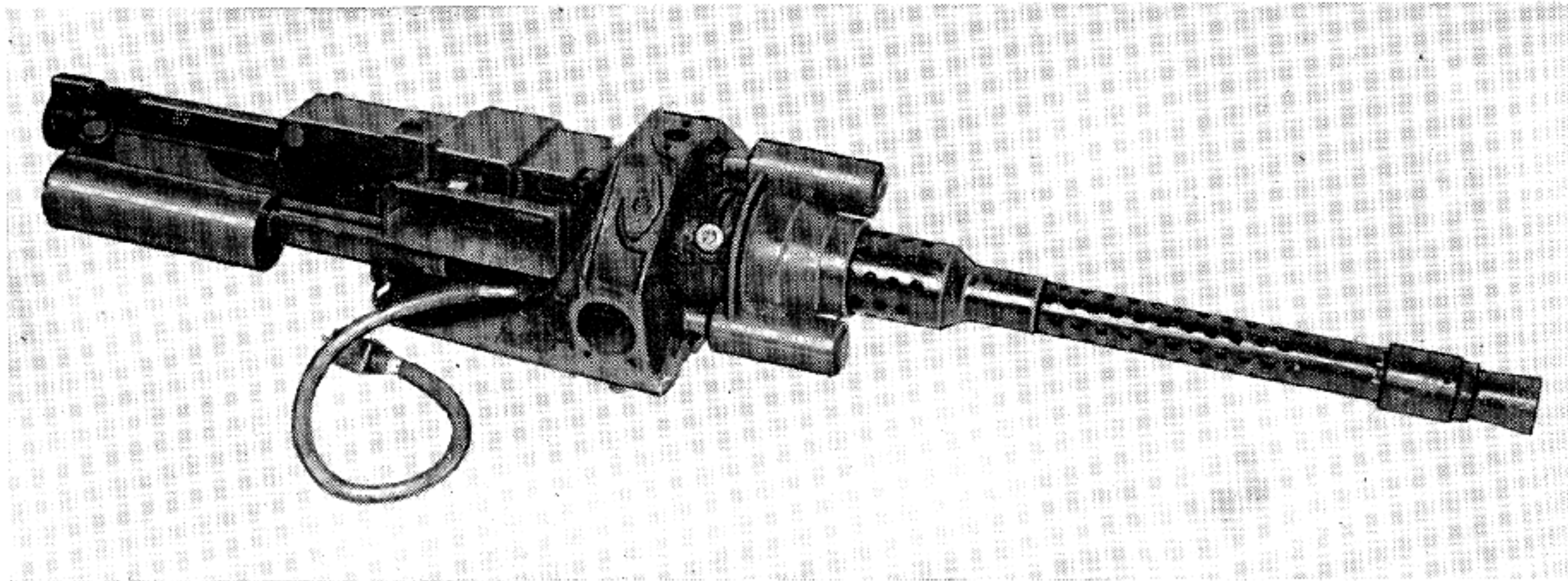

Rheinmetall Aircraft Machine Gun, Model 131, 13 mm, Fixed.

ward. It could be changed if need be from one side to another.

When the bolt was locked to the barrel, as in battery, it required more energy than most individuals possessed to pull the action back against both the driving and barrel springs until the rotary locking ring released the bolt. This made necessary a hand-charging arrangement, so constructed as to give the gunner great mechanical advantage when performing this act.

A metal disintegrating push-out-type link belt was always employed in getting ammunition to the feedway. No provision was made for single shots with this weapon. When the selector switch was turned on, the result was full automatic fire only. The buffing system was new in relation to earlier models. It used multiple springs in order to dampen the shock and friction by acting as a brake shoe upon a sleeve which is locked to the receiver.

The mechanical safety device took the form of a lever which rotated the sear lock in the path of the sear and also cut off the electrical detonating current. Ahead of the stationary receiver there was housed the barrel return mechanism, which in addition to the heavy ring spring comprised a rotating locking sleeve and a coupling device between the barrel and breech. The rear end of the receiver contained the bolt and driving spring.

The ammunition feed system indexed each round half by recoil and then completed the operation by counter-recoil. Two sets of rollers

in the cover group engaged ramps machined along the top of the bolt. When feeding from left to right, the bolt being in recoil, the outboard rollers would climb the inclined surface on the bolt and cause the outer feed pawl to index a round into position for stripping. The center pawl meanwhile was extended its full throw to snap behind the next round.

When the bolt started back to battery after having picked up the positioned round from the feedway, it would cam up the inboard set of rollers. This movement retracted the center pawl, moving the incoming round over one half space and at the same time sliding over the outside pawl behind the cartridge. When the cycle was repeated, the recoiling movement of the bolt completely indexed the incoming cartridge which was then chambered by counter recoil. This simple method relieved the bolt of high side loads and resulting friction usually found in track-type feed levering systems.

The MG-131 had Stange's patented locking ring with several added features that, while not original, were somewhat radical in design. For instance, barrel recoil was speeded up by a gas booster, which in turn transmitted energy to the bolt by a pivoting accelerator acting on the under side of the bolt at the instant of unlocking. The barrel, after three-fourths inch of recoil, was held in the retracted position by a sear device that was tripped only after the bolt contacted the barrel, allowing the parts to lock on the way into battery. This permitted the timing

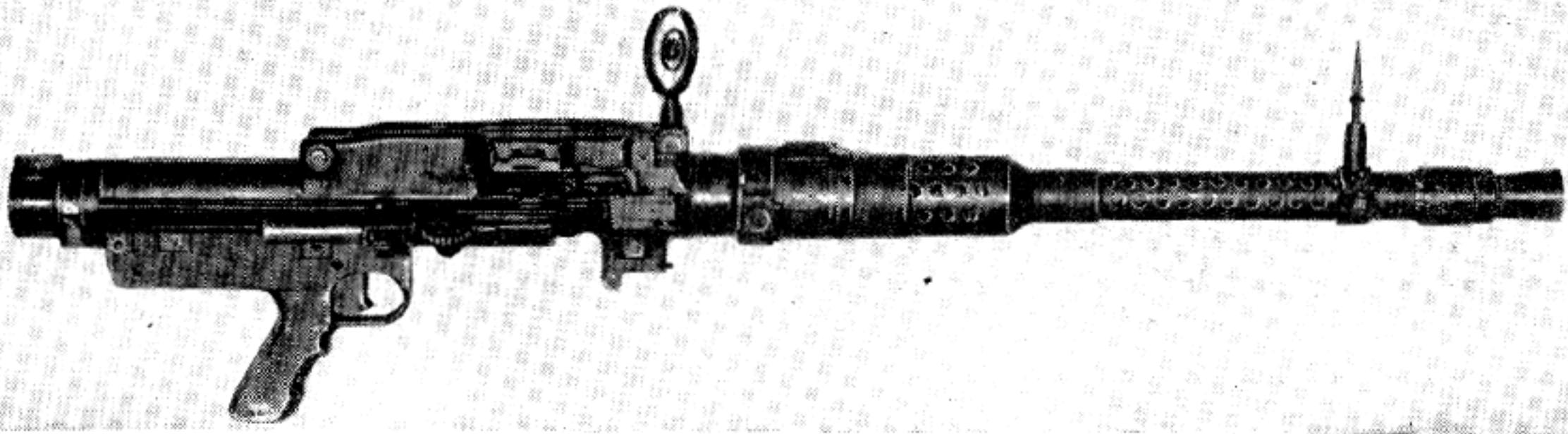

Rheinmetall Aircraft Machine Gun, Model 131, 13 mm, Flexible.

of the firing mechanism whereby the powder charge could be exploded and recoil forces set in a few hundredths of an inch before the fast and heavy moving parts collided with the rear end of the stationary receiver. In high-speed weapons especially, the act of buffering the action on counterrecoil not only insured longer parts life but gave smoother performance.

Another of Stange's typical features on this weapon was that the forward top surface of the bolt was movable up and down and spring loaded so as to remain in the up position. He had noticed that, in order for the incoming round not to interfere with the bolt body when being moved into position, a long bolt stroke was necessary. Sufficient distance was thus given for it to be moved into place after the bolt had recoiled beyond the base of the round in the feeder. The new device permitted a shorter stroke and raised the cyclic rate.

As the bolt, with its pivoted, spring-tension top recoiled, the cartridge was indexed in the stripping position and as the movement continued, the top came in contact with the underside of the cartridge case to depress the pivoting surface of the bolt. It slid easily under the round and as soon as the bolt face cleared the rim of the cartridge, the spring snapped the front part of the bolt face up to push the base of the cartridge out of the link.

Ammunition for the MG-131 consisted of either high-capacity explosive bullets or armor-piercing ones containing incendiary or tracer elements in the base. The explosive bullet had a supersensitive impact fuze that was completely bore-safe. The armor-piercing bullet was unusual in that it employed a rotating band and

the tungsten-hardened projectile was not enveloped in a gilding metal jacket.

The German Air Force held the MG-131 in high regard. At the outbreak of the war, when its fighters found themselves with only 7.92-mm guns attacking British bombers armed with Browning caliber .30, the situation called for immediate installation of the high-speed 13-mm weapon in all attack planes. Eventually it too became obsolete from the trend to automatic weapons of even higher cyclic rates, capable of firing a shell with considerably more bursting charge.

The MG-131 was produced for the German Luftwaffe by these firms: Rheinmetall-Borsig, of Berlin; Deutsche Waffen- und Munitionsfabrik A.G., Posen; I. C. Wagner, Muhlhausen; and Heinrich Krieghoff Waffenfabrik, Suhl.

To fire the weapon, the gunner first positions a loaded belt in the feedway and, if it is to be manually operated, jacks the ratchet-type cocking handle back  $8\frac{1}{2}$  strokes until the rear sear engages its recess in the bottom of the bolt. By actuating the solenoid, the sear is disengaged and the operating parts sent forward by the driving spring. The pivoting member on top of the bolt strikes the indexed round, driving it into the chamber. The bolt assembly, moving forward, contacts the barrel and a camming angle on the left side of the bolt engages the barrel release catch, forcing it down. Upon being freed, the whole assembly starts toward battery under tension from the heavy barrel return spring, and the bolt and barrel are locked together as the locking ring is rotated one-quarter turn clockwise.

On the right side of the receiver near the breech end of the barrel is an electric switch. It energizes the circuit when the whole counter-recoiling mass is one-sixteenth inch out of battery. The weapon then fires and recoil forces start in before the bolt and barrel strike the receiver. With the building up of the peak powder pressure and for a half inch of free travel during recoil, the bolt and barrel continue rearward as one unit. The lugs in the receiver then rotate the locking ring a quarter turn counterclockwise and unlock the recoiling parts. The barrel hold-back device is thereby forced out, retaining the barrel in its retracted position.

Coincidental with the unlocking, a pivoting accelerator located in front of the bolt transmits the energy of the recoiling barrel to the bolt face and speeds this part to the rear.

After initial extraction, the extractor withdraws and holds the loosened round until, upon contact with the ejector, it is kicked through the bottom of the receiver. The bolt continues towards its rear buffer. The recoil feeds a cartridge over one-half space, and in counterrecoil it is completely indexed. The driving spring, now being fully compressed, throws the bolt into counterrecoil, and as long as the solenoid is energized, the cycle of operation is repeated.

## SCOTTI MACHINE GUNS

In 1928 there appeared the first of a series of machine guns by an Italian designer named Alfredo Scotti, who maintained offices in Brescia, Italy. In practicing his profession, Scotti always depended upon companies with manufacturing facilities to make and promote the sale of his weapons on a contract and royalty basis. His place in design history rests upon the exploitation of a single principle or system. In itself, it was not original, being based solely on the act of unlocking by rearward movement of a gas piston at a time when a high enough residual pressure remained in the chamber to complete the cycle of operation. While automatic firing mechanisms bearing the name of Scotti range from pocket pistols to cannon, they all have the rotating bolt head actuated by a gas piston.

A number of firms have been associated with weapons designed by Scotti. The Grandi Co., located at Solbiate, Italy, near Milan, manufactured many models for test including sub- and light machine guns and a 20-mm cannon. The Ansaldo firm in Italy produced a light machine gun and a 37-mm automatic cannon that was entered without success in an Italian Navy test in 1931. The main producer of Scotti's models was the Isotta-Fraschini Co., Italy's largest automobile and aircraft engine manufacturer. It fabricated one or more models of 30-mm cannon and several aircraft machine guns ranging in

bore from 6.5 to 12.7 millimeters. Guns made by this company in 7.7 and 12.7 millimeters were used to a limited degree by the Italian Air Force throughout World War II.

Scotti's activities were by no means confined to his native land. To handle the manufacture and sale of his weapons in all countries outside of Italy, he established Scotti-Zürich, a firm in Zürich, Switzerland. Some of the main components for these guns were made by the Swiss firm, Oerlikon, while lesser ones were obtained by contract from the Swiss Industrial Society at Neuhausen. In November 1932, Oerlikon purchased outright Scotti-Zürich, including all foreign rights to Scotti-type guns. Italian rights were reserved by Isotta-Fraschini.

The only variations in Scotti guns were in size and external appearance. The most radical of his designs on record was his triple-barrel machine gun, made in bores of 6.5 to 8 millimeters. It employed a handle to rotate a fresh barrel into position, thereby allowing the gunner to keep up continuous fire by having a cool barrel available at all times. While this may have seemed very original to Scotti and he was given a patent on it, both he and the patent researchers must never have seen the specifications of the hand-operated Lowell gun, recorded in the United States in 1875.

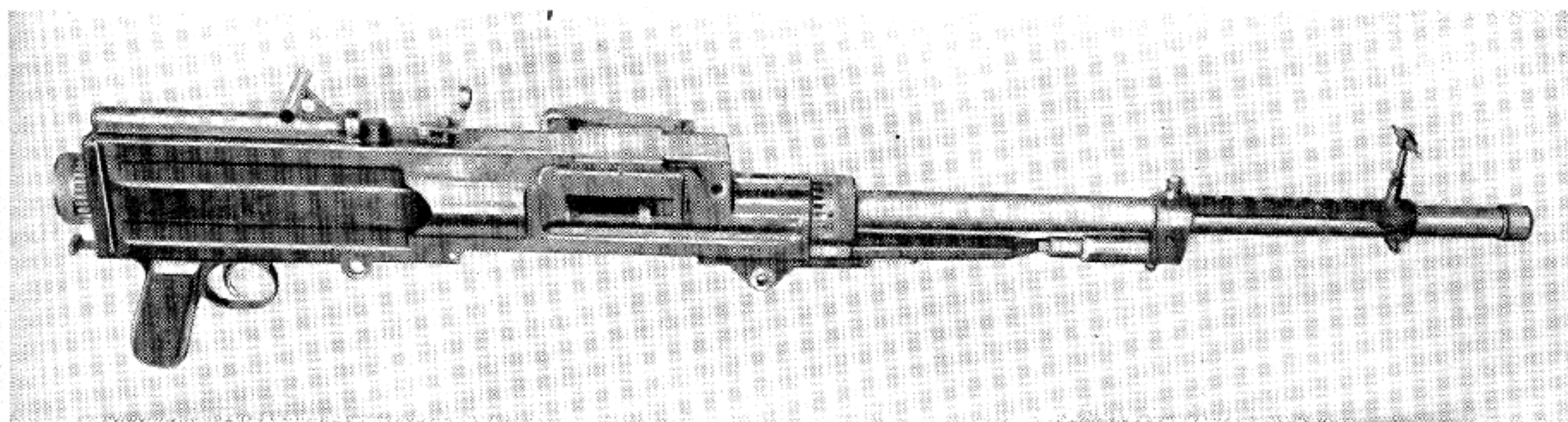

Scotti Aircraft Machine Gun, 7.7 mm.

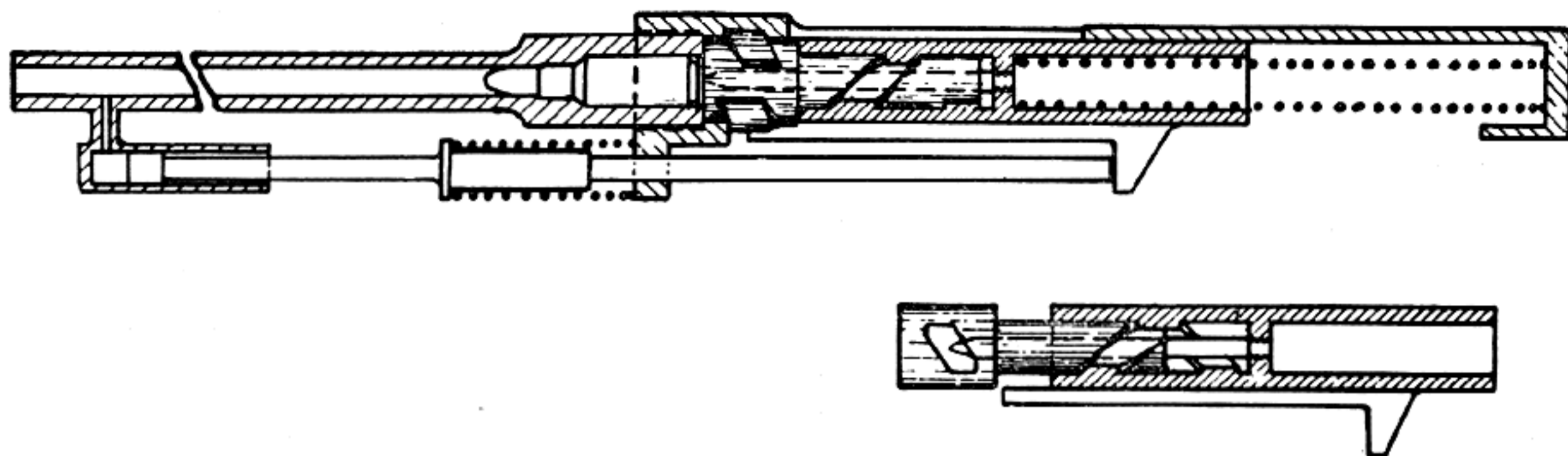

Drawing of Scotti's Action. Top: Bolt in Battery and Locked. Slide in Forward Position to Prevent Bolt Head from Rotating. Bottom: Slide Retracted by Gas Piston, Allowing Bolt Head to Rotate and Unlock.

On one model Scotti used a feed system that had been patented previously by another Italian, Giuseppe Perino, in 1901. This method of feeding was accomplished by a metal strip housing each cartridge individually. The bolt pushed the loaded cartridge out of its housing and after being fired, replaced it in its original position on recoil stroke. The metal clip was indexed over one space after each shot and was ejected completely out of the right side when the last round was fired.

To fire any weapon of the Scotti system, the operator installs a loaded belt, strip, or drum, as the case may be, and pulls the firing mechanism to the rear by the charging handle. This first movement unlocks the bolt and retracts the firing pin. The assembly is held in the cocked position under tension of the compressed driving spring. By actuating the trigger, the sear is released and the bolt starts home, stripping a round out of the feedway, and pushing it ahead as the two-piece bolt starts into the last phase of chambering the round. Lugs on the forward part

engage cams in the barrel extension, giving the bolt head a fraction of a revolution turn and locking the barrel and bolt head together.

The firing pin is housed inside the bolt and is attached to slides that, upon removal of the obstructing lugs, are forced forward by both inertia and driving-spring pressure. The firing pin is directed into the primer which detonates the propellant charge. When the projectile passes a port in the barrel, sufficient gas is bled into a cylinder that houses the gas piston. This closely metered gas gives the piston a slow backward thrust movement at just the right instant to permit contiguous slides to move rearward, allowing the bolt head to rotate while a high residual pressure remains in the bore.

The locking lugs being inclined at an angle of  $60^\circ$  make unlocking require little energy, as the gas pressure acting on the face of the bolt would rotate the lugs and unlock were they not covered by the slides. The latter having retracted the attached firing pin, the whole mechanism starts to the rear, with the operational force now

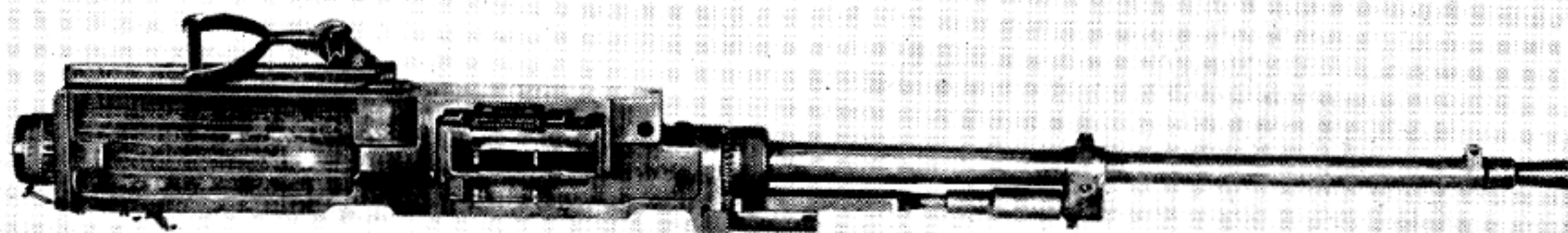

Scotti Aircraft Machine Gun, 12.7 mm.

coming from the remaining gas, or blow-back. The empty lubricated cartridge case, being held to the bolt face by the extractor, slips back with the recoiling bolt and is pivoted out of the receiver upon making contact with the ejector.

The bolt continues to recoil until stopped by contact with its spring-loaded buffer and compressed driving spring. If the trigger continues to be depressed, it then starts on its counter-recoil stroke to repeat the cycle of operation. Release of the trigger pressure causes the sear to rise and engage the recess in the rear of the bolt, holding the entire bolt assembly to the rear.

While this action was undoubtedly retarded blow-back, it should not be confused with other methods, particularly of Italian origin, where the whole bolt assembly creeps rearward at the instant of firing and opens up progressively afterwards. The Scotti principle positively locked the bolt and barrel together and the gas bled into the cylinder was for the purpose of unlocking only. This system most certainly was not new, as Mannlicher used it successfully and patented it in 1899, even to the rotating bolt head for unlocking. However, Scotti gave it greater use, as he employed it in everything from hand gun to cannon.

## BANG AIRCRAFT MACHINE GUN

The Danish Rifle Syndicate of Copenhagen, Denmark, in 1929 formed a company to produce a caliber .276 flexible aircraft machine gun to be known as the Bang. The weapon was the invention of Soren Hansen Bang, an employee of the Syndicate. It used a method of capping the muzzle with a cone-shaped device.

This system was by no means new, having been patented by Sir Hiram Maxim and used successfully by John M. Browning on his first experimental model in 1889. Its main drawback was that it demanded many clumsy accessories to accomplish very little. Even the preliminary operation was only begun well after the bullet left the bore, which made the method notoriously slow. After one working model was constructed and factory tested, the project was dropped. There is no record of another of the Bang aircraft machine guns being made.

The method of firing the weapon is as follows:

After a loaded magazine is put in place and the action charged, a pull on the trigger fires the piece. The bolt remains securely locked behind the base of the cartridge until the bullet leaves the bore. The muzzle has a cone-shaped device that can slide parallel with the barrel and is attached by means of rods to the locking system. The expanding gases are trapped in the cone after the bullet is clear. This sudden explosion in the cone jerks it forward and, in doing so, unlocks the breech.

Helical cuts on the inner surface of the receiver act as opposing angles on the bolt and rotate the bolt out of the locked position. It is then accelerated in recoil by the trapped gas pressure acting on the base of the cartridge driving the bolt assembly to the rear at high speed. The compression of an unusually stout driving spring absorbs all surplus energy and puts the operating parts in counterrecoil.

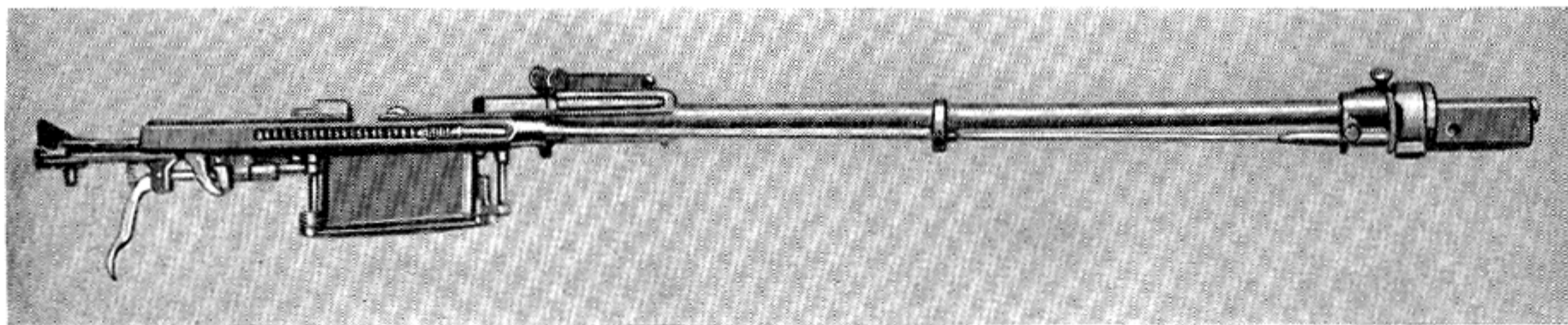

Bang Aircraft Machine Gun, Cal. .276.



## SISTAR MACHINE GUN

On 3 December 1932 there was filed in the Italian patent office an application covering the design of a recoil-operated machine gun, which, according to its inventor, Niccolo Mancini, of Florence, Italy, was a decided improvement on existing automatic firing mechanisms.

Not having the financial means to exploit his invention, he placed it with the Sistar Co. in Florence. Sistar actually was not a producing organization but a promotion and design firm which specialized in developing and financing likely looking patents. By this business connection, Mancini gained all the prestige needed to

call on interested parties. He was made president of Sistar's machine gun section, a title that no doubt was more impressive than the salary.

Demonstration machine guns were produced, both in light and heavy models. While the operating mechanisms were identical, the two types varied in the following characteristics. The light gun chambered the 6.5-mm infantry rifle cartridge; the heavy the 7.92-mm Mauser type. The light gun with its 22 pounds was half the weight of the latter, and the rate of fire was 700 rounds a minute on the small weapon and 500 on the other. The magazine on the lightweight

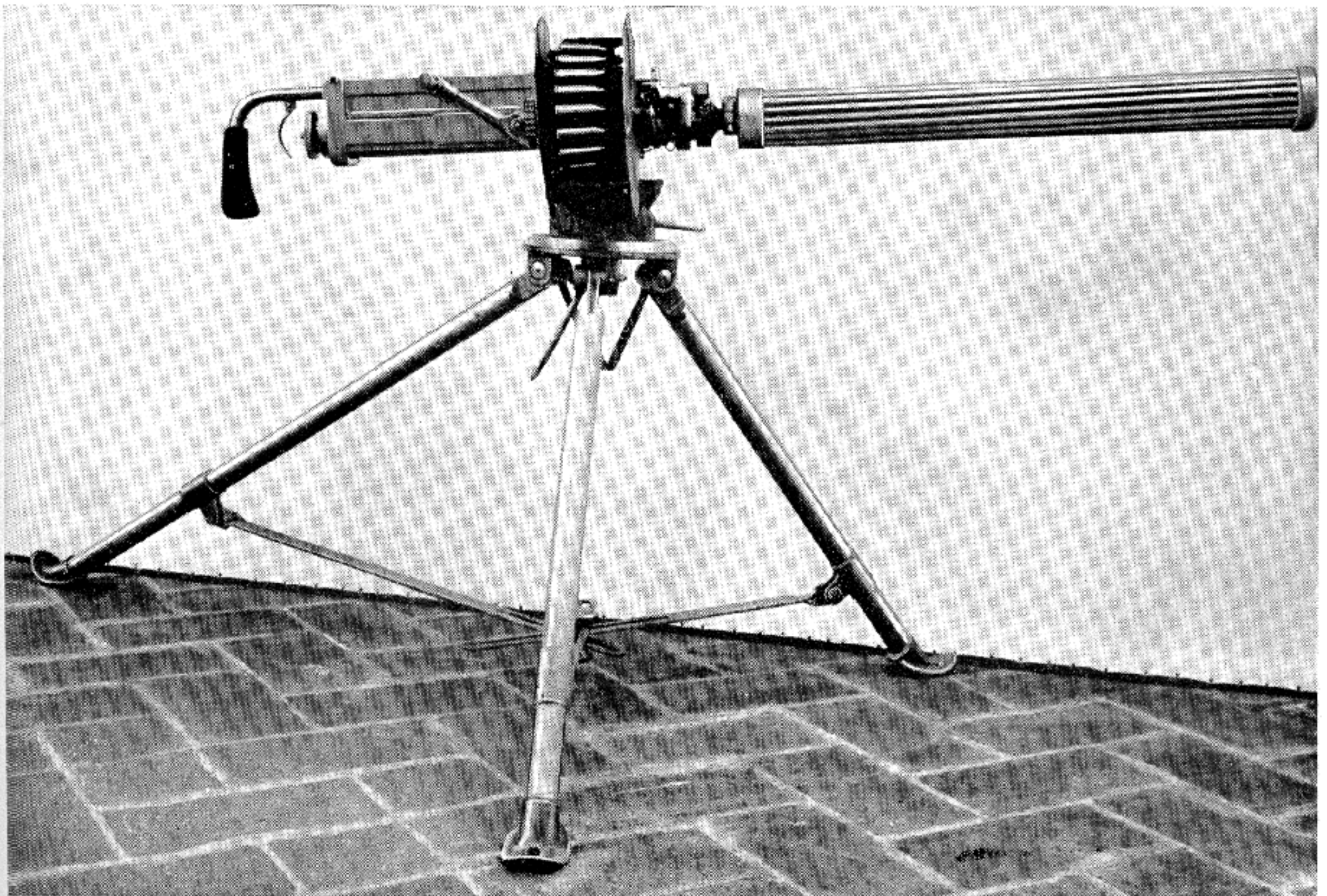

Sistar Heavy Machine Gun, 7.92 mm.



Sistar Light Machine Gun, 6.5 mm. The Operator Is Loading the Magazine.

version held 20 rounds, while the other utilized a semi-rigid metal belt holding 250 rounds wound on a drum.

The light machine gun, while having only a 20-shot magazine, did have a feature that the company made great effort to demonstrate on every occasion. The gunner, without rising, could pivot the swinging magazine forward from the prone position and insert in a matter of seconds a fresh supply of loaded rounds directly from the cardboard container into the feed system. By this ease and speed in loading he could keep up practically uninterrupted fire.

The weapon was recoil operated, the barrel having an open jacket that gave it support and a bearing for "floating" the recoiling parts. The barrel return spring was housed inside this skeletonized jacket. A large charging and carrying handle was located on the left side considerably forward of the usual placement of retracting assemblies. The trigger was placed underneath and slightly to the right. However, the customary guard, to protect it from accidentally striking some object and discharging the piece unintentionally, was omitted.

The recoiling parts were housed completely in a boxlike receiver on the top of which was a graduated sight. Air cooling was provided by circular fins machined along the barrel to give greater surface for heat radiation.

A built-in oil pump on the left side of the receiver sprayed a small jet of oil on the incoming rounds as each was positioned for chambering. This device was actuated by the recoil counter-recoil movement of the barrel extension.

The heavy machine gun had identical operating parts, but most certainly did not resemble the lighter gun in any other way. Its cooling was by air, but the barrel housing resembled the conventional water-cooled jacket. Long aluminum tubes grouped around the barrel were supposed to dissipate heat more efficiently. The 7.92-mm ammunition was fed to the weapon in a belt using push-out-type links, also originated and patented by the inventor of the gun. A clumsy looking handle with unprotected trigger was used on this heavy Sistar machine gun.

Both versions appeared only in prototype form. While many of the principles have later been proved sound, especially the locking method, apparently nothing was ever done to develop either one. There is no record of any extensive test conducted either by the factory or the government. Consequently, it had a very short-lived competitive existence.

To fire the lightweight 6.5-mm gun, the operator first assumes the prone position and with his right hand releases the catch allowing the swinging magazine to pivot forward. This leaves



Sistar Light Machine Gun, 6.5 mm. The Operator Is Charging the Weapon.

The rear part open for inserting the front end of the 20-round cardboard cartridge container. After positioning it in the magazine mouth, finger pressure forward shoves the cartridges from the box into the spring-loaded magazine. When filled, the empty container is then thrown aside and the loaded magazine is swung back and latched securely in the ready position.

The operator then grasps the barrel retractor with his left hand and the bolt charging handle with his right, and simultaneously pulls both fully rearward. This unlocks the piece and compresses the driving spring. Upon being released at the rear the bolt assembly goes forward to battery while stripping a round from the magazine, chambering it and locking the piece for firing.

With the safety off, pressure is put on the trigger and the striker flies forward under spring compression to ignite the primer. As the powder gases are reaching peak pressure with the bullet still in the bore, the barrel, bolt, and barrel extension are securely locked and continue to be

for a travel slightly over a half inch. The breech lock, pinned to the recoiling barrel extension, then rides up a ramp machined in the top of the stationary receiver. The end of the breech lock is pivoted up, unlocking the bolt and allowing it to continue rearward free of the other recoiling parts. The barrel driven by its strong spring returns to battery. This gradual freeing of the bolt allows the extractor to pull the empty case free, insuring initial extraction of the fired case before complete unlocking gives it a snatching movement.

The bolt, continuing rearward, carries the empty case held in position by the extractor until the base of the cartridge case strikes the ejector. The latter pivots and kicks it out of the ejection slot on the left side.

The bolt, at its rearmost position, compresses its spring buffer and then is driven forward. The rebound off the buffer, in conjunction with the driving spring, located in a housing offset to the left of the operating parts, starts counterrecoil. As the bolt face passes the mouth of the maga-

zine, it pushes the indexed round ahead of it into the guide way of the chamber. The firing pin assembly at this point has been traveling with the bolt as a unit, but at a distance of  $1\frac{3}{4}$  inches out of battery a spring-loaded sear located on the back of the breech lock lever engages the front face of the striker housing, holding it back while the bolt continues to go on into battery.

At this point, if the trigger button is still depressed, the breech lock in reaching its recess pivots down in front, securely locking the barrel, barrel extension, and bolt together at the same time. The sear on the back of the breech lock lever is raised, freeing the firing pin it has been holding in the cocked position. The pin flies forward and again fires the piece. If trigger tension is not applied, the breech lock will still release the firing pin but instead of flying all the way forward it will merely snap forward a few thousandths of an inch and come to rest on the

trigger sear. Further actuation of the trigger is needed to release it.

The United States Government in 1935, upon hearing from officials of the Sistar Co. of the various advantages this machine gun had over others, requested its attachés to report on the performance of the gun and what it had to offer. Upon investigation it was found that the Sistar firm as a manufacturer was non-existent and that the few models that were then being used for limited demonstration were produced by hand in various job shops. All available models at the time were in Rome where they were being given consideration by the Italian Government for purposes of adoption.

Italian authorities, however, did not see fit to produce this weapon for either air or ground use, and it never got beyond the prototype stage in development. The army, with its partiality to the retarded blow-back system, held in disfavor the Sistar's straight-recoil operation.

## KNORR-BREMSE MACHINE GUN

Swedish military authorities, upon becoming interested in a strangely designed machine gun, invented by Hans Lauf of Charlottenburg, Germany, had their government small arms factory manufacture the weapon for testing purposes in 1933. Lauf, in presenting it, described it as a gas-pressure-operated machine gun and made many claims for the unusual contrivance. The inventor was well known in the gun world and at the time was a director of the Knorr-Bremse Manufacturing Co. of Lichtenberg, Germany. However, since the Swedes showed initial interest, he permitted them to manufacture the first models with the understanding that, if adopted, he would receive royalties.

These Swedish-made weapons were given the designation L. H. 33, the markings probably being specified by Lauf to include the initials of his name and the year produced. After extensive trials the authorities did not see fit to adopt the weapon and Lauf turned to the Knorr-Bremse company to produce and promote it commercially.

The firm made a limited number and Lauf bent every effort to interest representatives of

many countries, giving personal demonstrations in each instance at the Knorr-Bremse firing range at Tegel to show off the good features claimed for the gun. The weapons made by the German company were officially labeled Knorr-Bremse 35/36. Those who witnessed Lauf's firing demonstrations failed to observe any features so outstanding as to warrant more investigation. The design was by no means revolutionary nor did it contribute a performance superior to that of the many tried and proved weapons of the time.

The barrel on this gun was very short and, due to this fact, even when an oversize flash hider was employed, it still had enough brilliant flame at the muzzle to impair aiming. The balance of the weapon was exceedingly poor and the absence of a wooden forearm made it impossible to discharge the piece in any other way than in the prone position with the use of a bipod because of the heat. The excessive length of the heavy stock also resulted in an undesirable distance to the rear sight.

Firing from a cocked-bolt position, with the mechanism being held back by an unusually strong spring that was supposed to help dampen

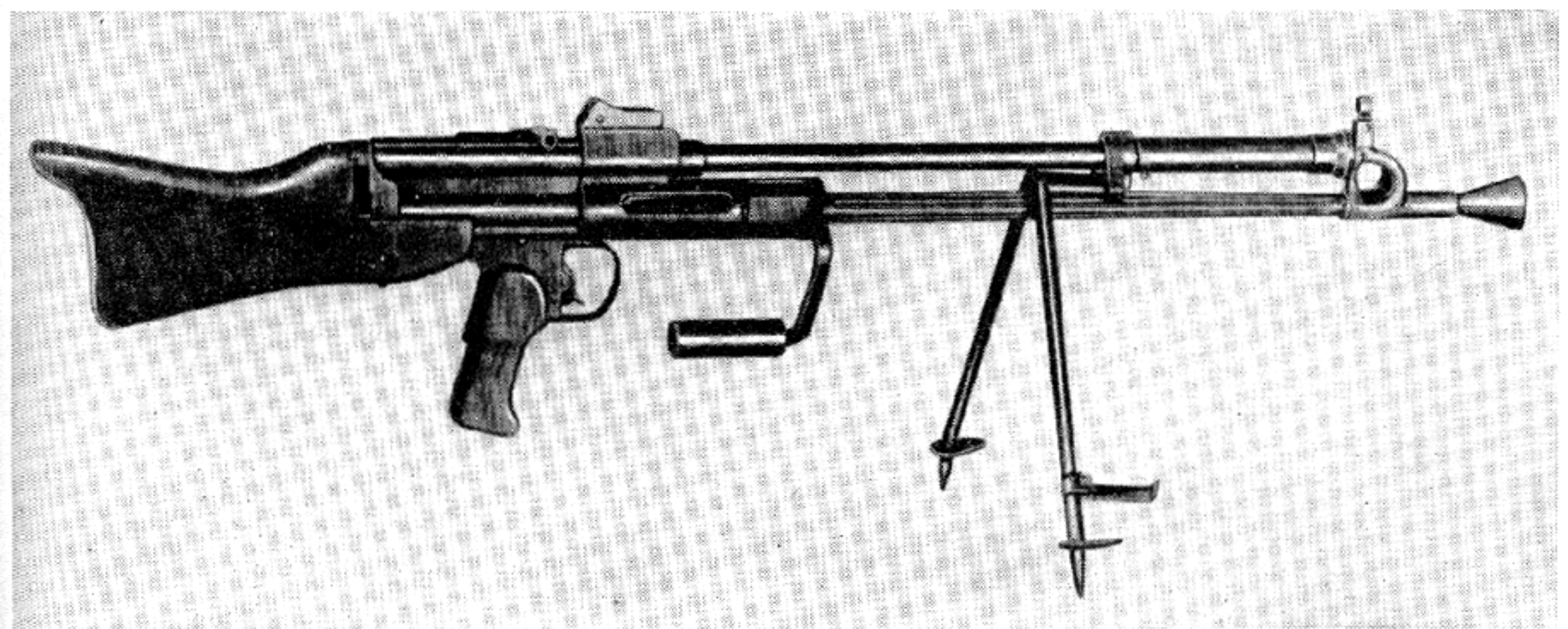

Knorr-Bremse Machine Gun, Model 1933, 7.92 mm.

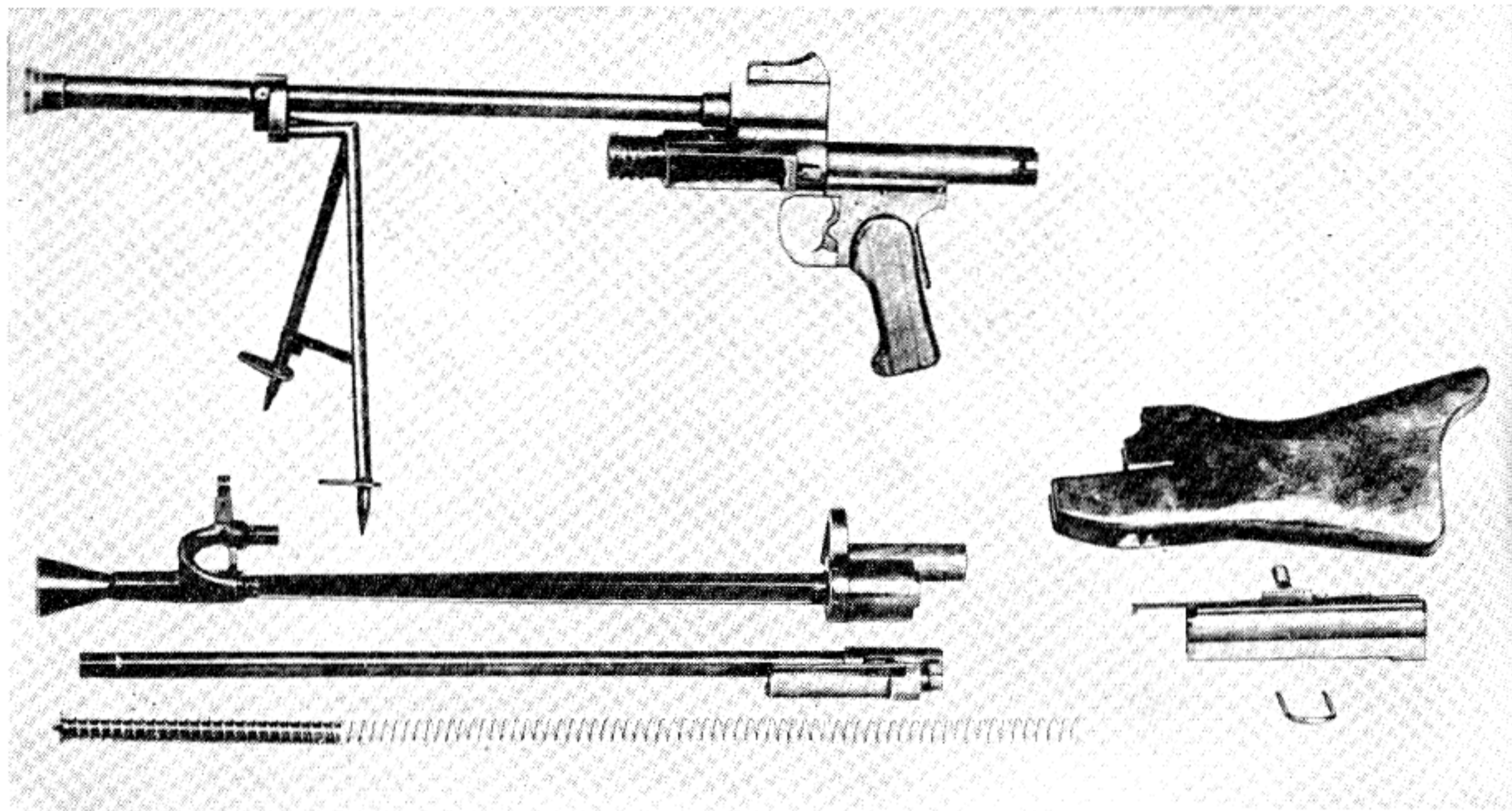

Components of the Knorr-Bremse Machine Gun, Model 1933.

recoil, made the gun lurch forward each time the action slammed home on single shots, with a natural destruction of accuracy. And while the barrel could be changed rapidly, the machined clearances on its components, that had to be removed first to make this change possible, resulted in considerable gas leakage.

The 25-shot magazine, when filled and inserted into the left side of the gun, made the weapon "left-heavy," and threw the gunner's aim off during first stages of automatic fire.

On the favorable side, a very novel feature was that by merely pulling the trigger at its top portion it could be changed from single shot to automatic fire. This piece was pivoted in the center and its depression at the bottom resulted in a full automatic burst. The cost of manufacturing the components was reasonable due to their simple construction. The barrel had longitudinal ribs that not only gave more rigidity but also furnished more cooling surface for heat dissipation. In the entire assembly there were only 62 components, no tools being required to disassemble or put it back together again. A single spring performed all recoil operation.

The main point of improvement emphasized by the inventor and one that, according to wit-

nesses of the demonstrations, was practically useless was the unique method of getting the gas pressure from the barrel without tapping it, as was customarily done by all weapons that operated by the forces of the still expanding gas.

This device functioned as follows: When the projectile passed through the flared-out portion at the muzzle, the gases entered a trombone-shaped nozzle and exerted considerable pressure on the gas piston which was thrust evenly to the rear, unlocking the bolt from the barrel and shoving it to its full recoil position.

Lauf's only new feature was to entrap at the muzzle end the gas that was shoving the bullet through the bore. It was then used to operate his mechanism in the manner employed by numerous other actions powered by the forces of expanding gas. He was forced to use an unusually short barrel in order to have high enough residual pressure to operate the mechanism after waiting for the projectile to clear the muzzle.

The safety located at the rear of the pistol grip handle was the squeeze type commonly found on automatic pistols.

While the German Army was not even mildly interested in this peculiar gun, it did get desperate enough for automatic weapons during

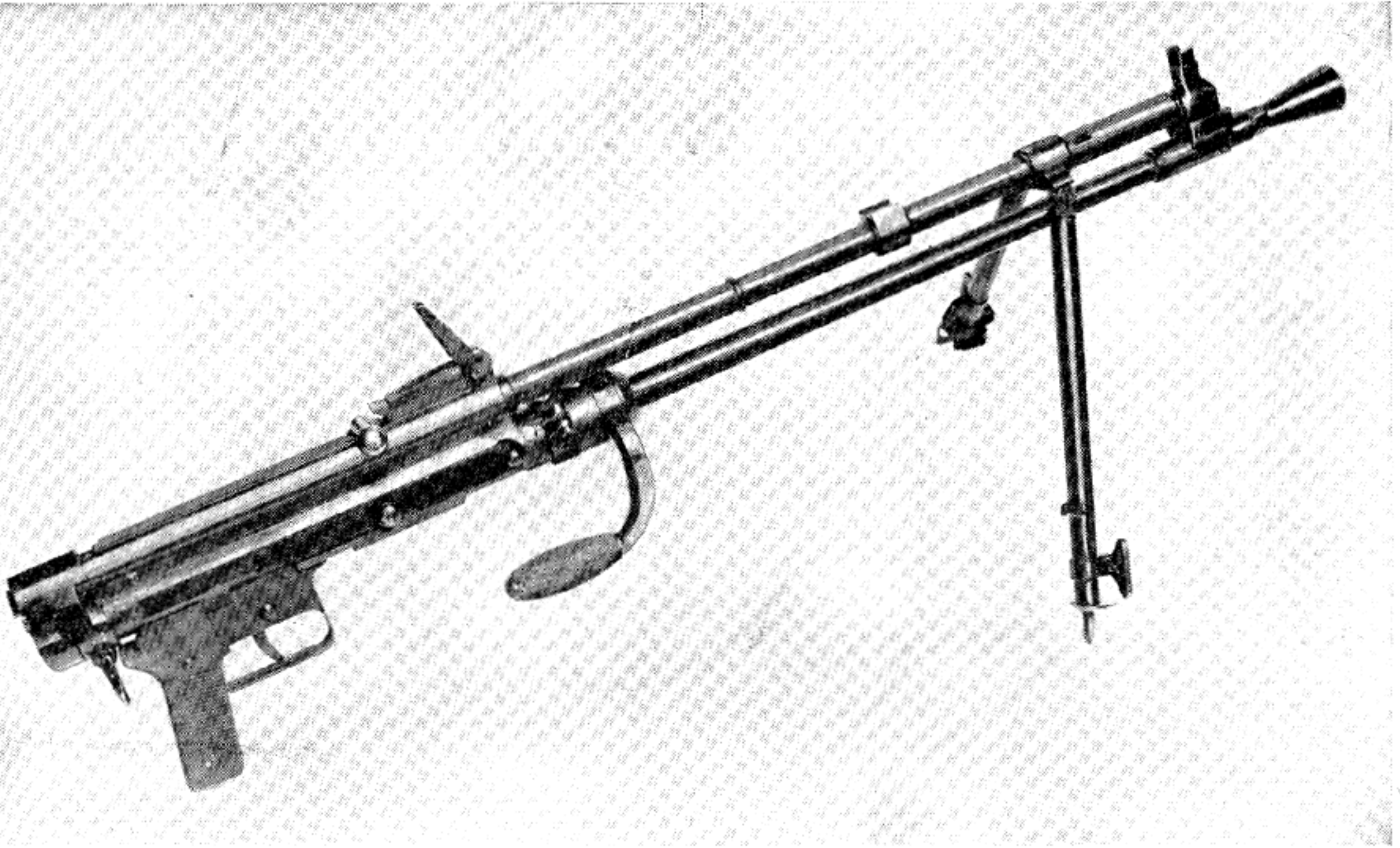

Knorr-Bremse Machine Gun, Model 35/36, 7.92 mm.

World War II to manufacture a limited number for its ally, Finland, which reportedly had also bought the few that were made up by the Swedish Government. All known models were chambered for the 7.92-mm German infantry rifle cartridge.

The Knorr-Bremse company also had under construction an automatic 20-mm cannon built on the Hans Lauf principle but like the others it did not get much beyond the prototype, or limited use, stage.

To fire the L. II. 33, or the Knorr-Bremse 35/36, the gunner from a prone position inserts a loaded 25-round clip in the left side of the feedway. The retracting handle is then pulled back until the gas piston extension is engaged by the rear sear. The pistol grip is grasped by the right hand to depress the safety and, if automatic fire is desired, the center pivoting trigger is pulled back at the bottom. The bolt connected to the piston extension flies forward under tension from the driving spring, thus stripping the first cartridge from the mouth of the magazine and chambering it.

At the moment of going into battery, the rear

of the bolt arrives directly over a recess in the stationary receiver. This permits the piston extension in continuing forward to actuate a linkage arrangement that forces the back of the bolt down into its locking recess. In doing so, it aligns the firing pin in the bolt with the L-shaped end of the piston extension that on the final forward movement smashes into the protruding firing pin which in turn detonates and fires the cartridge.

The bolt is securely locked to the receiver until the bullet is clear of the bore. The greatly reduced gas pressure is now diverted by means of a large trombone-shaped pipe that, by use of its reduced force, evenly thrusts the gas piston rearward. Its first movement breaks the link and the end of the bolt is then lifted up out of engagement with its locking recess. It starts to recoil as the extractor first pulls the empty cartridge from the chamber and then holds it until the ejector pivots the used case out through the slot cut in the right side of the receiver. At the end of its recoil movement under energy of the compressed driving spring, the action starts in counterrecoil movement to repeat the operation.

# MAUSER MACHINE GUNS

## Background

Very few arms companies have been as influential in world affairs as the Waffenfabrik Mauser A. G. from the date of its inception in 1871 until the end of World War II. At its very beginning Mauser products were used by the German Government to disseminate German beliefs. The authorities of that country recognized that by arming soldiers and police of smaller countries, it could also influence greatly their military way of thinking.

The company was organized by and named for Paul Mauser, who devoted his life to the invention and development of all kinds of weapons in the interest of his fatherland. The youngest of 13 children, he was born on 27 June 1838 at Oberndorf, Germany. His father, Andreas Mauser, was himself a master gunsmith in the Government arms factory at Oberndorf. At 12 years of age, Paul was already an apprentice gunsmith. After completing his schooling, he and several of his brothers were well established as craftsmen in weapon construction.

Europe, as usual, was on the verge of a war and young Mauser was called up for military duty in 1859. At this time he so impressed his officers that he was immediately placed on inactive status and given a responsible position in the Royal Fire Arms Factory at Oberndorf, where he might turn his creative talents to good ends. It was here that he developed his famous bolt-action rifle that was to become the design pattern for practically every military power in the world. And here he organized the company that bears his name.

It is not generally known that the first patent to be applied for by Mauser on his rifle was sought from the United States Patent Office. The rifle was followed by numerous other inventions that included many types of semiautomatic actions. They were later to be copied and modified

into full automatic mechanisms by arms designers in every corner of the world. These superb small arms, both bolt-action and semiautomatic, made the name Mauser synonymous with ordnance of exceptional quality. His conception and development of this type of armament brought him fame and fortune, and his government a chance to rise in military strength. Mauser died in 1914 as his country stood ready to challenge the power of the rest of the world.

After the war, the Allies occupied the country with a commission established in order to limit the ability of the German arms companies to produce for military use the many automatic weapons that had proved so deadly. The Mauser Co. continued in existence and it was hurt least of all by the occupation forces, since its factories turned out mainly rifles and semiautomatic pistols.

The large machine gun producing plant of Deutsche Waffen- und Munitions-Fabriken (D. W. M.), with which the Mauser Co. often contracted, was completely dismantled and the latter firm was allowed to acquire its patent assignments. Among them were the Luger pistol and the many improvements by Karl Heine-mann on the Maxim machine gun, then known by the D. W. M. code name of Parabellum. The company was not permitted to manufacture the Parabellum because of the Versailles Treaty and therefore, in order to remain solvent, an output of sporting guns and general small arms was manufactured commercially until 1934 when Germany, under the Hitler regime, openly began to rearm.

The Nazi high command, realizing the potentialities of the great Mauser organization, started at once to recruit talent and make a loan necessary for maximum production. In this manner the Waffenfabrik Mauser A. G. was officially launched in an all-out race for arms supremacy.



## MG-34

Its first effort was in the field of rifle caliber machine guns. A pressing need at that time was for a single machine gun using the 7.92-mm rifle cartridge, which would incorporate in it all the special features of modern weapons. It should be capable of use as both a light and heavy machine gun and, if need be, for antiaircraft work against low flying attack planes. The basic design for the weapon was sent to Mauser from Berlin and was the further development of a mechanism patented by Louis Stange, an engineer of Rheinmetall-Borsig. The specifications further stated the weapon must feed from both left and right and be fed by either drum or belt.

The weapon conceived by the officials in Berlin was the last word in machine gun design and eliminated the locking ring. In lieu of this system they recommended a rotating bolt head, the origin of which has been credited to Paul Mauser, Ferdinand Mannlicher, and even Alfredo Scotti. True, Mauser, at a much earlier date, successfully used a bolt that locked in a somewhat similar manner but for energy after unlocking by recoil forces he resorted to the high residual pressure in the chamber to give him the needed power to complete the cycle of operation. Mannlicher and Scotti used a gas piston both to actuate and unlock the operating mechanism. Stange's method, applied to the new weapon, differed inasmuch as it unlocked by re-

coil and used barrel energy and an accelerator to speed the bolt action to the rear.

The bolt body was first accelerated when the unlocking cams were engaged. On release of the bolt head, the rear portion of the two-piece bolt traveling at a high speed pulled the front piece with it. A closely calculated distance for unlocking, which utilized the safe but very high chamber pressure then being exerted on the face of the bolt, further added to the rate of fire. The pressure and recoil forces were both abetted by the muzzle booster that fitted over the end of the barrel. The booster not only held the high gas pressure after the bullet had cleared, but made it do double work by bringing it to bear on the barrel face for additional rearward thrust of the recoiling parts.

The result of Mauser's development of this method of operation was called officially the MG-34. It represented not so much a departure from conventional design as it did the sensible application of many well-established principles in the design of this most efficient machine gun. For instance, the muzzle booster was so constructed that it served as a flash hider and front barrel bearing as well as a gas trap.

Few machine guns on first appearance showed as much refinement as did the MG-34. The German high command evidently was greatly impressed as it was adopted in short order. Although development was not begun until 1934, it was put into production in 1936. Its most de-

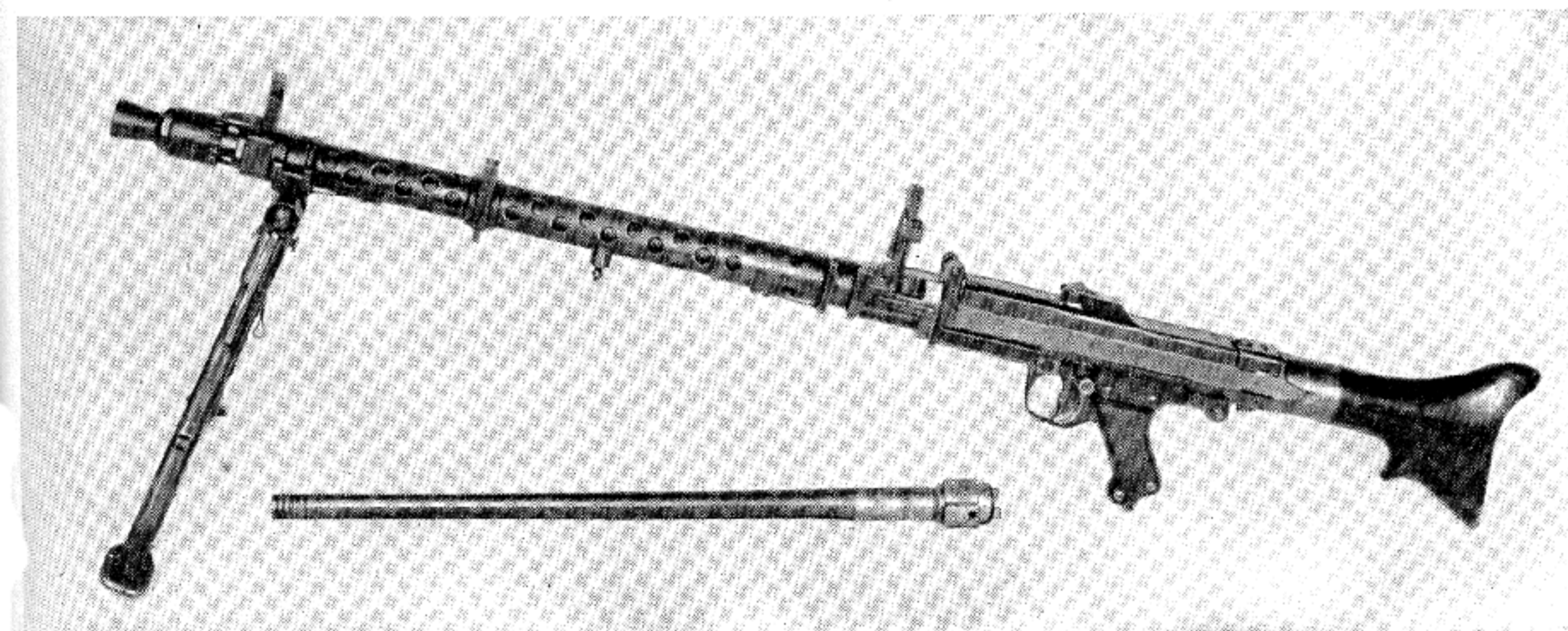

Mauser Machine Gun, Model 1934, 7.92 mm.

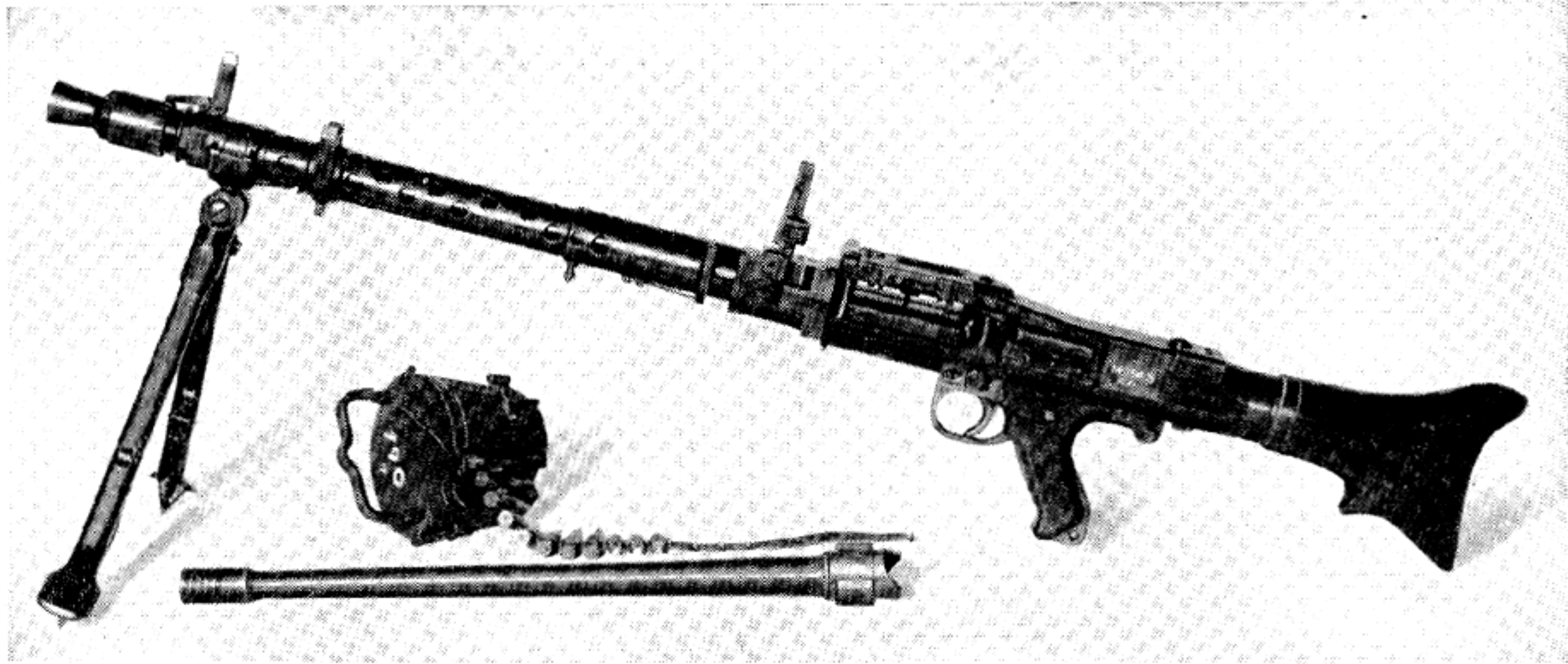

Mauser Machine Gun, Model 1934 S, 7.92 mm.

sirable feature was that, even with a high rate of fire, the straight-line action did not jar or impede the gunner's aim. The weapon was nearly as accurate as an infantry rifle when fired single shot.

The MG-34 soon became the standard machine gun of the German Army. It was mounted for light machine gun work with a bipod and for heavy duty with a tripod that could raise it to a high enough position to make it readily adaptable for anti-aircraft use. A dual mount was also made at a later date whereby two weapons could be operated by a single soldier and, although designed for anti-aircraft use, it could and often was employed by armored vehicles.

The MG-34 can be described as being an air-cooled, rear-loaded, short-recoil-operated, belt- or drum-fed, dual-purpose light machine gun, chambered for the 7.92-mm rifle cartridge.

It normally employed a nondisintegrating push-out type metal link belt, which came packed in 50-round lengths. It was common practice in the field for the gunner's helper to clip as many as five such belts together. At the beginning of each one there protruded a small rectangular tongue, while the last link contained a matching hole. To join as many belts as needed, the tongue of one was merely passed through the hole in the last link of another until a small projection in the tongue snapped into place, joining the whole assembly together. The belted round then made

it impossible for the links to separate until the cartridge was removed. In certain field operations necessitating rapid movement, a 50-shot drum was often employed. The magazine fitted against the left side of the receiver and was loaded with a single 50-round belt.

To insure against firing out of battery, a mechanical device, located on the right side of the breech lock, serves as an obstruction to the cocked firing pin. It can be removed only by a short sloping face beneath the front end of the bolt carrier camming it down after the barrel and bolt are locked together. To avoid rebound of the bolt assembly, a spring-loaded catch is fastened at the rear end of the barrel extension in the path of the outer roller on the bolt head. The piece is depressed during locking operations and rises again when the roller passes over it, thus serving as a sort of flexible chock. After the first three-sixteenths inch backward travel of the barrel and bolt, the roller is forced over the catch and only then is the bolt free to unlock.

Another safety that prevents accidental discharge is located in the receiver immediately above the trigger. A relief is cut in it that permits movement of the sear when the lever is in *Fire* position. The sear release is shaped like a pivoting lever and, on *Safe*, it pins the front end of the trigger bar, thereby preventing it from actuating the sear.

The firing pin, housed in the bolt body, is cocked during the recoil movement. It is nested inside its spring under constant slight tension. Full compression on its rearward travel is reached by means of two cam shoulders at the rear end of the bolt head bearing against corresponding shoulders at the front end of the bolt carrier. During the partial rotation movement brought about by unlocking, the carrier is cammed back and the firing-pin spring compressed. At this point the sear engages the notch in the firing pin holding it back and is released by the revolution of the bolt head after the bolt is locked to the barrel. This removes a safety obstruction and at the same time lifts the end of the firing-pin catch, allowing it to be driven forward.

Upon pulling back on the top portion of the trigger, for single fire, the rear end of the lever mounted on the trigger depresses the sear that allows the bolt to go forward. The projection on the bottom of the bolt pushes down a short upper arm of the sear-lever trip; this frees the sear-lever bar to go forward and the sear to rise; thereupon, with the return of the bolt on its recoil stroke, the sear is forced into its recess in the bolt holding it in the cocked position.

When the bottom part of the trigger is pulled, for automatic fire, the sear is depressed and the bolt driven towards battery. Housed in the main body of the trigger is a small auxiliary trigger. Upon being retracted, its projecting lug at the rear is raised above the trigger guide pin, thus permitting further rearward travel of the larger trigger than when firing single shots. Consequently, it is not possible to align the sear with its recess in the bolt and automatic fire results.

The mechanical means by which the push-out type link belt is fed into the gun is housed in the cover group and has a pivoting arm the ribs of which form a groove into which rides a stud located on top of the bolt. A holding pawl under spring tension is mounted in the feed slide and positions itself behind each cartridge with every throw of the slide. Heavy spring-loaded guides press each successive round down into alignment for chambering, with the full indexing movement of the cartridge belt.

When mounting the drum magazine, the feed block must first be removed. The cover group

is provided with an opening that is closed from the weather by hinged flaps when the drum is not in use. Beneath the ejection slot a dust cover (for the protection of operating parts) automatically opens when the trigger is pressed.

The ejector has no spring in its construction, being in the form of a pin housed in the head of the bolt. It has a cut-away portion for its retainer that allows it a longitudinal travel of only three-sixteenths inch. During recoil, when the empty case has been withdrawn the necessary distance, the pin contacts a case-hardened stop on the right side of the receiver body. The empty cartridge is struck by the pin at the top of its base, pivoting and at the same time knocking it down through the ejection slot in the bottom of the receiver.

The weapon was later altered for use in armored vehicles and differed from the parent gun by having a heavier barrel jacket to adapt it to a ball-type mount. It was known as the MG-34 (modified) and was followed by the MG-34-S and MG-34-41, identical in appearance except for the barrel jackets but marked as distinct models. They differed from the original MG-34 in the following points: (1) Full automatic fire only; (2) shorter barrel; (3) a trigger group of simpler construction; (4) a larger buffer; (5) larger muzzles on the barrels to add more surface for booster gas to bear upon; (6) elimination of the firing-pin nut; and (7) minor changes in the feed system.

To fire practically any of the MG-34 machine guns, the operator, if using a drum feed, presses a catch on the drum to slide back the cover. The end of the cartridge belt is pulled out and inserted in the left side of the feedway. The drum is attached to the forward part of the receiver guides, front end first, and the rear pivoted around to the lugs in the feed block. The end of the belt is then pulled to the right until the first round is engaged by the three pawls on the underside of the feed cover. The gun is charged by pulling the cocking handle smartly to the rear as far as it will go, then shoving it forward until the holding detent snaps into its locking recess. The catch on the safety lever is depressed to firing position until the letter *F* (*Fire*) is uncovered.

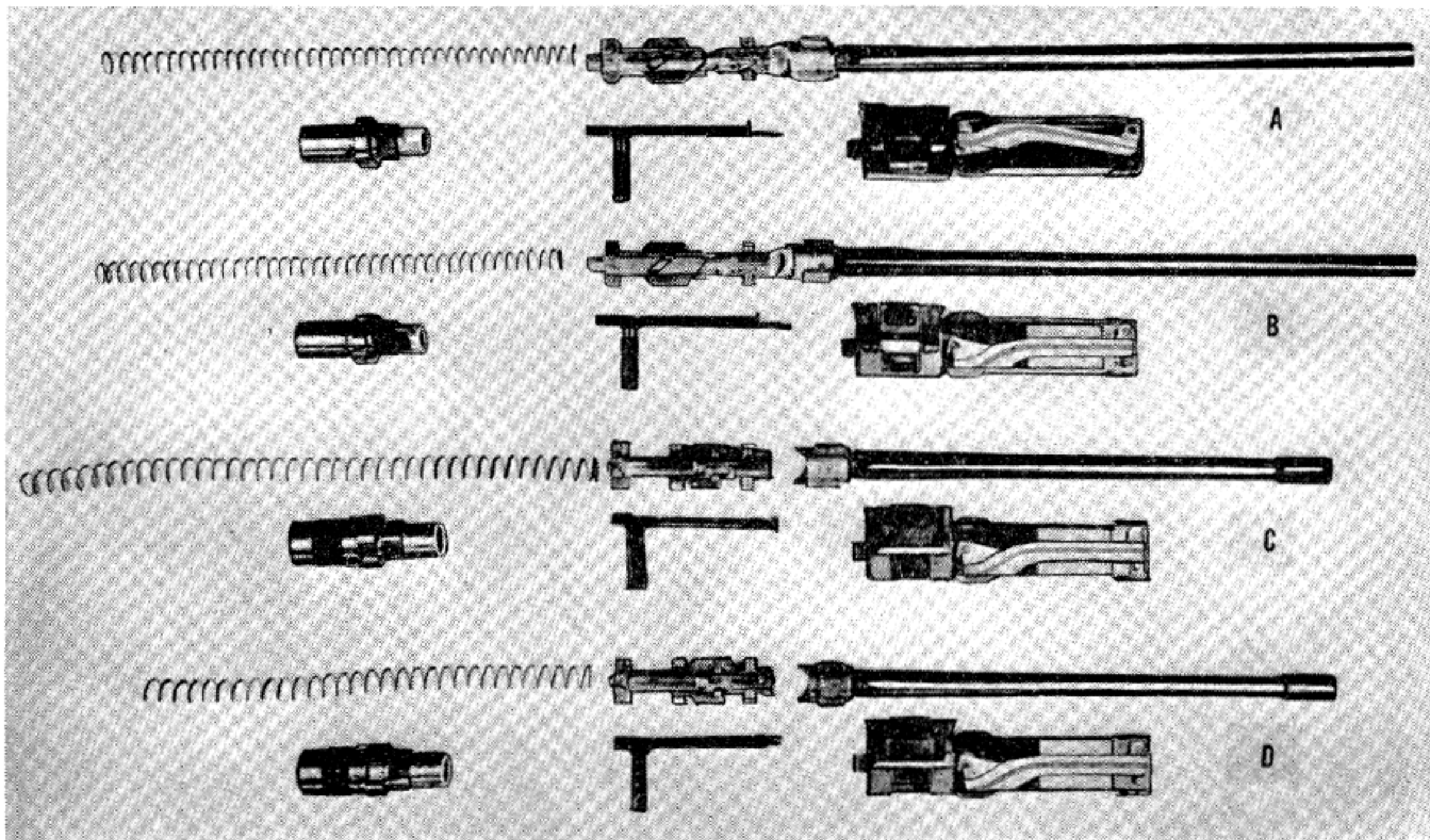

Comparison of Component Parts of the Mauser Machine Guns of the MG-34 Series. (A) MG-34. (B) MG-34 (Modified). (C) MG-34 S (D) MG-34/41.

For automatic firing, the bottom part of the trigger is pulled to the rear. This releases the sear and the bolt, which has been held in the cocked position, flies forward from the energy of the compressed driving spring. A feed piece on top of the bolt, being spring loaded, rises and strikes the base of the indexed cartridge, pushing it out of its linked position for chambering. Continuing on, the feed arm, actuated by the projection on the top rear end of the bolt carrier, causes the carrier to move the cartridge belt over a half space.

At the same time, the two inner rollers on the bolt head engage the cams on the barrel sleeve, causing a partial rotation of the bolt head clockwise so that the bolt buttress threads engage those on the cam sleeve and lock the bolt to the barrel. This movement also forces the extractor lip over the rim of the chambered round. The bolt carrier can now continue forward just enough to allow the firing pin to be driven into the primer.

The counterrecoil stroke is stopped completely as the shoulder on the bolt carrier's right

front strikes the cocking-handle stop. The bolt-locking catch has now lifted behind the outer roller on the bolt head, and the exploding powder charge starts recoil movement with barrel and bolt locked together for three-sixteenths inch of rearward travel. The bullet has now cleared the bore but a high residual pressure still remains in the chamber.

The rate-of-fire booster traps the muzzle blast which reacts with great force on the face of the barrel adding considerable thrust to the recoil. After three-sixteenths inch free travel, the outer rollers on the bolt head contact the two cam faces in front of the barrel extension and the bolt head makes a quarter turn counter-clockwise, thus unlocking the bolt from the barrel. Recoil movement of the barrel is then stopped as its cam sleeve butts against the shoulders in the front end of the receiver. The feed arm stud moves the feed pawl until it slips over the first round in the belt.

As the bolt continues to the rear, the empty cartridge case is held by the extractor claw. The latter had loosened the round by its initial rear-

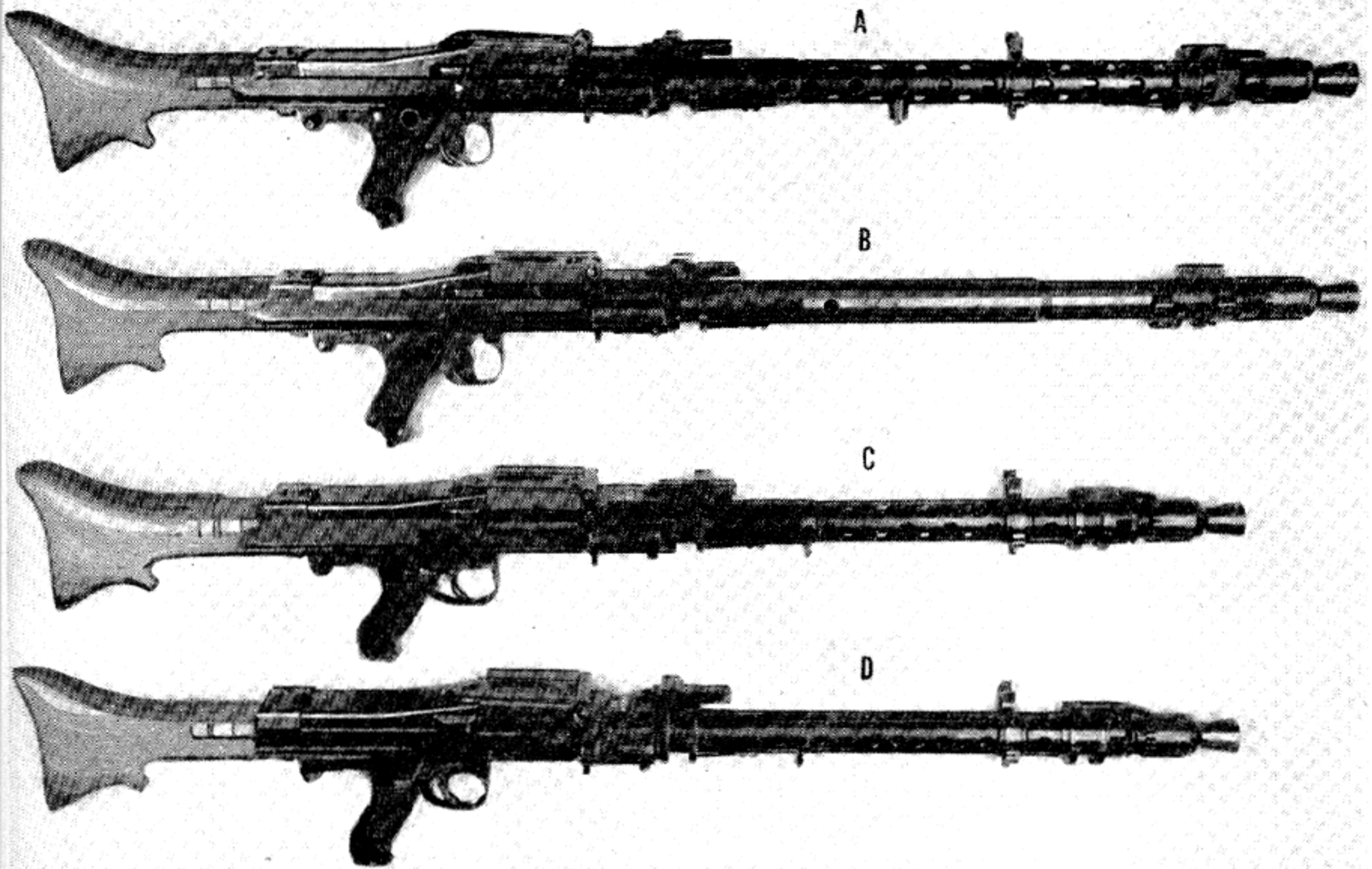

Comparison of Mauser Machine Guns of the MG-34 Series. (A) MG-34. (B) MG-34 (Modified). (C) MG-34 S. (D) MG-34/41

ward movement when the bolt head rotated to unlock, and now holds the base of the cartridge to the front of the bolt. The rear end of the ejector pin next strikes its stop, pushing it through the bolt face, pivoting and knocking the spent case through the ejection slot in the bottom of the receiver. The complete recoil stroke of the operating assembly is finally stopped by the buffer which absorbs the surplus energy and deflects it forward into counter-recoil movement to repeat the cycle.

The use of a rotating bolt head in place of the locking ring featured in earlier German machine guns has caused writers to credit the series of weapons that soon followed to other inventors. But, if Stange's patent granted in 1928 is checked closely, it will be disclosed that the roller locking arrangement will accelerate the rear portion of the two-piece bolt by recoiling barrel movement at the instant of unlocking. While earlier machine guns had locked and freed the bolt by turning the head of this part, they most cer-

tainly did not utilize speed of barrel recoil to accelerate its movement rearward.

It has been a moot question as to why the locking ring, successfully used by early ground guns, was suddenly dropped in favor of this system. The answer seems to be that the locking ring made barrel change, although fast, possible only with components that later had to be removed from the hot barrel and placed on the cool one. The rotary bolt allowed all operating parts to be retained in the receiver while the overheated barrel was quickly removed by itself. This feature alone justified the substitution.

The German field manual recommended that a barrel change should occur after 250 rounds had been fired continuously or with only short pauses between bursts. The following procedure was specified: The operator cocks the bolt to the rear after setting the selector lever on *Safe*. He depresses the receiver catch just below and back of the back-sight pivot and turns the receiver body 180° to the left. The muzzle is then raised

until the barrel drops out of the rear end of the jacket, after which it is lowered and a cool barrel dropped in. The receiver is turned to the right until the catches snap into the holding detents. The operator switches to *Fire* and grasps the cocking handle with his right hand. The trigger is pulled with the other hand and the bolt goes home slowly. The weapon is now ready to be cocked and firing resumed.

The following arms firms manufactured the MG-34: Mauser Werke and Maget, both of Berlin; Gustloff Co., of Suhl, Saxony; Steyr-Daimler-Puch A. G. of Vienna; and Waffenwerke Brunn A. G. of Czechoslovakia.

### MG-81

In 1936 when the MG-34 was put into production for the ground troops, the German Air Force became interested in the weapon as an aircraft machine gun for flexible and fixed mounting. The rifle caliber gun then in use in German aircraft was the MG-15 manufactured by Rheinmetall. The MG-15 was slow and expensive to produce so the Mauser firm was directed to develop an aircraft weapon, using the 7.92-mm rifle cartridge, and incorporating the bolt action of the MG-34. The new design was accepted in 1938 and put into production by Mauser in 1939.

For flexible mounting where an operator was

available to hand charge and fire the piece a pistol grip handle was used. A strong spring buffer, fastened to the rear and inside the receiver, was also added.

This weapon was designated the MG-81. A small cocking handle was located at the rear of the receiver. It had a very high rate of fire, officially listed as 1,000 to 1,200 rounds a minute. A muzzle booster with a small orifice and an abnormally strong buffer spring was responsible for the increase over the MG-34, which was closely copied in operating action. No provision was made for firing single shots.

A very odd thing about the design of the gun was that its muzzle booster had no flash-hiding device attached to the end, as did all the other German machine guns of this type, whether for aircraft or ground use. Since it was produced for flexible mounting where it would be manually trained and fired, it was mystifying that this extremely high-speed short-barrel gun did not employ the conventional cone-shaped flash hider.

Feeding was done by means of a flexible disintegrating metal link belt rather than the saddle drum magazine used on its predecessor. The ammunition box could be attached to the side of the receiver, if desired, and permitted bursts of longer duration than did the drum arrangement. Power-driven turrets were being introduced at

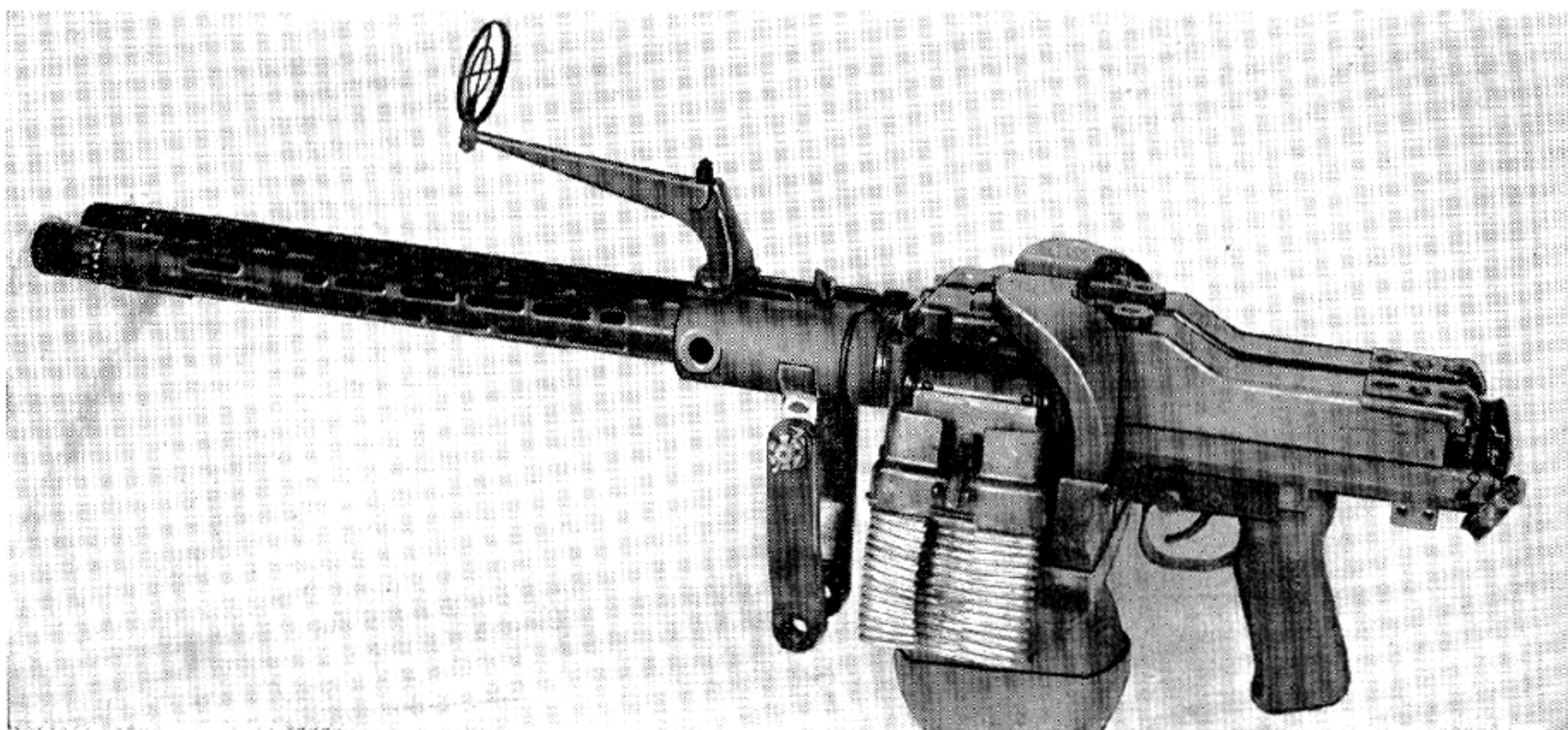

Mauser Aircraft Machine Gun, Model 81, 7.92 mm, Dual Mount.

about the time this weapon made its appearance and resulted in making the observer and his free gun practically a thing of the past. In view also of its small caliber the weapon was destined to occupy a very minor position in World War II.

The MG-81, however, was the first aircraft machine gun to be installed by the Germans in twin mountings. It was so mounted in the Bolo 81Z, and a few were later placed singly in the JU-88-A4, FW-189, and ME-110.

The weapon was manufactured for the German Luftwaffe by the following firms: Mauser Werke A. G., Oberndorf, which fabricated 46,000; Norddeutsche Maschinenfabrik G. m. b. H., Wittenberg; I. C. Wagner, Muhlhausen; Heinrich Krieghoff Waffenfabrik, Suhl; and L. O. Dietrich, Altenburg. Waffenfabrik Brunn A. G. also produced the MG-34, in addition to the ZB weapons, following the German occupation of Czechoslovakia.

## JOHNSON LIGHT MACHINE GUN

Melvin M. Johnson, Jr., is one of America's gifted gun designers. Born in Boston in 1909, he is a graduate of Harvard University and Harvard Law School. In 1933 he was commissioned in the Marine Corps Reserve and became captain in 1938. As early as 1937 Johnson produced experimentally a prototype light machine gun chambered for the caliber .30/06 United States infantry rifle cartridge. Empty, it weighed only 12½ pounds and was capable of delivering a maximum rate of fire of 500 shots a minute. The weapon had many good features, but the American Government viewed it with the customary caution it displayed toward progressive ideas on automatic arms.

After his rough version of the machine gun, Johnson modified and redesigned it in the years that followed. About 1 July 1940 he completed his first model of the Johnson light machine gun. It had a horizontal feed, and fired from an open bolt on automatic and from a closed one on semi-automatic.

In 1941 the light machine gun was tested by the Marine Corps at Quantico, Va., including a parachute jump from 400 feet. Packed in a pouch, the gun was assembled and fired within 90 seconds from the time of the jump.

The Marine Corps Equipment Board recommended its adoption for issue to parachute troopers and raiders. It was used in limited quantities with considerable success by Marine units in the Pacific and by the Army's First Special Service Force in the Italian campaign and landings in southern France. The annals of the latter group state that "pound for pound it was the most valuable armament the Force possessed." About 5000 Johnson light machine guns in all were produced by the manufacturer, Johnson Automatics, Inc., Boston, Mass., at a plant in Providence, R. I.

In August 1942, after seven months of war, the United States Army Ordnance Department

bought five Johnsons for test and experimental firing. It was reported, after examining the weapons, that "while called light machine guns by the manufacturer, they are not considered such by the War Department since they do not use belts but are fed from 20-round magazines." This official decision seems odd since the Browning Automatic Rifle was fed in the identical manner with the same number of rounds.

The five weapons, after a visual inspection, were shipped to Aberdeen Proving Ground for check firing. There it was discovered that the safety lever was defective and the group was promptly sent back to the manufacturer for correction. Upon being returned to the Proving Ground in September 1942, a total of 50 rounds was fired from each of the five. Then all were shipped to the Infantry Board to fulfill a request from that organization to see them.

No further government testing was done until December 1943 when the Johnson firm offered an improved model to the Ordnance Department. Incorporated in its construction were many things found more desirable as a result of over two years of combat use. The new version, known as the Model 1944, had only 11 parts and could be field stripped in less than 20 seconds and reassembled in 30 seconds. The method of operation was unchanged, short recoil with unlocking timed to coincide with a high but safe operating gas pressure.

The 1944 model differed from earlier designs in that it had a folding monopod mount and a slight improvement in barrel change. A field cleaning kit was placed in the butt stock of the gun. In some experiments at the factory a muzzle booster was used to accelerate the recoil forces for a higher rate of fire. This did hasten the cycle of operation but resulted in considerable breakage. For an infantry weapon its rapidity of fire had always been considered as high as needed and the muzzle attachment was dropped.





Melvin M. Johnson, Jr., Firing the Weapon He Designed.

In automatic firing, rotation of the bolt tripped the sear releasing the spring-loaded firing pin. For semiautomatic discharge, the trigger had to be pulled with each shot. The Aberdeen report of this model stated: "Test results were generally very satisfactory under normal conditions, but unsatisfactory under adverse conditions of mud, cold and dust."

Again the weapon was returned to the factory and in March 1944 its performance showed considerable improvement under adverse conditions. It fired successfully during the standard rain test for 200 rounds, but became more difficult to operate as the trial progressed, finally becoming inoperative after the 383rd round.

It failed to fire full or semiautomatic after the dust test with either a clean or dusted magazine. When the weapon had been liberally oiled, a dusted magazine was fired without difficulty.

Also 100 cartridges were fired without interruption after 17 hours in a cold room at a temperature of 40 degrees below zero Fahrenheit.

The Marine Corps Equipment Board had been testing similar guns at Quantico, Virginia, and this board recommended that the Johnson light machine gun be adopted in place of the Browning Automatic Rifle. The suggestion was not followed for the reasons stated below:

"(1) The swift tempo of Marine Corps operations with subsequent limitations on training time available. (2) The fact that the Marine Corps considers itself to be a customer of the Ordnance Department in small arms matters, and consequently, is reluctant to adopt an automatic shoulder weapon which is not an Army standard."

The same letter from the Commandant of Marines provided support and recognition of the inventor's contribution:

"The Marine Corps desires to lend impetus to the continual development of the Johnson light machine gun, and stands ready to perform such functions in that connection as may be considered desirable."

The Ordnance Department at a later date (May 1945) reviewed all the information available and decided to purchase 10 guns and accessories which were delivered and distributed as follows: Infantry Board, 3; Marine Corps, 2; Aberdeen Proving Ground, 2; Headquarters, Army Ground Force, 1; and Small Arms Development Division, 2. All spare parts were sent to the Aberdeen Proving Ground.

A final report on the Johnson weapon was made in October 1945, three months after the end of the war. No definite conclusion was cited, but it was intimated that it would be desirable to convert it to a belt-fed machine gun and that research and development were continuing.

Undoubtedly the Johnson light machine gun was an excellent weapon with many attractive and novel features, many of which were quickly copied by the enemy.

The selector switch is located on the right side back of the top part of the trigger. For semiautomatic fire the change lever is rotated into the forward position. If the cocking handle is pulled back to the rear and released, it will chamber the round and lock the bolt ready for single shots

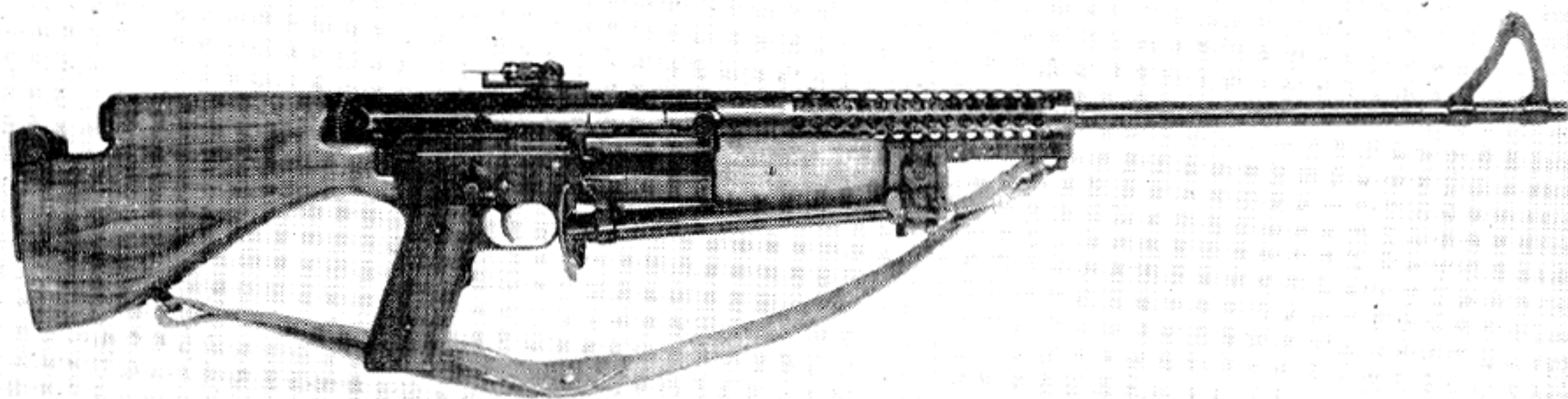

Johnson Light Machine Gun, Model 1941, Cal. .30/06.

at each trigger movement. When the automatic-fire position is used, the bolt will remain retracted at the end of each burst, allowing air to circulate through the open bore.

If, after firing a short burst, it is found desirable to recharge the magazine, it may be done by inserting the five-round clips through the loading aperture on the right side of the receiver, regardless of whether the bolt is open or closed. In semiautomatic fire a full magazine can be kept available for an emergency that would call for an extended burst. Loading in this manner is not normally intended for automatic fire, as replacing the magazine with a fresh one is but a matter of seconds.

One of the most desirable features on this light machine gun is the gunner's ability to fire semiautomatic with a closed bolt merely by changing the selector switch with finger pressure. Thus shooting was as accurate as with any similarly constructed rifle. Lurching forward off the rear sear, an act that disturbs aim in all guns employing the rear sear for inertia firing, is thus eliminated in this method of single-shot firing.

It would seem impossible to make a quicker system of barrel change. On the 1944 model with the bolt at the rear, the point of a bullet is inserted in the latch and shoved forward. This releases the holding catch and forces the barrel forward due to the action of the barrel return spring. The barrel, if hot, may then be shaken all the way out, or withdrawn if it can be handled. To assemble, the cool barrel is shoved down as far as it will go. Upon being seated, the

locking latch will be cammed into place holding it secure. During demonstrations a complete barrel change has been done in six seconds.

To fire the Johnson light machine gun, a loaded clip is inserted in the left portion of the receiver until the holding catches click into engagement. If automatic fire is desired, the selector switch is set and the cocking handle pulled all the way back or until the rear sear engages its notch in the bolt. When the trigger is pulled the connecting sear is released from the bolt, allowing it to be thrust forward by compression of the driving spring in the butt stock.

After pushing the cartridge out of the magazine, the bolt chambers it as the extractor cams its claw over the rim. Just below final forward movement is halted, the locking cam on the rear of the bolt rotates the latter piece. It is fully secured as the action goes through a 20-degree arc, engaging all eight of the locking lugs. This last movement also releases the firing pin which flies forward, detonating the primer.

When the cartridge is fired, the barrel, its extension and bolt locked together recoil for a full one-eighth inch at which point the angled face of the operating cam contacts its corresponding face in the receiver body. This causes the bolt to rotate until the piece is free to recoil. This act is timed to coincide with a high residual pressure in the bore which adds to the speed of the bolt. The barrel, traveling only seven-sixteenths of an inch rearward, is brought back to battery by its return spring.

The locking angle on the lugs permits sufficient creep during the act of unlocking. The

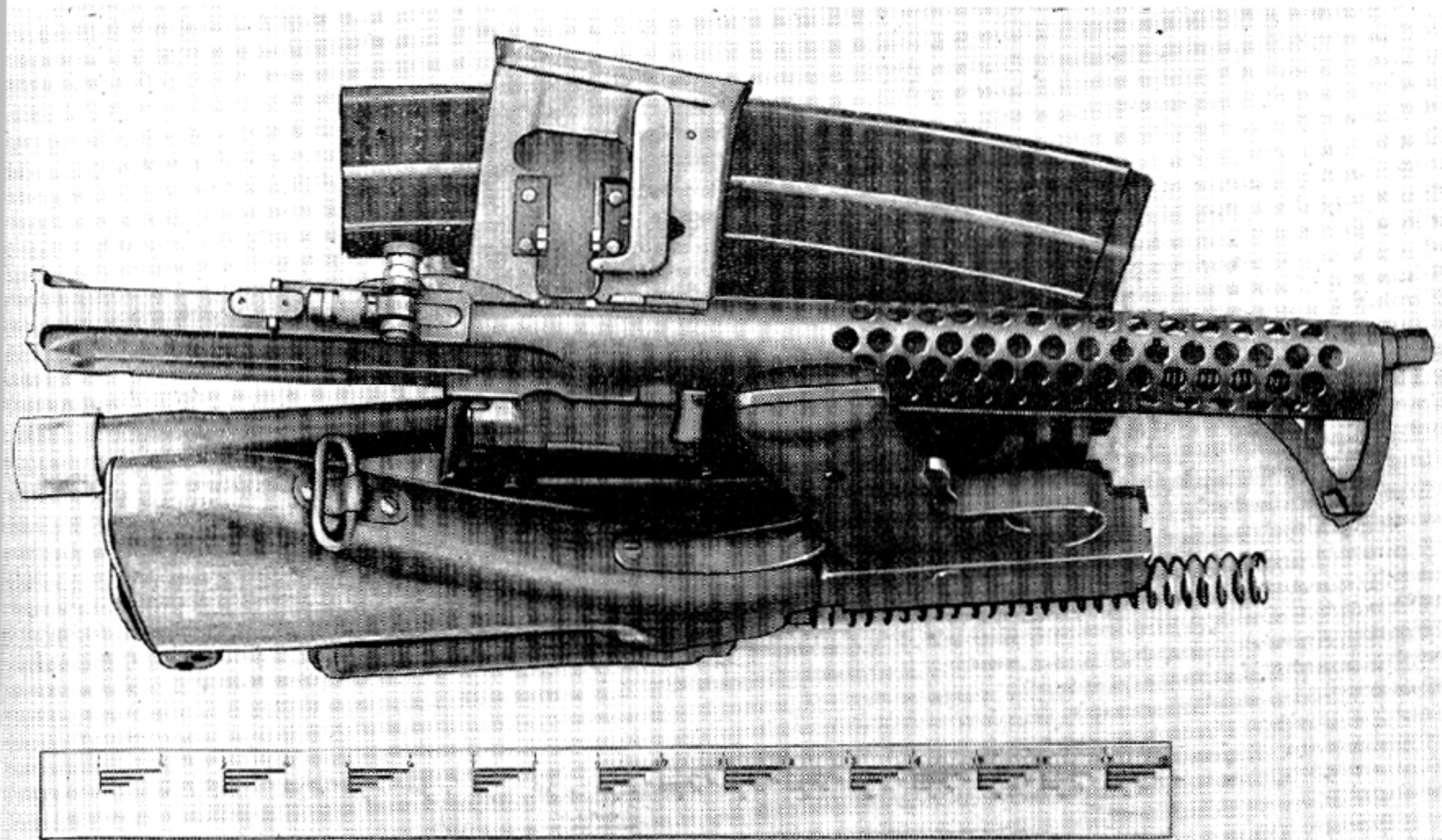

Johnson Light Machine Gun, Model 1941, Disassembled. For Paratroop Work.

empty cartridge is jacked back and freed in the chamber so that the extractor has only to hold it in position for ejecting. This is done when the ejector strikes the base of the round and kicks it out the right side of the receiver. The bolt continues to go to the rear until stopped by the compression of the driving spring.

All operational parts are then put in counter-recoil. As the bolt passes the rear of the magazine mouth, its face pushes the next cartridge

out of the lips of the feed system and starts to chamber it. As long as the trigger is held to the rear, the cycle will continue.

In addition to his light machine gun, Melvin Johnson developed and produced a highly regarded semi-automatic rifle, some 50,000 of which were made and delivered during the war to various Allied forces. He also originated, at the request of the Navy Department, a 20-mm aircraft cannon.

## MG-42 MACHINE GUN

In 1942 the Germans, after nearly 3 years of war, introduced into their services a machine gun known as the MG-42. It represented during World War II one of the finest machine guns manufactured for effort and money expended. The Germans, using the already highly successful MG-34 as a guide for such factors as length, weight, ballistics, and rate of fire, attempted to solve for the duration of the war their army's light machine gun problems. Only the soundest and most proved features known to them were put into its construction.

It was a weapon of devisement, contributed to by many, rather than the single invention of

any individual. For instance, the barrel change was an improvement over the Italian Breda, and the locking was an adaptation of the patented locking arrangement of Edward Stecke, a citizen of Warsaw, Poland. It is believed by many that, with the overrunning of Poland in 1939, one of the things seized by the Germans was a mock-up of a machine gun having Stecke's locking action. Realizing that it had many advantages, they added it to the list of fine features to be incorporated in a single ideal machine gun.

After the mechanism was finally decided upon, Dr. Grunow, a German industrialist, whose specialty was mass production by metal stampings,

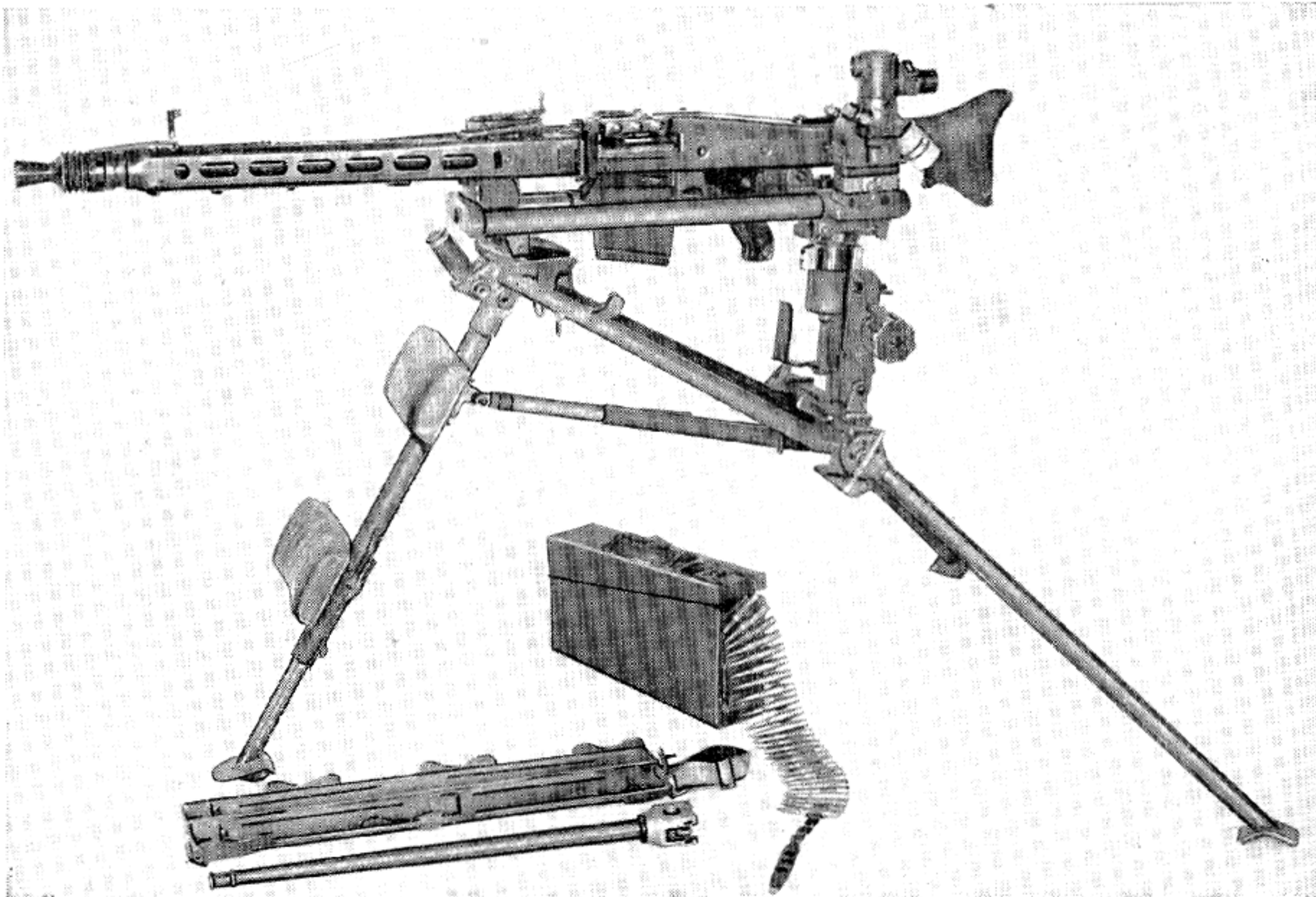

Machine Gun, Model 42, 7.92 mm.

was ordered to devote his talents toward manufacture of the weapon without employing complicated methods or equipment. Dr. Grunow's accomplishment of this task by extensive use of pressing, riveting, and spot welding was a thing that will be studied and closely copied in machine gun construction for years to come. While its finished appearance was by no means as striking as that of other German machine guns, its battle life and performance was even greater than the normally high German standards for such arms.

The need for frequent barrel change because of the unusually fast rate of fire was met by the introduction of a most novel and efficient method for accomplishing it. A barrel throw-out lever was hinged on the right side of the receiver. It could be swung out bringing with it the hot barrel, which was supported by a metal loop attached to the inside of the actuating lever. The barrel could then be pivoted out of the rear of the barrel jacket and dropped without handling.

Feeding was done by a continuous metal belt through the feed block. Two feed pawls were linked to the front end of the arm by an intermediate link in such a way that when one was chambered, the other was being positioned behind the next round in the belt. Loading was thus performed in two stages instead of one continuous movement. This made lurching of the belt less violent and did not impede the gunner's aim.

The Germans, being perfectly satisfied with its ballistics, adapted the MG-42 to take the 7.92-mm infantry rifle cartridge. Although it did not weigh much more than an ordinary military rifle, no provision was made whereby it could be fired single shot, the only two settings on its selector switch being for *Safe* and for *Automatic fire*.

The system of operation was short recoil. Free travel of locked bolt and barrel was allowed for a short distance. The bolt was then unlocked and the high chamber pressure being held by the muzzle booster exerted itself on the barrel face and through the bore to the now empty cartridge, thus giving an abnormal rate of fire for such a light firing mechanism. Its cyclic rate, when using special ammunition, was asserted to be 1,350 rounds a minute and the normal num-

ber of rounds per minute with standard ammunition was 1,200 shots. While this may seem unnecessarily high for an infantry weapon, its importance for fire power effect was obvious.

In lieu of the rotating bolt head, successfully used on earlier machine guns of this type, locking of the bolt to the barrel was achieved by means of a wedge situated in the bolt head. This wedge was formed by two locking pieces, each being a small two-dimensional roller arranged symmetrically in slots in the sides of the bolt head with their axles vertical. The rims of the circular locking pieces were forced outwards so that the axles which projected above and below the slots engaged corresponding grooves in the barrel extension. On recoil the locking parts were forced in by stationary ramps and the light bolt was free to move to the rear under the action imparted by the gases from high chamber pressure exerted on the bolt face by the spent cartridge case.

The MG-42 was used with a bipod as a light machine gun, and on a tripod as a substitute for the heavier type. The barrel-jacket cover and feed parts and receiver were constructed of stamped lightweight sheet steel welded lengthwise. The bolt's slideways were welded inside the receiver. The shoulder piece was made of plastic. On the right side of the barrel jacket a long slot purposely was left open so that the barrel could more easily be removed. Manipulation of the lever in the receiver on this side would force the rear of the hot barrel out and allow it to slide untouched to the ground.

As an example of the thoroughness of design whereby each component or accessory performed as many functions as possible, the muzzle booster is perhaps outstanding. This simple device, fastened to the forward end of the barrel jacket, not only trapped the still expanding gases after the bullet left the bore, but it also served as a front barrel bearing and flash suppressor. It was so slotted that the escaping gas, after it had been reworked, hit against angled buffers to serve as a muzzle brake for stabilizing the weapon during a short burst at an abnormally high cyclic rate.

The Germans, in developing and producing the MG-42, abandoned all former rules and regulations on both production and finishing of material. This led to the erroneous belief that

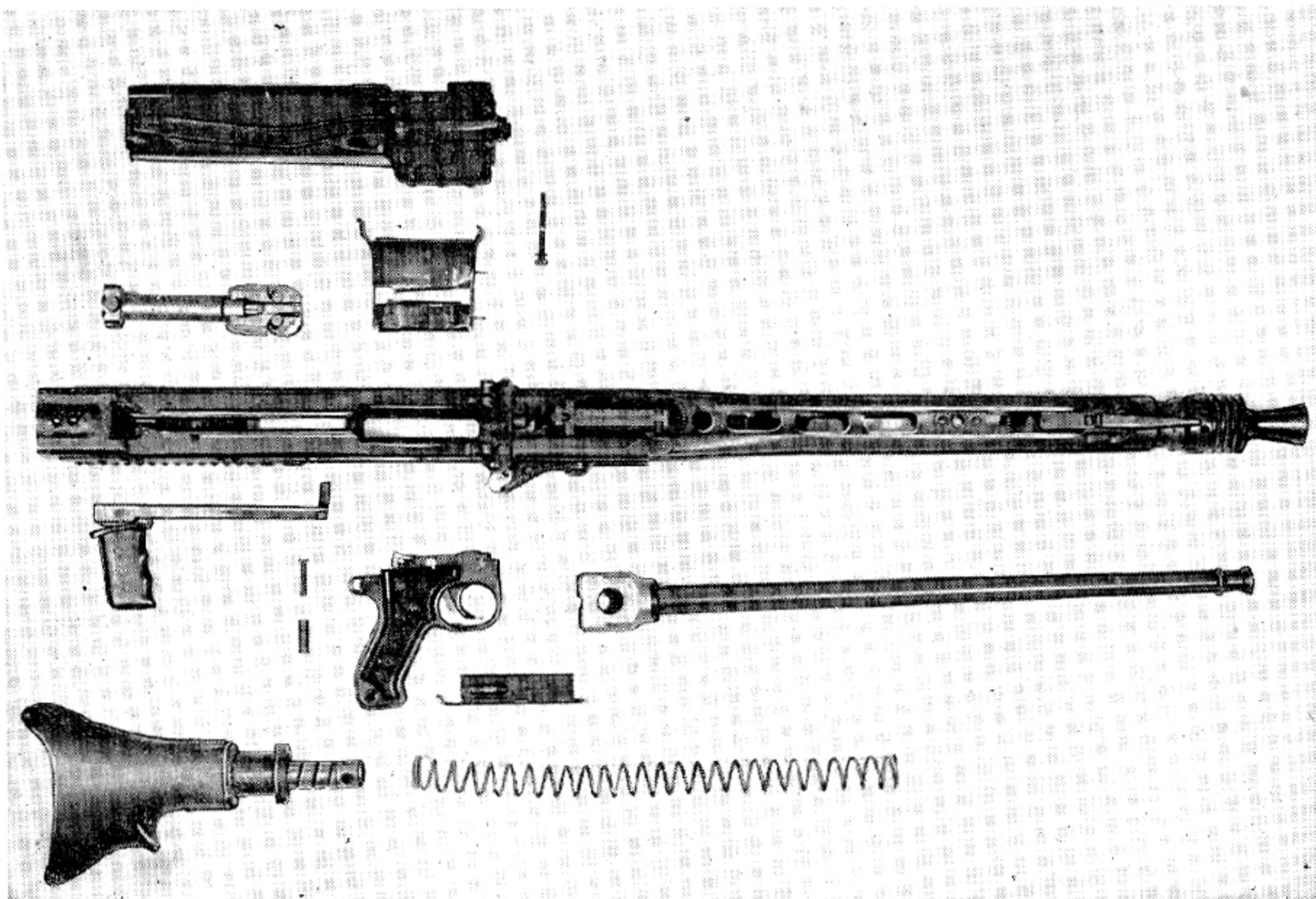

Components of the Machine Gun, Model 42.

a desperate shortage of certain materials existed in Germany and that automatic weapons of inferior quality were being made, since externally they did not meet the erstwhile meticulous German standards. The truth of the matter was they simply had mastered the art of producing fine automatic weapons with no more expense and time than would be needed to make a dozen cap pistols.

About the only real weakness was its variety of tactical uses, in line with a typical German characteristic. Once a fine weapon has been in production, invariably an attempt was made to adapt it to every conceivable use from anti-aircraft in batteries to individual-burst fire by the infantryman. Its employment by the latter incidentally was its most effective. And while many have pointed out that its terrifically high rate of fire for infantry use would make the muzzle climb if a long burst were tried, it must be remembered that the weapon was ordinarily only fired for a fraction of a second during each burst.

Since it was being discharged at a rate of 22 shots a second, the striking bullets could be held to a small enough area to cover it thoroughly. It acted more in the capacity of a long-range shot gun than as a machine gun. The German Army considered the MG-42 one of the most excellent weapons known not only for inflicting heavy casualties on infantry in movement but doubly so for its effectiveness in keeping the enemy pinned down when dug in.

Ammunition was fed to the weapon by flexible metal belts, each holding 50 rounds, that could easily be spliced to any length desired. A drum magazine, also holding one 50-round belt, could be attached to the left side and a few have been known to be modified to take a saddle drum feed that held 75 belted cartridges.

In loading the MG-42, the feed cover can be either open or closed, so long as the first round is positioned at the cartridge stop. The spring-loaded cover for keeping dirt out of the ejection slot flies open the instant the trigger is pulled

back. When firing has been interrupted for any length of time, this piece is snapped shut by hand. It is one of the easiest known machine guns to unload. The selector is simply switched to *Safe* and, after unlatching, the feed cover is raised as far as it will go. The remainder of the belted ammunition can then be lifted out.

The bolt is removed first by letting it go home, then by twisting the butt stock to detach the latter. The driving spring and bolt then slide readily out the rear. The barrel has a relatively short but heavy barrel extension which is screwed to its aft end.

To fire the MG-42, the operator, generally from the prone position, puts the tab end of the cartridge belt through from the left side of the feedway and pulls to the right until the first cartridge comes to rest against its stop. With the weapon set at *Safe*, the charging handle on the right side of the gun is pulled all the way to the rear. The searing device will then engage its locking notch in the bottom of the bolt. The selector switch is turned to *Fire* and the trigger pulled.

As the bolt is thrust forward by the compressed driving spring, the bolt face knocks the cartridge out of its link ahead of the counterrecoiling parts into the chamber. As the movement continues, a locking stud on each side and at the front of the bolt starts to engage a corresponding cam in the barrel extension. By forcing the lugs into their locking recesses, the bolt face is brought securely behind the base of the already chambered cartridge. Final movement cams the extractor lip over the rim and into the cannelure of the round. At the same time, the firing pin, which is now an integral part of the rear portion of the bolt, is driven forward by inertia and detonates the primer to explode the powder charge.

While the powder gases are reaching peak pressures and the bullet is still in the bore, the bolt is held securely to the barrel, both pieces traveling rearwards as a unit until a distance of one half inch is reached. Then travel of the barrel and its extension is stopped. At the same time the pins in the locking head are cammed out by contact with the unlocking ramps, withdrawing them from their seats. The bolt is thus freed to continue to the rear, accelerated by the impact

of the high residual pressure in the bore on the face of the bolt, while the barrel-return spring pushes the barrel and extension back to battery.

The cartridge case loosened by the first act of unlocking is carried to the rear by the extractor and is held until the ejector knocks it through the opening in the bottom of the receiver. The first movement of the bolt in recoil levers the next round in the belt into position and places the feed pawl behind the next cartridge as the bolt continues to go rearwards until it strikes the strong helical spring located in the shoulder stock. Deflection, working in conjunction with the stored energy of the driving spring, starts the operating parts back into counterrecoil to repeat the cycle of operation.

When placed in use as a heavy machine gun, it was found necessary to provide a specially constructed muzzle brake for the MG-42. The device counteracted the tendency of the muzzle to jump when a burst of long duration was fired. This followed the unsuccessful trials of a standard booster. The first use of the specially designed muzzle brake was late in 1943 and it was continued effectively until the war's end. The brake, which was attached to the flash eliminator and gas-pressure trap, had two baffle plates and was made to give more braking effect and lower cyclic rate than did the standard one.

The following arms plants manufactured the MG-42 for the German Army: The Johannus Grossfuss Metall- und Locierwarenfabrik, Döbeln, Saxony (Dr. Grunow was on its staff); Mauser Werke, Berlin; Maget, Berlin; Gustloff Co., Suhl Gun Works, Suhl, Germany; and Steyr-Daimler Puch A. G., Vienna, Austria.

After the United States entered the war against Germany, the Ordnance Department sought to copy a captured German MG-42. The Saginaw Steering Gear Division of General Motors was given the assignment. Drawings were completed in June 1943 and the first guns produced were test fired on 1 October 1943. Serious malfunctions were found to result and the components were then reworked. When it was thought to be ready, it was again put on trial in February 1944. The results were so discouraging that the discharge of a hundred rounds had to be done in bursts of two and three shots. Again the parts were modified and "beefed up" until it

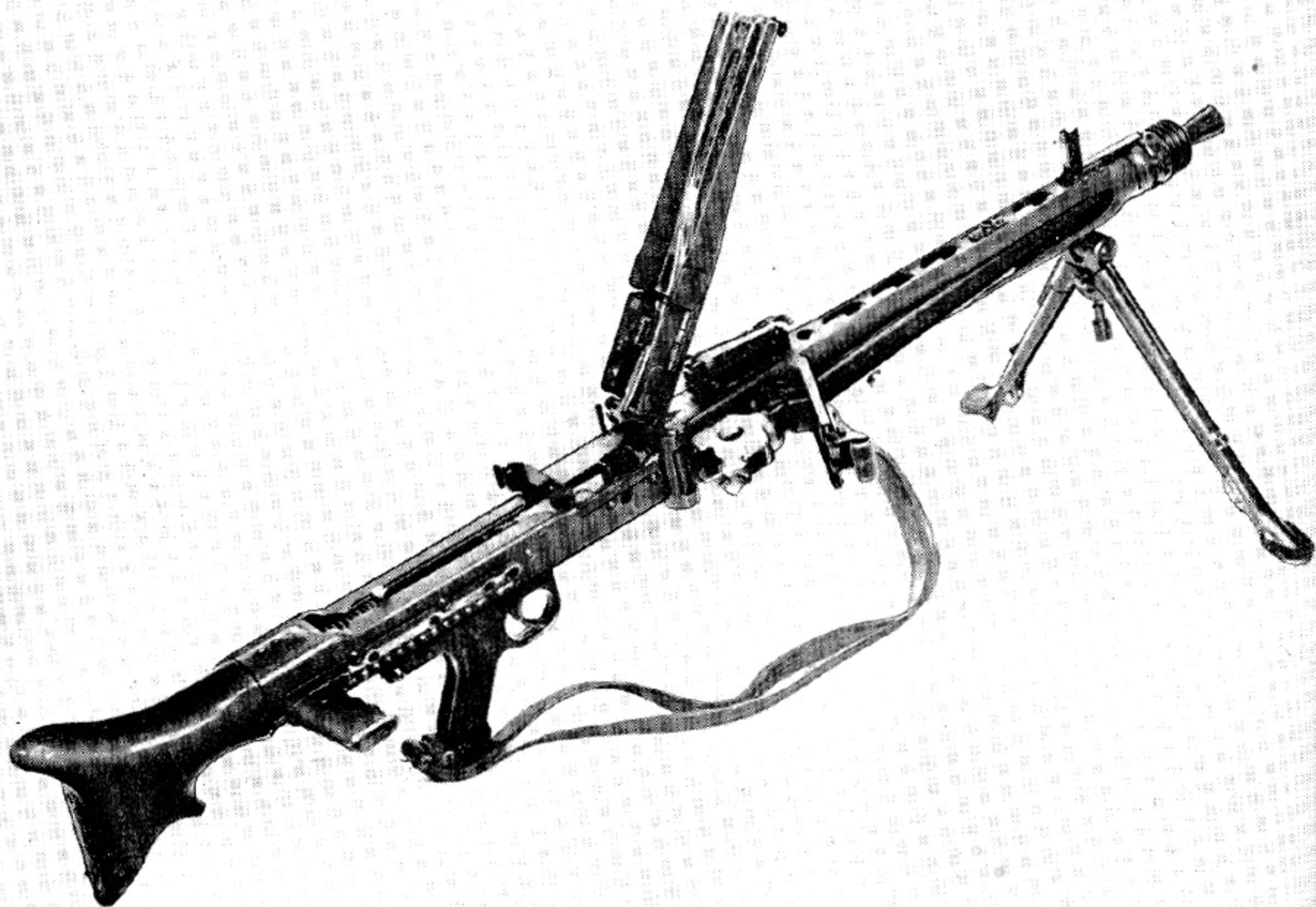

Machine Gun, Model 42, 7.92 mm. View Shows Cover Open and Barrel Release Latch Open with Barrel Partly Removed.

was thought to be capable of the basic 10,000-round endurance test required by the Army before being considered even for limited use. After 1,483 rounds had been expended, the test was stopped, there having been over 50 serious stoppages.

An intensive study was ordered on the failure of American engineers to copy successfully this German machine gun which had been stamped out of the most ordinary of materials. The investigation revealed that inadequate compensation for the difference between the cartridge length of our caliber .30 M2 and the German 7.92-mm cartridge case had been made and that the receiver on the American version was too

long. The rear lugs on the bolt body also had not been placed far enough back to allow the bolt face to recoil behind the ejection slot in the bottom of the receiver. As a result the receiver yoke interfered with the cartridge guide plate by as much as a quarter of an inch.

It was concluded that extensive redesign would be necessary to correct these serious defects in both receiver and bolt mechanisms and further expenditures or developments were ordered stopped. Two models of this American-made failure, known officially as Machine Gun Cal. .30T24, were shipped to the Springfield Armory and placed in its museum for reference and historical purposes.



## FG-42 MACHINE GUN

German military and industrial leaders, believing they had taken care of infantry armament needs, next turned their attention to a machine gun on which consideration had to be given to balance and lightness of weight. This weapon, manufactured by Heinrich Krieghoff Waffenfabrik, Suhl, Saxony, was intended for air-borne soldiers, a mode of warfare so far untried. With the invasion of Crete by air the Germans introduced the new paratroop machine

gun, called the FG-42. It was promptly confused with the MG-42 by observers reporting the incident. The designation given the air-borne weapon represented the initials for Fallschirm Jaeger Gewehr (paratroop machine gun).

The gas-operated, air-cooled, bipod-supported weapon had a large ventilated fore-arm grip and an unusually light and short shoulder stock. It weighed only 14 pounds with bipod and a loaded clip magazine that held 20 rounds. The

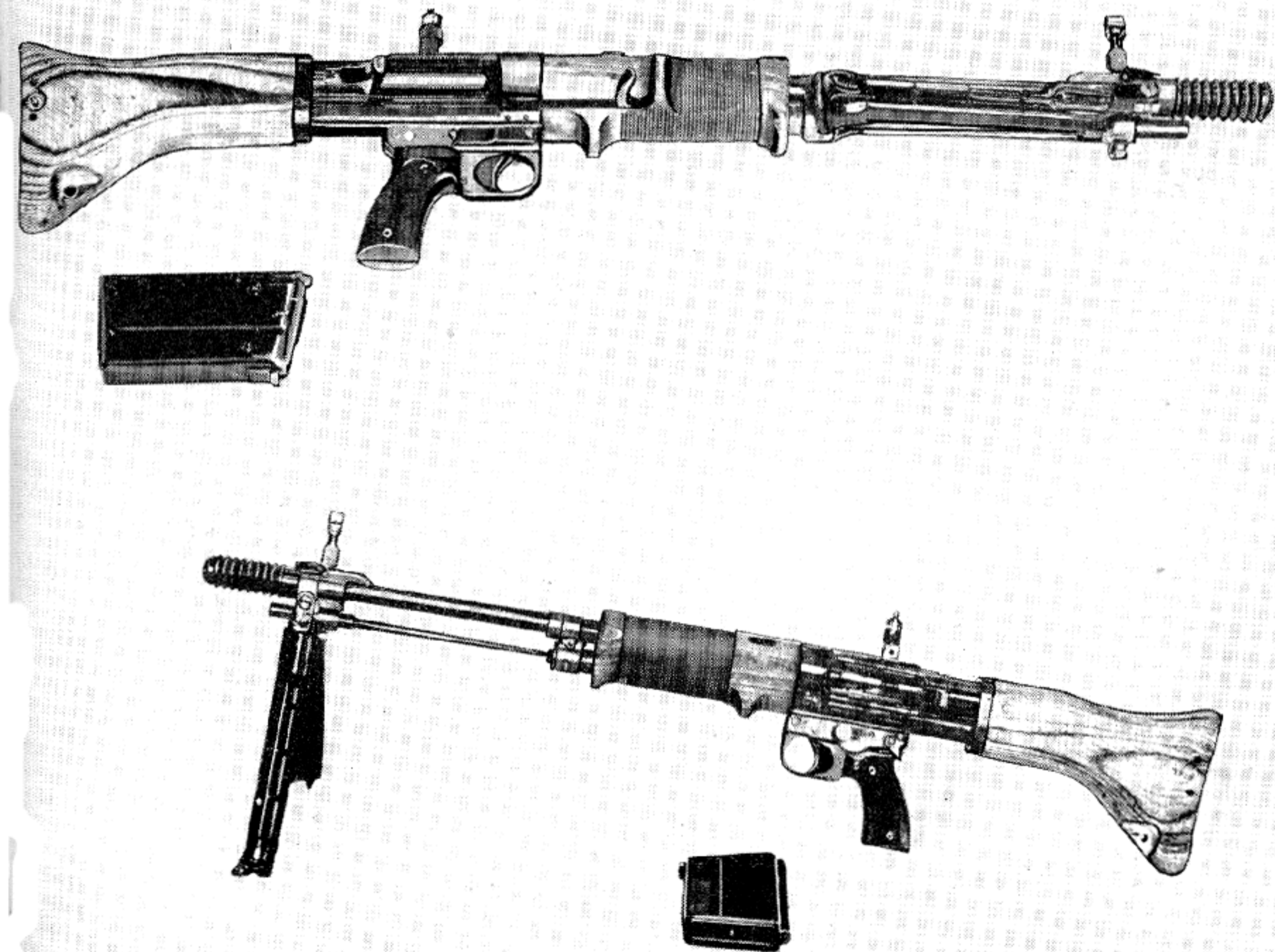

Machine Gun, Model FG-42, 7.92 mm.

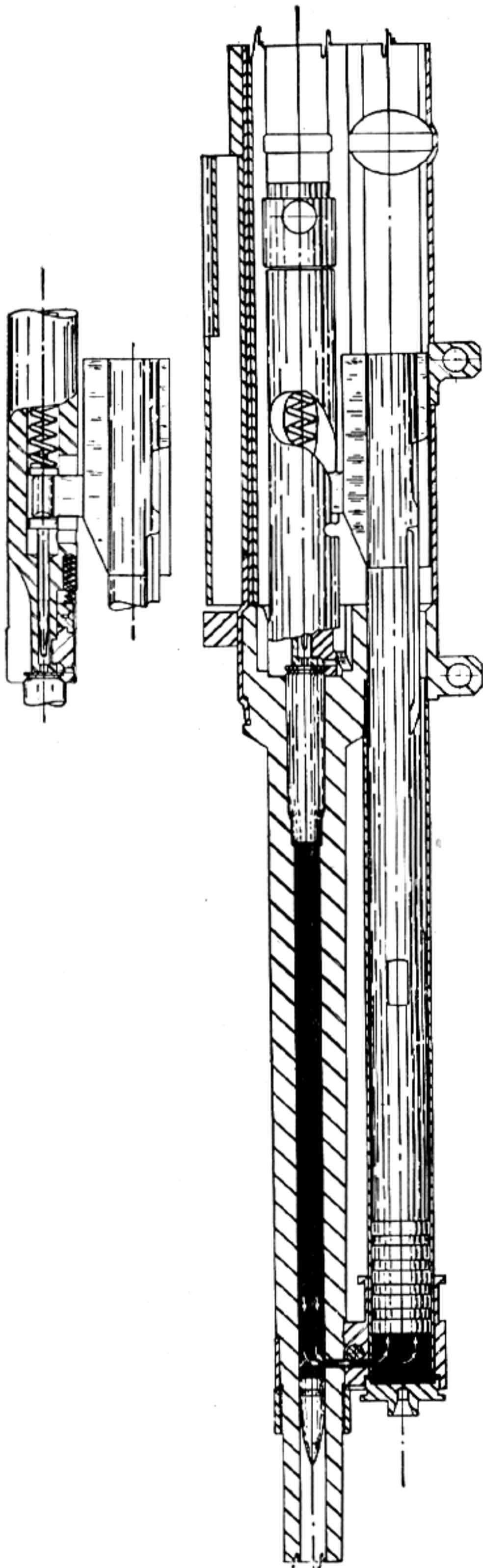

Section Drawing of the Machine Gun FG-42, Showing the Action Immediately After Firing. Gas from the Barrel Is Acting on the Piston Which Will Rotate and Unlock the Bolt.

receiver body, which contained the slideway for operating parts, was stamped out of sheet metal. The fixed barrel was permanently fastened both fore and aft by having the receiver swaged circumferentially in a recess around each end and then further secured by the locking pin. A projection on the left side opened to permit insertion of a fresh loaded magazine when all cartridges were expended from the previous one. When not in use, it was closed by two metal spring-loaded flaps which flew open when their latch was shoved forward.

A combination flash suppressor and muzzle brake was screwed on the muzzle end of the barrel, being held in place by a spring latch attached to the front sight. This device absorbed a high percentage of the recoil forces. A gas cylinder beneath the barrel was held in place by a locking nut. An orifice selector permitted the gunner to regulate the amount of gas going into the cylinder from the port in the barrel, center punch marks showing him in advance whether the movement would position a large or small orifice.

The gas cylinder had four equidistant ports located far enough away from the forward end to permit the piston rod to unlock before uncovering the ports. It then discharged the expanding powder gases at the end of its rear stroke and took in air on the return movement. The gas piston consisted of a tube closed on the forward end. Its rear portion had a recess machined in its upper side in which a rear-searing device engaged. Two D-shaped holes were machined at its middle to contain a cocking handle. The driving spring, held in place by a guide, was inserted into and housed by the gas piston. A rather strong spring-recoil buffer at the rear of the receiver, just aft of the gas piston, was designed to stop the latter on completion of its recoil stroke. The rear-inserted bolt assembly operated in a slideway in the receiver, while a cartridge guide stamped in the receiver, held the cartridge in alinement for chambering.

The two halves of the sheet-metal trigger mechanism were welded together. This unit housed the sear, selector switch, and safety latch. A sear protruding through the receiver acted against the underside of the gas piston and permitted the gunner freedom to fire either single

shot or full automatic. The short wooden stock was held in place by a spring-loaded catch and could be readily removed by depressing the locking latch located at the right rear.

The Germans, being on the receiving end of the very efficient Lewis gun during World War I, developed a great respect for this fine and reliable mechanism. It is natural that, when possible, many experiments were conducted in order to incorporate any single feature or the whole basic action for their own advantage. The FG-42 was the result. However it was so highly refined and modified to meet special needs that it was hardly recognizable. The most unusual feature was the cleverly designed triggering mechanism that enabled the operator by a turn of the selector switch to fire full automatic or single shot. At the same time it gave the gunner the privilege of firing with either a closed bolt for accuracy when used single shot, or of leaving the bolt in the open position for cooling purposes at the completion of a burst of full automatic fire.

This weapon represented the highest degree of refinement the Lewis type of automatic firing mechanism had ever attained and was well designed for its intended purpose.

To fire the FG-42 full automatic, a loaded 20-shot magazine is inserted after the spring-loaded flaps over the feedway are opened by releasing the catch. The safety lever, locked in the up position, is pushed down and the selector switch swung forward to *Full automatic*. The cocking handle, grasped on the right side, is pulled smartly to the rear until the gas piston and bolt are held there as the rear sear engages its locking notch beneath the piston. The weapon is now cocked and a cartridge is positioned for firing.

When the trigger is pulled, the driving spring thrusts the bolt and piston forward. The face of the bolt engages the base of the first cartridge in the mouth of the magazine. As the round is forced forward, it leaves the magazine and is directed by the cartridge guide for alignment with the oncoming bolt and chamber. As the

bolt reaches the end of its forward motion, the extractor lip snaps over the cartridge rim and the bolt face seats against the breech end of the barrel. The locking recesses are in position with the lugs on the bolt. However, the piston can still continue to travel and, in its attempt to do so, the beveled projection riding in the curved slot in the bolt body causes the bolt to rotate the lugs in their recesses and lock the piece. This act removes the obstruction that has been holding the action rearward. The added free travel permits the gas piston to drive the firing pin through the bolt face into the primer which in turn fires the powder charge.

The bolt remains securely locked supporting the cartridge while the bullet is in the bore. However, when it has passed the gas orifice, a portion of the expanding gases is let into the gas cylinder through one of the four regulating orifices. Pressure is exerted on the gas piston which starts to move rearward, carrying with it the firing pin held by the yokelike section on the rear part of the piston. The bullet is now clear of the muzzle and the yoke, after having had a free travel inside the bolt for over an inch, starts to act against the cam causing the bolt to rotate and become disengaged from the barrel extension.

When unlocking is complete, the bolt is free to be speeded back by the high residual pressure in the chamber. As it continues rearward, the empty cartridge case is withdrawn by the extractor and its rim brought into contact with the ejector operating through a slot in the bolt body. The empty case pivots about its extractor and is knocked through the ejection slot in the right side of the receiver, where it is deflected forward by a curved piece that is fastened rigidly to the outside of the receiver for this purpose. Additional movement rearward during the recoil stroke compresses the driving spring. The remainder of the energy of the operational parts is absorbed by their striking the heavy spring buffer. The latter, assisted by the driving spring, deflects the action forward to repeat the cycle of operation.

# PART V

## AUTOMATIC AIRCRAFT CANNON

After reviewing the material on the more recent large-bore automatic-firing mechanisms, it seems quite obvious that future armament of aircraft for years to come is to be found in this type of weapon. While quite ironically the bulk of our source material is in this particular field, due to security reasons the amount that can be openly discussed has become less and less. Only features that have been well known over a period of years are mentioned. All other models having peculiarities of construction that might reveal possible improvements in future design have been purposely deleted from this publication.

## DAVIS NONRECOILING GUN

When representatives of the great powers affixed their signatures to the treaty in St. Petersburg, Russia, in 1868, their main purpose was to eliminate the possibility of using explosive and purposely deformed bullets on personnel in warfare. In order to insure that no such projectiles be employed against the individual soldier, they collectively agreed to set 450 grams as the legal minimum weight for a projectile and its explosive content.

This simple specification made it impossible for any nation to put a bursting charge in any bullet of small dimensions. In fact, at this time no firearm existed which could utilize successfully a projectile based on these figures. It remained for the weapons manufacturer, B. B. Hotchkiss, then producing manually operated machine guns in Paris, France, to design the minimum size in artillery shells to be effective and still come within the legal requirements. This Hotchkiss projectile had stability of flight, penetration, and great destructive power from blast. When gaged up, it was found to be 37-mm in diameter.

The humanitarian intentions of the delegates who attended the convention resulted in a great restriction on aircraft armament all through World War I. For any plane that carried guns other than those in the rifle-caliber class had either to use a solid nonexploding projectile or mount at least a 37-mm cannon. As the cannon's slow rate of fire did not warrant employment of the nonexplosive shot, armament designers turned their attention to adapting shrapnel-firing cannon to the flimsy aircraft of the time. As a result, World War I saw aircraft weapons with bores equal in size to those used in another war some 25 years later.

The first recorded method of firing an artillery piece in the air was the invention of Commander Cleland Davis, an Annapolis graduate with a brilliant career, including a citation for

bravery in commanding machine gunners in the Manila campaign of 1899. His simple but unorthodox idea was so far advanced beyond the times that it reappeared as a "new discovery" in the latter days of World War II. In attempting to overcome the terrific recoil forces of artillery mounted in aircraft, he applied on 22 August 1911, for a basic patent on recoilless artillery and electric primer ignition. His wording in the patent claims bears repeating in order to show just how prophetic his conception was:

"It having been demonstrated that it is practicable to navigate the air under normal atmospheric conditions, and while as yet the practice is too hazardous for ordinary commercial



Cleland Davis When He Was a Lieutenant, USN.



A Davis Gun Mounted on a Naval Seaplane. The Gunner Has Pivoted the Breech to the Open Position for Loading.

purposes, still aircraft have already become a part of the military equipment of most of the civilized nations. . . . They have, however, so far developed little, if any, offensive value, it being practically impossible to strike a comparatively small target, such as the deck of a battleship, the vulnerable part of a fort, or even a large building, by merely dropping explosive from a high altitude. . . . Furthermore, the mere dropping of a high explosive on the deck of a ship, or a fort, would occasion very small damage, for the force of the explosive would ordinarily, aboard ship, be confined to the region above the protective deck and little damage would be done. . . .

"In order to secure the desired velocity to penetrate even thin armor, or a protected position anywhere, the explosive would have to be contained in a projectile, and this projectile would have to be propelled with sufficient velocity to penetrate said armor. . . .

"In order for a gun to be effective for such purposes, it must comply with the following conditions: (1) It should be of caliber sufficiently large to discharge a projectile carrying a considerable quantity of explosive. (2) It should be capable of giving a muzzle velocity to the projectile that would enable aimed shots to be fired at distances of 2,000 yards, or more. (3) It should be so designed that the shock of recoil will bring little or no strain upon the structure of the aeroplane."

"In order to meet the above condition, I have devised the apparatus . . . to which reference will now be had. . . ."

The invention was provided with an electric primer operated by a suitable source of electricity, such as a battery. The gun itself consisted of a barrel open at both ends to the atmosphere, a projectile and a propellant charge for the missile, and a recoil weight in the rear of said propelling charge. The weight was adapted to be expelled from the gun into the air when the charge was fired, thus neutralizing the backward thrust incident to the expulsion of the projectile. The shell was to be held in the gun by some friable connection and the resistance of shearing the set screw slightly exceeded the resistance required to start the shell in the bore. Thus the shell would move forward before the gun started to the rear.

By this arrangement of having the projectile and gun bring forces in opposite directions, a comparatively small amount of shock would be brought on the framework of the airplane. The resistance to the rearward travel of the gun in its sleeve obviously would be approximately equal to the resistance of the projectile in its passage through the bore of the gun. Then these two forces would neutralize each other, thereby relieving the gun support of any heavy strain.

Commander Davis did not stop with the conception of this novel weapon, as he demonstrated a working model at the United States Naval Academy at Annapolis, Md., several years before he actually put what he considered a perfected recoilless cannon into production.

The *Scientific American* on 21 April 1917, after its reporter had witnessed a factory demonstration of the weapon, published a glowing account of what it would make possible in aircraft use. In conclusion, the possibility it would offer as artillery for ground troops was described:

"Nonrecoiling guns of large size may also be mounted upon dirigibles, armored cars, or actually be carried by hand, greatly increasing offensive power without increasing the size of the vehicle or impairing the mobility of the infantryman in any way."

Like numerous other inventions of radical design, the possibilities of this new kind of aviation cannon were not realized except to offer a token demonstration of its capabilities during the last days of the war. On 2 August 1917, the largest gun yet fired from an airplane in America was tried out at the Curtiss Aircraft Co.'s testing range at Buffalo, N. Y. The weapon was a 75-mm Davis nonrecoiling gun, manufactured by the General Ordnance Co. of Derby, Conn. It was mounted at the front of the cockpit of a Curtiss J-N twin tractor operated by a factory test pilot, named Carlstrom, the company's representative, Mr. F. B. Towle, acting as gunner.

This pioneer performance of firing successfully such a large cannon from an airplane caused considerable comment in the newspapers and predictions of its effect on all artillery were freely made.

The velocity given for the big projectile was 1,175 feet per second and its accuracy was as good



Davis Gun Mounted for Anti-Submarine Patrol.

as that expected from a rifled barrel. A unique means of sighting the gun was employed. A Lewis gun was fastened on top and in the middle of the long tube and, as the pilot approached within range of the target, the gunner pressed one of a dual-trigger arrangement. This fired the Lewis gun and the gunner could observe where his bullets were hitting. When he had corrected his aim, by watching the bullets strike, until he felt he was on the target, the lower trigger was pulled back and by means of electric ignition the large cartridge in the Davis cannon was fired. This type of sighting was especially effective against submarines.

The Navy, which alone of the military services showed interest in the cannon, mounted it on seaplanes in three different calibers, 47-mm,

65-mm, and 75-mm, firing from six- to nine-pound projectiles. The Davis gun was distinctly an American Naval accomplishment, in that none of similar construction were developed, or even experimented with, by any other nation during the war. Both France and England were furnished the recoilless cannon by the Navy and it was put to limited use during the conflict. The Army made no attempt to utilize it as a land gun.

Actually the Davis gun practically dropped out of existence with the signing of the Armistice only to be rediscovered at a later date. During the course of World War II both the United States and Germany were working on secret projects relating to recoilless artillery. An American Army adaptation of the Davis gun was put



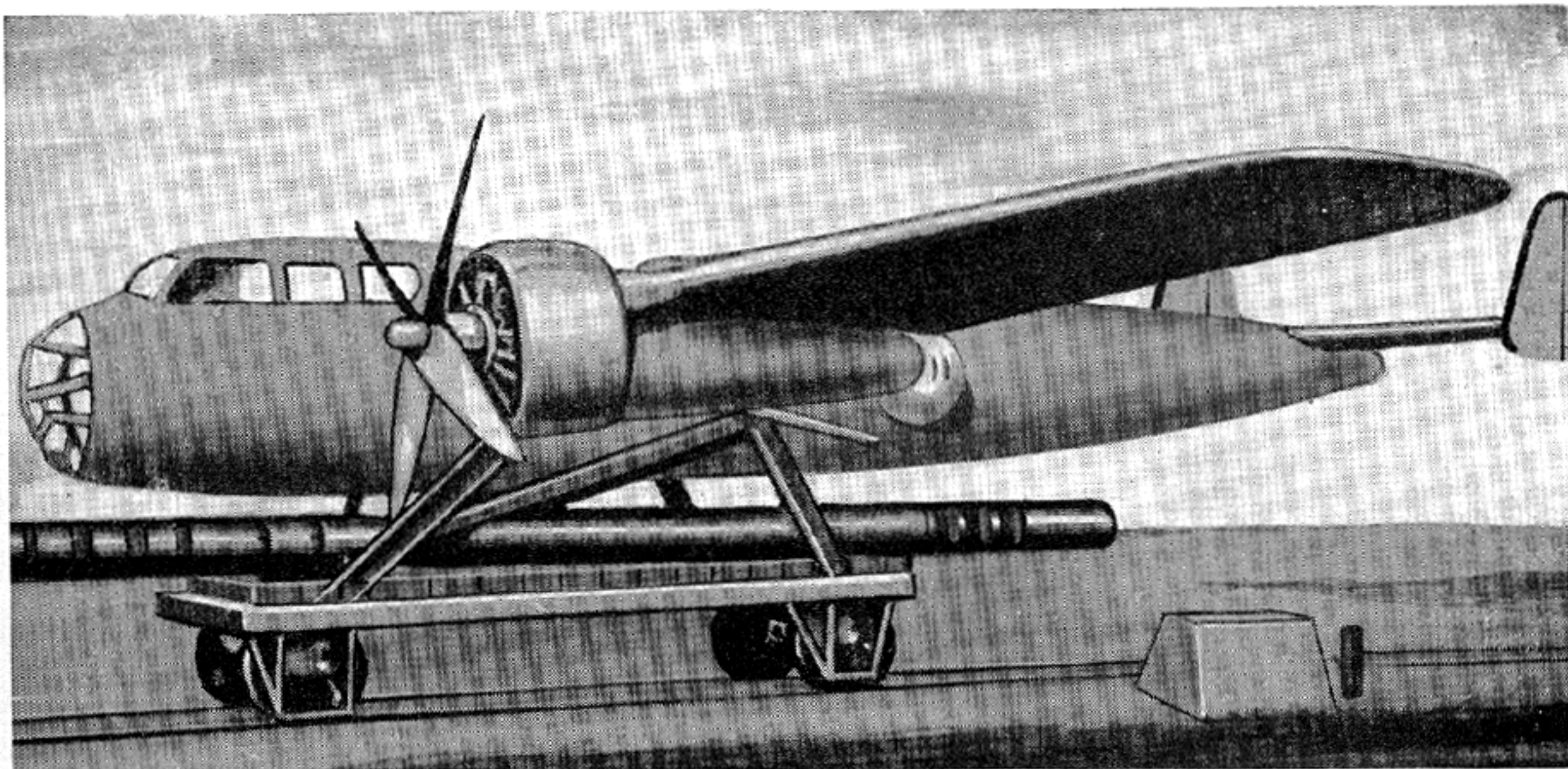

The Davis Principle Applied in World War II. The Germans Attempted Firing a 1500-Pound Shell from this Dornier 217.

in operation, called the recoilless rifle. It was used effectively as highly portable artillery.

Rheinmetall-Borsig developed two types of the Davis gun. The first (the Device 104) had a bore of 14 inches. It fired forward a naval gun projectile of armor-piercing type, weighing 1,500 pounds, and ejecting backwards, as the counter-recoiling projectile, a cartridge case of the same weight. Its muzzle velocity was over 1,000 feet a second. The whole round was loaded on the ground. The tube was 37 feet long and the complete unit (tube, projectile, and cartridge case) weighed 7,500 pounds. Its function was to improve the striking power of aircraft against capital ships. The cannon was mounted on a Dornier 217 attack plane.

The main difficulty the Germans experienced resulted from the muzzle blast. To lead the blast away from the fuselage, a deflector was fitted to each end, but even this did not prove sufficient and armor had to be installed on the bottom of the plane.

The other type of nonrecoiling aircraft cannon used by the Germans was mounted vertically in batteries and was known officially as the SG-113A (*Sonder Gerat* or *special purpose equipment*). The counterprojectile in this arm was

also the cartridge case. It was designed primarily to attack tanks from the air. The FW-190 was used to mount these 45-mm cannon. An armor-piercing projectile was fired straight down against the relatively thin roof armor on the tanks. The aiming and firing of the salvo was controlled by the disturbance of the earth's electric or magnetic field caused by the presence of the tank. Fortunately for the Allies this ultra-modern armament was never produced in quantity. By the time the Nazis were satisfied with the performance of this installation, volume production could not be reached because of the concentrated bombing of German industrial plants.

Also under construction at the same time was another vertical-firing cannon, known as the SG-116. It fired a 3-cm shell straight up and was fitted into the fuselage of a fighter plane. It was sighted and fired by radar when a bomber formation was directly overhead.

The Davis recoilless cannon was not used to more advantage in World War II because the United States between wars did not see fit to exploit the principles originally outlined in the Davis patent, and Germany, although desperately trying to make use of it after being convinced of its possibilities, could not do so following the bombing out of her industry.

## VICKERS AIRCRAFT CANNON (C. O. W. AIRCRAFT CANNON)

The first mounting and firing of a conventional type of cannon from an airplane was in July 1913. The Vickers Ordnance Co., which was conducting a series of tests on the effect of recoil on plane construction, suspended an airplane built by Short Brothers, Ltd., from the interior of a hangar. It was a large pusher biplane and mounted in the front of the cockpit was a two-pounder cannon, a naval quick-firing gun that had been modified for the occasion. Vickers engineers found that the airplane to a certain extent acted as its own recoil cylinder.

As a result of these studies, a test hop was undertaken by a young naval officer, Robert Clark Hall, who successfully fired the altered cannon. He reported that, while there was no damage to the aircraft, "there was a blinding flash and the plane actually seemed to stand still during the explosion of each round."

As the weapon itself was only a worked-over deck cannon, it does not warrant description or

cycle of operation. It had to be loaded manually and its place in aviation ordnance history is simply that of being the first air-borne cannon to be fired without disaster.

The United States became interested in the demonstration and sent a representative abroad to witness the next scheduled firing. This trial was not, however, a success and all work on the gun was stopped in favor of a full-automatic 37-mm cannon then in experimental development by the Coventry Ordnance Works, Coventry, England. The firm's initials were used by British flying officers in naming it the C. O. W., or "Cow," gun.

The cannon proved to be much more usable than the previous one. Upon completion, it was tested at the government range at Shoeburyness. The purpose of the experiments was to determine whether or not the automatic mechanism would function at all angles of elevation and depression.

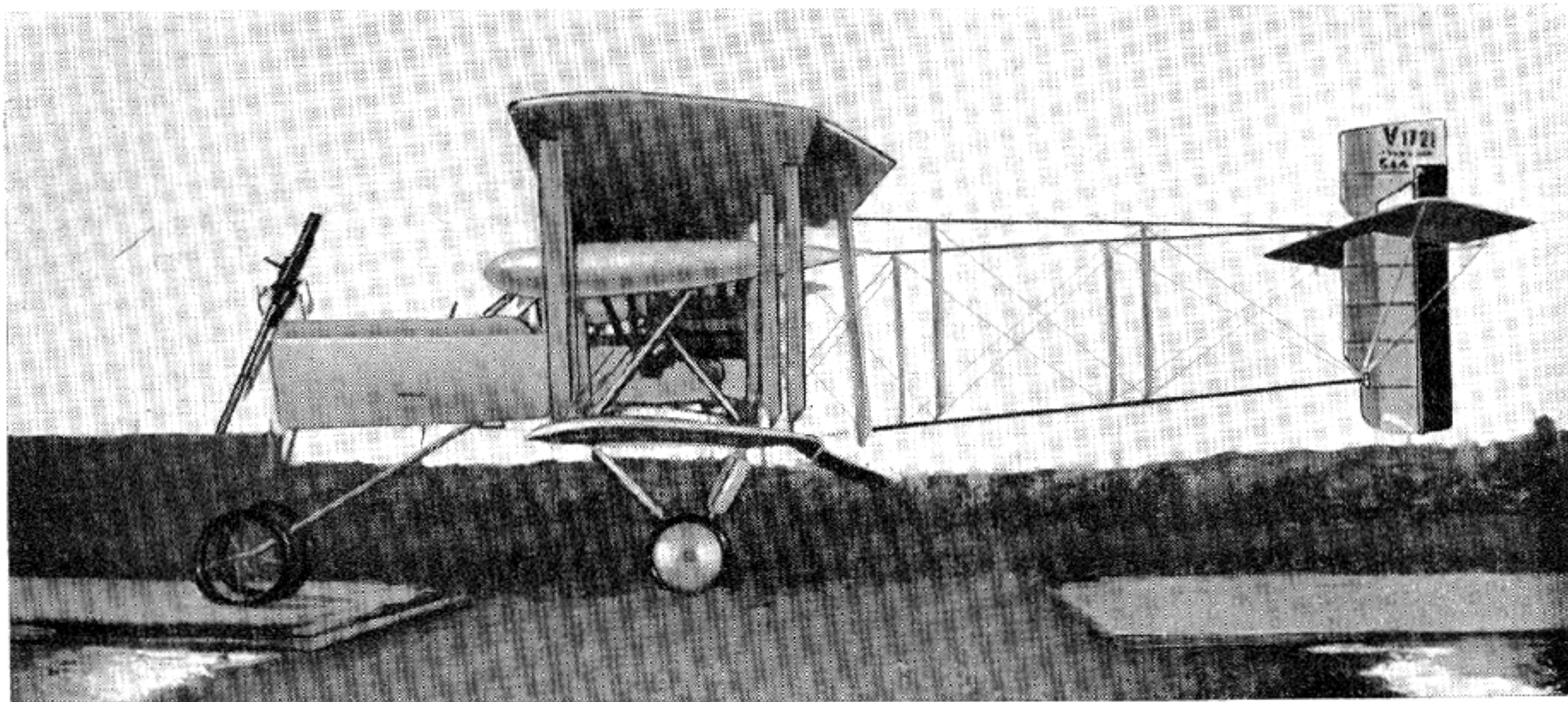

C. O. W. 37-mm Automatic Aircraft Cannon Mounted in a Voisin Battle Plane, 1915.

Three cannon were used. They were first elevated to an angle of  $85^{\circ}$  and fired. Two out of the three emptied the five-shot clip without malfunction. One, however, would not go back to battery, the return spring not being strong enough to position the operating parts. The two guns that fired properly were then depressed until the barrel was vertical. The performance took place on a pier and the weapons functioned well, although the shooting was so close to the water that it drenched both guns and ammunition during the test.

The C. O. W. cannon were used to a very limited degree by the British Navy in the latter days of World War I. They were never popular because of their habit of delivering the terrific impact of recoil into the body of the light plane carrying it. In one instance the gun was mounted in a Voisin plane and, after four shots, the wings came off the fuselage. As a result, the plane plunged into an airdrome, killing all occupants. Such accidents and the common-sense fact that a plane carrying such a weapon in that period

was overloaded contributed to its early abandonment.

The gun operated by what is known as the long-recoil system. The barrel and breech lock were held securely locked together until the distance of the recoil movement was greater than the over-all length of the incoming round. The lock was then freed and remained held to the rear while the counterrecoiling barrel went into battery, literally pulling the chamber off the empty cartridge case. This type of action, which was simply a scaled-up version of the Chauchat long-recoil-operated machine rifle, was quite commonly used on large-bore automatic weapons. While slow, it was reliable and solved such problems as the necessity of opening the breech under high gas pressure if short recoil were used. The gun had an air-cooled barrel, was magazine fed, and fired both semi- and full automatic.

To fire the C. O. W. automatic cannon, the five-round clip is first put into position with the bolt forward. The gunner, with the aid of a crank, jacks the operating mechanism to the

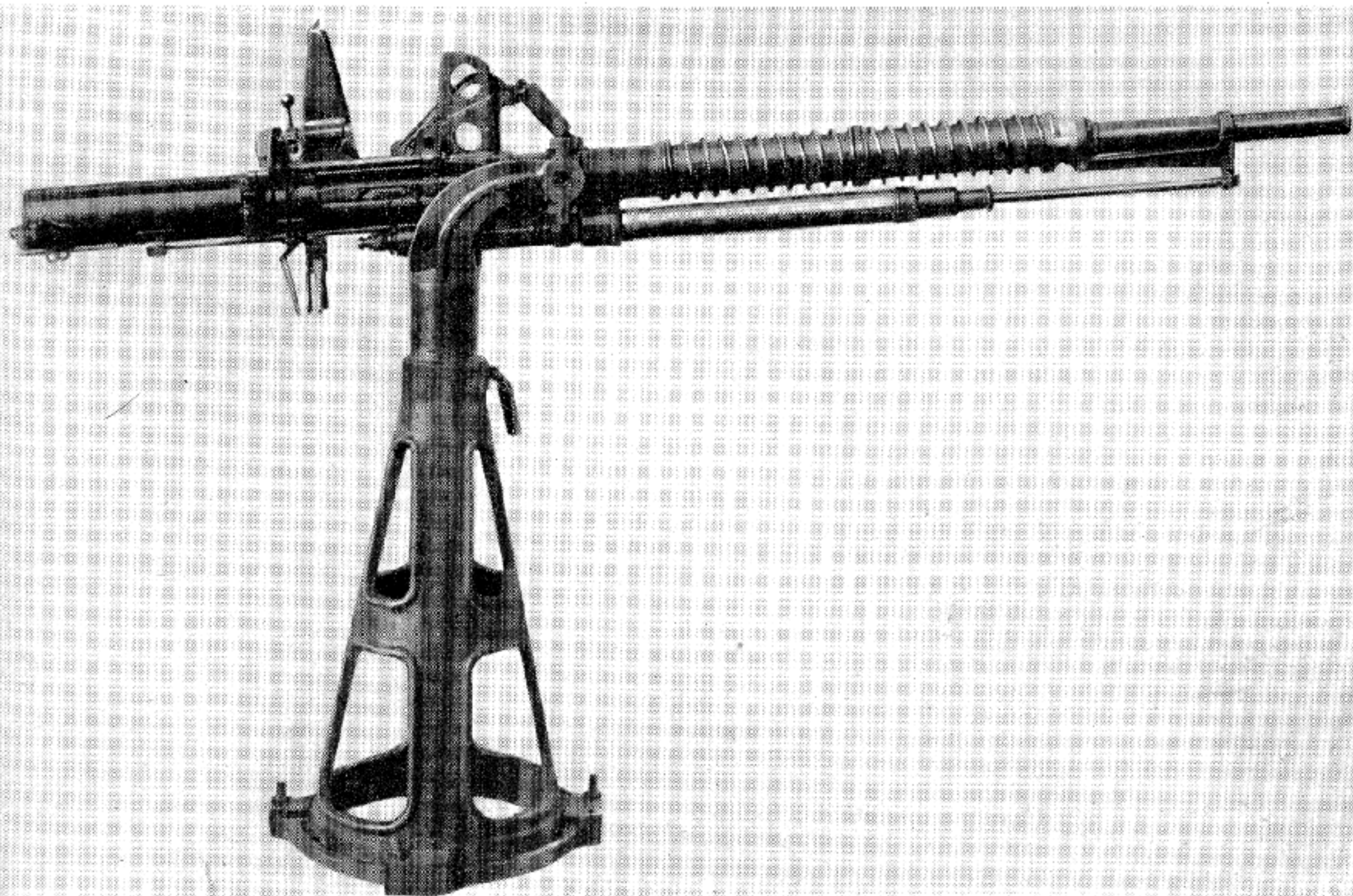

C. O. W. 37-mm Automatic Aircraft Cannon Mk III.

rear until the holding device stops the rammer and carrier frame. Upon release, the barrel returns to battery and at the instant of doing so releases the carrier. The latter strips the first round from the feeder. Upon chambering it, the rotating bolt is locked behind the round.

The weapon now being loaded and ready for firing, the trigger is depressed. The force of the exploding powder starts the barrel, the breech lock, and carrier to the rear, all rigidly locked together. After the assembly has traveled a distance greater than the over-all length of the incoming round, the breechblock is cammed a partial revolution and the carrier to which the extractor is attached is engaged by its holding sear. The barrel can then start back to its former position, while the carrier and extractor remain stationary with the extractor claws over the rim of the fired cartridge case. The barrel, in going forward, separates the chamber from the empty case.

Just before the barrel completes counterrecoil movement, a dog is cammed in that releases the carrier to start forward. On the first movement the ejector pivots the empty case through the ejection slot in the bottom of the receiver. Continued travel causes a rib on the carrier to push the loaded cartridge in the feed mouth into the chamber. The rim of the live case, upon being seated, strikes a device that rotates the bolt, rigidly locking it to the barrel extension. The carrier then completes full movement forward and the extractor claws are forced over the rim of the loaded round. If the trigger is held to the rear, the striker will again fly forward to discharge the weapon.

At the same time, the British developed a few larger experimental models with 47-mm and 75-mm bores. The latter were made for the French at their request.

Since the conventional rifle-caliber machine guns played the dominant role in early air warfare, these pioneer cannon, as far as the British were concerned, did not see too much action and in the years following the Armistice they met with little or no official encouragement for future development.

During the twenties and early thirties the Vickers Armstrong Co. copied the design of the C. O. W. 37-mm gun and proceeded to refine it,

keeping the bore at 37 millimeters and adapting it for installation in large seaplanes. The Blackburn "Perth" flying boat first mounted the gun.

It employed the identical system of long recoil for operation. In contrast with the original C. O. W., this air-cooled clip-fed gun had separated recoil and counterrecoil casings below the barrel and the mainspring had been housed. A crank was used to retract the mechanism for loading.

Upon orders from the Royal Air Force, the Vickers Co. produced a 40-mm cannon, using the same cartridge as the antiaircraft batteries with a muzzle velocity of 2,500 feet a second. Although British military authorities gave Percy R. Higson of Vickers much credit for the design of the Vickers-Armstrong 40-mm cannon, in reality it was fundamentally the firing mechanism of the Coventry Ordnance Works gun of a much earlier date.

Test firing was first done in August 1939 and the results were considered satisfactory. A Wellington bomber was soon equipped with one such gun in the nose. It was contemplated placing another in a power-driven turret then under consideration, but this project was dropped in favor of rifle-caliber machine guns. It was possible to have six cartridges ready to fire, if desired, one in the chamber and five in the cylindrical magazine. In this type of feed a center coil spring pushed each round into place for feeding.

After the design was considered acceptable, the Birmingham Small Arms Co. was also engaged by the government to make the weapons and carry on additional development. July 1940 was set as the delivery date for the first guns off the assembly line.

In arming twin-engine planes with large-bore automatic cannon having an extremely high muzzle velocity, Great Britain was following the example of the Russians. These high priority cannon were to be used offensively against shipping, submarines, power plants, and large storage tanks; and defensively on invasion barges and shipping in general. All development work was actively supported by the Coastal Command and the Fleet Air Arm, which had found from experience that smaller bore cannon, even in multiple installations, lacked sufficient striking power against these targets.



Vickers-Armstrong 37-mm Automatic Aircraft Cannon, Mounted in a Blackburn "Perth" Flying Boat.

The next progressive step was the use of a predictor sight which triggered the operating mechanism when on the target and the whole clip of five rounds was fired automatically.

Against shipping it was decided to concentrate fire on a vessel's boilers. All patrol pilots using aircraft so armed were provided with drawings, diagrams, and photographs of various types of ships showing boiler locations.

Again following the Russian pattern for ground support, the Ministry of Aircraft Production authorized the immediate design of a single-engine monoplane for low-altitude use against tanks, small ships, and similar land and sea targets. The aircraft was to be fitted with twin 40-mm Vickers automatic belt-fed cannon, mounted in the nose of the fuselage. A single Rolls Royce Model 45 low-altitude engine with pusher-type propeller powered the plane which had a top speed of 250 miles an hour.

The engine and the pilot's compartment were heavily armored against small arms ground fire, with no defensive armament for use against enemy aircraft. This special objectives plane had only a three- or four-hour patrol range. Operational use of the craft was dependent upon the protection being afforded at all times by an adequate "umbrella" of fighters. The Air Staff felt

that such an aircraft would form an important element as an Army support weapon.

There is also a record that the Ministry of Aircraft ordered 12 Hurricane fighters equipped with two 40-mm cannon, one mounted underneath each wing for firing outside the propeller arc. These planes, upon being modified, were shipped to the Middle East to be used against tanks.

Colonel Moore-Brabazon, the Minister of Air Production, was responsible for the air-borne cannon program and the passing years have proved it to be broad, intelligently conceived, and done in a manner that produced the greatest results in critical times. The Air Ministry, however, conceded it was following closely Russian strategists in this field, as these early advocates of big-bore ordnance, both ground and air-borne, were setting the pattern on the eastern front in supporting their infantry with cannon-bearing planes.

The British, in the latter days of World War II, turned to an even larger cannon. This time Vickers scaled up the same battle-tested mechanism and produced a 57-mm automatic gun that was placed in the nose of the Mosquito plywood bomber. This six-pounder, as the British always referred to it, had terrific powers of destruction and saw considerable active service before the end of the war.

## REVELLI AIRCRAFT CANNON

The Italian Air Force, having some of the largest bombing planes of World War I (the Caponi and Savoia-Pomilio), made an attempt to arm them with air-borne artillery. It turned to the well-known inventor, Bethel Abiel Revelli, to answer this problem. The result was a semiautomatic 25.4-mm cannon, chambered for a 1-inch projectile. Revelli claimed that work commenced on this cannon as early as 1913. It was classified as light (99 pounds), air cooled, long-recoil operated, magazine fed, and capable of firing its contents of eight cartridges in 2 seconds. The muzzle velocity was in excess of 1,320 feet a second. The cannon was strictly a flexible gun and was easily adapted for mounting on a Scarff ring.

The Fiat Co. at Turin, Italy, after making 200 of these guns, then officially called the Revelli (or Fiat) model 1917, sent one of its officials, Francisco Negri, to England in order to interest that government in arming bombing planes with the gun. British air officers, after witnessing the demonstration and examining the mechanism, pronounced it to be a copy of their own Vickers 37-mm, which they felt was a superior piece of ordnance that could also fire an explosive projectile without violating international law. In fact, Vickers officials were highly critical of the Italian company's ethics in sending this alleged copy of one of their own guns to England for testing.

Thereafter the Fiat Co. made only the original order and destroyed the manufacturing drawings, devoting its time to producing an aircraft machine gun.

Commander Garnier, of the French arsenal at Puteaux, at the completion of a trial of the Revelli conducted by his government, stated that he did not believe the weapon met the needs of the French Air Force for the following reasons: (1) For incendiary use the 11-mm Vickers machine gun was entirely satisfactory; and (2)

the manufacture of a supersensitive fuze (or for that matter a fuze of any sort) was a difficult thing for so small a projectile as the 25.4-mm one.

Even Italian Air Force officers complained about mounting this gun with fuzed ammunition, as a jam in the act of feeding with an up-to-now-unproved fuze would result in disaster if a malfunction took place while in flight. All attempts to produce a bore-safe fuze resulted in failure of the projectiles to explode on the target on an average of two out of every ten tested.

After 12 Caponi bombers were armed with the Revelli cannon, an order was issued not to equip planes with cannon of any sort, as machine guns were considered better all-around armament. The consensus was that, while the weapon itself was undoubtedly reliable in its action, it had a bore that seemed too small for causing explosive damage and too large for high-speed machine-gun work.

To fire the Revelli 25-mm aircraft cannon, the operator first installs the loaded magazine in position and pulls the cocking handle all the way to the rear. Being released to go forward under spring tension, it chambers a round, locks the bolt, and cocks the piece. When the firing button is pressed, it lifts up the sear, the nose of which lets go of the striker. Driven forward by its own spring, the latter fires the cartridge. The barrel and bolt recoil together securely locked for three-quarters of an inch at which point the cocking handle hits the vertical arm of the opening lever.

This arm pivots and the horizontal arm engages under and raises the cocking handle, freeing the bolt lugs from the resisting shoulders. The barrel is then brought forward by its return spring, butting against a shoulder on the body casing, which limits its movement.

The bolt continues to recoil, the extractor withdrawing the empty cartridge case and hold-

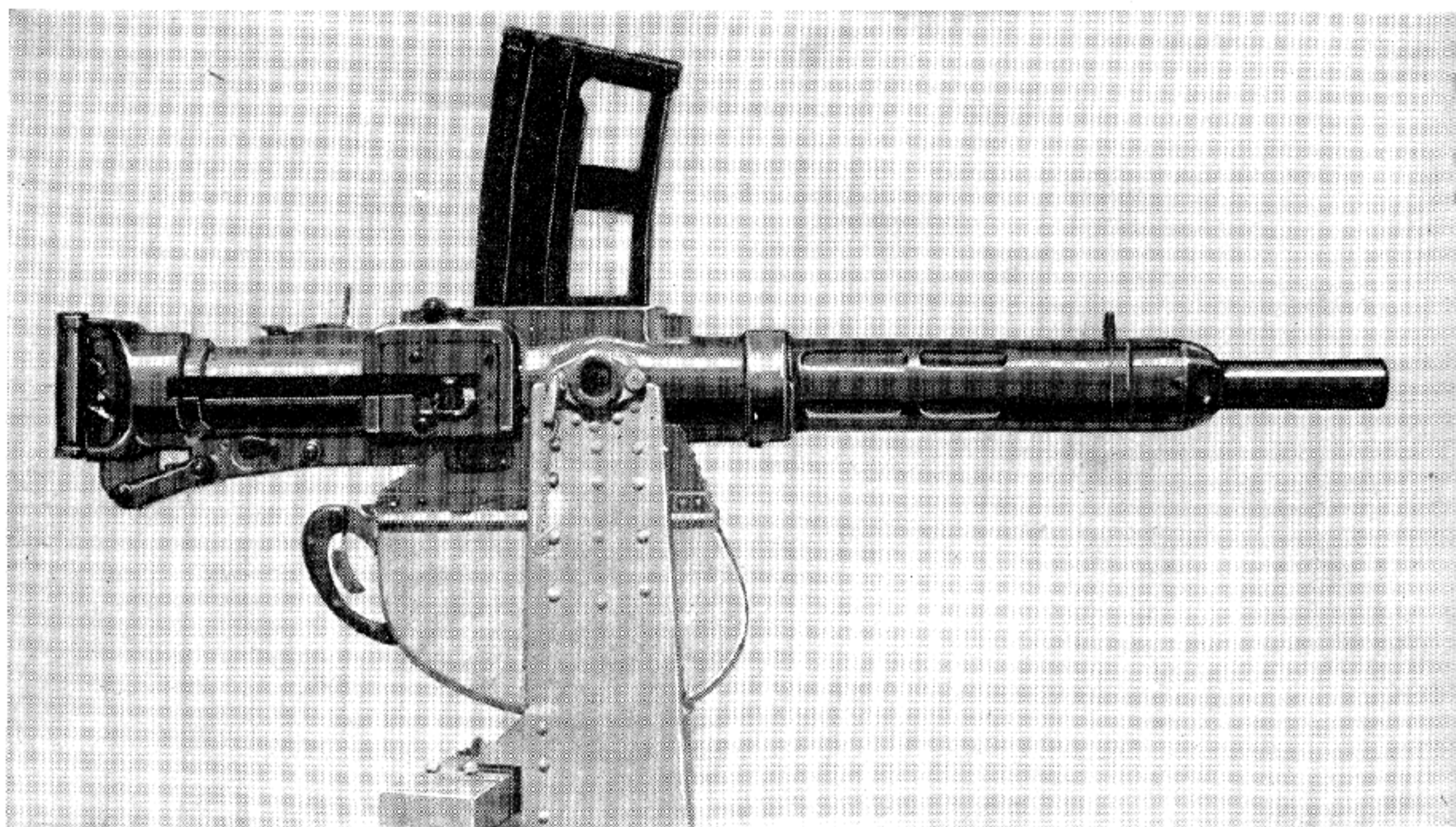

Fiat (Revelli) 25-mm Aircraft Cannon.

ing it until its base strikes the ejector and is pivoted out through the ejection slot in the bottom of the receiver.

The final recoil movement of the bolt fully compresses the driving spring. The hitting of the rear buffer absorbs the surplus energy and sends the operating parts into counterrecoil. The feed rib on top of the bolt strips a round out of the magazine and starts it into the chamber. When the striker makes contact with the nose of the sear, it is held in the cocked position while the bolt continues on into battery.

Three-quarters of an inch before it is fully home, the cocking handle engages the vertical arm of the operating lever. This arm pivots and engages under the retracting handle, causing it

to raise and rotate the locking lugs into their recesses in the receiver. The final movement now makes it possible with a push of the firing button to repeat the cycle again.

In the event of a stoppage, the gunner can hold the mechanism in the rear-seared position for inspection or maintenance by a very unique method—the charging handle is pulled all the way to the rear and the tail of the ejector pushed down by the thumb, causing this piece to pivot and hold the assembly to the rear. To close the action, all that is necessary is to give the charging handle a smart pull rearward and release it. The spring-loaded ejector then lifts out of the way, permitting the operating parts to go forward.



## PUTEAUX 37-MM AIRCRAFT CANNON

Although the British Royal Air Force was the first to fire a cannon successfully from an airplane, it remained for the artillery-minded French to achieve the major development on cannon for aircraft during World War I. These very realistic people approached the problem in the most practical way imaginable. The wheels of a reliable field piece were simply removed and it was bolted in the forward part of the cockpit of the latest Voisin plane. The aircraft was also armored, a fact which, in itself, was quite revolutionary. This combination made its initial appearance in June 1914.

Arrangements had all been made in secrecy and the experiment was first disclosed when a cannon projectile ploughed through a French farmhouse early one morning, fortunately without injury to anyone. An alert reporter solved the mystery which had puzzled the nearby countryside. No explosion had been heard and the farmhouse was miles away from any possible naval firing. Everyone, except the careless gunner and the military authorities, was satisfied when it was discovered that a large airplane manufactured by Gabriel Voisin, was being tested at Issyles-Moulineaux, where military



Puteaux 37-mm Aircraft Cannon (Semiautomatic) Mounted on a French Bombing Plane, 1916.

personnel had been air-firing this large-bore aerial cannon for several months.

The weapon was a 37-mm Hotchkiss Model 1885, and, while not automatic in principle, it was referred to, in a complimentary way, as a "quick-firing gun." A whole squadron of Voisins was equipped with this aerial artillery and immediately assigned to the defense of Paris. Upon declaration of war by Germany a few months later, more such planes were sent to bases behind the lines to act as bomber escorts.

The performance of the *avions-cannons* was considered satisfactory from the start, and the protection they offered the bombers was so good that losses through attack by German aircraft were almost negligible. The French had a great advantage in the awesome aerial armament they carried at the very outbreak of the war, at a time when German aviators were carrying nothing more than pistols and repeating rifles.

The freedom of bombing squadrons from attack at the beginning of hostilities was taken by the French to mean that opposing flyers were over-awed by the cannon-bearing escort. There is no question that the enemy had great respect for the French Voisins and did not go too far out of its way to engage them until the mounting of rifle-caliber machine guns in its fighters became prevalent. Thereafter aerial cannon played a secondary role to machine guns, though the French Air Force never stopped development of aircraft cannon as offensive aerial weapons.

Many spectacular kills have been credited to this innovation in warfare. As early as 1915 such a gun was mounted in the rear seat of a plane piloted by Norman Prince, an American member of the famous Lafayette Escadrille. Bob Scanlon, an American negro and an ex-boxer, acted as the gunner. On 10 January of that year, Prince and Scanlon scored their first victory by making a direct hit on an enemy plane with their 37-mm cannon.

Mounting of armament of such size naturally produced serious and often insoluble problems, such as stresses, shock from recoil, and vulnerability after firing before the single-shot weapon was reloaded. The French, however, continued to attempt correction of these things, and many inducements were offered inventors. Things remained in an uncertain status until early in 1917

when Marc Birkigt, chief engineer for Hispano-Suiza, evolved an entirely new method for utilizing cannon in aerial fighting.

Birkigt, familiar with aircraft engine design, created a motor whereby a gun could be mounted in the engine block and the projectile fired through the propeller hub. With a cannon so installed, the plane, which up to this time had been only a gun platform, now became the object to be pointed at the enemy. The pilot now had only to line up fixed sights that were parallel to the center line of the bore in order to aim his gun. The French greeted this achievement with renewed effort on the part of their ordnance developers to better the gun that would be a part of the new system.

The weapon decided upon was a 37-mm semi-automatic cannon, manufactured by the Puteaux Arsenal originally as a highly mobile fast-firing field piece. It had been modified to use a recoil-operated breech opening and lightened for aircraft use. The cannon was mounted in the V of the motor that drove the propeller by means of a reduction gear. The muzzle could thus project through the hub. The recoil ejected the empty case, cocked the firing mechanism and remained in the ready position for the pilot to close the breech manually. The breech consisted of a sliding block with a rotary motion in the breech housing that not only locked and unlocked but likewise operated in an open position.

Functioning of the Puteaux 37-mm aircraft cannon is as follows: As the barrel and bolt recoil, a cam turns the lugs allowing the bolt to be freed and to drop until it strikes the base of the extractors. The latter are pivoted in such a way that their upper parts are forced backwards, after the empty case is thrown out through the opening in the receiver. The pilot takes a loaded cartridge from a rack at the right of his seat and positions it in the chamber, at the same time rotating the breech with his fingers. Reloading and locking are thus accomplished manually and he is again ready to fire.

The guns were fitted with two types of barrels that were interchangeable. One was a smooth bore; the other rifled. Ammunition consisted of canister for the smooth bore and an explosive projectile with an extra-sensitive fuze for the rifled barrel.

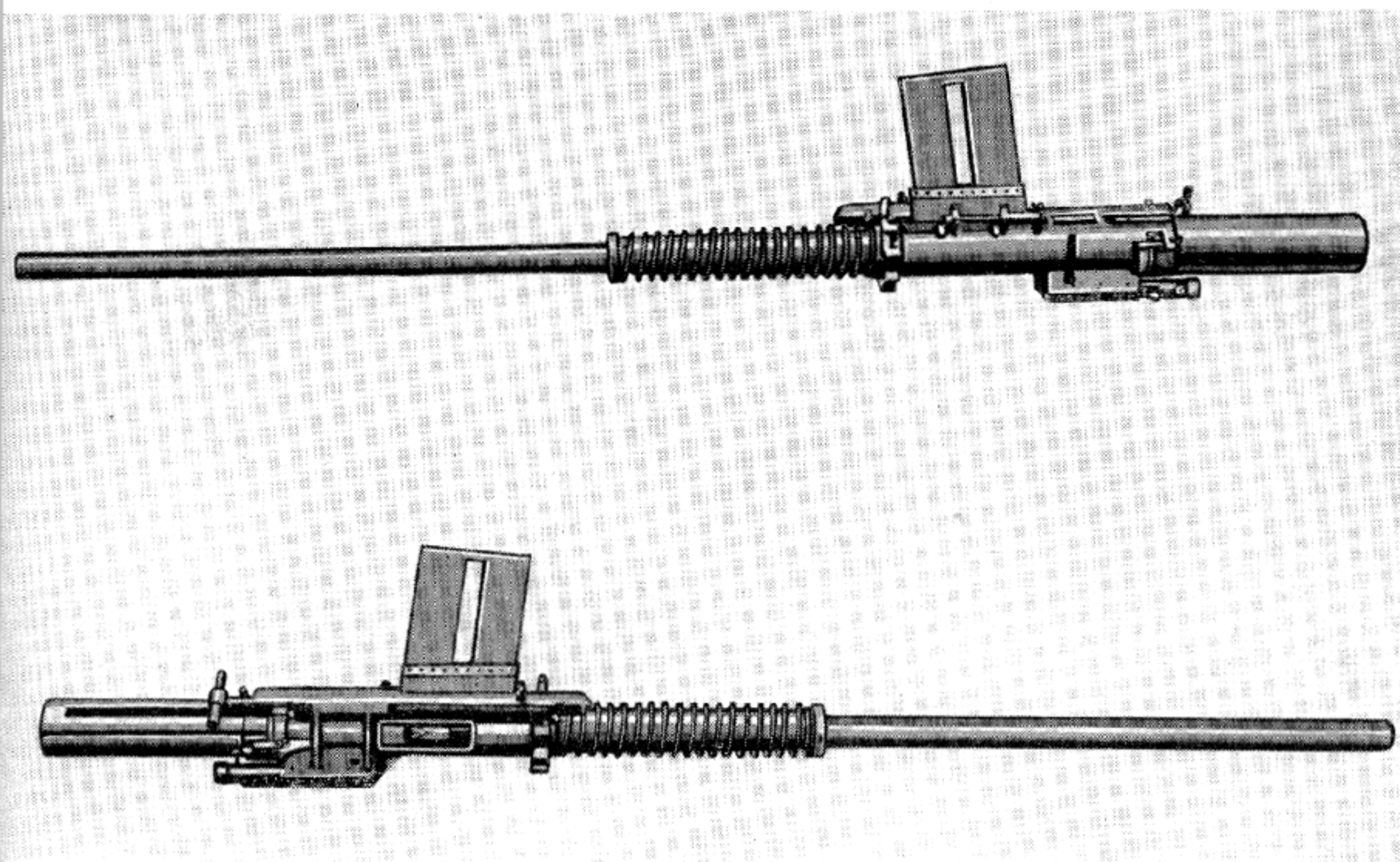

Puteaux 37-mm Automatic Aircraft Cannon.

The projectiles containing high explosives in reality had double fuzes, a contact one and a delayed firing arrangement in the event the target was missed. The latter exploded the charge before reaching the ground, a needed precaution since so much air fighting at the time took place over friendly territory.

Two of France's greatest aerial fighters in the First World War, Major René Fonck and Georges Guynemyer, were credited with officially destroying several enemy planes with cannon fire. Guynemyer originated the canister or shot shell used in a smooth-bore cannon, which was actually an overgrown shotgun. There is no question about the deadliness of such an arrangement when in range. These two aces, however, after much experimentation, finally dropped cannon in favor of high-speed machine guns for their own personal employment. French pilots, in general, did not like the semiautomatic cannon too well and they looked forward to the impending prospect of a full automatic Puteaux that would discharge projectiles at the maximum rate of 60 a minute.

The system of operation of this new cannon was more that of a scaled-up Chauchat automatic rifle than anything else. Activated by long recoil, the large return spring encircled the barrel aided by a smaller one in a cylinder. It also had a breech-recoil spring in a housing very much like the Chauchat. It was mounted in the V of the motor exactly like the earlier Puteaux.

In order to fire the improved full automatic cannon, the gunner first drops five rounds in the hopper on the receiver and then opens the breech by means of a handle. A cartridge is inserted in the feedway through the ejection port. The sear is released by pulling a chain leading back to the cockpit. The bolt is driven forward by the strong driving spring and pushes the positioned round into the chamber. The breech-lock then rotates to fasten the bolt to the barrel at the moment of firing.

At the explosion the barrel and bolt recoil together and at a distance greater than the over-all length of the loaded cartridge the rearward movement stops and the barrel starts into counterrecoil. The bolt, meanwhile, is held to the

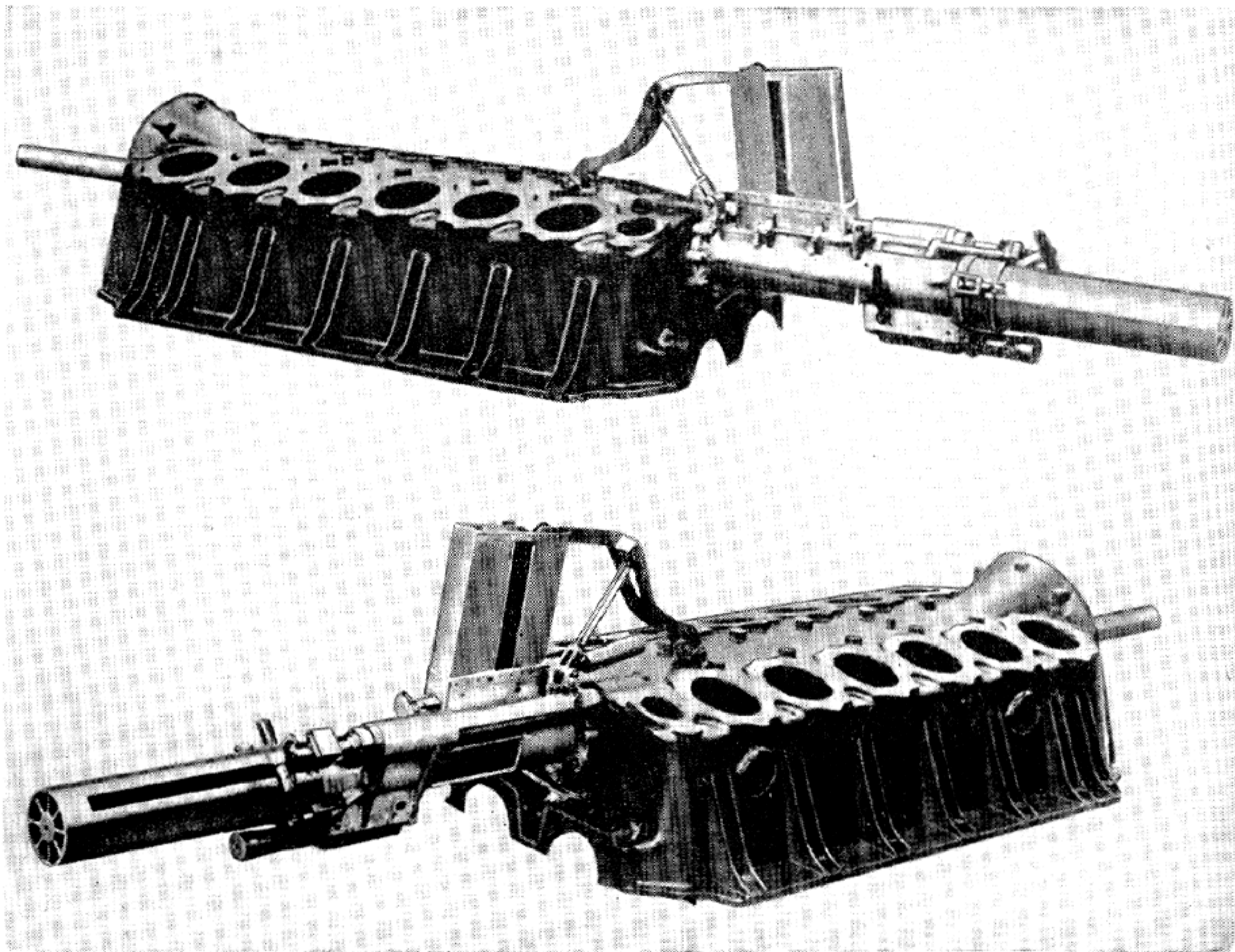

Puteaux 37-mm Aircraft Cannon, Mounted in the Cylinder Block of a Hispano-Suiza Engine to Fire through the Propeller Hub.

rear after the lugs on the breech lock have been rotated, thus freeing the two pieces. As the barrel starts to batter, two extractors, one on each side of the breech lock, cling to the rim of the cartridge as the counterrecoil chamber is literally pulled off the empty case.

At a point approximately three-quarters of the way home, a stud on the barrel causes one extractor to be disengaged. At the same time it brings the ejector to bear on the base of the newly released cartridge and pivots the empty case out the ejection port. If the trigger remains depressed a tenth of a second after the barrel reaches battery, a sear is tripped that starts the bolt into counterrecoil. A round that by now has dropped in the feedway by gravity is chambered and the piece is again locked and fired.

The delay before the bolt was put into coun-

terrecoil made this system of operation notoriously slow, but as high speeds were seldom demanded of cannon, it was quite popular with designers as a reliable method of operating big-caliber automatic mechanisms. Not until 7 November 1917, did firing reach a state that the weapon was thought capable of successful air application. Leading French airmen, while looking forward to using perfected automatic cannon, still mounted the inferior semiautomatics as they felt the former weapon was still not sufficiently proved.

Commandant Garnier and M. Stalporte of the Puteaux Arsenal are credited with the devisement of the full automatic aircraft cannon but, like many other things in process of development at the time, it never saw service in the war. It was not until 7 September 1918, that the French

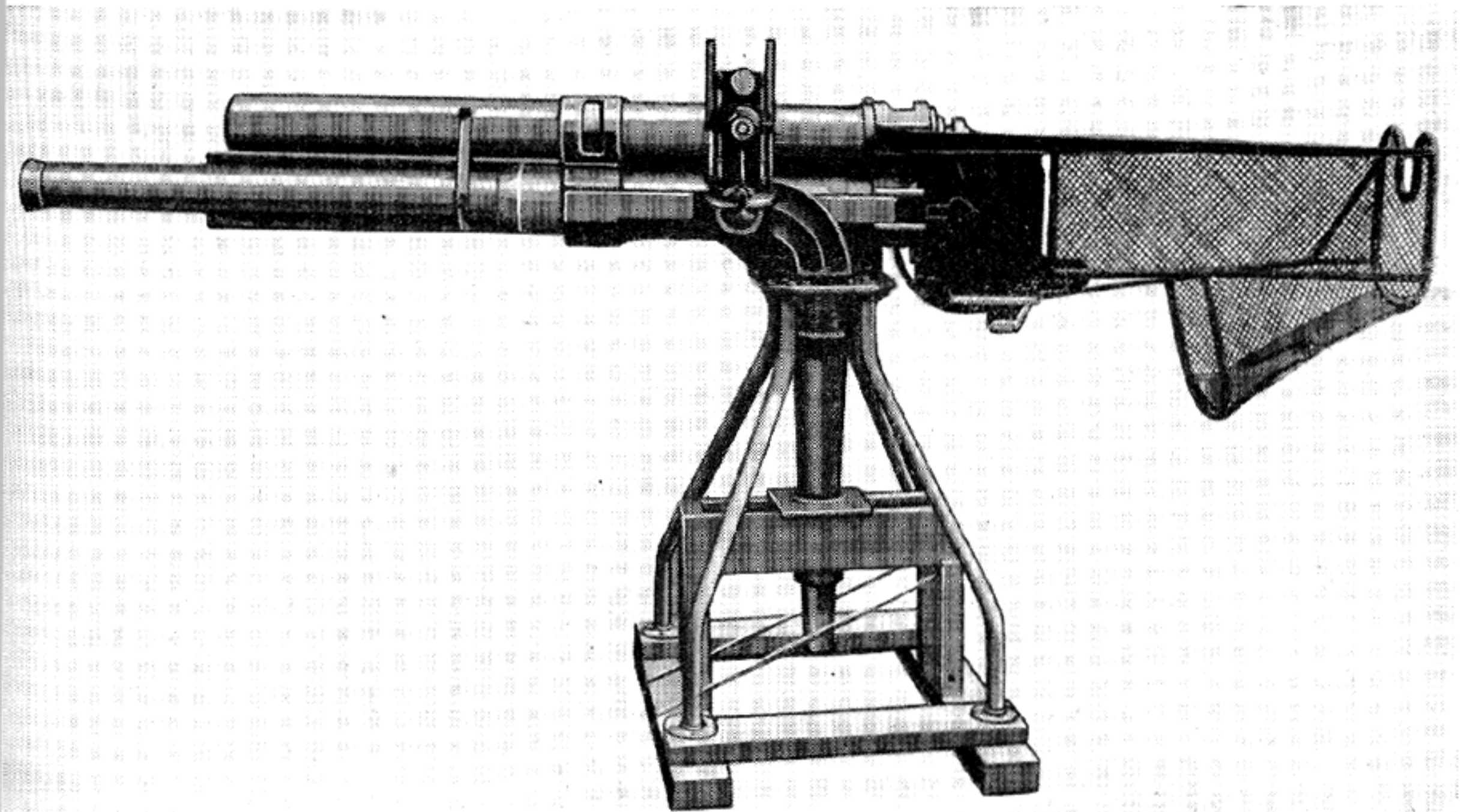

Puteaux 47-mm Aircraft Bombardment Cannon.

Minister of Armament informed the United States Army Automatic Arms Division that the automatic 37-mm Puteaux cannon was acceptable for aircraft installation. He doubted that enough would be manufactured before 1 April 1919, to arm any appreciable number of planes.

Two guns were ordered from France by the United States Army for experimental purposes and contracts were offered to encourage American manufacturers and designers to submit bids. It was stated that any company turning out a copy of this weapon capable of passing the standard Army test could start immediate large-scale production.

The United Shoe Machinery Co., of Beverly, Mass., agreed to produce two trial cannon under this arrangement. These guns were successfully tested at Aberdeen Proving Ground in November 1918, but by this time the war was over and the whole project dropped by mutual agreement.

For use against ground targets and small shipping, even larger cannon were placed in aircraft by the French. These were also made at the Puteaux Arsenal and, like the original model, were semiautomatic. One was a 47-mm cannon,

called by the air force "bombardment cannon." It was so installed that, in vertical flight, the angled gun could be brought to bear on railway stations, trenches, wagon trains, troop columns, etc. This type of weapon was used quite effectively during the war. At the end of the hostilities an even larger gun (75-mm) was mounted in a plane, so placed that it fired straight down through the floor. But while successfully air fired, it did not have actual combat use.

The origin of the 47-mm gun was interesting. The French, being thrifty people, had on hand great stocks of Hotchkiss manually operated revolving cannon with 47-mm barrels. As they were very light in construction and highly available, reliable locking mechanisms were attached to these barrels of another generation for renewed service.

The French continued with development following the war whenever time and money would permit and, until they were overrun by the Germans in the early part of World War II, experimental work was still being done on the Puteaux automatic cannon.

# BECKER-SEMAG-OERLIKON AUTOMATIC AIRCRAFT CANNONS

## Becker Cannon

When the leaders of the German Air Force, during the latter days of the first World War, ordered the placing of armor around the vital parts of their huge Gotha bombing planes, they realized that they had not only made the rifle-caliber machine guns of the Allies obsolete but their own as well. In order to find some suitable weapon that would deal adequately with the situation and still not violate the St. Petersburg Treaty relating to small-bore explosive projec-

tiles, they turned to the invention of Reinhold Becker, of Krefeld, Germany, who was then producing an aircraft cannon at his own firm, the Becker Stahlwerke at Willich am Rhein. His patent had been applied for in 1914.

The 20-mm Becker cannon was extremely light in weight, magazine fed and used straight blow-back for its operating power. It was full automatic, with a rate of fire given as 400 rounds a minute and, when first used by the Germans, employed a nonexploding solid projectile.

It consists principally of a barrel which is

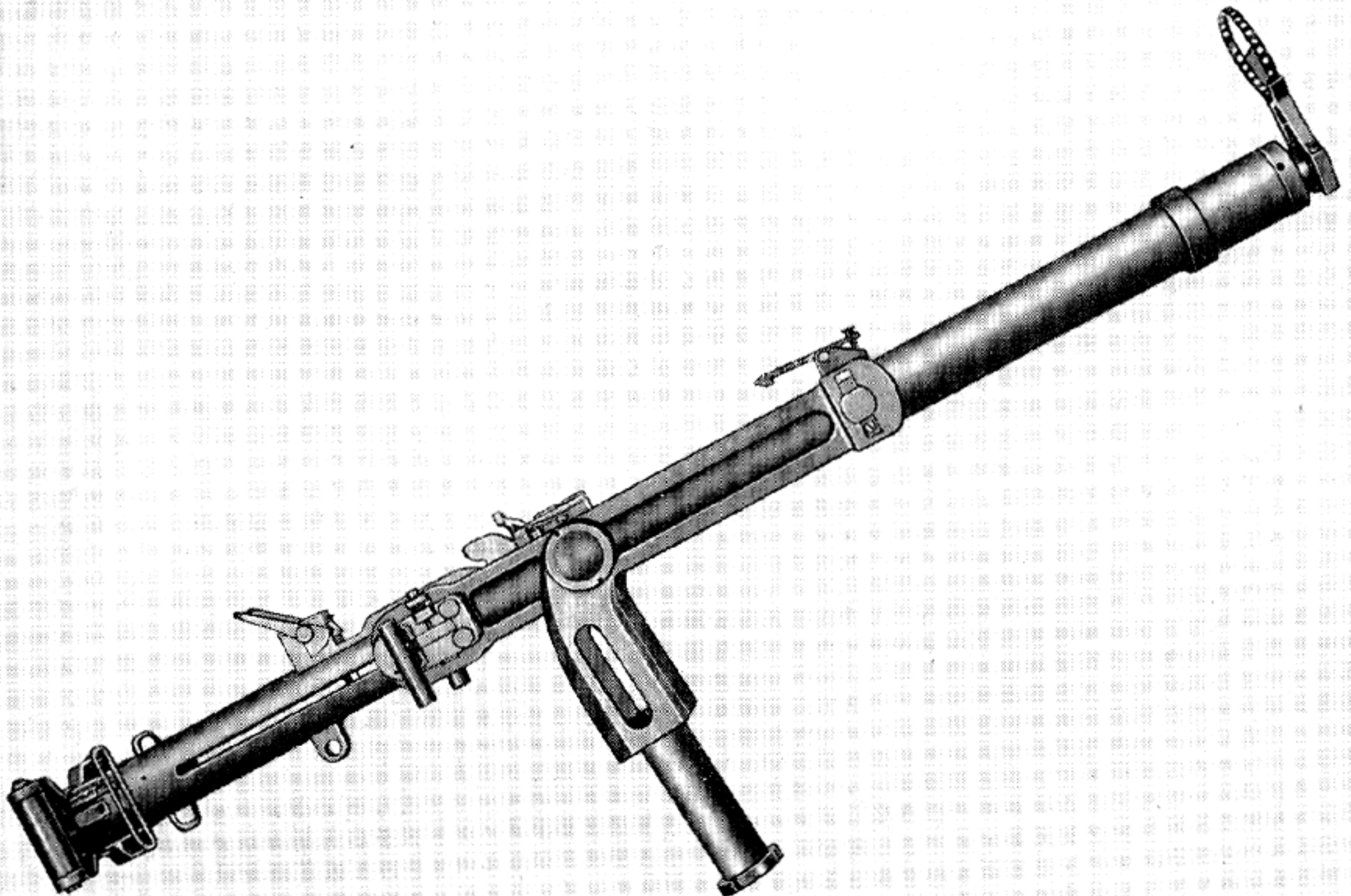

Becker 20-mm Automatic Aircraft Cannon, Model 1918 (Flexible).

forged to trunnions that rest in the pintle. A cylindrical receiver having a magazine latch on top and an ejection slot in the bottom is firmly screwed to the barrel. The rear end of the receiver is closed by a portion which houses the sear notch and a round end block which contains the trigger, safety, and buffer mechanism. These parts do not recoil. The barrel is partially covered by a sliding sleeve which houses the driving spring. This spring is seated at its rear end against a shoulder of the barrel, and at its forward end on an adjustable position in the shoulder of the sleeve. This in turn has at its lower end trunnions for two side bars that connect the sleeve and the bolt. The connection with the bolt is made by a flat key which passes all the way through this member and projects out of each side through slots in the receiver. The charging handles are riveted to the side pieces. The bolt rides in its slideway in the receiver and contains the firing pin. The latter is actuated by a bell-crank arrangement, pivoted in the

bolt, which strikes a step in the receiver during its forward motion.

A rather unusual safety feature is embodied in the Becker. In the chamber at the rear of the projectile but well forward of the point where rupture is most likely to occur, a plunger passes through the top of the chamber which bears a spring-loaded pawl at its outer end. The case, when positioned, presses the plunger flush with the chamber walls and the pawl is raised. If the case is ruptured or fails to extract, the catch will engage a special hook fastened to the sleeve when that part is in its full recoil. In this manner the gun is stopped until the unextracted case is removed.

As another unique feature the bolt continues to move forward during the firing of the shot by virtue of its kinetic energy. This insures an absolutely gas-tight closure of the rear end of the barrel and a minimum of recoil, which, after absorbing the terrific forward speed of the heavy bolt assembly, is then only sufficient to drive the bolt to its rearmost position. The cartridge case,

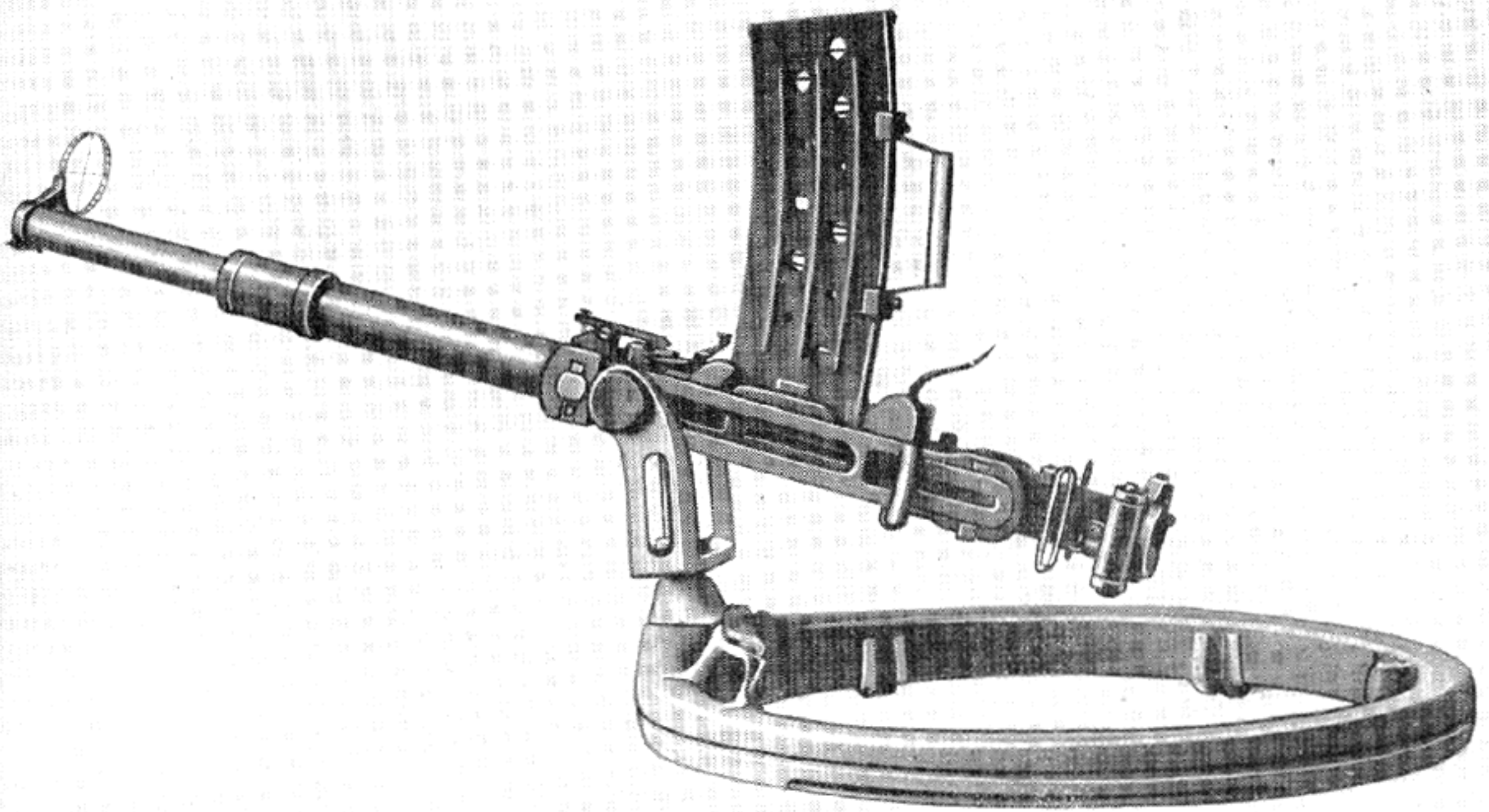

Serial 20-mm Automatic Aircraft Cannon (Flexible).

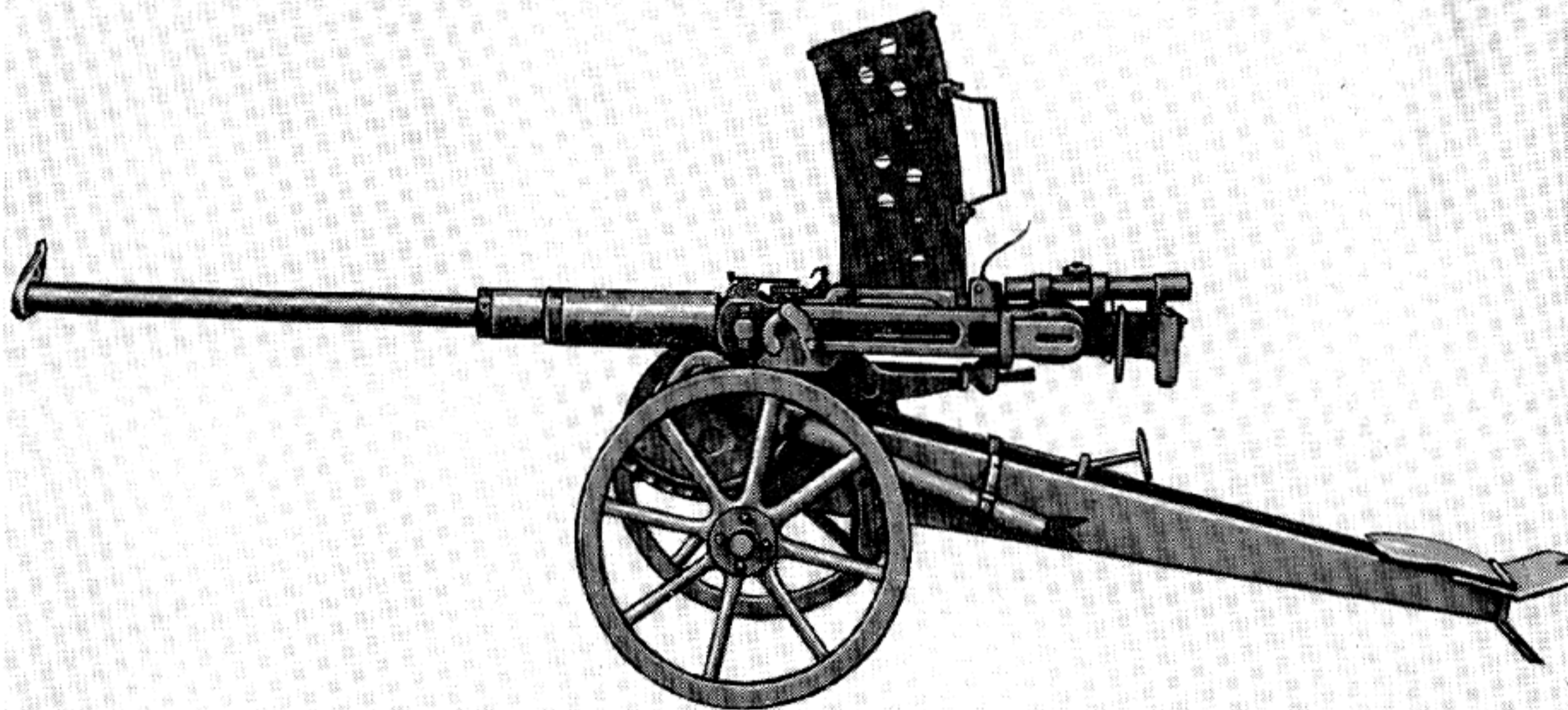

Semag 20-mm Automatic Cannon for Infantry.

while not supported by a locked bolt, is inclosed in the chamber during the instant of explosion and the rearwardly acting gas pressure cannot burst it.

The primer is ignited well before the bolt has reached battery position. With this arrangement the chamber pressure acts on a member of considerable mass which is moving forward. The energy of this fast traveling piece must first be overcome before it can be put in recoil movement by the exploding powder charge.

The cannon had hardly been mounted by the Germans when one of the planes armed with it was shot down by a French fighter. There was great excitement among Allied ordnance specialists at having such an advanced weapon fall into their hands. Although the plane fell in flames and all ammunition was destroyed, the gun itself, mounted flexibly on a single yoke pintle, was salvaged and displayed to high-ranking officers.

After the Armistice the Allies had at their disposal enough captured ammunition to conduct a fair test of the piece. Most of this work was done at the range of the French Puteaux Arsenal. On 31 March 1919, one Becker automatic 20-mm aircraft cannon was brought to the Army's Ord-

nance Department in Washington, D. C. This weapon was marked "2 CMM FLZ. K.—Becker—Typ 2—1045" (the FLZ. K. meant *Flugzeugkanone*, or *Aircraft cannon*).

The Ordnance Department did not show any interest in the cannon other than placing it in its museum at Aberdeen, but France experimented with the mechanism for a number of years, and the conclusions of the board at the Puteaux Arsenal were to the effect that it was very formidable for air combat but could not be classed as such against tanks or heavily armored units.

### Semag Aircraft Cannon

During the attempt to demilitarize Germany after the Treaty of Versailles, Becker formed a connection with the Seebach Maschinenbau Aktien Gesellschaft, a well-known automotive concern, located near Zürich, Switzerland. This move was sponsored by the supposedly non-existent German ordnance office. By starting production of this advanced air cannon in a neutral country, outside the jurisdiction of inter-Allied control and with capital provided by Germany, it felt it would be possible to rearm its forces



with the latest and most improved weapons when the need should arise.

Semag, the name being coined from its initials, manufactured the Becker gun and sold it as an aircraft weapon. In 1921 it introduced its own version, which was a modified Becker. The bore was 20 millimeters, but the barrel and cartridges were longer, giving a higher muzzle velocity. This weapon was called the Semag infantry gun. By early 1923 the company had built and fired a new 25-mm model, using the same action. The Semag 25-mm was mounted on a wheeled carriage and, although it fired successfully, it was considered too heavy. The firm failed before the redesign was completed.

A number of guns were sold to such countries as China and Spain. Long after this firm was but a distant memory, Semag cannon turned up as armament in the fighting between the Chinese and Japanese in the 1930's and during the Spanish Civil War.

### Oerlikon Aircraft Cannon

The financial failure of Semag resulted in its being taken over by the Werkzeug Maschinenfabrik Oerlikon, a machine-tool factory located in Oerlikon, Switzerland, a manufacturing village near Zürich. German capital and management dominated this company too. An ex-German army officer, Emil Bührle, was the manager of the plant. Its modern, one-story saw-tooth type buildings were set up primarily for the production of automatic arms. The plant has often been confused with an older Swiss firm, Oerlikon-Zürich, which produced heavy machine tools, electric locomotives, automobiles, and similar equipment.

The arms plant at once started development and experimental work on 20-mm automatic cannon, based on Becker's patents. The models at hand were provided with official designations to prevent confusion with future production. All guns made on the straight Becker principles were called Type F; weapons based on the Semag design were known as Type L; and Oerlikon development was identified as Type S.

The characteristics of each of the three are summarized as follows:

	F	L	S
Muzzle velocity (M/sec) . . . . .	550-575	670-700	835-870
Rate of fire . . . . .	450	350	280
Recoil force (kg) . . . . .	60- 70	115-120	140-150
Weight (kg) . . . . .	30	43	62
Barrel length (calibers) . . . . .	40	60	70

By early 1935 designs for each of the three types were completed and several new Oerlikon-developed models were constructed and designated respectively FFF, FFL, and FFS. The first model weighed 25 kg complete, including a compressed air charging mechanism, and had a muzzle velocity of 600 M/sec. The cyclic rate was roughly 550 a minute. The FFL and FFS had a proportionately higher velocity and were consequently heavier in weight. In other words, if a prospective customer had need for an extremely lightweight low-velocity cannon with a fairly high rate of fire, the refined Becker gun was the logical choice. However, if high velocity and low rate of fire were demanded, the Semag or Oerlikon type would adequately fulfill the needs.

The specifications naturally made the Becker gun a formidable aircraft weapon, while the Semag and Oerlikon models were very popular with ground forces that had armor to contend with. The successful use of other automatic cannon mounted in the engines of planes to fire through the propeller hubs led also to a wave of predictions by military forecasters that the day of the rifle-caliber machine gun had passed. Another war, they said, would see only the use of automatic shell guns, as the cannon were called on the continent. It was to these ends that the Oerlikon plant turned its full efforts.

Associated with Emil Bührle at Oerlikon was Antoine Gazda, a former Austrian fighter pilot in World War I, who took over the duty of sales promotion. He saw to it that much secrecy surrounded the procurement of the Oerlikon aircraft guns. Each country dealing with Gazda doubtless thought that it alone was making aviation armament's most progressive step. The world has known few salesmen who were his equal.

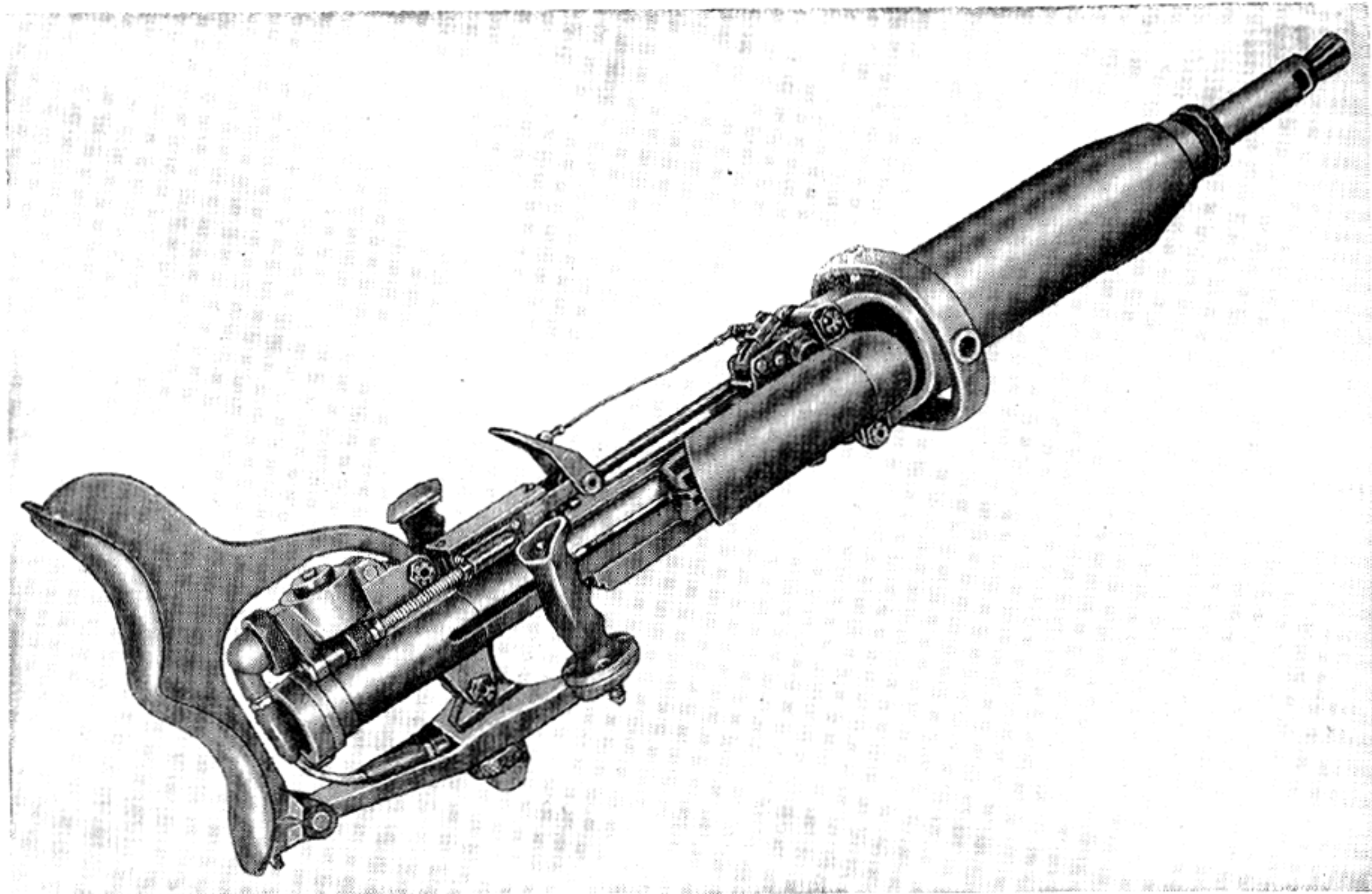

Oerlikon 20-mm Automatic Aircraft Cannon, Model F, (Flexible), Adopted by Germany.

England bought Oerlikon guns as early as 1935 for testing at Enfield, ostensibly for anti-tank work, but in reality for adaptation to aviation use. The United States in 1936 conducted similar trials at its Aberdeen and Dahlgren proving grounds. The cannon was called at the time an anti-aircraft gun, but it was installed in a Hispano-Suiza engine, the engine and gun having been procured from France at the suggestion of the Navy for test purposes.

The French Air Force also began to place Oerlikons in Hispano engines and experimented with them in many of its fighter planes. The possibility of its outright adoption looked so promising that the Hispano Co. negotiated a license to produce the weapon at its own plant near Paris. By 1938 over 400 of this engine-mounted type were in service in the French Air Force. All such guns produced by the Hispano-Suiza Co. were referred to as types 7 and 9 in order not to confuse them with another aircraft cannon on which it contemplated production.

In this same year the British, running their

second trials on the gun at Enfield, turned in a very favorable report on its ability to use deformed or poor quality ammunition. The Royal Navy, desperately in need of a reliable automatic cannon for anti-aircraft use, hastily adopted the FFS for shipboard use and ordered 500,000 rounds of ammunition to be made up immediately. The development of high-explosive projectiles had long been proved successful and all orders carried a stipulation that these be made in proportionate numbers.

Our Government, after years of experimenting on defense against low-flying attack planes after World War I, had not produced anything remotely resembling a reliable automatic cannon to replace the outmoded rifle-caliber machine guns. It quickly followed Britain's example and adopted the model FFS. Manufacture was begun in this country for both Great Britain and our own forces.

Antoine Gazda, never one to restrict his talents geographically, had early turned his attention to the pressing need of the Far East for reliable

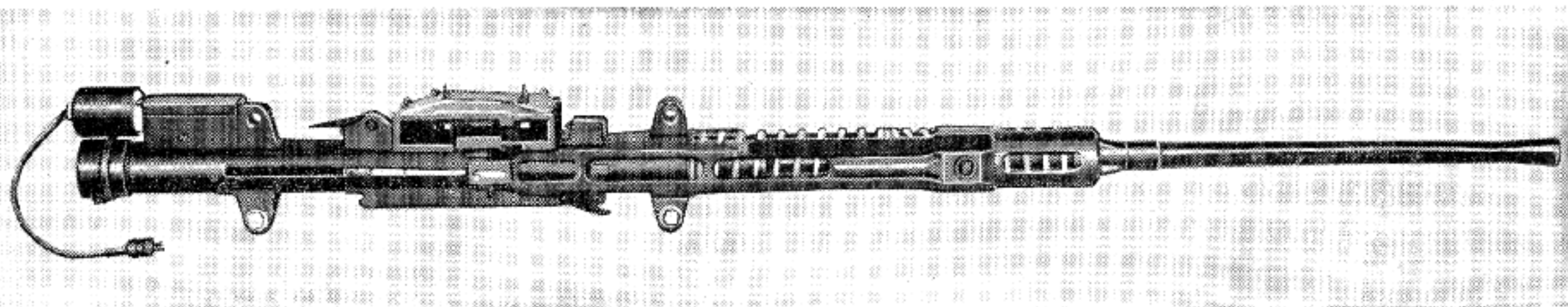

Oerlikon 20-mm Automatic Aircraft Cannon, Model 99 (Fixed). This Belt-Fed Weapon Was Manufactured in Japan and Used by Its Naval Air Force.

armament. As early as 16 July 1934, he visited Japan where he remained until 8 November of the same year. On this trip he spent his time in Tokyo negotiating with the Japanese War Department and private interests, principally in behalf of the French Société Aeronautique Lorraine relative to granting a license for Lorraine mosquito torpedo speedboats. At the same time he lost no opportunity to point out to the Japanese the devastating possibilities of the Oerlikon machine cannon in aircraft. He advised them of the experimental work and development being done at the Swiss plant.

In June 1935, Gazda returned to Tokyo. This time, after setting up headquarters in the Hotel Imperial, he proceeded to consult such notable industrialists as the Barons Okura, Watanabi (then director of the Okura interests), and Ishihara (head of the Mitsubishi Co.). Gazda's purpose was to advocate the Oerlikon 20-mm aircraft cannon mounted in the wings of fighter planes. While on this mission he had frequent occasion to be called into consultation by the Japanese War Department, and especially by the air corps.

The Japanese, open to such technical advice, placed their first order for 32 Oerlikon aircraft cannon on 17 September 1935, which upon arrival were immediately installed in the wings of 16 Mitsubishi Type 96 fighter planes. On 8 November of the same year, the Japanese Air Force ordered and acquired eight more such guns. A short while later a license agreement was signed, granting rights for Japanese manufacture of the 20-mm Oerlikon Aircraft Cannon Type FFF and construction plans were drawn for the Dai Nippon Heiki Munitions Works. Following the signing of this agreement, Gazda left on 6 June 1936 for Switzerland.

After a site at Tamioka was chosen for the

Japanese arsenal, machinery was installed by the Oerlikon firm that was capable of producing 200 aircraft cannon a month. Before starting on the new plant, two engineers were sent from Japan for a year's study of cannon manufacture and installation. One of them was Mr. Ishihara, the leading tool expert of Japan, who was formerly associated with the Mitsubishi tank factory at Tokyo. Upon their return, the Swiss technicians in charge of installing Oerlikon machinery at the Jap plant reported to their company that the two engineers brought with them better drawings of company machinery than those possessed by Oerlikon.

On 25 August 1937, the Japanese War Department, pleased with the performance of the aircraft gun and with the progress of their engineers in studying the techniques of the parent plant, sent Prince Chichibu, brother of the emperor, accompanied by Viscount Maeda and Major Yamaguchi, to discuss with certain prominent Oerlikon officials the granting of licenses to Japan for manufacturing the FFS type guns for anti-tank service. The weapons eventually produced in Japan ranged from aircraft to antitank cannon and were very popular with the Jap military leaders, being considered first-line automatic cannon by all branches of the service.

The German Army, Navy, and Air Force likewise adopted the gun and used it, in the early days of Hitler's power, when the nation began seriously to arm for the impending war. Since the Oerlikon arms plant was controlled by Germany and its head was an ex-army officer, there can be no doubt that the best interests of the Wehrmacht and Luftwaffe were considered. The navy was also served, as the Oerlikon was used on shipboard by the thousands.

At the beginning of World War II, the German Air Force had the gun mounted in almost

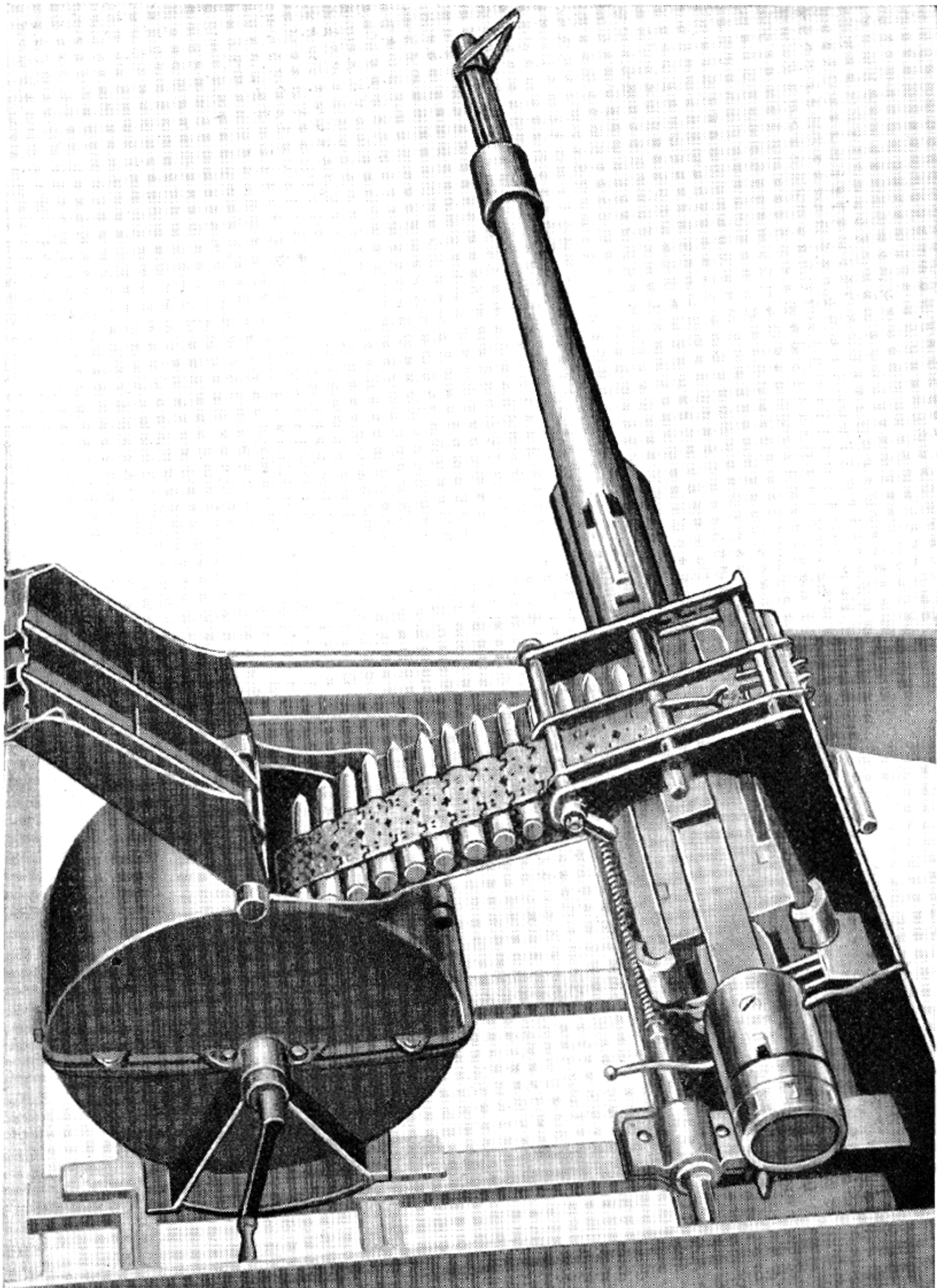

Oerlikon 20-mm Automatic Aircraft Cannon, Model S. Wing Installation with Belt Feed of 125 Rounds Adopted by the German Air Force.

every conceivable manner, flexible, wing, and engine installation. Up to and during the Battle of Britain, it was the main Nazi aircraft cannon. Its most objectionable feature, according to the Germans, was the 60-shot drum feed. To overcome this, a metallic link-belt feed system was successfully used by the Luftwaffe. With the inevitable improvement of aircraft cannon occasioned by the war, the Oerlikon aircraft cannon was replaced, but not before it had served Germany well. Great dividends were paid to those officials who had had the foresight to keep alive and improve the Becker gun of the closing days of World War I.

### Gazda Aircraft Cannon

After the fall of practically all of western Europe to the Germans and the United States had assumed the role of "arsenal of the democracies," Antoine Gazda made his appearance in this country and was promptly detained by the authorities for questioning. Gazda produced an already prepared paper entitled "Facts of How an Austrian Gave Great Britain and America the Most Powerful Weapon against Dive Bombers, the Oerlikon-Gazda Anti-Aircraft Cannon." This paper, now in the Army's possession, negligently failed to mention that the dive bomber was likewise armed with Oerlikon guns.

As further proof of his loyalty to the Allied cause, he carried plans for a revolutionary 23-mm automatic cannon that would "make all other aircraft cannon obsolete." In due time he presented literature with drawings showing the systems of other cannon in comparison with the Gazda four-stroke flywheel inertia-locked automatic cannon. The United States, being in a very precarious position, gave him an opportunity to present his gun and drawings. A booklet was delivered to the Navy Department which showed the flywheel Gazda gun (designated Model AS-43) in detail. Close study revealed nothing beyond the original Oerlikon that justified development, although a rate of fire of 1,140 rounds a minute using the same Oerlikon cartridge cases was claimed. A velocity of 3,100 feet per second was also declared possible without altering the powder charge.

Gazda has never been known to undervalue

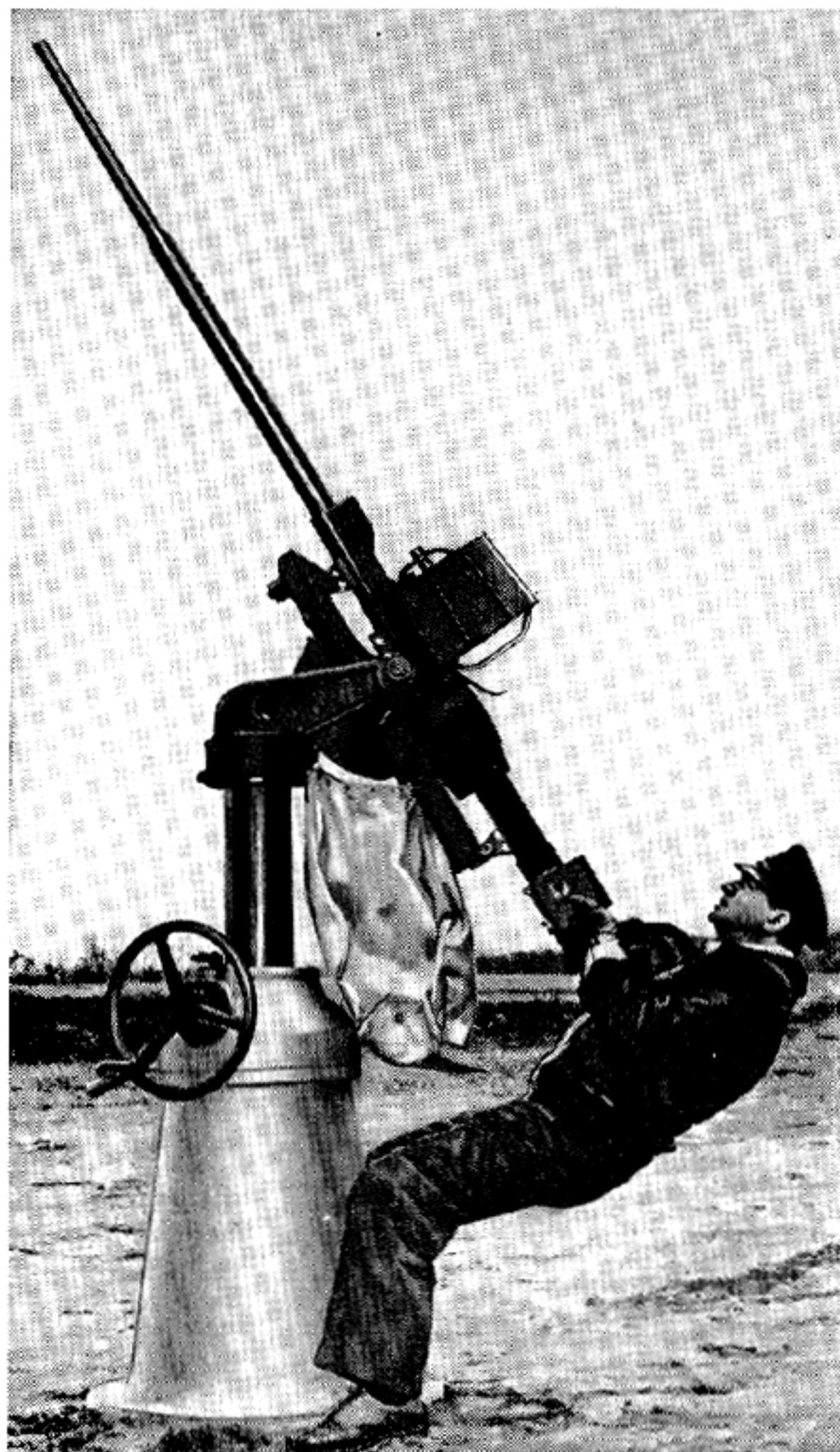

Antoine Gazda Firing the Gazda 20-mm Automatic Cannon.

the features of any gun he has had a hand in promoting, with respect to its individual feats as a combat weapon or its over-all responsibility for the successful conclusion of a global conflict.

It was stated in the descriptive booklet that the Gazda gun was entirely different from any other automatic cannon in that it employed "pre-percussion, whereby ignition takes place at a point where the forward moving breech, impelled by a simple recoil element, has almost reached its furthestmost position, but is still in full motion. . . . Much of the kinetic energy accumulated in the moving breech is absorbed by the rapidly increasing gas pressure, thereby losing about half of its recoil impulse, whilst the remaining energy

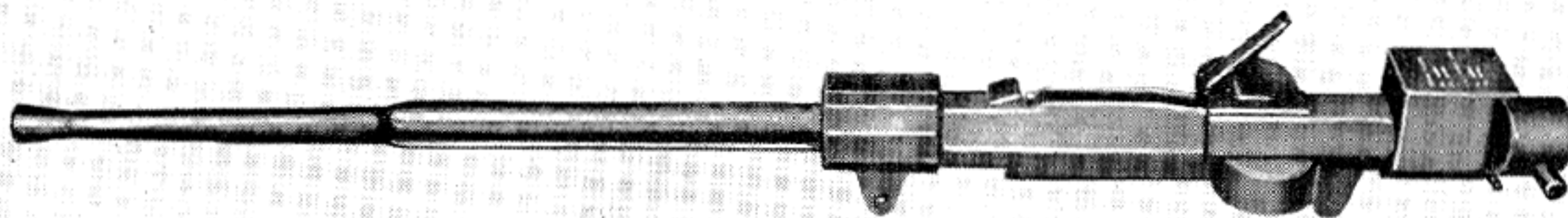

Gazda 23-mm Automatic Cannon.

drives the breech against the recoil element. This characteristic shows that the Gazda system locks the breech, and by means of pre-percussion reduces the ultimate recoil pressure to about half of the amount necessary without pre-percussion."

What Gazda overlooked in his claim for a new system was that every Becker and Oerlikon gun made since 1918 had used exactly the same principle. It was perhaps the most outstanding single feature of this type of gun. As evidence, a quotation is made from Reinhold Becker's patent application of 27 October 1914:

"The ignition is adapted to take place before the breech piece reaches its foremost position, that is to say, when it possesses its greatest kinetic energy, and before the cartridge inclosed in the cartridge chamber has attained its final position, the breech piece continues to move forward during the firing of the shot, by virtue of its kinetic energy and thus insures an absolutely gas-tight closure of the rear end of the barrel and reduces the recoil, which is then only sufficient to return the breech piece to its rear position."

After much correspondence the whole project was dropped as far as the United States Government was concerned, as there simply was not enough difference to warrant further investigation or expenditures at this particular time.

### Polsten Cannon

One of the most unusual developments or versions of the Oerlikon resulted from the German invasion of Poland. That country, in common with practically all others, had become interested in the weapon for ground use and had assigned its head engineers to redesign many parts for simplified manufacturing procedures. When this task was nearly completed, the German invasion began and the Polish engineers, carrying with

them their drawings of suggested improvements, escaped to England where the plans were shown to the chief superintendent of armament design. He was greatly impressed with the intended modification and this group, known as the Polish Design Section, was ordered to complete the details. When this was done, the finished plans were turned over to the British Sten Co. to make two pilot models with the understanding that, if the weapon passed the acceptance test, an order for 40,000 would be forthcoming.

One of the principal differences between the Polish-designed gun, known officially as the Polsten 20-mm Automatic Cannon Mark I, and the original Oerlikon was the built-up receiver of welded construction which had heretofore added greatly to the machining problem in mass production. The Polsten gun was also lighter in weight, but as the weapon was intended for shipboard and ground use, this did not seem of too much importance to the British. It could be fed both by clip or drum magazine, and could only be fired full automatic.

The following particulars compare the Oerlikon and the Polsten to show how much actual difference existed between the two guns:

	Oerlikon	Polsten
Weight of complete gun (pounds) . . . . .	152	121
Weight of barrel only (pounds) . . . . .	45	29½
Over-all length of gun . . . . .	7' ½"	7' 1¾"
Over-all length of barrel . . . . .	57"	57"
Inboard length of gun . . . . .	28"	32½"
Total number of parts . . . . .	195	108
Total number of machining operations . . . . .	1000-1200	550-600

Tests conducted at the armament design section at Cheshunt and the experimental establishment at Pendine showed that an average of 9,000 rounds could be expected on all components of the Polsten except for the mainspring and buffer assembly, which was given a life expectancy of 6,000 rounds. This was considered quite satisfactory. The same report, however, showed that a great deal of trouble was had with the 30-shot spring-loaded clip-type magazine. As this was considered an accessory to the gun, rather than an integral part, the malfunction was taken up with its producers.

The Pendine experimental establishment also went farther and proved that the accurate barrel life of this modified version of the Oerlikon was 1,200 rounds when fired as fast as the magazines could be changed, and 3,000 when 5-minute pauses were permitted after 600 rounds of continuous fire.

The Polsten 30-shot magazine is of the box type, rectangular in form and tapering at the bottom to neck with the conventional feed mouth. When filled, it presents two double columns,

each being operated by a separate platform and spring. The pressure on the platform is produced by two separate multileaf springs, which automatically place the correct pressure on the cartridge resting in the feed mouth, making any additional outside tension unnecessary. An L-shaped lever is issued with each magazine to assist filling. When not in use, it fits into slides at the rear. A web-strap carrying handle is fitted to the front.

When this magazine is used, each platform is pressed down almost to its limit of travel, fully compressing the leaf springs. When placed into position on the gun, the cartridges in the right-hand column will first feed out rounds 30 to 15, while rounds 1 to 13 are being forced into the recess of the partition. As the right-hand platform moves down and finally reaches the end of its travel, a cam on the inner side pushes number 13 out of the recess and thus permits the left-hand platform to feed its column rounds 14 to 1, with number 14 being held against number 13 by the passage of the cartridges from the opposite column.

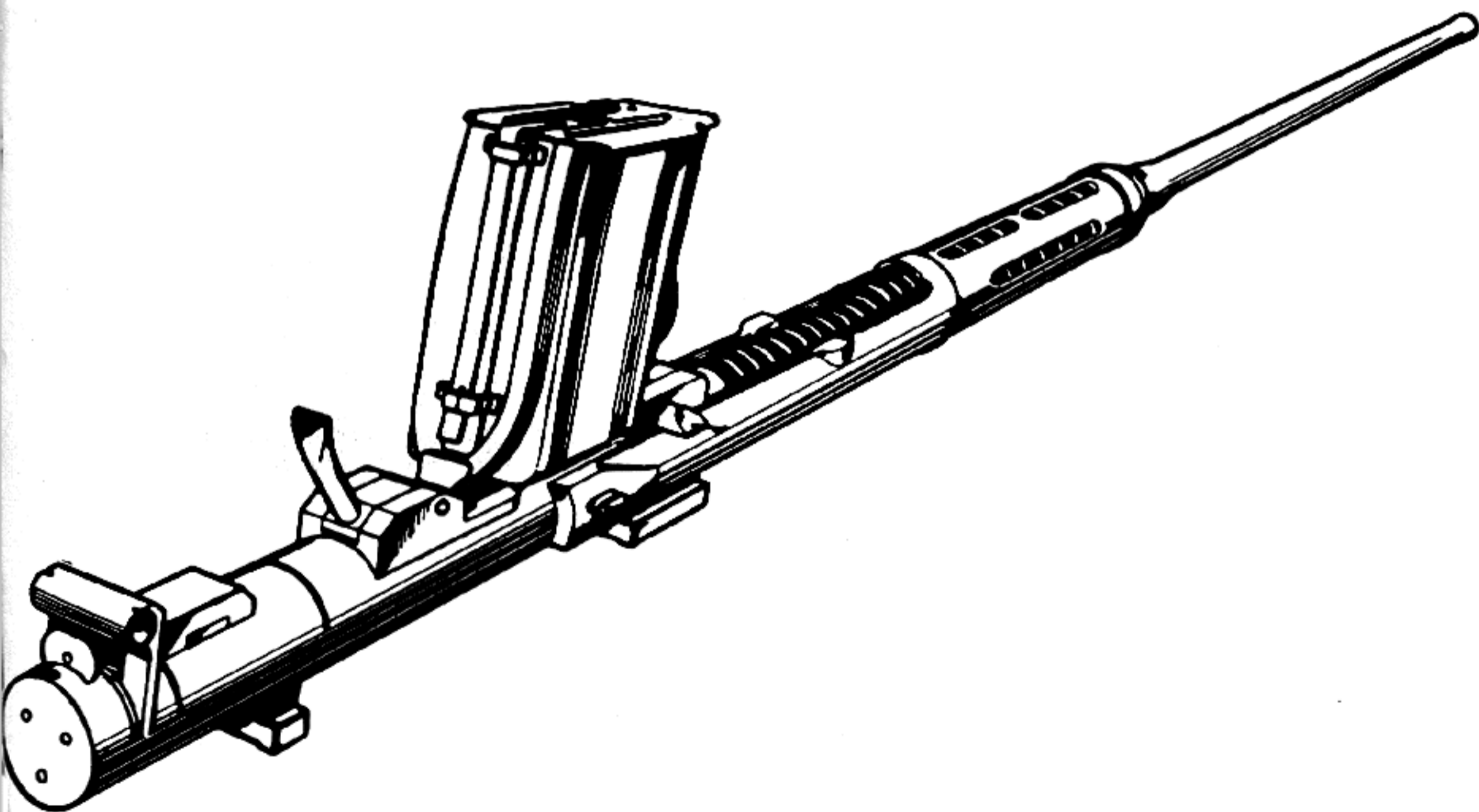

Polsten 20-mm Automatic Cannon Mk I. Drawing Shows 30-Round Magazine.

## Cycle of Operation

To fire the Becker, Semag, Oerlikon, Gazda, Japanese Model 99, Polsten, or whatever else the action may be known by, the gunner pulls the charging handle to the rear until the sear engages its recess in the bolt, and then places the loaded feed into position on top of the receiver. After turning the safety catch forward to the *Fire* position, the trigger is pressed back.

The breechblock is then released from the sear and travels forward under the influence of the barrel spring. The horns on the breechblock head come into contact with the base of the first round in the magazine, forcing it forward and downward towards the chamber.

The mouth of the chamber is shaped to guide in the nose of the round. The projectile is thus aligned with the axis of the bore, and the base of the cartridge slides down the face of the breechblock head until the rim of the cartridge rests in the extractor lip.

Forward movement continues until the round is about a half inch from the fully home position. Then the rear toe of the hammer comes into contact with the rear face of the hammer cam. The hammer is rotated on its axis pin thus forcing the firing pin forward and firing the primer. No locking of the breech takes place.

On firing, the forward movement of the breechblock is arrested by the building up of the chamber pressure, which forces the empty cartridge case against the face of the breechblock head and carries the block to the rear, compressing the barrel springs.

At the commencement of the rearward movement, the front toe of the hammer rides against the front face of the hammer cam, thereby rotating the hammer rearwards and withdrawing the firing pin.

The empty cartridge case is supported by the lip on the breechblock head until the top edge

of the base of the case comes into contact with the projection underneath the magazine catch which forces the case downwards through the ejection opening in the underside of the body.

The breechblock continues rearward movement until the buffer at its rear comes into contact with the body plug. Any surplus energy possessed by the recoiling parts is now absorbed by the buffer springs housed in the breechblock.

The barrel springs then reassert themselves and drive the breechblock forward again as the cycle is repeated.

## Conclusion

The Oerlikon system, as it is commonly designated, represents the fullest known exploitation of a sound operating principle for automatic cannon. Utilization of the terrific speed forward of the bolt as a substitute for a securely locked breech not only allowed the construction of a lightweight cannon but also dampened out to a considerable degree the abnormally large recoil forces that were an important consideration in mounting automatic cannon in aircraft.

While this system met these requirements, it still left many things to be desired. One feature, in particular, limited its use as an aviation weapon. In order to compensate for firing the cartridge at variable distances in the chamber, it was necessary that the ammunition be heavily lubricated with oil to insulate the case from the chamber walls. This permitted the empty case to slip to the rear by blow-back forces to exert necessary operating energy on the bolt face. This feature, which was so bad that it practically canceled out all the good ones in the gun, as far as aircraft use was concerned, was a byproduct of the Oerlikon type of action. It could only be eliminated by use of a positively locked breech, which, in turn, would produce greater recoil forces with their attendant difficulties.



## SZAKATS 20-MM AIRCRAFT CANNON

When the Inter-Allied Control Commission inspected German armament plants shortly after the armistice, it found an aerial cannon being developed for intended use against the Allies. It was the Szakats 20-mm belt-fed, air-cooled automatic cannon, having a rate of fire of 450 shots a minute. It was designed primarily for aircraft use although two experimental models did have a provision for water cooling. This weapon was the invention of a Polish arms designer named Gabriel Szakats, then serving as an ordnance engineer at the Fahrzeug Fabrik of Frankfurt, Germany.

The first successful model was produced by this company late in 1918, but, although manufactured under high priority, none were completed in time to get into combat. In all, four distinct types (SZA-1, SZA-2, SZB, and SZC) were made in the early development of this gun. The SZA-1 and SZA-2 could both be water cooled, if desired, the only difference in their construction being in the housing for the unusually large barrel return spring. The SZB was made much lighter than the original guns and was air cooled only. It had radial fins on the barrel and an air brake for checking recoil, made in the form of a "dash pot," to dampen out the sudden shock. In this design a device was incor-

porated for rotating the feed, thus facilitating the loading of the first cartridge. No provision was made for single rounds to be fired, the selector switch being on either *Safe* or *Full automatic*. The SZC represents the final improved model and its modified components were finished in bronze to eliminate undue friction.

Each Szakats cannon was based on the operating principle of blow back and employed a push-out-type metallic link belt. The most novel construction feature was the revolving feed that, actuated by a lug on the bottom of the bolt during recoil, rotated a cartridge into position for chambering. By utilizing the powerful recoil stroke to index the round, the weapon had enormous belt pull.

The buffing system was also extraordinary. A heavy spring arrangement bore the brunt of the shock but, if it could not absorb it completely, the back of the bolt then made contact with a piston. The resulting sudden air compression gave the recoiling parts their final check. This system of buffing, known as "dash pot," has been used extensively since Szakats first introduced it in his cannon.

The spring-loaded firing pin release was so timed that it was tripped a few thousandths of an inch before the cartridge was all the way home

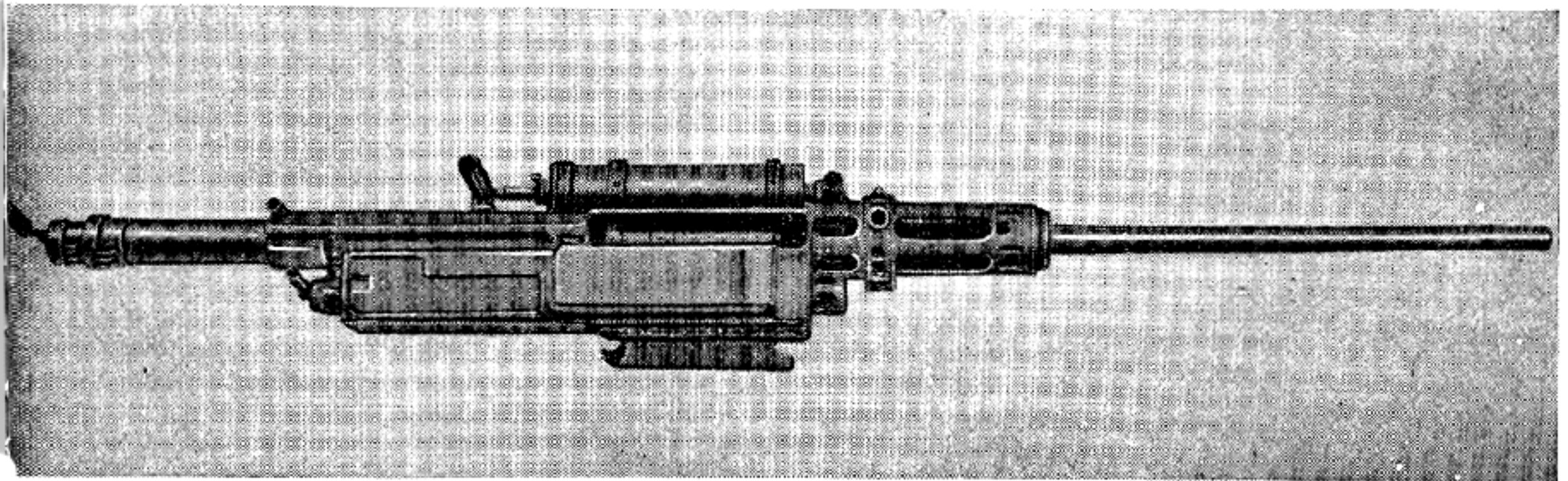

Szakats 20-mm Automatic Aircraft Cannon, Model SZB.

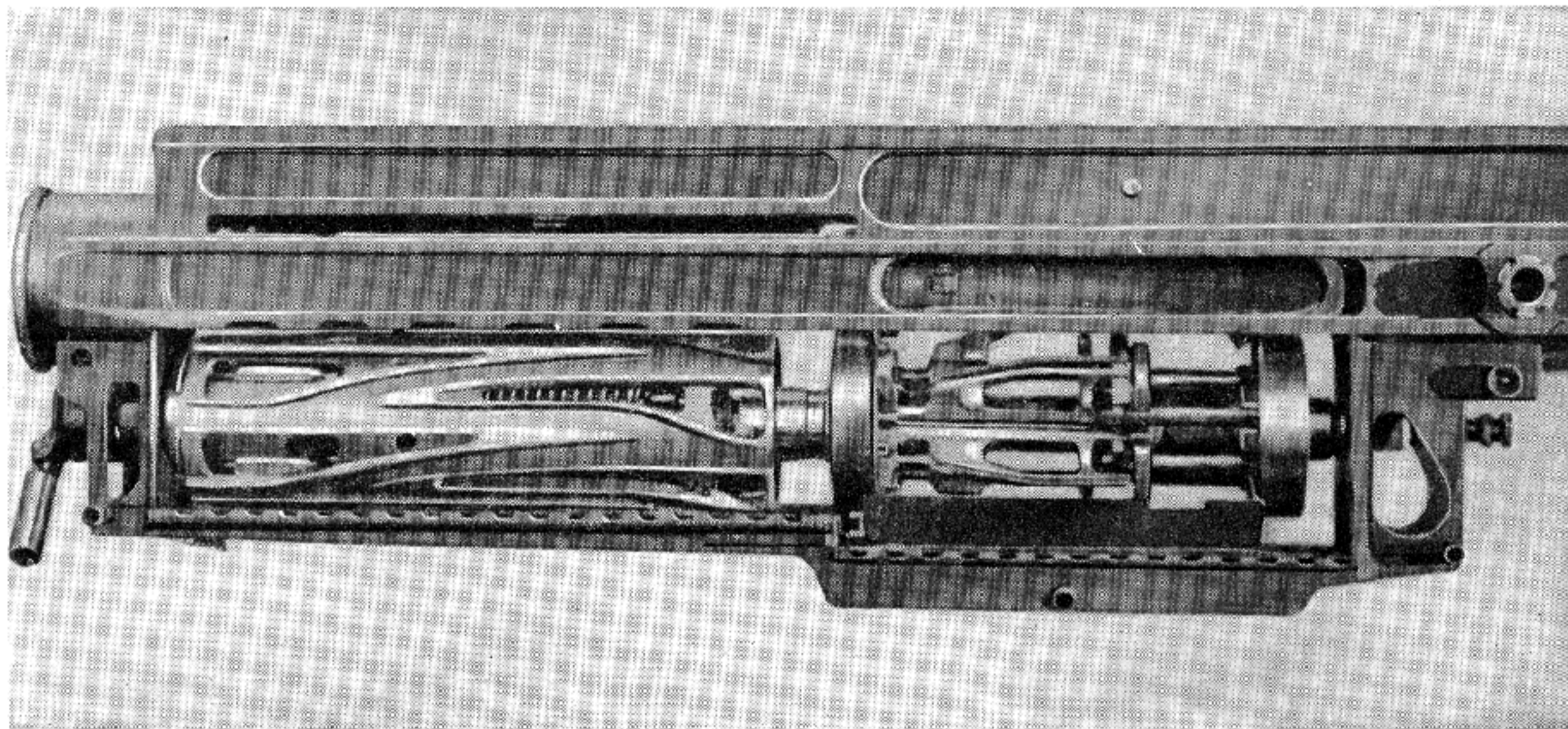

The Feed Mechanism of the Szakats Automatic Aircraft Cannon.

in the chamber. This allowed the forward thrust of the bolt to back up the cartridge when the explosion took place. As the weapon was not locked at the instant of firing, it was necessary to grease the cartridges used with the cannon. The inertia of fast traveling bolt and spring pressure served as the only lock. The action was straight blow back, no provision being made for retarding the movement.

The weapon could be mounted either flexibly or fixed in aircraft. When installed in the wings, it was possible to synchronize its front-seared action to fire through the propeller arc. When so installed, an ammunition box holding 100 cartridges was seated near it.

To fire the Szakats, the linked cartridges must first be brought out of the container and the first round placed in the fluted portion of the revolving feeder. This part of the feed must be disconnected from the rear portion by means of a throw-out device. The flutes can then be rotated by hand until charging of the gun indexes it into place.

The fore and aft members of the feed are again connected and the gun is ready to be manually cocked. This is done as the operating parts are pulled as far as possible to the rear and then released to go into battery. The positioned round is now chambered and the firing pin cocked. By turning the left-hand grip, the trigger bar with

its ball-shaped end is pulled rearward, camming the sear out of engagement with the projection on the rear of the firing pin. The latter flies forward, firing the gun.

The projectile clears the bore before the case is withdrawn and the chamber pressure is reduced far enough to prevent rupture from the initial shock of explosion. Having been lubricated, the empty case slips back with the recoiling bolt, being held in position by the extractor claw until it strikes the ejector, located  $8\frac{1}{2}$  inches to the rear of the chamber. At this point the ejector pivots the case around the extractor and knocks it to the left through the opening in the receiver.

The stud on the bottom of the bolt that actuates the feed rides in comparatively free movement, for the first 5 inches of recoil, but now the angle is accelerated. The flutes on the feed wheel are rotated rapidly one space, rolling a cartridge up through the floor of the feedway. The round is then held in place by its link and the nose of the projectile. This is slightly behind a guide ramp that leads it into the chamber. The bolt, in finishing its recoil stroke, compresses the buffer spring. It also starts a sudden compression of the dash pot and then begins counterrecoil. The rib on the bottom of the bolt contacts the base of the indexed cartridge, shoving it out of its link and starts to chamber it. At a distance

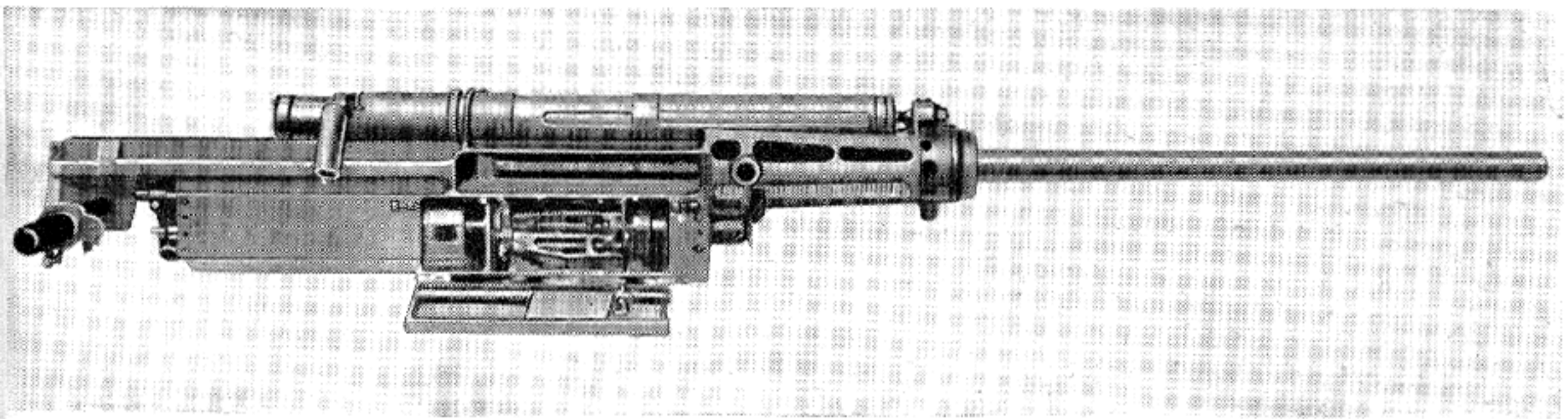

Szakats 20-mm Automatic Aircraft Cannon, Model SZC.

$\frac{3}{4}$ -inch from complete battery, the sear engages the lug on the firing pin, holding it there by commencing to compress its spring.

If the trigger is still held back, the sear device will rock out of engagement at a few thousandths of an inch before full counterrecoil is completed, allowing the firing pin to explode the powder charge. Thus the peak pressure in the bore coincides with the full force of the forward traveling bolt. This not only insures a better support be-

hind the fired cartridge, but also prevents collision of parts on counterrecoil from the fast-shuttling mechanism.

As the Szakats did not get much beyond prototype stage and the Allied Commission prevented future development, the only trace left of its existence lies in its many good features that have since been copied. The Soviets, for instance, have used a similar feed system in practically all of their aircraft cannon.

## BALDWIN AIRCRAFT CANNON (37-MM)

During World War I, an American engineer, A. S. Baldwin, was authorized by our Government to work on the Puteaux aircraft cannon sent to this country from France for the purpose of adapting them for use on American planes. From the wealth of experience gained during the early days of development and the wide reputation he enjoyed as a thorough ordnance man, he was the natural choice of the Army to design an aircraft cannon for use on a flexible mount or a motor cannon to be fired through the propeller hub.

Baldwin interested the Poole Engineering and Machine Co., Baltimore, Md., in contracting with the Government for producing a gun for test and with the assistance of one of Poole's en-

gineers, a Mr. Metz, he started work on the first automatic aircraft cannon sponsored by the Ordnance Department. The influence of the Puteaux was most certainly evident, as the Baldwin aircraft cannon was but a refined version of the French gun, which in turn closely followed the Vickers. The speed in which it made its initial appearance is proof enough of its having been copied from some already existing mechanism.

On 4 September 1919, at McCook Field, Dayton, Ohio, the first trial was held. The gun was mounted on a plane and ground fired not only to test the action but to observe at the same time the effect of recoil forces on the structure of the ship. After a sufficient number of single shots, the plane was taken up. The report stated th-

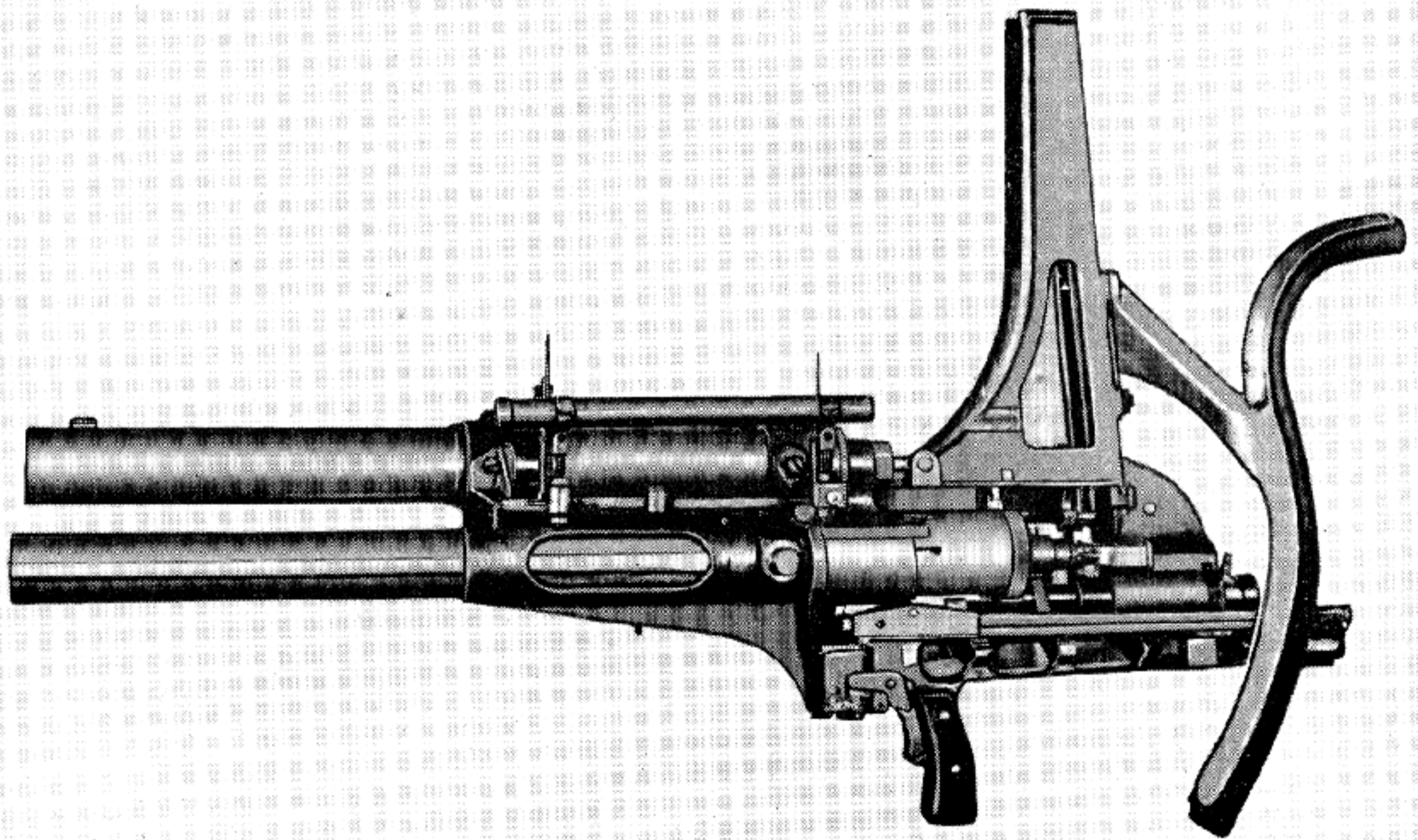

Baldwin 37-mm Automatic Aircraft Cannon.

shots fired one at a time were negligible in their effect on flight, but that automatic firing did increase the difficulty of piloting the plane. Still it was not hazardous in any sense of the word.

The weapon's performance was far from satisfactory, only one burst of eight rounds being accomplished. Failure to feed was the most prevalent malfunction.

The Ordnance Board recommended that the cannon and mount be given a more exhaustive test on the ground as soon as conditions would permit and that it be further tested in the air. It was concluded from the trial that the plane was strong enough to withstand the force of recoil of the cannon. However, considerable firing on this mount was urged to make certain that continued use would not disturb the latter and cause the gun to jam.

Testing took place periodically with little or no improvement shown. The feed continued to provide a major portion of the malfunctions. Baldwin requested the Ordnance Department that he be allowed to prepare an altogether new design, but it was denied on the grounds that he should first make the gun at hand work satisfactorily.

Army Ordnance became so impatient with the lack of results that it engaged John M. Browning and Fred Moore, of Colt's Patent Fire Arms Co., Hartford, to inspect visually the mechanism, hoping that these two outstanding ordnance men could suggest something that would better its performance or increase its efficiency. If need be, they were to send the weapon to Colt's for further development. On 29 November 1920, Browning and Moore visited the Aircraft Armament Division in Washington, D.C., to view the gun.

After peering into the mechanism intently for minutes and looking through the bore, Browning made a statement that more aptly described the Baldwin cannon than anything else could possibly do. Looking very perplexed, he asked Maj. Julian Hatcher, who was also present, "Where do they put the bait?" When asked what he meant, he replied, "This thing surely is some kind of a rat trap, as it can't possibly be an automatic gun."

Needless to say, such an expression from Amer-

ica's greatest master of ordnance did not enhance the standing of the Baldwin cannon. Time has proved the correctness of his evaluation, as attempts to convert it to a reliable mechanism met with one failure after another.

The Navy also fired the weapon at its proving grounds, with the usual negative results. On 22 November 1921, the Army Ordnance Department officially discontinued all developmental and experimental work on the Baldwin aircraft cannon, and nothing was ever done to revive the project.

The Baldwin's chief claim to fame is that it interested John M. Browning in developing a 37-mm aircraft cannon for the Government and showed the Air Force the definite need for a reliable cannon having a bore of this diameter.

The cannon weighed 140 pounds with the magazine empty and employed the system known as long recoil. It fired the 1-pound projectile at the rate of 120 shots a minute with a velocity of 1,350 feet per second.

The recoil cylinder, like that of the Puteaux, is located on top of the barrel. A short charging handle at the end of the receiver is attached directly to the rotating bolt that locks with the turning of the interrupted threads when the operating parts are in battery. The trigger arrangement is housed by a pistol-grip affair located beneath and slightly to the right of the bottom of the receiver.

The barrel has four longitudinal ribs cut on it. Two of them engage slideways in the receiver and act as a track to guide the barrel during the long stroke back and forth. The feed system, the poorest design to be found on any automatic weapon, is simply a piece of heavy metal crimped in such a manner as to present a T slot to hold the rims of eight cartridges as they drop into position for chambering by the bolt.

To aim the piece, the gunner rests his shoulder against a curved shoulder piece. This is well offset in order to miss the charging handle that returns with the bolt. For air firing, a heavy canvas bag is fastened beneath the receiver to catch the empty cartridge cases.

To fire the Baldwin automatic aircraft cannon, the gunner grasps the charging handle and pulls it all the way to the rear. Release of the handle

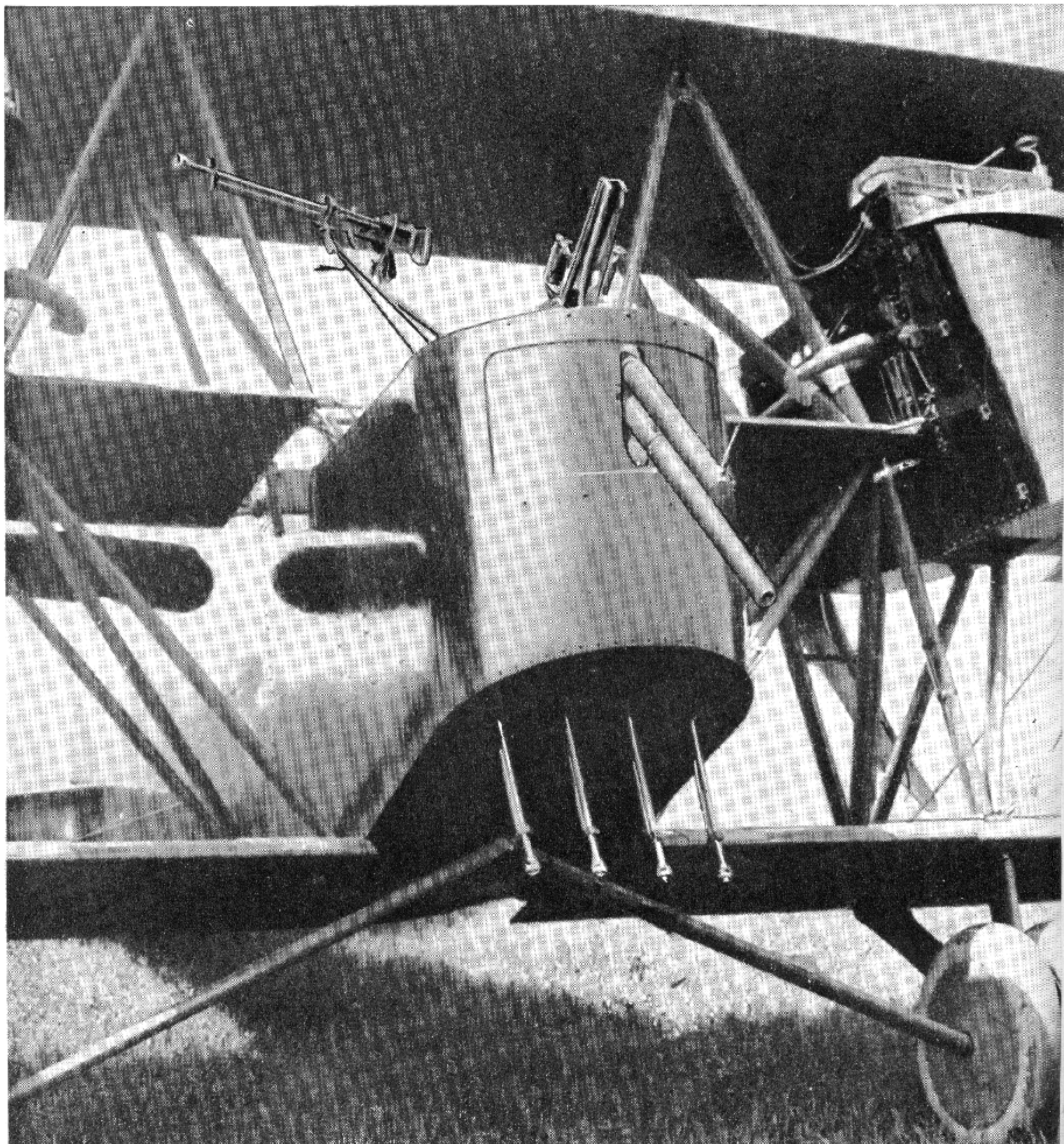

Baldwin 37-mm Automatic Aircraft Cannon Mounted for Test in a Martin Airplane.

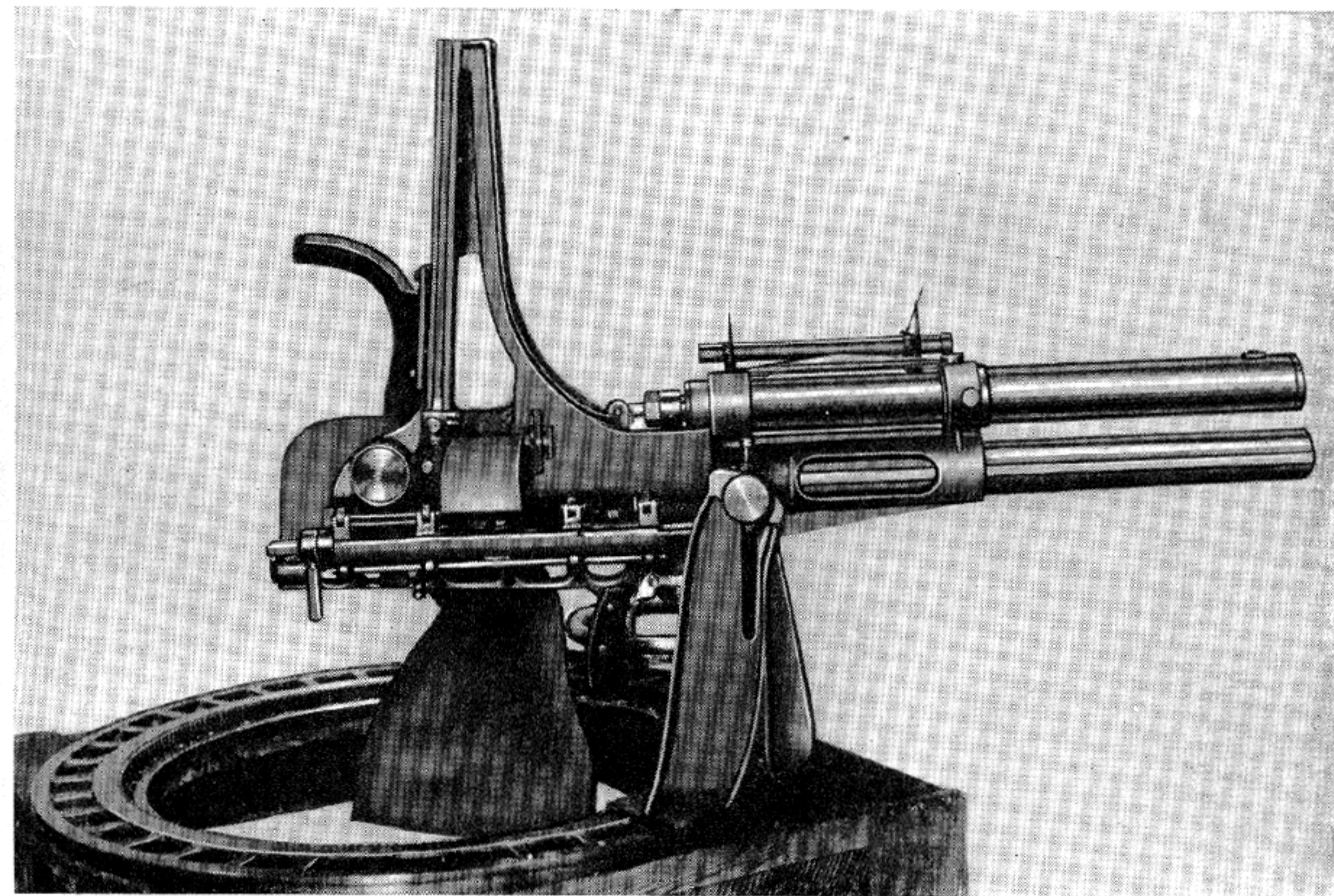

Baldwin 37-mm Automatic Aircraft Cannon. Picture Shows the Method of Mounting in Aircraft.

allows the mechanism to fly forward, chamber a round, cock, and lock the piece. By pulling back on the trigger in the pistol-grip handle, the spring-loaded firing pin is disengaged from its sear, and it flies forward and detonates the primer.

The barrel and bolt start to recoil locked together until a distance greater than the over-all length of the loaded cartridge is reached. At this time the lugs on the bolt are rotated and it unlocks. The barrel returns to battery by means of a recuperator spring. The bolt is held to the rear and the extractor grasps the rim of the cartridge as the barrel goes forward, pulling the chamber away from the empty case.

The final movement of the barrel trips the bolt, which then starts home. When the bolt face is directly underneath the hopper-type feeder, the loaded round is picked up and chambering is begun, while the empty case is dropped through the opening in the bottom of the receiver. As the bolt reaches battery, its momentum and the en-

ergy of the driving spring cause it to rotate and lock the interrupted threads on the bolt body to the breech of the barrel. Final movement in this direction, if the trigger is still pulled to the rear, trips the sear and automatic fire continues.

This gun showed practically no originality and the design was cumbersome to an unbelievable degree. Mr. Browning's appraisal was not too severe for the time and expense devoted to it. With Baldwin's background and unquestionable engineering ability plus the valuable Government backing, he should have produced a better weapon.

On 1 March 1921, Baldwin severed his connection with the Poole engineering firm, but although he persistently tried to interest the Government from time to time, there was never a successful enough demonstration to warrant an adoption.

In the fall of 1922, he approached the Army Ordnance Procurement Board with drawings for an automatic cannon to operate by compressed

air. After careful investigation, the following decision was made on 26 October 1922, by the Chief of Ordnance:

"This office does not look with favor upon the utilization of compressed air for the operation of automatic cannon. Compressed air apparatus was installed on two experimental antiaircraft guns which are now at the Proving Ground. The results thus far obtained are unsatisfactory and further use of pneumatic operation of breech mechanisms on antiaircraft guns is being abandoned at this time. It is not believed that pneumatically operated cannon would be practicable for aerial use.

"Of course this office does not desire to discourage investigation of projects and constructions not specifically called for in orders issued from this office. It is believed that design forces at the Arsenals cannot be properly developed unless they feel the responsibility of developing design studies which are not specifically called for. It is believed, however, that in the present stage of development of the automatic cannon that it would be preferable to confine the energies available in the Department to the projects under consideration unless outside studies can be carried on without interference with progress along lines already laid out."



## BROWNING AIRCRAFT CANNON

Not satisfied with the results of tests on the Poole Engineering Co.'s Baldwin cannon, the Chief of Ordnance, United States Army, with the consent of Mr. Baldwin and the Colt's Patent Fire Arms Co., consulted John M. Browning. This recognized genius of automatic weapons, who had been connected with Colt's for years, was asked to check visually the Baldwin gun and make any suggestions that might increase the reliability of the weapon's action.

On 29 November 1920, accompanied by Fred Moore, production manager of the Colt Co., Browning came to the office of the Chief of Aircraft Armament Design in Washington, D. C., to observe the manual cycling of the Baldwin. After a close inspection, at which time Browning is

credited with a remark that showed clearly his dubious opinion of the intricate mechanism, the weapon was shipped, at Moore's suggestion, to the Colt Co. for further study.

A short while later, S. M. Stone, president of Colt's, reported that both Browning and Moore concurred in the belief that the only way to improve the mechanism under study was complete redesign. If the Army was interested, the Colt Co. would undertake the development, any fee specified by the Government being acceptable to both Colt and Browning.

This generous offer was quite in keeping with the inventor's long association with weapon development for his Government. With this simple understanding concerning remuneration for the

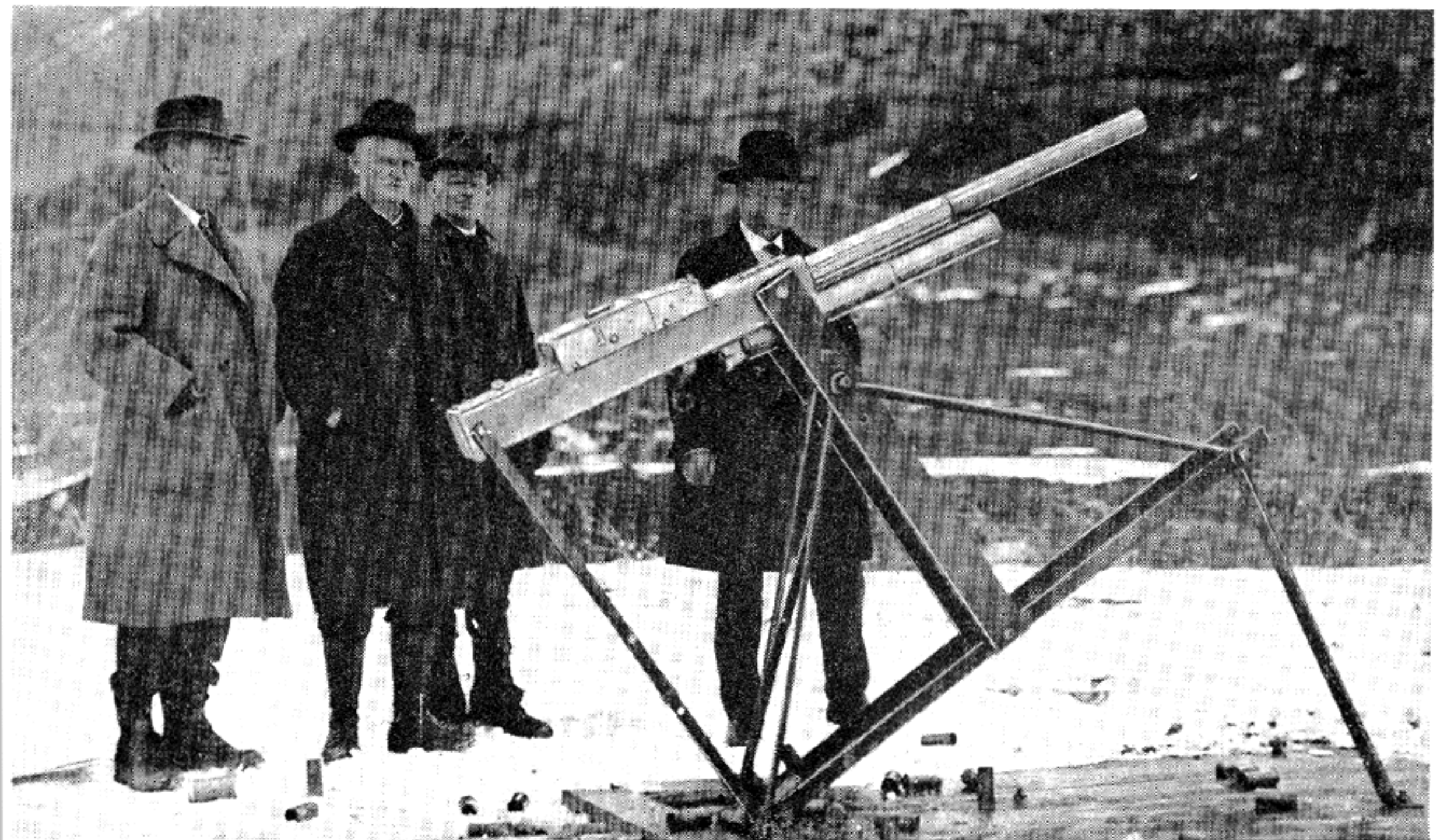

The First Model of the Browning 37-mm Automatic Aircraft Cannon Being Tested in the Foothills Above Ogden, Utah. Left to Right: Matt S. Browning, John M. Browning (the Inventor), John Browning (Son of the Inventor) and Ed Browning.

inventor, the Colt Co. asked the Army to write specifications on the exact needs of the Air Force.

At his experimental shop in Ogden, Browning made a prototype, that on its first attempt automatically fired projectiles weighing more than a pound at a rate of 150 rounds a minute. As this working model had a velocity of only 1,400 feet per second, he felt that the weapon needed further testing and modification at the Colt plant. In short order two more models were produced, each firing a heavier projectile with considerably more velocity. At a time when success seemed a certainty and after several demonstrations of the reliability of his cannon during the mid-twenties, interest in all military weapons in the United States became apathetic. Development work entered a period of great lethargy. Not only was money lacking to carry on the work, but the public became actually hostile towards all who were connected with such a project, referring to them as "Merchants of Death."

Even the Colt Co., one of the most outstanding automatic weapons factories in the world, turned its efforts to manufacturing electrical appliances, dishwashing machines and a variety of plastic devices in order to remain solvent. Mechanical drawings and the three successful working models of John M. Browning's 37-mm automatic cannon were filed away against the day when perhaps there might be a need.

It was England that first became interested in the further development of this gun. As early as 1929 the Armstrong-Whitworth Co. obtained from Colt's Patent Fire Arms Co. the rights to produce the 37-mm Browning mechanism. A 20-mm cannon, to be built along the same lines, was also included in the deal. However, just at the time when production on these two models had gotten well under way, the Armstrong-Whitworth Co. was taken over by the Vickers Arms Co., Ltd. The Browning end of the work was moved to the Vickers Erith plant, where a few of both the 20- and the 37-mm were produced commercially.

Practically all of the guns made at this time were sold to Spain, as Great Britain, somewhat like the United States, was also undergoing a strong reaction against any kind of weapon development. Without government support, the Vickers plant soon had to stop production after

its limited sale to Spain. The Spanish promptly called the weapons the Colt 20- and 37-mm automatic guns, a designation that has been very confusing to those interested in following European development of the Browning gun.

In 1935 the United States again became interested in an automatic gun of large caliber for aircraft. By this time the finished Browning cannon was practically at the Government's disposal, for the weapon had been tested and improved to a point of absolute reliability. The first Army Air Force venture was officially known as the M4.

This 37-mm gun weighed 313 pounds without feeder and 406 pounds with 15-shot loaded magazine attached. A 65-inch barrel weighed 55 pounds and the muzzle velocity was 2,000 feet a second. The action was known as the long-recoil type, utilizing spring-actuated ramming to load each round. The cyclic rate was given as 135 shots a minute. The feed was the endless-chain open-loop type, the cartridges being forced downward from the open links onto the feedway.

While its performance was reliable, it was far too cumbersome in design and the velocity entirely too low. Continued work on refining the action and making a better profile took place from time to time until American entry into World War II required the standardization of what is now known as the M9.

The full-automatic, high-velocity 37-mm automatic cannon M9 operates on what is known as the long recoil principle, and is designed primarily for aircraft use. It is mounted to fire either through the propeller hub, or outside the plane of the propeller arc, as the gun cannot be successfully synchronized. Triggering is accomplished by remote control by means of an electric solenoid.

The feed can be adapted to either left or right hand but it necessitates the changing of the box. When this is done, however, the parts inside can be made to operate the mechanism in either direction. The cartridges are fed into the side of the box and the empty links are ejected through a slot on the opposite side. The empty cartridge case is ejected through a longitudinal opening between the bottom of the receiver and the side plates.

The mechanism depends upon the unusually long recoil movement (greater than the over-all

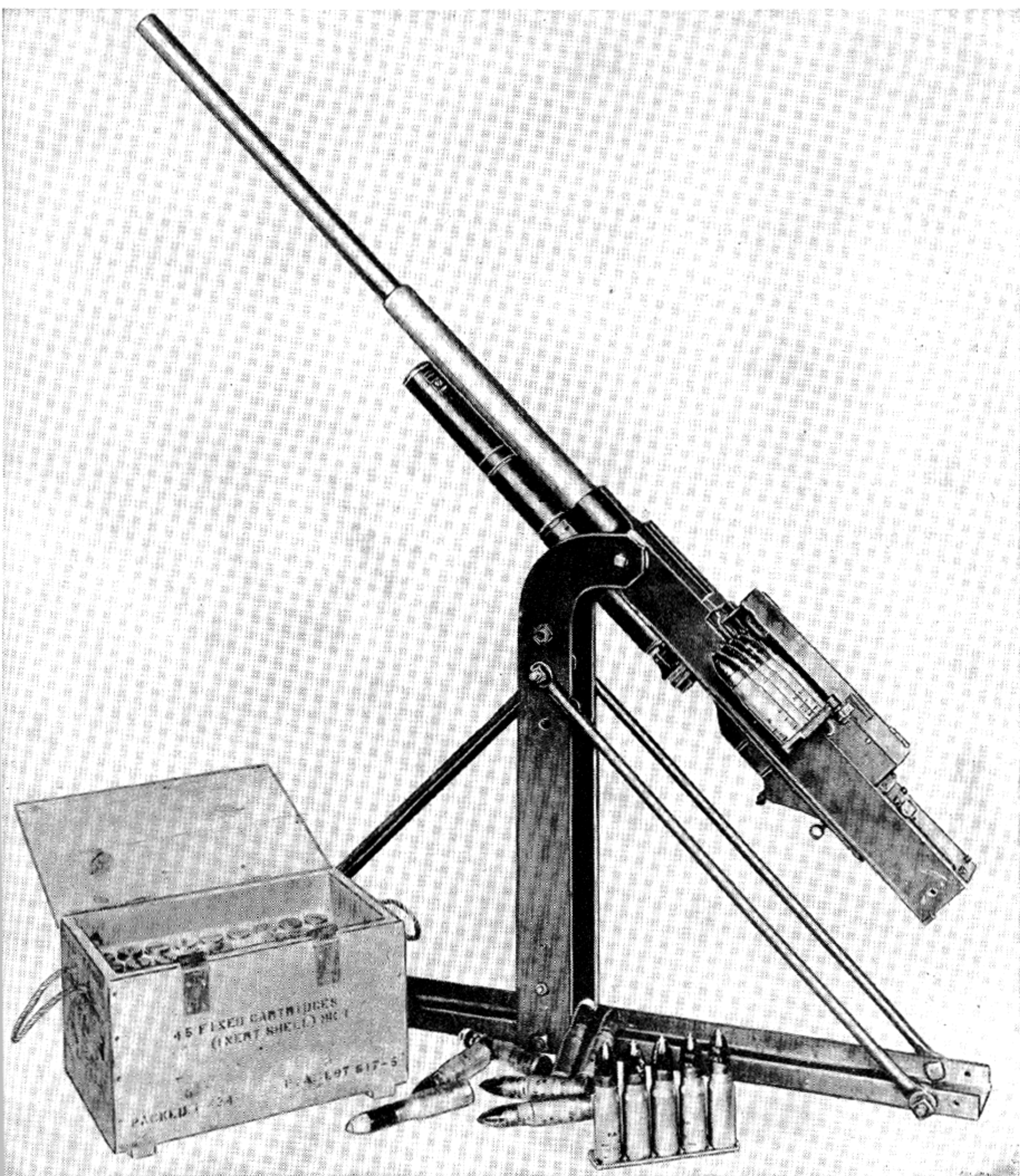

Early Model Browning 37-mm Automatic Aircraft Cannon.

length of the loaded round) for its operational power. Both recoil and counterrecoil forces are controlled by means of a hydro-spring buffing mechanism.

The weapon, although admittedly heavy (405 pounds), has unusually clean lines, the weight being necessary to handle the high-velocity (3,050 feet per second) round of ammunition. The breech lock is of the vertical sliding-wedge type and represents the simplest form yet conceived for an automatic weapon to insure not only position locking but control of the vital measurement of head space. A manual air charger made it possible to load the initial round easily for firing either by hand or by remote control if the gun is mounted in such a manner as not to be easily accessible to the gunner. The cartridges are linked between the shoulders of the rounds halfway up the projectile, which is very unusual in itself. The links, however, are lifted by a stripper leaving the cartridge free to be positioned.

To operate the Browning 37-mm weapon when engine-mounted for firing through the propeller hub of a plane, the pilot first pushes in on the charger button. This actuates the loader for jacking the mechanism to the rear. A round is stripped from the belt and is chambered as the mechanism goes forward. The gun is now cocked, loaded and locked, ready to fire.

By closing the circuit on the firing switch, the trigger is pulled through the use of an electric solenoid. When the cartridge is fired and the projectile is driven down the bore, an equal force is applied in the opposite direction against the face of the breechblock. Thus the barrel, barrel extension, breechblock, and lock frame, all securely locked together, go rearward during 10 $\frac{3}{4}$

inches of recoil, at which point the operating lever guide pin, following its front cams, causes the pin to rotate and bring the breechblock downward.

This movement also throws the lower end of the cocking lever forward. The hammer spring is compressed thereby and the latching hook forced back on its sear to cock the hammer. The rearward movement is controlled by what is called the recuperator, a cylinder with a spring-loaded piston and oil being used to accomplish this end. The fluid behind the piston is forced through slots to the front side as the piston goes rearward. The orifice diminishes in area as it approaches the end of its stroke, thus giving a positive buffing action.

The lock-frame assembly is not affected by the retarding action of the recuperator since it is unlocked from the barrel extension by the dropping of the breechblock. Consequently, when the barrel and its extension are near the end of their rearward travel, the lock frame separates from these parts and continues to recoil, speeded up by the accelerator. This part is actuated by a cam mounted on the rear of the side plate. The accelerator rides upwards on an inclined surface of a cam while its lower part pushes backwards against a lug on the lock frame body. This suddenly applied mechanical advantage gives recoil of the frame added impetus.

The rear of the lock frame then strikes the buffer plunger, compressing the ring spring and forcing the two friction pieces upward and outward against the inside of the back-plate housing. Then the remaining force of recoil is transmitted to the back-plate assembly. The frame rebounds from the buffer plunger because of the

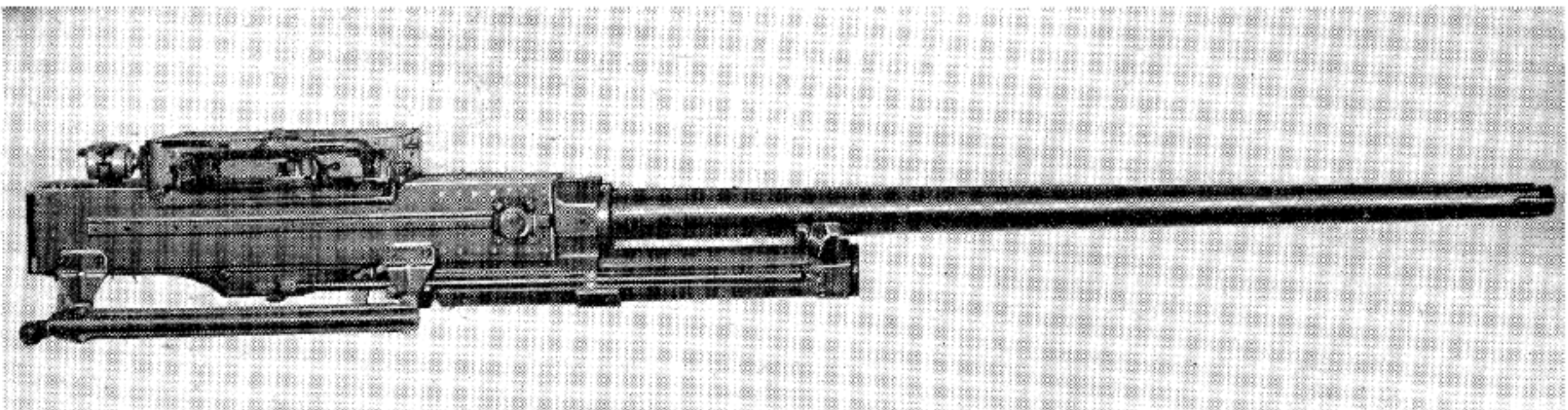

Browning 37-mm Automatic Aircraft Cannon, M4.

action of the ring springs. After traveling in counterrecoil a short distance, a carrier dog engages its notch in the frame holding the piece stationary while the barrel and its extension continue on in counterrecoil movement.

Initial extraction of the empty cartridge case occurs at the instant the lock frame separates from the barrel extension. Engagement of the rim of the case by the extractor claw fully loosens the round at this time. When the frame is held to the rear and the barrel and its chamber goes forward on counterrecoil, the empty case is entirely withdrawn from the chamber. At this point an ejector is pivoted downward by a cam on the upper flange of the left side plate. The protruding rear end of the ejector deflects the empty case downward between the side plates clear of the operating parts.

The compressed driving spring furnishes the energy to speed the lock frame towards battery. During recoil the feed lever operating stud on the side of the barrel extension contacts the lower end of the lever, pivoting it rearward. The stud passes under the end of this piece and then snaps back into position, so that during counterrecoil the operating stud pushes its lower end forward.

This actuates the feed crank, which in turn

moves over one space the feed slide containing a cartridge. The feed-slide return lever, plunger, and spring then force the slide toward the inlet side of the feedway to engage the next round. The new round having been indexed, the cartridge now releases the carrier latch from the carrier-lock frame. The barrel and extension have already reached full battery position and the lock frame, ramming the round ahead of it, starts chambering it. During this final movement the operating lever following the upper cam grooves pushes the breechblock up to lock and support the base of the cartridge during the act of firing. The gun, being cocked, loaded, and locked, will continue the cycle of operation as long as the electric trigger is actuated and ammunition remains in the belt.

While this Browning M9 was used to a very limited degree by the United States Army Air Force during World War II, it was, especially in the early stages of the war, the principal offensive aerial cannon of the Russians. Thousands were furnished to Russia by our Government, along with the Bell Aircobra plane on which it was mounted. Its installation permitted firing through the hollow propeller hub, thus eliminating the need for synchronization. The Russians found that the high-velocity armor-

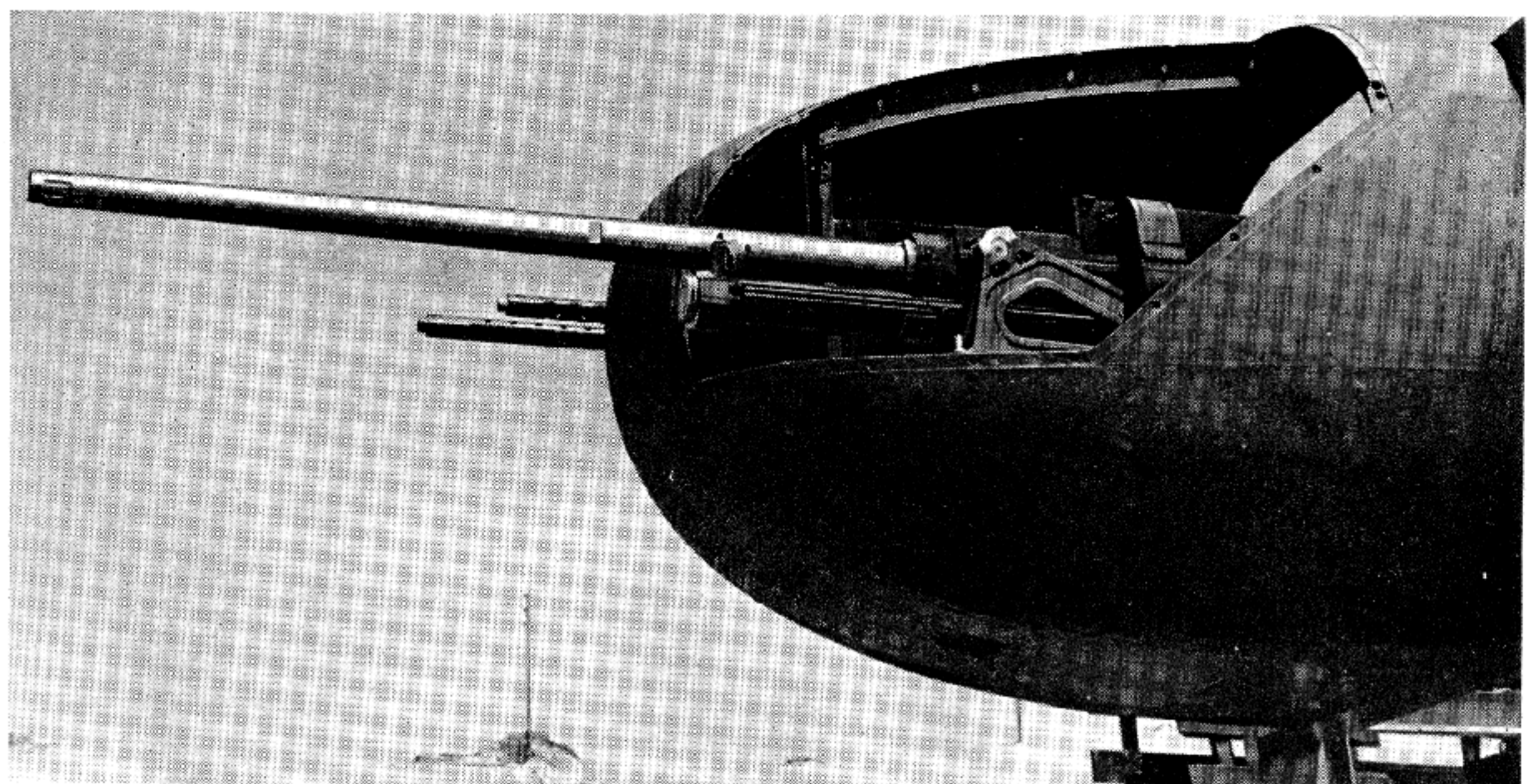

Browning 37-mm. Automatic Aircraft Cannon M9, Mounted in an A25.

piercing projectile was extraordinarily good when used on enemy tanks in the close ground support of their infantry. There were several instances where, in developmental work, these 37-mm automatic cannon were mounted in the wings of American planes. However, as there was no pressing need for such a cannon, as far as we were concerned, its use did not extend much beyond the experimental stations and proving grounds.

A very unfortunate accident occurred during development work on this gun, resulting in the death of Fred Moore of the Colt Co. on 31 March 1938. Being used to dummy small arms rounds being marked "Inert" when the cartridge was not loaded, he placed a 37-mm round that was so marked in the feedway of the gun during a hand-cycling demonstration. He thought that the wording meant the whole round was a dummy, when in reality this marking had

reference only to the lack of explosive charge in the projectile body. The weapon was resting on two wooden sawhorses and, when the loaded cartridge was chambered, it went off. The recoiling unmounted gun struck Moore in the side causing his death a short while later. His passing was a distinct loss for automatic weapon design.

This tragic incident shows how easily accidents can occur even to the most highly trained professionals when the least confusion exists as to the meaning of ammunition markings. It proves once more that "familiarity breeds contempt." Working in constant danger, even the most skilled ordnance man sometimes becomes careless.

Shortly after the tragedy, this method of marking was abandoned and a system of boring holes in the empty cartridge case to signify a dummy round was adopted.

## MADSEN AIRCRAFT CANNON

The Dansk Industri Syndikat of Copenhagen, Denmark, in 1926 announced to military attachés of all nations that its company had produced the pilot model of what it considered to be the ideal automatic cannon for aircraft armament. The weapon, which was given the name Madsen, was 20 mm in bore, employing a rimmed cartridge. Its rate of fire was listed as 180 rounds a minute; it was magazine fed, air cooled, and operated from short recoil; and it was identical in principle with the already well known rifle-caliber Madsen machine gun. The only feature different from the earlier model was the employment of a hydraulic buffer cylinder to absorb excessive recoil brought about by the larger powder charge. The ammunition was specifically designed to be used both in the air and, if necessary, on the ground as a defense against tanks.

This Danish company was very fortunate in that its plant was in a free port which allowed the custom-free importation of an unlimited supply of materials. This gave access to the world's best metals. For instance, Sweden, which had long been internationally famous for her

high-grade steel, furnished blanks for the Madsen barrels, the work of boring, reaming, and rifling being done at the Copenhagen plant. In some instances, the finished barrel was also purchased in Sweden.

The weapon was designed, according to the company, for wing and flexible mounting only, and it was not recommended for engine installation. This was believed dangerous since its employment of a specially designed high-velocity cartridge would lead to excessive vibration during automatic fire. Although the announcement of the prototype Madsen cannon was made in 1926, actual development of the weapon beyond the crude stage was exceedingly slow. It was 2 years before it had been refined enough to permit foreign observers to witness a demonstration. According to reports, the performance was far from impressive.

Well realizing that it was by no means far enough advanced to interest aviation authorities, the company's next step was to promote it for antitank and antiaircraft use and to this end it directed all its efforts. The transportation problem for ground work was settled by mounting it

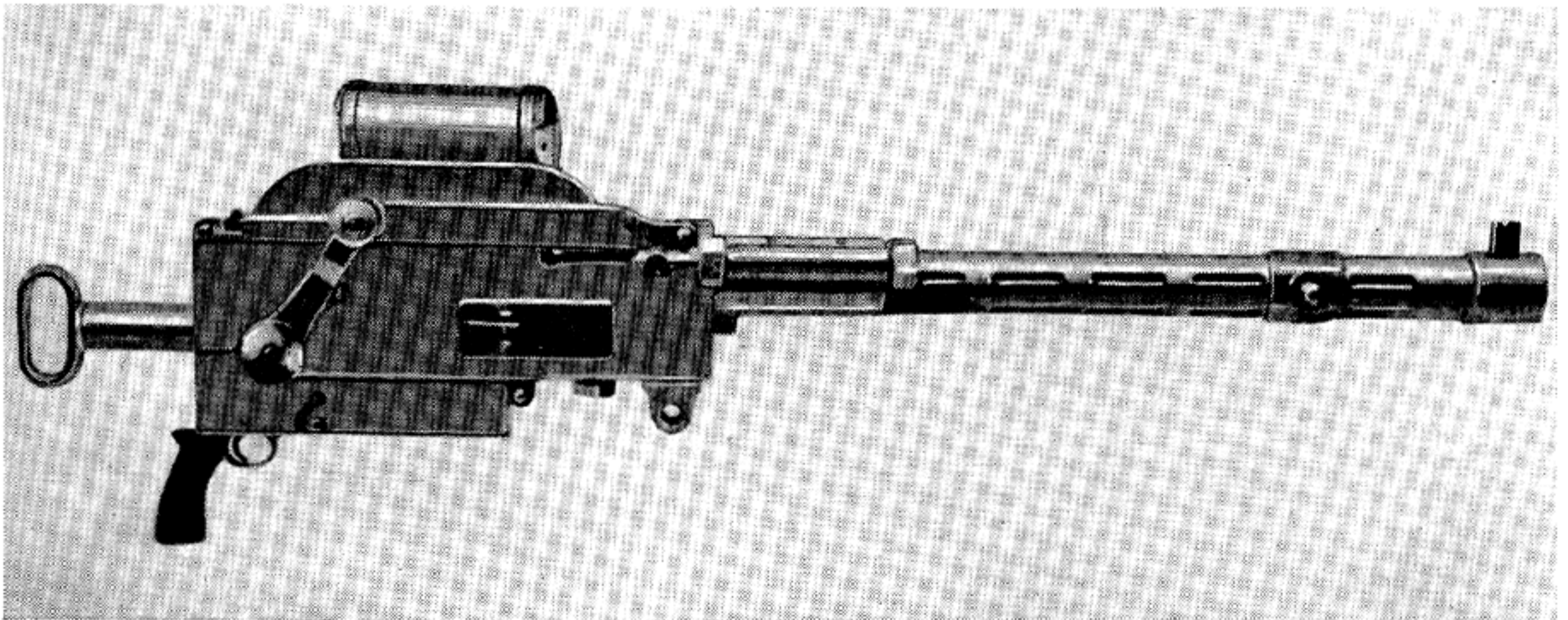

Madsen 20-mm Automatic Aircraft Cannon, Model 1926 (Prototype).

on a two-wheeled mount with a trail somewhat like a field piece. It could be put into action to fire against attacking aircraft in a matter of minutes. A piece fixed at the top of the tripod arrangement allowed the weapon to be raised on its mount and pointed upwards in any direction.

After the first few years no major power paid any interest in the weapon other than to purchase one or two to test at its own proving grounds. In fact, so little interest was shown that it was with the greatest of difficulty that the weapon was kept in existence until the revival in aircraft cannon began in Europe in the late thirties. Then any automatic cannon capable of being mounted in a plane was worthy of consideration by the leading nations of the world.

The Danish firm increased the bore of the gun and it was given great impetus when at the Paris Exposition in 1936 a Fokker G-1 airplane was displayed with a Madsen 23-mm gun installed in each wing. One hundred rounds of ammuni-

tion per gun were carried and fed to the weapon by means of a metallic disintegrating link belt. The ammunition represented the most modern armor-piercing, high-explosive and ball-with-tracer types.

This display not only aroused the interest of military authorities on the Continent but likewise of the United States. Our attachés were requested to forward to the Chief of Army Ordnance all available data on the weapon and also to ascertain the price of four guns, plus necessary accessories and 5,000 rounds of high-explosive ammunition.

The Dansk Industri Syndikat on 18 May 1937, contracted to furnish the weapons, with ammunition and accessories for the sum of \$28,611. The 18th of August was set as the date of delivery, but it was not until 1 October that the inspection of the first cannon took place at Copenhagen.

Of the guns presented, only one met contract specifications. The cannon was accepted and

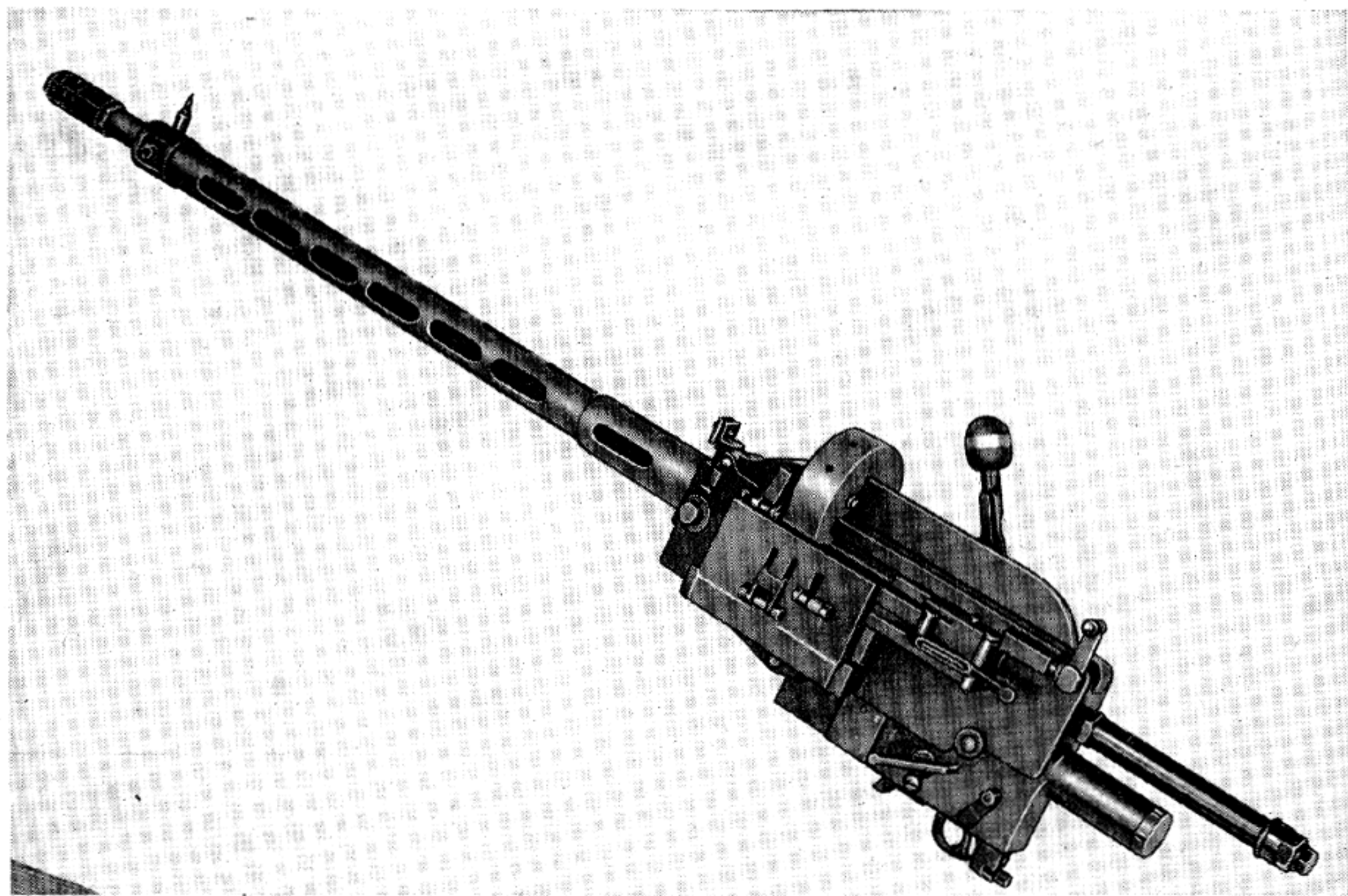

Madsen 23-mm Automatic Aircraft Cannon (Flexible).



shipped to New York on the *Scanstates* in November 1936. It was immediately sent to the Army Proving Grounds at Aberdeen, Md. There the tests to determine reliability met with negative results and the Danish firm was notified that the feed was not functioning satisfactorily. The low rate of fire, combined with the failure of the feed, made the Ordnance Department feel it could produce or find a more suitable weapon for aircraft use, and all interest in this country stopped.

The cannon was sent to Wright Field by the Army for study and eventually the other guns passed inspection and were delivered. Two of the guns were given to the Navy, which fired them at the Naval Proving Ground at Dahlgren, Va., with little satisfaction.

The French Air Ministry purchased a few 23-mm Madsens in early 1938 and according to its report the feed system had been improved and the operation as a whole was reliable. The Chilean Government ordered 20 of the weapons the same year to put in the wings of its Italian-made (Breda) airplanes.

Even with the improved reliability of action, installation in planes was discouraged by the

low rate of fire inherent with all automatic weapons that employed such a long delay during the operation of the feed. The action was so slowed by this system that to get a substantial rate of fire was an engineering impossibility. As there were so many other cannon by this time that gave both reliability and high cyclic rate, the Madsen dropped out as a serious contender as far as aircraft armament was concerned.

On this model there was fastened to the barrel jacket at the forward end a combination muzzle brake and device to trap the blast after the projectile cleared the bore. This was done by a controlled orifice that permitted the projectile to clear along with some of the still-expanding gases. The remainder acted on the face of the barrel somewhat on the order of a piston, accelerating the recoil forces and resulting in an increased rate of fire plus an added amount of belt pull.

The cycle of operation for the Madsen 23-mm cannon is identical with that for the same firm's automatic machine guns. When the belt-fed cannon is prepared for firing, the ammunition belt is started into the left side. The front of the disintegrating link used in the belt fits over the

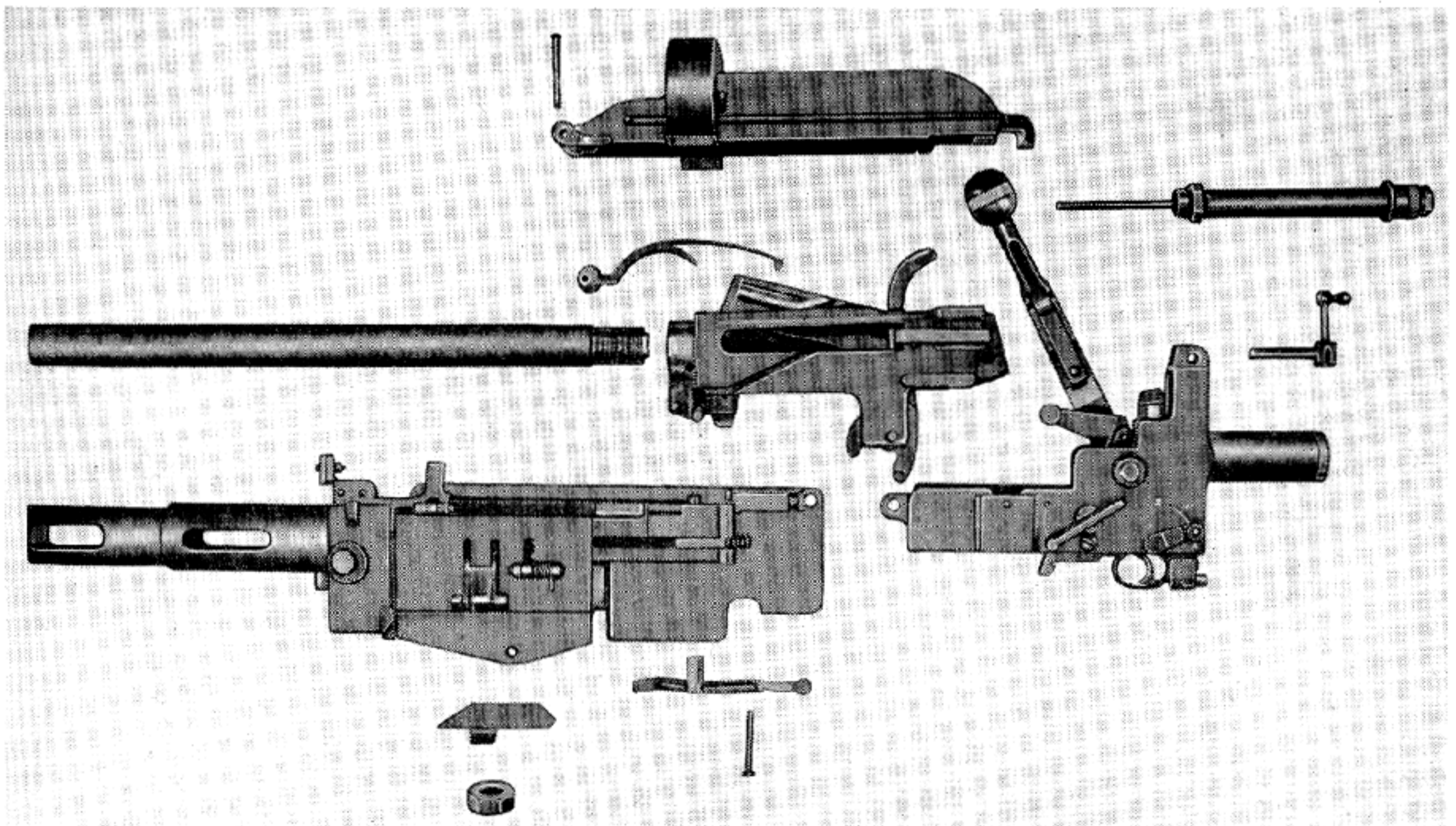

Components of the Madsen 23-mm Automatic Aircraft Cannon.

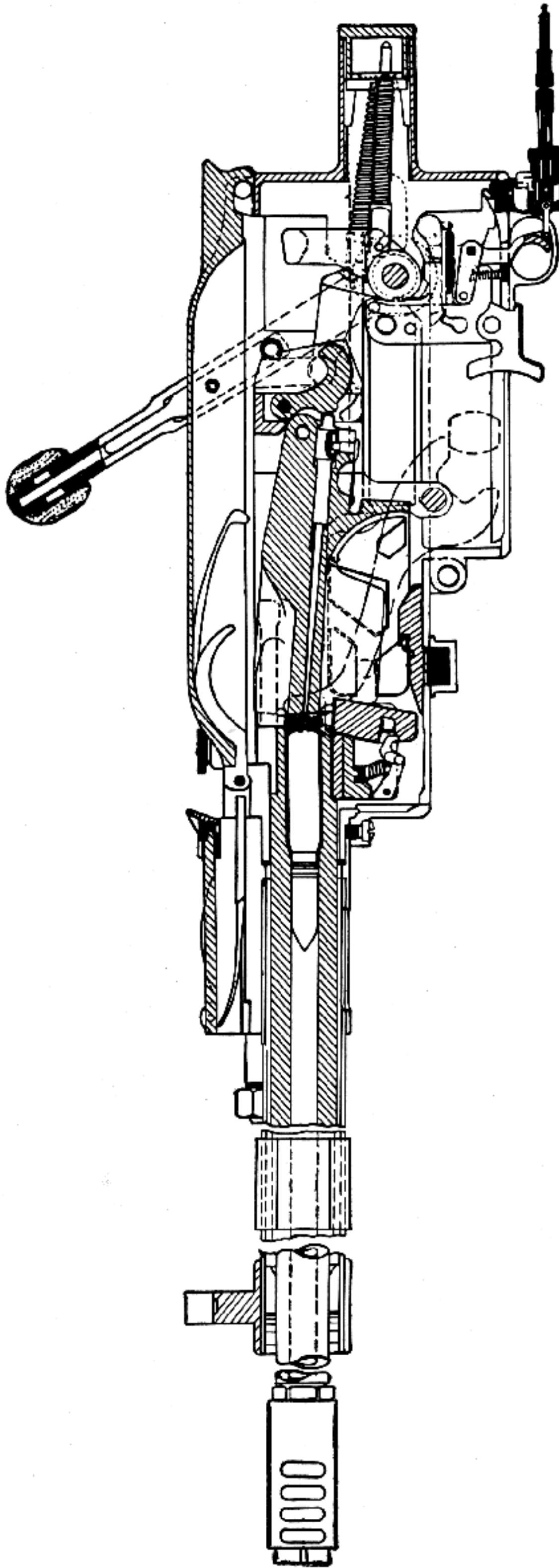

Section Drawing of the Madsen 23-mm Automatic Aircraft Cannon.

shoulder of the round which has to be pulled through it by the feed action. The rear portion of the link is of the type known as push-out, or half-link, since it does not go all the way around the case of the cartridge. A sharp claw of spring steel holds the case firmly until it is finally withdrawn.

Once the weapon is cocked and the first cartridge is placed under the belt-holding pawl, the large charging handle on the right side is pulled back. This action moves the barrel extension a considerable distance to the rear after the bolt rises. The pawl holding the cartridge in position is carried to the right by the camming action taking place between the barrel extension and the piece supporting the incoming round until the cartridge is forced through the feed slot in the receiver.

At this time a spring-loaded claw snaps over the rim of the cartridge. The pivoting of the feed arm actuates the claw rearward and withdraws the cartridge from the belt, positioning it in the feed trough in the top of the bolt. The pivoting lever has by now taken its place behind the round. Upon release of the cocking handle the energy of the compressed driving spring sends the lever forward. The front end of the bolt is pivoted down below the bore in the barrel. Further movement forward of this lever causes it to strike the base of the cartridge, ramming it into the chamber. The final pivot movement raises the breechblock full behind the bolt and the weapon is ready to fire.

The rearward pull of a trigger releases the large striker which flies upwards in an arc against a firing pin, detonating the primer. During recoil, the barrel, barrel extension, and bolt are securely locked for one-half inch, until the trigger bar is struck by the rear of the recoiling bolt mechanism. This frees it, allowing the striker to be forced back to the cocked position and the spring-loaded firing pin is withdrawn into the bolt body. The guide stud then passes out of the horizontal groove and travels up the top cam of the switch plate to pivot the bolt face upwards. The base of the empty cartridge case is thus uncovered, permitting the recoiling extractor to apply a sudden mechanical advantage as it strikes the lug in the bottom of the receiver. The extractor claw, in one rolling mo-

tion, not only withdraws but ejects the empty case from the chamber. The case is guided out of the receiver by the curved contour of the bolt until it falls clear to the ground.

During the last of the recoil movement the barrel extension has cammed another round into the receiver feed slot, and the pivoting feed and operating arm positions it in the trough formed by the machined recess in the top of the bolt. Counterrecoil, originating in the stored energy of the driving spring when it starts the entire operating assembly back to battery, first de-

presses the bolt and then drives the cartridge into the chamber.

The bolt and barrel extension are then accelerated forward by this spring acting through the medium of the cammed pivoting of the radial operating arm. When the counterrecoil movement is almost completed and the base of the cartridge is fully covered by the rising of the pivoting bolt, a cam on the arm automatically releases a sear if the trigger is still held rearward. The striker again flies up to continue the cycle.

# HOTCHKISS 25-MM AIRCRAFT CANNON

The French Air Ministry, shortly after World War I, undertook to write specifications for a 25-mm aircraft automatic cannon that would be worthy of its superb air force and chose for the basic operating mechanism the Hotchkiss system that had served France faithfully for many years. In the opinion of the French, it was the most reliable rifle-caliber machine gun in the world.

Development on the Hotchkiss aircraft cannon was done with the utmost secrecy and the work progressed very slowly due primarily to lack of finances. It was early in 1928 before the pilot model had reached a stage of development that a selected group of foreign observers was permitted to see the weapon. It was demonstrated as an antitank and antiaircraft gun having tremendous weight, and could only be mounted for shipboard use.

The first exhibition took place at the government arsenal at Calais in July 1928. Among the favorable things said about the weapon by proving ground officers was that it had less recoil than any gun of this caliber that the activity had function fired. French cartridge manufacturers had experienced considerable difficulty in pro-

ducing a satisfactory powder for the new round of ammunition but the American Dupont Co. undertook and solved this ballistic problem for them.

The weapon was gas operated, as were all Hotchkiss gun mechanisms. It was magazine fed and air cooled with an announced rate of fire of 180 shots a minute. The operating mechanism was simple in design and very rugged in construction. There were very few working parts, all of which could be easily demounted and reassembled without the aid of tools. The French considered the weapon ideal for the dual purpose of air-to-air combat and also as an anti-aircraft gun for ground mounting. When used in the latter manner, the officers in charge proudly pointed out it had a maximum altitude range of 26,246 feet, which was considered extremely good. One of the most important characteristics of this 25-mm cannon was shown when in an official test an armor-piercing projectile penetrated 1½ inches of armor plate at 700 yards and ¾ inch at 2,000 yards.

On the original model, the low rate of fire and the 10-shot magazine appeared to limit its possibilities for aircraft use. No doubt this was ex-

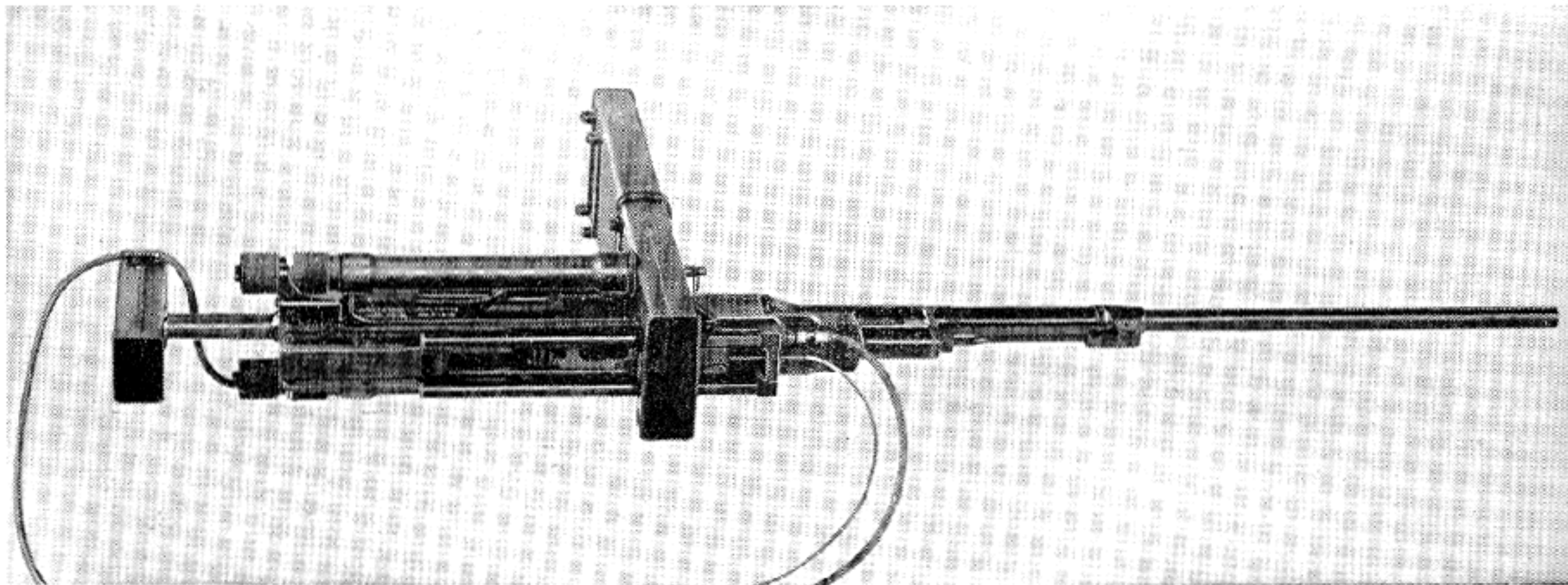

Hotchkiss 25-mm Automatic Aircraft Cannon (Fixed).

actly the impression the French were trying to create, as their refined version for plane mounting was being developed with very little publicity.

In 1937, after French arms plants were nationalized, the United States requested permission to buy one, plus necessary accessories and ammunition for testing. The Bureau de Cessions de Materiel a l'Etranger informed our military attachés that the request was denied since the weapon and its development were considered secret.

Nevertheless a few American military representatives did see the weapon and also observed it firing. It was cycled by means of compressed air, the French engineers having made a device for simulating firing by means of high air pressure.

The Japanese Government, having long been a customer of the Hotchkiss Co. and having plants of its own manufacturing the firm's weapons under license, somehow secured drawings on this antiaircraft version of the weapon and made thousands of them.

Before the French could do more with the refinement and modification of the aircraft type, the Hotchkiss plant fell into the hands of the Germans early in World War II. The Nazis, recognizing it as a very serviceable weapon but not considering it as satisfactory for plane use as their own cannon, relegated these fine weapons to antiaircraft duty.

The weapon in its final design was 96.25 inches long with a muzzle velocity of 2,700 feet per second using a 0.7-pound projectile. The methods of operation for both the aircraft and the ground gun were the same, except for charging and triggering. Barrel change was a slow operation.

To fire the Hotchkiss cannon, the gunner first positions the loaded magazine. The bolt assembly is then retracted until the spring-loaded sear engages the gas piston assembly. In the aircraft gun, this is accomplished by the pneumatic charger while with the ground cannon the gunner uses a ratchet-type lever mounted on the right side of the receiver. The lever is connected with a gear rack and after charging it is manually returned to its forward position.

Pulling the trigger releases the bolt and piston assembly allowing them to be moved forward by the compressed driving spring. Triggering of the aircraft gun is done by remote control with compressed air. In passing under the feeder, the bolt picks up a round. As the round is chambered, the spring-loaded extractor is cammed over the base of the cartridge. The linkage-operated, positive-type lock is actuated by the piston assembly. After the bolt assembly stops in the battery position, the piston assembly is forced forward another 2.25 inches by the driving spring. This movement causes the rotation of the connecting link and the lock, which is cammed up to engage the locking recesses in the receiver. After the bolt assembly is completely

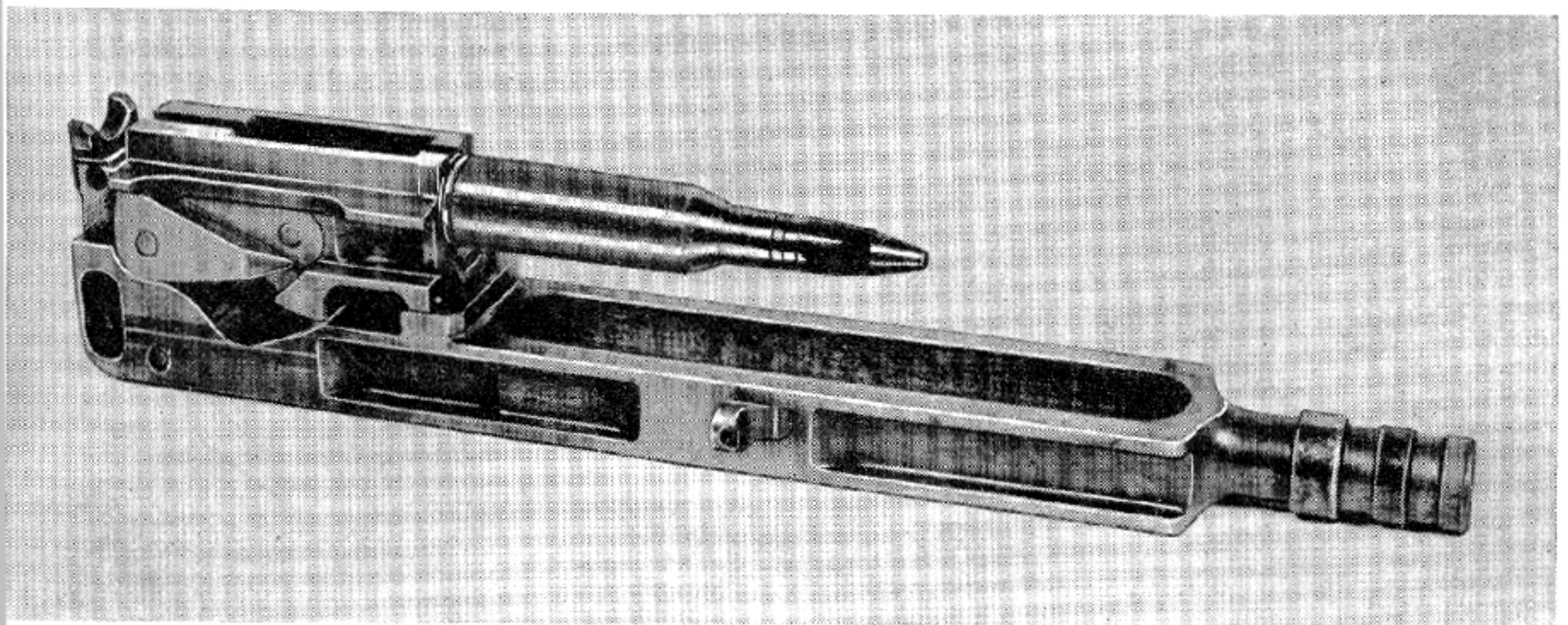

Bolt, Lock, and Gas Piston Assembly of the Hotchkiss 25-mm Automatic Aircraft Cannon.

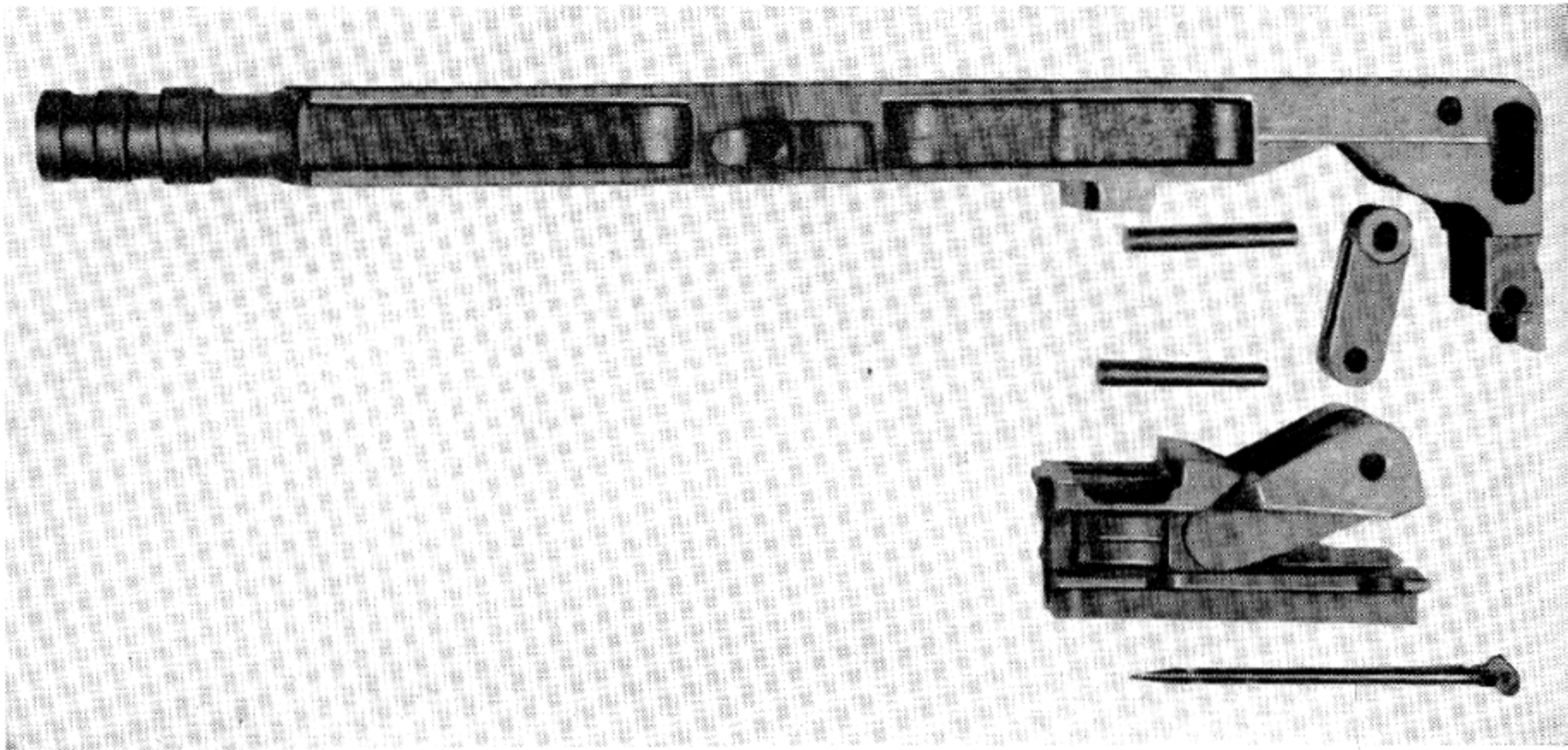

Bolt, Lock, and Gas Piston Disassembled, Hotchkiss Automatic Aircraft Cannon.

locked, the firing pin which is carried in the piston assembly strikes the primer, firing the round.

As the projectile passes through the bore, a small portion of the expanding gases move through an orifice in the barrel and into the gas housing. These gases act on the piston assembly, driving it to the rear. This motion first retracts the firing pin and then through the connecting link rotates the lock down and out of engagement with the receiver. The bolt assem-

bly is now free to move rearward forced by both the energy in the gas piston and the blow-back pressure in the bore. As the bolt recoils, the cartridge is extracted from the chamber and when the bolt rides under the ejector the spent brass is kicked through an opening in the bottom of the receiver. The bolt and piston assembly continue to recoil together compressing the driving spring and unless the release of the trigger allows the sear to engage the gas piston, the cycle will be repeated.

## SCOTTI AIRCRAFT 20-MM CANNON

In 1928 Italy, thanks to the talents of one of her best automatic weapon designers, had available for aviation use a highly advanced 20-mm automatic cannon. Because of indecision more than anything else, the nation did not take advantage of the Scotti aircraft cannon and, by failing to do so, contributed greatly to the weakness of Italian fire power that was so evident throughout World War II.

Alfredo Scotti, the inventor of the system so named, exploited in full one principle of operation from pistol to cannon. His weapons were all gas operated. The gas piston was used only to unlock the piece, while a high residual pressure remained in the bore to furnish the energy to complete the cycle. The origination of this combination gas and blow-back system made him famous and it was widely copied by other gun designers. Scotti was strictly an inventor and in no instance did he ever manufacture weapons of his own creation. Being an Italian subject by birth, Scotti always made the provision, when patent rights were assigned, that Italy had the right to produce the weapons for her own defense.

The Italian motor plant, Isotta-Fraschini, in most cases was the facility chosen for the production of the weapons. This company made the first of these guns for test by the Italian Government. The air force, however, had just had an experience with another type of aircraft cannon that resulted in a miserable failure, and that branch of the service was left hostile to any ma-

chine gun larger than rifle caliber for installation in fighter planes. At the instant of the appearance of the first Scotti cannon, all interest was centered on the development of a 12.7-mm machine gun employing an explosive bullet that had been perfected by Italian ballistic engineers.

All through the thirties practically no encouragement was given the producers of any aviation cannon to refine or improve their guns. Later, however, when it was ruled that an explosive 12.7-mm bullet was a violation of international law, and those responsible for the procurement of aircraft armament realized that they were left without an adequate weapon as a defense against bombers, it was practically too late to undertake the development of a larger gun. Shortly afterwards, Italy was engaged in war.

Had the Scotti gun been recognized from the first and a project on its refinement for aircraft use been initiated, no doubt it would have been one of the most reliable 20-mm cannon of World War II. In physical appearance it greatly resembled the Oerlikon, in which factory the first guns of this type were produced under license. In 1932 Scotti sold his patent rights to the Zürich-Oerlikon Co. of Switzerland, which made a limited number for the commercial trade, used principally by small countries both in Europe and South America, which had need for a reliable aircraft cannon that did not involve too much cash outlay.

It was described by its promoters as ideal for both aircraft installation and antitank work.

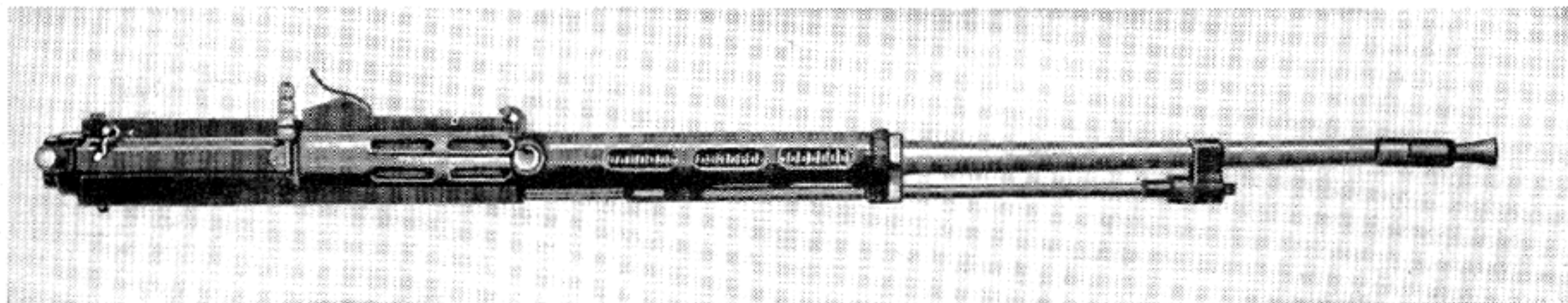

Scotti 20-mm Automatic Aircraft Cannon.



Scotti 20-mm Automatic Cannon on Antiaircraft Mount.

This double duty was attractive to the procurement authorities of second-rate powers. The cannon's main claim to fame is that it was copied basically by another company in designing what resulted in the first-line automatic aircraft cannon of two major powers.

During the latter days of World War II the Isotta-Fraschini Co. manufactured the weapon in quantity, although too late to be of use to Italy, particularly since it had had so little battle testing to evaluate its effectiveness. It is known, however, that the Italian proving grounds reported reliability of action at 600 shots per minute and a system of feeding with a metal disintegrating link belt had also been suc-

cessfully employed. This was in itself a worthwhile accomplishment.

To fire the Scotti cannon, the operator installs a loaded belt, strip, or drum, as the case may be, and pulls the firing mechanism to the rear by the charging handle. This first movement unlocks the bolt and retracts the firing pin. The assembly is held in the cocked position under tension of the compressed driving spring. By actuating the trigger, the sear is released and the bolt starts home, stripping a round out of the feedway and pushing it ahead as the two-piece bolt starts into the last phase of chambering the round. Lugs on the bolt head engage cams in the barrel extension, giving the bolt



head a fraction of a revolution turn and locking the barrel and bolt head together.

The firing pin is housed inside the bolt and is attached to slides that, upon removal of the obstructing lugs, are forced forward by both inertia and driving spring pressure. The firing pin is directed into the primer, which detonates the propellant charge. When the projectile passes a port in the barrel, sufficient gas is bled into a cylinder that houses the gas piston. This closely metered gas gives the piston a slow backward thrust movement at just the right instant to permit contiguous slides to move rearward. They rotate the bolt head while a high residual pressure remains in the bore.

The inclination of the locking lugs at a 60° angle makes unlocking require little energy, as the gas pressure acting on the face of the bolt

would rotate the lugs and unlock were they not covered by the slides. The latter having retracted the attached firing pin, the whole mechanism starts to the rear, with the operational force now coming from the remaining gas, or blow-back. The empty lubricated cartridge case, being held to the bolt face by the extractor, slips back with the recoiling bolt and is pivoted out of the receiver upon making contact with the ejector.

The bolt continues to recoil until stopped by contact with its spring-loaded buffer and compression of the driving spring. If the trigger continues to be depressed, the bolt starts on its counterrecoil stroke to repeat the cycle of operation. Release of the trigger pressure causes the sear to rise and engage the recess in the back of the bolt, holding the entire bolt assembly to the rear.

## LÜBBE 20-MM AIRCRAFT CANNON

A prominent Berlin engineer, H. F. A. Lübbe, completed in 1929 a working model of an automatic gun that he considered the last word in aircraft armament. The weapon was also held to be highly desirable for use against armored vehicles.

The gun in question was gas operated, had a bore diameter of 20 millimeters and had proved capable of firing at the rate of 360 shots per minute. It was air cooled, magazine (drum) fed and its weight was only 107 pounds without feeder. These features are evidence of the careful planning that went into its design. The components were so devised that they could be duplicated in mass production and the simplicity of construction is shown by the fact that there were only 50 parts in all.

Rheinmetall, Germany's big arms-producing plant, became interested in the weapon and in 1931 its leading ordnance expert gave a favorable opinion on it. The German War Office officially tested three of the guns at its proving grounds. The results were unsatisfactory and after one more attempt to revive interest in its production, nothing was done either by the inventor or the German ordnance department to promote it.

The complete assembled unit consists of the receiver, barrel, charging handle, magazine, bolt, gas piston, and push rods. The bolt is held firmly by a transverse breechlock until the projectile has cleared the bore. The barrel is quickly interchangeable (3 seconds by actual test), fastening into the receiver by means of the bayonet lock. The actuating lever in the bolt assembly has a handle protruding through the left side of the receiver for charging the piece manually and this unit must be removed first before complete disassembly.

Incorporated in the bolt is the locking block which is actuated by a lever arrangement that unlocks the action upon reaching a safe chamber pressure. The gas piston which controls the lock serves as an obstruction in the path of the firing pin, making impossible the discharge of the weapon before the breech is securely locked. A heavy spring buffer located at the rear of the receiver absorbs the shock of the recoiling parts and returns them to battery.

The magazine is an open drum-shaped container holding 30 rounds that are fed in by two flat-shaped spiral springs. In order that the point of the projectile does not injure the magazine when shoved forward violently by the act of

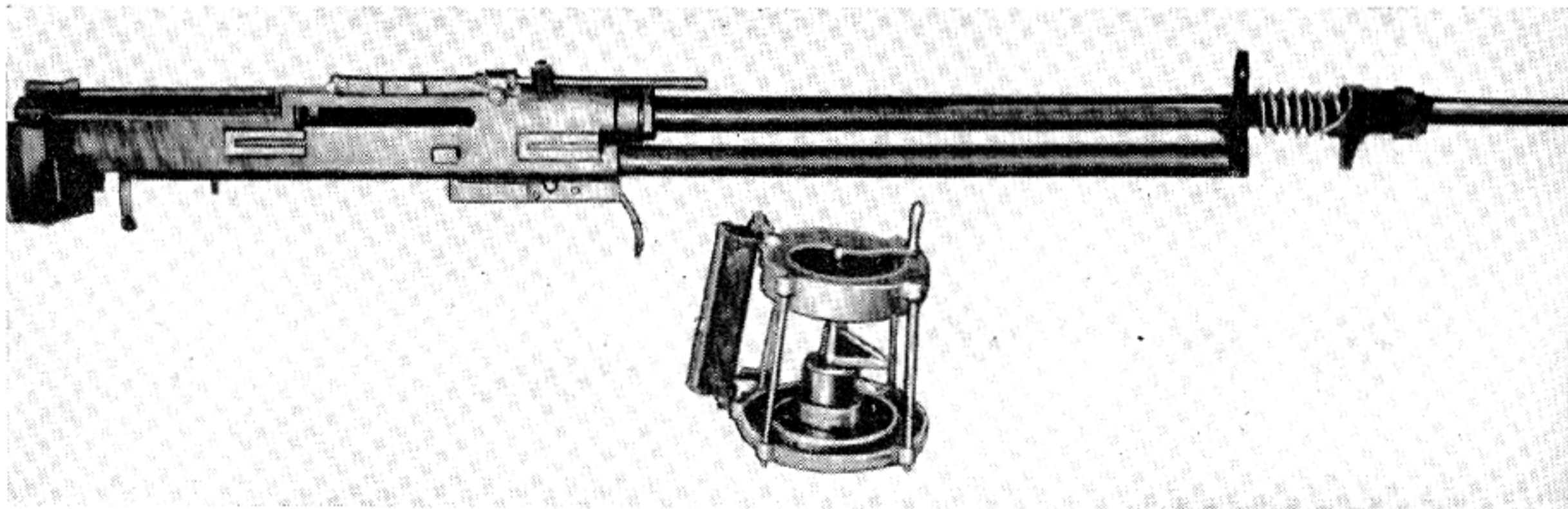

Lübbe 20-mm Automatic Aircraft Cannon and Feeder.

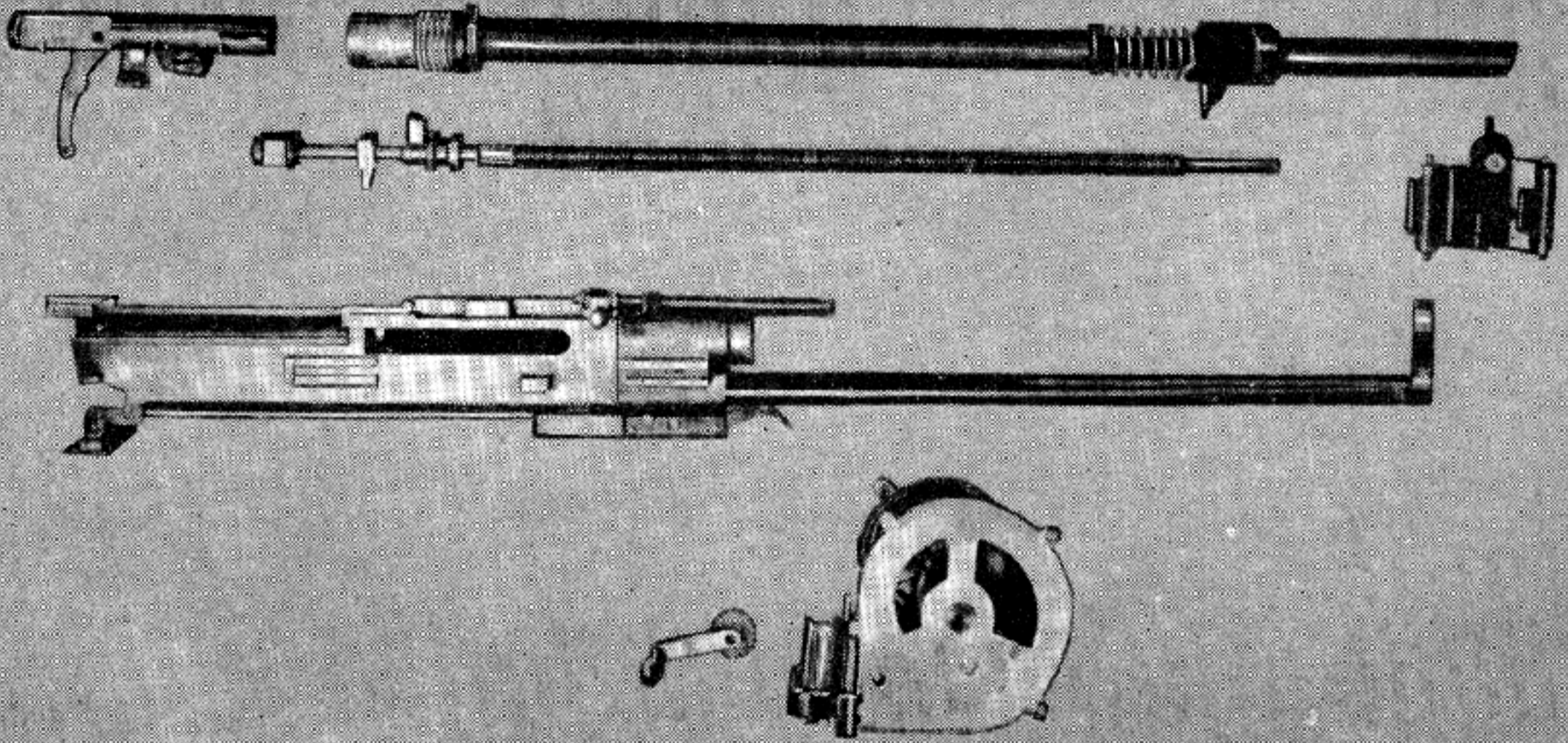

Lübbe 20-mm Automatic Aircraft Cannon Disassembled.

chambering, a specially hardened piece of metal is attached to the front portion of the feed. This deflects the nose of the projectile into alignment with the axis of the bore. During firing, the barrel and receiver recoil in a cradle which serves also as part of the mount.

In the barrel there are two diametrically opposite gas ports enclosed in a cylindrical housing that is also the gas piston. The piston has a short exposed return spring. Mounted beneath the barrel is a long push rod fitted between the gas piston and the bolt-actuating lever. Around the rod is the driving spring and the two are inclosed in a tubular housing. The bolt-actuating lever is pivoted in the bolt body and the tail of the lever extends well below it. Halfway down its exposed length the lever is machined to fit into a slot in the aft end of the push rod.

When the Lübbe 20-mm automatic gun is fired, the projectile passing through the barrel uncovers the gas ports. The expanding gas strokes the piston which in turn forces the push

rod rearward. The latter, being attached to the bolt-actuating lever, swings the bottom of the lever to the rear, while an ear on the top of the rod withdraws the firing pin.

When the lever is moved in this manner, its front face is rotated in a downward direction. This face, being engaged with the lock, slides the latter down and out of the locking recess in the top of the receiver. The bolt assembly then recoils from blow-back compressing the driving spring in the push rod assembly.

At full recoil the gun can be seared. If allowed to fire again, the driving spring returns the mechanism to battery. When the bolt stops, the lock is alined with the locking recess and the driving spring continues forcing the push rod forward. This causes the lever to rotate in the opposite direction and raises the lock. The firing pin, being attached to the push rod, continues to travel forward and strikes the primer, as the cycle is repeated.

# RHEINMETALL-BORSIG AUTOMATIC AIRCRAFT CANNON

Ehrhardt, Solothurn, and Flak 30 Cannon

At the time of the signing of the Armistice on 11 November 1918, there were in German arms plants a number of experimental weapons desperately being worked upon in order to stave off disaster. Many of them were being fabricated under the highest priority. Among these weapons was a pilot model automatic cannon, constructed at the Rheinmetall plant at Dusseldorf, and devised by the director of the firm, Heinrich Ehrhardt, who was world famous for his developments in field artillery.

The gun in question was a 20-mm recoil-operated, air-cooled, magazine-fed automatic aircraft cannon. The locking mechanism was based on a patent by Louis Schmeisser, who as early as 1907 assigned all rights to Rheinmetall, and it was later introduced in a machine gun known as the Dreyse (MG-13). In fact, the Rheinmetall gun, sometimes called the Ehrhardt, was in reality just a scaled-up version of the rifle-caliber machine gun, having identical locking action and acceleration. For the first time in automatic cannon, the driving spring was housed in the top of the hinged cover group. This has since been a characteristic feature of German automatic weapons.

With the occupation of Germany and the tak-

ing over of ordnance plants by the Inter-Allied Control Commission, officials at Rheinmetall knew that the discovery of their new cannon would lead to its being destroyed or, worse yet, tested and copied at the Allied proving grounds. In order to forestall this, just before being taken over, the few weapons that had been made, along with all spare parts, patterns, and mechanical drawings, were shipped to neutral Holland and placed in storage until the occupation forces left and this weapon could again be produced. The move achieved its desired result. The Allied Commission's reports constantly referred to the Ehrhardt cannon but admitted that one had not fallen into its possession for study and test.

An attempt by Rheinmetall in 1929 to establish a subsidiary company in Holland under the name of Hollandische Industrie und Handels Maatschaps (HIH) turned out to be unworkable. In the same year, the firm acquired ownership of the Waffenfabrik Solothurn A. G. in Solothurn, Switzerland, also a neutral country. This plant was originally a watch-making plant, but most certainly the new German owners had other ideas in mind when, with capital furnished in large part by the government, they took over operation of the plant.

No sooner had Solothurn been established as a legitimate outlet for the parent company in

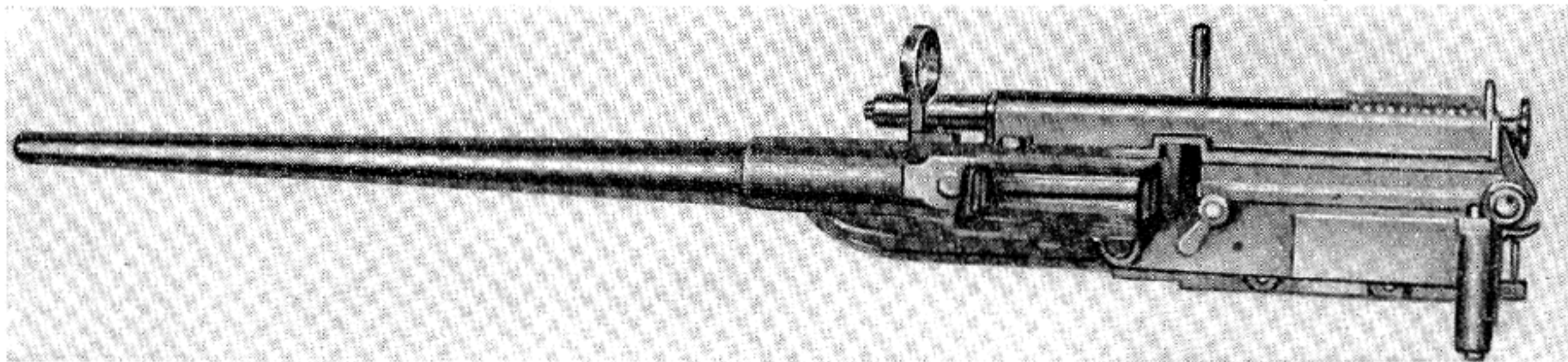

Ehrhardt 20-mm Automatic Aircraft Cannon.

Berlin than a fully developed rifle-caliber machine gun and a 20-mm automatic cannon were put on the market. The cannon, known by now as the Solothurn, was none other than the Schmeisser-Ehrhardt-Rheinmetall gun that had been kept away from the Allies after World War I.

As early as 1926, two of Rheinmetall's most talented automatic-cannon specialists, Fritz Herlach and Theodor Rakula, became actively engaged in refining and modifying the weapon until it met the demands placed upon it by its producers. Both men became important officials of the company, because of their excellent work in designing automatic arms. Herlach succeeded Ehrhardt as director of the company and Rakula held the important post of chief engineer. As soon as the Solothurn plant in Switzerland was taken over, both men transferred to the new factory and worked on the Solothurn 20-mm gun with the purpose of placing it in competition with the Oerlikon gun, also of German origin and manufactured in nearby Zürich.

The cycle of operation on the Solothurn 20-mm automatic cannon consists of the following

sequence: A loaded magazine is put into position on the left side of the receiver with the bolt forward. The selector switch is then placed on *Safe*. The cocking lever is swung out and pulled vigorously to the rear. When the bolt engages the sear in its rearmost position, the lever is returned to battery. The first movement rearward unlocks the weapon and cams the striker down, cocking the piece.

The switch is now turned to *Fire*. The weapon has two hand grips mounted on the back end of the receiver. With the right grip, single shots are fired, while the left grip delivers continuous fire. When either trigger grip is rotated, the sear is disengaged from its recess in the bottom of the bolt. This allows the assembly to be driven forward under compression of the driving spring.

In going forward, the bolt face strips a round from the feed mouth and starts to chamber it. The unlocked barrel that has been held to the rear now starts final movement forward after being released by the rising of the pivoting lock behind the bolt. This act rigidly backs up the cartridge that is being chambered. The last fraction of an inch before going into full bat-

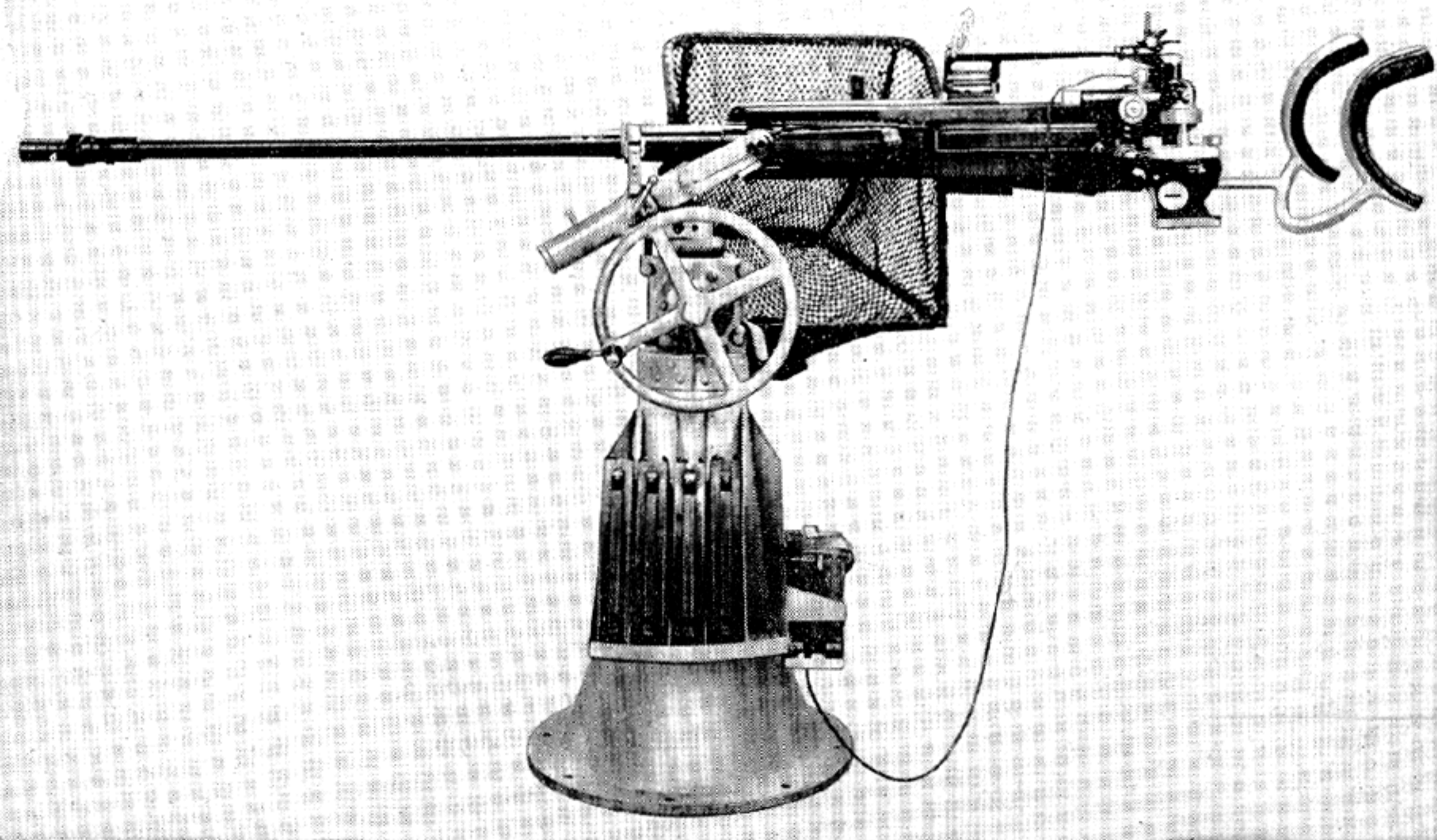

Rheinmetall (Solothurn) 20-mm Automatic Cannon Model ST-5 on a Naval Mount.

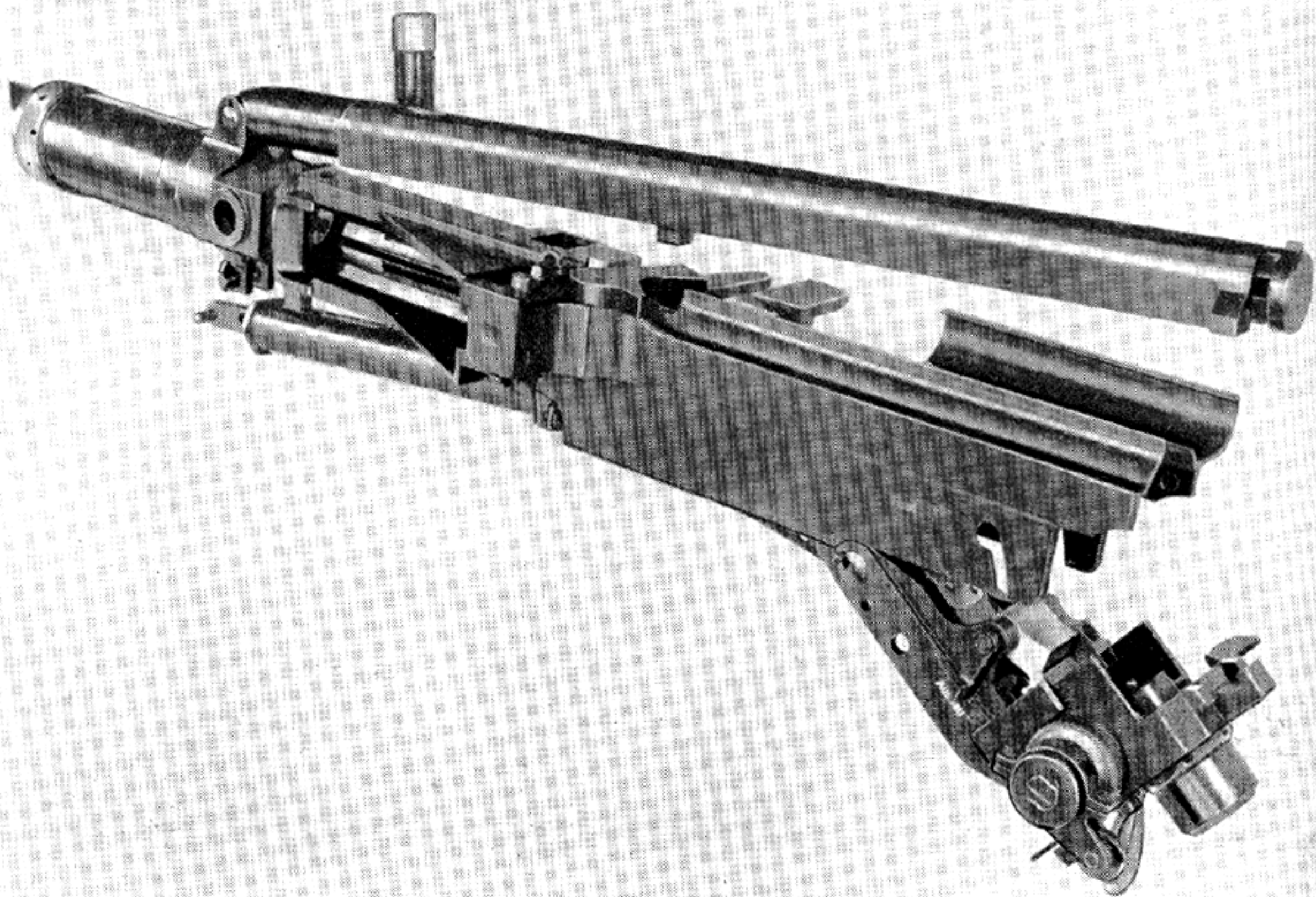

Rheinmetall (Solothurn) 20-mm Automatic Cannon Model ST-5, Showing Ease of Disassembly.

tery position uncovers the spring-loaded striker allowing it free movement to fly up and strike the primer. The recoil caused by detonating the powder charge, which is much greater than that required to operate the weapon, is dampened out by use of a muzzle brake. The remaining energy pushes back both the barrel and the bolt with the pivoting lock holding the assembly locked together for a distance of  $\frac{7}{8}$  inch. At this point the rear arm of the locking lever carried in the barrel extension hits the inclined face of a stationary ramp in the receiver. It slides up and along this slope forcing the forward face of the unlocking arm down until it frees the bolt.

Then begins the action of the accelerator lever which is rotatably lodged in the cradle and is engaged between the barrel sleeve and the breech piece. The recoiling barrel has changed its position until it has a mechanical advantage, thereby transmitting the energy to the bolt

speeding it rearward. While the bolt continues to the rear, the extractor has withdrawn the empty cartridge case from the chamber and positions it to be struck on its base by the ejector which kicks it through the opening in the right side of the receiver. The remaining bolt energy is absorbed by compressing the driving spring and striking a rubber buffer. If the sear remains depressed, the cycle is repeated.

The aircraft gun, similar in design to the above weapon, was designated by the parent firm as the MK-ST-11. It was more streamlined and had a rate of fire of 280 rounds a minute. A ratchet-type charger replaced the straight-pull type. An odd-looking interchangeable twin-drum magazine holding 20 cartridges and an empty cartridge-case bag was used when mounted as a free gun.

The barrel was the quick-disconnect type using the bayonet lock. A muzzle attachment was always employed and rates of fire were increased



Rheinmetall 20-mm Automatic Aircraft Cannon, Model ST-11.

by eliminating the back part and substituting a flash hider. This weapon was fed through the top of the receiver and the driving-spring assembly was mounted underneath.

MK-ST-5 was the nomenclature given the anti-aircraft weapon. It was adapted to shipboard as well as to land use. It differed from the basic first model Solothurn automatic only in the accessories found necessary for various types of mounting and training.

The gun was offered commercially to practically every major power in the thirties. The British Air Ministry ran tests in competition with the Oerlikon gun in 1935, resulting in the selection of the latter weapon. The United States undertook a trial at Aberdeen Proving Ground even prior to the British. On 25 September 1933, the commanding officer in reporting the results summed up the entire proceedings with the statement that "while the weapon did function reliably, there was nothing unusual or outstanding enough to warrant replacing similar weapons we already have." It was not considered an improvement on cannon then under design in American arsenals.

The German high command thought quite

highly of the weapon as an anti-aircraft and tank gun and used thousands of them at the beginning of World War II under the official name of Flak 30. It remained in use until displaced by an improved design.

German military authorities, remembering well their plight in World War I when the British introduced the armored tank, felt that an adequate antitank gun should be in their possession in case of another war. As their needs demanded that it have a large bore with an automatic, or at least semiautomatic action, they turned the problem of a cannon of this nature to Rheinmetall for solution.

Herlach and Rakula, who took over the job, saw at once that, if the weapon had to be as mobile as desired, it must be a shoulder-operated piece with at least a 20-mm bore. The one thing most apparent to these engineers was that the MK-ST-5 could not be adapted. The locking system used in this weapon transmitted too much recoil or kick to the shoulder to make its use permissible unless the weight were greatly increased and this would defeat its purpose of being highly mobile.

As they could not employ the Schmeisser ac-

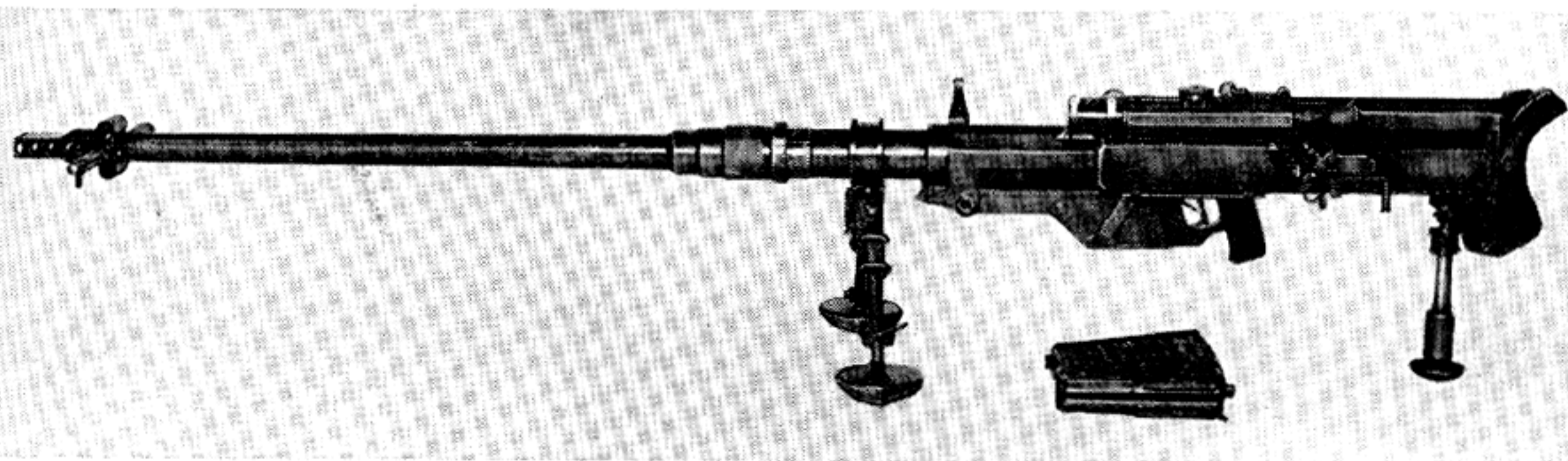

Rheinmetall (Solothurn) 20-mm Semi-Automatic Antitank Cannon, Model S18-1000.

tion, as in the earlier Solothurn gun, the next move was to adopt the Stange system of locking that had been used so successfully in rifle-caliber machine guns. It was scaled up to produce a mechanism capable of handling the high-velocity 20-mm cartridge. The working parts were designed to dampen out the recoil forces so that the explosion of the powder charge took place while the securely locked barrel and bolt assembly were still traveling forward with great speed.

The result of their efforts was the MK S-18-100 and the later refined MK S-18-1000 semiautomatic antitank gun. The Tank Buchse, as it was called by the German soldiers, was recoil operated, clip fed, air cooled and semiautomatic in action, with a quick detachable barrel that had splines cut on the aft end to facilitate cooling and a flash hider on the forward part. It used a high-velocity cartridge that, when loaded with an armor-piercing projectile, could penetrate 1½ inches of armor plate at 350 yards. The weapon became quite popular with the German soldiers as they felt it answered a long-felt need.

The Stange system of locking by rotating a sleeve between barrel and bolt was used on the MK S-18-100 and the S-18-1000, exactly as designed by the inventor. Little or no difference existed between the two weapons. A cycle of operation will not be given on these weapons as they are semiautomatic and their mention here is only because of a highly successful automatic cannon that evolved from these earlier guns.

## Flak 18 Cannon

Shortly after the introduction of these single shot 20-mm semiautomatic rifles into the service, Rheinmetall engineers again turned their attention to the development of an automatic 37-mm cannon, using a centrally locked bolt that was a byproduct of their semiautomatic cannon development.

Locking was done in the simplest manner imaginable. The cocking handle that protruded from the bolt head rode in and was guided by a long slot cut in the side of the receiver. As the bolt head approached battery, the guiding slot curved quickly, rotating the locking lugs on the bolt head and locking it rigidly to the barrel. It is easy to see that with this method there was not the slightest hesitation of the action going into battery and that the full force of inertia could be utilized to dampen the shock of recoil.

The Rheinmetall designers did what so many engineers do under varying circumstances. Not being able to apply Stange's locking system as shown in the patent, they simply reversed the principle and came up with something that could be successfully used.

This weapon fired full automatic, being fed by clips of eight rounds. The rate of fire was given at 180 to 200 rounds a minute and upon its introduction was given a thorough test by the German Army in competition with a Mauser-produced 37-mm gun of similar design.

The unusually reliable action during the trial brought about its choice over its competitor. It

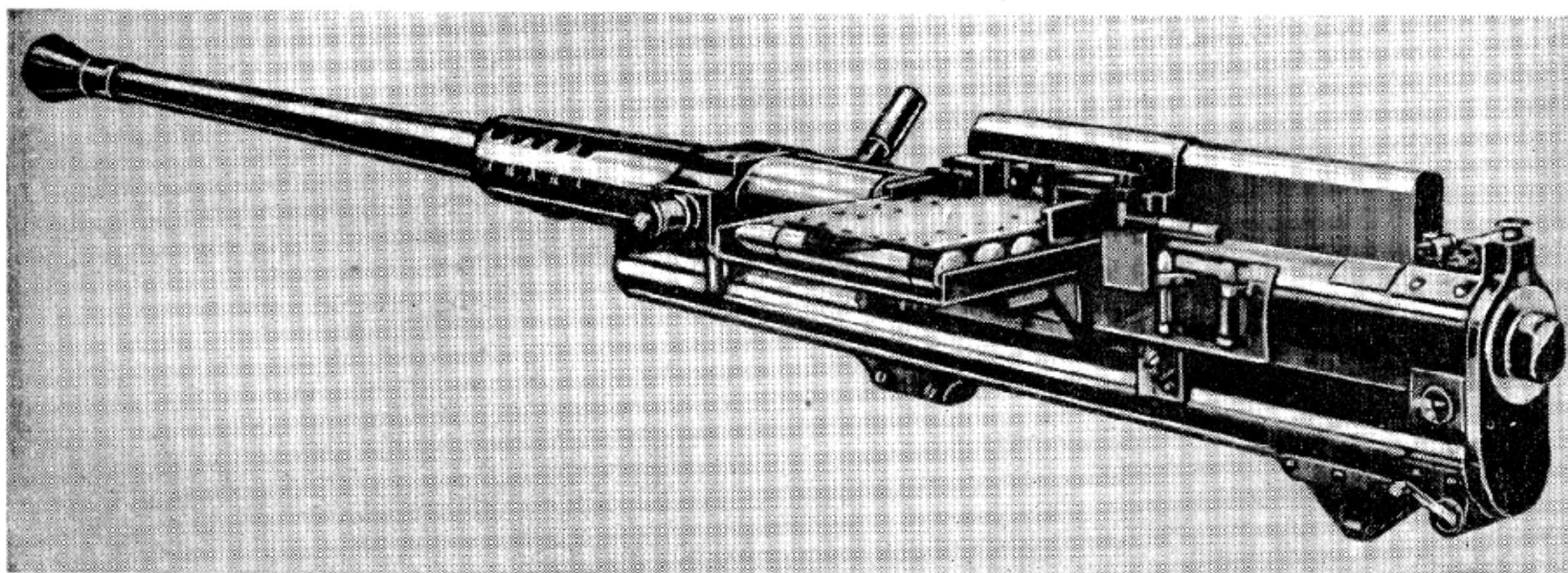

Rheinmetall 37-mm Automatic Cannon, Flak 18.



was promptly adopted and given the designation Flak 18. German antiaircraft regiments used it as their primary defense weapon. A highly sensitive fuze was used on the high-explosive projectile. During one test at a range of 5,000 yards it was fired against a metal wing of an airplane. The projectile, upon entering, made a very small hole and then detonated, tearing out a section of the wing over 8 feet square. The German antiaircraft gunners estimated only one hit would be necessary to bring down the largest planes.

Thousands of Flak 18's were installed before World War II by all German services. They were mounted in the fixed fortifications on the Kiel Canal, as well as along the coast, and it was considered the first-line automatic weapon for antiaircraft defense by the German Navy. Although its main purpose was against aircraft, the army always looked upon it as a dual-purpose gun that could be used effectively against armor if tanks were too heavily protected to be stopped by other guns.

### MK-101 Cannon

By the time World War II began, so much automatic cannon development work was under way in Germany by different plants that the designations given to prototypes and already adopted weapons became highly confusing. By the end of 1942, a new system was instituted of identifying each of the four plants which were handling 90 percent of all experimental and development work. Rheinmetall-Borsig was allotted the number 1; Mauser, 2; Krieghoff, 3; and Krupp, 4.

To identify a weapon, the first digit represents the plant that developed it, and the last two stand for the order or sequence in which it was developed. As several firms were given the same problem in design, the company credited with the solution had its number assigned to the project which it carried all the way through to adoption. For instance, if Rheinmetall developed a prototype for the thirteenth type of weapon specified by the military authorities, the official designation of the finished product would be MK-113. If Mauser were first to succeed in

this development, the nomenclature would be MK-213.

The first weapon to receive the new marking was a 30-mm automatic aircraft cannon which turned out to be merely a scaled-up version of the early 20-mm antitank gun, the Mark S-18-1000. The weapon was designated the MK-101—Aircraft 30-mm automatic cannon. It had a very long chamber and used an extremely high-velocity cartridge for an automatic aircraft cannon.

The locking system is the locking-ring principle, so successfully exploited by Rheinmetall's Solothurn plant in the production of many rifle-caliber machine guns. The in-line action has a bolt with lugs on its forward part to be driven onward by driving-spring compression; upon contact with a collar or ring it turns and locks all these members as one piece until freed by recoil movement. The weapon is electropneumatically charged. It has a means of manually retracting the bolt after it is unlocked, but the necessary rearward movement to free the bolt and barrel must be done by compressed air.

The bolt sear is disengaged from its recess in order to fire and remain disconnected until the last round leaves the feed mouth. There are two different types of magazines with this gun. One is flat; the other made in the form of a drum. In both cases, however, the cartridges are positioned by spring pressure. When the last round leaves the magazine, a spring-loaded follower strikes a latch which allows the sear to engage the bolt holding it to the rear. Cocking the gun is thus unnecessary after placing a loaded feed clip into position.

The firing circuit is designed to permit either single shot or automatic fire. When firing is interrupted by opening the electric circuit, the bolt will go home with a round in the chamber. The forward end of the barrel is fitted with a muzzle brake and recoils within the recuperator housing. Interrupted threads in the breech end allow a quick disconnect and longitudinal cuts in it furnish rigidity and additional surface for heat dissipation. The bolt is flat in design on both top and bottom with lugs on each side to engage mating interrupted threads in the locking sleeve. A spring-loaded extractor is on the under side and on top is a patented feature of

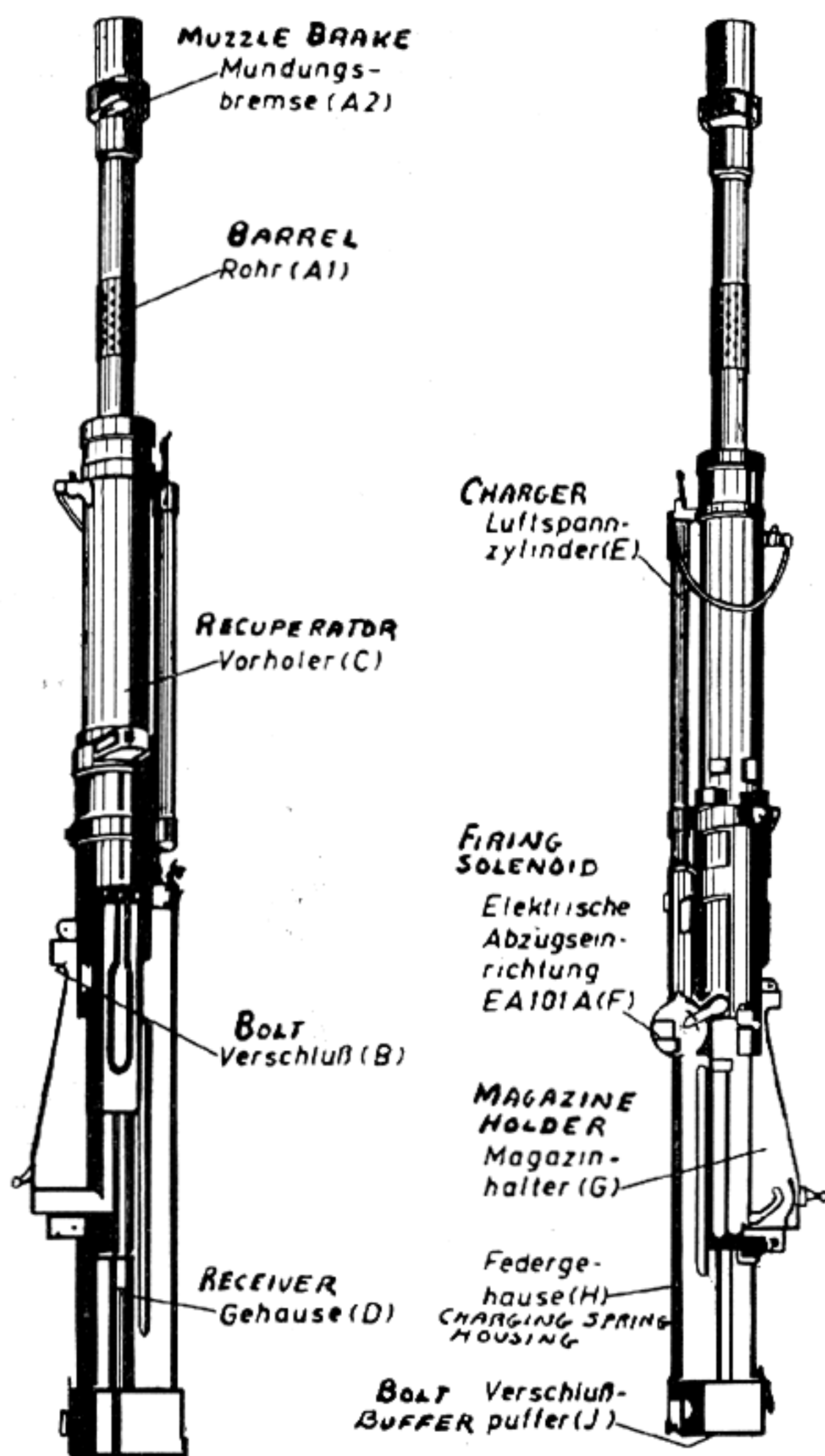

Rheinmetall 30-mm Automatic Aircraft Cannon, MK-101.

Strange's that permits an unusually short recoil stroke before picking up the incoming round. A safety lock can be so positioned as to make it impossible to depress the solenoid actuator.

To fire the MK-101, a loaded drum is attached in its fastening latches on top of the receiver. Air from a cylinder is admitted to the charging mechanism through an electric solenoid valve. This allows compressed air to enter the piston housing against the charging piston, forcing it back with the bolt assembly until it engages a rear-searing device after the contact button of the charging valve has been broken. The

release of air depresses the sear and allows the bolt assembly to be driven forward under energy of the compressed driving springs.

The bolt face picks up a round from the mouth of the feed, chambering it at the same time the rotating sleeve locks the piece in battery. Firing is accomplished by depressing the button that engages the solenoid; this moves a lever that in turn disengages the front sear from the firing pin grooves. At this time a heavy spring drives the firing pin into the primer, to fire the chambered round. The barrel, bolt, and locking sleeve are all firmly joined while the projectile is traveling through the bore and remain that way until an inch and a half of recoil takes place.

During the first bit of travel the cocking lever is pivoted, at first withdrawing the firing pin within the bolt face and then compressing the firing-pin spring tightly until it is seared back, fully cocked. The locking sleeve, the rollers of which are guided in the cam slots, is now rotated unlocking the bolt, at which point the accelerator speeds the bolt rearward. The barrel and locking sleeve are held in a retracted position while the bolt is still recoiling. It carries the empty cartridge case, withdrawn from the chamber by the extractor, until the ejector makes contact with the rim of the case, pivoting it out the ejection slot in the bottom of the receiver.

Further recoil compresses the driving spring and the bolt hits the buffer, after which an opposite movement begins. As the bolt moves forward, the first round in the magazine is started towards the chamber. At the same time the extractor claw is cammed over the rim of the cartridge. Shortly before the bolt strikes the locking ring, the coupling lever is lifted by an inclined ramp on the bolt body. This releases the retracted barrel and locking ring at the exact instant the bolt lugs are opposite their mating threads in the ring. The rollers in the locking ring follow the camming grooves which rotate the sleeve, quickly locking the entire assembly. If the solenoid is still actuated, the firing lever moves the sear out of engagement with the button on the firing pin. The latter flies forward to fire the propellant charge in the cartridge again.

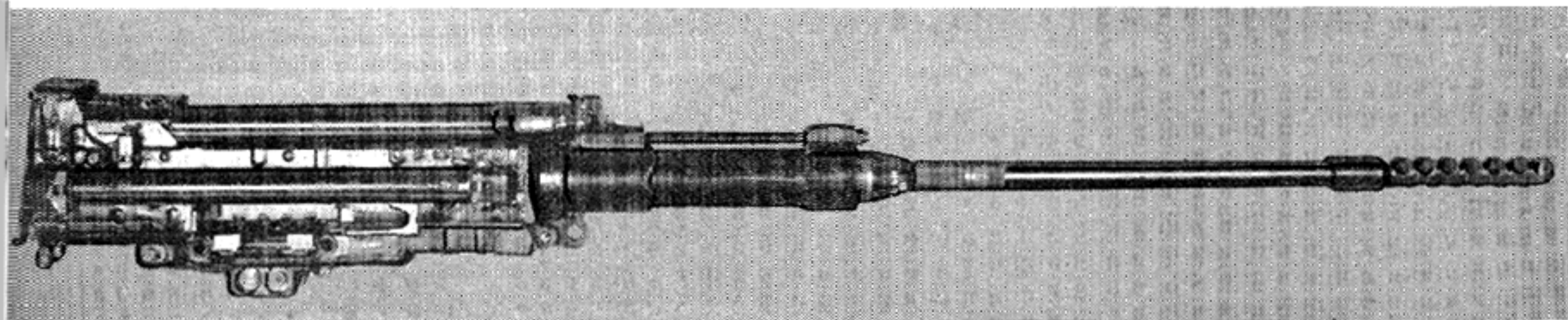

Rheinmetall 30-mm Automatic Aircraft Cannon, MK-103.

### MK-103 Cannon

While the MK-101 was used by the German Luftwaffe mostly on the Russian front in the Heinkel 129, a heavily armored plane especially designed for ground attack, this type of installation was also employed for tank-destroying purposes. And while it was designed for specific work and its over-all use was limited, it certainly called attention to the need for a 30-mm aircraft gun of this type with more fire power.

It was soon followed by another Rheinmetall development, the MK-103. This 30-mm automatic aircraft weapon was also gas operated, air

cooled and belt fed, a metal disintegrating link being used. The feed was actuated by the recoil forces of the gun. The primer was fired electrically with charging and searing being performed by compressed air. A muzzle brake was employed to reduce the shock of recoil. The rate of fire was 450 rounds a minute. Locking of the bolt was done when two swing-type locks were forced behind their locking keys in the barrel extension body. A gas piston located beneath the barrel furnished the power to unlock and drive the bolt assembly to the rear, assisted by blow-back forces. The locking arrangement on this gun was practically identical with an experi-

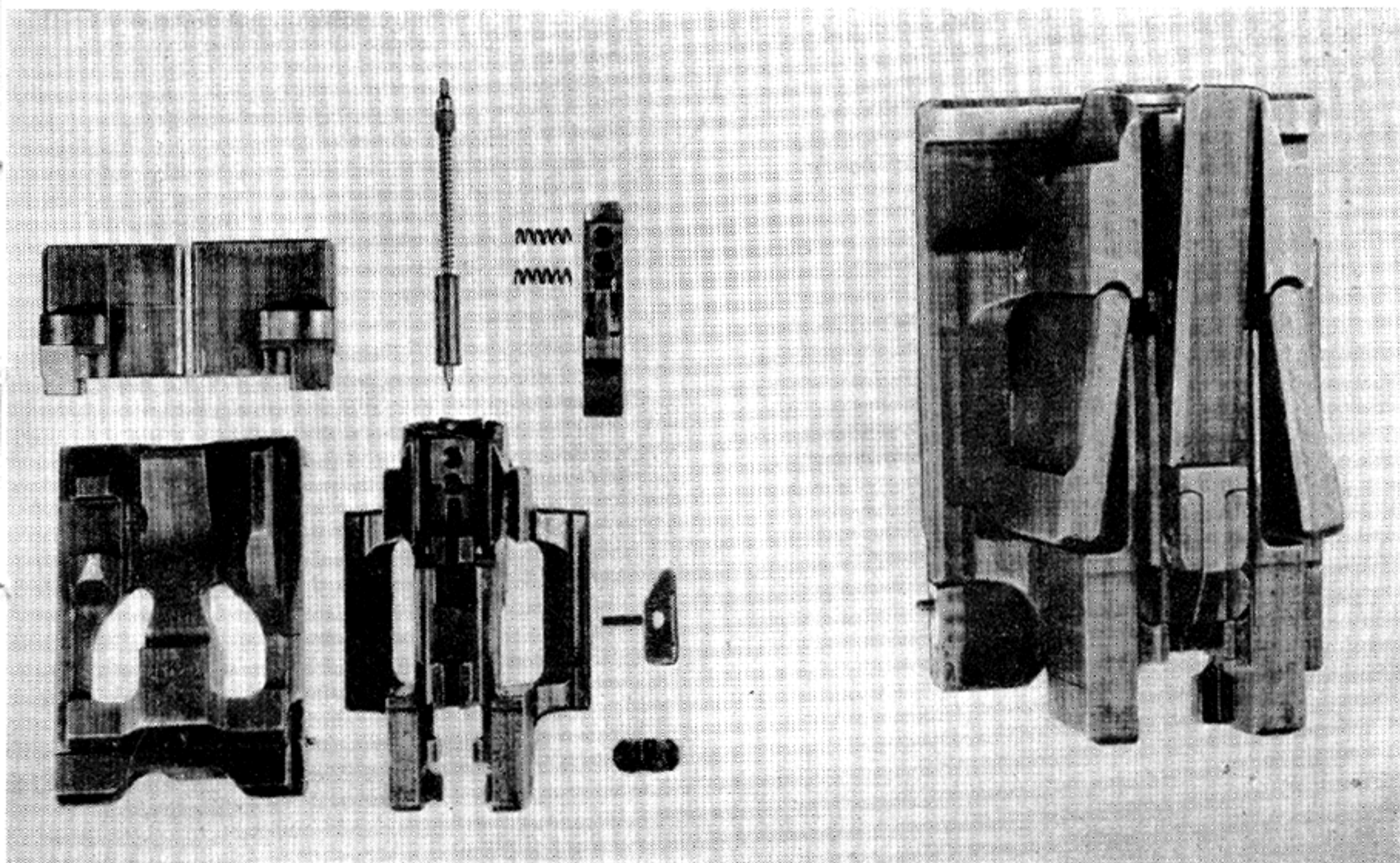

Bolt Assembly of Rheinmetall's 30-mm Automatic Aircraft Cannon, MK-103. Left: Bolt Mechanism Disassembled. Right: Bolt Mechanism Assembled and in the Locked Position.

mental one from an American automatic gun that never advanced beyond the prototype stage.

To fire the MK-103, the gunner places a loaded belt in the feedway until the first cartridge is behind the belt-holding pawl. Then air is turned into the charging mechanism by actuating the charger valve. The pneumatic effect on the charger's piston-like front and on the driving springs forces the whole assembly rearward carrying the bolt group with it. The sear engages the bolt and holds it in a cocked position, until another valve releasing air pressure forces the holding device down and allows the bolt to fly forward under tension from the driving spring. On the final movement rearward, the center pawls in the feed position the first round for stripping.

As the bolt is driven forward, the rammer engages the rim of the indexed round and starts to chamber it. The extractor claw is forced over the lip of the rim at this time. The upper part of the bolt is abruptly stopped as its face strikes the breech. However, a striker on the rear of the piston keeps on to force the two swinging locks out into their locking abutments into the barrel extension, thus locking the bolt securely behind the chambered round.

The cannon now being loaded and ready to fire, pressure on the trigger button closes the circuit and the electric primer in the cartridge is set off. The action remains locked for the first 2 inches of recoil, but force is transmitted to the feed pawls and they are moved over one space shoving the cartridge across the spring-loaded rammer, forcing it down. After the projectile has cleared, pressure is brought on a gas piston housed in a cylinder beneath the barrel. Being driven rearward, the piston and slide uncover the two locks, allowing them to move into the bolt body and all recoil together. The extractor pulls the empty cartridge case from the chamber and holds it until the ejector at the rear of the feedway strikes the top of the rim, knocking it down and out of the receiver. Continued recoil fully compresses the driving springs and the final movement ends with the bolt striking the buffer. The first phase of counterrecoil places the cartridge-holding pawl in the feeder over the next round. The rest of the forward travel is used to strip and chamber the new round and

to lock the action into battery. The cycle is repeated if the electric circuit is still energized.

### MK-108 Cannon

When the German Air Force was suddenly thrown on the defensive by heavy bombing raids, an automatic cannon was offered by Rheinmetall that was designed for one purpose only, air-to-air combat against big bombers. The gun was given the designation MK-108. Although design began in 1941, it was not given the highest priority in production until 1944. One direct hit from its unusually large projectile was deemed sufficient to bring down any plane.

The weapon was blow-back operated, rears, sears and belt fed, with a maximum rate of fire of 450 rounds a minute. It used electric ignition and was charged and triggered by compressed air. On the ME 109 plane the gun was mounted on its side and fired through the hub of the propeller. Sixty rounds of ammunition were fed by means of a metal disintegrating linked belt from an ammunition can that was located directly above the gun.

The system of operation employed in the MK-108 is nothing other than the original Becker-Oerlikon method, brought up to date and using a larger cartridge. The barrel and receiver do not recoil, the entire force being taken up by the rearward motion of the heavy bolt against strong springs that also act as buffers. There is no locking action between the barrel and bolt at any time.

An extra long and heavy push-out type link holds the cartridges and as the bolt goes forward upon release of the sear, a rib on top of the bolt passes through the link to push a round into the chamber. After being fired, the empty case is withdrawn and repositioned in the link, there being no ejection of the single cartridge as in most other automatic weapons.

Due to the fact that straight blow back is used, it is necessary that the ammunition be prelubricated. The most unusual feature about the aircraft model is the extremely short barrel with its resulting low muzzle velocity. The term, head space, in its ordinary sense, is not applicable in this gun. The electric circuit leading to the fir-

ing pin is closed the instant the round is safely inclosed, but because there is a certain time lag, the primer detonation of the charge actually takes place after the circuit is broken but while the mass of the heavy bolt is still advancing. This utilizes the tremendous force forward as a substitute for a locked breech.

Since the ignition is tripped well out of battery, the electric system is designed to make it impossible to energize the firing pin with a bolt fully home. For with a closed bolt minus the forward speed of the assembly, a round fired in this position would wreck the mechanism. The air charger consists of a fixed piston and sliding sleeve with a stout retaining spring. Air is introduced by means of a solenoid valve. After charging, deenergizing the solenoid causes a valve to open dumping the charger side of the line. The return spring then moves the assembly back to the front of the receiver.

The feed is unique, two operating lugs actuated by grooves cut in the top of the bolt working by means of linkage. Disintegrating links

are necessary for successful operation. The links enclose both the cartridge case and most of the projectile, presenting a solid chute when positioned in the receiver. Feeding is accomplished in two movements. As the bolt moves rearward, the cartridge and its link are moved outward by the ejection pawls while the incoming round and link are started over by the two feed pawls. When the bolt begins counterrecoil, the feed pawls move back in line with the chamber carrying the incoming round.

Each phase of operation produces a separate motion for the feed belt. After the cartridge is chambered and fired, the empty case is returned to its former place in the link as before feeding. This allows the linked empty cartridge to come from the opposite side of the receiver. With the projectile in a cartridge, a link could not be separated, but after it is out, the links can come apart upon leaving the gun and a metal finger on the side of the receiver accomplishes this action. Another unusual feature about this very efficient weapon is that over 80 percent of it is

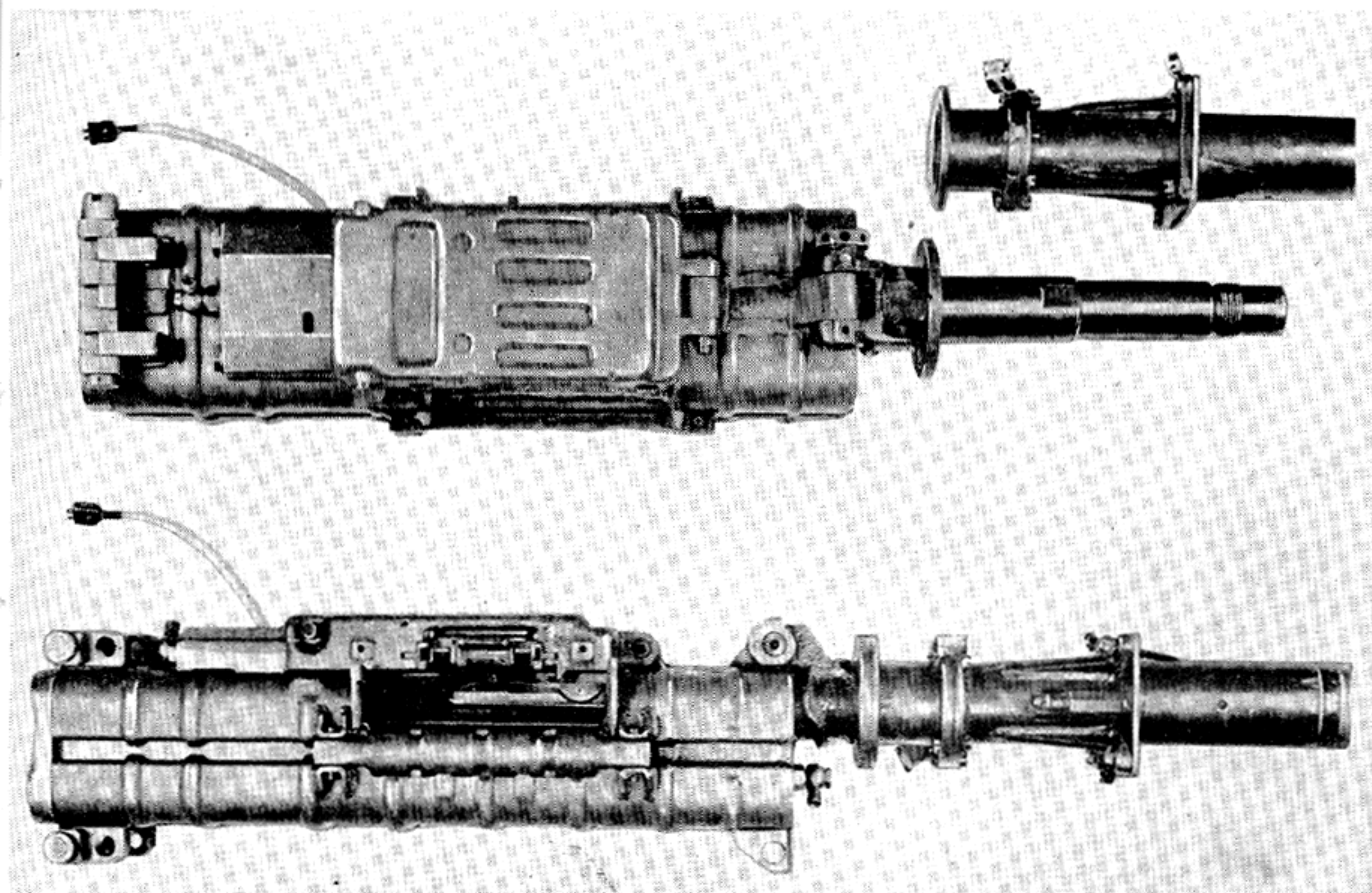

Rheinmetall 30-mm Automatic Aircraft Cannon, MK-108.

constructed of stampings, making its manufacture both easy and cheap.

To prepare the MK-108 for firing, the armorer places a loaded belt of cartridges in the ammunition container and inserts the first round under the belt-holding pawl with the bolt forward. The pilot gunner, when readying the weapon for combat, pushes in on the charger button. The electric-powered solenoid opens an air valve on the charging device that throws the bolt rearward until it engages a sear that holds the assembly in a cocked position. The valve now releases the air, permitting the charger to return home from its own spring tension. On this recoil stroke of the bolt the belt-feed lever, actuated by lugs riding in grooves in the bolt body, moves a cartridge over to the edge of the feed mouth.

The gun is now cocked and a cartridge positioned for the next phase of operation. When the sear is released, the heavy bolt starts home under compression of the driving spring. Its first forward movement causes the incoming round to be moved over the necessary distance to be indexed. The bolt face, which is narrower than the cartridge width, contacts the base of the cartridge pushing it through the link into the chamber. At a distance of one-sixteenth inch be-

fore final movement is halted by complete chambering, an electric contact is made that energizes the firing pin.

This detonates the electric primer, but the time delay is enough to allow the bolt to go still farther into battery. Actual explosion of the propellant takes place while the bolt is still traveling at full speed forward. This permits the projectile to clear the bore of the weapon before the heavy bolt can begin recoil movement. The lubricated cartridge case is free to exert full blow-back pressure on the face of the bolt which starts recoiling immediately after the projectile clears.

The cartridge case is supported by the extractor until the bolt face clears the rear end of the link at which time a dog rises to stop travel of the empty case leaving it in link. Continued movement of the bolt to the rear causes the feed arms to move the belt over three-fourths of a space shoving the empty case and link outside the receiver. The bolt recoil is stopped by compression of the two strong driving springs which places the action into counterrecoil to repeat the cycle if the solenoid remains actuated.

The Luftwaffe's operational tactics were altered to meet the attacks of Allied heavy bombers, and fighter aircraft were required to strike

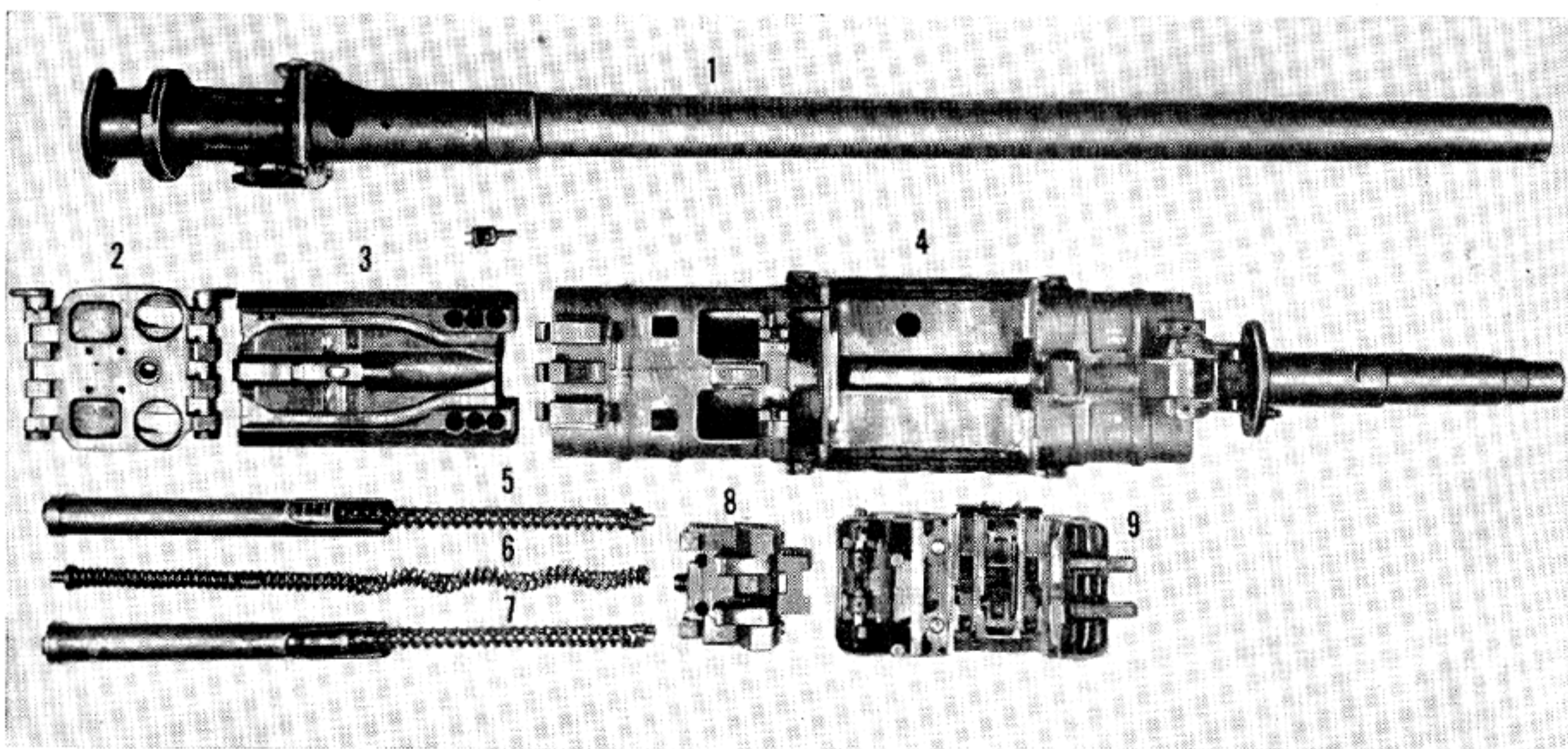

Rheinmetall 30-mm Automatic Aircraft Cannon, MK-108, Disassembled. (1) Blast Tube. (2) Back Plate Assembly. (3) Bolt Assembly. (4) Receiver and Barrel Assembly. (5 and 7) Driving Spring Assembly. (6) Charger Spring Assembly. (8) Sear Plate Assembly. (9) Feed Cover Plate Assembly.

at very short range well inside the fighter screen. For this purpose the light MK-108 gun (135 pounds) with lower muzzle velocity but with a high-capacity high-explosive projectile was very efficient.

This gun was nicknamed the "pavement buster" by American ordnance men, due to its appearance and to its slow but steady rate of fire which sounded like the very common pneumatic-power tool. All ammunition made for this weapon was either high explosive or incendiary tracer, as its low muzzle velocity ruled out the practicability of using either the ball or armor-

piercing types. The short barrel, which is a big factor in excessive muzzle flash, was compensated for by using a long blast tube in all mountings. This not only dampened out the flash, but allowed the blast to be trapped and bled off to prevent damage to the skin surfaces of planes.

The weapon represents the highest degree of efficiency that the Becker system has been brought to and was remarkable in many ways. It was most fortunate for the Allies that its production and mounting in jet planes was not started earlier, as it accounted for many B-17s during the latter days of World War II.

# BIRKIGT TYPE 404 20-MM (HISPANO-SUIZA) CANNON

## Early History of Hispano-Suiza Company

The Société Française Hispano-Suiza S. A., located in Bois Colombes, France, a Parisian suburb, emerged from World War I as one of the most famous aircraft engine manufacturers in the world. This firm was first organized in 1904 for the manufacture of automobiles in Barcelona, Spain, by a Swiss engineer, Marc Birkigt, with the financial support of the Spanish King Alfonso XIII (hence the name Hispano-Suiza, meaning Spanish-Swiss). A plant in Paris was founded the same year, which became headquarters for the organization. During World War I it played no small part in contributing to victory as its battle-tested power plants were used after August 1914 in practically all first-line Allied fighting planes. The Spad, perhaps, was the most outstanding of such aircraft. This important work was done under the



Marc Birkigt, Designer of the Hispano-Suiza 20-mm Automatic Aircraft Cannon, Type 404.

supervision and control of Marc Birkigt, the technical director, Ferdinand Foure, the company's chief designer, and Louis Massuger, the head engineer.

The firm and its officials did not confine their war efforts to the production of aircraft engines. As early as 1917, Birkigt solved one of the most intricate of all problems that faced ordnance engineers, namely, how to fire an unsynchronized gun forward without hitting the whirling propeller. Birkigt conceived a method of mounting an automatic cannon between two banks of cylinders in the engine and firing through an offset hollow propeller shaft. He not only put his idea into operation but produced it in time for fairly extensive use during the last days of the war.

This original 37-mm motor cannon was effectively used against aircraft made of wood and fabric, when supplied with a smooth bore barrel and canister shot. The shot was made up of 24 half-inch steel balls and when fired point blank at enemy aircraft, one round usually decided the contest. French aces, such as Maj. René Fonck and Capt. Georges Guynemer, logged several planes shot down with the company's new aid to aerial warfare. This method of fire power was soon temporarily superseded by high-speed larger caliber machine guns mounted in the wings outside the propeller arc.

The company continued to prosper following the war, keeping pace with the many advances made in aircraft engines, automobiles, and its other products. The corporation at this time was under the control of Marc Birkigt, his son, Louis, and Prince Stanislaus Poniatowski, the latter being the grandson of the last Polish king.

In the early thirties a revival of interest in cannon mounted in aircraft caused even the highest military authorities to predict the passing of the machine gun as aircraft armament.



The Hispano Co., owning patent rights to the accepted method of firing through the hollow propeller shaft, began to seek a suitable light-weight cannon to place in its engine mountings. It decided upon the Oerlikon gun, which was highly esteemed by the French Air Force.

This automatic cannon was of Swiss manufacture, being made at the Zürich plant of the Oerlikon Co. After some delay, the Hispano-Suiza Co., at the request of the French Air Ministry, obtained a license to produce the weapon at its Bois Colombes plant. During the time that Hispano made the gun under license, both Marc and Louis Birkigt patented improvements on the mechanism and the feed. Oddly enough, in each instance the improvement was given as applicable to machine tool and engine adaptation and the word "gun" was at no time mentioned. In this period the Birkigts applied for and received five patents relating to motor mounting of the Oerlikon automatic cannon. All weapons made by Hispano-Suiza under Oerlikon license were given the designation, Hispano-Suiza Automatic Aircraft 20-mm Cannon, Types 7 and 9, to distinguish them from those made by the parent company. The only difference in the two types made in France was in methods of mounting, the operational parts being identical with those of the Oerlikon F or Becker model.

The Hispano and Oerlikon companies, shortly after production began, disagreed over patent rights of certain features originated by the Birkigts, and business connections between the two firms came to an end. The French manufacture of the Types 7 and 9 cannon continued, however, until the expiration of the license. Marc Birkigt now turned his attention to developing an automatic cannon that would be produced and owned outright by the Hispano-Suiza Co.

### Earliest Birkigt Type 404 Cannon

In 1933 Birkigt began work on the devisement of a weapon he later produced successfully. This mechanism could in no sense rise to the dignity of an invention, the principles involved having been long known by those who followed the profession of gun design. A combination of already established methods of operation was arranged

in such a manner as to result in a shooting prototype.

Its system of locking was covered in a patent application by Carl Swebilus, one of the most prolific machine-gun inventors the United States has even known and rated by many as second only to John M. Browning. As early as 15 March 1919, Swebilus applied for a patent on a firing mechanism for an automatic gun. The principal parts included a gas-operated piston that actuated a bolt and extension. The lock was the swinging type that was cammed down into position by the continued advancement of the slide or bolt extension. After the lock had been forced down behind the locking step, the slide, to which the firing pin was attached, insured that the weapon had to be securely locked before the pin could advance and strike the primer. When the gas piston was driven back by gas pressure, an ear on the slide (or extension) would lift the lock up out of its recess into the bolt body where it would then recoil as a part of this piece.

The Italian designer, Alfredo Scotti, can also be credited with several basic principles that were incorporated in the original Birkigt gun. In 1928 a series of machine guns and automatic cannon designed by Scotti began to make their appearance on the Continent. This inventor, who maintained his offices in Brescia, Italy, always depended upon companies with manufacturing facilities to make and promote the sale of his own weapons. His activities were by no means confined to his native land. To handle the distribution of his products outside Italy, he established the Scotti-Zürich Co., a firm located in Zürich, Switzerland. The main components for his guns were made by the nearby Oerlikon Co.

In November 1932 Oerlikon purchased outright the Scotti-Zürich concern, including patent rights for every nation except Italy, utilization of which was reserved for the Isotta-Fraschini company of Milan. The only variations in any Scotti-designed gun were in caliber and means of mounting. He invariably used a system originated by him of combining gas unlocking with blow back.

An outline of Scotti's method of operation, as described by the inventor, is given here in order that one may compare it with the functioning of the weapon later offered by Marc Birkigt.

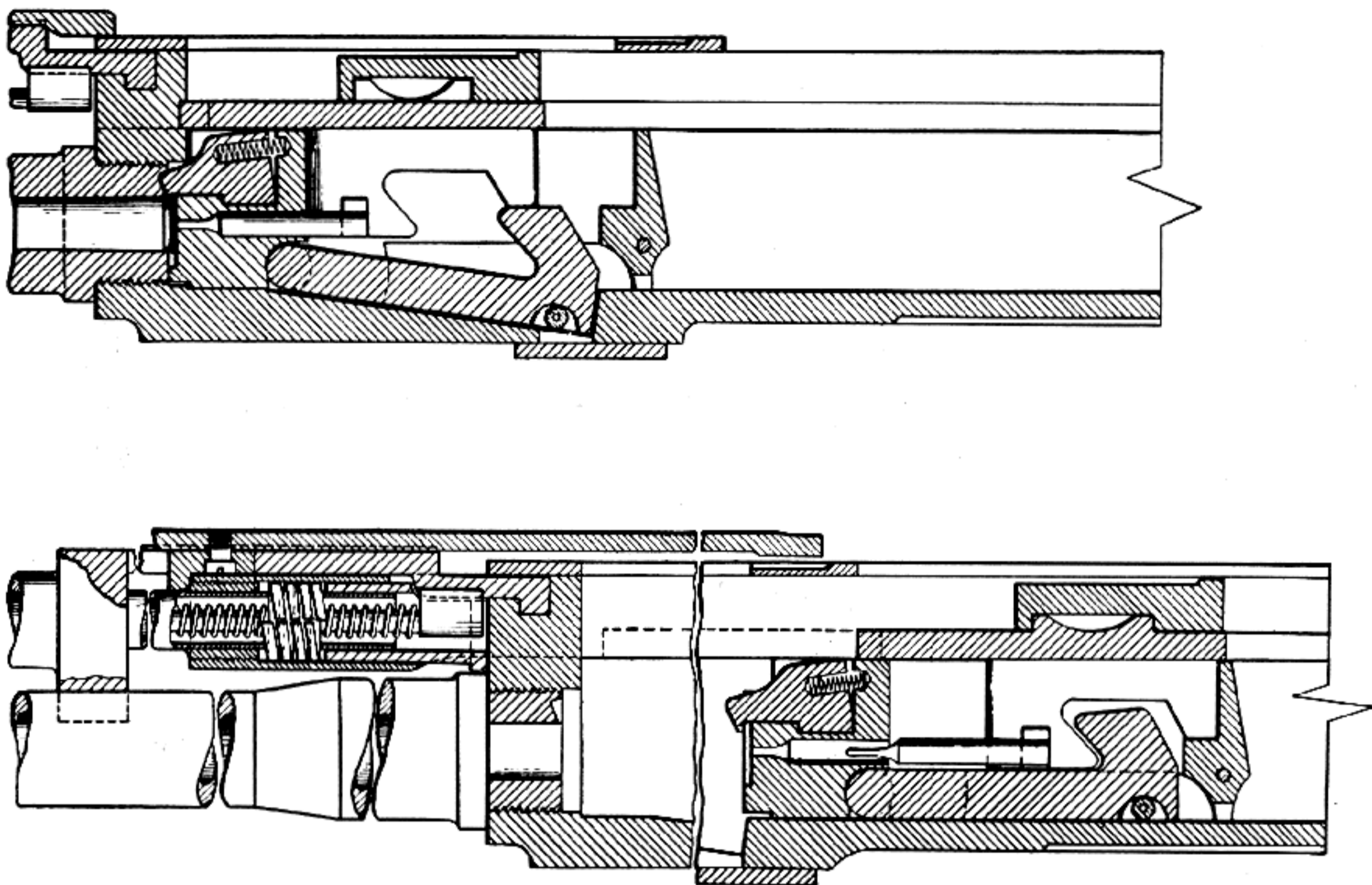

The Method of Locking Patented by Carl Swabilus.

"The firing pin is housed inside the bolt body and is attached to slides that upon removal of the obstruction of the locking piece are forced forward by both inertia and driving spring pressure. The firing pin is directed into the primer which detonates the propellant charge. When the projectile passes the port in the barrel, sufficient gas is 'bled' into a cylinder that houses the gas piston. This closely metered gas gives the piston a slow thrust movement backward at just the right instant to permit the contiguous slides to move rearward. They unlock the bolt while a high residual pressure remains in the bore. The angle on the locking face is so abrupt as to require very little effort to unlock. In fact, the gas pressure acting on the face of the bolt would cause the piece to be freed if the lock was not covered by the slides. When the latter have been retracted with the attached firing pin, the whole mechanism starts to the rear with the operational force now coming from the remaining gas pressure or 'blow back,' the empty lubricated car-

tridge case being held to the bolt face by the extractor until struck by the ejector."

Scotti used a rotating bolt head for the purpose of locking, while the weapon devised by Marc Birkigt, used the pivoting or swinging type of lock, which was cammed down by slides, the energy being derived from the combination of inertia and driving spring compression. The firing pin, being attached to the slides or bolt extension, could only go forward to fire the cartridge after the weapon was securely locked, as already described in the Swabilus patent.

Since these patents not only were in existence but were well known years in advance of the Hispano-Suiza design, it is hard to see, when the major features of Swabilus and Scotti are combined, what is left in Birkigt's weapon that can be classified as original.

Upon hearing of the successful manufacture of this automatic cannon with its unusually high rate of fire, the French Air Ministry notified the

May 23, 1939.

M. BIRKIGT

AUTOMATIC FIREARM

2,159,127

Filed April 16, 1938

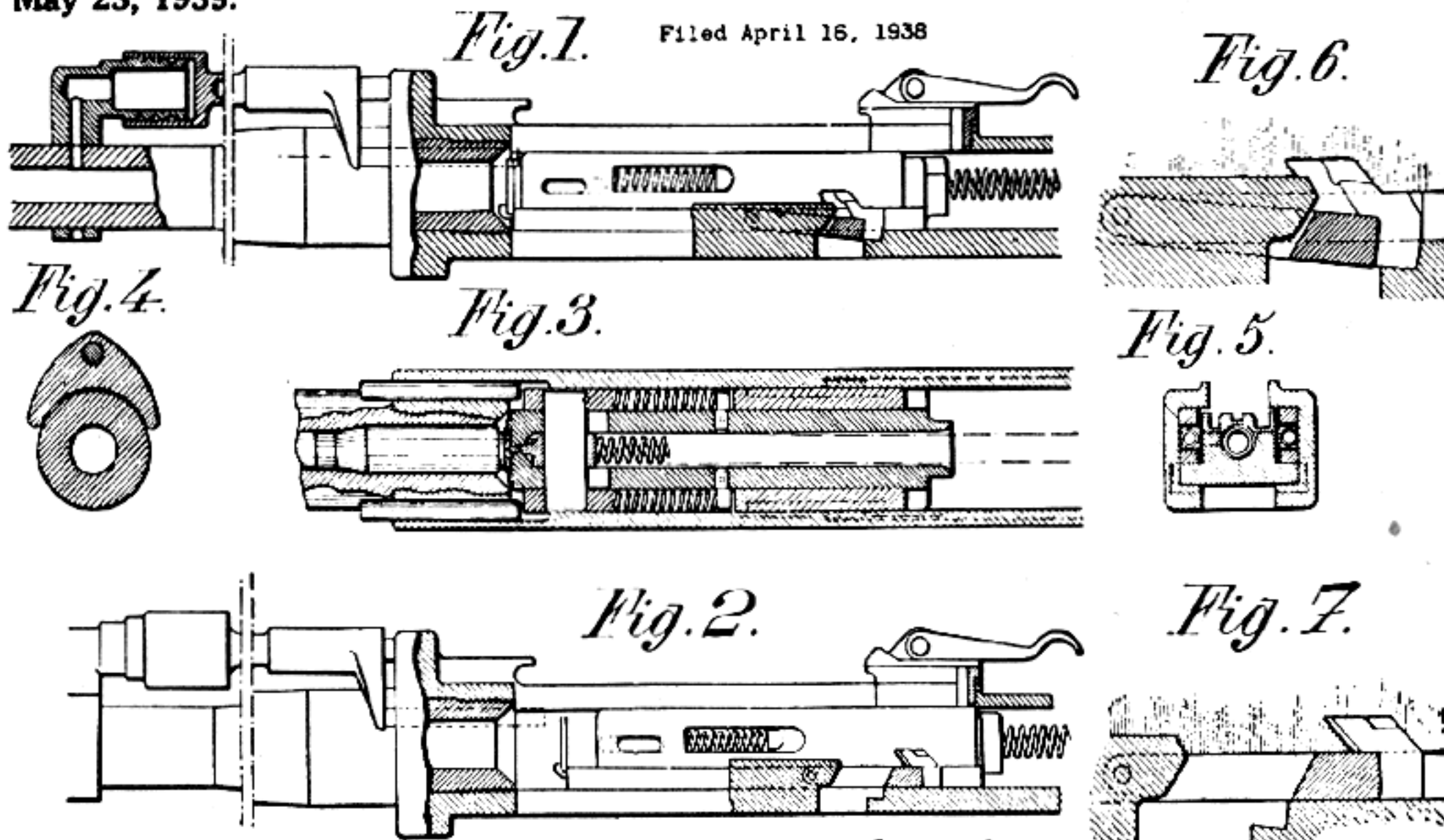

Inventor:  
 Marc Birkigt  
 Bailey & Carson Attorneys

The Method of Locking Patented by Marc Birkigt.

Hispano company that no other country could be offered the weapon without its approval. Three countries, England, Russia, and Czechoslovakia, learning of experimental results through their military attachés, began to make overtures to the Hispano-Suiza company to purchase the cannon for testing purposes.

A rumor that a 23-mm version was sold to Russia without the consent of the Air Ministry placed the whole project practically under secret status. It was charged and denied on the floor of the Chamber of Deputies that the Russian sale had taken place. The Czechoslovakian Commission was unable to obtain official Government sanction to buy the gun and not until the fall of 1936 were British representatives permitted to see it in action.

The men given this privilege were Group Capt. C. H. Keith, R. A. F., and Christopher Bilney, Chief of the Operational Requirements Branch, who were invited by Hispano-Suiza to witness the function firing of a Birkigt auto-

matic 20-mm aircraft cannon. This weapon had been designed for engine installation, since the company was the original promoter of this system of mounting. A firing range had been improvised in an ancient fort at Bouviers, where the new cannon was mounted alongside an Oerlikon. The latter was fired first with creditable results. Then the Birkigt gun was fired and its amazingly high rate, estimated at 700 rounds a minute greatly impressed the British officers. Upon request the parts were disassembled before them, and attention was called to the small number of operational components, and their simple but rugged construction.

The main feature was then pointed out that the gun worked from both gas and blow-back. With this system the breech was completely locked as long as the projectile was in the bore. It not only insured safety but allowed the use of a light bolt. As a result an additional 200 rounds a minute rate over the Oerlikon was reached.

## Cycle of Operation

To fire the 20-mm Hispano-Suiza (Birkigt) automatic gun, the operator must first see that each cartridge case has been liberally lubricated before being placed into the magazine, after which the loaded feed is snapped into position on top of the receiver. Spring pressure positions the first round resting on top of the bolt, which is in battery.

The charging assembly is then pulled completely to the rear or until the sear is securely engaged in its recess under the bolt body. Upon release, the charging unit goes home under its own spring tension. The passing of the bolt rib under the feed mouth allows the incoming cartridge to drop a fraction of an inch for final positioning.

The gun is now in the cocked bolt position and release of the sear allows the driving spring to force the bolt and its components forward. As the front face of the bolt passes under the rear of the feed mouth, it engages the rim of the cartridge, forcing it down into the extractor claws, and continues to push it towards the chamber. Continued travel completes the seating of the cartridge and the forward motion of the bolt is finally stopped by contact with the barrel and receiver. At the instant of impact the breechblock lock is cammed downward into locked position against its locking key, held securely by the continued travel of the slides.

The latter, which are connected through the bolt body by means of a key that carries the firing pin, are now driven on by the combined action of the breechblock-slide springs and the inertia of the entire assembly, causing the firing pin to strike the primer. The powder charge in the cartridge is thereby ignited. The bolt is positively locked at the instant of firing and remains that way until the projectile has passed the port in the barrel, at which point gas is bled into the cylinder that houses the actuating piston.

As soon as the gas piston moves to the rear, its yoke contacts two push rods that in turn engage the slides through the receiver body. The movement of the slides retracts the firing pin for a stroke of three-fourths inch. It also permits the breech lock to rise and unlock after the projectile has cleared the bore, while a high residual

pressure still is present to drive the bolt rearward.

The lubricated cartridge case is now floating in the chamber and when the breech lock is suddenly raised, the remaining chamber pressure is brought to bear on the face of the bolt. The latter starts to the rear with the extractor acting merely as a guide and support under the empty cartridge case. When the bolt face passes beneath the feed mouth, the ejector prongs strike the rim of the empty case pivoting it downwards through the ejection slot in the bottom of the receiver and the spring tension in the feed positions another round for chambering. The bolt continues to travel rearward, compressing the driving spring. At the end of the recoil stroke, it strikes the rear buffer. The latter returns the bolt in counterrecoil to repeat the cycle of operation if the sear remains depressed.

## British Adoption of the Gun

The British Commission, after informing its government of the gun's performance, sought permission from the French Air Ministry to purchase enough of the weapons to allow tests that would prove their worth. The French sanctioned the sale of six cannon to the British on the condition that their own air needs be met first.

The order for the six cannon was placed at once and its urgency was pointed out to Hispano-Suiza. Since the British were not interested in the cannon as an engine-mounted weapon, aircraft manufacturers had to have at least the physical dimensions in order to make a suitable wing or fuselage mounting. After some delay six wooden mock-ups were flown over to the British followed by a barrel and bolt assembly. This allowed proof firing of the barrel and experiments with ammunition of English manufacture.

The delay in actually delivering even one of the six guns on order caused the British authorities to notify the Hispano-Suiza officials that, unless the agreement was promptly met, the whole deal would have to be canceled. In reply the firm stated its intention of delivering the guns promised. The first such weapon was received in January 1937 and underwent tests at the Aeroplane and Armament Experimental Es-

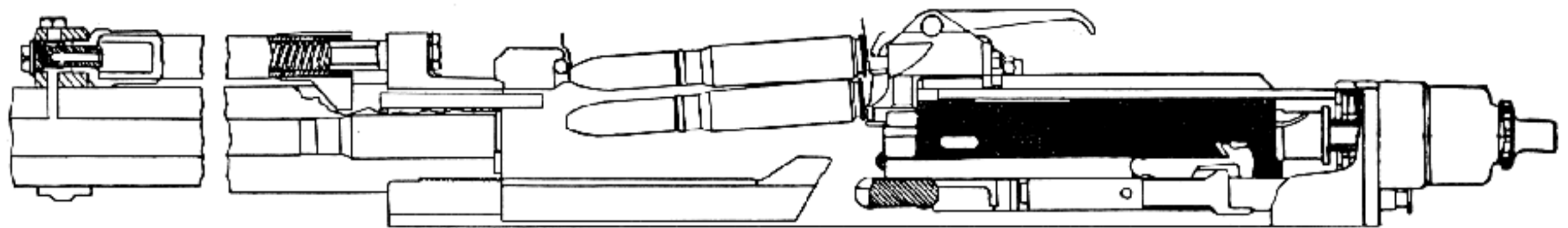

GUN AT REST, BREECH BLOCK ON SEAR.

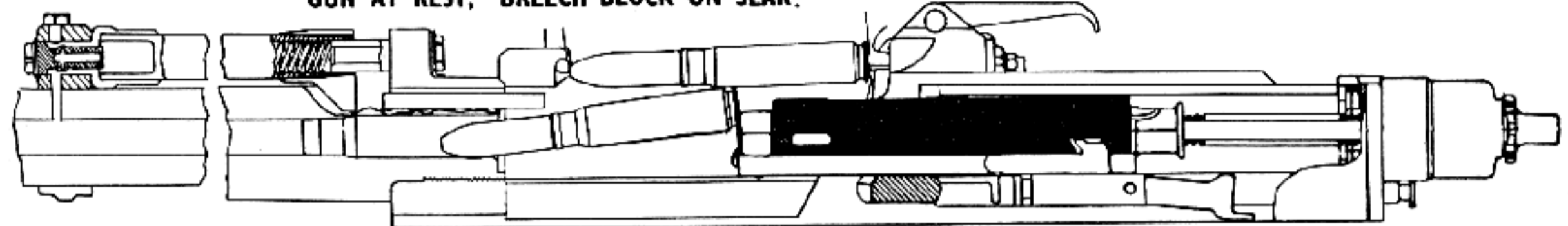

SEAR RELEASED, BREECH BLOCK DRIVING ROUND INTO CHAMBER

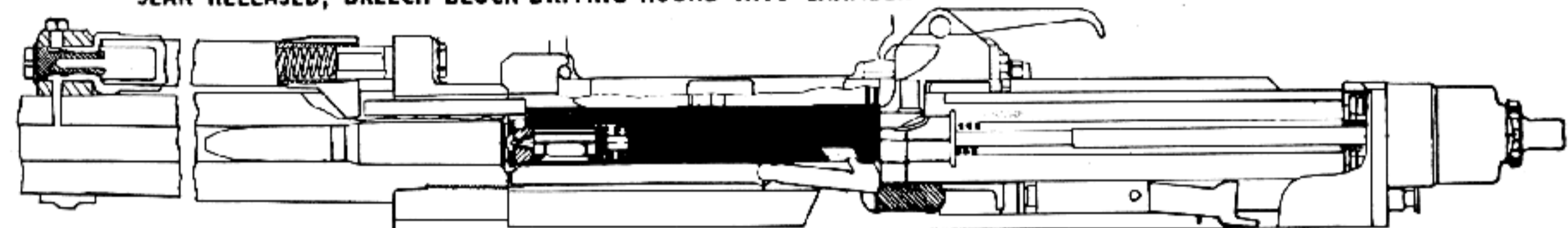

BREECH BLOCK LOCKED, FIRING PIN FULLY FORWARD, CAP FIRED

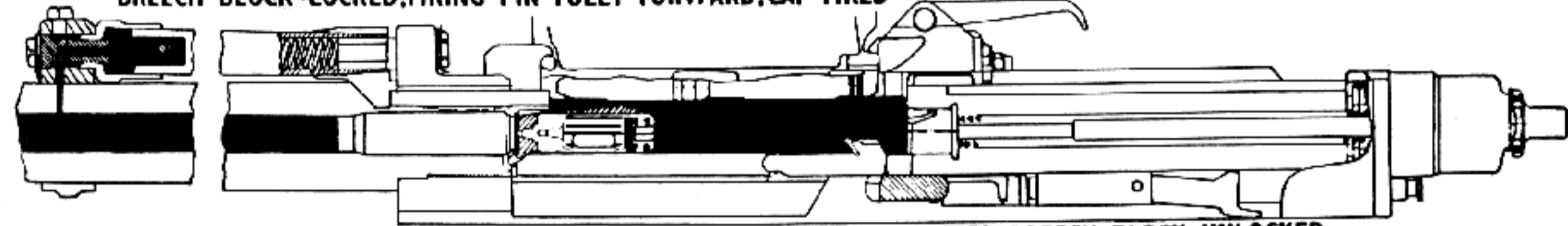

SHELL LEFT GUN, GAS PISTON PUSHES BACK UNLOCKING PLATES, BREECH BLOCK UNLOCKED

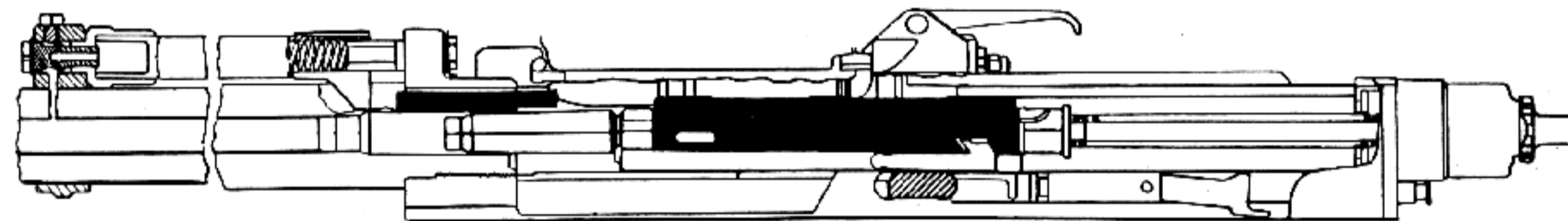

BREECH BLOCK RECOILS, EXTRACTING CARTRIDGE CASE

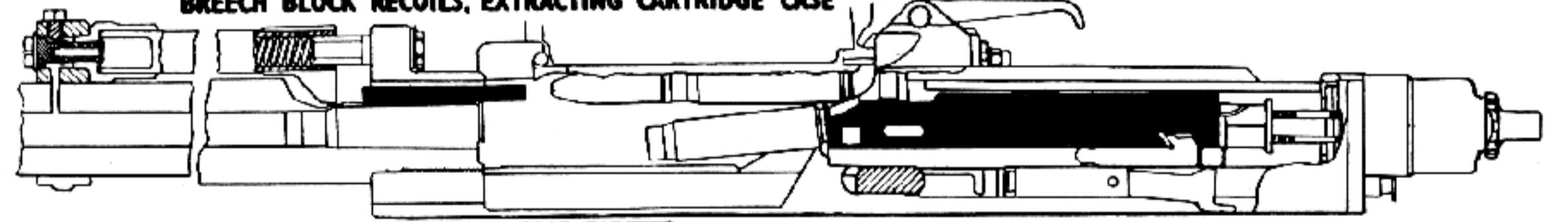

CARTRIDGE CASE EJECTED

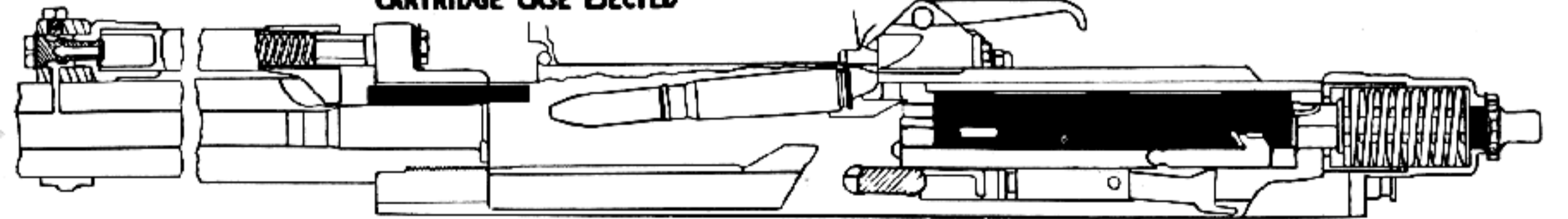

BREECH BLOCK FULLY RECOILED, BUFFER SPRING COMPRESSED



VIEW OF FRONT MOUNTING SPRING  
FREE POSITION

VIEW OF FRONT MOUNTING SPRING  
RECOILED POSITION

Section Views of the Hispano-Suiza Action.

establishment at Martlesham Heath. Three more weapons awaited acceptance tests in March of the same year. In addition, the factory proposed the establishment of a Hispano-Suiza plant in England if given a token order for 400 cannon.

As the latter was exactly what the commission had ultimately hoped to accomplish, a contract was signed immediately. The French concern employed Dennis Kendall, an Englishman, as the managing director. This connection with Kendall, who had a successful background as production engineer with the Citroën motor car firm of France, was very fortunate for both Hispano-Suiza and the British Empire. His selection of a site near Grantham and the buying and arranging of necessary machinery and power tools in a short space of time were feats of no small proportions. The plant was constructed and by late December 1938 on land that had been leased only 6 months earlier, the first English-made Hispano-Suiza automatic cannon Type 404 was ready to be fired. In addition to the factory, a fine testing range had also been completed at the same time.

On 19 January 1939 an official ceremony was held with many important people present, among them the King, the Queen, and the Duke and Duchess of Gloucester. After the usual ceremony that accompanies an affair of such a nature, an inspection of the plant and its facilities was made. At its conclusion, the King personally fired a burst from the first cannon, the prototype of thousands that were to follow.

This newly formed company was given the harmless sounding name of British Manufacture & Research Co. The initials were at once picked up to nickname the gun the British "Mark," under which title it operated from that time on.

Very few official acts of the British showed their desperate need for an adequate aircraft cannon as much as did their dealings with the Hispano-Suiza Co. After witnessing just one firing demonstration in France and proofing a single barrel in England, they committed themselves so far as to contract almost without reservation with the Birkigt firm.

After production got under way at Grantham, the British Navy became interested in the 404 as a possible shipboard fast-firing cannon for anti-aircraft use. The Royal Navy had already con-

ducted tests on everything ranging from .303 caliber to two-pounders. The .303 had been dropped because of lack of range and destructive effect. The two-pounder was ruled out because of the necessity for skilled maintenance and the difficulty in hitting fast targets with a single-barrel model, while a multibarrel version was considered entirely too heavy for practical use.

Twenty millimeters was eventually chosen as best for the purpose, it being the largest dimension suitable for shoulder control and the smallest to offer a worthwhile high-explosive projectile. It offered also possibilities for an exceptionally high rate of fire. The new Hispano-Suiza cannon was tested alongside the Oerlikon and the results were most disappointing as far as the Hispano-Suiza was concerned. The navy reported that, while its use in aircraft might prove satisfactory, it could in no way compare with the Oerlikon for shipboard service.

The English-produced gun was called the Hispano-Suiza Type 404, the model made in France being designated the Hispano-Suiza Birkigt Type 404. The Royal Air Force worked with the Procurement Board to iron out many malfunctions and manufacturing difficulties that naturally arose in putting into production an inadequately tested weapon. The British viewpoint was that war was imminent and the desperate need for armament at the moment made necessary the most rapid development work possible under the circumstances.

One of the first needs was a suitable wing mounting since the weapon in its present state could only be installed in the V block of an engine. The French firm, Société d'Applications des Machines Motrices, developed a recoil cradle that was used first in the Spitfires and Hurricanes. This mounting was always referred to as the S.A.M.M. cradle, from the initials of the firm that manufactured it.

It is a matter of record that, when World War II commenced, the British had a modest number of locally made guns, the reliability of which under simulated combat conditions had not been impressive. In fact, the Hispano weapon was actually developed during the critical days of the Battle of Britain. The report of the first Spitfire pilot to engage the enemy with the can-

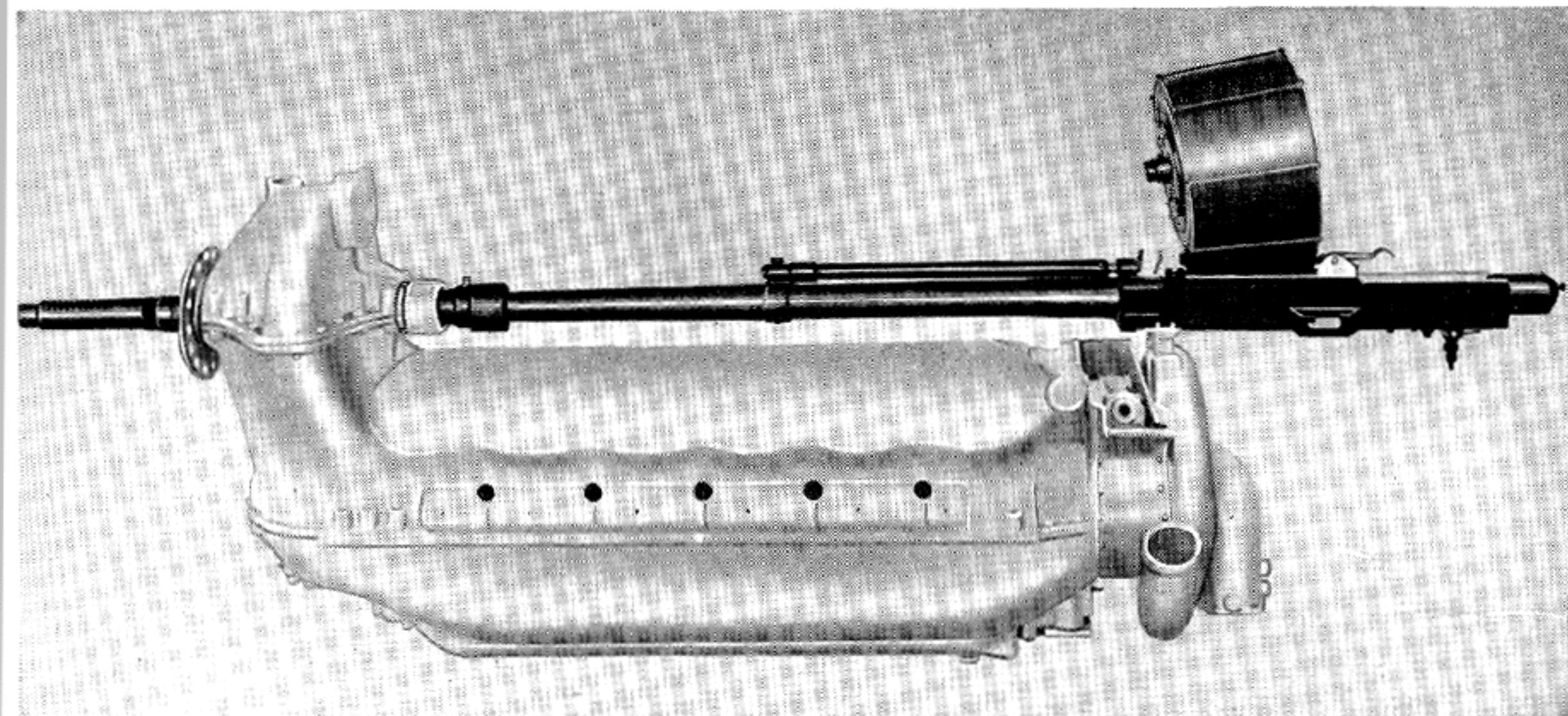

Hispano-Suiza "Birkigt" 20-mm Automatic Aircraft Cannon, Type 404. Mounted on a Hispano-Suiza 12-Cylinder Engine to Fire through the Propeller Hub.

non stated that "upon opening fire against the enemy one gun jammed on the first round, and the recoil of the one remaining wing gun threw the axis of the airplane off line so that the enemy escaped before effective fire could be delivered. The second gun jammed after 30 rounds."

After this rather disheartening start the British, taking advantage of every failure, kept making changes wherever possible by close study and rechecking of design to improve performance. And in less than a year's time they had an aircraft cannon which was never phenomenal in its performance but did have an acceptable degree of reliability.

One of the worst features of the original gun was its feed system. It was an exceptionally large 60-shot drum arrangement that not only carried too small an ammunition supply but was limited in its possibilities of mounting by its cumbersome and bulky design. Well before the contract with the British had been approved by the French Air Ministry, the latter government's air force, also observing faults in the drum arrangement, began work at the manufacturing arsenal at Chatellerault on a feed that would employ a metal disintegrating belt. This design was still under way when the critical British need for it, plus the possibility of German occupation of France before its completion, re-

sulted in the French making all drawings and working models available to the British.

The feed, as received by the English ordnance engineers, needed many improvements before it could be expected to work and they were soon forthcoming. With the smaller profile of the new feed, British planes appeared with Hispano-Suiza cannon mounted in groups of four where heretofore it had been possible to fix no more than two. And while the French did not furnish the Royal Air Force with a workable feeder and much necessary improvement and redesign had to be done, they must be given full credit for the basic idea that was found in the Chatellerault feed upon which all successful systems of a similar nature have been constructed.

The French Air Force, upon delivery of the first Birkigt Type 404 guns of the original 20 that were ordered, mounted them in a single-seater Dewoitine fighter equipped with a Hispano-Suiza motor. The cannon were engine-mounted and fired through the propeller hub. The standard 60-shot drum was also used, since the new Chatellerault feeder had not reached a state of reliability. And while other types of French planes were equipped with the cannon as fast as production allowed, they saw little use because of the German occupation of the country.

### American Negotiations for the Cannon

In 1936 the United States Navy, after coming to the conclusion that a heavier aircraft machine gun than the caliber .50 would be needed to protect the fleet adequately from heavy bomber attack, turned its attention to the procurement of a larger automatic weapon with a caliber of approximately 20 mms, since that bore represented practically the smallest dimension of a projectile with enough bursting charge to inflict appreciable damage and still be large enough to permit fuzing. The Navy instructed its overseas attachés to check all tests being conducted in Europe and to notify the Bureau of Ordnance as to what weapons not only merited consideration but were readily available.

Reports indicate that four different weapons falling into this classification were considered worthy and the purchase of four each was authorized for testing purposes. The weapons in question were the Danish Madsen, the German Rheinmetall-Borsig, and the two Swiss models, Solothurn and Oerlikon. It was also specified that catalogs showing the construction, maintenance, and cycle of operation of each gun be transmitted with each weapon, together with ammunition price lists. With each gun there was to be a minimum of 400 rounds of each type of ammunition per gun, so that after their arrival demonstrations and tests could begin at the various Navy proving grounds. Actually, because of costs and other considerations, tests were carried out only on four 23-mm Madsen guns.

The development of the Birkigt gun was followed closely by both United States Navy and Army attachés in France. On 27 February 1937 the War Department authorized its attaché to "ascertain prices and dates of delivery of one and four Hispano-Suiza aircraft cannon Birkigt design, French manufacture, for both 20 and 23 mm, complete with fixed and flexible mounts, sights and accessories, and 500 rounds of explosive shell." The Department was informed that the 23-mm gun was in experimental status, that only the 20-mm gun could be considered far enough along to warrant interest and that authority to purchase it would be requested of the French Government.

At the same time information was desired on

the progress toward the 25-mm Hotchkiss aircraft cannon. If thought ready for trial, a request for purchase would be initiated. However, the French Bureau de Cessions de Materiel a l'Etranger, on 9 March 1937, informed the American representative that the Hotchkiss gun was still in secret status. Permission was granted to purchase Hispano-Suiza guns and the following message was sent back to Washington:

"Birkigt 23-mm examined . . . but not fully developed. No gun this caliber has left Hispano-Suiza factory. British have purchased nine cannon of similar type except for caliber which was 20-mm Birkigt design for motor mount only. \$3,500 quoted for gun, crank-case mount, magazine and tools. Same unit price for four guns, ammunition with inert projectile, \$2 each, explosive projectiles \$4 each. 45 days Paris delivery."

On 11 March 1937 the Army's technical expert in Europe sent a description of the complete breakdown of the Hispano-Suiza Birkigt Type 404 automatic gun, together with the manufacturer's specifications translated from French to English. The comments made by this authority are of unusual interest today, particularly the following quotation:

"The gun has been characterized by the undersigned as gas operated and locked breech. Sufficient gas is tapped off from the barrel to unlock the breech. Thereafter blow back comes into operation. It is interesting to note that this is the principle advocated by Alfredo Scotti, an Italian inventor of automatic weapons. Particular attention is invited to the use of lubricated cartridges which is said to be necessary for the functioning of the gun."

The writer also declared that he had seen a 23-mm gun differing from the 20-mm only in bore dimensions. When Prince Poniatowski was questioned whether this model had been sold to the Russians, he stated that "no 23-mm Hispano-Suiza gun has left the factory to this time." In addition to the 23-mm aircraft gun, a second and similar version was observed. It had a shorter barrel and employed a somewhat different system of mounting.

The American Ordnance Department, after considering the unusual interest that the British had shown in the gun from the very first and



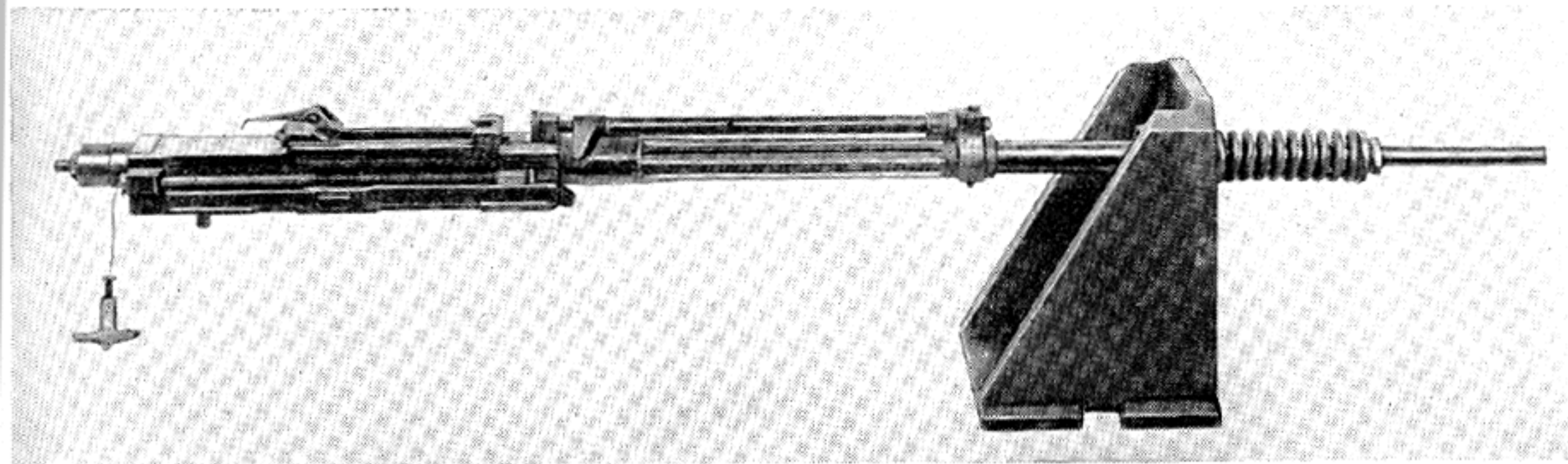

Hispano-Suiza 20/60 Automatic Aircraft Cannon. Experimental Model Manufactured by the British M.A.R. Company.

the fact that they were doing more to develop the weapon than were the French, ordered its representatives abroad to watch very keenly production and refinement activities on the weapon. Since events were taking shape that might make the two countries allies at any moment, any information requested by our attachés was freely passed on.

On 27 July 1937 a procurement authority was sent to the Hispano-Suiza officials, signed by the Assistant Secretary of War, carrying an allotment of \$8,000 for the purchase of one gun, 1,250 rounds of ammunition with inert projectiles, 600 with tracer elements and 150 with high explosive, together with a tool kit, a magazine and engine mount. Immediate delivery, if possible, was requested, but in any event the date must be no later than 11 November 1937.

This limit for fabrication and assembly was accepted by the French firm but it was not until 15 December of the same year that the material was presented for inspection. The delay was due in part to French nationalization of the Hispano factory under the laws passed in 1936. Although the factory was taken over by the government, the company maintained an office across the street which remained in private hands. After a visual check it was agreed to give the gun a 50-round function test before sending it to America. This took place on 22 December 1936, 10 rounds first being fired for accuracy, then 20 in short bursts, and over 20 in one continuous burst. The results were considered satisfactory and the manufacturer was asked to ship in accordance with instructions.

The Hispano-Suiza Co., upon beginning the

manufacture of Birkigt automatic cannon, started numbering them above 1,000, so as not to confuse them with its Oerlikon serial numbers. The cannon sent to this country had a series number of 1027; in other words, it was the twenty-seventh gun made by the company. The number also indicated delivery of the 20 guns which the French had demanded before any outside order was to be filled and of the original British order for six.

On 17 February 1938, aboard the U. S. S. *President Roosevelt*, the gun and its ammunition (except for 1,000 rounds with inert projectile) left Le Havre, France, arriving in New York on the twenty-sixth of the month. The remainder of the ammunition was sent on 1 March on the U. S. S. *Independence*, reaching port on the fourteenth. The whole shipment was sent to Aberdeen Proving Grounds, Md., for its first official American test.

Although the sample gun reached the United States in February 1938, Hispano-Suiza officials did not file for an American patent until 16 April of that year. When this was done, it showed alleged improvements over the first patent granted in Belgium 16 September 1935. One of the principal changes was the addition of ears to the breech lock that, when engaged with their mating notches in the slide, lifted the lock out of its recess. The original breech lock had no ears, the angle being such that it would unlock automatically as soon as the slide uncovered it.

The British made available to the United States at this time the results of a test showing the failure of an attempt to fire the weapon without lubricating the ammunition. They called at-

attention to the Hispano-Suiza manual, which stated that the first step in preparing the gun for action was to grease each cartridge before placement in the magazine. As this would present endless difficulties for aircraft use, the United States was requested to seek a solution to this problem. The British Air Ministry was prepared to exchange reports on it or any other similar subject.

On 9 March 1938 the Chief of the Bureau of Ordnance, U. S. Navy, addressed a memorandum to the Army's Chief of Ordnance, stating that the Navy would be willing to allot funds for experimental and development work on aircraft cannon, provided that the weapon decided upon met certain requirements. It was considered highly important that aircraft cannon, when adopted for Naval use, be manufactured in this country either from designs originating here or acquired from abroad. Based on reports from tests conducted in Europe of both the Hispano-Suiza and Oerlikon guns, either would be acceptable to the Navy if these requirements were met.

On 21 June 1938 the first official test of the Hispano-Suiza cannon, serial number 1027, began at the Army's proving ground at Aberdeen, Md., and continued until 5 August. The object was to observe the functioning of the weapon and ammunition. The report noted that lubrication of the ammunition was not necessary since the cases were provided with a coating of heavy wax. During the trials, which were little more than demonstrations before high ranking officials, only 81 rounds were expended in the whole period.

In the testing of this gun, 2,511 rounds of ammunition were fired from 21 June 1938 to 9 April 1940. In his report, the range officer ventured the opinion that the Hispano-Suiza cannon under test "was reliable in functioning, safe for use, and as an aircraft weapon merited serious consideration." A later report had the following remarks: "Endurance appears satisfactory but further firing is necessary to establish this. Lubrication of the cartridges is necessary. The extractor spring is not adequate to withstand continued firing. The lock may crack from continued firing." It was recommended that a more severe trial be run to prove these doubtful features.

The Navy followed the trials at Aberdeen very closely. A report from the Armament Section of the Bureau of Aeronautics to its Engineering Division on 15 March 1939, was made in order to bring that unit up to date on past cannon procurement and to prepare it for what to expect in the future. It is quoted at length, as it graphically describes the state of affairs at this time.

" . . . Although considerable preliminary investigation and discussion had occurred, it was not until about September 1935 that this bureau first acquired an aircraft cannon, which was a 20-mm Oerlikon, Type 9, gun to be used with Hispano-Suiza 12 YCRC engine. The engine and gun were tested by the Navy and, subsequently, turned over to the Army. The gun is still in Army custody but the engine has been returned to the Naval Aircraft Factory.

"The next procurement involved purchase of three 20-mm Oerlikon guns, one flexible Type L, and two wing guns Type FF. The flexible gun is now in custody of the Glenn L. Martin Co.; one wing gun is in custody of the Army and the other wing gun is at the Naval Air Station, Anacostia.

"In November 1936 the Army Development Program Sub-Committee met at Wright Field for the purpose of formulating a policy with regard to aircraft cannon development and procurement. While a Bureau of Aeronautics representative attended this conference, this bureau was not committed to the conclusions reached by the sub-committee. . . .

"In February 1937 a Joint Bureau of Aeronautics and Bureau of Ordnance Board met for the purpose of formulating a recommended armament program for naval aircraft. . . . For such uses as might be prescribed, guns of 20-23-mm were considered most satisfactory for Naval use.

"Pursuant to the foregoing this bureau recommended, 11 June 1937, procurement of seven aircraft cannon: three 20-mm Oerlikon, two 23-mm Madsen and two 20-mm Rheinmetall-Borsig. Because of cost and other considerations, the Bureau of Ordnance did not procure the above guns but, instead, purchased four 23-mm Madsens which have been delivered and are now at the Proving Ground awaiting test.

"In accordance with recommendation of the

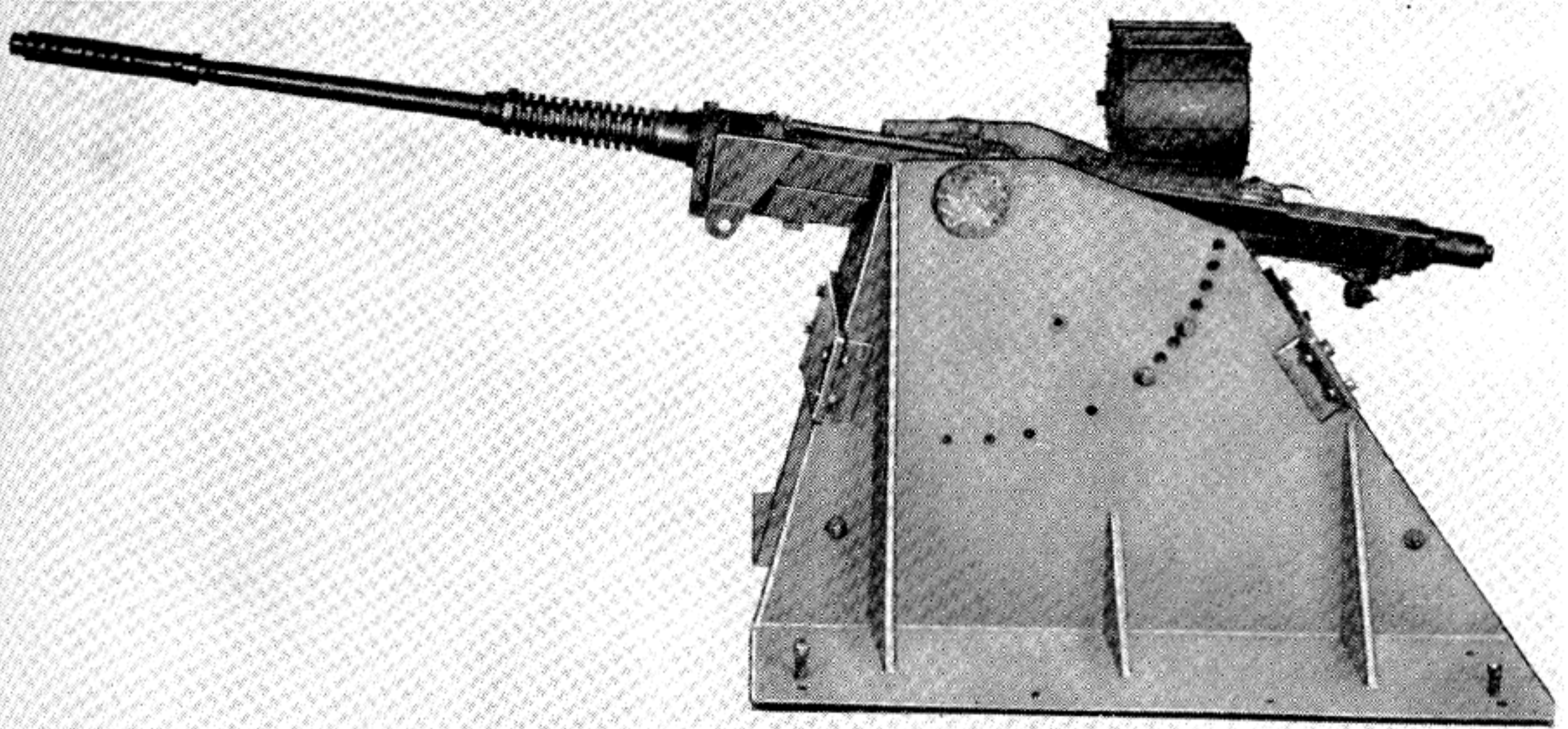

Hispano-Suiza 30-mm Automatic Aircraft Cannon. This is an Experimental Model Manufactured in France.

Aeronautical Board that cognizance of the development of aircraft cannon be not assigned to either service to the exclusion of the other (recommendation approved by the Secretaries of War and Navy) and the stated willingness of the War Department to undertake any work in connection with aircraft cannon desired by the Navy, the Bureau of Ordnance transmitted, on 9 March 1938, to the Ordnance Department the characteristics considered necessary in a gun for Naval use. Information was requested as to whether any guns under development by the Ordnance Department met the above characteristics and, if not, whether the Ordnance Department would be willing to initiate such development during the fiscal year 1939.

"On 13 April 1938, the Bureau of Ordnance informed the Ordnance Department that it was interested in the Army automatic guns T1 (.9") and T2 and T3 (.9") guns and that it was proposed to make available to the Chief of the Ordnance Department about 1 July 1938 \$40,000 for the purpose of accelerating the development of the above listed guns.

"On 20 July 1938, this bureau requested, after conferences and understandings reached by representatives of the two bureaus, that the Bureau of Ordnance procure 20 23-mm Madsen guns and ammunition for installation in Model F2A-1

airplanes. The Bureau of Ordnance stated, in a letter dated 15 October 1938 that, as a matter of policy, it did not wish to equip any Navy planes with cannon of foreign manufacture. Accordingly, procurement of additional Madsen guns was not contemplated. At this time, however, the Ordnance Department was again requested to make available whatever information might be available concerning the Army T2-T3 guns then under development.

"Based upon disappointing developments to date, as well as further investigation and conversations with representatives of the Air Corps and Ordnance Department, this bureau and the Bureau of Ordnance have concluded that it is extremely doubtful that we are likely to be supplied with aircraft cannon of Army design or procurement within a reasonable number of years. Army Ordnance representatives are inclined to the same belief and, accordingly, no provision whatever is being made for installation of guns other than those now available, such as the 37-mm gun.

"Since it is not only desirable but essential that this bureau proceed at once with service tests of aircraft cannons firing explosive projectiles, representatives of this bureau and of the Bureau of Ordnance have concluded that the only possible manner in which such guns may

be acquired is by purchase of manufacturing rights by an American firm of a suitable foreign gun. The gun which appears to offer the most promise in this respect is the Hispano-Suiza (Birkigt) gun and accordingly negotiations to this end have been under way for some time with the Bendix Corp. Based upon possible procurement by the Navy and, possibly, Army, the Bendix Corp. has stated a willingness to proceed with negotiations toward acquirement of manufacturing rights, with possible delivery of these guns within one year.

"While the foregoing does not indicate a very satisfactory past, the future appears reasonably bright, since it now appears that we shall acquire the best known aircraft cannon within a period of approximately one year. In anticipation of future acquirement, this bureau is making provision for possible future installation of cannon in all applicable types, such as VF, VSB and VPB."

The Bendix Aviation Corp. was the only adequately equipped American factory that showed any interest in negotiating for a license to manufacture the Hispano-Suiza weapon. Through Army channels, the Bureau of Ordnance placed an order with Bendix for the manufacture of 20 guns. A memorandum from a very prominent Navy official perhaps stated the Navy's attitude about the whole business of cannon procurement when he said: "We have waited so long with so little results that I recommend strongly any cannon at any price in order to get some tangible results. I note with regret that even at this late date (3 June 1939) the proposal is to merely purchase a limited quantity for service test."

Bendix had made numerous attempts to procure American production rights even before the sample gun was delivered and as a result of the earlier inquiry, Hispano quoted a figure to take under consideration. The price stipulated was to be \$80,000 for manufacturing rights plus a royalty of \$400 a gun, provided a minimum of a hundred guns a year were produced. By this time Bendix felt justified in taking on a contract of such proportions and communicated its willingness to enter into the agreement.

Hispano, however, changed the terms to \$500,000 plus 10 percent royalty per gun, besides a 5

percent royalty on all ammunition produced. Again Bendix attempted to take steps to close the deal for the manufacturing privileges and before it could be consummated, the price was again increased to \$2,000,000.

This exorbitant demand forced Bendix to drop all further effort to obtain license, especially for an indeterminate number of experimental guns. It later turned out that the actual number to be given on the initial order was to be 33, of which 20 were to go to the Navy and 13 to the Army.

### Production of Hispano-Suiza Cannon by the United States

After months of negotiating through the State Department and military attachés, a contract was finally signed on 14 December 1939 and its terms officially approved by the Secretary of War on the eighteenth of December. The agreement was between the United States Government and the Suisse-Brevets-Aero-Mecaniques of Geneva, Switzerland, representing the Société Francaise Hispano-Suiza. The contract called for 33 Hispano (Birkigt) Type 404 Aircraft Guns and the Ordnance Department agreed to pay \$115,170, or \$3,490 per gun, plus \$141,830 for 59,500 cartridges, which was at a rate of \$2.38 each. In addition, the contract permitted the Ordnance Department to purchase all manufacturing rights within a year for \$425,000, plus a royalty of \$100 for each gun made.

At the time the contract was signed with the French company, our military attachés informed the Government that there were then four distinct models of the gun, as follows: The Types 404 caliber 20-mm, barrel length 1,600 mm, for motor mounting only; the 405 caliber 20-mm, barrel length 1,000 mm, designed to be mounted in turrets; the 406 caliber 23-mm, barrel length 1,150 mm, for turret installations; and the 407 caliber 23-mm, barrel length 1,600 mm, for engine mounting.

The Type 404 was considered the best for the purpose intended and interest in the other types was slight. Although the date of delivery for the first ten of the 33 guns ordered was scheduled for 28 February 1940, they were shipped ahead of time, arriving at Aberdeen Proving

Ground, Md., on 20 February, followed closely by the remainder which reached Aberdeen with 9,200 rounds of ammunition on 11 April.

Tests were started immediately and certain weaknesses were noted. Information was requested both from the French plant and the English firing ranges in order to remedy the various malfunctions.

The first six guns to be proof fired at Aberdeen were turned over to the Navy for testing at the Proving Ground at Dahlgren, Va. The rest, as soon as enough rounds were fired to prove any degree of reliability, were sent to various manufacturers of Navy aircraft for installation in experimental airplanes then under design.

On 11 April 1940 the Navy, through its Bureau of Ordnance, offered to stand half the cost with the Army in obtaining the Hispano-Suiza manufacturing license. On 12 April 1940 Gen. H. H. Arnold, Chief of the Army Air Forces, wrote to the Chief of Ordnance, U. S. Army, suggesting that immediate steps be taken to purchase production rights to the Hispano-Suiza gun on as large a scale as needed, and that an immediate order of 400 more guns from the French company be placed even before taking up the option. He also pointed out the desirability of standardizing the weapon as soon as possible. Quick action followed this suggestion and on 29 April 1940 the Chief of Ordnance recommended the immediate official adoption of the 20-mm Hispano-Suiza cannon.

Since receipt of manufacturing drawings of the gun from France would be delayed until the option had been officially taken up, Watervliet Arsenal, at Watervliet, N. Y., was ordered to prepare a set of drawings from a cannon sent there for study from the Army Proving Ground. As such blueprints were not considered suitable for contractors unfamiliar with the procedure necessary for mass production, all prospective bidders were informed that mechanical drawings would not be made available to them until they sent competent representatives to Watervliet. There they would study not only the gun's mechanism but likewise the accepted methods used for its manufacture. This was done to prevent or at least deter unqualified companies from bidding on the contract.

As a starter it was estimated that Air Force needs would be 456 for the fiscal year of 1941, while the Navy would require 100; therefore, 600 guns were planned for production to insure a surplus. However, when bids were sent out to a selected few firms on 10 July 1940, the requirements had been raised to 1,202 guns. Only three companies bid on producing the weapon. The Mergenthaler Linotype Co. was high with a price of \$2,875.28 for each gun produced; the National Pneumatic Co. was next with \$2,485.69; and the Bendix Aviation Corporation, Eclipse Division, was low with \$1,120.00 per gun.

Maj. Gen. C. M. Wesson, Chief of Army Ordnance, requested and received authority to reject all other bids and negotiate a contract with the Bendix Aviation Corp. for the amount of their offer. Bendix had a great advantage in bidding as its earlier and unsuccessful attempts to negotiate a license with the parent firm gave it insight not only on what would be necessary to meet the requirements of manufacture but also what the cost per unit would be.

This favorable position, brought about by earlier negotiations, made it possible for the firm to offer a reasonable bid from the start. On 23 September 1940 the contract was approved. It not only provided for the manufacture of immediate requirements but also permitted the Army to order up to a total of 5,000 at the stipulated price. This act, where a major power officially adopted a weapon of foreign origin and ordered its manufacture before obtaining a license from its owners, was perhaps without parallel in ordnance history.

Even after French drawings were available, those based on the one gun at Watervliet saved so much time over converting the French metric measurements to English units, that it was decided to start manufacture as originally planned, using the Watervliet prints. One of the original features that was overlooked in this procedure was the use of a braided wire driving spring.

The contract was signed on 6 November 1940 between the United States Government and the Brevets-Aero-Mecaniques S. A., of Geneva, Switzerland, whereby the United States would pay \$425,000 for the drawings and engineering data and \$35 for each gun, plus \$40 royalties. "In other words, for each receiver made which

by agreement of both parties would constitute a gun (all other components not counting), the United States agreed to pay the sum of \$75 to represent royalty or manufacturing know-how."

The Eclipse Machine Division of Bendix Aviation Corp. started tooling for production and of 1,202 on order 500 were for the Navy. All of this lot were the Type M1, as the American-made weapon was initially called, with delivery scheduled for May 1941.

Before the first cannon came off the assembly line, Army Ordnance ordered all procurement following the original contract be given the designation of M2. Subsequently this model was identified officially as "Gun, Automatic, 20-mm, AN-M2 (Aircraft)." The latter type would have a heavier receiver with slightly greater external dimensions. The M2 would weigh 112 pounds, as compared with 105 pounds for the M1, and the point of balance would be 1.07 inches further forward. The weight difference was in the heavier constructed receiver. The reason for this receiver was that the gun was originally designed for engine mounting which did not require as much support as wing installations.

Another small difference was in the method of attaching the buffer system to the receiver body.

Bendix began shipping guns late in 1941 and later contracts placed with the company necessitated a monthly production rate of 1,300 guns, which was attained in December 1942. Manufacture continued at this rate until August 1943, when a reduction in the Army Supply Program caused a cut to 1,000 guns per month. In this month, Bendix requested its release as a facility by the end of the year so that an Air Forces item might be manufactured in its Elmira plant. The last 20-mm guns were completed at this plant in December 1943, a total of 22,642 having been manufactured.

The average unit price of the first guns manufactured at Bendix was \$1,010 each, while the final price charged was \$458 for the basic 20-mm gun with all components.

Since a new model had been authorized before the 500 guns ordered by the Navy were delivered, the Bureau of Aeronautics asked the War Department to supply only the M2, disregarding the original order. The result was that the Navy had delivered to it only 14 M1 guns. Six of them had been sent earlier to the Brewster Aeronautical Corp., Long Island City, for installation purposes in the F2A-3 airplanes. These represented the only M1 guns actually installed in Navy planes. The other eight remained in

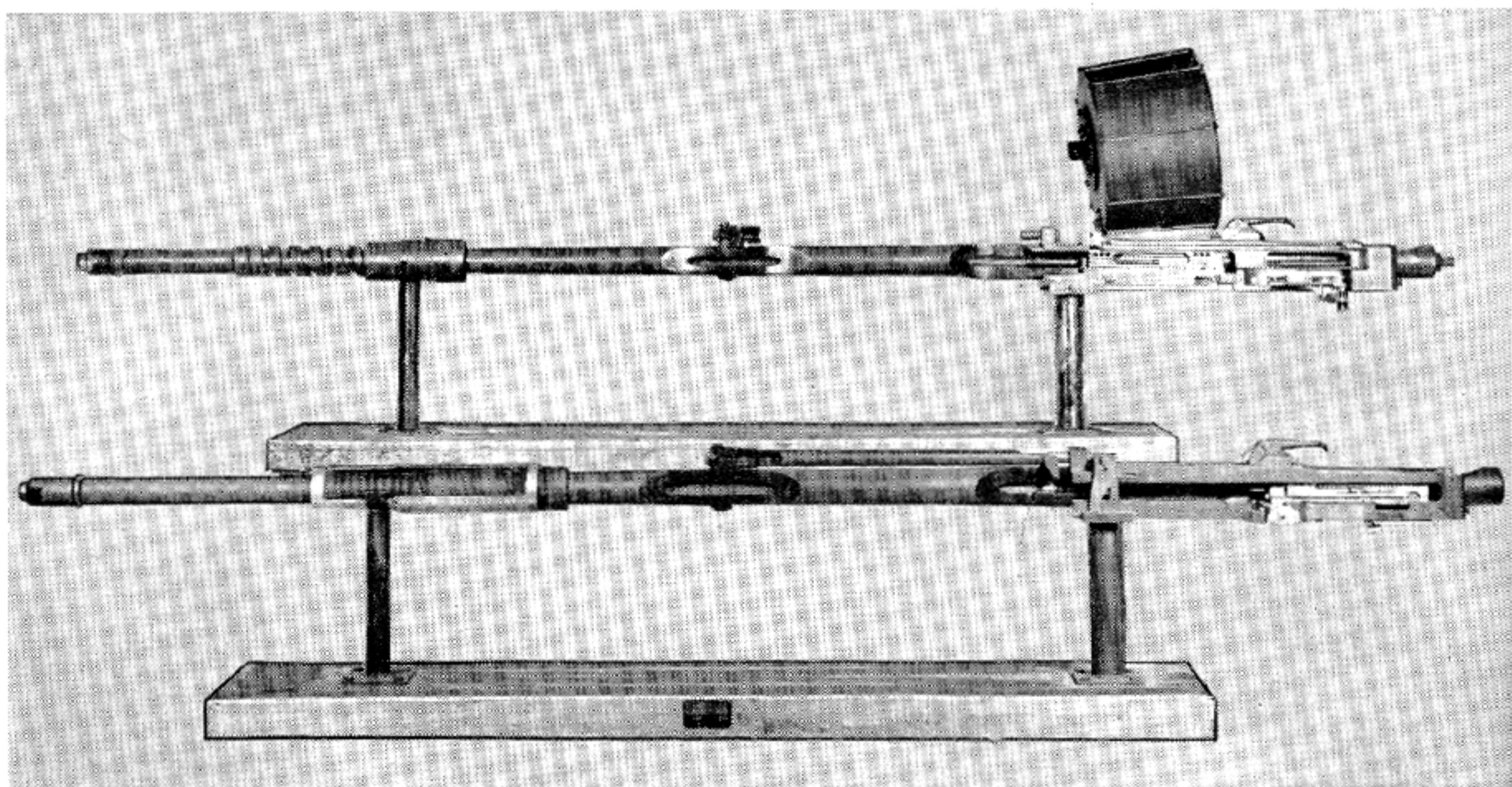

Hispano-Suiza 20-mm Automatic Aircraft Cannon. Top: U.S. M2. Bottom: U.S. M1.

storage in custody of the Inspector of Naval Aircraft at Long Island City, N. Y., until they were turned in as not being acceptable for installation.

The increasing Army Supply Program during 1940 and early 1941 resulted in an over-all requirement of 44,747 20-mm guns. This staggering number made it obvious that other facilities than the Bendix subsidiary commence production. On 17 April 1941 a contract was awarded to the Oldsmobile Division, General Motors Corp., Lansing, Mich., for 9,000 guns. Oldsmobile delivered its first gun during November (the serial number of the weapon was 24,490) and by 1 January 1942 the company had produced a total of 1,056 cannon.

As additional demands were placed on the Army Supply Program, both orders and production increased until 4,000 guns a month were being delivered. This rate was held constant from November 1942 to September 1943 when, in order to keep a well-organized plant in operation as the demand slackened, Oldsmobile's quota was placed at 1,000 a month from that date to February 1944. Production then ceased entirely after Oldsmobile had turned out a total of 77,010 AN-M2 20-mm automatic cannon. When this firm first contracted to make the gun, the price was \$910 each and this amount was gradually reduced until the last ones manufactured were delivered at \$510 for each complete unit.

The International Harvester Co. of St. Paul, Minn., the next largest producer of the gun, was awarded a contract for an identical number of guns at the same time. However, its first gun was produced in January 1942 and it did not attain a capacity of 1,500 guns a month until May 1942. Upon receipt of additional contracts, an average monthly rate of 1,300 guns was held until September 1943 when the Army cut back on orders due to an excessive supply. Thereafter 1000 a month were manufactured until all work ended in December 1943. In all, this company delivered 24,526 cannon. The first were contracted for at \$840 each and this figure was steadily lowered until the last ones were delivered for \$465 each.

When the Army decided in 1944 to keep one of the major companies as a pilot-line operator, International Harvester was considered. How-

ever, it was not chosen because Oldsmobile had been tooled to manufacture at a high rate if the demand suddenly warranted it.

The other company awarded a manufacturing contract was International Business Machines Corp. of Poughkeepsie, N. Y. Only one agreement was entered into with this concern, which was in November 1941 for a total of 10,500 guns. The first complete unit came off the assembly line in March 1942 and an average of 1,000 a month was being turned out by May. This figure was held consistently until the contract ended in February 1943. By November 1942, it was found that production requirements for 20-mm aircraft cannon could be maintained by the three larger companies and it was considered advisable that one facility be dropped. Since IBM was the last in the field to enter and had been producing at a lower rate, it was considered logical to eliminate it first. After the 10,500 guns were satisfactorily completed, however, the action was delayed until the company had been given other war material work to compensate for the loss of the cannon order.

When the first complete IBM gun was turned over to Army inspectors, the price was \$905 for the basic gun. This cost was reduced as efficiency increased until the last 3,000 were sold to the Government at \$565 each.

### Modifications and Attempts at Standardization

By the time production really began with all companies, the United States Navy was the only branch of the service actually placing Hispano-Suiza cannon in planes in great numbers and demanding that aircraft designs of the future include 20-mm in lieu of lighter machine gun armament. Unfortunately, the gun, which was being delivered in prodigious numbers, was not proving itself totally reliable in America.

On the other hand, promising reports were coming in daily from the British, who had used practically the same procedure as our Army ordnance engineers in getting the gun into production status. The original Birkigt Type 404 gun was used as the model for the Mark I. This was followed shortly by the Mark II. Drawings and a sample of this improved cannon arrived in the

United States for purposes of study and test in January 1942. The British strongly suggested that American ordnance officials confer with their representatives in order to accomplish an early standardization. It was further desired that all 20-mm aircraft cannon of this design procured for British use be of the Mark II type, the principal differences between the Mark II and the American M1 being pointed out as follows:

"1. The magazine carrier of the Mark II gun had a different latch; the ejector was provided with a buffer, and changes had been made in the magazine holding boss.

"2. A heavier rear buffer was provided in the Mark II gun and the back plate was dovetailed into the receiver instead of being fitted with a simple groove as in the M1 gun. Inertia blocks were used in the breechblock slides of the Mark II gun.

"3. The sear of the Mark II gun had been modified.

"4. Triple wire driving spring and extractor springs were used in the Mark II gun instead of simple single-strand coil springs which were used in the M1 gun.

"5. Minor changes had been made in the muzzle brake of the Mark II gun.

"6. The receiver of the Mark II gun was substantially different from the one used in the M1 gun; much heavier guide rails were used and the receiver itself was larger, heavier, and designed in accordance with British manufacturing methods.

"7. The chamber of the Mark II gun was 2 mm shallower than the chamber of the M1 gun."

Practically all the changes suggested were of a minor nature and slight modifications or alterations would permit complete standardization. The main difference in the two types of gun was in the chamber dimensions. Since both were designed to use the same cartridge, it was quite obvious that one size would best handle the round. The British were very insistent that their measurements were better, pointing out, in particular, that their chamber was slightly more than one-sixteenth inch shorter than the American one. In their opinion, such a length would solve the problem of faint strikes, since the weapon was inertia fired and depended upon the

shoulder of the chamber to offer resistance and position the cartridge.

Tests were conducted at Aberdeen, Eglin Field, Wright Field, and Kenvil Proving Grounds to determine the relative merits of the British suggestions. The Army Ordnance engineers were not convinced by these tests that the British chamber was superior to the American design. However, it was agreed on 4 April 1942 that additional trials be initiated for the purpose of reaching a satisfactory compromise for both governments.

The only official action finally taken by the American representatives and approved by the Ordnance Committee was:

"(1) That the manufacture of the American 20-automatic gun M1 and AN-M2 be continued in the United States without modification to the chamber.

"(2) That no chamber with the small cone moved one-sixteenth inch to the rear (as was done in the British chamber) be considered for manufacture in the United States.

"(3) That the request made by British representatives that 20-mm automatic guns produced in the United States for British use be made with British chambers not be considered until after the 20-mm automatic guns M1 and M2 have been subjected to a thorough test in Great Britain."

After further comparative tests in late April 1942, it was again definitely decided by the Ordnance Department that all American-made 20-mm automatic guns continue to be made with the chambers longer by one-sixteenth inch than the British regardless of the employment of the same ammunition. This decision was final as far as American production was concerned, but in no way did it change the British representative's view on the longer chamber's performance.

Oddly enough, the question was again raised, not by the English or our many proving grounds, but by manufacturers of 20-mm ammunition. In testing their cartridges for reliability of action, they encountered a series of malfunctions known as light-struck primers that were all out of proportion for such a weapon. These were not isolated cases, the reports coming in from practically every maker of 20-mm ammunition that was engaged in function firing his products.



Since the munitions companies pointed out that the faint strikes were due to lack of impact on the primer resulting from error in the gun, and not as a result of defective materials or workmanship, it was decided to conduct another test on an extensive scale at Aberdeen. Ninety of the 20-mm guns, M1 and AN-M2, selected from every facility producing them, were expended in this test with all types of ammunition, both from accepted and rejected lots.

A complete record was made of every malfunction during the entire test and the probable causes of the trouble. The engineers in charge of the project in the early stages of this test recommended that two modifications should be made to overcome the serious malfunctions:

"(1) Shorten the chamber one-sixteenth inch, thus modifying it to approximately the British chamber.

"(2) Replace the extractor spring with a solid plug, thus positioning the rounds by means of the extractor. This change would include such modifications to the extractor, the bolt, and the ejector, as were deemed necessary."

The test began in June 1942 and continued until the last of January 1943. The final recommendations from Aberdeen Proving Ground were presented at a meeting attended by representatives of the Ammunition Branch, Industrial Division, Artillery Branch, Technical Division, and Field Service. All present accepted as official four much-needed modifications that were to be made on all 20-mm M1 and AN-M2 cannon: (1) The chambers were to be shortened one millimeter or approximately one thirty-second inch; (2) the extractor spring would be of the cantilever type; (3) the standard firing pin was to have one sixteenth inch removed from the back of the key slot to give it "float"; and (4) the breechblock slide springs would be strengthened.

This sanctioned change found the Army with 40,000,000 rounds of ammunition already stocked. While 56,410 guns had been manufactured to date, it would be easy to make external changes such as with the firing pin and extractor spring. Barrel chamber shortening, however, was a problem that generally cost as much in time and money as to make the whole barrel, to say nothing of the number of guns immobilized

while the modification process was being performed.

Action was taken immediately by the Industrial Division to put the alterations into effect. There still remained certain differences between the British Mark II and the AN-M2. As the British Ministry of Aircraft Production had long advocated having both guns manufactured identically, the Army Ordnance Department ordered a comprehensive test in England as soon as the modified weapons came off the assembly line.

At the suggestion of Capt. E. R. S. Adams of the British Air Mission, two guns each from International Harvester, Oldsmobile, and Bendix were shipped to England for the purpose of competitive aerial tests with the Mark II. Representatives of the Army Ordnance Department were present to observe the 2,000-round tests which were held during July and August 1943.

Two British Mark II's were mounted in the left wing of a Hurricane fighter with two AN-M2's made by Oldsmobile and International Harvester in the right wing. Combat flying, dives, G-loading, straight-away, etc., were simulated. One stoppage was attributed to the Oldsmobile gun. The International Harvester weapon had no stoppages but a cracked breechblock was noticed at the completion of the trial. Each Mark II had one sear failure and one of them had a cracked breech lock after 1,400 rounds. The Bendix guns were fired on the ground in competition with the British-made guns and made a creditable showing.

In reporting the findings of the test, Mr. Hansen, of the British Ministry of Aircraft Production, declared: "American guns are as good as British guns and are acceptable for service use."

### Mount, Feed, and Other Modifications

From the arrival of the first Hispano-Suiza cannon in this country, the problem of mounting was present, as the weapon was originally designed to fire only through the propeller hub. This was considered satisfactory at the time; later, the British and our Ordnance Department obtained a method of cradle mounting from the French. The authorities, however, soon realized that dependence upon this one system of mounting would greatly restrict the gun's usefulness.

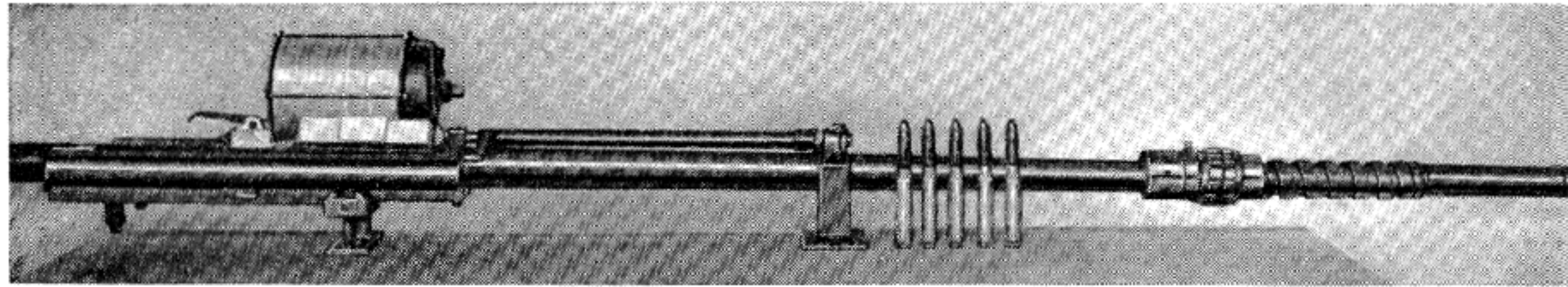

Hispano-Suiza Automatic Aircraft Cannon AN-M2 with Feed Mechanism, 20-mm AN-M1. Developed from the French Chatellerault Feeder.

Later in 1940 the Edgewater Steel Co., Oakmont, Pa., agreed to develop a type of ring-spring mounting in an effort to reduce the unusually high recoil forces always present with automatic cannon. Tests were first conducted on the prototypes, the T6 and T6M1, from January to March 1941 and they were found too heavy. On 20 April 1942, the T6E1 was successfully tested and officially adopted by the Navy. It was given the designation, "Adapter, Gun, 20-mm, M1." Later it was named "Adapter, Gun, 20-mm, M6" when a rear mounting extension was used. A total of 70,011 M1's and M6's were manufactured by the Edgewater Steel Co.

In May 1942 after the Edgewater adapter had proved superior, a limited number of guns was produced with the M7 adapter, which, despite its higher number, was merely a refinement of the original French mount. Only guns produced for the British were equipped with this adapter, and Oldsmobile, after making 9,697, began replacing it with the Edgewater adapter.

The first Hispano-Suiza Type 404 gun received in this country carried a large 60-cartridge drum feed. Ammunition was placed in the feed by hand after first greasing each round. The spring on the drum had a preload of approximately 14 torque pounds to insure positioning the last round, each cartridge being placed with the full tension thrust absorbed by slowly winding the spring.

This type of feed was accepted as a standard component of the gun until 1941. In England, other methods of getting ammunition to the gun were being experimented with that should soon make the use of this cumbersome feed system unnecessary. But until this became a reality, our use of the drum continued and it was given the nomenclature, "Magazine, 60-round, 20-mm, M1."

The feed, for some unknown reason, was manufactured as late as 1944 with little or no change. At this time it was improved and the designation changed to "Magazine, 60-round, 20-mm, M1A1." Its characteristics were: weight, empty, 22 pounds; diameter, 12 inches; length, 8 inches; and maximum height, when mounted on gun, 18 $\frac{3}{4}$  inches. The last feature practically ruled it out for wing installation, because of its excessive overall height and small ammunition content. For this reason the records show only a very limited amount were procured for use by the British. And the Army Air Force was considering a single experimental plane mounting only one gun firing through the nose that could have employed this antiquated feed. Yet a total of 29,235 magazines of this type were procured, 6,200 from the Borg-Warner Corp. and 23,035 from the Seng Co., both of Chicago.

While the drum feed was being steadily produced, the devisement of a means of feeding the gun was being studied that would allow better profile while delivering a greater supply of cartridges. The most successful method heretofore used on other guns was the disintegrating metal link belt and investigation of its possibilities was authorized in May 1941. During subsequent experimentation many different systems of feeding were tried. Only three gave promise of warranting further effort: (1) the disintegrating belt and feed system devised by Watervliet Arsenal; (2) a similar method of feeding developed by Curtiss-Wright Aircraft Corp. under an Air Force contract; and (3) the Chatellerault feed mechanism initiated by the French and later turned over to the British, who made considerable improvements in it.

Tests were conducted at Aberdeen of all three mechanisms and it was reported that the Chatellerault, then designated the T1E1 (the latest type

that had been received from England), gave far more satisfactory performance than the other two. It was also stated that the Chatellerault was light in weight, very compact in construction, and capable of pulling a large belt of ammunition successfully. The latest model tested was declared a definite improvement over the earlier T1, as the original Chatellerault feed was marked.

The most serious difficulty found with the basic design of this system was that, to delink the cartridge, a cam was used on the nose of the projectile to push the round out of the belt. This principle made it necessary for all cartridges to have the same physical dimensions, which placed a very serious limitation on the feed, Armor-piercing shells were, by their very nature, constructed different from high-explosive and ball ammunition.

In spite of these shortcomings development proceeded. In order to have an adequate feed system at the earliest possible moment, the experimental "Mechanism, Feed, 20-mm, T1E1" was standardized and officially named "Mechanism, Feed, 20-mm, AN-M1."

The Chatellerault, as it was more commonly called when standardized, included a spring band, shaft, and sprocket assembly that acted as a clutch to allow slipping. This prevented overwinding and acted also as a safeguard against breakage in case of a seizure of the ammunition belt.

In the feed tested at Aberdeen the clutch band was fixed by welding which, if successful, eliminated not only many problems of manufacture, but gave extra strength to the vital part. The test indicated that it was feasible and Aberdeen recommended that all clutch mechanisms already manufactured be attached by welding.

While the Chatellerault feed did divorce the gun from the clumsy drum-type arrangement, it was not considered completely ideal. The Bureau of Ordnance in February 1943 gave the designation of "Mechanism, Feed, 20-mm, M1E1" to an experimental feed mechanism. It was the same basically as the M1, but had a considerably heavier spring that required 210 pounds of torque pressure to wind it and one additional sprocket. It was thought by the Navy that the original model did not produce the

necessary belt pull. This modified feed was tested successfully at Aberdeen and standardized on 12 June 1943 as "Mechanism, Feed, 20-mm, AN-M1A1."

The Navy then requested that it be furnished only this improved version; however, the Air Corps having expressed a preference for the M1, procurement of both types of feed continued until August 1944. This double problem of supply was then settled by the agreement of the Air Corps to use the AN-M1A1 only.

A total of 119,216 feed mechanisms carrying the designation, AN-M1 or AN-M1A1, were produced in all. The Chicago Flexible Shaft Co. and the Harley Machine Division, both of Chicago, the E. W. Carpenter Co., Bridgeport, Conn., and the National Pneumatic Co. of Rahway, N. J., produced this item. Initial contracts were signed with the first three companies in December 1941, while the last company began manufacture in August 1943.

As the feeding of ammunition to a gun from left to right, and vice versa, could be accomplished only by changing to another feed designed to work in the direction desired, it was necessary to make both right- and left-hand feeds. The following tabulation shows the number of left- and right-hand feeds made and whether they were the original or welded clutch models of the M1 or the improved AN-M1A1:

	Left hand	Right hand
AN-M1 (Original design) . . . . .	19,785	14,782
AN-M1 (with welded clutch) . . . . .	53,690	10,613
AN-M1A1 . . . . .	6,825	13,521
Total . . . . .	80,300	38,916

The muzzle brake and the barrel-return spring were considered integral parts of each 20-mm M1 and AN-M2 after standardization. The muzzle brake consisted of two ferrules, a washer and a tubular body that had 36 ports and a like number of baffles. These slots were cut on a 45-degree angle to the axis of the bore and sloped backwards where they caught a good amount of the muzzle blast, thereby absorbing a considerable amount of the recoil forces. It fastened to the

front end of the barrel and was locked into place. This arrangement was quite satisfactory as long as the 60-shot magazine was being used. With the advent of the Chatellerault feed a minimum recoil of seven-eighths inch was found necessary in order to operate the feed, as the system utilized the force and distance of the recoil stroke to wind the operating spring.

Since the muzzle brake could obviously not be used on all guns in the future, it was given the nomenclature, "Brake, Muzzle, M1" and furnished only on special order for guns having the M7 adapter for the 60-shot drum magazine. As there was no call during the war for such a magazine, needless to say, the use of the muzzle brake was indeed limited.

As soon as the Navy saw possibilities of mounting the M1 and AN-M2 in the wings of a plane, a development contract was immediately placed with Bendix Products Division, South Bend, Ind., for the origination of a system of hydraulic charging by remote control from the cockpits. A prototype was completed and satisfactorily tested at several aviation ordnance proving grounds. As a result, the Navy Department requested the Army to procure a sufficient quantity of such chargers to equip all intended Navy installations.

To comply with this sudden demand for the accessory, an order was placed with Bendix without specifying a certain number. The company was simply to make as many as possible in the shortest time. In all Bendix manufactured 46,748 of this type of charger. During the early stages of procurement all were sent to the Navy separate from the gun but later it was decided to equip each new weapon with the charger. The Navy received all the hydraulic chargers made by Bendix during the war, as the Air Corps had a method all its own of retracting the firing assembly by means of manual operation from the cockpit for the few 20-mm cannon it used. And the British used a pneumatic system of reloading that was manufactured in England.

When the United States received its first Hispano-Suiza cannon in 1938, the trigger actuating mechanism was considered part of the firing assembly. It was operated by the Bowden Cable Control System, with which the pilot released the sear manually by means of a flexible shaft operating through a hollow tube. During all the

stages of manufacture of the M1 this type of device was used and was included in all drawings of the firing mechanism. The blueprints pertaining to this part of the gun refer to it as the "Platex Sear Cover Assembly."

The Army Air Force was the first of the services to become interested in tripping the sear by use of an electrical unit known as a solenoid. At its suggestion the Magnavox Co. of Fort Wayne, Ind., in May 1941 contracted to experiment with and develop an electric trigger actuator. The results of these efforts was known as the "Solenoid, G17" and it was so successful that both the Army and Navy specified that all future guns for their use be equipped with the device.

However, the British still clung to their original method of manual firing and continued to order their guns with the original Bendix cable. In order to avoid misunderstanding in ordering of the right parts, the manual release was given the designation "Mechanism, Sear release, M1" and was treated thereafter as a separate component of the guns and not an integral part.

Later when the system of "types" was adopted in order that a gun and certain special parts be included merely by ordering a certain code designation, it was decided that all guns for American use would be furnished with the G17 solenoid and all British ones with the original sear cover and manual trip. When the electric trigger actuator had been established as an official ordnance item, it was assigned the nomenclature "Trigger, Electric, AN-M1."

### Types of Hispano-Suiza Cannon

From the very first there was a continuous effort to produce improved mountings, feed systems, and trigger actuating devices. The latter two were done by authority of the Air Force. In order that someone stand responsible for the procurement of these essential components, the Ordnance Committee, which alone had the authority to do so, took action so that all future orders should be placed in such a manner as to prevent the ordering of 20-mm accessories unusable on the installation intended.

In order to simplify the requisitioning of 20-mm cannon, every combination of gun and components used by the Army, Navy, and British

was assigned an identifying type designation. After much discussion and arbitration it was determined that seven different types would be required to fill every known need. These groups are given below to clarify the purpose of this much needed act:

**TYPE A—AIR CORPS**

20-mm Gun, AN-M2, with the following components:

- 20-mm Adapter, AN-M1
- Electric Trigger, AN-M1
- Manual Charger, M2

**TYPE B—AIR CORPS**

20-mm Gun, AN-M2, with the following components:

- 20-mm Adapter, M6
- Electric Trigger, AN-M1
- Manual Charger, M2

**TYPE C—AIR CORPS**

20-mm Gun, AN-M2, with the following components:

- 20-mm Adapter, M7
- Electric Trigger, AN-M1
- Manual Charger, M2

**TYPE D—AIR CORPS**

20-mm Gun, AN-M2, with the following components:

- 20-mm Adapter, M7
- Electric Trigger, AN-M1
- Manual Charger, M2
- Muzzle Brake, M1

**TYPE E—NAVY**

20-mm Gun, AN-M2, with the following components:

- 20-mm Adapter, AN-M1
- Electric Trigger, AN-M1
- Hydraulic Charger, M2

**TYPE F—BRITISH**

20-mm Gun, AN-M2, with the following components:

- 20-mm Adapter, M7
- Sear Mechanism, M1

**TYPE G—BRITISH**

20-mm Gun, M1, with the following components:

- 20-mm Adapter, M7
- Sear Mechanism, M1

In February 1944 production of all 20-mm M1 and AN-M2 cannon ceased. Although no use was ever found for the M1 guns, since there were almost no serious attempts at engine mountings, it was as late as 16 October of that year before the gun was declared obsolete. Total production of the 20-mm AN-M1 and M2 weapons was as follows:

Navy .....	21,228
Air Force .....	13,272
International Aid .....	44,478
Storage:	
Serviceable .....	19,042
Unserviceable ...	35,955 (long chambers)
Total storage .....	54,997
Lost or expended ..	688
Total .....	134,663

**T26 and Other Modified Hispano-Suiza Cannon**

Since the protection of her carriers from heavy bombers called for a fast-firing automatic cannon, the United States Navy logically took the initiative in the development of the Hispano-Suiza. As early as December 1942 the Navy's Bureau of Ordnance requested that the Army, which had the responsibility of production, study the possibility of shortening the barrel and making other refinements.

On 18 January 1943 Aberdeen Proving Ground began a series of tests to show the effect on muzzle flash, velocity, dispersion, rate of fire, reliability of action, and trunnion loads. Five AN-M2 guns with barrels shortened 6, 12, 15, 18, and 20 inches, respectively, were given severe function tests to determine which was the most effective.

In July 1943 the Ordnance Committee decided that, in the event the tests at Aberdeen did prove successful and a substantial amount could be removed from the barrel length without interfering with the gun's performance, certain

20 MM GUN TYPE DESIGNATION CHART



BASIC GUN - 20 MM MI OR 20 MM AN - M2

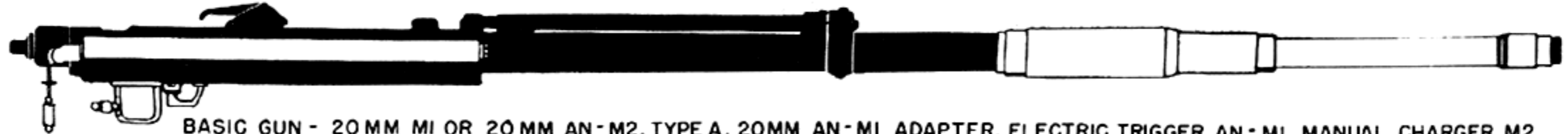

BASIC GUN - 20 MM MI OR 20 MM AN - M2, TYPE A, 20MM AN - MI ADAPTER, ELECTRIC TRIGGER AN - MI, MANUAL CHARGER M2



BASIC GUN - 20 MM MI OR 20 MM AN - M2, TYPE B, 20MM M6 ADAPTER, ELECTRIC TRIGGER AN - MI, MANUAL CHARGER M2

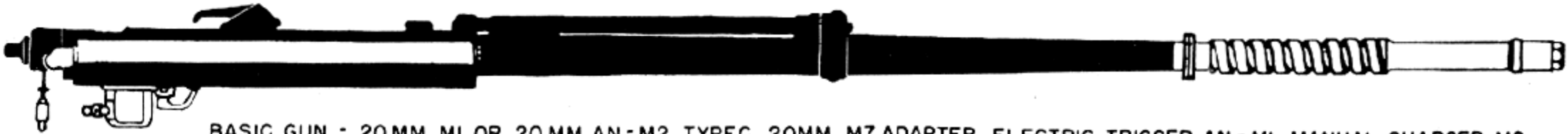

BASIC GUN - 20 MM MI OR 20 MM AN - M2, TYPE C, 20MM M7 ADAPTER, ELECTRIC TRIGGER AN - MI, MANUAL CHARGER M2



BASIC GUN - 20 MM MI OR 20 MM AN - M2, TYPE D, 20MM M7 ADAPTER, ELECTRIC TRIGGER AN - MI, MANUAL CHARGER M2, MUZZLE BRAKE MI

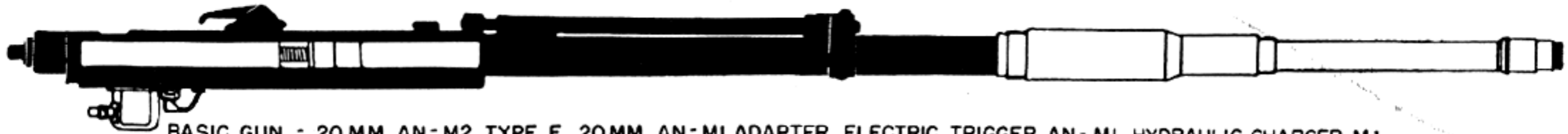

BASIC GUN - 20 MM AN - M2, TYPE E, 20MM AN - MI ADAPTER, ELECTRIC TRIGGER AN - MI, HYDRAULIC CHARGER M1



BASIC GUN - 20MM MI, TYPE F, 20MM M7 ADAPTER, SEAR MECHANISM MI  
BASIC GUN - 20MM AN - M2, TYPE G, 20MM M7 ADAPTER, SEAR MECHANISM MI

other specifications should also be incorporated in the redesign of this weapon. There were definite disadvantages in the use of the AN-M2 gun mounted in aircraft, mainly because of its profile and weight. With the feed in place, the silhouette was very bulky, and often the weapon had to be installed in planes at various angles, sometimes even sideways. This not only handicapped the problem of mounting but wasted space and made the correct placement of feed chutes most complicated.

While the Chatellerault feed was a distinct advantage over the original 60-shot drum, it was not considered the ultimate in feeding and it was quite apparent that if the over-all height could be lowered and the weight of the entire assembly reduced, it would indeed be a progressive step forward.

With these points in mind, the Ordnance Committee took action on 22 February 1943 to authorize the development of a 20-mm gun with characteristics which, if met, would make the weapon practically the equivalent of a greatly refined Hispano-Suiza cannon. The specifications, as given by the committee, are as follows:

"1. The gun to be developed should be capable of using existing ammunition for the 20-mm Gun, M2.

"2. Feed should be of the disintegrating link belt type, without involving a separated transfer as in the case of a magazine throat.

"3. Must be capable of taking different lengths of projectiles.

"4. Rate of fire to be 575-650 rounds a minute.

"5. The gun should be of the self-locking semi-blowback type.

"6. The round in the gun must be controlled at all times.

"7. Feed must be left or right hand without the addition of extra parts.

"8. Belt pull should be at least 75 pounds or the limit permitted.

"9. If possible, the M3 Link (used in the M1 Feed) should be used."

The tests requested by the Navy at Aberdeen, to determine how much the barrel length of the 20-mm AN-M2 could be shortened, showed that 15 inches could be removed with no appreciable muzzle flash and with a velocity drop of only 80

feet per second. At the same time reports from Great Britain showed that the British likewise were refining the aircraft cannon based on the Birkigt or Hispano-Suiza principle. They had successfully removed 25 pounds in weight from the original design and had shortened the barrel by 12 inches. The weapon used for these experiments was the Mark II and the work had progressed so successfully that it had already been given a designation "20-mm Automatic Gun, Mark V."

Oldsmobile Division of General Motors had been given authority by the Ordnance Department to carry on research and development in this country on the contemplated improvement of the gun. By July 1943 Oldsmobile completed the refinement of an AN-M2 following the British pattern with a weight reduction of 27 pounds and a barrel 12 inches shorter in length than the original specifications. The rest of the mechanism was unchanged.

The Ordnance Committee acted to procure a number of these modified guns so that Navy flyers could also test them. It likewise recommended that the weapons be still further modified and stated that they should have these characteristics:

"1. Reduction in weight of approximately 25 pounds.

"2. Decrease in barrel length, 15 inches.

"3. Capable of using the standard M1 Adapter.

"4. Muzzle velocity to be reduced not more than 80 f/s.

"5. Have a cyclic rate of approximately 750 shots per minute.

"6. Capable of firing with the bolt closed and locked.

"7. Capable of using a nonadjustable ring spring adapter."

The lightweight version built to conform to the above specifications was to be given, upon completion, the designation "20-mm Automatic Gun, T26." The immediate modification of 14 standard AN-M2 guns was authorized on 7 October 1943.

Army Ordnance combined this project with a development problem given it in July 1943 when the Commanding General, Army Air Force, urgently requested that work be started on a 20-mm

aircraft cannon with the ability to fire from a closed and locked bolt. A limitation was placed on the time required to fire the gun of no more than one-hundredth of a second between sear release and the instant the projectile clears the muzzle.

Ordnance Department personnel believed that this could be done and added it to the intended improvements then being undertaken. A number of commercial firms were contacted and Watervliet Arsenal was also asked to investigate the problem and offer a solution.

Oldsmobile Division of General Motors was to undertake the devisement of a system of mechanically firing the weapon from a locked and closed bolt. The result was to be given the test designation "20-mm Automatic Gun, T27." The United Shoe Machinery Co. was asked to undertake a similar project, the nomenclature given to it being "20-mm Automatic Gun, T25."

Watervliet Arsenal, in being assigned the task of firing from a locked bolt, was given two means of accomplishing it: By percussion, the gun to be known as "20-mm Automatic Gun, T-28"; and by electric ignition, using electric primed ammunition, to be known as "20-mm Automatic Gun, T29."

This work was undertaken so that the possibilities of firing the AN-M2 from the front seared position could be proved. If accomplished, it permitted the synchronization of the weapon not only for firing through the propeller arc but for turret use as well, since employment of a synchronized fire interrupter could maintain position control throughout firing with no possible danger to the ship structure.

On 7 October 1943, 20 AN-M2 guns were authorized for issue to the above mentioned facilities for modification. On the same date the Navy Bureau of Ordnance requested that six 20-mm T26 guns be furnished it for test purposes. On 12 October the Air Force made a similar demand for 30 guns. Both activities also asked for wooden mock ups to send to airplane manufacturers in order that design changes in mounting could be accomplished.

By December 1943 prototypes of both the T28 and T29 had been produced and were tested at Aberdeen Proving Ground. Each weapon was

constructed for firing with the bolt in the locked battery position, one employing percussion ignition and the other electric.

A pilot model, having features of both the T28 and the T29, also made its appearance at this time. It was successfully fired, using bolts from the T28 and T29 alternately. In view of the advantages resulting from this combination, it was considered highly desirable to concentrate on developing it. The Ordnance Committee ordered the cessation of the separate T28 and T29 programs and gave the new weapon the official nomenclature, "Gun, Automatic, 20-mm, T31."

In January 1944 the Navy asked that 25 of the T31 version be sent to it as soon as possible for the purpose of testing. The Army Air Force likewise requisitioned 51 with the option of an additional order if it proved satisfactory.

The speed with which the whole matter moved is shown by a letter from the Bureau of Ordnance to the Office of the Chief of Ordnance on 12 February 1944 in which a requirement for 23,326 guns of the T31 specifications was to be delivered to the Navy in 1944. The Army asked for a thousand a short while later.

These demands were made before the specified modifications could have possibly been given the endurance firing so necessary for establishing reliability. The tremendous Navy order, with all future aircraft design committed to a weapon that had not been proved, certainly showed great faith in the mechanism.

The International Harvester Co. plant at St. Paul, Minn., having filled its contract and production having stopped on the AN-M2 in December 1943, was given an order in January 1944 to begin making the T31 for which there was already a terrific demand. This company notified the Industrial Branch of the War Department that the T31 could be easily produced by modification of AN-M2 guns. This took care of two things: First, only modification of an existing weapon would be necessary; second, there were in storage thousands of 20-mm AN-M2 guns that did not meet the requirements of the latest drawing revisions. While these guns were being brought up to date, they could at the same time be converted to meet the specifications set forth for the T31. Many of them were



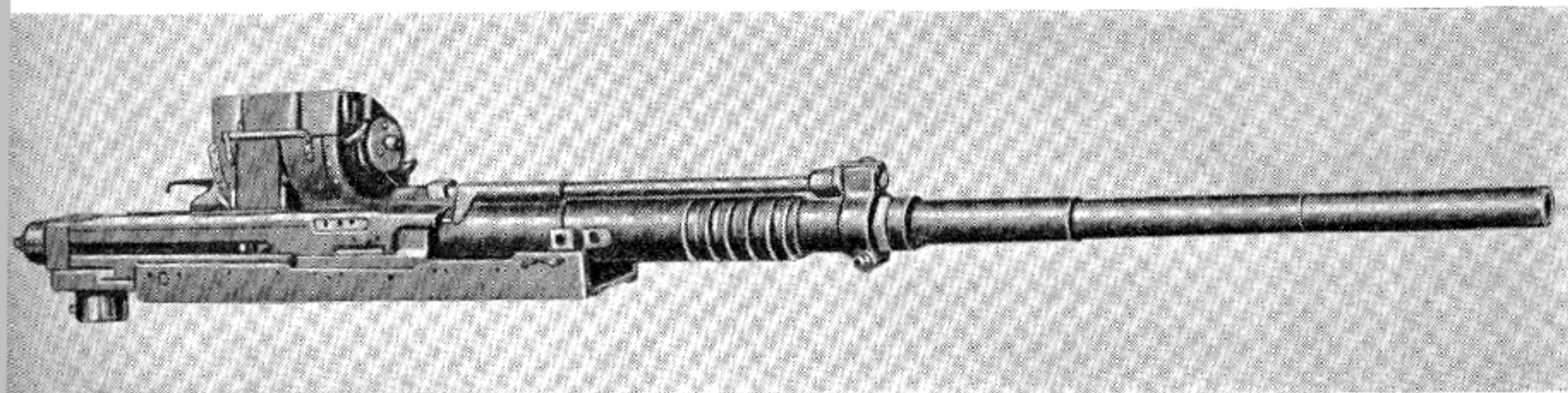

Hispano-Suiza 20-mm Automatic Aircraft Cannon, Model T31.

returned to the St. Paul plant and on 10 July 1944 the first 20-mm T31 appeared. Between that date and 20 September a total of 2,455 guns had been modified, and a scheduled rate of 1,250 guns per month was set as necessary to fill the demand. By May 1945 a total of 12,083 weapons had been converted from AN-M2 to the lighter weight T31, at which time all alteration ceased. The modification of the M2 to the later designation was done at a price of \$625 per gun.

The Oldsmobile Division of General Motors was the other main contractor for the T31 guns. On 16 February 1944 an initial order for 50 weapons was placed with it, followed by a Navy requisition for over 12,000 guns. Large quantities of AN-M2 guns, which had not been modified to meet the latest revisions, were returned to Oldsmobile from storage to be changed into T31 mechanisms.

The first such weapons were produced by this firm in August 1944 and, as of 30 September 1944, 621 guns had been shipped. A rate of 1,400 guns per month was attained by October 1944 and this schedule continued until May 1945, at which time a total of 20,163 weapons had been converted. The final unit price of the Oldsmobile T31 was \$412.

The combined number of T31 mechanisms from International Harvester and Oldsmobile was 32,346. Eighty additional ones were procured by Research and Development Service, making a total production of 32,426 cannon.

Meanwhile experimentation continued on the feed mechanism for the 20-mm cannon, because of the limitations of the M1, or Chatterault, mechanism. Development of the feed mechanism, T4, which had been carried on at Curtiss-

Wright Field, was transferred to Oldsmobile, under the designation "Mechanism, Feed, 20-mm, T14." A preliminary test of this version was made on 10 June 1943, which gave evidence that it was the most promising of any feeder built to that date. It proved capable of lifting 105 rounds and its outside dimensions were much more compact than those of the M1.

The T14 used a new link named "20-mm Metallic Belt Link, T23." This link had no tendency to be cammed off the cartridge during handling and increased the flexibility of the ammunition belt.

In July 1943 a test of the mechanism was made at Aberdeen, during which over 5,000 rounds were fired. Maximum lifting capacity was found to be 110 to 120 rounds, and, after minor modifications, was found to function properly in all positions. Endurance qualities were also quite satisfactory.

The Air Force and the Bureau of Ordnance urged that development of the T14 feed be expedited. An initial order of 30 feed mechanisms and 55,000 belt links was authorized on 7 October 1943. Additional procurement was later requisitioned and on 6 April 1944 a requirement of 550 T14 mechanisms, to be supplied by July of that year, was approved by the Subcommittee on Aircraft Armament.

On 12 February 1944 the Chief of the Bureau of Ordnance established a requirement for approximately 30,000 feed mechanisms, T14, enough to provide one for each 20-mm light-weight gun needed by the Navy, together with necessary spares. Standardization of the mechanism was approved on 11 May 1944 as the "Mechanism, Feed, 20-mm, M2."

## Performance of Hispano-Suiza Cannon During World War II

It soon became apparent that the Navy would be the largest user of the 20-mm cannon; in fact, records show that this branch of the service mounted over 90 percent of the cannon actually placed in American aircraft. The first 20-mm Hispano-Suiza automatic gun in a mock up by the Navy was installed at the Bureau of Aeronautics test facility, then known as the Aircraft Armament Unit, Norfolk, Va., on 11 March 1942.

There was nothing slow about the Bureau of Aeronautics on armament decisions, for the gun was officially accepted for aircraft use the next day. The installation was in the wing of an SB-2C which had been shipped separately by the Curtiss-Wright Aeronautical Corporation, Columbus, Ohio, in order to proof fire the new cannon.

The Aircraft Armament Unit continued to test the weapon in its mock-up mounting and it was as late as August 1943 before the guns were actually placed in the planes at the factory, SB-1C, serial number 200, being the first to be so armed. It was quickly followed by plane number 50, SB-2C.

This aircraft, the scout bomber type, proved to be one of the most widely used during the war and the resulting damage inflicted upon the enemy by Naval pilots was tremendous. However, the records reveal such destruction was done by dive bombing rather than by the use of the 20-mm cannon. The SB-2C first reached the combat area on 11 November 1943 and its first action took place in March 1944.

As an innovation in Navy ordnance, factory representatives accompanied the new cannon to the front. These expert technicians sent back voluminous reports that explained that the malfunctions that did occur were due to one of three things: failure of the feeder, bad ammunition, and improper maintenance. Their zeal in clearing the gun itself in every instance casts doubt on the validity of the reports.

Available records show that the AN-M2 was installed in 5,800 Naval planes requiring the total mounting of 11,600 guns. The SB-2C and

SB-W aircraft were the principal planes carrying this weapon into combat, along with a very limited number of F4U-1Cs. Statistics on enemy aircraft shot down in World War II credit the AN-M2 in SB-2C aircraft with destroying few enemy aircraft. The F4U-1C planes brought down an even smaller number. However, it must be remembered that the primary mission of the SB-2C was not to shoot down aircraft.

The United States Navy has always permitted the introduction of evidence even when contrary to what it would like it to be. There existed two distinct schools of thought on the reliability of the gun. One was that the 20-mm Hispano-Suiza automatic cannon could not be considered satisfactory as an aircraft weapon as long as it was necessary for the ordnanceman to coat the cartridge case with a heavy lubricant or wax. The other was that this was unimportant as long as it bettered the performance of the weapon. But everyone even remotely connected with weapon development agreed on one thing, namely, that 20 millimeters was the minimum caliber for aerial warfare.

During war all that can be done is to install and make function as reliably as possible that which is issued. With the mounting of the 20-mm cannon in Navy planes a series of malfunctions began that could not be properly corrected at the time because manufacture was at the peak of production. The slightest change would practically mean retooling. The most serious problem was the oversize chamber. There still remained considerable variance in dimensions between the chambers of the British and American cannon, even after the latter chamber was made one thirty-second inch shorter.

Due to an outmoded agreement of long standing, everything above caliber .60 in the Army is considered artillery and the manufacture of the Hispano-Suiza cannon therefore came under this classification. In other words the production of this high-speed machine gun was done under artillery manufacturing tolerances. The resulting poor mating of parts, coupled with the inherent fault of all gas-operated weapons whereby the breech locking key in the receiver is immovable and the position of the gas port in the barrel is permanently fixed, made it impos-

sible to adjust the relationship between barrel and breech lock to establish head space. Thus the most vital measurement in any automatic weapon was governed by chance in this instance.

An unfortunate discovery was that chamber errors in the gun could be corrected for the moment by covering the ammunition case with a heavy lubricant. If the chamber was oversize, it served as a fluid fit to make up the deficiency and, if unsafe head space existed that would result in case rupture if ammunition was fired dry, then the lubricant allowed the cartridge case to slip back at the start of pressure build up, to take up the slack between the breech lock and the breech lock key. Had this method of "quick fix" not been possible, the Navy would have long ago recognized the seriousness of the situation. In fact, this inexcusable method of correction was in use so long that it was becoming accepted as a satisfactory solution of a necessary nuisance.

This state of affairs continued until the war's end, at which time all complaints and suggested improvements were carefully evaluated by the Chief of the Bureau of Ordnance, and a letter outlining past faults and suggesting improvements was dispatched on 26 December 1945 from that authority to the Army's Chief of Ordnance under the subject, "Reactivation of Certain 20-mm Automatic Gun Development Projects and 20-mm Ammunition Development Projects—Request for." The following paragraphs are quoted from the letter:

"There is a firm requirement on the part of the Navy Department for use of 20-mm automatic guns in practically all Navy combat aircraft currently in design and currently designated combat operational aircraft . . .

"The 20-mm automatic guns M2 and M3 in their present stage of development have certain objections and defects which make continued development of this type weapon highly desirable. The following features are considered objectionable and are believed capable of improvement:

"(a) The profile of the gun is too bulky for proper installation in VF type wings.

"(b) The cyclic rate of the gun is too low.

"(c) The belt pull is too low.

"(d) It is believed that the over-all weight of the gun and its associated equipments can be materially reduced.

"(e) The accumulated tolerances in the manufacture of the weapon are too great to give uniformly efficient operation in these guns.

". . . Other objectionable features which are believed capable of rectification are listed below:

"(a) The need to oil the ammunition prior to loading for use in this weapon is undesirable. Self-lubricated ammunition, or the elimination of the need for lubrication, is strongly desired.

"(b) The ballistics of the projectile can stand much improvement. It is believed that ballistics similar to that of the Caliber .60 projectile can be closely approximated.

"(c) It is believed that an electrically primed round can be developed for the gun which will give more efficient performance.

"(d) The ammunition should be manufactured to fit the chamber of the gun in which it will be fired and not to fit two of these weapons—namely, the American and British 20-mm automatic guns.

"From the above, it can be seen that the Navy's need for improvement in the gun and ammunition is immediate and will be continuing until the Army's long range development program of an optimum gun for aircraft materializes. It is understood that the optimum gun will require from 15 to 25 years for development to be completed. Continued improvement in the present cannon will certainly contribute materially in experience gained to the development work leading toward the optimum gun. . . .

"Inasmuch as the Chief of Ordnance is definitely interested in this development program, this Bureau wishes to indicate its active interest in and requests that the following program be undertaken:

"(a) Improve the present 20-mm Automatic Gun M3 for immediate needs.

"(b) Continue development projects of such guns as the 20-mm T32 and T33 to arrive at a reliable lightweight, high performance gun within the next four to six years.

"(c) Improve the ammunition for these

guns in order to achieve a family of matched projectiles of relatively high performance.

"(d) Through the experience gained in this development program obtain information, data and experience which, combined with current gun research for an optimum gun, might materially aid in the development of an optimum gun for aircraft within the next ten to fifteen years.

"To support such a program, this Bureau will initiate projects complementary to those undertaken by the Ordnance Department (ASF) to provide competent and experienced personnel and afford Navy Ordnance facilities to assist in the program. In addition, this Bureau will furnish funds to support a proportional part of

this development program as established by the estimates of the Chief of Ordnance."

This letter resulted in the cooperation of the Army, with Navy engineering personnel, familiar with the conditions that needed remedying, in solving the various problems. Today, barely five years after the war, every point brought out by the Navy's Chief of the Bureau of Ordnance has been answered. Nothing was basically wrong with the weapon. Its wartime performance, good or bad, was the result of having been bought in desperation, put into mass production without first having been adequately proved, and then modified regularly to meet a future commitment before the previous model had been made to function reliably.

## FURRER AUTOMATIC AIRCRAFT CANNON

The Swiss Air Force in 1933 introduced an aircraft cannon designed by its well known inventor, Col. Adolf Furrer. This officer originated a system that employed short recoil for operational energy and a clever method of timing the weapon to fire slightly out of battery while securely locked. This last feature permitted high rates of fire and gave a definite buffing action on the counterrecoil stroke.

The first Furrer aircraft cannon was 20-mm, air cooled, belt fed and short-recoil operated, with a quick-change barrel having an attached bolt assembly. All Furrer mechanisms are highly characteristic of the Swiss genius for precision-made instruments, being composed of a multiplicity of intricate components that perform reliably but do not lend themselves to mass production.

The aircraft models, regardless of caliber, had the following details in common: (1) Feeds interchangeably from left to right and vice versa; (2) possibility of mounting for either fixed or flexible; (3) a built-in rounds counter to give the gunner an instant check on ammunition supply; (4) feed pawl disengagement for bringing the bolt home on an empty chamber to prevent cook-off; (5) a non-disintegrating metal belt that did not separate when the cartridge was pushed out; (6) muzzle booster and front barrel bearing; (7) considerably larger barrels than usually employed with the same mechanism in ground work; and (8) single grips in place of the conventional two-grip (or spade) arrangements.

The first models made for the Swiss Air Force were designed for firing through the hollow propeller hub in a Hispano-Suiza engine at the rate of 400 shots a minute. It is of unusual interest to note that the official armament of the Swiss service was all designed by Furrer and government produced. The small arms manufacturing arsenals near Berne were committed to produce

every automatic weapon used by all branches of the Swiss service, despite the fact that two of the leading commercial types of automatic cannon (Hispano-Suiza and Oerlikon) were also manufactured within the borders of Switzerland. This shows, if nothing else, that this government had unlimited faith in the Furrer action and exploited its possibilities to the fullest.

After the engine-mounted 20-mm gun came a 34-mm version with an identical action that was looked upon with great favor because of the larger explosive charge in the projectile. The muzzle velocity of 3,445 feet per second coupled with a cyclic rate of 350 rounds per minute made it a very formidable aircraft and antiaircraft weapon. The cartridge case used in both guns was of the type known as rimmed and was fed into the weapon by a metallic open-type link. The 34 mm was not only adapted to wing mounting but to turret installations, the synchronization of the weapon making it one of the few automatic cannon that lent itself easily to turret mounting.

The cycle of operation of all Furrer aircraft cannon is the same, regardless of caliber. After the belt, or magazine, is put into place, bringing the cartridge in position to be picked up by the bolt face, the action is completely retracted. When released, the compressed driving spring gives the firing mechanism a thrust forward. As the bolt face comes abreast of the rear of the feeding system, a loaded round is shoved forward into the chamber. On the last fraction of an inch of forward travel the toggle joint is forced into line and locks, cocking the piece. The weapon is now loaded, ready to fire.

The scar is rotatable in the breech-bolt frame, and upon being actuated, pivots, releasing the firing pin to fly forward under tension of its spring and strike the primer of the cartridge. This in turn fires the charge. For the first fraction of an inch of recoil the barrel is rigidly

connected with the barrel extension and bolt. During this time it slides under action of recoil in the guides cut in the stationary receiver. The breech-bolt frame contains the bolt which is also moving rearward and is connected by a link with the front end of a pivoted member, also in the form of a link.

The latter is rotatably mounted in the breech-bolt frame on a pivot. The rear end is connected by means of a pin with one of the supporting links, the other end of which attaches to the barrel extension. The bolt only becomes unlocked from the barrel after the barrel and breech bolt have reached a point where a projection in the stationary receiver breaks the straight-line action of the pivoting links. This allows the bolt to open slowly to produce initial extraction. To complete the function, it carries back the fully loosened cartridge held to its face by the extractor.

The first breaking action of the links withdraws the firing pin slightly within the bolt face.

The continued recoil movement not only holds the firing pin in this position but carries the cartridge to a point where its base collides with an ejector built into the receiver. Here the empty cartridge case is pivoted and ejected through a slot opposite the one through which it was fed. With the barrel extension being unlocked from the bolt, the barrel remains in a retracted position. The bolt having completed its full recoil stroke starts counter movement and the bolt face, when in position, picks up the incoming round out of the feedway ready for chambering.

At this time the projection on the firing pin catches the sear mounted in the barrel extension. In the final act of locking, the bolt compresses the firing-pin spring. When the bolt and barrel are locked, the continued thrust of the driving spring then shoves the retracted barrel assembly into battery. If the trigger remains depressed, the sear releases again, firing the chambered cartridge.

## AMERICAN ARMAMENT AUTOMATIC AIRCRAFT CANNON

When the mania for "shell gun" mounting in planes was at its peak on the Continent and the revival of interest in air-borne cannon made the military authorities of all countries review what armament their own air forces had available, the American Armament Co., of New York City, announced in 1933 the development of a 37-mm automatic cannon designed primarily for aviation armament.

The director of the company, Mr. I. J. Miranda, and its chief engineer, Mr. B. P. Joyce, who claimed to have designed the weapon, not only made many trips abroad to interest major powers seeking just such an automatic arm but also made many claims for their weapons that were seized upon by writers for various aviation magazines and ordnance publications. Mr. W. S. Shackleton, of London, who was the firm's foreign representative, also published numerous articles on the virtues of this 37-mm automatic aircraft cannon.

The air-cooled, clip-fed weapon used long recoil for operation, and its rate of full automatic fire was 60 shots a minute, with a ridiculously low muzzle velocity of 1,200 feet a second. This is not surprising when the mechanism is examined closely and compared with others already in existence. For, notwithstanding the manufacturing claim that the mechanism was new in principle and was designed "just for aircraft," it goes back to World War I, being nothing more or less than a conversion for air use of the Puteaux cannon developed both in the United States and abroad.

The first country to become interested in the gun was Poland. It was not impressed by the low muzzle velocity and contracted with the American Armament Co. on the condition that the speed of the projectile be substantially increased. The Polish Government posted a bond

with a neutral agent equal to the cost of manufacture and demonstration of the weapon. This would be turned over to the company if the tests were successful. The agreement stipulated that muzzle velocity and ballistics would be improved. At the trials in Poland in competition with the antiquated C. O. W. gun, then made by the Vickers Co., the English-made weapon consistently outshot the American product. It was also demonstrated that the muzzle velocity had not been increased one particle and the Poles ordered return of the bond. The next venture was with Italy with results that were comparable with the earlier failure.

About the only real accomplishment of the weapon was to mislead the American public into thinking this country had an automatic aircraft cannon that was superior to that of any other country in the world. Practically every aviation magazine or ordnance publication contained artists' conceptions of huge aircraft armed with the gun, firing both from fixed positions in the wings and in power-driven turrets. In reality, little or no improvement over the Puteaux, of which it was a close copy, can be found.

The limited number that were manufactured were made in two models, *M* and *F*. The *M* represented a weapon adapted for turret or movable use. The *F* was for fuselage or fixed installations.

To fire the American Armament cannon, the chambering of the first round requires the efforts of two men. It is a very clumsy operation since the breech must be opened by a special tool which moves the pinion on the breech operating shaft. After the cartridge is chambered, it is fired by percussion, a striker hitting the firing pin a smart blow. The barrel and its extension then recoil together a distance greater than the over-all length of the loaded round. At this

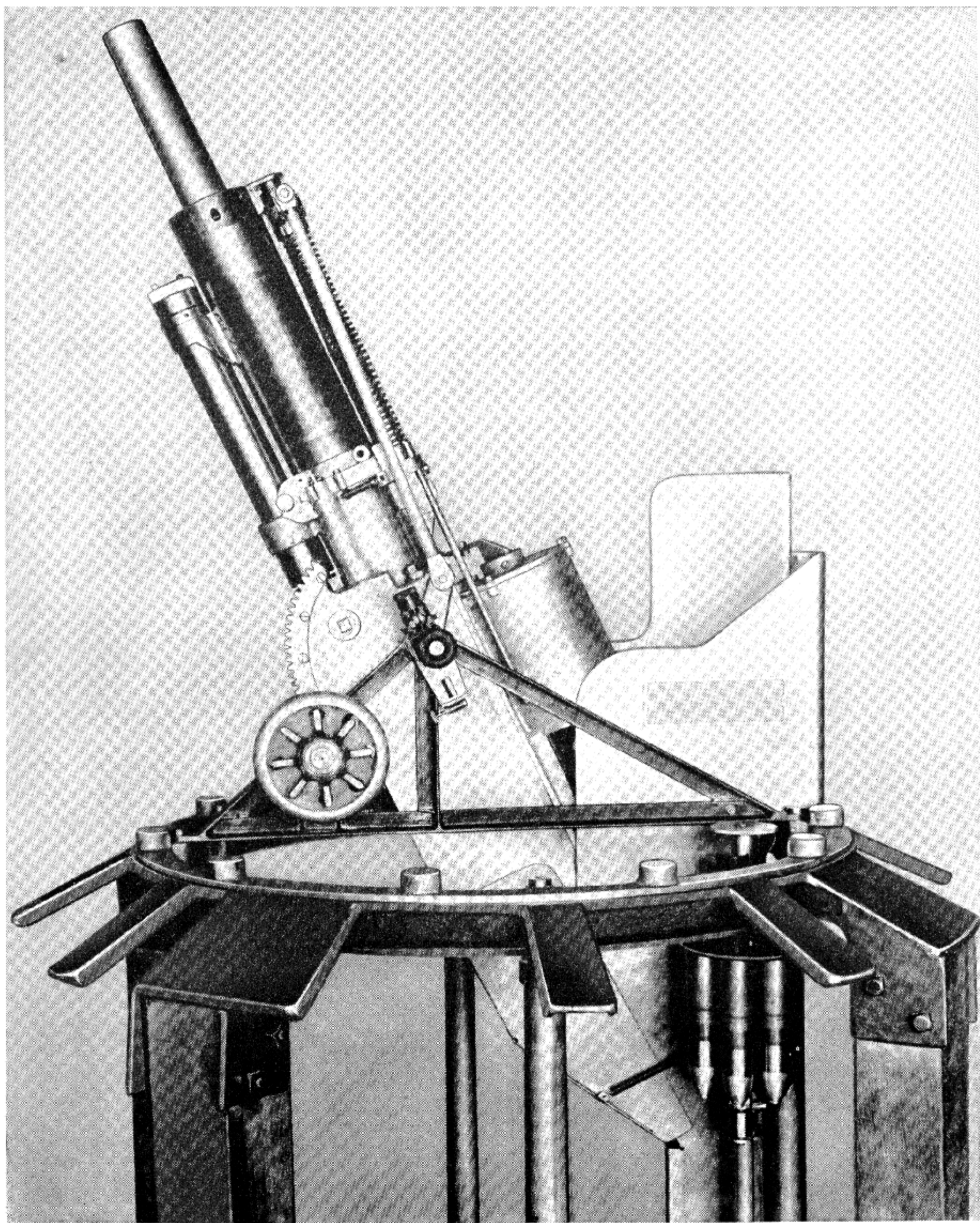

American Armament 37-mm Automatic Aircraft Cannon (Flexible).



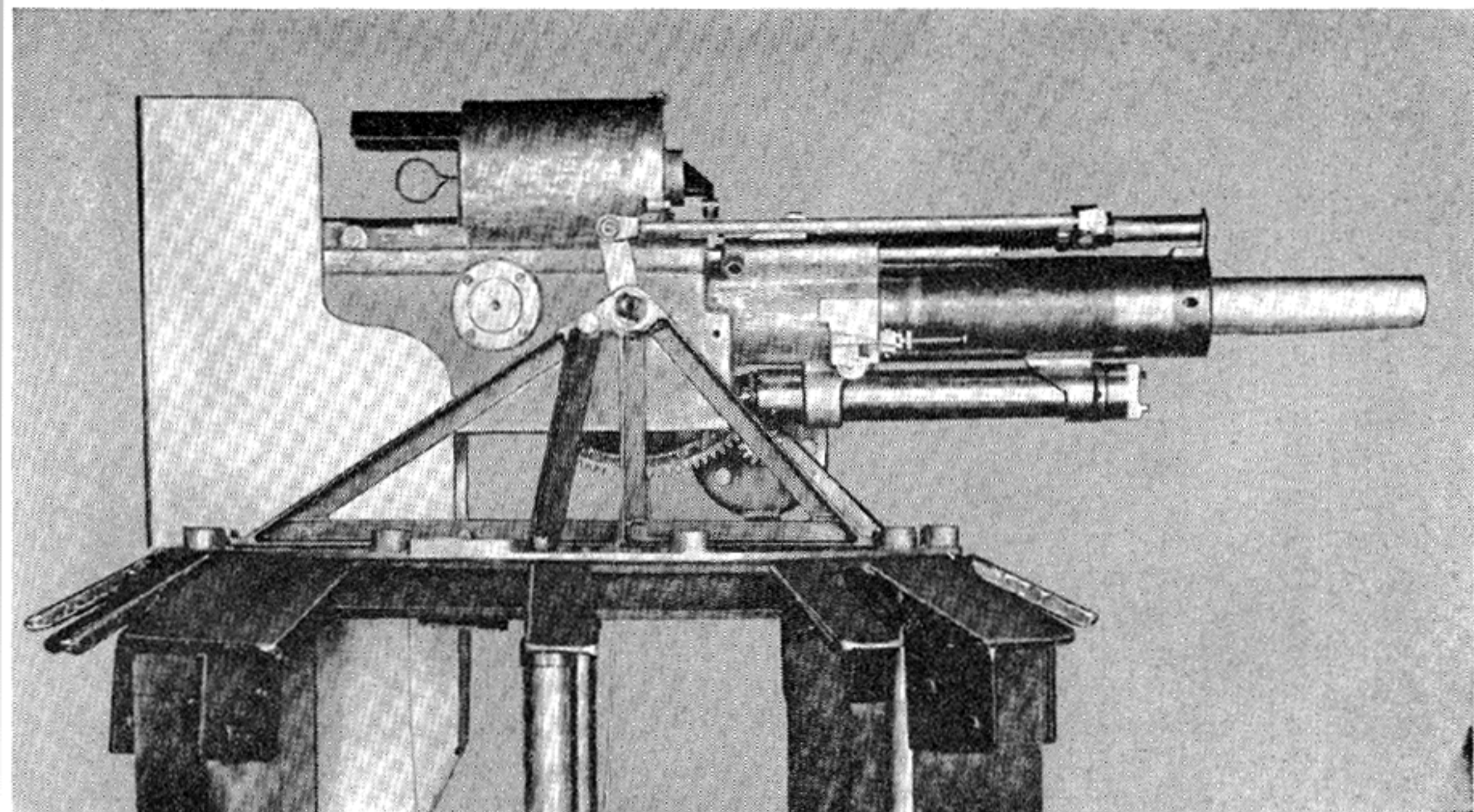

American Armament 37-mm Automatic Aircraft Cannon.

time the breech is unlocked by the camming down of the lock. The barrel and breech lock start toward battery while the extractor attached to the carrier remains seared to the rear.

When the barrel assembly is a half inch from the battery position, the scar holding the carrier is released and this assembly starts home. The feed system, which holds a clip of five cartridges, consists of a recoil-operated cage which rotates to feed the rounds through an opening in the loading tray. The carrier picks up the positioned cartridge and the extractor snaps over the rim as it chambers. The final movement forward of the carrier cams up the breech lock and the weapon is ready to repeat the cycle.

After much paper promotion and exaggerated factory claims this gun disappeared from existence shortly before World War II, but not before it had caused a great deal of interest both here and abroad. It was hardly possible to find any prominent aviation magazine of the day that did not show a sketch of an American plane with this weapon in both fixed and flexible mounting.

The company manual sent to prospective customers on the care, use, and handling of the

American Armament automatic cannon devoted many pages to the potentialities of its devastating fire. Particular attention was called to the ease of its operation, said to require the services of just one man. A direct quote from the booklet permits the reader to determine whether the company was really serious in describing this allegedly simple feat or whether the gunner was some form of contortionist seeking another hazardous occupation for a livelihood.

"The gunner is seated facing one side of the gun and with his eye at the sight at all times. With his left hand he operates the elevating hand wheel whilst with his right hand he traverses the piece by means of a traversing hand wheel. He fires the gun with his left foot while his right foot works the breech pedal that is used to lock the gun in traverse, releasing the right hand to feed clips of ammunition to the magazine."

Regardless of the performance of the gun, any gunner who could accomplish so many things simultaneously would have made a fortune in public exhibitions.

## LAHTI AIRCRAFT CANNON

Finland's highly respected small arms designer, Aimo Johannes Lahti, in 1933 produced at the state manufacturing arsenal at Jyväskylä his first prototype 20-mm automatic aircraft cannon, soon destined for use by the Finnish Air Force. The 84-pound weapon was gas operated, both front and rear seared, and magazine fed (60-shot drum). Charging was done by means of compressed air and the rate of fire was 550 shots per minute, with a muzzle velocity of 2,750 feet per second.

As part of a peculiar mounting system, the brackets were located on top of the receiver immediately fore and aft of the drum magazine. A muzzle brake was always used on the weapon to dampen out a portion of the recoil forces. Half of the barrel starting at the breech end was fluted, giving not only rigidity but offering more cooling surface. An electric solenoid mounted on the left rear of the receiver triggered the firing mechanism when remote control was needed. The air charger was not an integral part of the weapon but fastened to the right side of the receiver. A latch operated by thumb pressure locked or released the magazine at will. An unusually heavy nested spring buffer at the rear of the receiver deflected the operating parts back into counterrecoil.

The Lahti 20-mm automatic cannon had a very clean profile and, with the exception of the abnormally large drum feed, was easily adaptable to aircraft mounting. The inventor was permitted by the Finnish Government in 1935 to demonstrate this weapon before British ordnance officers. It did not give a satisfactory performance, having, in the opinion of the British, too many stoppages from broken parts resulting from the experimental nature of the weapon. The most prevalent malfunction was failure to extract. This could have been caused by the use of too much gas to operate the mechanism. Hasty unlocking thus resulted while too high a residual pressure remained in the bore.

Much work was done to correct the malfunctions that turned up in the English trials and eventually the weapon was considered satisfactory and adopted by the Finnish Air Force. It saw much action in the Russo-Finnish War. At its conclusion the Russians became greatly interested in this weapon and its influence is most certainly shown in some of their later developments.

To fire the Lahti 20-mm automatic gun in an aircraft installation, the loaded drum is placed on top of the receiver and latched into position with the bolt forward. The air charger is then

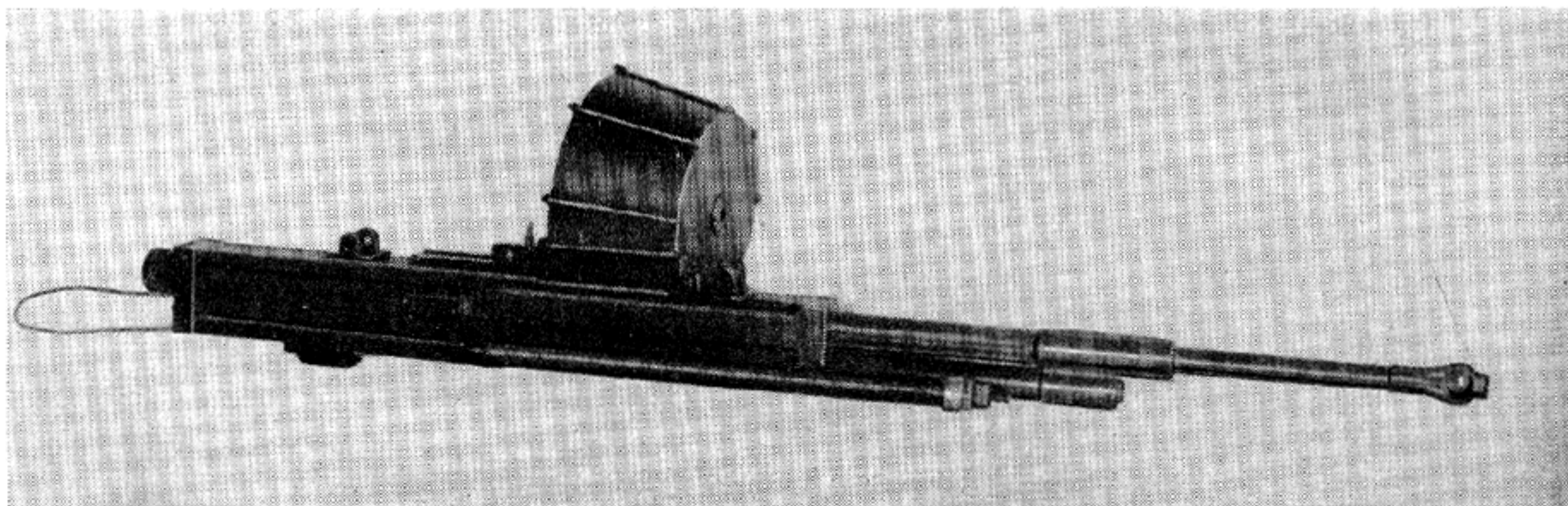

Lahti 20-mm Automatic Aircraft Cannon, Model L27, with Drum Feed.

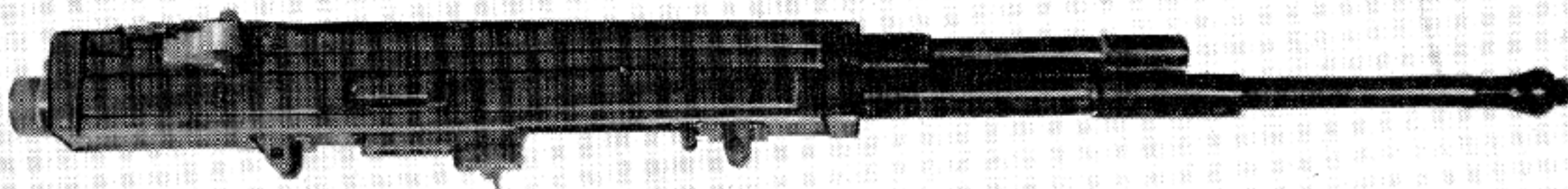

Lahti 20-mm Automatic Aircraft Cannon, Model L27.

actuated. The bolt and piston assembly are then thrust rearward until the sear rises and engages its recess in the bottom of the gas piston. By actuating the electric solenoid, the sear disengages the piston and bolt assembly which is driven forward by the energy of the compressed driving spring. The feed rib on top of the bolt shoves the first round out of the lips of the magazine and chambers it. While the barrel assembly is still three-fourths inch out of battery, the bolt seats behind the cartridge and the extractor claw snaps over its rim. At the same time the bolt-locking piece is cammed up into its locking notch in the barrel extension and this act releases the device that has been holding the barrel and extension to the rear.

The locked barrel, the extension, and the bolt start final movement forward. At a point one-sixteenth inch from full battery position, a pivoting pin in the bolt-body tip that has been in the path of the retracted firing pin contacts a ramp in the receiver and is levered up out of the way. The firing pin is now released to fly forward, striking the primer. The timing is such that recoil forces of the exploding powder charge are set up before the fast-traveling locked mass strikes the solid receiver, thus utilizing these forces to buff the forward action.

The recoiling parts are locked securely together for a distance of a half inch; as the projectile passes the port in the barrel, a portion of the gas is released into the cylinder housing the piston to give the member a sudden thrust rearward. The movement is done in such a manner as to allow the bolt to creep a few thousandths of an inch rearward before total unlocking. This permits the extractor to break the gas seal and fully loosen the cartridge before the instant of complete release, at which time energy is transferred from the fast recoiling barrel to the bolt by means of an accelerator. The latter, upon pivoting, speeds the bolt to the rear with the extractor holding the empty cartridge case. When its rim strikes the solid ejector, it is knocked out of the slot in the bottom of the gun.

The first recoil movement starts to jack the firing pin to the rear and continues to do so until the sear in the left side of the bolt drops in front of the circular projection over the body of the pin. The barrel and its extension at the moment of bolt release are held in a retracted position by the holding latch. When the bolt has reached full recoil, compression of the driving spring starts the assembly forward to repeat the cycle.

## BREDA 20-MM AUTOMATIC CANNON

An early experience with aircraft cannon that ended in complete failure caused the Italian Air Force to delay the development of large-bore aviation weapons until it was altogether too late. And had the Breda 20-mm automatic gun not been designed originally for ground work against armored vehicles and later refined for aircraft use, there would have been no Breda aircraft cannon. In 1934 the Italian Army introduced this weapon as an antitank gun and mounted it on a carriage similar to that of a field piece.

This 20-mm, gas-operated, air-cooled Breda is clip fed with each tray holding 12 cartridges. Continuous fire can be accomplished by keeping one clip in contact with another. The cannon may be fired either single shot or full automatic, as desired. The empty cartridge case is not ejected, but is carried back into its original position in the feed clip by the extractor. This

method of handling the brass unnecessarily complicates the feeder mechanism. The bolt assembly, which actuates the feed, has to perform its work during the very short time it takes for the bolt to clear the rear of the feeder, strike the buffer, and return to position.

To reduce shock and keep the action from being erratic, the mechanism is so designed that the ammunition is not indexed through positive linkage. The bolt assembly on recoil cocks a set of springs and they in turn move the clip through the gun. Also the stroke of the recoiling assembly extends beyond the feed. This long bolt stroke accounts for the weapon's low rate of fire.

The breech lock is of the rising block type and it is impossible to fire out of battery, since the bolt must be securely locked before the firing pin is alined with the primer.

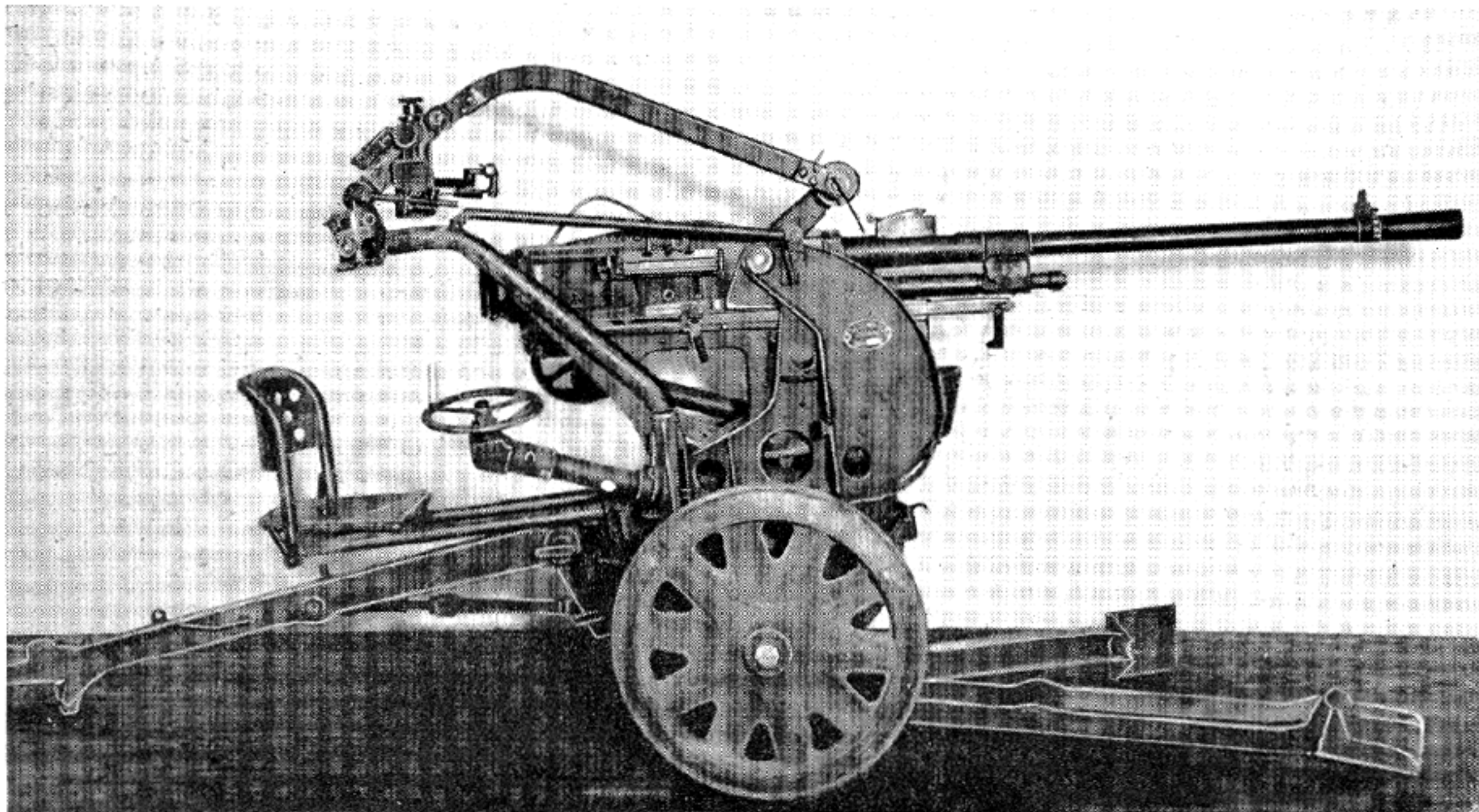

Breda 20-mm Antitank Automatic Cannon.

The gas bracket, which locates the gas housing beneath the barrel, is an integral part of the latter. This assembly includes an adjusting screw to control the pressure bled from the barrel that operates the mechanism. On its breech end the barrel has interrupted threads that enable the gunner to make a quick change. It is also recessed for the extractor and barrel-locking detent.

The receiver consists of a front face, two sides and a bottom plate rigidly joined. The forward part is threaded for the barrel and has in its upper part a seat for the locking detent. Inside and toward the front of the receiver there are slideways for the bolt; slots at the back permit attachment of the back plate; and on the top part of the inside is milled the locking recess. Forward and near the top on each side are the necessary openings permitting the clip to be fed into and carried out of the receiver.

The operating parts include the gas piston, the driving spring and the two-piece bolt and bolt extension assembly. The gas piston is a hollow tube that houses the driving spring. When assembled in the weapon it is fastened to the bolt extension and may be considered part of this piece.

The lower part of the bolt extension is rectangular in shape and bored out to permit the driving spring to pass through it and into the gas piston. A wedge-shaped lug extends from the upper rear part of the bolt extension, and on each side is machined an inclined plane upon which rides the bolt carrying the firing pin. The bolt straddles the horizontal surface of the bolt extension and the action of the angular surfaces cams the bolt up and down to lock and unlock the weapon. Grooves in the lower part of the piece mate with the guide rails in the receiver permitting the assembly to reciprocate in the act of firing.

The upper rear part of the bolt extension has a protrusion that acts as the firing-pin striker after the bolt is securely locked. The forward part of the bolt, which carries the firing pin, has vertical grooves in which the extractor slides.

The loaded clip is indexed when the feed cam is engaged by the lug on the bolt extension. As the cam is stroked to the rear by the firing mechanism's recoil, it compresses the feed pawl springs. On reaching full recoil, the spring-driven feed pawls are released and move a round into position for loading.

Incorporated in the design of this weapon is

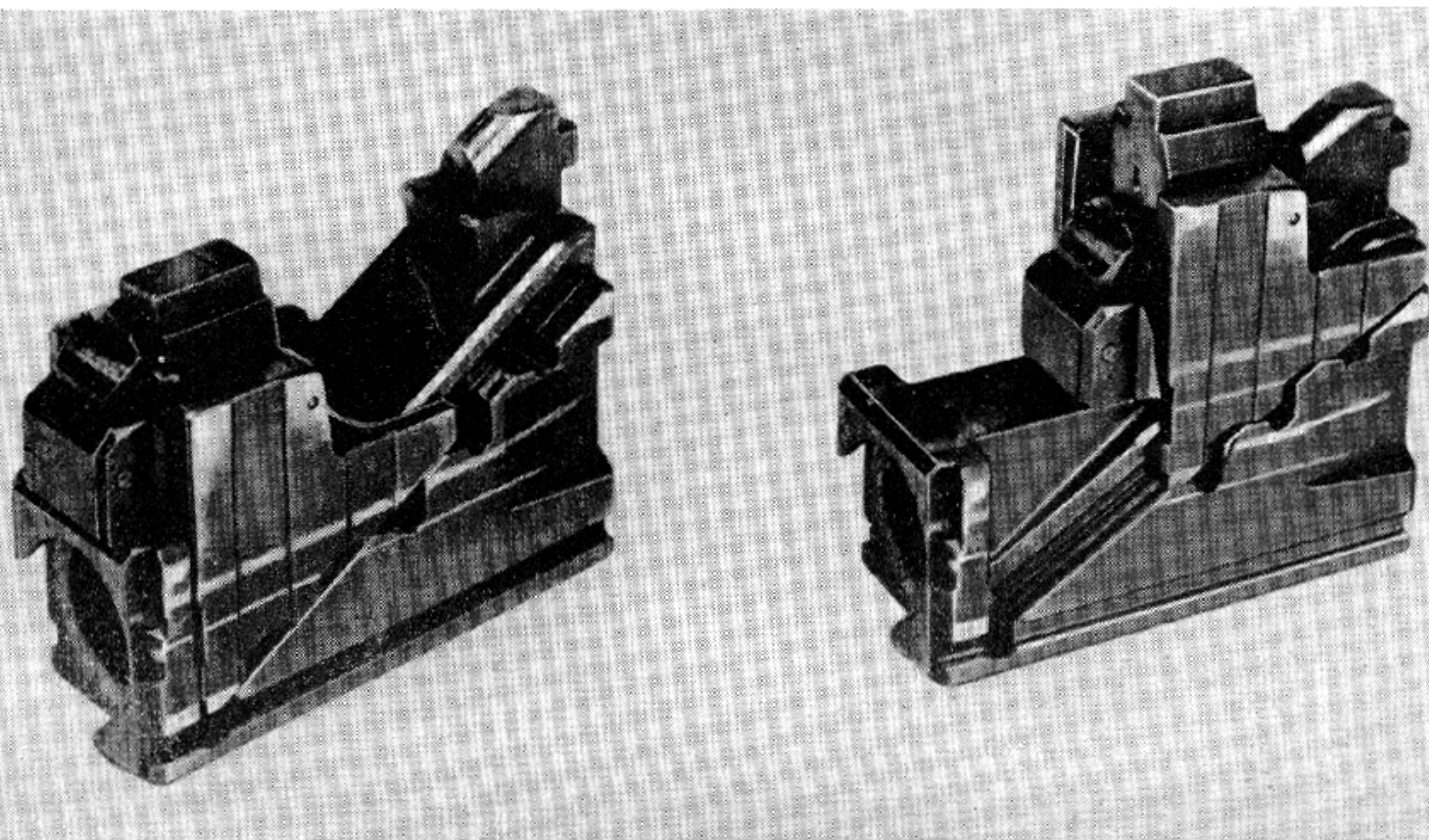

Bolt Assembly of the Breda 20-mm Automatic Cannon. Left: Bolt in Traveling Position. Right: Bolt Locked in Battery Position.

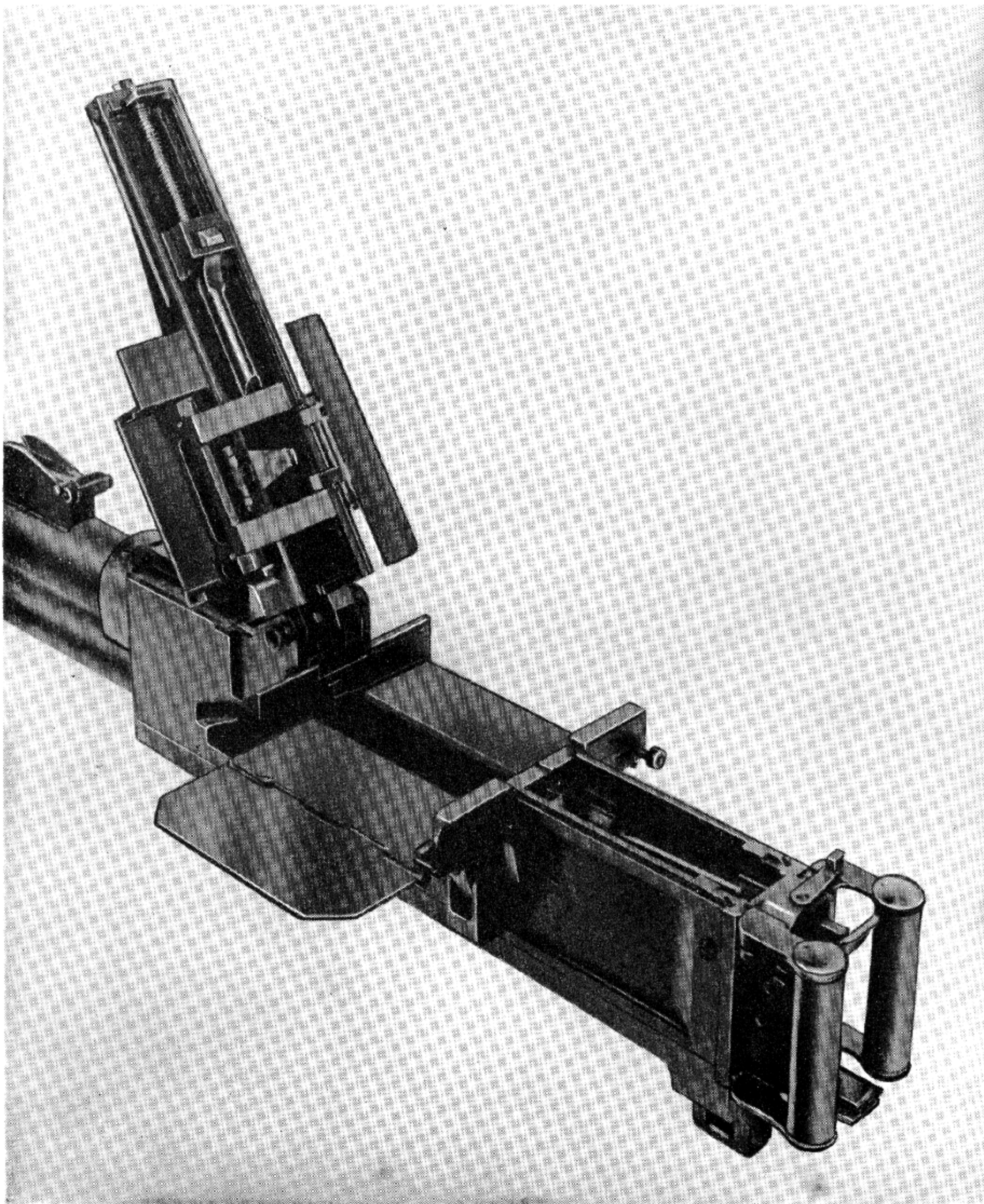

Breda 20-mm Automatic Aircraft Cannon with Cover Group Open, Exposing Feed Mechanism.

a unique safety feature by which a spring-loaded latch falls into a slot whenever the corresponding recess in the feed clip fails to contain an expended cartridge. Consequently, if an empty case is not withdrawn from the chamber by the extractor and positioned into its former place in the clip, the feed will remain stationary without indexing the next round at the end of the recoil stroke. This will jam the mechanism but will prevent a loaded high-explosive projectile from striking the base of an unextracted cartridge left in the chamber.

To fire the Breda 20-mm automatic aircraft cannon, a loaded clip holding 12 cartridges is placed into position on the left-hand side of the receiver and the mechanism is retracted by pulling rearward on a lever located on the lower right side of the receiver. This charging device contacts a lug on the bottom of the bolt extension. As the bolt assembly is moved to the rear against the compression of the driving spring, two lugs one on each side of the extractor strike the inclined surface of the cams in the receiver, causing the extractor to be depressed against spring pressure. Further movement to the rear makes the feed clip move over one space, thereby indexing the first round.

At the completion of the rearward movement the sear engages the bolt extension at a point just below and forward of the hammer and holds the bolt assembly in the retracted position. The weapon is now loaded and cocked. When the trigger is depressed, the firing assembly is released and flies forward by the action of the driving spring.

The top front portion of the bolt starts to shove a round out of the feed clip, while the extractor rises and positions itself around the rim of the cartridge. Continued travel forward chambers the round, with the front face of the bolt striking the breech end of the barrel. The bolt

extension continues forward causing the bolt to rise vertically until its rear portion slips into the locking recess in the receiver. The firing pin has now been moved into position and the upper lug on the bolt extension strikes it a smart blow, driving it into the primer.

The barrel, bolt, and receiver are securely locked at the instant of firing. As the projectile passes through the bore and the port is uncovered, gas is bled into the gas cylinder exerting an impinging action against the piston. This causes the bolt extension to start in recoil and at the same time cams the bolt down and out of the locked position.

The extractor now withdraws the empty cartridge case from the chamber, and releases it after it has been carried back into the space it originally occupied in the feed clip. The release is caused as the lugs on the extractor strike their cams, thus lowering the piece out of engagement with the round. As the recoil movement continues, the top part of the bolt extension strikes the feed cam and indexes the clip through a complete cycle, so that the next round is positioned for stripping.

At the end of the recoil stroke the shock of the bolt is absorbed by the buffer spring, and counterrecoil movement begins. The cycle of operation is repeated if the trigger remains depressed.

The Italian Air Force was practically in World War II before it realized that it lacked adequate armament against heavy bombers. This 20-mm Breda gun was hastily refined and modifications made for aircraft mounting. The weapon was manufactured by the Società Italiana Ernesto Breda of Brescia, Italy, a locomotive works which had turned to armament production in the first European war and continued to turn out weapons in the years that followed.

# MAUSER AUTOMATIC CANNON

## MG-151

When Hitler seized control of the German nation, the military authorities immediately began open Government financing of weapon development and production. The Waffenfabrik Mauser A. G., which had barely existed since World War I, was among the first so expanded. The firm had remained in business through the manufacture of infantry rifles and semiautomatic small arms, which were considered second to none. In 1934 the Government recruited experienced weapons engineers and financed the expansion of the plant.

The Mauser Co.'s initial venture into the field of automatic weapons for aircraft was in 1935. It was given the assignment of developing an automatic gun to use a 15-mm high-velocity cartridge to fill the needs for an intermediate weapon for the German Air Force and to compete with the 13-mm development of Rheinmetall. The action chosen was very similar to an infantry light machine gun that it was also in the act of developing.

High-velocity ammunition had reached a stage

where tests showed the speed of the bullet to be slightly in excess of 3,300 feet per second and an electric primer had proved reliable. This eliminated synchronization difficulties. This work had been accomplished by the D. W. M. plant which likewise had been placed under contract by the German Government. The new aircraft gun used a short recoil, with a rotating bolt head for locking. It was air cooled, belt fed, with a metal disintegrating push-out type link, and the rate of fire was 650 to 700 shots a minute.

While first tests showed reliability of action to a satisfactory degree, the high-velocity bullet practically destroyed the rifling in the barrel in a comparatively short burst. Since the projectile was too small to fuze for a high explosive charge, and as the slight increase of bullet speed was not considered worth the difference, the German ordnance department ordered that the work on this caliber weapon be stopped at once and that every effort be made to use the same mechanism with a 20-mm bore, which put it in the automatic cannon class.

The German system of nomenclature at this time placed everything at 20 millimeters and

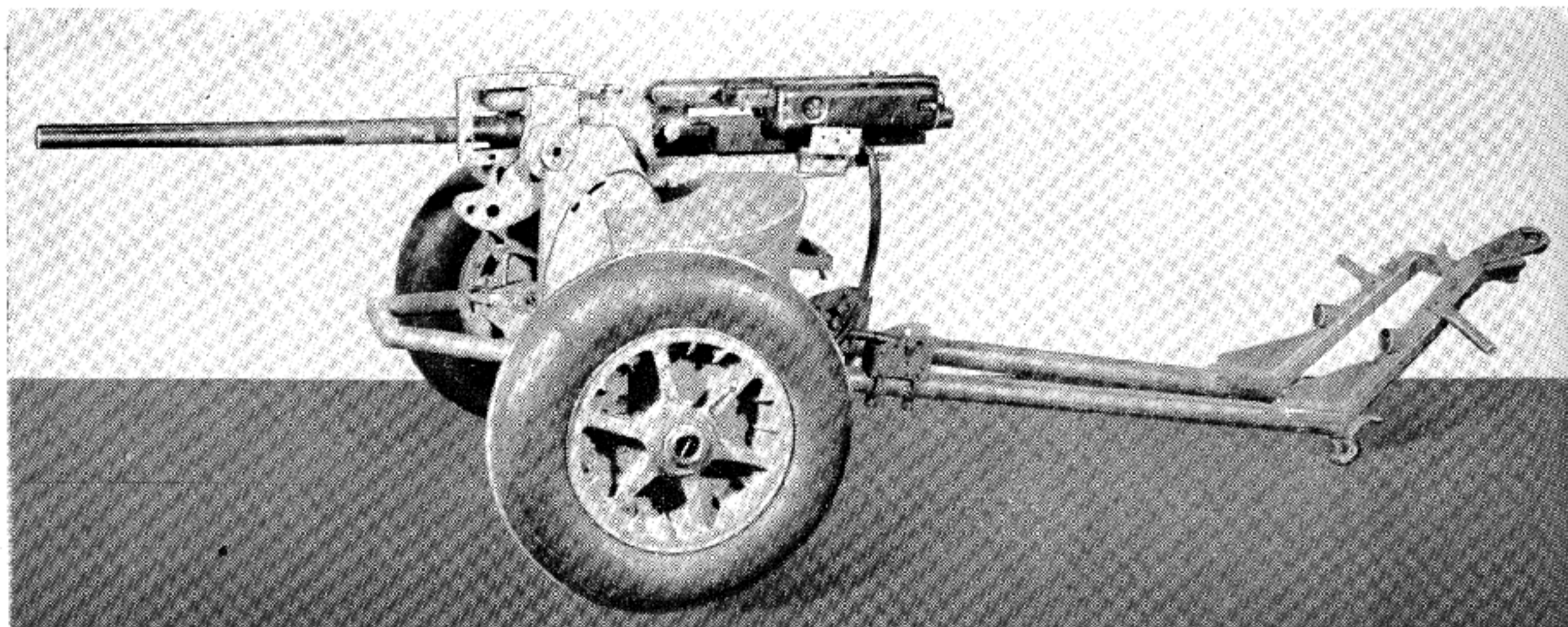

Mauser 20-mm Automatic Aircraft Cannon, Model 151, Mounted for Antitank Duty.



above in the cannon classification, while all below were designated rifle caliber. This method of identification called for the letters MG or MK to be placed on rifle caliber guns and cannon, respectively, followed by the closest numeral to the bore diameters in millimeters, plus the model number. Thus the Mauser Co. designated its original gun the "MG-151" (the "MG" for *Maschinen Gewehr*, or machine gun, the "15" for the bore diameter in millimeters, and the "1" representing the first model.) This is explained in order to clarify events that followed shortly. For when the gun was changed to 20-mm, putting it in the MK, or *Maschinen Kanon* (cannon), classification, the original designation was kept, showing that the weapon was first constructed in a rifle caliber, although now definitely a cannon. The official nomenclature, as ordered by the German ordnance department, was "MG-151 15/20." However, it did not take long for the 15 to be dropped and this weapon is universally known as the MG-151 20-mm aircraft cannon.

The men responsible for the design and development of both versions were Dr. Kurt Fleck, Mr. Otto Helmutt von Lossnitzer, and Dr. Doerge. Dr. Fleck was responsible for production while the other two members busied themselves with the design. All were joint directors of the Mauser firm.

One of the Germans' main objections to the rifle-caliber gun was the weight of projectiles fired a minute. The 15-mm gun firing at 700 rounds a minute placed 93 pounds in flight while the 20-mm, with its higher rate of fire (750 rounds per minute), discharged 190 pounds of metal in the same time. This, coupled with the low destructive power of the solid-ball versus the high-explosive projectile, prevented the smaller caliber from being seriously considered as an aircraft weapon.

The MG-151 20-mm had several good features, the most outstanding of them being: The incorporation of the accelerator as an integral part of the bolt; a quick-change barrel that required only a quarter turn; electric ignition; a driving spring in the cover group, which when raised left the bolt free to be lifted out; push-out type link with snap at the rear to prevent misalignment after belting by engaging the can-

nelure of the round; complete housing of the barrel-return spring; an electric charger that actuated the bolt by energizing its motor; a roller-type sear that insured an easy release by requiring only a minimum amount of energy to free the mechanism but at the same time providing a positive searing action; and a feed system actuated by a lug on top of the bolt, that rotates a feed cam which in turn moves the belted rounds into place. In its final design the weapon weighed 93½ pounds and had a muzzle velocity of 2,590 feet per second.

To fire the MG-151 15/20, the operator first makes certain the bolt is all the way forward, then the belt is placed in the feedway and pushed across until the second cartridge is well inside the receiver. By closing the charger's electric circuit, the bolt is retracted until it engages its rear sear at which time the device returns home under its own spring tension. The rearward movement rotates the feed tube to position a round for loading and the bolt is in the cocked position ready for firing.

When the solenoid that pulls the roller sear downward is engaged, the bolt assembly is started forward by the force of the driving spring in the cover group. The top of the bolt head strikes the base of the cartridge and moves it forward out of its link. As the round is guided downward towards the axis of the bore, the extractor claw engages the rim of the cartridge just as it is chambered.

Locking commences at the instant the bolt-head rollers come in contact with the cams of the sleeve on the rear of the barrel. The locking lugs on the bolt head then turn in a clockwise direction and engage their mating flanges on the sleeve. This movement is aided by the cams on the front of the bolt body acting from the rear against the rollers.

At this moment the bolt carrier is in its foremost position and the weapon securely locked. The firing pin is energized by an electric circuit that is closed by this final movement to detonate the electric primer and explode the powder charge in the cartridge. With the bolt and barrel rigidly locked together while the projectile is in the bore, these parts recoil together five-eighths inch. The bolt-head rollers then engage the surfaces of the unlocking cam, as continued

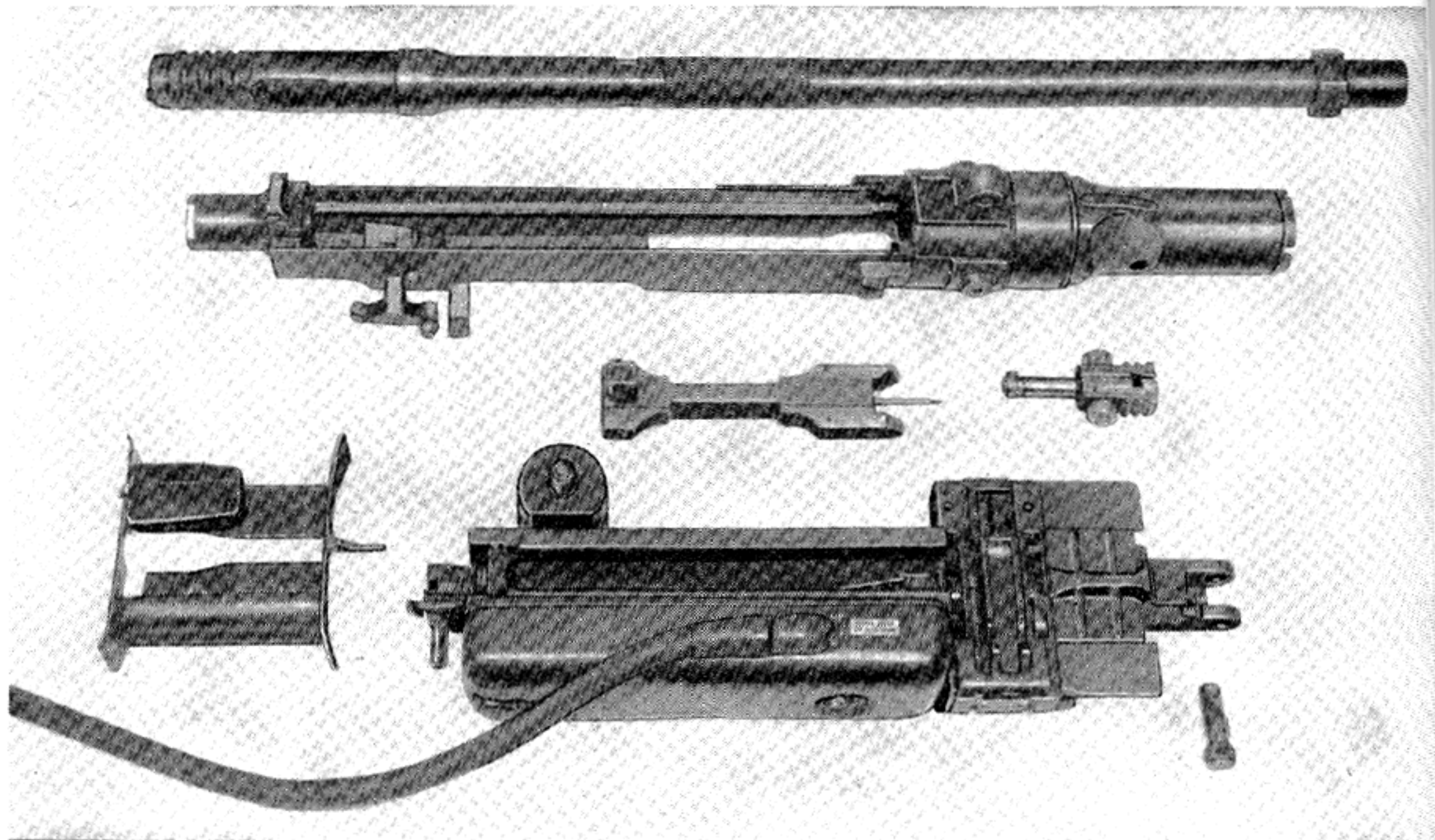

Component Parts of the Mauser 20-mm. Automatic Aircraft Cannon, Model 151.

movement causes the lugs to turn counterclockwise unlocking the piece.

As the bolt head turns with a sudden movement, the rearward portion of the bolt carrier is accelerated by the action of the bolt-head rollers pushing against the cams on the bolt carrier. The barrel continues to travel a half inch until it is stopped by its recoil spring and the snubbing action of the buffer rings. The last action of the rotating bolt head before full unlocking is to extract initially or loosen the round. As the freed bolt starts recoil movement, the extractor pulls the empty case from the chamber and holds it to the bolt face. Near the end of this rearward movement the ejector slides through its slot in the bolt head causing this part to strike the rim of the empty case, knocking the spent cartridge out of the ejection slot in the bottom of the receiver.

Throughout bolt recoil the belt-feed rack and belt-feed pawls draw the linked rounds into the feedway. The belt-holding pawls hinge upward to clear the incoming round. As the bolt approaches its rearmost travel, the pawls snap down against the first cartridge link holding by

spring action the round down in the feedway slot where it can be picked up and chambered by the bolt when it assumes counterrecoiling movement. A strong single-spring buffer stops the bolt's recoil stroke and speeds it back towards battery if the rear sear remains depressed.

A good indicator as to its general use is that the Mauser Co. alone made 29,500 of these weapons in 20-mm caliber from 1940 to 1943.

### Flak 38

The Germans have long been famous for using a reliable firing mechanism in every conceivable manner in which it could be applied and the MG-151 was certainly no exception. It made practically a simultaneous appearance as an anti-aircraft automatic gun and was given the designation of Flak 38. This cannon was designed by Mauser engineers, Linder and Froebel, and although similar in appearance and identical in operating principles, it is a distinct weapon and not to be confused with the MG-151 20.

The Flak 38 has a 20-mm bore, it feeds through the left side with a 20-shot spring-

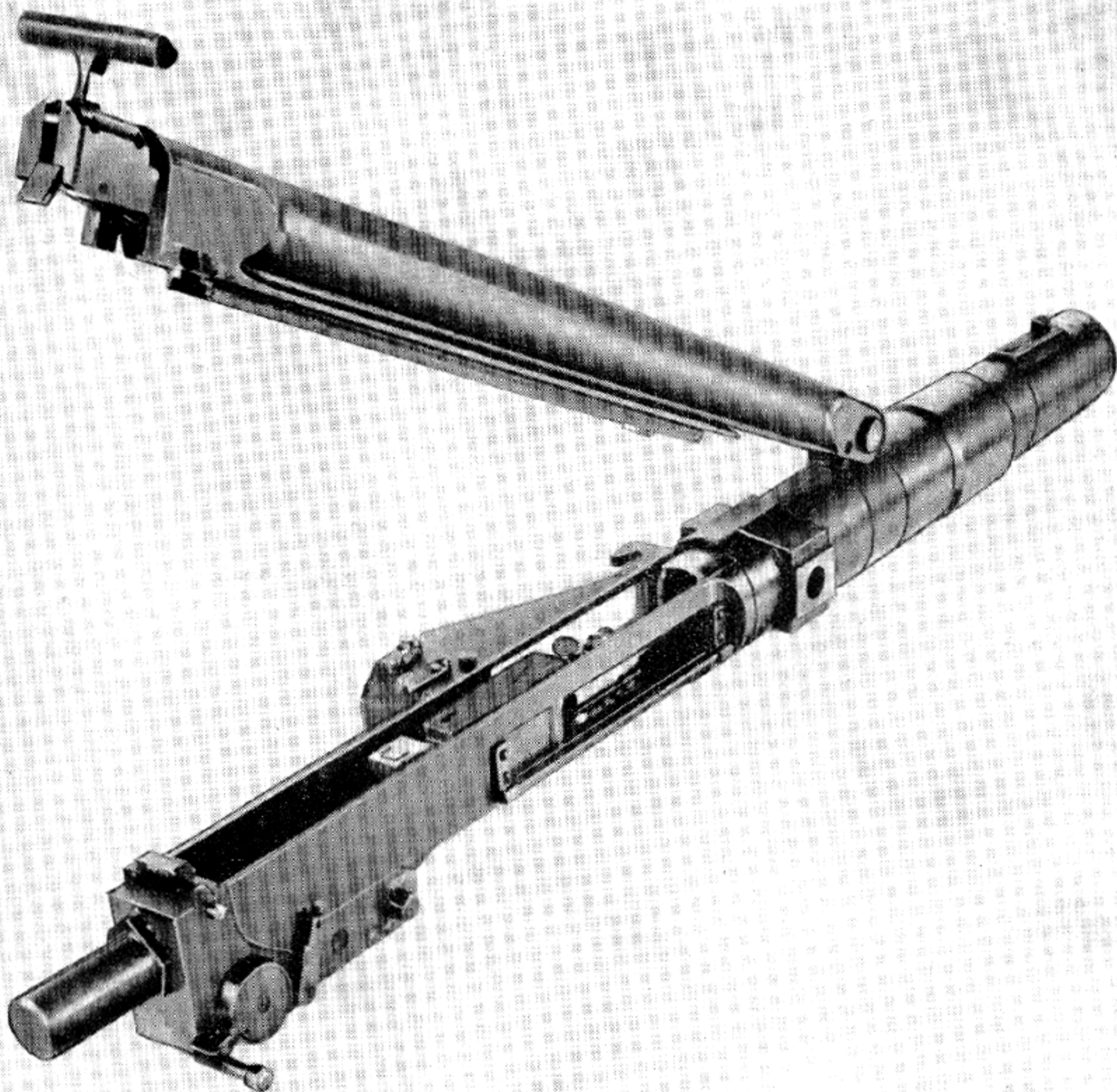

Mauser 20-mm Automatic Antiaircraft Cannon, Model Flak 38, with Cover Group Raised.

loaded curved magazine, and the spent brass is ejected through an opening in the right side of the receiver. The gun is percussion fired and a selector lever on the side allowed single-shot fire if desired. The weapon weighs 123 pounds, has a muzzle velocity of 2,720 feet per second and a rate of fire of 420 rounds per minute. Incorporated in this design is a Belleville washer-type rear buffer.

The Flak 38 was popular from its introduction and eventually superseded the standard 20-mm antiaircraft weapon that had previously been in use. The Mauser factories made 20,900

of this model in the years between 1939 and 1945. Captured documents have revealed that Japan was also furnished manufacturing drawings and all necessary specifications for making both the aircraft and antiaircraft models.

In 1943 the British turned over to the United States a MG-151 20-mm aircraft gun that had been shot down in the battle of Britain and immediately work began in this country in an attempt to devise a weapon using an identical system of operation but in a caliber that was thought to be more desirable than 20 millimeters. American authorities decided on a bore of

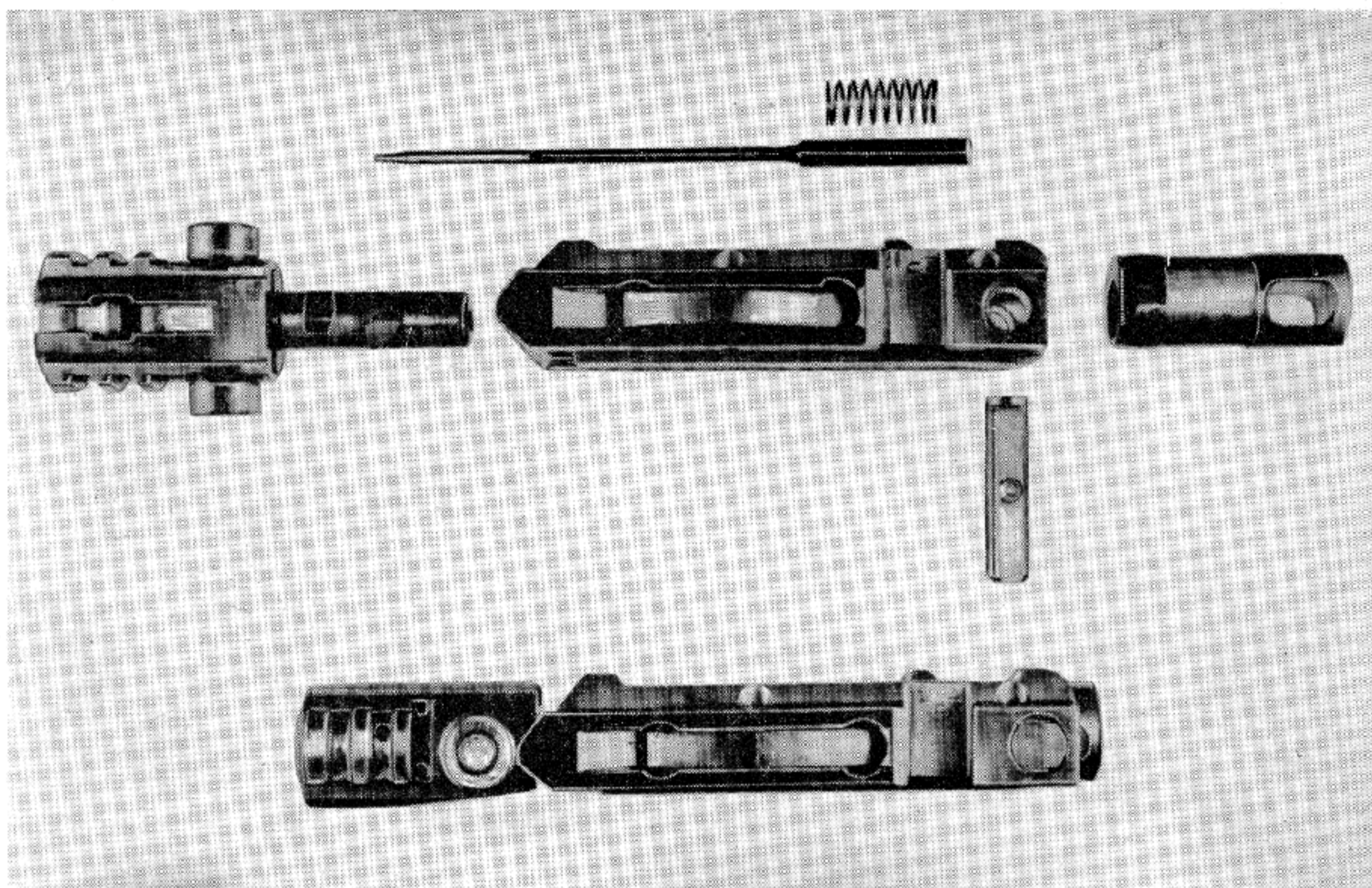

Bolt Assembly of the Mauser 20-mm Automatic Antiaircraft Cannon, Model Flak 38.

60/100 inch, the same as the German weapon that proved unsatisfactory. After seven years and an outlay of money that would be most interest-

ing from a statistical standpoint of negative results, it is in exactly the same status as when originated.

## AUTOMATIC AIRCRAFT CANNON, CALIBER .90 SERIES

During the thirties when the European powers became unusually interested in development of automatic cannon for plane armament, the Ordnance Department, United States Army, also started work at its manufacturing arsenal on several different weapons of this type. Because of the peculiar caliber chosen, they were called by the personnel who worked on them the 9/10ths, or caliber .90, guns. The bore diameter of this series was in reality .900 of an inch.

The first design, known as the T1, was a cumbersome affair. It used a flat drum feed that held 50 rounds, weighed 205 pounds with loaded feeder in place, employed the long-recoil system of operation and was air cooled. Surplus recoil forces were absorbed by a conventional spring-oil-type hydraulic system. The rate of fire ranged up to 150 shots a minute and could be adjusted by a valve in the buffer that controlled oil flow through the counterrecoil bypass.

The very awkward feed system, low rate of fire and numerous other features that were far behind those of already existing weapons caused the project to be dropped. The cannon, however, was made and tested with rather disappointing results.

To fire the T1, the 80-pound magazine is positioned on top of the receiver and the operating parts pulled to the rear by means of a hydraulic charging device. When allowed to go forward,

the drum rotates and positions a live round for chambering, while the bolt is held to the rear. Energizing the electric solenoid sends the bolt forward to shove the round toward the chamber until the bolt's locking lugs come opposite their recesses. This act cams in a dog that has been holding the barrel a half inch from battery. As the entire assembly goes forward, the bolt rotates, locking behind the chambered round.

The final act of locking releases the spring-loaded firing pin and cams the extractor claws over the rim of the cartridge. The pressure generated by the exploding powder charge drives the barrel, bolt, and barrel extension rearward all locked together for a distance greater than the over-all length of a loaded round. A spring-actuated device then rises and holds the bolt while the barrel goes forward pulling the chamber away from the empty cartridge case. The latter falls from gravity through the bottom of the receiver as soon as it is clear of the chamber. If the solenoid remains energized, the returning barrel will trip the sear holding the bolt to the rear and repeat the cycle of operation.

Not only was this notoriously slow long-recoil system of operation used but an additional delay was built into this weapon in the partial retraction of the barrel. The result was a cannon with such a low rate of fire that it was out of the question for aviation use. About the only

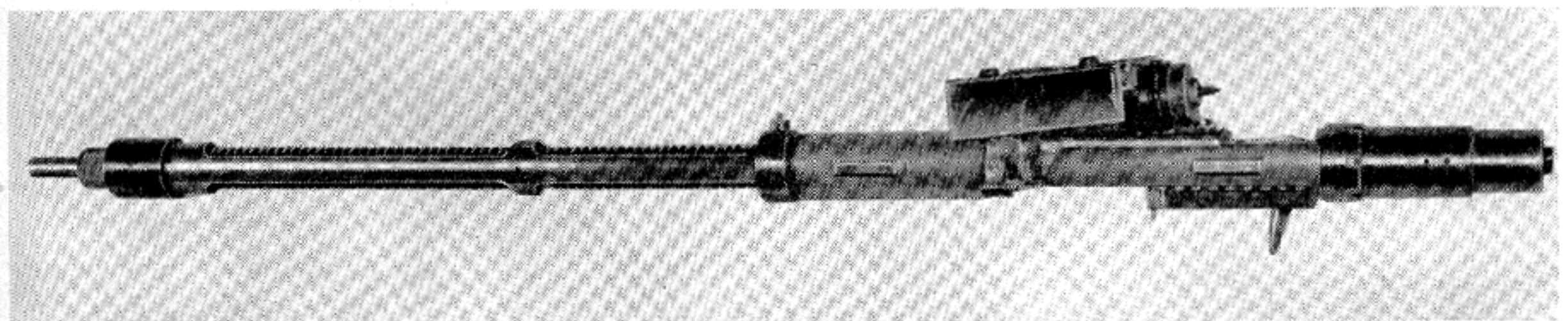

Cal. .90 Automatic Aircraft Cannon, Model T2, with Feed Mechanism.

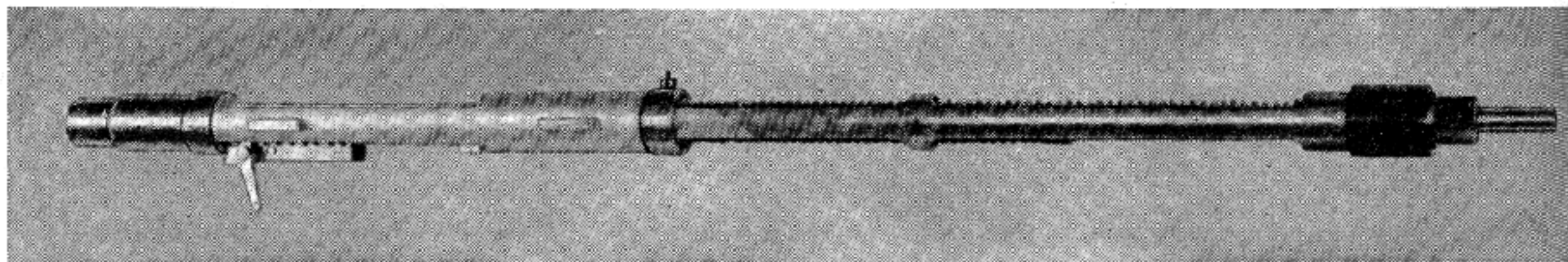

Cal. .90 Automatic Aircraft Cannon, Model T2.

thing to be said in its favor was that it fired a very efficient fuzed projectile at a velocity of 2,850 feet per second.

The T2 air-cooled, magazine-fed model that soon followed used straight blow back for operation and had a bore diameter of .900. The blow-back force was the only energy used in performing the various functions of retracting the firing pin, shoving the bolt to the rear, extracting and ejecting the empty cartridge case and compressing the driving spring for counter-recoil. Cartridges were originally fed to the gun by a drum magazine holding 48 rounds.

As each cartridge is stripped from the feed by the bolt in its forward movement, the succeeding round is positioned by means of a clip and spring contained in the mouth of the feed. The magazine is held in position on top of the receiver by means of a spring-loaded bracket. For mounting in aircraft four trunnions are attached 90° apart at the forward end of the receiver. The weight of the gun without feeder is 240½ pounds with an over-all length of 97 inches. The weapon is rear seared and the firing pin is actuated by forces of inertia.

The magazine functions in an unusual manner and can be set to feed from 2 to 48 rounds. This is accomplished by means of a large gear at the rear of the magazine bracket, geared with the inner revolving unit of the magazine at a ratio of 1 to 4. Each hole in the larger gear represents one round in the magazine. By means of the plunger, which protrudes through and can be rotated about the axis of the gear, selective bursts can be fired. Allowing for the round in position, the setting of the plunger would be one hole less than the selected burst. The plunger, when set, will rotate with the gear until it contacts and depresses the push rod located in the left side of the bracket.

The push rod when depressed has a twofold

function. One is to stop the inside of the magazine from rotating; the other is to release the sear. The first is accomplished by the enlarged diameter of the push rod head coming to rest on the bracket; the second is brought about by depressing the flexible lug on the sear which permits it to return to its normal position. This last function renders the gun safe, as it cannot be fired until the magazine has been reset.

The weapon used straight blow back for operational power and the ammunition had to be waxed before being used. This feature has always been one of the most objectionable associated with such a system. The low rate of fire (400-450), likewise inherent with blow-back operation, made it undesirable for aircraft use.

A flat type of feeder that operated from the recoil of the weapon was later developed to replace the drum feed, but it too proved unsatisfactory.

The T2 caliber .90 automatic aircraft gun resembled the Oerlikon from which it was closely copied. But as in most instances where an attempt is made to duplicate a weapon in principle but not identically, the finished product assumed proportions that were all out of reason for its intended use. This devisement was no exception, as it weighed 240 pounds without feed. This exorbitant weight resulted from use of a heavy bolt and spring to serve as a locking factor instead of inertia as did other weapons of this particular design.

The blow-back force is opposed by the weight of the recoiling parts amounting to 47 pounds, plus the force required to compress the large driving spring. An assembly of gears inclosed in a housing filled with heavy grease acts as a front buffer. The function of this buffer is to absorb the shock of the fast-moving heavy parts in the last phase of counterrecoil movement. The rear buffer is hydraulic in type. A piston

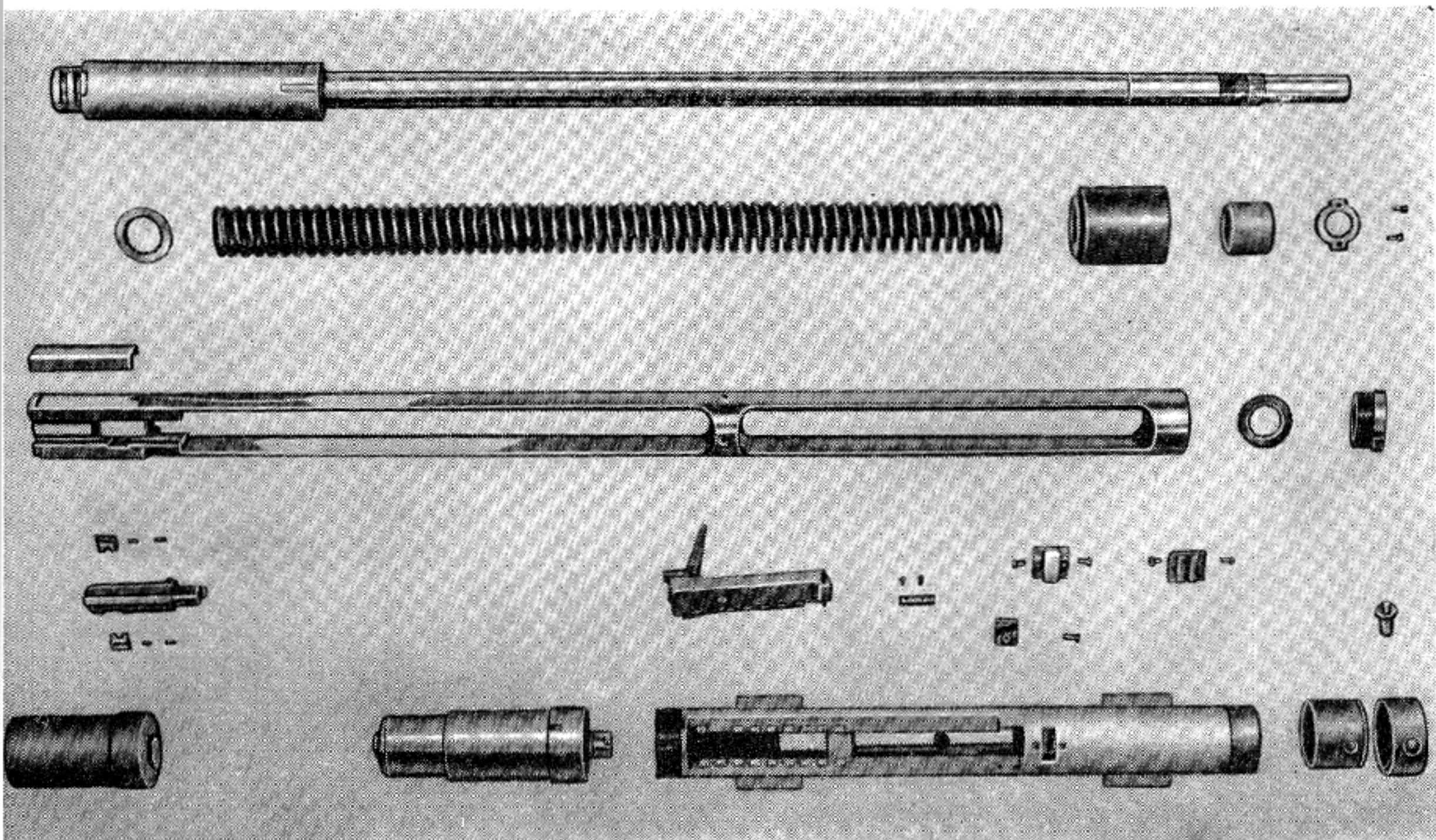

Components of the Cal. .90 Automatic Aircraft Cannon, Model T2.

rod protrudes from the front end, and, when filled with oil, the buffer requires a void only large enough to allow for piston-rod displacement.

The helical driving spring is mounted forward of the receiver over the barrel and inside the bolt sleeve. The hand-charging device consists of a screw with a loop on one end, a serrated nut and a ratchet wrench. The loop on the end of the screw fits the top of the trunnion while the body of the screw lies in the yoke attached to the bolt sleeve. The face of the nut and yoke are brought together by means of the ratchet wrench, which fits the serrated nut. By this crude method the bolt and assembly are jacked to the rear-seared position.

To fire the T2 caliber .90 automatic aircraft cannon, the loaded feeder is set into position and adjusted for the desired number of rounds to be fired. The bolt is then charged back until it is held in the cocked position by the rear sear. When the trigger is pulled, the sear is rotated releasing the bolt to move forward under tension of the advancing driving spring. The bolt

face contacts the head of the first round in the feed mouth, strips it from the magazine and starts to chamber it. When the bolt reaches a point .003 inch out of battery the lug on the firing pin contacts its release cam which causes it to rotate driving the firing pin forward. The inertia-type firing-pin assembly advances rapidly and explodes the propellant.

The pressure from the explosion starts to drive the heavy bolt to the rear and compress the large return spring. The waxed cartridge case slips back with the recoiling parts held by the extractor claw. The bolt passes under a fixed device that strikes the base of the cartridge and knocks it down through the ejection slot in the receiver. The bolt then contacts the hydraulic buffer which dampens out the shock of the heavy recoiling mass, as the operating parts start into counterrecoil movement to fire the next cartridge already positioned by the feed spring.

Later another such weapon, officially designated the T3, was made. It was so close in working principles and in performance to the T2 that it does not warrant further mention.

## BOFORS AUTOMATIC AIRCRAFT CANNON

The name Bofors first appeared in the Swedish public records in November 1646 when an individual named Paul Horsman was granted permission to erect a forge and hammer mill in the mining district of Bofors in central Sweden. It was typical of the many such mills that were later to bring fame to the Swedish steel industry.

There was nothing outstanding about this particular establishment until the middle of the nineteenth century when world events enlarged its sphere of activity. As early as 1870 it was rated the largest manufacturer of rolled bar stock in Sweden and in 1873 the mill was converted into a joint stock company, AB. Bofors-Gullspång. During the late seventies Bofors succeeded in producing a new kind of steel that was considered highly suitable for the manufacture of cannon. This made it a serious competitor of the mighty Krupp works of Germany. In 1883 it built its own workshop for the manufacture of war material and its first order was in 1888 from Switzerland for 28 cannon with a 12-cm bore.

In 1894 outright ownership of the company was acquired by the famous explosives inventor, Alfred Nobel, who immediately stressed the importance of specialization and erected the company's first research laboratory at Björkborn. The manufacture of gunpowder was started and later armor plate was added to the items produced.

In spite of keen foreign competition Bofors prospered and after 1900 began the manufacture of ammunition and fuzes. The company made money but had no need for added factories until World War I when huge orders made its existing facilities inadequate and necessitated considerable enlargement of the plant. After the defeat of Germany, the dismemberment of the Krupp plant by the victorious Allies not only removed a big competitor but also allowed Bofors to

make under license many Krupp guns that could not be produced in Germany.

Events leading up to the second world conflict greatly stimulated the armaments industry during the 1930's and many countries placed large orders with Bofors. Its machinery was thoroughly modernized and production leaned towards heavy automatic weapons development. However, aircraft armament was not overlooked and several experimental models were produced and tested at its modern range. Bofors was the only plant in the world that manufactured and proofed weapons, powder, cartridges, and fuzes on the same company property.

In 1938 the firm announced that it had for sale a 20-mm automatic aircraft cannon. This weapon operated by short recoil, was air cooled and belt fed, using a metal disintegrating push-out type link and was very streamlined in design compared with other known 20-mm guns of this date. A muzzle booster was used to speed up the action to 700 shots per minute. A hinged cover permitted the instant inspection of components for visual check or replacement of broken parts.

An air charger located directly on top of the cover group contacted the bolt by means of a ringed member that protruded through a slot in the center of the receiver that permitted manual operation. A large buffer using Belleville washers was used to absorb shock and give a faster return to the recoiling parts. The barrel was quickly detachable and was housed in a slotted barrel jacket. Mounting was done both on the center line of the receiver and on a T-slot sort of arrangement beneath the trunnion could also be employed whenever this type of installation was needed.

The feed could be made to function from right to left and vice versa merely by the repositioning of parts. Releasing the sear could be accomplished by air and manually, the former



being used when the weapon was mounted for remote control firing.

The links were of thin spring steel and covered half of the cartridge case from base to shoulder of the cartridge. A portion of the link snapped into the cannellure of the round making it impossible for it to get out of calibration once it was belted.

Later the development and great success of a large-caliber automatic gun for antiaircraft use led to this mechanism being refined for aerial use. The bore diameter of 57-mm, however, was thought to be necessary for the specific purpose the weapon was designed for, namely antitank work in close ground support by heavily armored planes especially adapted for this purpose.

The operation and basic features are identical with the Bofors antiaircraft gun, with the exception of the heavier components for withstanding the greater shock of the larger round. The Bofors 57-mm automatic aircraft cannon is operated by short-recoil, non-reciprocating bolt action. It is air cooled, drum fed by a 25-round magazine, and its rate of fire is 100 rounds a minute. A very efficient recoil system is employed to cushion the shock from this unusually large-bore automatic cannon. The recoil assembly consists of a spring and a cylinder. The spring provides in counterrecoil the force necessary to return the gun mechanism to the battery position,

cock the rammer, and feed a new round. The recoil cylinder controls the length of recoil and the velocity of counterrecoil. As the piston rod is drawn to the rear in the recoil cylinder, liquid is forced from the front of the piston through the eight holes in the piston head. Through these ports the liquid passes to the rear. This effective and controlled flow sets up a fluid resistance that adequately retards recoil.

In full automatic fire, only six operations are necessary for a complete cycle. A live round is fed into the loading tray. The rammer is cocked. The round is rammed into the chamber, the breech closed, the round fired, and the empty case ejected.

The large drum feeder indexed each round by spring pressure. While quite simple in operation and efficient, this feed made mounting in aircraft difficult and relegated the weapon to fuselage installations only. The manufacturers of the gun pointed out that this was no hardship since it was for a specific purpose that required a minimum number of rounds to accomplish its mission.

To fire the Bofors 57-mm aircraft model in flight, assuming the weapon is properly serviced before taking off, the operator has only to throw the selector switch from *Safe* to *Fire* and press the firing button. By means of a solenoid a cam forces the sear inward and releasing the inner

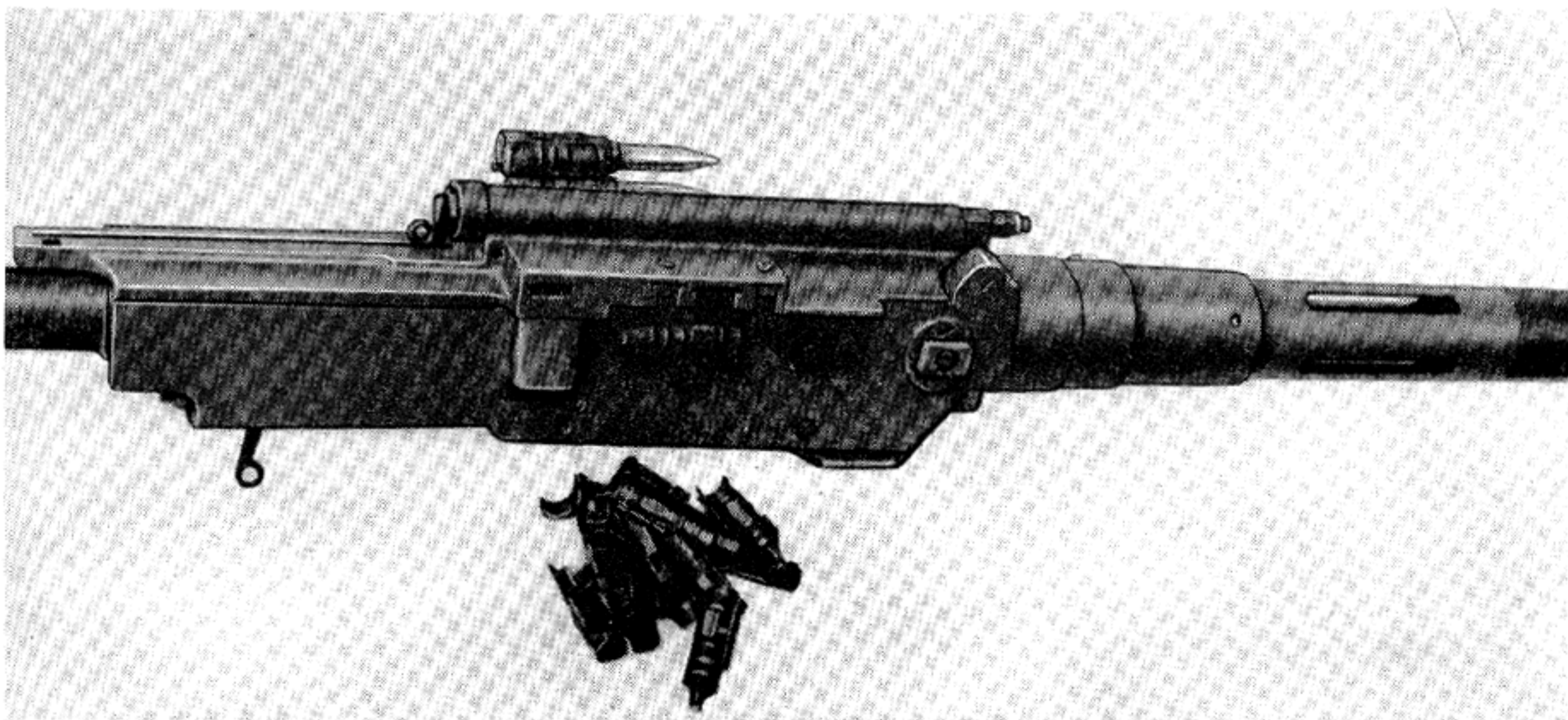

Bofors 20-mm Automatic Aircraft Cannon.

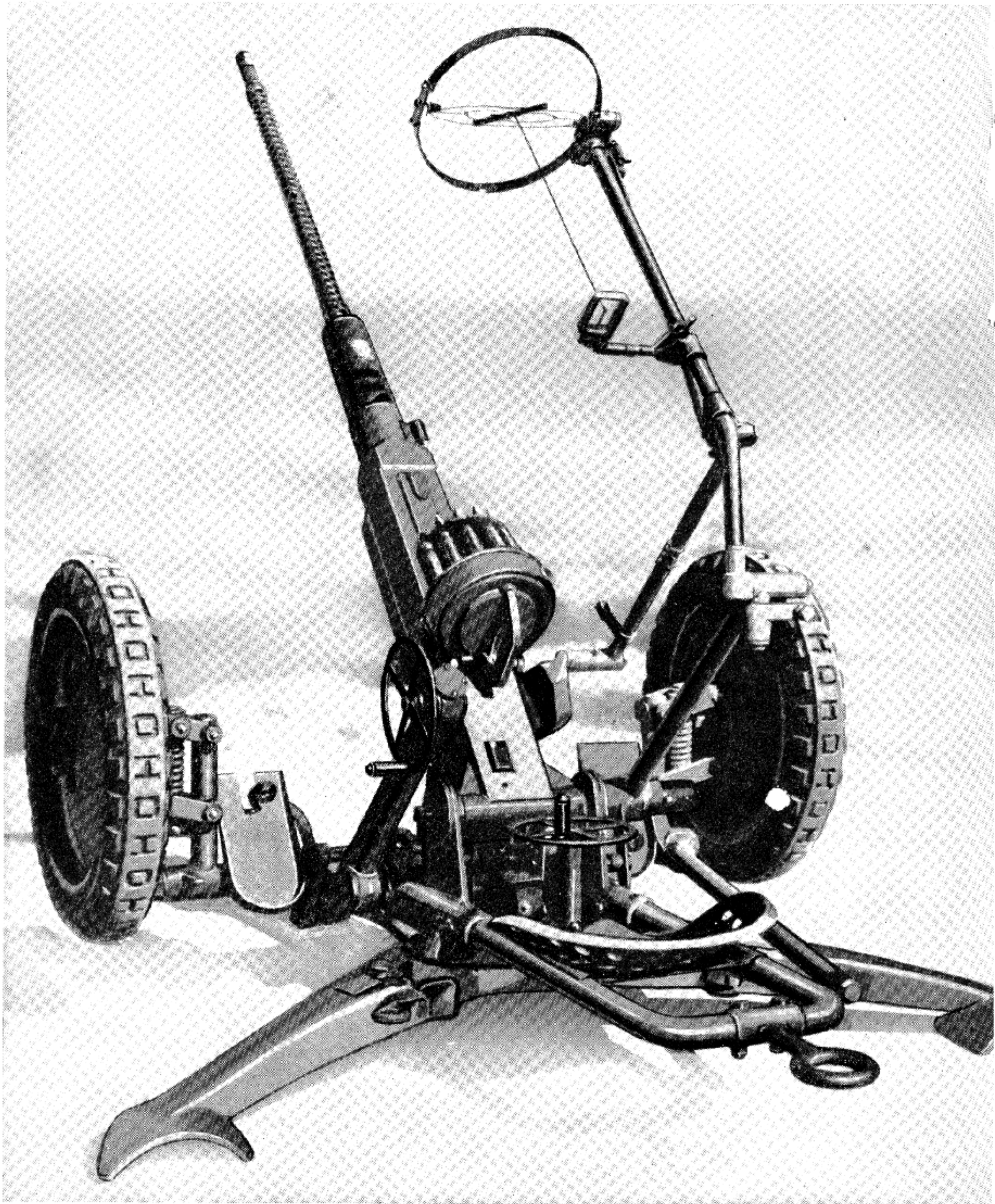

Bofors 20-mm Automatic Cannon, Model L/70, on a Field Carriage.

cocking lever and the firing pin, which strikes the primer and explodes the cartridge's propellant charge.

During recoil the cams on the side act on the outer crank to rotate the crankshaft and the inner cranks. The latter's first movement retracts the firing pin and unlocks the breechblock after  $\frac{7}{8}$  inches of travel. At this time the projectile has safely cleared the bore and continued rotations of the inner cranks lower the breechblock into contact with the toes of the extractors accelerating them in their housing. The empty cartridge case is thrown violently through the opening in the top of the breechblock and clear of the working mechanism of the gun, until it hits a deflector.

During the remainder of recoil the rammer and feed pawls of the loader are raised above the incoming round, being held in position by the stop pawl. This action is brought about by movement of the roller on the feed rod by means of the guides on the sides of the tray.

In the counterrecoil that begins after full compression of the driving spring, the breechlocking spring acts to move the breechblock to the closed position but this motion is stopped

as the breech is latched open by the hooks on the extractor. Consequently, the outer crank is carried clear of the side cam. As the tray moves forward, the pawls on the top surface rotate the star-wheel in the feeder forcing a loaded round on the tray up to the point where the rammer shoe is latched to the rear by the tray catch lever. When an inch from battery position, the cam on the bottom of the tray trips the rocker arm. This in turn fires the tray catch lever, releasing the rammer to start the round into the chamber. At the end of this stroke the ramming levers are spread by the slots in the tray and the live round, released at a high rate of speed, is literally knocked into the chamber.

At the completion of this action the breechblock-closing spring is free to raise the breechblock to the closed position as the extractors are unhooked from the block by the rim of the cartridge in the act of chambering.

While the block rises, pressure on the left inner cam is removed from the cocking lever and firing of the round is accomplished. As the breech is closed, its action on the cam controlling the sear is automatic as long as the selector switch is set for this type of fire.

# JAPANESE AUTOMATIC AIRCRAFT CANNON

The status of Japanese large-caliber automatic-weapon development all during World War II is best described as chaos compounded by confusion, with a slight bit of bewilderment thrown in for good measure. No originality was shown and only a desperate attempt to meet critical conditions by combining a few good features of other weapons was attempted. A scaled-up version of a well-known rifle-caliber machine gun was generally the finished product.

The best way to approach a Japanese aircraft cannon is first to identify it and then compare it with its counterpart among weapons that had been made for years in other countries, such as Hotchkiss, Hispano-Suiza, Oerlikon, Browning, or Vickers. The similarity in operating principles will usually be very apparent.

The most outstanding example of such borrowing is the 20-mm automatic gun given the designation HO-5B. It was simply the successful caliber .50 Browning machine gun made in 20-mm bore by copying an American weapon captured in the early stages of the war. According to official documents found after the Jap

surrender, this condition was the result of Japanese confidence in their 7.7-mm rifle caliber machine guns and 20-mm Oerlikon-type cannon. It later became apparent that a quick victory was not possible and that there was a pressing need for larger bore automatic weapons and for higher rates of fire and greater velocity. Consequently, they copied and put into production whatever was most readily available.

After their successful conquest of the Philippines, the Japs captured thousands of our Browning machine guns and upon this reliable mechanism they based practically all wartime cannon development. It was first made in 13 millimeters and then raised progressively to whatever bore was demanded. These were all designated HO with the Type and bore diameter following, such as HO-103-13-mm, HO-5 20-mm, HO-153 Type 1, 30-mm, and HO-204-37-mm. Of these the HO-5 was the most successful. During the latter days of the war it was the air force's first-line 20-mm aircraft cannon.

While the Japanese simply copied our Browning gun in detail and showed no originality,

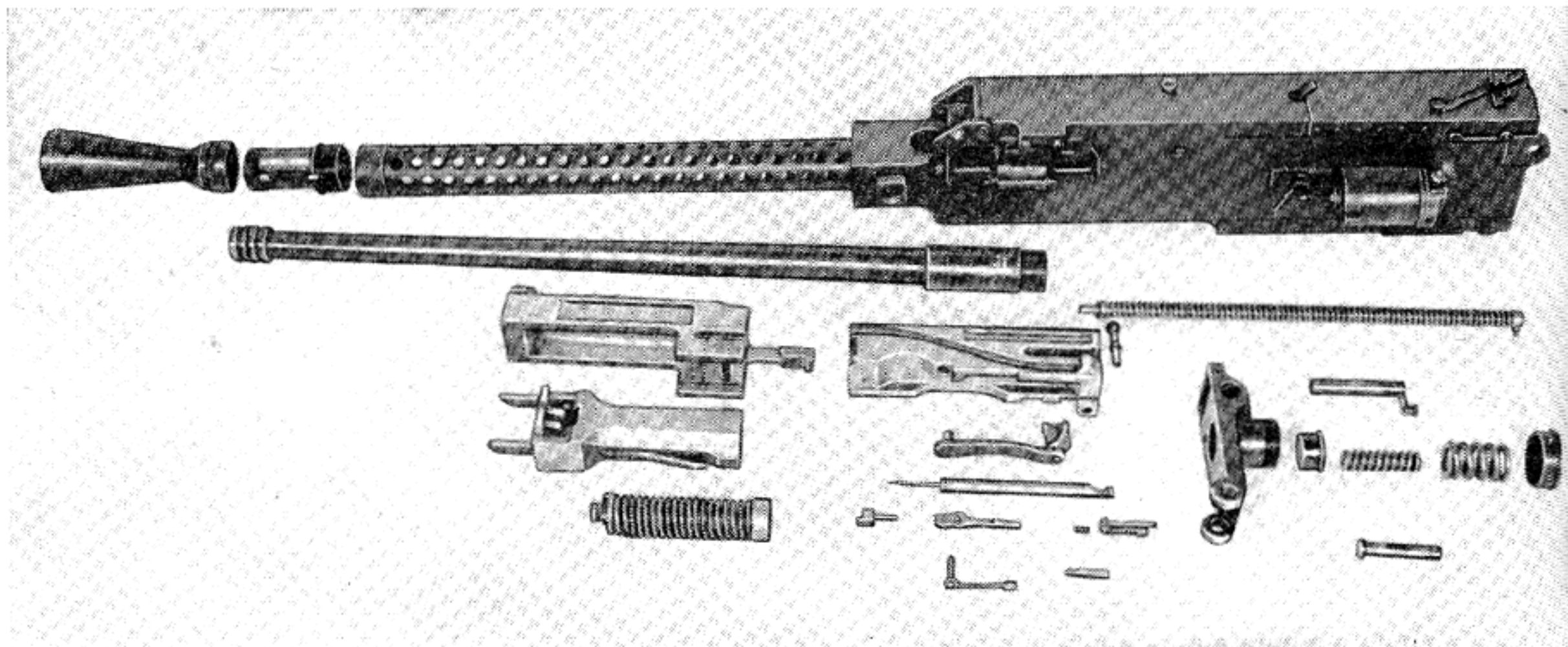

20-mm Automatic Aircraft Cannon, Model HO5.

they did deserve great credit for furnishing an answer to one question that was asked all through World War II. If the Browning caliber .50 machine gun was the best of its kind in the world, then why did not American engineers scale it up to the 20-mm arm we needed so desperately at the time? While we advanced theories as to why it could not be done, the Japs not only did it but succeeded remarkably well. It had a rate of fire of 960 rounds a minute and weighed only 84 pounds. Even with the use of inferior metals the components had a life expectancy of 3,000 rounds.

Later a 57-mm cannon, copied after the Hispano-Suiza Type 404, was attempted and was in an experimental stage at the close of the war. It was known as the HO-401.

Discussion of Japanese aircraft cannon with any degree of clarity is impossible since they were not produced with any object other than to copy and improvise various mechanisms in as large a caliber as metal limitations would permit.

One of the best examples of Japanese developments was the Model 98 20-mm automatic cannon. This was as close as their designers came to originality in weapon planning, but was still only a combination of features that have been in standard use for years.

This weapon was so constructed as to be adapted to both aircraft and antitank mounting, and was successfully tested in 1938 at the government arms plant. The mechanism was relatively simple and rugged in construction. It

operated by gas and blow-back and was magazine fed, air cooled and rear seared. It was relatively light for this caliber, weighing 152 pounds with loaded magazine attached. The official rate of fire was given as 180 aimed shots per minute and 450 maximum during full automatic. The bolt was securely locked during the act of firing with gas being used only to unlock the piece. Blow back furnished the necessary energy to complete the cycle.

The barrel is quickly fastened or detached. It is positioned by a set screw in the top of the receiver acting as a key in a slot on the barrel. After the interrupted thread bushing is rotated a sixth of a turn, a spring lock snaps in the rim of the bushing securing the whole assembly. The bolt, gas piston yoke, driving spring, rear buffer, magazine interlock, safety lock, and ejector are all housed in the receiver. The opening in the receiver into which the magazine fits has a spring-loaded door that snaps shut whenever the magazine is removed and the gun is not in use. This prevents dust or any other foreign matter from getting into the working parts.

The gas-piston yoke rides in the slideway in the sides of the receiver. The locking key that backs up the breech lock is also set in this member. The yoke is the carrier for the bolt assembly, having two tubes that go to the cylinder and act as pistons. The driving springs are housed in these tubes. The angled surface of the yoke's rear end acts to cam the back of the bolt upward into locked position while the rearward thrust

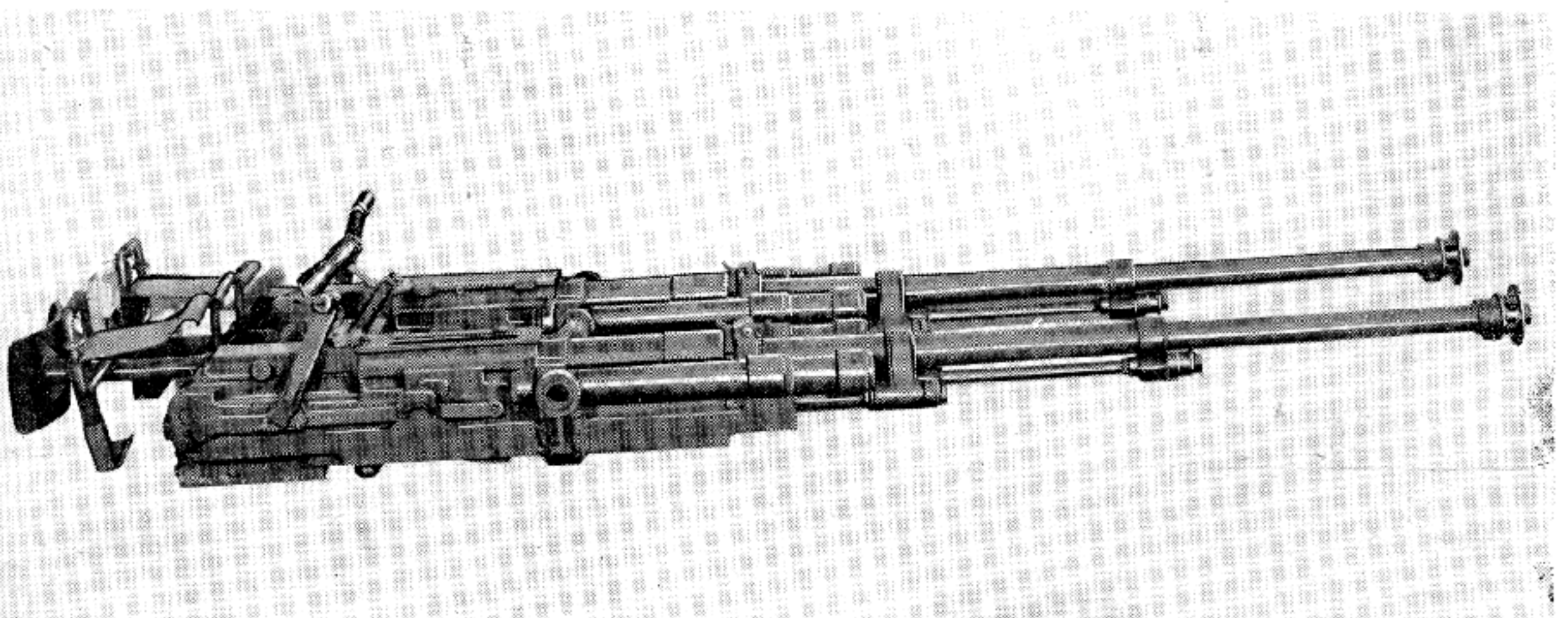

20-mm Automatic Cannon, Model 98, Dual Antitank Mount.

by gas pressure on the piston cams the bolt down to unlock. The ejector rides through a slot in in the top rear portion of the yoke, the surface below the ejector groove serving as a cushion for the striker.

The breech lock has two T slots. The rear one engages the firing pin camming it rearward for unlocking, while the forward one forces a vertical movement for locking. The firing pin, which is housed by the bolt, is slotted at the top so that the ejector can make contact with the base of the empty case. Also attached to the bolt is the spring-loaded claw-type extractor.

When the weapon is mounted for aircraft, a drum feed is employed and the rate of fire increased by raising the size of the gas orifice. When used as an antitank gun a vertical metal-box-type magazine holding 20 staggered rounds is fitted into a slot in the top of the receiver and held in place by a shoulder at the forward end and a spring catch at the rear.

To fire the 20-mm Model 98 automatic cannon, the gunner first places a loaded drum or magazine into place with the bolt forward. He then grasps the charging handle located on the lower right side of the receiver and pulls all the way to the rear. This draws the bolt assembly and gas-piston yoke rearward until the spring loaded sear hook in the receiver snaps into its recess in the gas piston assembly holding the entire mechanism in the cocked position. The trigger, actuated by a firing handle, transmits its movement to the sear by means of a linkage and releases the gas-piston yoke and bolt assembly to go forward by compression of the driving springs.

The charging handle also moves ahead with the firing of the first round and remains that way throughout automatic fire. The rib on top of the bolt, in passing under the magazine, strips the first round from the feed and starts it towards the chamber. During the final act of chambering

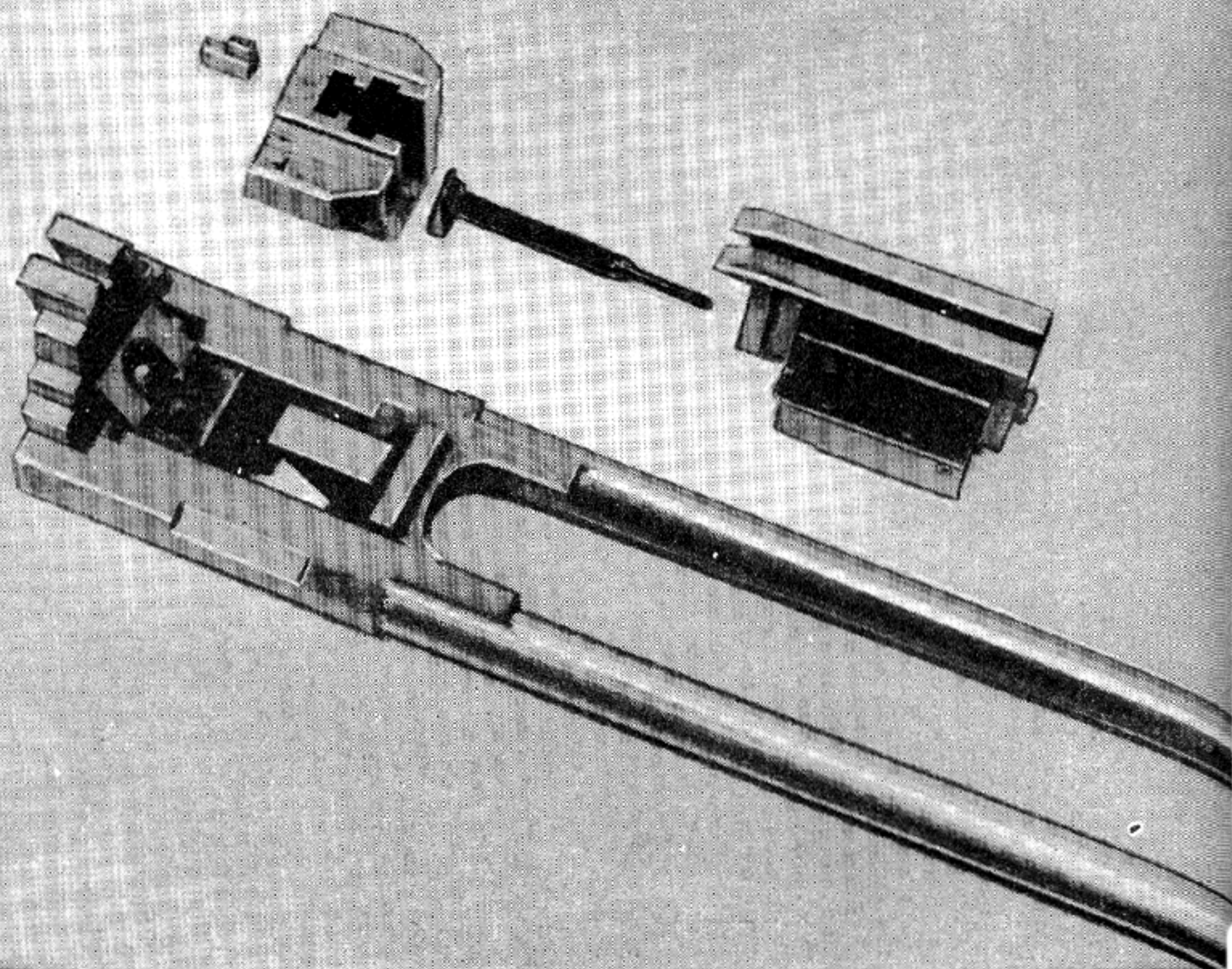

Bolt and Bolt Extension Assembly of the 20-mm Automatic Cannon, Model 98.

the spring-pivoted extractor snaps over the rim and into the cannellure of the cartridge case. As the bolt is seated all the way forward, the gas piston yoke is free to continue on, the bolt and its locking piece being interlocked in such a manner as to permit the latter to rise vertically. The angled surface of this piece and the corresponding cam on the gas piston yoke force it upwards in front of its locking key, thereby holding the bolt securely behind the chambered round.

The piston yoke travels forward a few thousandths of an inch when its rear vertical projection strikes the firing pin, driving it into the primer which in turn detonates the powder charge. While the projectile is in the bore, the entire action is rigidly locked but a portion of the gas is metered into the gas cylinder through the barrel port after the passage of the projectile.

This forces the yoke to the rear, camming the breech lock down, and the entire unit starts to recoil with the extractor carrying the empty car-

tridge case. The first movement rearward cams the firing pin back into the bolt body. As the movement continues, the ejector fixed to the inside top of the receiver rides through the grooved upper part of the bolt, striking the rim of the empty case, pivoting it down through the ejection slot in the bottom of the receiver. Full recoil stroke is accomplished when the bolt assembly and the gas piston yoke strike the rear buffer. This heavy spring-loaded device absorbs all surplus energy not taken up by compression of the driving spring. The operating parts enter into counterrecoil movement to repeat the cycle of operation provided the firing handle remains depressed.

The Japanese used the weapon as a ground gun, but during the latter days of World War II in their desperate attempt to stop the devastating American bombing raids, they modified and adapted the cannon to aircraft use. It was usually mounted as a free gun but there are records showing experimental installations in power-driven turrets.

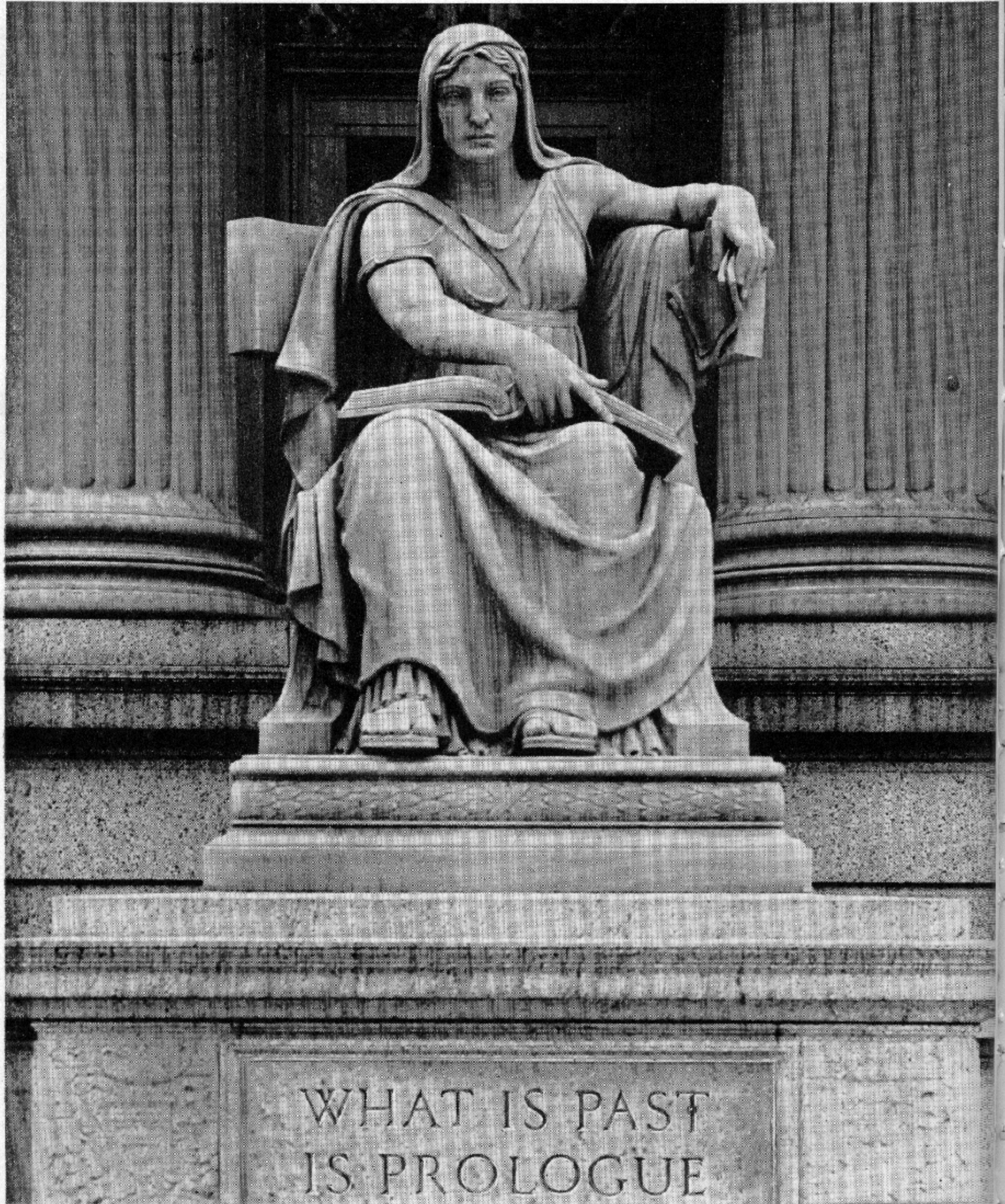

Statue at the Entrance to National Archives Building, Washington, D. C.



## CONCLUSION

It was indeed an eventful day when man stepped from the path of his upward climb for the purpose of starting war. While his travel along the road to progress has been notable, he has found occasion to pause more times than civilization would care to admit, in order to seize, save, or sanctify those things of his neighbor which he deemed worthy of the effort.

The improvements in methods of transportation, communication, medicine, and divers other things are of such vast proportions that they seem magical in comparison with their predecessors. The years since the advent of gunpowder have seen the replacement of the oxcart by the jet plane, the town crier by television, and snake oil by penicillin but there have been no such phenomena with respect to progress in projectile delivery.

In armament man has yet to achieve the mental capacity to replace the earliest of his discoveries, the missile weapon, first brought about by the hasty throwing of a rock. True, throughout the years, countless thousands of hours have been expended, along with sums of money, too fabulous to estimate, in an effort to break away from this mode of lethal delivery. However, the result has been only a refinement—evolutionary, but in no sense revolutionary.

# APPENDIX A

## Patents on Machine Guns and Relating Mechanisms Upon which the World's Automatic Weapons Have Been Based

The following patents granted by the United States Patent Office to American and foreign inventors cover the most important machine-gun and firing mechanisms from which have evolved the automatic weapons we know today.

The patents are listed under the inventors and the firms or individuals to whom they may have been assigned. The title, patent number, and date of patent are given for each, together with names of joint inventors and assignees, where applicable. Entries under assignees are marked with an asterisk (\*) and are cross-referenced to the names of the inventors.

### ACCELERATING FIRE ARMS CO.—NEW YORK, N.Y. (\*)

Gun, Accelerating 200,740 26 Feb 1878 (Lyman)

### ACCLES, JAMES G.—MIDDLESEX, ENGLAND

Machine gun 426,356 22 Apr 1890

Feeder for machine gun 290,622 18 Dec 1883 (Assigned to Gatling Gun Co.)

### ADAMSON, KEITH F.—FORT BRAGG, N.C.

Automatic gun 1,648,469 8 Nov 1927 (Adamson & Stambaugh)

### ADST, FRANK W.—ST. PAUL, MINN.

Machine gun 1,313,038 12 Aug 1919

### AGNELLI, GIOVANNI—TURIN, ITALY

Firearm, Automatic 1,187,957 20 June 1916

### AKTIEBOLAGET J. C. LJUNGMAN—MAIMO, SWEDEN (\*)

Disconnecter means in self-charging firearms 2,390,061  
4 Dec 1945 (Eklund)

### AKTIEBOLAGET AUTOMATGEVAR—STOCKHOLM, SWEDEN (\*)

Firearm, Automatic 680,488 13 Aug 1901 (Kjellman & Andersson)

Firearm, Automatic 690,739 7 Jan 1902 (Kjellman & Andersson)

### AKTIEBOLAGET STOCKHOLMS VAPENFABRIK—STOCKHOLM, SWEDEN (\*)

Firearm, Recoil-operated 765,491 19 Jan 1904 (Kjellman)

Firearm, Automatic 738,140 1 Sep 1903 (Friberg)

Firearm, Automatic 814,547 6 Mar 1906 (Kjellman)

Firearm, Automatic 1,040,692 8 Oct 1912 (Kjellman)

### ALDRICH, WALES—CLEVELAND, OHIO

Firearm, firing pin & extractor (breech loading) 38,455  
12 May 1863

### ALESSI, FEDERICO—NEW YORK, N.Y.

Gun, Machine 672,690 23 Apr 1901

Gun, Machine 683,240 24 Sep 1901

### ALEXANDER, ALBERT M.—HAVRE DE GRACE, MD.

Automatic firearm feed mechanism 2,436,370 24 Feb 1948

### ALIEN PROPERTY CUSTODIAN (\*)

Automatic or repeating firearm 2,325,484 27 Jul 1943  
(Kivaly & Koucher)

Firing mechanism for automatic firearm 2,356,615 22 Aug  
1944 (Revelli)

Automatic shoulder firearm adapted for use in a carriage  
2,376,726 22 May 1945 (Rossmanith)

### ALLENDER, HENRY—DETROIT, MICH.

Gun, Machine 323,997 11 Aug 1885

Gun, Machine 372,191 25 Oct 1887

### AMERICAN & BRITISH MFG. CO. (\*)

Automatic gun 851,196 23 Apr 1907 (Bevans & Bartholmes)

### AMERICAN MACHINE & ORDNANCE CO. (\*)

Automatic gun 851,196 23 Apr 1907 (Bevans & Bartholmes)

### AMERICAN PAPER GOODS CO.—KENSINGTON, CONN. (\*)

Cartridge, Belt 1,341,111 25 May 1920 (Cooley)

### ANDERSON, EDWARD WILLIAM—WITTON, ENGLAND

Gun, Automatic 671,062 2 Apr 1901

### ANDERSON, LOUIS A.—DAYTON, OHIO

Bolt mechanism 2,503,575 11 Apr 1950 (Anderson & Pearson)  
(Assigned to General Motors Corp.)

### ANDERSSON, GUSTAV L.—STOCKHOLM, SWEDEN

Firearm, Automatic 680,488 13 Aug 1901 (Kjellman & Andersson)  
(Assigned to Aktiebolaget Automatgevar)

Firearm, Automatic 690,739 7 Jan 1902 (Kjellman & Andersson)  
(Assigned to same)

### ANDREWS, JOEL W.—NORRISTOWN, PA.

Gun & bayonet batteries, Improvement in 33,731 19 Nov  
1861

### ANDRUS, GEORGE P.—ABERDEEN, WASH.

Bombing gun for aircraft 1,636,451 19 Jul 1927

- ANSLEY H. FOX CO.—PHILADELPHIA, PA.**  
 Gas-operated machine gun 1,293,396 4 Feb 1919 (Fox)  
 Gas-operated automatic machine gun 1,294,892 18 Feb 1919 (Fox & Rice)  
 Gun, Machine 1,388,856 30 Aug 1921 (Fox)
- ARCHBOLD, ISRAEL N.—RIDGE FARM, ILL.**  
 Gun, Machine 476,590 7 Jun 1892
- ARMAMENTI MILITARI S. A.—TURIN, ITALY (\*)**  
 Automatic firearm 1,759,277 20 May 1930 (Revelli)
- ARMIT, ROBERT H.—LONDON, ENGLAND**  
 Gun, Machine 446,807 17 Feb 1891 (Assigned to T. McCulloch)
- ARMSTRONG, WHITWORTH & CO. LTD.—NEWCASTLE-ON-TYNE, ENGLAND**  
 Gun, Automatic 702,240 10 Jun 1902 (Noble)
- ARTER, JOHN J. B.—BIRMINGHAM, ENGLAND**  
 Machine gun, Anti-aircraft & other 1,334,983 30 Mar 1920
- AUTO-ORDNANCE CORP.—NEW YORK, N.Y. (\*)**  
 Automatic gun 1,396,949 15 Nov 1921 (Eickhoff)  
 Automatic gun 1,425,810 15 Aug 1922 (Thompson)  
 Automatic gun 2,053,489 8 Sep 1936 (Norman)
- AUTOMATGEVAR, AKTIEBOLAGET—See AKTIEBOLAGET AUTOMATGEVAR.**
- AUTOMATIC ARMS CO.—CLEVELAND, O. & BUFFALO, N.Y. (\*)**  
 Gun, Gas-operated 1,003,632 1 Sep 1911 (McClellan)  
 Gun, Gas-operated machine 1,005,263 10 Oct 1911 (McClellan)  
 Automatic machine gun 1,042,135 22 Oct 1912 (McClellan)  
 Breech-loading & discharge-actuated firearm 1,042,363 22 Oct 1912 (McClellan)  
 Gas regulator & trap for gas-operated firearm 1,195,693 22 Aug 1916 (Lewis)
- AUTOYRE CO.—OAKVILLE, CONN. (\*)**  
 Cartridge belt link 2,423,346 1 Jul 1947 (Ryan)  
 Cartridge feeding mechanism 2,501,143 21 Mar 1950 (Sanford)  
 Feeding mechanism for automatic guns 2,502,891 4 Apr 1950 (Sanford)
- BAILEY, FORTUNE L.—INDIANAPOLIS, IND.**  
 Gun, Machine 206,852 13 Aug 1878 (Assigned to Bailey Gun Co.)  
 Guns, Improvement in machine 173,752 22 Feb 1876  
 Improvements in machine guns 173,751 22 Feb 1876
- BAILEY GUN CO.—INDIANAPOLIS, IND. (\*)**  
 Gun, Machine 206,852 13 Aug 1878 (Bailey)
- BAILEY, OLIVER J.—FLORENCE, MASS.**  
 Silencer for firearms 1,207,264 5 Dec 1916
- BALL, ALBERT—WORCESTER, MASS.**  
 Firearms, Self-loading 38,935 23 Jun 1863
- BANGERTER, FRIEDRICH—NEW YORK, N.Y.**  
 Automatic rapid-fire machine gun 1,424,751 8 Aug 1922
- BARDELLI, ARTURO—MILAN, ITALY**  
 Firearm, Automatic 1,355,378 12 Oct 1920  
 Firearm, Automatic 1,425,627 15 Aug 1922
- BARNES, CHARLES EMERSON—LOWELL, MASS.**  
 Cannon, Improved automatic 15,315 8 Jul 1856 (Assigned to self and M. W. Oliver)
- BARNES, CHARLES H.—ILION, N.Y.**  
 Firearm, Automatic 1,089,621 10 Mar 1914
- BARRETT, J. B.—WYTHE COUNTY, VA. (\*)**  
 Improvements in repeating cannon 110,233 20 Dec 1870 (Hedrick)
- BARROS, JOSE DE—IMPERIAL, CALIF. (\*)**  
 Rapid-fire gun 1,285,765 26 Nov 1918 (Martin)
- BARRY, MACK CARLTON—ATLANTA, GA.**  
 Rapid-fire gun 1,233,165 10 Jul 1917
- BARTHOLMESS, CHARLES W.—ILION, N.Y.**  
 Automatic gun 851,196 23 Apr 1907 (Bevans & Bartholmess)
- BATCHELDER, FRANK R.—WORCESTER, MASS.**  
 Machine gun belt 1,243,686 23 Oct 1917 (Assigned to Universal Patents Co.)
- BAUMWART, GABRIEL W.—GARDEN CITY, N.Y.**  
 Automatic locking ammunition container 2,506,409 2 May 1950 (Assigned to Republic Aviation Corp.)
- BAXTER, JOHN—KNOXVILLE, TENN. (\*)**  
 Gun, Machine 296,365 23 Jul 1878 (Taylor)  
 Guns, Improvement in machine 174,872 14 Mar 1876 (Taylor)  
 Guns, Improvement in machine 174,873 14 Mar 1876 (Taylor)  
 Guns, Improvement in machine 177,030 2 May 1876 (Taylor)
- BECK, MICHAEL—MINNEAPOLIS, MINN.**  
 Gun, Automatic magazine 645,932 27 Mar 1900 (Beck & Ferrant)
- BECKER, REINHOLD—KREFELD, GERMANY**  
 Automatic firearm 1,144,285 22 June 1915
- BEEBE, FRANK N.—COLUMBUS, OHIO**  
 Extractor, Spring 230,224 20 Jul 1880
- BEECHER, EBENEZER B.—NEW HAVEN, CONN. (\*)**  
 Gun, Machine 430,206 17 Jun 1890 (Garland)  
 Gun, Machine 479,799 2 Aug 1892 (Garland)  
 Automatic mechanism for machine guns 636,974 14 Nov 1899 (Garland)  
 Gun, Automatic machine 643,118 13 Feb 1900 (Garland)
- BELL, DAVITT S.—PITTSBURGH, PA.**  
 Automatic gun 2,370,835 6 Mar 1945 (Bell & Wilkander) (Assigned to Edgewater Steel Co.)  
 Automatic gun 2,395,211 19 Feb 1946 (Bell & Wilkander) (Assigned to same firm)

- BENDIX AVIATION CORP.—SOUTH BEND, IND. (\*)**  
 Gun-feed mechanism 2,379,185 26 Jun 1945 (Reek)  
 Automatic gun charger 2,410,767 5 Nov 1946 (Wisman & Rolin)  
 Gun-charging mechanism 2,413,104 24 Dec 1946 (Goepf-  
 rich)
- BENEDICTIS, CAMILLO D.—PHILADELPHIA, PA. (\*)**  
 Gas-operated firearm 630,136 1 Aug 1899 (Travaglini)
- BENET, LAURENCE V.—PARIS, FRANCE**  
 Gun, Automatic machine 564,043 14 Jul 1896 (Benét &  
 Mercié) (Assigned to Hotchkiss Ordnance Co., Ltd.)  
 Gun, Gas-operated 588,380 17 Aug 1897 (Benét & Mercié)  
 (Assigned to same)  
 Gun, Gas-operated 606,115 21 Jun 1898  
 Gun, Semi-automatic 649,393 8 May 1900 (Benét &  
 Mercié)  
 Gun, Automatic 696,306 25 Mar 1902 (Benét & Mercié)  
 Gun, Gas-operated 861,939 30 Jun 1907 (Benét & Mercié)  
 Feed apparatus for automatic guns 958,078 17 May 1910  
 Rifle, Automatic shoulder 1,125,937 26 Jan 1915 (Benét  
 & Mercié)  
 Gun, Semi-automatic 852,253 30 Apr 1907 (Benét &  
 Mercié)  
 Firing sear, Automatic 854,253 21 May 1907 (Benét &  
 Mercié)
- BENNETT, THOMAS G.—NEW HAVEN, CONN.**  
 Automatic firearm 695,784 18 Mar 1902 (Bennett &  
 Mason) (Assigned to Winchester Repeating Arms Co.)
- BERGMANN, THEODOR EMIL—ROTENFELS, GERMANY**  
 Automatic firearm 2,072,197 2 Mar 1937
- BERGMANN, THEODOR—SUHL, GERMANY (\*)**  
 Firearm, Recoil-operated 547,451 8 Oct 1895 (Schmeisser)  
 Machine pistol 1,450,834 3 Apr 1923 (Schmeisser)
- BERTHIER, ANDRE VIRGILE PAUL MARIE—PARIS, FRANCE**  
 Gun, Automatic 918,646 20 Apr 1909  
 Firearms, Cooling device for 1,017,373 13 Feb 1912  
 Gun, Gas-operated 1,082,916 30 Dec 1913  
 Gun, Machine 1,144,994 6 Jul 1915
- BERTRAN, EDWARD M.—JACKSON HEIGHTS, N.Y.**  
 Gun, Ammunition magazine 2,364,510 5 Dec 1933 (Ber-  
 tran & Lesnick) (Assigned to Brewster Aeronautical Corp.)
- BEVANS, W. H.—BRIDGEPORT, CONN.**  
 Gun, Automatic 851,196 23 Apr 1907 (Bevans & Bar-  
 tholmes) (Assigned to American & British Manuf. Co. &  
 American Machine & Ordnance Co.)  
 Electric & percussion firing mechanism 855,427 28 May  
 1907
- BICKART, M.L.—ATLANTA, GA.**  
 Gun, Machine 664,952 1 Jan 1901 (2/3 assigned to Black-  
 burn & Spilman)
- BILLINGHURST, WILLIAM—ROCHESTER, N.Y.**  
 Improvement in platoon batteries 36,448 16 Sep 1862  
 (Billinghurst & Requa)
- BIRKIGT, LOUIS—BOIS-COLOMBES, FRANCE**  
 Tripping device 1,993,645 5 Mar 1935  
 Mechanism for the tripping or release of movable organs  
 2,040,197 12 May 1936
- BIRKIGT, MARC—BOIS-COLOMBES, FRANCE**  
 Combined gun and engine for aerial machines 1,319,510  
 21 Oct 1919  
 Magazine for the automatic feeding of objects 2,011,889  
 20 Aug 1935  
 Aircraft provided with a gun 2,014,876 17 Sep 1935  
 Aircraft engine and gun assembly 2,020,872 12 Nov 1935  
 Aircraft engine and gun assembly 2,053,691 8 Sep 1936  
 Machine provided with an automatic firearm 2,075,086 30  
 Mar 1937  
 Airplane provided with an automatic firearm 2,075,087 30  
 Mar 1937  
 Automatic firearm 2,159,126 23 May 1939  
 Automatic firearm 2,159,127 23 May 1939  
 Detent mechanism 2,179,914 14 Nov 1939  
 Automatic firearm 2,199,871 7 May 1940  
 Automatic firearm 2,199,872 7 May 1940  
 Firearm of the recoiling type 2,291,867 4 Aug 1942
- BIRMINGHAM SMALL ARMS CO., LTD.—BIRMINGHAM, ENGLAND (\*)**  
 Firearm, Automatic 1,637,234 26 Jul 1927 (Norman)  
 Firearm, Automatic 1,637,235 26 Jul 1927 (Norman)
- BJORGUM, NILS—ASKER, NORWAY**  
 Automatic firearm 1,007,911 7 Nov 1911
- BLACKER, L. V. S.—LONDON, ENGLAND**  
 Machine gun & small arm 1,856,022 26 Apr 1932
- BLACKBURN, B. M.—ATLANTA, GA. (\*)**  
 Machine gun 664,952 1 Jan 1901 (Jeter)
- BLICKENSERFER, GEORGE C.—STAMFORD, CONN.**  
 Attachment for automatic guns 1,290,828 7 Jan 1919
- BOEGER, JOSEPH—DRESDEN, KANS.**  
 Machine gun 800,062 19 Sep 1905
- BOCHNAK, ANDREW—BOBTOWN, PA.**  
 Machine gun 2,024,125 10 Dec 1935
- BOGDONOV, ANTON—ALTOONA, PA. (\*)**  
 Antiaircraft machine gun 1,443,249 23 Jan 1923 (Dupcza)
- BOMINGHAUS, FRANZ—ESSEN-ON-THE-RUHR, GERMANY**  
 Recoil gun 923,051 25 May 1909 (Lambur & Boming-  
 haus) (Assigned to Fried. Krupp A. G.)
- BONHAM, JOHN L.—HELLEN, PA.**  
 Improvement in revolving ordnance 36,555 30 Sep 1862
- BORCHARDT, HUGO—CHARLOTTENBURG, GERMANY**  
 Trigger mechanism for automatic firearms 987,543 21 Mar  
 1911  
 Cartridge-ejecting device for firearms 1,009,464 21 Nov  
 1911  
 Breech-mechanism lock for automatic firearms 1,071,023  
 26 Aug 1913  
 Automatic firearms with toggle joint 1,160,831 16 Nov  
 1915

- Breech mechanism for automatic firearms 1,184,065 23 May 1916  
 Hold-back device 1,196,759 5 Sep 1916
- BOTTS, ROBERT E.—BLUE EARTH, MINN.**  
 Buffer spring assembly for automatic firearms 2,504,958 25 Apr 1950 (Botts & Young)
- BOURDELLES, E. A. L.—ST. DENIS, FRANCE**  
 Automatic firearm 1,382,058 21 Jun 1921 (Assigned to Société Anonyme des Etablissements Delaunay)  
 Machine gun 1,402,564 3 Jan 1922 (Assigned to same firm)
- BOURNE, ROLAND B.—WEST HARTFORD, CONN.**  
 Gun silencer 2,375,617 8 May 1945 (Assigned to Maxim Silencer Co.)
- BOUSSEL, ANDRE—COURBEVOIE, FRANCE**  
 Automatic firearm 2,108,026 8 Feb 1938 (Sutter & Bous- sel) (Assigned to Société Anonyme des Anciens Et. Hotchkiss & Cie.)
- BOWMAN, MARK H.—PINKSTAFF, ILL.**  
 Machine gun 662,761 27 Nov 1900 (Hughes & Bowman)
- BRADY, FREEMAN, JR.—WASHINGTON, PA.**  
 Gun, Magazine 34,126 14 Jan 1862 (Brady & Noble)
- BRAND, CHRISTOPHER C.—NORWICH, CONN.**  
 Revolving firearm 38,279 28 Apr 1863
- BRAUNING, KARL A.—HERSTALL, BELGIUM**  
 Automatic firearm with fixed barrel and breech action 1,020,596 19 Mar 1912  
 Firing mechanism for automatic firearms 1,073,588 23 Sep 1913  
 Firearm, Automatic 1,350,543 24 Aug 1920  
 Automatic firearm 1,411,473 4 Apr 1922
- BREDA—See SOCIETA ITALIANA ERNESTO BREDA**
- BREHM, EDUARD—JERSEY CITY, N.J.**  
 Improvement in revolving cannons 110,194 20 Dec 1870
- BRETT, JAMES—MATTEAWAN, N.Y.**  
 Gun batteries, Many barrels 42,552 3 May 1864
- BREVETS AERO-MECHANIQUES S. A.—GENEVA, SWITZERLAND (\*)**  
 Gas piston operated firearm 2,494,889 17 Jan 1950 (Maillard)  
 Ammunition charging device for automatic arms 2,503,116 4 Apr 1950 (Maillard)  
 Pivoted breech bolt lock 2,522,628 19 Sept 1950 (Mail- lard)
- BREWSTER AERONAUTICAL CORP.—NEW YORK, N.Y. (\*)**  
 Gun, Ammunition magazine 2,364,510 5 Dec 1944 (Ber- tran & Lesnick)
- BRISTOL, MORTIMER L.—WEST HARTFORD, CONN.**  
 Gun, Automatic 862,384 6 Aug 1907 (Assigned to Colt's Patent Firearms Mfg. Co.)
- BRISTOL AEROPLANE CO., LTD.—BRISTOL, ENGLAND (\*)**  
 Ammunition feed mechanism for machine guns 2,521,346 5 Sep 1950 (d'Assis-Fonseca)
- BRODERICK, CLEMENT M.—HARTFORD, CONN.**  
 Machine gun 504,517 5 Feb 1893 (Broderick & Vankiers- bilck) (Assigned to Gatling Gun Co.)  
 Feed for machine guns 504,516 5 Sep 1893 (Broderick & Vankiersbilck) (Assigned as above)
- BRONDBY, FRIDTJOF N.—OSLO, NORWAY**  
 Gas-operated firearm, Automatic 2,223,671 3 Dec 1940
- BROTHERSTON, ALEXANDER M.—MONCTON, NEW BRUNSWICK**  
 Machine gun 1,216,938 20 Feb 1917 (1/2 assigned to Holmes)  
 Apparatus for cooling gun barrels 1,216,939 20 Feb 1917
- BROWN, AARON A.—RAWLINS, WYO. (\*)**  
 Automatic gun 718,062 8 Jan 1903 (Weed)
- BROWN, CHARLES W.—INDIANOLA, IOWA**  
 Machine gun 1,401,667 27 Dec 1921
- BROWN, JOHN F.—CASA GRANDE, ARIZ. (\*)**  
 Automatic rifle 1,398,452 29 Nov 1921 (Wagon)
- BROWN, JOHN L.—MOMENCE, ILL.**  
 Gun silencer & scavenger 2,208,093 16 Jul 1940
- BROWN, M. W.—TRENTON, N.J.**  
 Automatic rifle 966,995 9 Aug 1910
- BROWN, RICHARD J. W.—LONDON, ENGLAND**  
 Breech mechanism for automatic recoil-operated guns 1,021,130 26 Mar 1912
- BROWNING Co., J. M. & M. S.—OGDEN, UTAH (\*)**  
 Gas-operated automatic firearm 2,093,706 21 Sep 1937 (Marriner Browning)  
 Automatic firearm 2,039,705 21 Sep 1937 (Marriner Browning)  
 Automatic firearm 2,039,704 21 Sep 1937 (Marriner Browning)  
 Firing mechanism for automatic firearms 2,116,140 3 May 1938 (Marriner Browning)  
 Firing mechanism for automatic firearms 2,116,139 3 May 1938 (Marriner Browning)  
 Firing mechanism for automatic firearms 2,093,707 21 Sep 1937 (Marriner Browning)  
 Gas-operated automatic firearm 2,116,141 3 May 1938 (Marriner Browning)  
 Firing mechanism for repeating firearms 2,385,057 18 Sep 1945 (Val A. Browning)
- BROWNING, JOHN M.—OGDEN, UTAH**  
 Machine gun 471,783 29 Mar 1892 (John & Matthew Browning)  
 Machine gun 471,784 29 Mar 1892 (John & Matthew Browning)  
 Gun, Gas-operated breech-loaded 502,549 1 Aug 1893  
 Gas-operated machine gun 544,657 20 Aug 1895  
 Gas-operated machine gun 544,658 20 Aug 1895

Gas-operated machine gun 544,659 20 Aug 1895  
 Gun, Gas-operated breech-loaded 544,660 20 Aug 1895  
 (John & Matthew Browning)  
 Gun, Gas-operated 544,661 20 Aug 1895  
 Gas-operated firearm 621,747 21 Mar 1899  
 Recoil-operated firearm 659,507 9 Oct 1900  
 Recoil-operated firearm 659,786 16 Oct 1900  
 Gun, Automatic 678,937 23 Jul 1901  
 Automatic firearm 689,283 17 Dec 1901  
 Recoil-operated firearm 701,288 3 Jun 1902  
 Automatic firearm 708,794 9 Sep 1902  
 Automatic firearm 747,585 22 Dec 1903  
 Automatic firearm 853,438 14 May 1907  
 Recoil-operated firearm 981,263 11 Feb 1911  
 Automatic machine gun 1,293,021 4 Feb 1919  
 Automatic machine rifle 1,293,022 4 Feb 1919  
 Automatic firearm 1,511,262 14 Oct 1924  
 Automatic firearm 1,525,065 3 Feb 1925  
 Automatic firearm 1,525,066 3 Feb 1925  
 Cartridge-feeding device for firearms 1,525,067 3 Feb 1925  
 Recoil buffer for automatic guns 1,548,708 4 Aug 1925  
 Automatic firearm 1,618,510 22 Feb 1927  
 Automatic firearm 1,628,226 10 May 1927  
 Cartridge feeding mechanism for automatic firearm  
 1,629,652 24 May 1927

## BROWNING, MARRINER A.—OGDEN, UTAH

Gas-operated automatic firearm 2,093,706 21 Sep 1937  
 (Assigned to Browning Co.)  
 Automatic firearm 2,093,705 21 Sep 1937 (Assigned to  
 same)  
 Automatic firearm 2,093,704 21 Sep 1937 (Assigned to  
 same)  
 Firing mechanism for automatic firearm 2,116,140 3 May  
 1938 (Assigned to same)  
 Firing mechanism for automatic firearm 2,093,707 21 Sep  
 1937 (Assigned to same)  
 Gas-operated automatic firearm 2,116,141 3 May 1938  
 (Assigned to same)

## BROWNING, MATTHEW S.—OGDEN, UTAH

Machine gun 471,783 29 Mar 1892 (John M. & Matthew  
 Browning)  
 Machine gun 471,784 29 Mar 1892 (John M. & Matthew  
 Browning)  
 Gas-operated breech-loading gun 544,660 20 Aug 1895  
 (John & Matthew Browning)

## BROWNING, JONATHAN E.—OGDEN, UTAH

Gas-operated firearm 2,211,405 13 Aug 1940 (Assigned  
 to Western Cartridge Co.)  
 Gas-operated automatic firearm 2,252,754 19 Aug 1941  
 (Assigned to same)

## BROWNING, VAL A.—OGDEN, UTAH

Firing mechanism for repeating firearms 2,385,057 18 Sep  
 1945 (Assigned to Browning Co.)

## BRUCE, LUCIEN F.—SPRINGFIELD, MASS.

Cartridge charger for machine gun feeders 341,371 4 May  
 1886 (Assigned to Gatling Gun Co.)

Cartridge feeder for machine gun 343,532 8 Jun 1886  
 (Assigned to same)

Cartridge feeder for machine guns 351,960 2 Nov 1886

## BUCK, EDWARD R.—WINDSOR, VT. (\*)

Automatic magazine firearm 900,965 13 Oct 1908 (C. W.  
 Louis)

## BUCKHAM, GEORGE THOMAS—LONDON, ENGLAND

Gun, Automatic or other machine 687,130 19 Nov 1901  
 (Dawson & Buckham) (Assigned to Vickers Sons &  
 Maxim, Ltd.)  
 Automatic gun 909,849 12 Jan 1909 (Dawson & Buck-  
 ham) (Assigned to same)  
 Automatic gun 920,832 4 May 1909 (Dawson & Buck-  
 ham) (Assigned to same)  
 Automatic gun 942,167 7 Dec 1909 (Dawson & Buck-  
 ham) (Assigned to same)  
 Cartridge-feed mechanism for Maxim guns 951,999 15  
 Mar 1910 (Assigned to same)  
 Automatic gun 926,052 22 Jun 1909 (Dawson & Buck-  
 ham) (Assigned to same)  
 Cartridge feed mechanism for automatic guns 1,091,640  
 31 Mar 1914 (Assigned to same)  
 Automatic gun 1,077,680 4 Nov 1913 (Assigned to same)  
 Automatic gun 1,262,196 9 Apr 1918 (Assigned to same)  
 Automatic gun 1,262,181 9 Apr 1918 (Dawson & Buck-  
 man) (Assigned to same)  
 Machine gun 1,312,105 5 Aug 1919 (Dawson & Buckham)  
 (Assigned to same)  
 Machine gun 1,314,734 2 Sep 1919 (Dawson & Buckham)  
 (Assigned to same)  
 Machine gun 1,327,086 6 Jan 1920 (Dawson & Buckham)  
 (Assigned to same)  
 Machine gun 1,453,974 1 May 1923 (Dawson, Buckham  
 & Haskell) (Assigned to same)  
 Automatic gun 1,468,262 18 Sep 1923 (Dawson, Buckham  
 & Larson) (Assigned to same)  
 Machine gun 1,456,625 29 May 1923 (Dawson & Buck-  
 ham) (Assigned to same)  
 Articulated link for the cartridge belts for machine guns  
 1,550,787 25 Aug 1925 (Dawson, Buckham & Larsson)  
 Automatic gun 1,553,992 15 Sep 1925 (Dawson, Buck-  
 ham & Larsson)

## BULL, WILLIAM R.—SPRINGFIELD, MASS.

Method of and apparatus for cooling gun barrels 1,631,190  
 7 Jun 1927  
 Machine gun 2,108,817 22 Feb 1938 (Hoppert, Bull &  
 Simpson)

## BULLARD, HERBERT A.—SAN FRANCISCO, CALIF.

Centrifugal gun 1,311,492 29 July 1919 (Assigned to In-  
 tercontinental Co.)

## BURCESS, ANDREW—BUFFALO, N.Y.

Automatic firearm magazine 557,359 31 Mar 1896  
 Gas-operated firearm 589,120 31 Aug 1897  
 Recoil-operated magazine gun 520,753 29 May 1894  
 Automatic gun 636,196 31 Oct 1899 (Assigned to Win-  
 chester Repeating Arms Co.)  
 Automatic firearm 663,954 18 Dec 1900

- Automatic firearm 663,955 18 Dec 1900  
 Automatic firearm 663,956 18 Dec 1900  
 Automatic gun 666,081 15 Jan 1901  
 Automatic gun 687,448 26 Nov 1901  
 Automatic gun 693,105 11 Feb 1902  
 Automatic gun 693,106 11 Feb 1902  
 Automatic gun 715,971 16 Dec 1902  
 Automatic gun 821,922 29 May 1906  
 Automatic gun 822,851 5 June 1906  
 Recoil-operated firearm 591,525 12 Oct 1897  
 Recoil-operated firearm 520,752 29 May 1894 (Assigned to Burgess Gun Co.)
- BURGESS GUN CO.—NEW YORK, N.Y. (\*)**  
 Recoil-operated firearm 520,752 29 May 1894 (Burgess)
- BURGESS, WILLIAM STARLING—BROOKLINE, MASS.**  
 Recoil-operated gun 591,155 5 Oct 1897
- BURK, PAUL W.—WASHINGTON, D.C.**  
 Machine gun 2,453,830 16 Nov 1948 (Chadwick & Burk)
- BURNEY, CHARLES D.—BAYNARDS PARK, ENGLAND**  
 Magazine loaded recoilless gun 2,503,578 11 Apr 1950
- BURTON, BETHEL—LONDON, ENGLAND**  
 Automatic machine gun 390,114 25 Sep 1888
- BURTON, FRANK F.—SHORT BEACH, CONN.**  
 Gun with recoiling barrel 941,006 23 Nov 1909 (Assigned to Winchester Repeating Arms Co.)  
 Cartridge-ejecting mechanism for firearms 2,101,236 7 Dec 1937 (Assigned to same)
- BUSKIRK, THOMAS B.—PAOLI, IND. (\*)**  
 Machine gun 547,717 8 Oct 1895 (Dougherty)  
 Self-acting breech-loading gun 529,521 20 Nov 1894 (Dougherty)
- BYE, MARTIN—WORCESTER, MASS.**  
 Recoil-operated firearm 812,015 6 Feb 1906 (Assigned to Harrington and Richardson Arms Co.)
- CAMPBELL, THOMAS J.—LINCOLN, NEBR.**  
 Improvement in automatic revolving ordnance 35,504 10 Jun 1862
- CANET, JEAN B. G. A.—LE CREUSOT, FRANCE**  
 Recoil apparatus for guns 713,691 18 Nov 1902 (Schneider & Canet)
- CANTILEY, JOSEPH C.—BEVERLY, MASS.**  
 Automatic firearm 2,409,251 15 Oct 1946 (Assigned to United Shoe Machinery Corp.)
- CAPALDO, FRANCESCO—NAPLES, ITALY**  
 Machine gun 1,371,351 15 Mar 1921 (Casseta & Capaldo)
- CAPELL, WILLIAM H.—HAMPTON, VA.**  
 Aircraft machine gun installation 1,907,342 2 May 1933
- CAPALUPO, VINCENZO—E. BOSTON, MASS.**  
 Automatic firearm 1,639,425 16 Aug 1927
- CARL, JOHN HOWARD—GILROY, CALIF.**  
 Automatic firearm 1,118,330 24 Nov 1914  
 Automatic firearm 1,118,331 24 Nov 1914
- CARPENTER, JOHN H.—PICABO, IDAHO (\*)**  
 Recoil-operated firearm 1,078,224 11 Nov 1913 (Taylor)
- CARR, HOWARD—SAN FRANCISCO, CALIF.**  
 Recoil-operated firearm 574,189 29 Dec 1896 (Assigned to San Francisco Arms Co.)  
 Recoil-operated firearm 584,153 8 Jun 1897 (Assigned to same)
- CARRILLO, LEOPIDO A.—BIG WELLS, TEX.**  
 Machine gun 2,004,925 18 Jun 1935
- CARVEN, HARRY—PITTSFIELD, ILL.**  
 Gun silencer 984,750 21 Feb 1911
- CASSETTA, VINCENZO—NAPLES, ITALY**  
 Machine gun 1,371,351 15 Mar 1921 (Casseta & Capaldo)
- CASTELLI, VITTORIO—BRESCIA, ITALY**  
 Cartridge-fed device for automatic firearms 1,611,289 21 Dec 1926 (Soncini & Castelli)  
 Automatic firearm with recoiling barrel 1,613,205 4 Jan 1927 (Soncini & Castelli)
- CATLIN, ROBERT M.—TUSCARORA, NEV.**  
 Recoil-operated firearm 574,350 29 Dec 1896 (Assigned to San Francisco Arms Co.)  
 Recoil-operated magazine gun 454,993 30 Jun 1891
- CAYLOR, HENRY M.—NOBLESVILLE, IND. (\*)**  
 Machine gun 458,268 25 Aug 1891 (Cook)
- CECERO, RALPH S.—WATERBURY, CONN.**  
 Machine gun, Automatic 1,595,993 17 Aug 1926
- CEDILLO, NICASIO—HOUSTON, TEX.**  
 Recoil-operated firearm 1,453,439 1 May 1923 (Assigned to Reed, C. E.)
- CENTRIFUGAL GUN CORP.—MATTAPAN, MASS. (\*)**  
 Centrifugal gun 1,420,660 27 Jun 1922 (Lombard)
- ČESKOSLOVENSKÁ ZBRŮJOVKA AKČIOVÁ-SPOLEČNOST V. BRNE—BRUNN, CZECHOSLOVAKIA (\*)**  
 Gas-pressure regulating device for firearms 1,802,816 28 Apr 1931 (Holek, E.)  
 Automatic firearm 1,906,800 2 May 1933 (Marek)  
 Automatic firearm 2,115,526 26 Apr 1938 (Holek, V.)  
 Automatic firearm 2,223,004 26 Nov 1940 (Holek, V.)  
 Automatic firearm in particular machine guns 2,093,169 14 Sep 1937 (Holek, V.)  
 Self-loading firearm 1,960,913 29 May 1934 (Marek)  
 Automatic firearm 2,146,185 7 Feb 1939 (Holek, V.)  
 Automatic firearm 2,267,501 23 Dec 1941 (Holek, V.)  
 Automatic gun 1,926,816 12 Sep 1933 (Podrabsky)
- CHADWICK, GEORGE A.—WASHINGTON, D.C.**  
 Machine gun 2,453,830 16 Nov 1948 (Chadwick & Burk)
- CHAFFEE, REUBEN S.—SPRINGFIELD, ILL.**  
 Feed mechanism for breech-loading firearms 314,515 24 Mar 1885

## CHALLENGER, GEORGE H.—WESTMINSTER, ENGLAND

Bullet deflector for the propellers of aeroplane and similar aircraft provided with guns 1,298,886 1 Apr 1919 (Assigned to Vickers, Ltd.)

Automatic gun 1,298,887 1 Apr 1919 (Challenger & Savage) (Assigned to same)

## CHANDLER, EDWARD F.—BROOKLYN, N.Y.

Self-propelled projectile 2,391,865 1 Jan 1946

## CHAPMAN, THOMAS O.—GLENDALE, CALIF.

Firing mechanism for rifles 2,441,029 4 May 1948 (Nyvall & Chapman)

## CHEVALLIER, ARNOLD LOUIS—LONDON, ENGLAND

Automatic firearm 1,454,039 8 May 1923

## CHILDRESS, GEORGE F.—WILLS POINT, TEX.

Gun muffler 953,943 5 Apr 1910

## CHRISTOPHE, LOUIS—BRUSSELS, BELGIUM

Machine gun 121,277 28 Nov 1871 (Montigny)

## CLADWELL, THOMAS F.—RICHMOND, AUSTRALIA

Quick-firing machine gun 1,090,124 10 Mar 1914

## CLARK, ALFRED L.—DUBUQUE, IOWA

Machine gun 1,169,237 25 Jan 1916

## CLARK, WILLIAM R.—SEATTLE, WASH.

Gas-operated gun 1,308,016 24 June 1919 (Assigned 1/2 to Martin, William.)

## CLARUS, BRUNO—LUTTICH, BELGIUM

Recoil-operated firearm 898,038 8 Sep 1909

## CLAUSIUS, CLAUS H. R.—HAMBURG, GERMANY

Firearm, Recoil-operated 593,835 16 Nov 1897

## CLEMENT, CHARLES P.—LIEGE, BELGIUM

Automatic firearm 976,122 15 Nov 1910

## COBB, LYMAN H.—FITCHBURG, MASS.

Automatic firearm 499,259 23 May 1911 (Assigned to Johnson, M. E.)

## COLE, CHARLES SCHNEIDER—SANDY HOOK, CONN.

Automatic firearm 1,843,916 9 Feb 1932

## COLEMAN, BENJAMIN F.—PRENTISS, MASS.

Multibarrel machine gun 2,404,277 16 Jul 1946

## COLLEONI, GIUSEPPE—NEW YORK, N.Y.

Automatic gun 960,825 7 Jun 1910

## COLONEY, MYRON—NEW HAVEN, CONN.

Machine gun 225,462 16 Mar 1880 (Assigned to J. H. McLean)

Machine gun 225,466 16 Mar 1880 (Assigned to J. H. McLean)

Machine gun 231,653 31 Aug 1880 (Assigned to J. H. McLean)

Machine gun 282,549 7 Aug 1893 (Assigned to J. H. McLean)

Magazine gun 231,652 31 Aug 1880 (Assigned to J. H. McLean)

## COLT'S PATENT FIRE ARMS MFG. CO.—HARTFORD, CONN. (\*)

Gas-operated machine gun 550,262 26 Nov 1895 (Ehbets)

Gas-operated magazine gun 570,388 27 Oct 1896 (Ehbets)

Automatic gun 862,384 6 Aug 1907 (Bristol)

Automatic machine gun 1,499,846 1 Jul 1924 (Tansley)

Magazine-feed mechanism for machine guns 1,719,126 2 Jul 1929 (Pfeiffer & Moore)

Barrel mounting for firearms 1,738,500 3 Dec 1929 (Moore)

Gas-operated automatic firearm 1,738,501 3 Dec 1929 (Moore)

Trigger mechanism for machine gun 1,738,502 3 Dec 1929 (Pfeiffer & Moore)

Speed regulator for machine guns 1,741,432 31 Dec 1929 (Pfeiffer)

Speed regulator for machine guns 1,741,534 31 Dec 1929 (Pfeiffer)

Reversible feed mechanism for machine guns 1,803,351 5 May 1931 (Pfeiffer & Moore)

Automatic firearm 1,803,349 5 May 1931 (Pfeiffer)

Firing mechanism for machine guns 1,966,592 17 Jul 1934 (Moore)

Automatic firearm 2,050,538 11 Aug 1936 (Moore)

Firing mechanism for machine guns 2,050,539 11 Aug 1936 (Moore and Tansley)

Machine gun and attachment therefor 2,061,313 17 Nov 1936 (Moore)

Machine gun 2,110,165 8 Mar 1938 (Moore)

Machine gun 2,140,809 20 Dec 1938 (Moore)

Automatic firearm 2,169,083 8 Aug 1939 (Swartz)

Firing mechanism for automatic firearms 2,335,688 30 Nov 1943 (Moore)

Automatic firearm and combined accessories 2,359,263 26 Sep 1944 (Webb)

Automatic firearm 2,375,452 8 May 1945 (Webb)

Improvement in operating machine gun 120,588 7 Nov 1871 (Kinne)

Bolt mechanism for machine guns 2,529,391 7 Nov 1950 (Hedges)

## COMPAGNIA COMMERCIALE CAPRONI—MILAN, ITALY (\*)

Gun barrel 2,238,670 15 Apr 1941 (Traversi & Pagna)

## CONDIT, WILLIAM D.—DES MOINES, IOWA (\*)

Gas-operated machine gun 784,966 14 Mar 1905 (Smith)

Recoil-operated firearm 804,984 21 Nov 1905 (Scarle)

Gas-operated automatic firearm 814,242 6 Mar 1906 (Smith)

## CONLON, THOMAS A.—SILVER SPRING, MD.

Automatic gun 2,213,953 10 Sep 1940

## CONLY, ART B. (\*)

Automatic firearm 747,073 15 Dec 1903 (Huntley)

## CONLY, J. GRIFFIN (\*)

Automatic firearm 747,073 15 Dec 1903 (Huntley)

## CONNOR, MARCUS W.—LOUISVILLE, MISS.\*

Machine gun 282,787 7 Aug 1883 (Shields)



**COOK, THOMAS R.—NOBLESVILLE, IND.**

Machine gun 458,268 25 Aug 1891 (Assigned 1/3 to Caylor)

Machine gun 560,842 26 May 1896 (Assigned 1/2 to Over)

**COOKE, CHARLES JOHN—HONG KONG, CHINA**

Non-recoil gun for aeroplanes 1,375,381 29 May 1921

Non-recoiling gun for aeroplanes 1,380,358 7 Jun 1921

**COOLEY, HENRY B.—KENSINGTON, CONN.**

Cartridge belt for machine guns 1,341,111 25 May 1920  
(Assigned to American Paper Goods Co.)

**CORNWELL, WILLIAM D.—LOUISVILLE, MISS. (\*)**

Machine gun 282,787 7 Aug 1883 (Shields)

**COULOMBE, JOSEPH C.—NORTHFIELD, VT.**

Noiseless gun 1,140,578 25 May 1915

**COUPLAND, RICHARD C.—DAYTON, OHIO**

Counting or registering apparatus for machine guns  
1,653,698 27 Dec 1927

Operating mechanism for machine guns 1,799,284 7 Apr  
1931

Bolt-operating mechanism for machine guns 1,845,242 16  
Feb 1932

Operating mechanism for machine guns 1,897,099 14 Feb  
1933 (Woody & Coupland)

Means for cooling gun barrels 2,112,144 22 Mar 1938

**COVENTRY ORDNANCE WORKS, LTD.—COVENTRY, ENGLAND (\*)**

Feed mechanism for automatic guns 1,298,091 25 Mar  
1919 (Redpath & Hellberg)

Automatic gun 1,315,329 9 Sep 1919 (Redpath)

**COX, CHARLES F.—SING SING, N.Y. (\*)**

Improvements in firearms 31,933 2 Apr 1861 (McCord)

**CRANMER, T. J.—VALLICITA, CALIF.**

Self-loading battery gun 74,994 3 Mar 1868

**CRAWFORD, SAMUEL—SHULLSBURG, WIS. (\*)**

Machine gun 14,215 5 Feb 1856 (Terrel)

**CREON, WARNANT JULIEN—HOICNEE-CHIERATTE, BELGIUM**

Automatic rifle 908,631 5 Jan 1909

**CROCKETT, HARRY L.—NEW HAVEN, CONN.**

Gas-operated self-loading firearm 2,370,233 27 Feb 1945  
(Assigned to Western Cartridge Co.)

Gas-operated self-loading firearm 2,394,986 19 Feb 1946  
(Assigned to Olin Industries, Inc.)

**CZAVRA, IGNATI—ROCHESTER, N.Y.**

Automatic gun 1,321,419 11 Nov 1919

**CZEGKA, VICTOR H.—WASHINGTON, D.C.**

Centrifugal gun 1,404,378 24 Jan 1922

**DAAM, GERRIT VAN—BUFFALO, N.Y.**

Gun heater 2,403,415 2 Jul 1946

**DANSK REKYL-RIFFEL SYNDIKAT—COPENHAGEN, DENMARK (\*)**

Automatic firearm 701,815 3 June 1902 (Rasmussen)

**DANUVIA IPARI ES' KERESKEDELMI R. T.—BUDAPEST, HUNGARY (\*)**

Gas-operated firearm 2,186,582 9 Jan 1940 (Gebauer)

**DARCHE, PAUL—PARIS, FRANCE**

Firearm, Recoil-operated 519,151 1 May 1891

**DARLINGTON, THOMAS—NEW YORK, N.Y. (\*)**

Automatic gun 954,797 12 Apr 1910 (Hammond)

Automatic gun 954,798 12 Apr 1910 (Hammond)

**DARNE, PIERRE—ST. ETIENNE, FRANCE**

Automatic firearm or machine gun 1,323,025 25 Nov 1919  
(R. & P. Darne)

**DARNE, REGIS—ST. ETIENNE, FRANCE**

Automatic firearm or machine gun 1,323,025 25 Nov 1919  
(R. & P. Darne)

Device of regulating the rate of fire in automatic firearms  
1,532,305 7 Apr 1925

Automatic firearm 1,730,269 10 Oct 1929

Automatic firearm 2,124,911 26 Jul 1938

**D'ASSIS-FONSECA, EVELYN C. M.—BRISTOL, ENGLAND**

Ammunition feed mechanism for machine guns 2,521,346  
5 Sep 1950 (Assigned to Bristol Aeroplane Co., Ltd.)

**DAVIS, CLELAND—WASHINGTON, D.C.**

Aeroplane gun 1,108,714 25 Aug 1914 (Assigned to  
Ordnance Development Co.)

Apparatus for firing projectiles from aeroplanes 1,108,715  
25 Aug 1914 (Assigned as above)

Apparatus for firing projectiles from aeroplanes 1,108,716  
25 Aug 1914

Fixed ammunition for use in aircraft 1,108,717 25 Aug  
1914 (Assigned as above)

Gun, Non-recoil 1,395,630 1 Nov 1921

Armament for aircraft 1,446,000 20 Feb 1923

**DAVIS, LOUIS, JR.—GALVESTON, TEX.**

Machine gun 1,869,738 2 Aug 1932 (Assigned to Halett,  
Dalbert & Stuckey)

**DAWSON, ARTHUR T.—WESTMINSTER, ENGLAND**

Automatic gun 1,262,181 9 Apr 1918 (Dawson & Buckham)  
(Assigned to Vickers, Ltd.)

Machine gun 1,312,106 5 Aug 1919 (Dawson & Buckham)  
(Assigned as above)

Machine gun 1,314,734 2 Sep 1919 (Dawson & Buckham)  
(Assigned as above)

Machine gun 1,327,068 6 Jan 1920 (Dawson & Buckham)  
(Assigned as above)

Machine gun 1,453,974 1 May 1923 (Dawson, Buckham  
& Haskell) (Assigned as above)

Machine gun 1,456,625 29 May 1923 (Dawson & Buckham)  
(Assigned as above)

Automatic gun 1,468,262 18 Sep 1923 (Dawson, Buckham  
& Larsson) (Assigned as above)

Links for the cartridge belts for machine guns 1,550,787  
25 Aug 1925 (Dawson, Buckham & Larsson) (Assigned  
as above)

Automatic gun 1,553,992 15 Sep 1925 (Dawson, Buckham  
& Larsson)

- DE BRAME, J. A.—NEW YORK, N.Y.  
 Improvement in breech-loading ordnance 34,025 24 Dec 1861 (Assigned to J. Gurney)  
 Improvement in revolving ordnance 34,024 24 Dec 1861
- DEGAILLE, PIERRE ALBIN—PARIS, FRANCE  
 Automatic firearm 1,059,680 22 Apr 1913 (Menteyne & Degaille)  
 Automatic firearm 981,210 10 Jan 1911 (Menteyne & Degaille)  
 Cartridge belt 1,150,435 17 Aug 1915 (Laird, Menteyne & Degaille)
- DEHM, EDWARD—FRUITA, COLO.  
 Magazine repeating firearm 841,670 22 Jan 1907
- DEKNIGHT, VICTOR P.—WASHINGTON, D.C.  
 Automatic rapid-fire gun 698,107 22 Apr 1902 (Assigned to Victor P. DeKnight Gun Co.)  
 Automatic rapid-fire gun 709,880 30 Sep 1902 (Assigned to same)  
 Rapid-fire automatic gun 709,881 30 Sep 1902 (Assigned to same)  
 Rapid-fire automatic gun 709,883 30 Sep 1902 (Assigned to same)
- DELAUNAY CO. See SOCIETE ANONYME DES ETABLISSEMENTS DELAUNAY
- DERSCHAU, ALBERT VON—EMDEN, GERMANY  
 Electrically controlled lock for firearms 439,055 21 Oct 1890
- DEUTSCHE WAFFEN UND MUNITIONSFABRIKEN—BERLIN, GERMANY (\*)  
 Trigger mechanism for machine guns 905,071 24 Nov 1908 (Heinemann)  
 Automatic gun 1,045,549 26 Nov 1912 (Heinemann)  
 Machine gun 1,087,371 17 Feb 1914 (Heinemann)  
 Automatic gun 1,114,463 20 Oct 1914 (Gebauer)  
 Automatic gun 1,114,611 20 Oct 1914 (Heinemann)  
 Machine gun 1,123,530 5 Jan 1915 (Heinemann, Karl)  
 Machine gun 1,128,310 16 Feb 1915 (Heinemann)  
 Machine gun 1,150,364 17 Aug 1915 (Heinemann, Karl)  
 Machine gun 1,155,061 28 Sep 1915 (Heinemann)  
 Machine gun 1,167,498 11 Jan 1916 (Heinemann)  
 Automatic firearm 1,725,272 20 Aug 1929 (Heinemann)
- DEVRIES, PETER J.—SHELDON, IOWA  
 Gun muffler 1,143,814 22 June 1915
- DESTREE, JOSEPH—BRUSSELS, BELGIUM  
 Automatic firearm 1,735,160 12 Nov 1929  
 Automatic firearm 1,713,955 21 May 1929  
 Automatic firearm with gas extraction 1,846,993 23 Feb 1932
- DIBOVSKY, VICTOR V.—LONDON, ENGLAND  
 Machine gun 1,298,911 1 April 1919  
 Buffing device for machine guns 1,298,912 1 Apr 1919  
 Machine gun 1,362,479 14 Dec 1920 (Assigned to Type Release Co., Inc.)
- DICKE, ALLEN A.—MONTCLAIR, N.J.  
 Automatic firearm 2,297,693 6 Oct 1942
- DICKINSON, CHARLES S.—CLEVELAND, OHIO  
 Improvement in centrifugal guns 24,997 9 Aug 1859
- DICKINSON, JACOB M.—CHICAGO, ILL.  
 Automatic firearm 1,835,286 8 Dec 1931
- DIEHM, LUCIUS N.—WEST HARTFORD, CONN.  
 Automatic firearm 1,226,478 15 May 1917 (Assigned 2/3 to Stone)
- DIESTELKAMP, FREDERICK A.—BLAND, MO.  
 Automatic magazine firearm 1,126,726 2 Feb 1915
- DINSMORE, ROBERT—WESTON, W.VA.  
 Magazine gun with pneumatically operated magazines 444,666 13 Jan 1891 (Assigned to Greenstein)
- DOBREMYSL, JOSEF—LONDON, ENGLAND  
 Automatic firearm 2,367,488 16 Jan 1945  
 Automatic gun 2,365,498 19 Dec 1944
- DODGE, JOSIAH—DUMMERSTON, VT.  
 Improved mode of charging cannons 15,357 15 July 1856  
 Improved mode of discharging cannons 17,920 4 Aug 1857
- DODGE, WILLIAM W., JR.—ASHEVILLE, N.C.  
 Machine gun 1,551,809 1 Sep 1925
- DOLLEY, LEON H.—SHERMAN MILLS, ME.  
 Recoil-operated firearm 1,067,721 15 July 1913
- DOOLITTLE, JAMES B.—SEYMOUR, CONN.  
 Magazine firearm 35,996 29 July 1862
- DOUGHERTY, ALBERT G.—CHAMBERSBURG, IND.  
 Machine gun 547,717 9 Oct 1895 (Assigned 2/3 to Buskirk & Foote)  
 Self-acting breech loading gun 529,521 20 Nov 1891 (Assigned 2/3 to Buskirk)
- DOUGLAS, WILLIAM M.—GALVESTON, TEX.  
 Automatic gun or rifle 1,025,132 7 May 1912
- DOUGLAS, WILLIAM—CORRY, PA.  
 Improvement in battery guns 43,903 23 Aug 1864
- DOVELL, HARPER H.—BALTIMORE, MD.  
 Machine gun 1,294,636 18 Feb 1919
- DRIGGS, LOUIS LABODIE—NEW YORK, N.Y.  
 Rapid-fire gun 613,195 25 Oct 1898 (Driggs & Tasker) (Assigned to Driggs-Seabury Gun & Ammunition Co.)  
 Automatic gun 698,472 29 Apr 1902 (Assigned to same)
- DRIGGS ORDNANCE CO., INC.—NEW YORK, N.Y. (\*)  
 Gas-operated gun 1,291,690 14 Jan 1919 (Smith)
- DRIGGS-SEABURY GUN & AMMUNITION CO.—NEW YORK, N.Y. (\*)  
 Rapid-fire gun 613,195 25 Oct 1898 (Driggs & Tasker)  
 Automatic gun 698,472 29 April 1902 (Driggs)
- DRIGGS-SEABURY ORDNANCE CORP.—SHARON, PA. (\*)  
 Automatic gun 781,503 31 Jan 1905 (Driggs)

**DRIGGS, WILLIAM HALE—WASHINGTON, D.C.**

Automatic gun 781,503 31 Jan 1905 (Assigned to Driggs-Seabury Ordnance Corp.)

**DUFFEK, JOSEF—STEYR, AUSTRIA**

Gun lock for automatic firearm 1,387,369 9 Aug 1921  
(Assigned to Oesterreichische Waffenfabrikgesellschaft, Steyr, Austria)

**DUNLOP RUBBER CO. LTD.—LONDON, ENGLAND (\*)**

Firing device for automatic guns 2,135,688 8 Nov 1938  
(Wright & Trevaskis)  
Solenoid 2,403,315 2 July 1946 (Trevaskis)  
Firing mechanism for automatic gun 2,397,387 26 Mar 1946 (Trevaskis)

**DUNWOODY AUTOMATIC GUN & PROJECTILE CO. (\*)**

Automatic gun 1,227,897 29 May 1917 (H. H. C. Dunwoody)

**DUNWOODY, HENRY H. C.—WASHINGTON, D.C.**

Automatic gun 1,227,897 29 May 1917 (Assigned to Dunwoody Automatic Gun & Projectile Co.)

**DUPCZA, PETER A.—LYNDORA, PA.**

Machine gun 990,642 25 April 1911  
Antiaircraft machine gun 1,443,249 23 Jan 1923 (Assigned 1/2 to Bogdonov)

**EATON, GILBERT C.—CLEVELAND, OHIO (\*)**

Centrifugal gun 37,159 16 Dec 1862 (Turner)

**EBELING, FRED—LINN, KANS.**

Machine gun 531,168 18 July 1894

**EDGEWATER STEEL CORP.—OAKMONT, PA. (\*)**

Automatic gun 2,370,835 6 Mar 1945 (Bell & Wilkander)  
Automatic gun 2,395,211 19 Feb 1946 (Bell & Wilkander)

**EDWARDS, DANIEL G.—HOPKINSVILLE, KY.**

Fire control means for aircraft machine guns 1,466,951 4 Sep 1923 (Assigned to Stone)

**EGLIN, HANS—GENEVA, SWITZERLAND**

Automatic inertia-locked firearm with automatic hammer 2,512,014 20 Jun 1950 (Assigned to Oerlikon Co.)

**EBBETS, CARL J.—HARTFORD, CONN.**

Gas-operated machine gun 550,262 26 Nov 1895 (Assigned to Colt's Patent Firearms Mfg. Co.)  
Gas-operated magazine gun 570,388 27 Oct 1896 (Assigned to Colt's Patent Firearms Mfg. Co.)

**EICKHOFF, THEODORE H.—CLEVELAND, OHIO**

Automatic gun 1,396,949 15 Nov 1921 (Assigned to Auto-Ordnance Corp.)

**EIANE, HALVOR O.—WASHINGTON ISLAND, WIS.**

Automatic gun 2,149,512 7 Mar 1939

**ERLUND, HANS E.—MALMO, SWEDEN**

Disconnecter means in self-charging firearms 2,390,061 4 Dec 1945 (Assigned to Aktiebolaget J. C. Ljungman)

**EKSERGIAN, CAROLUS L.—DETROIT, MICH.**

Rocket projectile (Spin S.) 2,405,415 6 Aug 1946  
Recoilless gun mechanism 2,405,414 6 Aug 1946

**ELLOTT, CARLETON R.—DAYTON, OHIO**

Gun cocking device 2,386,801 16 Oct 1945 (Johnson & Elliott)

**ELLIOTT, DANIEL S.—MIDDLE RIVER, MD.**

Machine gun feed 2,428,414 7 Oct 1947 (Assigned to Glenn L. Martin Co.)

**END, G.—SCHIAFFHAUSEN, SWITZERLAND**

Automatic firearm 2,031,305 18 Feb 1936 (End & Gactzi)  
(Assigned to Schweizerische-Industrie Gesellschaft)  
Automatic firearm 2,130,383 20 Sep 1938 (Assigned to Schweizerische-Industrie Gesellschaft)  
Automatic firearm 2,052,287 25 Aug 1936 (Assigned to Schweizerische-Industrie Gesellschaft)

**ENGEL, GEORG—DUSSELDORF, GERMANY**

Automatic firearm 2,133,661 18 Oct 1938 (Engel & Winter) (Assigned to Rheinmetall-Borsig)

**ERIKSEN, JOHAN—CHRISTIANA, NORWAY**

Machine gun 1,497,096 10 June 1924

**ERNESTI, WALTER—BERLIN, GERMANY**

Gun which fires with forward movement of the gun 2,218,877 22 Oct 1940 (Ernesti & Herlach) (Assigned to Rheinmetall-Borsig Aktiengesellschaft)

**EYLER, LAWRENCE J.—DAYTON, OHIO**

Cocking handle for aerial guns 1,528,950 10 May 1925 (Russell & Eyer)

**FAIRCHILD AVIATION CORP.—NEW YORK, N.Y. (\*)**

Gun synchronizer 1,848,720 8 Mar 1932 (Horton)

**FARQUHAR, MOUBRAY GORE—ABOYNE, SCOTLAND**

Automatic rifle 867,960 15 Oct 1907 (Farquhar & Hill)  
Automatic firearm 920,301 4 May 1909 (Farquhar & Hill)  
Automatic firearm 1,019,620 5 Mar 1912 (Farquhar & Hill)  
Cartridge magazine for rifles and machine guns 1,337,893 20 Apr 1920 (Farquhar & Hill)  
Automatic firearm 1,350,961 24 Aug 1920 (Farquhar & Hill)  
Automatic firearm 1,353,736 21 Sep 1920 (Farquhar & Hill)

**FARRINGTON, DE WITT CLINTON—LOWELL, MASS.**

Machine gun 165,318 6 July 1875  
Barrel-shifting mechanism for machine guns 198,366 18 Dec 1877  
Cartridge feeder for machine guns 198,368 18 Dec 1877  
Machine gun 241,130 10 May 1881  
Improvement in machine guns 179,450 4 July 1876  
Improvement in traverse mechanism for machine guns 198,367 18 Dec 1877  
Improvement in locks for machine guns 185,510 19 Dec 1876

**FARWELL GUN CO.—NEW YORK, N.Y. (\*)**

Machine gun 154,596 1 Sep 1874 (Farwell)

**FARWELL, WILLARD B.—NEW YORK, N.Y.**

Machine gun 137,428 1 Apr 1873  
Machine gun 154,596 1 Sep 1874 (Assigned to Farwell Gun Co.)  
Machine gun 169,686 9 Nov 1875

- FERRANT, EMIL.—MINNEAPOLIS, MINN.  
Automatic magazine gun 645,932 27 Mar 1900 (Beck & Ferrant)
- FIELDS, WILLIAM—WILMINGTON, DEL.  
Gun, Battery 113,996 25 Apr 1871
- FISHER, GEORGE O.—BROOKLYN, N.Y.  
Automatic gun 1,475,761 27 Nov 1923
- FITTIPALDI, RAFAEL—BUENOS AIRES, ARGENTINA  
Automatic repeating firearms 1,099,245 9 June 1914
- FLETCHER, WALLACE R.—DAYTON, OHIO  
Blast tube for machine guns 1,557,820 20 Oct 1925  
Electrical synchronizer and trigger motor for automatic machine guns 1,530,700 24 Mar 1925 (Russell & Fletcher)
- FLÖRICKE, ALBERT E.—NEW YORK, N.Y.  
Machine gun 1,401,768 27 Dec 1921
- FOKKER, ANTHONY H. G.—AMSTERDAM, NETHERLANDS  
Breech lock for machine guns 1,426,851 22 Aug 1922
- FOOTE, OSCAR—WASHINGTON, D.C. (\*)  
Machine gun 547,717 8 Oct 1895 (Dougherty)
- FOSBERY, GEORGE VINCENT—LONDON, ENGLAND  
Recoil-operated firearm 584,631 15 June 1897
- FOSKETT, WILLIAM A.—HARTFORD, CONN. (\*)  
Machine gun 430,206 17 June 1890 (Garland)  
Machine gun 479,499 2 Aug 1892 (Garland)
- FOWLER, ELBERT—BALTIMORE, MD.  
Machine gun 1,451,443 10 Apr 1923
- FOX, ANSLEY H.—PHILADELPHIA, PA.  
Gas-operated machine gun 1,293,396 4 Feb 1919 (Assigned to Ansley Fox Co.)  
Gas-operated automatic machine gun 1,294,892 18 Feb 1919 (Fox & Rice) (Assigned to Ansley Fox Co.)  
Machine gun 1,388,856 21 Aug 1930 (Assigned to Ansley Fox Co.)
- FRANCIS, LOUIS—MIAMI, FLA.  
Multi-charge gun 2,360,217 10 Oct 1944
- FRANK, HOLMES A.—MILLARTON, NEW BRUNSWICK, CANADA (\*)  
Machine gun 1,216,938 20 Feb 1917 (Brotherston)  
Method of and apparatus for cooling gun barrels 1,216,939 20 Feb 1917 (Brotherston)
- FRANKE, BERNHARD—NEW YORK, N.Y.  
Improvement in revolving ordnance 35,998 29 July 1862
- FRANKS, BENJAMIN R.—SCOTTSBORO, ALA.  
Extractor for revolving firearms 239,238 22 Mar 1881
- FREEMAN, CHARLES—LOS ANGELES, CALIF.  
Automatic firearm 802,033 17 Oct 1905  
Automatic firearm 870,719 12 Nov 1907
- FRIBERG, H.—STOCKHOLM, SWEDEN  
Automatic firearm 738,140 1 Sep 1903 (Assigned to Aktiebolaget Stockholms-Vapenfabrik)
- FRIED. KRUPP AKTIENGESELLSCHAFT—ESSEN ON THE RUHR, GERMANY (\*)  
Recoil gun 809,821 9 Jan 1906 (Lauber)  
Barrel-recoil gun with wedge breech lock 842,547 29 Jan 1907 (Hermsdorf)  
Barrel-recoil gun 911,818 9 Feb 1909 (Hermsdorf)  
Recoil gun 911,849 9 Feb 1909 (Theile)  
Recoil gun 923,051 25 May 1909 (Lauber and Bominghaus)  
Composite gun barrel assembled by rotary motion of its component parts 1,400,780 20 Dec 1921 (Vollmer)
- FRISSELL, FRANK H.—MIDDLETOWN, CONN.  
Belt-like cartridge carrier for machine guns 1,168,876 18 Jan 1916 (Assigned to Russell Mfg. Co.)  
Machine-gun belt 1,247,811 27 Nov 1917  
Machine-gun feed belt 1,258,553 5 Mar 1918 (Assigned to Russell Mfg. Co.)
- FITZPATRICK, KIRBY—OKLAHOMA CITY, OKLA.  
Automatic gun 1,161,384 23 Nov 1915
- FROMMER, RUDOLF VON—BUDAPEST, AUSTRIA-HUNGARY  
Firearm for hand and automatic loading 952,896 22 Mar 1910  
Automatic firearm 959,002 24 May 1910  
Automatic firearm 960,880 7 June 1910  
Automatic firearm 988,996 11 Apr 1911  
Automatic firearm 992,184 16 May 1911  
Automatic firearm 1,038,555 17 Sep 1912  
Firing mechanism for automatic firearms 1,159,004 2 Nov 1915  
Automatic firearm 1,516,835 25 Nov 1924  
Automatic firearm 1,521,676 6 Jan 1925  
Automatic firearm 1,579,742 6 Apr 1926  
Automatic firearm 1,680,186 7 Aug 1928  
Automatic firearm 1,758,486 13 May 1930  
Automatic firearm 1,809,741 9 June 1931  
Barrel spring for automatic firearm 1,877,839 20 Sep 1932  
Automatic firearm with removable barrel 1,991,302 12 Feb 1935
- FROST, JOSEPH W.—NEW YORK, N.Y.  
Electric firearm 319,898 9 June 1885
- FURRER, ADOLF—BERNE, SWITZERLAND  
Automatic firearm 1,518,498 9 Dec 1924 (Assigned to Schweizerische Industrie Gesellschaft)
- GABBETT-FAIRFAX, HUGH WILLIAM—LONDON, ENGLAND  
Automatic firearm 684,055 8 Oct 1901  
Recoil-operated firearm 600,066 1 Mar 1898 (Assigned to the Mars Automatic Firearms Syndicate, Ltd.)  
Automatic or semi-automatic firearm 1,338,649 27 Apr 1920  
Automatic firearm 1,344,499 22 June 1920  
Firearm or machine gun 1,348,702 3 Aug 1920  
Automatic firearm 1,357,857 2 Nov 1920
- GAETZI, JAKOB—SCHAFFHAUSEN, SWITZERLAND  
Automatic firearm 2,031,305 18 Feb 1936 (End & Gaetzi) (Assigned to Schweizerische Industrie Gesellschaft)

- GAIDOS, ALONZO F.—REDWOOD, CALIF.**  
Fire control selector for automatic firearms 2,512,638 27 Jun 1950
- GANNOE MFG. CO.—W.VA. (\*)**  
Centrifugal gun 1,309,129 8 July 1919 (Gannoc, T. A.)
- GANNOE, THOMAS A.—WARREN, PA.**  
Centrifugal gun 1,309,129 8 July 1919 (Assigned to Gannoc Mfg. Co.)
- GARAND, JOHN C.—SOMERSET, MD.**  
Automatic gun 1,603,684 19 Oct 1926
- GARAND, JOHN C.—NEW YORK, N.Y. (\*)**  
Machine gun 1,472,126 30 Oct 1923 (Kewish)
- GARDNER, WILLIAM—HARTFORD, CONN. & CLEVELAND, OHIO**  
Machine gun 245,710 16 Aug 1881  
Machine gun 216,266 10 Jan 1879  
Improvement in machine guns 174,130 29 Feb 1876
- GARLAND, EDWARD E.—BELLEVILLE, N.J.**  
Automatic firearm 2,189,202 6 Feb 1940
- GARLAND, FRANK M.—NEW HAVEN, CONN.**  
Machine gun 430,206 17 June 1890 (Assigned 2/3 to Beecher, Foskett, Newton & Sherman)  
Machine gun 513,995 6 Feb 1894  
Machine gun 479,799 2 Aug 1892 (Assigned 2/3 to Beecher, Foskett, Newton & Sherman)  
Machine gun 457,276 17 May 1892  
Automatic machine gun 623,003 11 Apr 1899  
Automatic operating mechanism for machine guns 636,974 14 Nov 1899 (2/3 to Beecher)  
Automatic machine gun 636,977 14 Nov 1899  
Automatic machine gun 643,118 13 Feb 1900 (2/3 Assigned to Beecher)  
Automatic machine gun mechanism 643,119 13 Feb 1900  
Automatic machine gun 669,236 5 Mar 1901
- GASS, GEORGE WILLIAM—BOLTON, ENGLAND**  
Machine gun 729,858 2 June 1903
- GAST, CARL—BARMEN, GERMANY**  
Double-barrel machine gun with recoiling barrels 1,477,115 11 Dec 1923
- GASTAV GENSCHOW & CO.—BERLIN, GERMANY (\*)**  
Automatic firearm 2,182,907 12 Dec 1939 (Vollmer)
- GATES, WILLIAM H.—NORWICH, CONN.**  
Automatic firearm 962,137 21 June 1910
- GATLING GUN CO.—HARTFORD, CONN. (\*)**  
Feeder for machine guns 290,622 18 Dec 1883 (Accles)  
Cartridge-charger for machine gun feeders 341,371 4 May 1886 (Bruce)  
Cartridge feeder for machine guns 343,532 8 June 1886 (Bruce)  
Cartridge feeder for machine guns 351,960 2 Nov 1886 (Bruce)  
Machine gun 504,517 5 Feb 1893 (Broderick & Vankeirsbilck)
- Feed for machine guns 504,516 5 Sep 1893 (Broderick & Vankeirsbilck)
- GATLING, RICHARD J.—HARTFORD, CONN. AND INDIANAPOLIS, IND.**  
Traversing gun mechanism for machine guns 145,563 16 Dec 1873  
Machine gun 502,185 25 Dec 1893  
Feed for machine gun 499,534 13 June 1893  
Improvement in revolving-battery guns 125,563 9 Apr 1872  
Revolving-battery gun 36,836 4 Nov 1862  
Improvement in revolving-battery guns 112,138 28 Feb 1871  
Improvement in battery guns 47,631 9 May 1865
- GAVITT, JAMES K. G.—PHILADELPHIA, PA.**  
Electric firearm 332,071 8 Dec 1885
- GEBAUER, FERENC—BUDAPEST, HUNGARY**  
Gas-operated firearm 2,186,582 9 June 1940 (Assigned to Danuvia Ipari es' Kereskedelmi R. T.)
- GEBAUER, PAUL—BERLIN, GERMANY**  
Automatic gun 1,114,463 20 Oct 1914 (Assigned to Deutsche Waffen und Munitionsfabriken)
- GENERAL AIRCRAFT EQUIPMENT, INC.—SOUTH NORWALK, CONN. (\*)**  
Gun actuator 2,341,641 15 Feb 1944 (Mejean, J. G.)
- GENERAL ELECTRIC CO.—NEW YORK, N.Y. (\*)**  
Gun charger 2,389,943 27 Nov 1945 (Wall)
- GENERAL MOTORS CORP.—DAYTON, O. AND DETROIT, MICH. (\*)**  
Cartridge feed mechanism 2,418,428 1 Apr 1947 (Rundquist)  
Bolt mechanism 2,503,575 11 Apr 1950 (Anderson & Pearson)  
Feed mechanism for machine guns 2,519,947 22 Aug 1950 (Watt)
- GENERAL ORDNANCE CO.—GORTON, CONN. (\*)**  
Non-recoil gun 1,394,490 18 Oct 1921 (Giles)
- GERNER, JOSEPH H.—LOWVILLE, N.Y.**  
Rapid-fire battery gun 1,283,728 5 Nov 1918
- GESELLSCHAFT ZUR VERWARTUNG VON FEUERWAFFEN-PATENTEN MBH—COLOGNE, GERMANY (\*)**  
Machine gun 1,032,413 16 July 1912 (Knotgen)  
Automatic machine gun 1,005,759 11 Mar 1913 (Knotgen)  
Automatic firearm 1,114,150 20 Oct 1914 (Knotgen)
- GILES, JULIAN A.—DERBY, CONN.**  
Non-recoil gun 1,394,490 18 Oct 1921 (Assigned to the General Ordnance Co.)
- GLENN L. MARTIN CO.—BALTIMORE, MD. (\*)**  
Machine gun feed 2,428,414 7 Oct 1947 (Elliott)
- GOEBEL, B.—LIEGE, BELGIUM**  
Semi-automatic firearm with cylindrical breech 909,398 12 Jan 1909

- GOEPFRICH, GEORGE A.—SOUTH BEND, IND.  
 Gun charging mechanism 2,413,104 24 Dec 1946 (Assigned to Bendix Aviation Corp.)  
 Gun charger 2,408,624 1 Oct 1946
- GORTON, WALTER T.—SPRINGFIELD, MASS.  
 Buffer mechanism for machine guns 1,561,713 17 Nov 1925  
 Machine gun 1,625,993 26 Apr 1927  
 Machine gun 1,625,994 26 Apr 1927  
 Machine gun 1,498,542 24 June 1924  
 Combined barrel support and flash hider for guns 1,538,243 19 May 1925  
 Automatic firearm 2,352,193 27 June 1944
- GRANT, HARRY C., JR.—NEW YORK, N.Y.  
 Gun charger 2,409,623 22 Oct 1946 (Assigned to Specialties Development Corp.)
- GRAY, WILLIS R.—OAKTON, VA.  
 Silencer for firearms 1,066,898 8 July 1913
- GREEN, SAMUEL G.—GRAY, GA.  
 Electrically controlled mechanism for firearms 1,352,891 14 Sep 1920  
 Attachment for preventing the feeding of ball cartridges to a gun 1,354,825 5 Oct 1920  
 Attachment for gas-operated guns 1,445,583 13 Feb 1923 (Assigned to United States Ord. Co.)  
 Machine gun unit 1,689,482 30 Oct 1928  
 Water jacket for machine guns 1,963,086 19 Jun 1931  
 Gun barrel and barrel mounting 1,980,399 13 Nov 1934  
 Packed joint for guns 2,026,528 7 Jan 1936  
 Trigger mechanism for machine guns 2,069,244 2 Feb 1937  
 Cartridge feeding mechanism for automatic guns 2,073,632 16 Mar 1937  
 Muzzle attachment for guns 2,101,063 7 Dec 1937  
 Stabilizer for guns 2,101,848 14 Dec 1937  
 Muzzle attachment for guns 2,101,849 14 Dec 1937  
 Muzzle attachment for guns 2,101,850 14 Dec 1937  
 Machine gun jacket mounting 2,101,851 14 Dec 1937  
 Bolt operating mechanism for machine guns 2,104,033 4 Jan 1938  
 Back plate latch for machine guns 2,108,060 15 Feb 1938  
 Trigger for machine guns 2,119,536 7 Jun 1938  
 Gland adjusting mechanism 2,121,030 21 Jun 1938  
 Recoil check and barrel accelerator for a machine gun 2,128,243 30 Aug 1938  
 Muzzle attachment for guns 2,128,936 6 Sep 1938  
 Muzzle attachment for guns 2,150,161 14 Mar 1939  
 Machine gun structure 2,186,969 16 Jan 1940  
 Back plate and driving spring for machine guns 2,321,592 15 Jun 1943 (Green & Hopkins)  
 Gun barrel mounting 2,326,139 10 Aug 1943  
 Back plate latch mechanism for machine guns 2,335,854 7 Dec 1943  
 Flash hider 2,339,777 25 Jan 1944  
 Barrel mounting 2,345,596 4 Apr 1944  
 Stabilizer for guns 2,351,037 13 Jun 1944  
 Recoil check and barrel accelerator for automatic weapons 2,362,996 21 Nov 1944  
 Speed regulator for automatic guns 2,382,411 14 Aug 1945  
 Gun feed mechanism 2,405,207 6 Aug 1946
- GREENSTEIN, ADOLPH—WESTON, W.VA. (\*)  
 Magazine gun with pneumatically operated magazine 444,666 13 Jan 1891 (Dinsmore)
- GREER, JOHN WILLIAM—AUSTIN, TEX.  
 Machine gun 431,515 1 July 1890
- GREGG, CLARENCE—PITT BRIDGE, TEX.  
 Machine gun 1,277,307 2 Aug 1918
- GRIFFITHS, WILLIAM—LONDON, ENGLAND  
 Recoil-operated gun 512,437 9 Jan 1894 (Woodgate & Griffiths)
- GRILL, CALVIN E.—SAN FRANCISCO, CALIF.  
 Automatic gun 1,617,683 15 Feb 1927
- GURNEY, J.—NEW YORK, N.Y. (\*)  
 Improvement in breech-loading ordnance 34,025 24 Dec 1861 (De Brame)  
 Improvement in revolving ordnance 34,024 24 Dec 1861 (De Brame)
- GUSTAVO, VINCON—TURIN, ITALY  
 Automatic firearm 1,484,163 19 Feb 1924
- HAGEN, RUDOLF A.—MASON CITY, IOWA  
 Machine gun 1,653,171 20 Dec 1927
- HALETT, DELBERT—GALVESTON, TEX. (\*)  
 Machine gun 1,869,738 2 Aug 1932 (Davis)
- HALL, EUGENE ADELBERT—WEST BAY CITY, MICH.  
 Recoil-operated firearm 830,226 4 Sep 1906
- HALLÉ AUTOMATIC FIRE ARMS SYND., LTD.—LONDON, ENGLAND (\*)  
 Recoil-operated firearms 755,482 22 Mar 1904 (Hallé)  
 Automatic firearm 753,700 1 Mar 1904 (Hallé)
- HALLÉ, CLIFFORD R. S. J.—HAMPTON WICK, ENGLAND  
 Recoil-operated firearm 755,482 22 Mar 1904 (Assigned to the Hallé Automatic Firearms Syndicate, Ltd.)  
 Automatic firearms 753,700 1 Mar 1904 (Assigned to Hallé Automatic Firearms Syn., Ltd.)  
 Automatic firearms 1,010,899 5 Dec 1911
- HAMILTON, L. M.—PARIS, FRANCE  
 Means for cooling machine guns 1,527,585 24 Feb 1925 (Hamilton, Joly & Pullock)
- HAMMOND, GRANT—HARTFORD, CONN.  
 Automatic gun 954,797 12 Apr 1910 (Assigned 1/2 to Darlington)  
 Automatic gun 954,798 12 Apr 1910 (Assigned to Darlington)  
 Automatic gun 954,799 12 Apr 1910
- HANSEN, OLE—CHOATE, MICH. (\*)  
 Gas-operated firearm 532,380 8 Jan 1895 (Johnson)
- HANSEN, SERN L.—NORTHFIELD, OHIO  
 Rapid-fire gun 2,374,816 1 May 1945
- HARDY, MOSES F.—SEWARD, N.Y.  
 Improvement in revolving ordnance 36,148 12 Aug 1862

- HARE, D. O.—CHARLESTOWN, ILL. (\*)  
Improvement in repeating ordnance 12,295 23 Jan 1855  
(Hoffman)
- HARPER, ANGELO C.—WASHINGTON, D.C.  
Machine gun 1,369,426 22 Feb 1921
- HARRING, HARRY K.—WASHINGTON, D.C.  
Machine gun 1,698,228 8 Jan 1929 (Assigned 2/3 to  
Morgan R. Mills)
- HARRINGTON & RICHARDSON ARMS COMPANY—WORCESTER,  
MASS. (\*)  
Recoil operated firearm 812,015 6 Feb 1906 (Bye)  
Safety device for firearms 2,495,383 24 Jan 1950 (Mulno)
- HARVEY, EARLE M.—SPRINGFIELD, MASS.  
Automatic firearm 2,397,963 9 Apr 1946
- HASKELL, GEORGE D.—CONCORD, MASS.  
Machine gun 1,379,339 24 May 1921 (Assigned to  
United States Ordnance Co.)  
Machine gun 1,453,974 1 May 1923 (Dawson, Buckham  
& Haskell) (Assigned to Vickers, Ltd.)
- HATCHER, JAMES L.—WINCHESTER, VA.  
Gun 1,744,162 2 Jan 1930  
Apparatus for rifling gun barrels 1,789,308 20 Jan 1931  
Belt-feed mechanism for machine guns 1,808,847 9 June  
1931  
Bolt-operating mechanism for machine guns 1,858,498 17  
May 1932
- HAUFF, ALBERT—BERLIN, GERMANY  
Recoil-operated firearm 545,496 3 Sep 1895
- HAUBROE, WERNER CHRISTIAN LASSEN—COPENHAGEN, DENMARK  
Machine gun with exchangeable barrels 1,588,887 15 June  
1926
- HAYN, GEORG—ESSEN-ON-THE-RUHR, GERMANY  
Recoil gun barrel 913,403 23 Feb 1909
- HAZELTON, GEORGE—LONDON, ENGLAND  
Machine gun 1,339,390 11 May 1920  
Machine gun 1,447,246 6 Mar 1923 (Assigned to  
Vickers Ltd.)  
Machine gun 1,479,138 1 Jan 1924 (Assigned to  
Vickers Ltd.)
- HEDGES, ELLSWORTH C.—WEST HARTFORD, CONN.  
Bolt mechanism for machine guns 2,529,391 7 Nov 1950  
(Assigned to Colt's Manufacturing Co.)
- HEDRICK, FLOYD C.—KENTLAND, IND.  
Automatic firearm 1,249,622 11 Dec 1917
- HEDRICK, JAMES H.—WYTHE COUNTY, VA.  
Improvement in repeating cannons 110,233 20 Dec 1870  
(Assigned to Barrett)
- HEINEMANN, KARL—BERLIN, GERMANY  
Trigger mechanism for machine guns 905,071 24 Nov 1908  
(Assigned to Deutsche Waffen und Munitionsfabriken)
- Automatic gun 1,045,549 26 Nov 1912 (Assigned to  
Deutsche Waffen und Munitionsfabriken)
- Machine gun 1,087,371 17 Feb 1914 (Assigned to  
Deutsche Waffen und Munitionsfabriken)
- Automatic gun 1,114,611 20 Oct 1914 (Assigned to  
Deutsche Waffen und Munitionsfabriken)
- Machine gun 1,123,530 5 Jan 1915 (Assigned to  
Deutsche Waffen und Munitionsfabriken)
- Machine gun 1,128,310 16 Feb 1915 (Assigned to  
Deutsche Waffen und Munitionsfabriken)
- Machine gun 1,150,364 17 Aug 1915 (Assigned to  
Deutsche Waffen und Munitionsfabriken)
- Machine gun 1,155,061 28 Sep 1915 (Assigned to  
Deutsche Waffen und Munitionsfabriken)
- Machine gun 1,167,498 11 Jan 1916 (Assigned to  
Deutsche Waffen und Munitionsfabriken)
- Automatic firearm 1,725,272 20 Aug 1929 (Assigned to  
Deutsche Waffen und Munitionsfabriken)
- Automatic firearm 1,825,904 6 Oct 1931 (Assigned to  
Deutsche Waffen und Munitionsfabriken)
- HEIZLER, EDWARD J.—WEST CLADWELL, N.J.  
Gun charger 2,411,877 3 Dec 1946 (Assigned to Special-  
ties Development Corp.)
- HELLBERG, HELDGE—COVENTRY, ENGLAND  
Feed mechanism for automatic guns 1,298,091 25 Mar  
1919 (Redpath & Hellberg) (Assigned to Coventry  
Ordnance Works)
- HANDLEY, JAMES A.—MIDDLETOWN, CONN.  
Cartridge feed-belt for machine guns 2,422,898 24 June  
1947 (Assigned to Russell Mfg. Co.)
- HENCKEL, AAGE F. C.—HELLERUP, DENMARK  
Cartridge feeder and cartridge feeder dog for automatic fire-  
arms 2,499,583 7 Mar 1950
- HENNEVELD, JACOBUS—LAANDAM, NETHERLANDS  
Cartridge belt for machine guns 1,136,956 27 Apr 1915  
(Henneveld & Lemei)
- HENNICK, DANIEL G.—MITCHELL, ONTARIO, CANADA  
Automatic firearm 1,004,424 26 Sep 1911
- HENNING, HERMANN—BERLIN, GERMANY  
Automatic gun 2,202,201 28 May 1940 (Assigned to  
Rheinmetall-Borsig Aktiengesellschaft)
- HEPBURN, LOUIS L.—NEW HAVEN, CONN.  
Repeating firearm 882,561 24 Mar 1908 (Assigned to  
Marlin Fire Arms Co.)
- HEPPERLE, ERWIN—ZÜRICH, SWITZERLAND  
Automatic firearm 2,380,455 31 Jul 1945 (Lippert &  
Hepperle)  
Automatic firearm breech bolt locking mechanism 2,523,704  
26 Sep 1950 (Lippert & Hepperle) (Assigned to Oerli-  
kon Co.)  
Trigger mechanism for automatic firearms 2,524,258 3 Oct  
1950 (Assigned to Oerlikon Co.)

- HERAPH, S. H.—ST. LOUIS, MO. (\*)**  
Improvement in repeating ordnance 29,437 31 July 1860 (Matthews)
- HERLACH, FRITZ—DUSSELDORF, GERMANY**  
Automatic firearm 1,709,399 16 Apr 1929 (Herlach & Rakula) (Assigned to Rheinische Metallwaren und Maschinenfabrik)  
Automatic firearm with two cartridge magazines 1,784,355 9 Dec 1930 (Herlach & Rakula) (Assigned to Rheinische Metallwaren und Maschinenfabrik)  
Automatic gun 2,067,322 12 Jan 1937 (Herlach & Rakula) (Assigned to Waffenfabrik Solothurn A.G.)  
Automatic firearm 1,746,471 11 Feb 1930 (Herlach & Rakula) (Assigned to Rheinische Metallwaren und Maschinenfabrik)  
Automatic firearm 2,015,908 1 Oct 1935 (Rakula & Herlach) (Assigned to Waffenfabrik Solothurn A.G.)
- HERLACH, HEINRICH—BERLIN, GERMANY**  
Gun that fires during forward movement of the gun 2,218,887 22 Oct 1940 (Ernesti & Herlach) (Assigned to Rheinmetall-Borsig Aktiengesellschaft)  
Automatic gun 2,230,328 4 Feb 1941 (Krum & Herlach) (Assigned to Rheinmetall-Borsig)
- HERMAN, HENRY—LOUISVILLE, MISS. (\*)**  
Machine gun 282,787 7 Aug 1883 (Shields)
- HERMSDORF, MAX—ESSEN-ON-THE-RUHR, GERMANY**  
Barrel-recoil gun with wedge breechblock 842,547 29 Jan 1907 (Assigned to Fried. Krupp Aktiengesellschaft)  
Barrel-recoil gun 911,818 9 Feb 1909 (Assigned to Fried. Krupp Aktiengesellschaft)
- HIGH STANDARD MFG. CORP.—NEW HAVEN, CONN. (\*)**  
Self-loading repeating firearm 2,342,824 29 Feb 1944 (Swabilius)  
Self-loading repeating firearm 2,365,307 19 Dec 1944 (Swabilius)  
Belt-holding pawls for machine guns 2,392,012 1 Jan 1946 (Swabilius)  
Extractor switch mechanism for machine guns 2,404,325 16 July 1946 (Swabilius)
- HIGSON, PERCY REUBEN—WESTMINSTER, ENGLAND**  
Gas-operated machine gun & Automatic small arm 1,811,693 23 June 1931 (Larsson & Higson) (Assigned to Vickers Armstrong Ltd.)  
Drum magazine for machine guns and automatic small arms 1,811,694 23 June 1931 (Larsson & Higson) (Assigned to Vickers Armstrong Ltd.)  
Machine gun and automatic small arms 1,846,035 9 Feb 1932 (Larsson & Higson) (Assigned to Vickers Armstrong Ltd.)  
Machine gun 2,013,312 3 Sep 1935 (Larsson & Higson) (Assigned to Vickers Armstrong Ltd.)  
Machine gun 2,048,395 21 July 1936 (Larsson & Higson) (Assigned to Vickers Armstrong Ltd.)  
Machine gun 2,037,244 14 Apr 1936 (Larsson & Higson) (Assigned to Vickers Armstrong Ltd.)  
Machine gun & drum 2,113,793 12 Apr 1938 (Larsson & Higson) (Assigned to Vickers Armstrong Ltd.)  
Machine gun and automatic small arm 2,137,612 22 Nov 1938 (Larsson & Higson) (Assigned to Vickers Armstrong Ltd.)  
Automatic gun 2,347,559 25 Apr 1944 (Assigned to Vickers Armstrong Ltd.)  
Double-barreled automatic gun 2,509,734 30 May 1950 (Assigned to Vickers-Armstrong Ltd.)
- HILL, ARTHUR HENRY—BIRMINGHAM, ENGLAND**  
Automatic rifle 867,960 15 Oct 1907 (Farquhar & Hill)  
Automatic firearm 920,301 4 May 1909 (Farquhar & Hill)  
Automatic firearm 1,019,620 5 Mar 1912 (Farquhar & Hill)  
Cartridge magazine for rifles and machine guns 1,337,893 20 Apr 1920 (Farquhar & Hill)  
Automatic firearm 1,350,961 24 Aug 1920 (Farquhar & Hill)  
Automatic firearm 1,353,736 21 Sep 1920 (Farquhar & Hill)
- HODGES, LLOYD E.—GLENORA, CALIF.**  
Machine gun 1,399,119 6 Dec 1921
- HOFFMAN, SAMUEL—CHARLESTON, ILL.**  
Improvement in repeating cannons 12,295 23 Jan 1855 (Assigned to Hare, D. O.)
- HOLEK, EMANUEL—BRUNN, CZECHOSLOVAKIA**  
Gas-pressure regulator device for firearms 1,802,816 28 Apr 1931 (Assigned to Ceskoslovenska Zbrojovka Akciová Společnost V. Brne)
- HOLEK, VACLAV—BRUNN, CZECHOSLOVAKIA**  
Automatic firearm 2,146,185 7 Feb 1939 (Assigned to Ceskoslovenska Zbrojovka)  
Automatic firearm 2,223,004 26 Nov 1940 (Assigned to Ceskoslovenska Zbrojovka)  
Automatic firearm 2,267,501 23 Dec 1941 (Assigned to Ceskoslovenska Zbrojovka)  
Automatic firearm 2,093,169 14 Sep 1937 (Assigned to Ceskoslovenska Zbrojovka)  
Automatic firearm 2,115,526 26 Apr 1938 (Assigned to Ceskoslovenska Zbrojovka)
- HOLLINGSWORTH, J.—ZANESVILLE, OHIO (\*)**  
Firearm, Self-cocking revolving 39,825 8 Sep 1863 (Mershon)
- HOOHAM, GEORGE—BIRMINGHAM, ENGLAND**  
Automatic gun 621,085 14 Mar 1899
- HOPKINS, EDWARD W.—ENFIELD, CONN.**  
Back plate and driving spring for machine guns 2,321,592 15 Jun 1943 (Green & Hopkins)
- HOPPERT, FILSER D.—SPRINGFIELD, MASS.**  
Machine gun 2,108,817 22 Feb 1938 (Hoppert, Bull & Simpson)



**HORAN, TIMOTHY F.—NEW HAVEN, CONN.**

- Automatic firearm 2,311,780 15 Feb 1944  
 Automatic firearm 2,357,047 29 Aug 1911 (Assigned to Savage Arms Corp.)  
 Cartridge feeding mechanism for repeating firearms 2,422,301 17 June 1947

**HORNE, GEORGE A.—SYRACUSE, N.Y.**

- Recoil-operated firearm 690,955 14 Jan 1902

**HORTON, WINTHROP S.—FARMINGDALE, N.Y.**

- Gun synchronizer 1,848,720 8 Mar 1932 (Assigned to Fairchild Aviation Corp.)

**HOTCHKISS, BENJAMIN B.—NEW YORK, N.Y.**

- Machine gun 10,280 6 Feb 1883  
 Metallic cartridge 98,278 28 Dec 1869 (Leet, C. D.)  
 Breech-loading firearm 99,898 15 Feb 1870  
 Machine gun or battery gun 103,501 13 Aug 1872  
 Machine gun 211,737 28 Jan 1879  
 Machine gun 211,849 4 Feb 1879  
 Machine gun 253,924 21 Feb 1882

**HOTCHKISS ET CIE (FRANCE) See SOCIETE ANONYME DES ANCIENS ETABLISSEMENTS HOTCHKISS & CIE.****HOTCHKISS ORDNANCE CO. LTD.—LONDON, ENGLAND (\*)**

- Automatic machine gun 563,043 14 July 1896 (Benét & Mercié)  
 Gas-operated gun 588,380 17 Aug 1897 (Benét & Mercié)

**HOWIE, JAMES F.—SEATTLE, WASH.**

- Centrifugal gun 1,235,897 7 Aug 1917

**HUDSON, ROBERT F.—RICHMOND, VA.**

- Machine gun 1,386,872 9 Aug 1921  
 Machine gun 1,749,137 4 Mar 1930 (Assigned to Automatic Guns Inc.)  
 Machine guns 1,786,207 23 Dec 1930 (Assigned to Automatic Guns Inc.)  
 Automatic gun 2,112,660 29 Mar 1938

**HUGHES, CHARLES F.—VANCOUVER, BRITISH COLUMBIA, CANADA**

- Automatic firearm 1,190,653 12 Apr 1916

**HUGHES, ROBERT H. S.—BALTIMORE, MD.**

- Recoil control for firearms 2,184,595 26 Dec 1939 (Assigned to Roberts, M.)

**HUGHES, WILLIAM O.—PINKSTAFF, ILL.**

- Machine gun 662,761 27 Nov 1900 (Hughes & Bowman)

**HUMESTON, FREDERICK L.—HAMDEN, CONN.**

- Gas-operated actuating mechanism for firearms 2,340,962 8 Feb 1911 (Assigned to Western Cartridge Co.)

**HUNTLEY, STEPHEN A.—SIOUX CITY, IOWA**

- Automatic firearm 747,073 15 Dec 1903 (Assigned to Spatz & Conly)

**IDE, CHARLES E.—REDLANDS, CALIF. (\*)**

- Automatic firearms 1,028,884 11 June 1912 (Johnson)

**INTERCONTINENTAL CO.—CALIF. (\*)**

- Centrifugal gun 1,311,465 29 July 1919 (Saliger)  
 Centrifugal gun 1,311,492 29 July 1919 (Bullard)

**INTERSTATE AIRCRAFT & ENGINEERING CORP.—CALIF. (\*)**

- Remote control gun charger 2,397,507 2 Apr 1946 (Roberts)

**ITHOMITIS, APOSTOLOS C.—RAYMOND, WASH.**

- Automatic firearm 1,442,951 23 Jan 1923

**JAESCHKE, ERNST—HAMBURG, GERMANY**

- Lateral dispersion device for machine guns 1,413,936 25 Apr 1922 (Rauchfuss & Jaeschke)

**JAGGARD, WILLIAM R.—HYTHE, ENGLAND**

- Air-cooled gun 2,337,840 28 Dec 1943 (Scott-Paine & Jaggard)

**JANECEK, FRANTISEK—PRAGUE, CZECHOSLOVAKIA**

- Machine gun 1,747,546 18 Feb 1930  
 Automatic firearm 2,270,683 20 Jan 1942

**JERVEY, THOMAS M.—WASHINGTON, D.C.**

- Automatic gun 1,651,128 29 Nov 1927

**JETER, EDMOND W.—ATLANTA, GA.**

- Machine gun 664,952 1 Jan 1901 (Assigned 2/3 to Blackburn, Spilman & Bickart)

**JOHNSON, CHRIST—WAUSAU, WIS.**

- Gas-operated firearm 532,380 8 Jan 1895 (Assigned 9/20 to Ole Hansen)

**JOHNSON, CLIFFORD E.—DAYTON, OHIO**

- Gun cocking device 2,386,801 16 Oct 1945 (Johnson & Elliott)

**JOHNSON, MARY E.—FITCHBURG, MASS. (\*)**

- Automatic gun 499,259 23 May 1911 (Cobb)

**JOHNSON, MELVIN M., JR.—BROOKLINE, MASS.**

- Automatic firearm 2,215,470 24 Sep 1940 (Assigned to Johnson & Rice)  
 Automatic gun 2,383,487 28 Aug 1945 (Assigned to Johnson & Rice)  
 Automatic firearm 2,409,569 15 Oct 1946 (Assigned to Johnson & Rice)

**JOHNSON, QUINTON C.—GARDENA, CALIF.**

- Gun blast seal 2,514,495 11 Jul 1950 (Assigned to North American Aviation, Inc.)

**JOHNSON, THOMAS C.—NEW HAVEN, CONN.**

- Automatic firearm 681,481 27 Aug 1901 (Assigned to Winchester Repeating Arms Co.)  
 Automatic firearm 694,157 25 Feb 1902 (Assigned to Winchester Repeating Arms Co.)  
 Recoil-operated firearm 768,665 30 Aug 1904 (Assigned to Winchester Repeating Arms Co.)  
 Locking block for automatic guns 760,871 24 May 1904 (Assigned to Winchester Repeating Arms Co.)  
 Recoiling-barrel firearm 945,328 4 Jan 1910 (Assigned to Winchester Repeating Arms Co.)  
 Recoiling-barrel gun 946,134 11 Jan 1910 (Assigned to Winchester Repeating Arms Co.)

**JOHNSTON, JAMES S.—UTICA, N.Y.**

- Machine gun 1,335,939 6 Apr 1920  
 Machine gun 1,328,230 13 Jan 1920

- Gas delay for firearms 1,387,889 16 Aug 1921  
 Cartridge magazine for machine guns 1,447,860 6 Mar 1923  
 Cocking mechanism for automatic machine guns 1,447,861 6 Mar 1923  
 Machine gun 1,485,460 4 Mar 1924
- JOHNSTON, MILLARD L.—UTICA, N.Y.  
 Cooler for firearms 1,296,193 4 Mar 1919  
 Actuator for machine guns 1,452,465 17 Apr 1923  
 Cartridge mechanism for machine guns 1,460,800 3 July 1923
- JOHNSON, IVAR—REDLANDS, CALIF.  
 Automatic firearm 1,028,884 11 June 1912 (Assigned 1/2 to Ide, Charles E.)
- JOLY, CHARLES LEVQUE—NEW YORK, N.Y.  
 Means for cooling machine guns 1,527,585 24 Feb 1925 (Hamilton, Joly & Pullock)
- JORGENSEN, BERNHARDT—MARBLEHEAD, MASS.  
 Gun loading mechanism 2,425,425 12 Aug 1947 (Assigned to United Shoe Machinery Corp.)
- JORGENSEN, ERIC—KONGSBERG, NORWAY  
 Straight pull breech bolt for firearms 502,727 8 Aug 1893 (Krag & Jorgensen)
- JOSLIN, WILLIAM—CLEVELAND, OHIO  
 Improvement in centrifugal guns 24,031 17 May 1859
- JUHASZ, ELEK B.—LEBANON, PA.  
 Automatic concealed firearm for self defense 1,726,228 27 Aug 1929
- JUSSELIN, LEON—MOREAUVILLE, LA.  
 Machine gun 861,467 30 July 1907
- KAUCH, ROBERT—DAYTON, OHIO  
 Machine gun synchronizer 1,592,500 13 July 1926 (Paulus & Kauch)
- KEHNE, KARL—BERLIN, GERMANY  
 Cocking device for automatic firearms having a sliding barrel and a bolted breech 2,056,577 6 Oct 1936  
 Gun having sliding and interchangeable barrels 2,345,127 28 Mar 1944
- KENNEY, CHARLES H.—NEW LONDON, CONN.  
 Silencer for firearms 1,017,003 13 Feb 1912
- KEWISH, JOHN T.—NEW YORK, N.Y.  
 Machine gun 1,472,126 30 Oct 1923 (Assigned 1/2 to Garand, John C.)  
 Automatic firearm 1,563,751 1 Dec 1925  
 Automatic firearm 1,587,003 1 June 1926  
 Automatic firearm 1,696,537 25 Dec 1928  
 Automatic firearm 1,993,887 12 Mar 1935
- KEY, MINTER P.—MEMPHIS, TENN.  
 Machine gun 241,671 17 May 1881
- KILGORE MFG. CO.—WESTERVILLE, OHIO (\*)  
 Machine gun 2,039,930 5 May 1936 (Rickenbacher)
- KIMBALL, WILLIAM W.—WASHINGTON, D.C.  
 Recoil-operated bolt gun 554,068 4 Feb 1896
- KING, WILLIS L.—APRONAUG, R.I.  
 Automatic firearm 515,526 27 Feb 1894 (Assigned to self & Potter, Louis K.)
- KINNE, GEORGE O.—HARTFORD, CONN.  
 Improvement in operating machine guns 120,588 7 Nov 1871 (Assigned to Colt's Patent Fire Arms Mfg. Co.)
- KINSMAN, FRANK E.—PLAINFIELD, N.J.  
 Electric firearm 317,545 12 May 1885
- KIRALY, PAUL VON—BUDAPEST, AUSTRIA-HUNGARY  
 Automatic breech-loading firearm 1,073,908 23 Sep 1913 (Kiraly & Lovasz)  
 Automatic or repeating firearm 2,325,484 27 July 1943 (Kiraly & Kucher) (Assigned to Alien Property Custodian)
- KJELLMAN, RUDOLF HENRIK—STOCKHOLM, SWEDEN  
 Automatic firearm 680,488 13 Aug 1901 (Kjellman & Andersson) (Assigned to Aktiebolaget Automatgevar)  
 Automatic firearm 690,739 7 Jan 1902 (Kjellman & Andersson) (Assigned to Aktiebolaget Automatgevar)  
 Recoil-operated firearm 765,491 19 July 1904 (Assigned to Aktiebolaget Stockholms Vapenfabrik)  
 Automatic firearm 814,547 6 Mar 1906 (Assigned to Aktiebolaget Stockholms Vapenfabrik)  
 Automatic firearm 1,040,692 8 Oct 1912 (Assigned to Aktiebolaget Stockholms Vapenfabrik)
- KLEFFE, CURT—DUSSELDORF, GERMANY  
 Gun with long recoil 1,151,476 14 Aug 1915 (Assigned to Rheinische Metallwaren und Maschinenfabrik)
- KNORR-BREMSE A. G.—BERLIN, GERMANY (\*)  
 Gas-operating loading device 2,119,169 31 May 1938 (Lauf)
- KNÖTGEN, MATHIAS—COLOGNE, GERMANY  
 Automatic firearm with stationary barrel 993,175 23 May 1911  
 Machine gun 1,032,413 16 July 1912 (Assigned to Gesellschaft zur Verwaltung von Feuerwaffen Patenten m.b.H.)  
 Automatic machine gun 1,005,759 11 Mar 1913 (Assigned to Gesellschaft zur Verwaltung von Feuerwaffen Patenten)  
 Automatic firearm 1,114,150 20 Oct 1914 (Assigned to Gesellschaft zur Verwaltung von Feuerwaffen Patenten)
- KNOTTS, ADDISON BURGESS—RAMOS, LA.  
 Means for operating machine gun 1,179,635 18 Apr 1916  
 Means for operating machine gun 1,198,557 19 Sep 1916
- KNOUS, FRANKLIN H.—NEW HAVEN, CONN.  
 Automatic firearm 933,254 7 Sep 1909 (Assigned to Winchester Repeating Arms Co.)
- KNOWLES, WILLIAM H.—HARTFORD, CONN.  
 Recoil-operated automatic firearm 829,163 21 Aug 1906
- KOBER, FERDINAND—ALLENTOWN, PA.  
 Machine gun 771,019 27 Sep 1904

**KOCH, NORBERT—ESSEN-ON-THE-RUHR, GERMANY**

Barrel recoil gun 913,403 23 Feb 1909

**KOUCHER, JOZSEF—BUDAPEST, HUNGARY**Automatic or repeating firearm 2,325,484 27 July 1943  
(Alien Property Custodian)**KOUCKY, JOSEF—PRAGUE, CZECHOSLOVAKIA**

Automatic firearm 2,351,976 20 Jun 1944

Inertia member for retarding breechblock movement in automatic firearms 2,495,460 24 Jan 1950 (Assigned to Zbrojovka Brno Narodni Podnik)

Cartridge feeding means for automatic firearms 2,519,582 22 Aug 1950 (Assigned to Zbrojovka Brno Narodni Podnik)

**KOZURIK, OSKAR VON—VIENNA, AUSTRIA**

Machine gun 2,147,003 14 Feb 1939 (Assigned to Latscher-Latka &amp; Beck-Rzikowsky)

**KRAG, OLE HERMAN—KONGSBERG, NORWAY**Straight-pull breech bolt for firearms 502,727 8 Aug 1893  
(Kraig & Jorgensen)

Automatic repeating firearm 954,441 12 Apr 1910

**KRNKA, CHARLES—VIENNA, AUSTRIA-HUNGARY**

Automatic firearm 676,995 25 June 1901 (Roth &amp; Krnka)

Automatic firearm 683,072 24 Sep 1901 (Roth &amp; Krnka)

**KRNKA, KARL—PRAGUE, AUSTRIA-HUNGARY**

Revolving magazine firearm 459,874 22 Sep 1891

Straight-pull breech loading gun 441,673 2 Dec 1890  
(K. & S. Krnka) (Assigned to Krnka Repeating Rifle Co. Ltd.)

Recoil-operated firearm 634,913 17 Oct 1899 (Roth &amp; Krnka)

Automatic firearm 975,256 8 Nov 1910

Automatic firearm 1,018,914 27 Feb 1912

Automatic firearm 1,166,913 4 Jan 1916

**KRNKA REPEATING ARMS CO. LTD.—LONDON, ENGLAND (\*)**Straight-pull breech loading gun 441,673 2 Dec 1890  
(Silvester & Karl Krnka)**KRNKA, SILVESTER—PRAGUE, AUSTRIA-HUNGARY**Gun, straight-pull breech loading 441,673 2 Dec 1890  
(Silvester & Karl Krnka) (Assigned to Krnka Repeating Rifle Co. Ltd.)**KRUM, ALFRED—BERLIN, GERMANY**Automatic gun 2,230,328 4 Feb 1941 (Krum & Herlach)  
(Assigned to Rheinmetall-Borsig Aktiengesellschaft)**KRUPP, FRIED., A. G. See FRIED. KRUPP A. G.****KRZYZANOWSKI, THEODORE R.—PHILADELPHIA, PA.**

Antiaircraft gun 1,297,699 18 March 1919 (Assigned 1/10 to Gliwski, Frank and 1/2 to Pinder, S. S.)

**KÜNG, ALBERT—ZÜRICH, SWITZERLAND**

Automatic gun 1,556,225 6 Oct 1925 (Assigned to Werkzeug-Maschinenfabrik Oerlikon)

**LAHTI, AIMO JOHANNES—JYVASKYLA, FINLAND**

Automatic firearm 1,895,719 31 Jan 1933

Machine gun 1,987,939 15 Jan 1935

**LAIRD, CHARLES WILLIAM—LONDON, ENGLAND**

Cartridge belt 1,150,435 17 Aug 1915 (Laird, Menteyne and Degaille)

**LALOIX, RENE—BRUSSELS, BELGIUM**

Automatic rapid-fire gun 2,136,512 15 Nov 1938

Barrel fastening means 2,121,171 21 June 1938

Automatic repeating gun 2,017,283 15 Oct 1935

Machine gun 2,115,861 3 May 1938

Machine gun 2,141,537 27 Dec 1938

**LARSSON, CARL ALFRED—LONDON, ENGLAND**

Automatic gun 1,468,262 18 Sep 1923 (Dawson, Buckham &amp; Larsson) (Assigned to Vickers)

Automatic gun 1,553,992 15 Sep 1925 (Dawson, Buckham &amp; Larsson) (Assigned to Vickers)

Articulated link for the cartridge belts of machine guns 1,550,787 25 Aug 1925 (Dawson, Buckham &amp; Larsson) (Assigned to Vickers)

Gas-operated machine gun and automatic small arm 1,811,693 (Larsson &amp; Higson) (Vickers)

Drum magazine for machine guns and automatic small arms 1,811,694 23 June 1931 (Larsson &amp; Higson) (Assigned to Vickers Armstrong Ltd.)

Machine gun and automatic small arms 1,846,035 9 Feb 1932 (Larsson &amp; Higson) (Vickers)

Machine gun 2,013,312 3 Sep 1935 (Larsson &amp; Higson) (Assigned to Vickers)

Machine gun 2,048,395 21 July 1936 (Larsson &amp; Higson) (Assigned to Vickers)

Machine gun 2,037,244 14 April 1936 (Larsson &amp; Higson) (Assigned to Vickers)

Machine gun and magazine therefor 2,113,793 12 April 1938 (Larsson &amp; Higson) (Assigned to Vickers)

**LAUBER, OTTO—ESSEN-ON-THE-RUHR, GERMANY**

Recoil gun 809,821 9 Jan 1906 (Assigned to Fried. Krupp Aktiengesellschaft)

Recoil gun 923,051 25 May 1909 (Lauber &amp; Bominghaus) (Assigned to same)

**LAUF, HANS—BERLIN, GERMANY**

Gas-operating loading device 2,119,169 31 May 1938 (Assigned to Knorr-Bremse)

**LEE, JAMES P.—ILION, N.Y.**

Gun, straight-pull bolt 506,319 10 Oct 1893

Gun, straight-pull bolt 506,320 10 Oct 1893

Gun, straight-pull bolt 506,321 10 Oct 1893

**LEE, JAMES PARIS—HARTFORD, CONN. (\*)**

Gun, straight-pull bolt 506,339 10 Oct 1893 (Richards)

**LEET, C. D.—VIENNA, AUSTRIA**

Metallic cartridge 98,278 28 Dec 1869 (Hotchkiss)

**LEMEI, ALEXANDER—AMSTERDAM, NETHERLANDS**Cartridge belt for machine guns 1,136,956 27 Apr 1915  
(Henneveld & Lemei)

- LANG, CHARLES WELLINGTON—PHILADELPHIA, PA.**  
 Rapid-fire gun 1,329,979 3 Feb 1920  
 Rapid-fire gun 1,359,608 23 Nov 1920  
 Cartridge feed mechanism for breech-loading firearms  
 1,359,607 23 Nov 1920
- LEONARD, HARVEY REID—SAN FRANCISCO, CALIF.**  
 Machine gun 207,747 3 Sep 1878 (Assigned to Abraham  
 Rosenberg)
- LESNICK, ROBERT N.—BROOKLYN, N.Y.**  
 Gun ammunition magazine 2,364,510 5 Dec 1944 (Ber-  
 tran & Lesnick) (Assigned to Brewster Aeronautical  
 Corp.)
- LEVE, CHARLES—CANNES, FRANCE**  
 Automatic gun 1,738,439 3 Dec 1929
- LEWIS, ISAAC NEWTON—FORTRESS MONROE, VA.**  
 Air-cooled automatic firearm 1,004,666 3 Oct 1911  
 Automatic firearm 1,142,896 15 June 1915  
 Gas regulator and trap for automatic gas-operated firearms  
 1,195,693 22 Aug 1916 (Assigned to Automatic Arms  
 Co.)
- LEWIS, JOHN—RAWLINS, WYO. (\*)**  
 Automatic gun 718,062 8 Jan 1903 (Weed)
- LIEBENFELD, LOUIS—LOUISVILLE, MISS. (\*)**  
 Machine gun 282,787 7 Aug 1883 (Shields)
- LINDER, FRIEDRICH—DUSSELDORF, GERMANY**  
 Firearm with exchangeable barrel 2,014,184 10 Sep 1935  
 (Assigned to Rheinische Metallwaren und Maschinen-  
 fabrik)
- LINDSEY, BEN G.—JASPER, TEXAS (\*)**  
 Machine gun 1,959,737 22 May 1934 (Rigsby)
- LIPPERT, HANNS—ZÜRICH, SWITZERLAND**  
 Automatic firearm 2,380,455 31 Jul 1945 (Lippert &  
 Hepperle)  
 Automatic firearm breech bolt lock 2,512,027 20 Jun 1950  
 (Lippert and Muhlemann) (Assigned to Oerlikon Co.)  
 Automatic firearm breech bolt locking mechanism 2,523,704  
 26 Sep 1950 (Lippert & Hepperle) (Assigned to  
 Oerlikon Co.)
- LJUNGMAN, J. C. AKTIEBOLAGET. See AKTIEBOLAGET J. C. LJUNG-  
 MAN**
- LJUTIC, ALBERT V.—VERONA, CALIF.**  
 Gas-operated automatic rifle 2,456,290 14 Dec 1948
- LOCHHEAD, JOHN L.—SPRINGFIELD, MASS.**  
 Machine gun 2,205,426 2 Mar 1938  
 Reversible feed mechanism for machine guns 2,504,994 25  
 Apr 1950
- LOCAN, HUMPHREY THOMAS—LONDON, ENGLAND**  
 Machine gun and the like 1,318,214 7 Oct 1919
- LOMBARD, LEVI W.—MATTAPAN, MASS.**  
 Centrifugal gun 1,420,660 27 June 1922 (Assigned to  
 Centrifugal Gun Corp.)
- LOUIS, CHARLES W.—SPRINGFIELD, MASS.**  
 Firearm, Automatic magazine 900,865 13 Oct 1908 (As-  
 signed to Edward R. Buck)
- LOVASZ, JOSEF—BUDAPEST, AUSTRIA-HUNGARY**  
 Automatic breech-loading firearm 1,073,908 23 Sep 1913  
 (Kiraly & Lovasz)
- LOVELACE, CHARLES D.—FORT WORTH, TEX.**  
 Recoil gun 922,173 18 May 1909
- LUCAS, OWEN DAVIS—LONDON, ENGLAND**  
 Machine gun and similar weapon 1,412,252 11 Apr 1922  
 (Martin & Lucas) (Assigned to M. L. Experimental Ltd.)  
 Means for controlling the rate of fire of automatic guns car-  
 ried by aircraft 1,486,909 18 Mar 1924 (Assigned to  
 Vickers Ltd.)
- LUCINANI, JACQUES—PARIS, FRANCE**  
 Multiple-barrel machine gun 1,319,882 28 Oct 1919 (As-  
 signed to Solms, W. J.)
- LUDORF, ERNST—BERNE, SWITZERLAND**  
 Machine gun 1,446,388 20 Feb 1923
- LUGER, GEORG—CHARLOTTENBURG, GERMANY**  
 Recoil-operated firearm 839,778 25 Dec 1906  
 Cartridge having multipart projectiles 926,431 29 June  
 1909  
 Recoil-operated firearm 851,538 23 Apr 1907
- LUTTON, GEORGE E.—KALISPELL, MONT.**  
 Automatic rifle 1,886,113 1 Nov 1932
- LYMAN, A. S.—NEW YORK, N.Y.**  
 Gun, Accelerating 200,740 26 Feb 1878 (Assigned to  
 Accelerating Fire Arms Co.)
- LYTTON, EDWARD—LONDON, ENGLAND**  
 Firing mechanism for small arms 1,240,068 11 Sep 1917
- M. L. EXPERIMENTAL LTD.—LONDON, ENGLAND (\*)**  
 Machine gun and similar weapon 1,412,252 11 Apr 1922  
 (Martin & Lucas)
- MAHER, EDMUND—NEW YORK, N.Y.**  
 Improvement in repeating ordnance 33,813 26 Nov 1861  
 (McCord & Maher)  
 Improvement in repeating firearms 33,167 6 May 1862
- MAILLARD, BERNARD—GENEVA, SWITZERLAND**  
 Gas piston operated firearm 2,494,889 17 Jan 1950 (As-  
 signed to Brevets Acro-Mecaniques S. A.)  
 Ammunition charging device for automatic arms 2,503,116  
 4 Apr 1950 (Assigned to Brevets Acro-Mecaniques S. A.)  
 Pivoted breech bolt lock 2,522,628 19 Sep 1950 (Assigned  
 to Brevets Acro-Mecaniques S. A.)
- MANCINI, NICCOLO—FLORENCE, ITALY**  
 Detachable feed belt for automatic firearms 2,016,750 8  
 Oct 1935  
 Automatic firearm 2,016,646 8 Oct 1935
- MANGLE, ST. OMER—BOSTON, MASS.**  
 Automatic firearm 896,453 18 Aug 1909

**MANNLICHER, FERDINAND RITTER VON—VIENNA, AUSTRIA-HUNGARY**

Feed mechanism for magazine guns 518,821 24 Apr 1894  
 Automatic firearm 581,295 27 Apr 1897  
 Automatic firearm 581,296 27 Apr 1897  
 Automatic firearm 728,739 19 Mar 1903

**MAREK, ANTON—VIENNA, AUSTRIA**

Automatic firearm 1,906,800 2 May 1933 (Assigned to Ceskoslovenska Zbrojovka Akciová Společnost v. Brne)  
 Self-loading firearm 1,960,913 29 May 1934 (Assigned as above)

**MARGA, ULDARIQUE A.—BRUSSELS, BELGIUM**

Automatic firearm 1,456,811 29 May 1923

**MARINER, NORMAN E.—BEVERLY, MASS.**

Magazine for machine guns 2,489,428 29 Nov 1949 (Assigned to United Shoe Machinery Corp.)

**MARLIN FIRE ARMS CO.—NEW HAVEN, CONN. (\*)**

Repeating firearm 882,561 24 Mar 1908 (Hepburn)  
 Automatic firearm 1,402,459 3 Jan 1922 (Swebilius)  
 Automatic gun 1,450,653 3 Apr 1923 (Swebilius)  
 Automatic gun 1,441,890 13 Feb 1923 (Swebilius)  
 Automatic firearm 1,521,730 6 Jan 1925 (Swebilius)  
 Automatic gun 1,565,756 15 Dec 1925 (Rockwell)  
 Automatic firearm 1,550,759 25 Aug 1925 (Swebilius)  
 Automatic firearm 1,550,760 25 Aug 1925 (Swebilius)  
 Automatic gun 1,558,566 27 Oct 1925 (Rockwell)

**MARS AUTOMATIC FIRE ARMS SYND. LTD.—LONDON, ENGLAND (\*)**

Recoil-operated firearm 600,066 1 Mar 1898 (Gabbett-Fairfax)

**MARTIN, HELMUTH PAUL—LONDON, ENGLAND**

Machine gun and similar weapon 1,412,252 11 Apr 1922 (Martin & Lucas) (Assigned to M. L. Experimental Ltd.)

**MARTIN, JAMES—HIGHIER DENHAM, ENGLAND**

Cartridge feeding mechanism for automatic cannon 2,522,457 12 Sep 1950

**MARTIN, JOHN—IMPERIAL, CALIF.**

Rapid-firing gun 1,285,765 26 Nov 1918 (Assigned 1/2 to Jose de Barros)

**MARTIN, JOSEPH—LOUISVILLE, KY.**

Machine by which the centrifugal force is controlled in throwing balls and other bodies 1,713 3 Aug 1840

**MARTIN, THOMAS—ST. ETIENNE, FRANCE**

Automatic firearm 935,672 5 Oct 1909

**MARTIN, WILLIAM—SEATTLE, WASH. (\*)**

Gas-operated gun 1,308,016 24 June 1919 (Clark)

**MARTINEAU, JOSEPH A. E.—BRITISH COLUMBIA, CANADA**

Rotary barrel gun 2,406,089 20 Aug 1946

**MARTINEZ-SILVA, LUIS—BOGOTA, COLUMBIA**

Automatic mechanism for firearms 1,233,096 10 July 1917

**MASCARUCCI, GIUSEPPE—TURIN, ITALY**

Automatic firearm with recoiling barrel and without movable breech 1,733,231 29 Oct 1929 (Assigned to Società Anonima Fabbrica Armi-Torino)  
 Device for reducing the rate of fire of automatic firearms 1,771,132 22 July 1930 (Assigned to Società Anonima Fabbrica Armi-Torino)

**MASON, WILLIAM—NEW HAVEN, CONN.**

Magazine for firearms 285,284 18 Sep 1883 (Assigned to Winchester Repeating Arms Co.)  
 Gas-operated gun 525,151 28 Aug 1894 (Assigned to Winchester Repeating Arms Co.)  
 Automatic firearm 695,784 18 Mar 1902 (Bennett & Mason) (Assigned to Winchester Repeating Arms Co.)  
 Gun, Tubular magazine automatic 874,856 24 Dec 1907 (Assigned to Winchester Repeating Arms Co.)  
 Gas-operated gun 877,657 28 Jan 1908 (Assigned to Winchester Repeating Arms Co.)  
 Gas-operated gun 885,166 21 Apr 1908 (Assigned to Winchester Repeating Arms Co.)  
 Automatic firearm 846,591 12 Mar 1907 (Assigned to Winchester Repeating Arms Co.)  
 Automatic firearm 854,707 21 May 1907 (Assigned to Winchester Repeating Arms Co.)

**MATTHEWS, J. A.—ST. LOUIS, MO.**

Improvement in repeating ordnance 29,437 31 July 1860 (Assigned to Heraph)

**MATHEWS, T.—LEWISBURGH, W.VA. (\*)**

Machine gun 130,098 30 July 1872 (Wood)

**MAUSER A. G. See WAFFENFABRIK MAUSER A. G.****MAUSER, PAUL—OBERNDORF, GERMANY**

Breech-loading firearm 78,603 2 June 1868 (Norris & Mauser)  
 Recoil-operated firearm 584,479 15 June 1897  
 Recoil-operated firearm 639,421 19 Dec 1899  
 Automatic gun 1,014,660 16 Jan 1912  
 Ejector device for automatic firearm 1,035,210 13 Aug 1912  
 Automatic firearm 1,091,857 31 Mar 1914  
 Device for automatic firearms for shooting with blanks 1,092,157 7 Apr 1914  
 Automatic firearm 1,107,815 18 Aug 1914  
 Automatic firearm 1,125,578 19 Jan 1915  
 Automatic firearm 1,130,312 2 Mar 1915  
 Automatic firearm 1,131,721 16 Mar 1915  
 Firing mechanism for automatic firearms 1,150,611 17 Aug 1915  
 Rotatable breech bolt for automatic firearms 1,180,784 25 Apr 1916 (Assigned to Waffenfabrik Mauser Aktiengesellschaft)  
 Rotatable lug bolt firearm 1,180,785 25 Apr 1916 (Assigned to Waffenfabrik Mauser Aktiengesellschaft)  
 Firearm 1,217,974 6 Mar 1917 (Assigned to Waffenfabrik Mauser Aktiengesellschaft)  
 Means for combining the barrel with the receiver in connection with firearms 1,234,783 31 July 1917 (Assigned to Waffenfabrik Mauser Aktiengesellschaft)

## MAUSER, WILHELM—WURTEMBERG, GERMANY

Breech-loading firearm 78,603 2 June 1868 (Norris & Mauser)

## MAXIM, HIRAM PERCY—HARTFORD, CONN.

Silencer for firearm 880,386 25 Feb 1908  
 Silencer for firearm 916,885 30 Mar 1909 (Assigned to Maxim Silent Firearms Co.)  
 Silent firearm 958,934 24 May 1910 (Assigned to Maxim Silent Firearms Co.)  
 Silent firearm 958,935 24 May 1910 (Assigned to Maxim Silent Firearms Co.)  
 Silencer or device 1,018,720 27 Feb 1912 (Assigned to Maxim Silent Firearms Co.)  
 Silencer for guns 1,482,805 5 Feb 1924

## MAXIM, HIRAM STEVENS—LONDON, ENGLAND

Automatic machine gun 551,779 24 Dec 1895 (Maxim & Silverman)  
 Machine gun 317,161 5 May 1885 (Assigned to Vickers & Symon)  
 Machine gun 319,596 9 June 1885  
 Machine gun 321,513 7 July 1885  
 Machine gun 321,514 7 July 1885  
 Machine gun 367,825 9 Aug 1887  
 Automatic gun 430,210 17 June 1890  
 Machine gun 439,248 28 Oct 1890  
 Machine gun 395,791 8 Jan 1889  
 Automatic machine gun 430,211 17 June 1890  
 Automatic gun 593,228 9 Nov 1897 (Assigned to Maxim-Nordenfelt Guns and Ammunition Co. Ltd.)  
 Automatic gun 436,899 23 Sep 1890  
 Recoil-operated gun 579,401 23 Mar 1897  
 Automatic gas-operated gun 577,485 23 Feb 1897  
 Gas-operated gun 586,362 13 July 1897

## MAXIM MUNITION CORP.—NEW YORK, N.Y. (\*)

Recoil-operated firearm 1,228,827 5 June 1917 (Saalfeld)

## MAXIM-NORDENFELT GUNS &amp; AMMUNITION CO. LTD.—LONDON, ENGLAND (\*)

Automatic gun 593,228 9 Nov 1897 (Maxim)  
 Gas-operated automatic gun 577,485 23 Feb 1897 (Maxim)  
 Gas-operated gun 596,362 13 July 1897 (Maxim)

## MAXIM SILENT FIREARMS CO.—NEW YORK, N.Y. (\*)

Silent firearm 916,885 30 Mar 1909 (Maxim, H. P.)  
 Silent firearm 958,935 24 May 1910 (Maxim, H. P.)  
 Silent firearm 958,935 24 May 1910 (Maxim, H. P.)  
 Silencing device for firearms 1,018,720 27 Feb 1912 (Maxim, H. P.)  
 Gun silencer 2,375,617 8 May 1945 (Bourne)

## MAYALL, THOMAS J.—ROXBURY, MASS.

Improvement in breech-loading ordnance 30,335 9 Oct 1860  
 Improvement in ordnance 30,742 27 Nov 1860  
 Improvement in ordnance 32,376 21 May 1861

## MCABOY, ISAAC E.—HUNTINGTON, W.VA.

Automatic rapid-firing gun 566,214 18 Aug 1896

## MCALLISTER, ALBERT H.—COTTON PLANT, MISS.

Machine gun 201,810 26 Mar 1878  
 Machine gun 674,811 21 May 1901 (Assigned to McAllister Machine Gun Co.)

## MCALLISTER MACHINE GUN CO.—MEMPHIS, TENN. (\*)

Machine gun 674,811 21 May 1901 (McAllister)

## MCCARTY, ROBERT—NEW YORK, N.Y.

Machine for throwing balls, shot etc. 1,049 31 Dec 1838

## MCCLEAN ARMS &amp; ORDNANCE CO.—CLEVELAND, OHIO (\*)

Gas-operated automatic firearm 816,591 3 Apr 1906 (McCLean)  
 One-pounder machine gun 859,745 2 July 1907 (McCLean)

## MCCLEAN, SAMUEL NEAL—CLEVELAND, OHIO

Gas-actuated magazine gun 785,971 28 Mar 1905  
 Gas-operated gun 785,974 28 Mar 1905  
 One-pounder machine gun 858,745 2 July 1907 (Assigned to McCLean Arms & Ord. Co.)  
 Gas-operated gun 1,003,632 19 Sep 1911 (Assigned to Automatic Arms Co.)  
 Gas-operated machine gun 1,005,263 10 Oct 1911 (Assigned to Automatic Arms Co.)  
 Automatic machine gun 1,042,135 22 Oct 1912 (Assigned to Automatic Arms Co.)  
 Breech-loading and discharge-actuated firearm 1,042,363 22 Oct 1912 (Assigned to Automatic Arms Co.)  
 Gas-operated firearm 783,453 28 Feb 1905  
 Gas-operated automatic firearm 816,591 3 Apr 1906 (Assigned to McCLean Arms and Ordnance Co.)

## MCCLURE, ADOLPHUS C.—KEITHVILLE, LA.

Automatic repeating firearm 1,075,431 14 Oct 1913

## MCCORD, WILLIAM—SING SING, N.Y.

Improvements in firearms 31,933 2 Apr 1861 (McCord, Cox & Woodward)  
 Improvement in repeating ordnance 33,813 26 Nov 1861 (McCord & Maher)

## MCCRUDEN, JOHN CHARLES R.—HURSTVILLE, NEW SOUTH WALES, AUSTRALIA

Machine gun 1,406,404 14 Feb 1922  
 Machine gun 1,452,123 17 Apr 1923

## MCCULLOCH, THOMAS—LONDON, ENGLAND

Machine gun 446,807 17 Feb 1891 (Armit)

## MCLAIN, ROBERT M.—HUNTSVILLE, ALA.

Machine gun 1,375,653 19 Apr 1921 (McLain & Quick)  
 (Assigned to the Quick-McLain Machine Gun Co.)

## MCLEAN, JAMES HENRY—ST. LOUIS, MO. (\*)

Machine gun 225,462 16 Mar 1880 (Coloney)  
 Machine gun 225,466 16 Mar 1880 (Coloney)  
 Machine gun 231,653 31 Aug 1880 (Coloney)  
 Machine gun 282,549 7 Aug 1883 (Coloney)  
 Machine gun 231,652 31 Aug 1880 (Coloney)

## MCLEAN, JAMES HENRY—ST. LOUIS, MO.

Machine gun 282,551 7 Aug 1883  
 Machine gun 282,553 7 Aug 1883

**McMANUS, LUIS M.—HOUSTON, TEX.**

Machine gun 1,273,078 16 July 1918 (Assigned to Warner, James H.)

**McNAIER, JOSEPH TREANOR—NEW YORK, N.Y.**

Centrifugal machine gun and method for feeding same 1,472,080 30 Oct 1923

**MEINERSMANN, WILLIAM—ELIZABETH, N.J.**

High velocity gun 1,326,763 30 Dec 1919

**MEJEAN, JACQUES G.—GENEVA, SWITZERLAND**

Gun actuator 2,341,641 15 Feb 1944 (Assigned to General Aircraft Equipment Co.)

**MEJIA, ENRIQUE A.—MEXICO CITY, MEXICO**

Improvement in many-barreled guns 62,281 19 Feb 1867

**MENDOZA, RAFAEL—MEXICO CITY, MEXICO**

Machine gun bolt mechanism 2,031,383 18 Feb 1936

**MENTEYNE, PAUL MARIE—PARIS, FRANCE**

Automatic firearm 1,059,680 22 Apr 1913 (Menteyne & Degaille)

Automatic firearm 981,210 10 Jan 1911 (Menteyne & Degaille)

Cartridge belt 1,150,435 17 Aug 1915 (Laird, Menteyne & Degaille)

**MERCIE, HENRI A.—PARIS, FRANCE**

Automatic machine gun 564,043 14 July 1896 (Benét & Mercié) (Assigned to Hotchkiss Ordnance Co. Ltd.)

Gas-operated gun 588,380 17 Aug 1897 (Benét & Mercié) (Assigned to Hotchkiss Ordnance Co. Ltd.)

Semi automatic gun 649,393 8 May 1900 (Benét & Mercié)

Automatic gun 696,306 25 Mar 1902 (Benét & Mercié)

Gas-operated gun 861,939 30 Jan 1907 (Benét & Mercié)

Semi-automatic gun 852,253 30 Apr 1907 (Benét & Mercié)

Firing gear 854,557 21 May 1907 (Benét & Mercié)

Automatic shoulder rifle 1,125,937 26 Jan 1915 (Benét & Mercié)

Automatic firearm 1,317,633 30 Sep 1919 (Squire & Mercié) (Assigned to Hotchkiss Ordnance Co. Ltd.)

**MERSHON, RALPH S.—PHILADELPHIA, PA.**

Self-cocking firearm 39,835 8 Sep 1863 (Hollingsworth)

**MERTENS, LUDWIG—LONDON, ENGLAND**

Non-recoiling firearm 891,778 23 June 1908

**METALLURGICA BRESCIANA GIA TEMPINI—BRESCIA, ITALY (\*)**

Automatic firearms actuated by compressed air 1,803,946 5 May 1931 (Revelli)

Device for loading firearms 1,812,363 30 June 1931 (Orlando)

**METHILIEN, NICOLAS E.—PARIS, FRANCE**

Multibarrel gun 1,535,619 28 Apr 1925 (Assigned to Schneider & Cie)

**MEYER, FRANCIS ED.—NEW YORK, N.Y. (\*)**

Machine gun 208,203 17 Sep 1878 (Schultze)

Machine gun 208,204 17 Sep 1878 (Schultze)

**MICHAL, CHARLES J.—HINSDALE, ILL.**

Machine gun 2,139,691 13 Dec 1938

Machine gun 2,223,380 3 Dec 1940

**MICLAUS, ALEXANDER, JR.—WASHINGTON, D.C.**

Automatic gun 1,136,695 20 Apr 1915

**MILG, ARMAND—HEIDELBERG, GERMANY**

Recoil-operated firearm 533,911 12 Feb 1895

**MILBURN, NATHAN L.—ST. LOUIS, MO.**

Improvement in revolving ordnance 57,751 4 Sep. 1866

**MILES, W. A.—SALISBURY, CONN.**

Machine gun 129,976 30 July 1872

**MILLER, JOHN A.—PADUCAH, KY.**

Improvement in breech-loading ordnance 46,257 7 Feb 1865

**MILLS, MORGAN R.—RICHMOND, VA. (\*)**

Machine gun 1,698,228 8 Jan 1929 (Harring)

**MILTIMORE, ALONZO E.—U.S. ARMY**

Improvement in battery guns 145,224 2 Dec 1873

Improvement in battery guns 181,093 15 Aug 1876

**MISKUNAS, ANTON—OGLESBY, ILL.**

Machine gun 1,441,517 9 Jan 1923

**MONFORT, EDGAR A.—NEW YORK, N.Y.**

Electric cartridge 365,842 5 July 1887 (Assigned to Universal Electric Arms & Ammo. Co.)

Electrical breech-loading firearm 365,843 5 July 1887 (Assigned to Universal Electric Arms & Ammo. Co.)

**MONGARDI, GIOVANNI—SOMERVILLE, MASS.**

Automatic firearm 1,296,204 4 Mar 1919

**MONNER, RAY J.—DENVER, COLO.**

Machine gun cooling means 2,416,768 4 Mar 1947 (Assigned to Sorensen)

**MONTIGNY, JOSEPH—BRUSSELS, BELGIUM**

Machine gun 121,277 28 Nov 1871 (Christophe)

**MOORE, FREDERICK T.—EAST HARTFORD, CONN.**

Magazine feed mechanism for machine guns 1,719,126 2 July 1929 (Pfeiffer & Moore) (Assigned to Colt's Patent Firearms Mfg. Co.)

Gas-operated automatic firearm 1,738,501 3 Dec 1929 (Pfeiffer & Moore) (Assigned to Colt's Co.)

Barrel mounting for firearms 1,738,500 3 Dec 1929 (Pfeiffer & Moore) (Assigned to Colt's Patent Firearms Mfg. Co.)

Trigger mechanism for machine guns 1,738,502 31 Dec 1929 (Pfeiffer & Moore) (Assigned to Colt's Patent Firearms Mfg. Co.)

Reversible feed mechanism for machine guns 1,803,351 5 May 1931 (Pfeiffer & Moore) (Assigned to Colt's Patent Firearms Mfg. Co.)

Firing mechanism for machine guns 1,966,592 17 July 1934 (Pfeiffer & Moore) (Assigned to Colt's)

Automatic firearm 2,050,538 11 Aug 1936 (Pfeiffer & Moore) (Assigned to Colt's)

- Firing mechanism for machine guns 2,050,539 11 Aug 1936 (Lansley & Moore) (Assigned to Colt's)
- Machine gun & attachment therefor 2,061,313 17 Nov 1936 (Assigned to Colt's)
- Machine gun 2,110,165 8 Mar 1938 (Assigned to Colt's)
- Machine gun 2,140,809 20 Dec 1938 (Assigned to Colt's)
- Firing mechanism for automatic firearms 2,335,688 30 Nov 1943 (Assigned to Colt's)
- MOORE, HERBERT P.—NORWALK, OHIO**  
Silencer for firearms 1,080,154 2 Dec 1913
- MOORE, ROBERT A.—CHICAGO, ILL.**  
Silencer for firearms 956,717 3 May 1910 (Assigned to the Moore Silencer Co.)  
Silencer for firearms 1,021,742 26 Mar 1912  
Automatic firearm 1,376,456 3 May 1921
- MOORE SILENCER CO.—NEW YORK, N.Y. (\*)**  
Silencer for firearms 956,717 3 May 1910 (Moore)
- MORRIS, RICHARD—BLACKHEATH, ENGLAND**  
Machine gun 353,231 23 Nov 1886
- MOTTIN, WILLIE F.—NOEL, MO.**  
Machine gun 1,290,842 7 Jan 1919
- MOSES, H. O.—LYNN, MASS. (\*)**  
Machine gun 563,701 7 July 1896 (Wilder)
- MÜHLEMANN, ERNST—ZÜRICH, SWITZERLAND**  
Bearing surface for breech bolts in automatic firearms 2,509,013 23 May 1950 (Assigned to Oerlikon Co.)  
Automatic firearm breech bolt lock 2,512,027 20 Jun 1950 (Lippert & Mühlemann) (Assigned to Oerlikon Co.)
- MÜLLER, BERNHARD—WINTERTHUR, SWITZERLAND**  
Automatic firearm 802,582 24 Oct 1905
- MULNO, LESTER F.—WORCESTER, MASS.**  
Safety device for firearms 2,495,383 24 Jan 1950 (Assigned to Harrington & Richardson Arms Co.)
- MURPHY, JOHN L.—SPRINGFIELD, MASS.**  
Machine gun 427,239 6 May 1890
- MUSTELLI, ROBERTO—BRESCIA, ITALY**  
Automatic firearm 1,455,503 15 May 1923
- NARDIN, CELESTIN F.—WOODHAVEN, N.Y.**  
Automatic firearm 1,067,054 8 July 1913
- NATCHER, GABRIEL SIDNEY, OHIO**  
Improvement in many-barreled cannons 45,623 27 Dec 1864
- NAUGLER, WALTER E.—BEVERLY, MASS.**  
Gun charging mechanism 2,411,934 3 Dec 1946 (Assigned to United Shoe Machinery Corp.)  
Ammunition feeder 2,524,132 3 Oct 1950 (Naugler and Stacey) (Assigned to United Shoe Machinery Corp.)
- NEAL, ERNEST C.—CHICAGO, ILL.**  
Automatic firearm 2,436,175 17 Feb 1948
- NEELS, FRANK—DAVENPORT, IOWA**  
Machine gun 562,846 30 June 1896
- NELSON, ADOLPH L.—INDIANAPOLIS, IND.**  
Control mechanism for machine guns (aircraft) 1,562,424 17 Nov 1925
- NELSON, CHARLES A.—UTICA, N.Y.**  
Machine guns 1,256,923 19 Feb 1918 (Assigned to Savage Arms Corp.)  
Gas-operated firearm 1,388,879 30 Aug 1921 (Assigned to Savage Arms Corp.)
- NETTLES, ISAAC—DETROIT, MICH.**  
Gun with reciprocal breech and rotary feeder 2,483,837 4 Oct 1949
- NEWTON, CLARK A.—NEW YORK, N.Y.**  
Automatic gun 1,307,594 24 June 1919
- NEWTON, FREDERICK P.—NEW HAVEN, CONN. (\*)**  
Machine gun 430,206 17 June 1890 (Garland)  
Machine gun 479,799 2 Aug 1892 (Garland)
- NOBLE, ANDREW—NEWCASTLE, ENGLAND**  
Automatic gun 702,240 10 June 1902 (Assigned to Armstrong, Whitworth & Co., Ltd.)
- NOBLE, JOHN C.—WASHINGTON, PA.**  
Improvement in magazine gun 34,126 14 Jan 1862 (Brady)
- NORDENFELT, THORSTEN—LONDON, ENGLAND (\*)**  
Machine gun 218,190 5 Aug 1879 (Palmcrantz)  
Machine gun 220,545 14 Oct 1879 (Palmcrantz)
- NORDENFELT, THORSTEN—LONDON, ENGLAND**  
Machine gun 298,493 13 May 1884  
Machine gun 303,879 19 Aug 1884  
Machine gun 340,725 27 Apr 1886
- NORMAN, GEORGE—BIRMINGHAM, ENGLAND**  
Automatic firearm 1,637,234 26 July 1927 (Assigned to Birmingham Small Arms Co. Ltd.)  
Automatic firearm 1,637,235 26 July 1927 (Assigned to Birmingham Small Arms Co.)  
Automatic firearm 2,053,489 8 Sep 1936 (Assigned to Auto-Ordnance Corp.)
- NORRIS, SAMUEL—SPRINGFIELD, MASS.**  
Breech-loading firearm 78,603 2 June 1868 (W. & P. Mauser)
- NORTH, THOMAS KEPPEL—WESTMINSTER, ENGLAND**  
Feed system 723,719 24 Mar 1903
- NORTH AMERICAN AVIATION, INC.\***  
Gun blast seal 2,514,495 11 Jul 1950 (Johnson)
- NORTHOVER, HARRY ROBERT—WINNIPEG, MANITOBA, CANADA**  
Gas cylinder for machine guns 1,234,071 17 July 1917  
Retracting assembly 1,207,612 5 Dec 1916  
Flash absorber attachment for machine guns 1,242,843 9 Oct 1917
- NYVALL, YNGVE J.—SAN PEDRO, CALIF.**  
Firing mechanism for rifles 2,441,029 4 May 1948 (Nyvall & Chapman)



OBREGON, ALEJANDRO—MEXICO CITY, MEXICO

Automatic loading firearm 2,115,041 26 Apr 1938

ODKOLEK, ADOLF—VIENNA, AUSTRIA-HUNGARY

Magazine firearm 422,327 25 Feb 1890

Quick-firing gun 486,938 29 Nov 1892

Recoil-operated machine gun 452,403 16 June 1891

Automatic firearm 799,884 19 Sep 1905

OERLIKON, *See* WERKZEUG-MACHINENFABRIK OERLIKON

OESTERREICHISCHE WAFFENFABRIKSGESELLSCHAFT — STEYR, AUSTRIA (\*)

Gun lock for automatic firearms 1,387,369 9 Aug 1921  
(Duffek)

OLIN INDUSTRIES INC.—NEW HAVEN, CONN. (\*)

Piston means for gas-operated firearms 2,376,466 22 May 1945 (Williams)

Gas-operated self-loading firearm 2,394,986 19 Feb 1946  
(Crockett)

Cartridge extracting mechanism for firearms 2,412,663 17 Dec 1946 (Williams)

OLIVER, M. W.—LOWELL, MASS. (\*)

Improved automatic cannon 15,315 8 July 1856 (Barnes)

OLIVER, STACY—HARTFORD, CONN.

Automatic rifle 1,383,966 5 July 1921

O'MALLEY, JOHN F.—MERIDEN, CONN.

Machine gun 1,307,316 17 June 1919

Machine gun 1,329,922 3 Feb 1920

Machine gun 1,366,210 18 Jan 1921

ONDERDONK, JOHN P.—PHILADELPHIA, PA.

Recoil mechanism for firearms 294,402 4 Mar 1884

ORDNANCE DEVELOPMENT CO.—GORTON, CONN. (\*)

Aeroplane gun 1,108,714 25 Aug 1914 (Davis)

Apparatus for firing projectiles from aeroplanes 1,108,715  
25 Aug 1914 (Davis)

Apparatus for firing projectiles from aeroplanes 1,108,716  
25 Aug 1914 (Davis)

Fixed ammunition for use in aircraft 1,108,717 25 Aug 1914 (Davis)

ORLANDO, LUIGI—MILAN, ITALY

Device for loading firearms 1,812,363 30 June 1931 (Assigned to Metallurgica-Bresciana Gia Tempini)

ORMAN, BENJAMIN—BELVEDERE, ENGLAND

Automatic firearm 1,128,180 9 Feb 1915

OVER, EWALD—INDIANAPOLIS, IND. (\*)

Machine gun 560,842 26 May 1896 (Cook)

PAGE, J. H. W.—BOSTON, MASS. (\*)

Improvement in repeating cannons 46,762 7 Mar 1865  
(Tufts)

PALMCRANTZ, HELGE—STOCKHOLM, SWEDEN

Machine gun 218,190 5 Aug 1879 (Assigned to Nordenfelt)

Machine gun 220,545 14 Oct. 1879 (Assigned to Nordenfelt)

PALMER, CHARLES H.—LAKEVILLE, CONN.

Repeating gun 37,052 2 Dec 1862

PALMER, CHARLES H.—NEW YORK, N.Y.

Machine gun 332,741 22 Dec 1885

PALMER, WILLIAM—NEW YORK, N.Y.

Improvement in revolving firearms 41,857 8 Mar 1864

PARKER, WILLIAM H.—MILLVILLE, N.J.

Chamber loader indicator for firearms 2,416,712 4 Mar 1947

PARKHURST, EDWARD G.—HARTFORD, CONN.

Machine gun 228,777 15 June 1880 (Assigned to self and Pratt & Whitney Co.)

Machine gun 231,607 24 Aug 1880 (Assigned 1/2 to Pratt & Whitney Co.)

PARSONS, JOHN H.—RIDLEY PARK, PA.

Centrifugal gun 1,408,137 28 Feb 1922 (Assigned to Runnell & Normoyle)

PATCHETT, GEORGE W.—CHIGWELL, ENGLAND

Fire controlling mechanism for automatic firearms 2,432,486 9 Dec 1947

Cartridge magazine for automatic firearms 2,510,831 6 June 1950

PATRICK, LIDO J.—SAN DIEGO, CALIF.

Machine gun 1,347,753 27 July 1920

PAULSON, SIVIL—RED WILLOW, ALBERTA, CANADA

Automatic firearm 950,576 1 Mar 1910

PAULUS, CHARLES LEIGH—DAYTON, OHIO

Automatic advance for synchronizing gun control 1,471,378 23 Oct 1923 (Russell & Paulus)

Charging device for machine guns 1,471,348 23 Oct 1923

Control for synchronized guns 1,504,712 12 Aug 1924 (Russell & Paulus)

Automatic cocking attachment for machine guns 1,504,714 12 Aug 1924 (Russell & Paulus)

Synchronized gun control 1,523,952 10 Mar 1925 (Russell & Paulus)

Feed box for cartridge belts for machine guns 1,541,282 9 June 1925 (Russell & Paulus)

Machine gun synchronizer 1,592,500 13 July 1926 (Paulus & Kauch)

Lock mechanism for machine gun 1,427,855 5 Sep 1922 (Russell & Paulus)

PAUMIER, EMILE LOUIS ALBERT—PARIS, FRANCE

Machine gun 1,444,849 13 Feb 1923

PEARSON, HAROLD C.—DAYTON, OHIO

Bolt mechanism 2,503,575 11 Apr 1950 (Anderson & Pearson) (Assigned to General Motors Corp.)

PECK, HELEN R.—WASHINGTON, D.C. (\*)

Attachment for machine guns 1,320,711 4 Nov 1917 (Rasmussen)

PEDERSEN, JOHN D.—JACKSON, WYO.

Auto-loading firearm 1,348,733 3 Aug 1920

- PEDERSON, SIVERT—MENOMONEE, WISC.**  
Machine gun 264,897 26 Sep 1882
- PEGNA, GIOVANNI—REGGIO EMILIA, ITALY**  
Gun barrel 2,238,670 15 Apr 1941 (Travers & Pegna)  
(Assigned to Compagnia Commerciale Caproni)
- PELO, CARL—TAVASTEHUS, FINLAND**  
Light machine gun 1,897,710 14 Feb 1933
- PERINO, GIUSEPPE—ROME, ITALY**  
Machine gun 682,230 10 Sep 1901
- PERMENTIER, PAUL R.—CASABLANCA, MOROCCO**  
Thermostatically controlled firearm cooling system  
2,428,359 7 Oct 1947
- PETERSEN, CHARLES—SAN FRANCISCO, CALIF.**  
Automatic gun 754,691 15 Mar 1904
- PFEIFFER, CHRISTIAN—HARTFORD, CONN.**  
Feed mechanism for machine guns 1,719,126 2 July 1929  
(Pfeiffer & Moore) (Assigned to Colt's Patent Firearms  
Mfg. Co.)  
Trigger mechanism for machine guns 1,738,502 31 Dec  
1929 (Pfeiffer & Moore) (Assigned to Colt's)  
Speed regulator for machine guns 1,741,534 31 Dec 1929  
(Pfeiffer & Moore) (Assigned to Colt's)  
Reversible feed mechanism for machine guns 1,803,351 5  
May 1931 (Moore & Pfeiffer) (Assigned to Colt's)  
Automatic firearm 1,803,349 5 May 1931 (Moore &  
Pfeiffer) (Assigned to Colt's)
- PHELAN, JOHN—PITTSBURGH, PA.**  
Machine gun 249,204 8 Nov 1881 (Assigned 1/2 to  
Richardson, Ralph J.)
- PHILLIPS, HARRY—BEVERLY, MASS.**  
Firing mechanism for guns 2,440,381 27 Apr 1948 (As-  
signed to United Shoe Machinery Corp.)
- PODRABSKY, ANTONIN—BRUNN, CZECHOSLOVAKIA**  
Automatic gun 1,926,816 12 Sep 1933 (Assigned to  
Ceskoslovenska Zbrojovka)
- POTTER, LOUIS K.—WARWICK, R.I. (\*)**  
Automatic firearm 515,526 27 Feb 1891 (King)
- POTTS, ALBERT—PHILADELPHIA, PA.**  
Centrifugal battery 17,339 19 May 1857
- PRATHER, ANDREW T.—RODEO, N.MEX.**  
Attaching means for gun silencers 1,171,242 8 Feb 1916
- PRATT & WHITNEY Co.—HARTFORD, CONN. (\*)**  
Machine gun 228,777 15 June 1880 (Parkhurst)  
Machine gun 231,607 24 Aug 1880 (Parkhurst)
- PRIDEAUX, WILLIAM DE COURCY—WEYMOUTH, ENGLAND**  
Construction of links for ammunition belts for machine  
guns 1,305,160 27 May 1919  
Ammunition belt for machine guns 1,315,742 9 Sep 1919  
Ammunition belt for machine guns 1,305,161 27 May 1919
- PRINKE, CARL H.—BALTIMORE, MD.**  
Automatic firearm 875,209 31 Dec 1907  
Automatic firearm 904,646 24 Nov 1908
- PRITCHETT, WILLIAM H.—CARTERSVILLE, GA.**  
Automatic machine gun 1,297,240 11 Mar 1919
- PULLOCK, GRANVILLE ALEXANDER—PARIS, FRANCE**  
Means for cooling machine guns 1,527,585 24 Feb 1925  
(Hamilton, Joly & Pullock)
- PUTNAM, BURLEIGH—PASADENA, CALIF.**  
Machine gun 1,334,052 16 Mar 1920 (Assigned to John  
T. Thompson)  
Machine gun 1,429,370 19 Sept 1922
- QUICK-McLAIN MACHINE GUN Co.—HUNTSVILLE, ALA. (\*)**  
Machine gun 1,375,653 19 Apr 1921 (McLain & Quick)
- QUICK, WILLIAM M.—HUNTSVILLE, ALA.**  
Machine gun 1,375,653 19 Apr 1921 (McLain & Quick)  
(Assigned to Quick-McLain Machine Gun Co.)
- QUISLING, R. H.—CHRISTIANIA, NORWAY**  
Portable gun for throwing grenades and the like 1,087,608  
17 Feb 1914
- RAINES, RICHARD—NEW YORK, N.Y.**  
Machine gun 965,538 26 July 1910
- RAKULA, THEODOR—DUSSELDORF, GERMANY**  
Automatic firearm 1,709,399 16 Apr 1929 (Herlach &  
Rakula) (Assigned to Rheinische Metallwaren und  
Machinenfabrik)  
Automatic firearm with two cartridge magazines 1,784,355  
9 Dec 1930 (Herlach & Rakula) (Assigned to Rheinische  
Metallwaren und Maschinenfabrik)  
Automatic firearm 2,015,908 1 Oct 1935 (Rakula &  
Solothurn H.) (Assigned to Waffenfabrik Solothurn  
A. G.)  
Automatic gun 2,067,322 12 Jan 1937 (Herlach &  
Rakula) (Assigned to Waffenfabrik Solothurn A. G.)
- RAMSAY, JAMES—LONDON, ENGLAND**  
Muzzle attachment for automatic guns 870,497 5 Nov  
1907 (Dawson & Ramsay) (Assigned to Vickers Sons &  
Maxim Ltd.)
- RASMUSSEN, JULIUS ALEXANDER NICOLAI—COPENHAGEN, DENMARK**  
Automatic firearm 701,815 3 June 1902 (Assigned to  
Dansk Rekyl-Riffel Syndicate)
- RASMUSSEN, ERNEST J.—U.S. ARMY**  
Attachments for machine guns 1,320,711 4 Nov 1919 (As-  
signed 1/2 to Peck, H. R.)
- RAUCHFUSS, KURT V.—CUXHAVEN, GERMANY**  
Lateral dispersion device for machine guns 1,413,936 25  
Apr 1922 (Rauchfuss & Jaeschke)
- RAY, EUGENE J.—BEVERLY, MASS.**  
Gun ammunition magazine 2,447,092 17 Aug 1948 (As-  
signed to United Shoe Machinery Corp.)
- RECHEL, ERNEST R.—HUNTINGDON VALLEY, PA.**  
Method for making incendiary bullets 2,425,005 5 Aug  
1947
- REDFIELD, EDWARD E.—GLENDALE, ORE.**  
Automatic firearm 984,489 14 Feb 1911

**REDPATH, ROBERT—COVENTRY, ENGLAND**

Feed mechanisms for automatic machine guns 1,289,091  
(Redpath & Hellberg) (Assigned to Coventry Ordnance  
Works Ltd.)  
Automatic gun 1,315,329 9 Sep 1919 (Assigned to Cov-  
entry Ordnance Works Ltd.)

**REED, C. E.—HOUSTON, TEX. (\*)**

Recoil-operated firearm 1,453,439 1 May 1923 (Cedillo)

**REEK, ROYAL J.—SOUTH BEND, IND.**

Gun feed mechanism 2,379,185 26 June 1945 (Assigned  
to Bendix Aviation Corp.)

**REIFGRABER, JOSEPH J.—ST. LOUIS, MO.**

Automatic firearm 729,413 26 May 1903  
Automatic firearm 834,753 30 Oct 1906  
Automatic firearm 929,491 27 July 1909  
Automatic firearm 1,418,021 30 May 1922

**REMINGTON ARMS CO. INC.—BRIDGEPORT, CONN. (\*)**

Gun barrel straightness testing apparatus 2,422,294 17  
June 1947 (DuPont)

**REPUBLIC AVIATION CORPORATION (\*)**

Automatic locking ammunition container 2,506,409 2 May  
1950 (Baumwart)

**REINHOLD, FRANK W.—BEVERLY, MASS.**

Ammunition feeder 2,494,728 17 Jan 1950 (Stacey &  
Reinhold) (Assigned to United Shoe Machinery Corp.)

**REQUA, J.—ROCHESTER, N.Y.**

Improvement in battery or platoon weapons 36,448 16 Sep  
1862 (Billingshurst & Requa)

**REVELLI, BETHEL ABIL—ROME, ITALY**

Automatic gun 1,073,709 23 Sep 1913  
Automatic firearm 1,159,417 9 Nov 1915 (Assigned to  
Officine di Villar Perosa)  
Machine gun 1,286,884 3 Dec 1918 (Assigned to Officine  
di Villar Perosa)  
Automatic firearm 1,759,277 20 May 1930 (Assigned to  
Armamenti Militari S.A.)  
Automatic firearm actuated by compressed air 1,803,946  
5 May 1931 (Assigned to Metallurgica Bresciana Gia  
Tempini)  
Automatic rifle 1,854,064 12 Apr 1932

**REVELLI, GINO—ROME, ITALY**

Firing mechanism for automatic arms 2,356,615 22 Aug  
1944 (Assigned to Alien Property Custodian)

**REYNOLDS, JOHN A.—ELMIRA, N.Y.**

Improvement in firearms 13,292 17 July 1855  
Improved apparatus for cooling repeating firearms 13,294  
17 July 1855  
Improvements in firearms 13,293 17 July 1855

**RHEINISCHE METALLWAREN UND MASCHINENFABRIK—DÜSSEL-  
DORF, GERMANY (\*)**

Gun with recoiling gun barrel 855,366 28 May 1907  
(Voller)  
Breech mechanism for self-loading firearm 909,233 12 Jan  
1909 (Schmeisser)

Automatic firearm 956,430 26 Apr 1910 (Schmeisser)  
Automatic firearm 956,431 26 Apr 1910 (Schmeisser)  
Breech operating mechanism for automatic firearms  
1,002,764 5 Sep 1911 (Schmeisser)  
Automatic gun 1,033,625 23 July 1912 (Schmidt)  
Gun with long recoil 1,151,476 14 Aug 1915 (Klette)  
Automatic firearm 1,709,399 16 Apr 1929 (Herlach &  
Rakula)  
Automatic firearm 1,755,034 15 Apr 1930 (Stange)  
Automatic firearm with two cartridge magazines 1,784,353  
9 Dec 1930 (Herlach & Rakula)  
Automatic firearm 1,801,179 14 Apr 1931 (Stange)  
Automatic firearm 1,846,156 23 Feb 1932 (Stange)  
Automatic firearm 1,825,904 6 Oct 1931 (Heinemann)  
Firearm with exchangeable barrel 2,014,184 10 Sep 1935  
(Linder)  
Automatic gun 2,113,202 5 Apr 1938 (Stange)  
Automatic firing mechanism 887,713 12 May 1908 (Voller)

**RHEINMETALL-BORSIG A. G.—DÜSSELDORF, GERMANY (\*)**

Gun-loading device 2,151,288 21 Mar 1939 (Wagninger)  
Automatic firearm 2,133,661 18 Oct 1938 (Engel &  
Winter)  
Gun which fires during forward movement of the gun  
2,218,877 22 Oct 1940 (Ernesti & Herlach)  
Automatic gun 2,202,201 28 May 1940 (Henning)  
Automatic gun 2,230,328 4 Feb 1941 (Krum & Herlach)

**RICE, EDWARD E.—BOSTON, MASS. (\*)**

Automatic firearm 2,215,470 24 Sep 1940 (Johnson)

**RICE, WALTER J.—PHILADELPHIA, PA.**

Gas-operated automatic machine gun 1,294,892 18 Feb  
1919 (Fox & Rice) (Assigned to Ausley Fox Co.)

**RICE, WAYNE H.—WINDSOR, CONN.**

Self-loading firearm 38,604 19 May 1863

**RICHARDS, FRANCIS H.—HARTFORD, CONN.**

Gun, Straight-pull bolt 506,339 10 Oct 1893 (Assigned to  
James Paris Lee)

**RICHARDSON, RALPH J.—PITTSBURGH, PA. (\*)**

Machine gun 249,204 8 Nov 1881 (Phelan)

**RICHAY, DAVID M.—DEVON, CONN.**

Gun charger installation 2,431,079 18 Nov 1947 (As-  
signed to United Aircraft Corp.)

**RICHMOND, ROMULUS R.—CHARITON, IOWA**

Automatic machine gun 572,771 8 Dec 1896

**RICKENBACHER, ROBERT J.—COLUMBUS, OHIO**

Machine gun 2,039,930 5 May 1936 (Assigned to Kilgore  
Mfg. Co.)

**RIGSBY, VIRGIL—VEACH, TEX.**

Machine gun 1,959,737 22 May 1934 (Assigned 1/2 to  
Ben G. Lindsey)

**RIPLEY, EZRA—TROY, N.Y.**

Gun batteries, Improvements in repeating 33,544 22 Oct  
1861

- ROBERTS, FRED T.—LOS ANGELES, CALIF.  
Remote-control gun charger 2,397,507 2 Apr 1946 (Assigned to Interstate Aircraft & Engineering Corp.)
- ROBERTS, MILTON—CHICAGO, ILL. (\*)  
Recoil control of firearms 2,184,595 26 Dec 1939 (Hughes)
- ROBINSON, CHARLES—CAMBRIDGEPORT, MASS. (\*)  
Improvements in centrifugal guns 21,109 3 Aug 1858 (Thayer, C. B.)
- ROCKWELL, HUGH M.—BRISTOL, CONN.  
Automatic gun 1,565,756 15 Dec 1925 (Assigned to Marlin Firearms Corp.)  
Automatic gun 1,558,566 27 Oct 1925 (Assigned to Marlin Firearms Corp.)
- ROEMER, WILLIAM C.—NEW HAVEN, CONN.  
Self-loading firearm 2,372,339 27 Mar 1945 (Assigned to Western Cartridge Co.)
- ROHN, WILLIAM C.—SOUTH BEND, IND.  
Automatic machine gun charger 2,410,767 5 Nov 1946 (Wiseman & Rohn) (Assigned to Bendix Aviation Corp.)
- ROSEBUSH, WALDO E.—SPOKANE, WASH.  
Composite automatic firearm 1,377,629 10 May 1921
- ROSENBERG, ABRAHAM—SAN FRANCISCO, CALIF. (\*)  
Machine gun 207,747 3 Sep 1878 (Leonard)
- ROSENGREN, OVAR E.—HAMDEN, CONN.  
Machine gun fire retarder 2,509,530 30 May 1950 (Rosengren & Sunderland)
- ROSIER, HENRY—LOWELL, MASS.  
Automatic firearm 1,520,671 23 Dec 1924
- ROSNER, KARL—PRAGUE, CZECHOSLOVAKIA  
Aircraft gun 1,510,109 30 Sep 1921
- ROSS, CHARLES H. A. F. L.—BALNAGOWAN CASTLE, SCOTLAND  
Recoil-operated firearm 643,983 20 Feb 1900  
Automatic firearm 958,545 17 May 1910  
Breech-closing mechanism for automatic firearm 954,543 12 Apr 1910
- ROSS, OSCAR A.—NEW YORK, N.Y.  
Synchronized machine gun for aeroplanes 1,454,137 8 May 1923  
Synchronized machine gun 1,782,148 18 Nov 1930
- ROSSMANN, WOLFGANG—SOLOTHURN, SWITZERLAND  
Automatic shoulder firearm 2,376,726 22 May 1945 (Assigned to Alien Property Custodian)  
Cocking mechanism for automatic firearms 2,202,232 May 28 1940 (Assigned to Rheinmetall-Borsig)
- ROTH, GEORGES—VIENNA, AUSTRIA-HUNGARY  
Automatic firearm 616,260 20 Dec 1898  
Recoil-operated firearm 616,261 20 Dec 1898  
Recoil-operated firearm 634,913 17 Oct 1899 (Krnka & Roth)  
Automatic firearm 676,995 25 June 1901 (Krnka & Roth)  
Automatic firearm 681,737 3 Sep 1901  
Automatic firearm 683,072 24 Sep 1901 (Krnka & Roth)
- RUGER, WILLIAM B.—GREENSBORO, N.C.  
Machine gun 2,388,291 6 Nov 1945
- RUNDQUIST, HENNING W.—EAST LANSING, MICH.  
Cartridge feeding mechanism 2,418,428 1 Apr 1947 (Assigned to General Motors Corp.)
- RUSSELL, HERBERT O.—LOS ANGELES, CALIF. & DETROIT, MICH.  
Lock mechanism for machine guns 1,427,855 5 Sep 1922 (Russell & Paulus)  
Automatic advance for synchronizing gun control 1,471,359 23 Oct 1923 (Russell & Paulus)  
Control for synchronized guns 1,504,712 12 Aug 1924 (Russell & Paulus)  
Machine gun & hopper feed box 1,504,714 12 Aug 1924 (Russell & Paulus)  
Automatic cocking attachment for machine guns 1,504,717 12 Aug 1924 (Russell & Paulus)  
Cocking handle for aerial guns 1,528,950 10 Mar 1925 (Russell & Eyler)  
Synchronized gun control 1,528,952 10 Mar 1925 (Russell & Paulus)  
Electrical synchronizer and trigger motor for automatic machine guns 1,530,700 24 Mar 1925 (Russell & Fletcher)  
Sear and sear release for machine guns 1,530,702 24 Mar 1925  
Feed box for cartridge belts of machine guns 1,541,282 9 June 1925 (Russell & Paulus)
- RUSSELL MFG. CO.—MIDDLETOWN, CONN. (\*)  
Beltlike cartridge carrier for machine guns 1,168,876 18 Jan 1916 (Frissell)  
Machine gun feed belt 1,258,553 5 Mar 1918 (Frissell)  
Cartridge feed belt for machine guns 2,422,898 24 June 1947 (Hendley)
- RYAN, LESTER R.—PLYMOUTH, CONN.  
Cartridge belt link 2,423,346 1 July 1947 (Assigned to Autoyre Co.)
- SAALFIELD, OLIVER BERRY—WEST HOBOKEN, N.J.  
Recoil-operated firearm 1,228,827 5 June 1917 (Assigned to Maxim Munitions Corp.)
- SAFAT (SOCIETA ANONIMA FABRICA ARMI-TORINO)—TURIN, ITALY (\*)  
Automatic firearm with recoiling barrel and without moveable breech 1,733,231 29 Oct 1929 (Mascarucci)  
Device for reducing the rate of fire of automatic firearms 1,771,132 22 July 1930 (Mascarucci)
- SAIVE, DIEUDONNE J.—WANDRE, BELGIUM  
Tilt locking breechblock for automatic firearms 2,515,315 18 Jul 1950
- SALIGER, ALIUS B.—NEW YORK, N.Y.  
Centrifugal gun 1,311,465 29 July 1919 (Assigned to Intercontinental Co. of Calif.)
- SAN FRANCISCO ARMS CO.—SAN FRANCISCO, CALIF. (\*)  
Recoil operated firearm 574,189 29 Dec 1896 (Carr)  
Recoil-operated firearm 574,350 29 Dec 1896 (Catlin)  
Recoil-operated firearm 584,153 8 June 1897 (Carr)

- SANDERS SMALL ARMS LTD.—LONDON, ENGLAND (\*)  
Recoil-loading firearm 2,101,957 14 Dec 1937 (Sanders)
- SANDERS, THOMAS F.—SLOUGH TRADING ESTATE, ENGLAND  
Recoil-loading firearm 2,101,957 14 Dec 1937 (Assigned to Sanders Small Arms Ltd.)
- SANFORD, ROY S.—WOODBURY, CONN.  
Cartridge feeding mechanism 2,501,143 21 Mar 1950 (Assigned to Autoyre Co.)  
Feeding mechanism for automatic guns 2,502,891 4 Apr 1950 (Assigned to Autoyre Co.)
- SAVAGE ARMS CORP.—UTICA, N.Y. (\*)  
Machine gun 1,256,923 19 Feb 1918 (Nelson)  
Automatic firearm 2,357,047 29 Aug 1944 (Horan)  
Gas-operated firearm 1,388,879 30 Aug 1921 (Nelson)
- SAVAGE, HAROLD ARTHUR—BEXLEY-HEATH, ENGLAND  
Automatic gun 1,298,887 1 Apr 1919 (Challenger & Savage) (Assigned to Vickers Ltd.)
- SAYLER, DANIEL—ORLAND, CALIF.  
Gas gun 1,164,876 21 Dec 1915
- SCARFF, FREDERICK WILLIAM—LONDON, ENGLAND  
Machine gun mountings 1,364,525 4 Jan 1921 (Assigned to Vickers Ltd.)  
Gun mounting for use on aircraft 1,628,068 10 May 1927 (Assigned to Vickers Ltd.)
- SCHELLENGER, NEWTON C.—SALT LAKE CITY, UTAH  
Automatic firearm 1,029,720 18 June 1912
- SCHIRGUN CORP.—NEW YORK, N.Y. (\*)  
Gun barrel lock 2,345,833 4 Apr 1944 (Schirokauer)  
Gun mechanism 2,378,331 12 June 1945 (Schirokauer)
- SCHIROKAUER, HENRY—NEW YORK, N.Y.  
Gun barrel lock 2,345,833 4 Apr 1944 (Assigned to Schirgun Corp.)  
Gun mechanism 2,378,331 12 June 1945 (Assigned to Schirgun Corp.)
- SCHMEISSER, LOUIS—MANNHEIM, GERMANY  
Recoil-operated firearm 547,454 8 Oct 1895 (Assigned to Theodor Bergmann)  
Breech mechanism for self-loading firearm 909,233 12 Jan 1909 (Assigned to Rheinische Metallwaren und Maschinenfabrik)  
Automatic firearm 956,340 26 Apr 1910 (Assigned to Rheinische Metallwaren u. Maschinenfabrik)  
Automatic firearm 956,431 26 Apr 1910 (Assigned to Rheinische Metallwaren u. Maschinenfabrik)  
Automatic firearm 989,432 11 Apr 1911  
Breech operating mechanism for automatic firearms 1,002,764 5 Sep 1911 (Assigned to Rheinische Metallwaren u. Maschinenfabrik)  
Automatic firearm 1,077,760 4 Nov 1913
- SCHMIDT, FRANZ—DÜSSELDORF, GERMANY  
Automatic gun 1,033,625 23 July 1912 (Assigned to Rheinische Metallwaren und Maschinenfabrik)
- SCHNEIDER, ALOIS—SAN FRANCISCO, CALIF.  
Rifling, Guns 300,515 17 June 1884
- SCHNEIDER & CIE.—PARIS, FRANCE (\*)  
Apparatus for lubricating the bore of firearms during firing 1,481,930 29 Jan 1924 (Schneider)  
Multibarrel Gun 1,487,695 18 Mar 1924 (Schneider)  
Multibarrel Gun 1,535,619 28 Apr 1925 (Methlien)
- SCHNEIDER, CHARLES P. E.—LECREUSOT, FRANCE  
Recoil apparatus for guns 713,691 18 Nov 1902 (Schneider & Canet)
- SCHNEIDER, EUGENE—PARIS, FRANCE  
Apparatus for lubricating the bore of firearms during firing 1,481,930 29 Jan 1924 (Assigned to Schneider & Cie.)  
Multibarrel Gun 1,487,695 18 Mar 1924 (Assigned to Schneider & Cie.)
- SCHNEIDER, P. F.—HARTFORD, CONN.  
Cartridge box, Revolving 56,804 31 July 1866
- SCHOUBOE, THEODOR JENS—RUNGSTED, DENMARK  
Automatic firearm 733,681 14 July 1903  
Trigger mechanism for automatic firearms 1,230,930 26 June 1917
- SCHULTZE, FREDERICK E.—NEW YORK, N.Y.  
Machine gun 208,203 17 Sep 1878 (Assigned 1/2 to E. Meyer)  
Machine gun 208,204 17 Sep 1878 (Assigned 1/2 to Meyer)
- SCHWARZLOSE ANDREAS WILHELM—SUHL, GERMANY  
Recoil-operated firearm 712,730 4 Nov 1902  
Recoil-operated firearm 712,972 4 Nov 1902  
Automatic gun 863,101 13 Aug 1907  
Automatic firearm with forward sliding barrel 918,380 13 Apr 1909  
Lock mechanism for automatic firearm 932,183 24 Aug 1909  
Automatic firearm with fixed barrel and breech locked 1,026,609 11 May 1912
- SCHWEIZERISCHE INDUSTRIE GESELLSCHAFT — SCHAFFHAUSEN, SWITZERLAND (\*)  
Automatic firearm 1,518,498 9 Dec 1924 (Furrer)  
Automatic firearm 2,031,305 18 Feb 1936 (End & Gaetzi)  
Automatic firearm 2,130,383 20 Sep 1938 (End)  
Automatic firearm 2,052,287 25 Aug 1936 (End)
- SCOTT, CHARLES B.—LAS VEGAS, N.MEX.  
Machine gun 299,686 3 June 1884
- SCOTT, J. Q. A.—PITTSBURGH, PA.  
Magazine firearm 36,174 12 Aug 1862
- SCOTT-PAINE, HUBERT—HYTHIE, ENGLAND  
Air-cooled gun 2,337,840 28 Dec 1943 (Scott-Paine & Jaggard, W.)
- SEARLE, ELBERT H.—PHILADELPHIA, PA.  
Recoil-operated firearm 804,984 21 Nov 1905 (Assigned 3/4 to W. D. Condit)
- SEDGELY, R. F.—PHILADELPHIA, PA.  
Machine gun 2,029,839 4 Feb 1936

- SEELY, SAMUEL—BROOKLYN, N.Y.  
Improvement in portable body batteries 33,854 3 Dec 1861
- SEVERANCE, GLEN R.—DETROIT, MICH.  
Electrically operated gun 2,340,991 8 Feb 1914 (Assigned to Eureka Vacuum Cleaner Co.)
- SHARP, JOHN F.—LOUISVILLE, MISS. (\*)  
Machine gun 282,787 7 Aug 1883 (Shields)
- SHEPPARD, CREEDY C.—WASHINGTON, D.C.  
Automatic firearm 1,376,831 3 May 1921 (Assigned to United States Ordnance Co.)
- SHERMAN, THOMAS H.—WASHINGTON, D.C. (\*)  
Machine gun 430,206 17 June 1890 (Garland, F. M.)  
Machine gun 479,799 2 Aug 1892 (Garland, F. M.)
- SHIELDS, FRANCIS M.—COOPWOOD, MISS.  
Machine gun 282,787 7 Aug 1883 (Assigned to Shields, Cornwell, Liebenfeld, Herman, Connor, Sharp & Woodward)
- SHIELDS, SARAH T.—LOUISVILLE, MISS. (\*)  
Machine gun 282,787 7 Aug 1883 (Shields)
- SILLOWAY, FREDERICK D.—SPRINGFIELD, ILL.  
Steam escape for machine guns with water jackets 1,294,349 11 Feb 1919
- SILVERMAN, LOUIS—CRAYFORD, ENGLAND  
Automatic machine gun 551,779 24 Dec 1895 (Maxim & Silverman)  
Automatic gun 644,969 6 Mar 1900 (Dawson & Silverman) (Assigned to Vickers Sons & Maxim, Ltd.)  
Automatic gun 772,700 18 Oct 1904 (Dawson & Silverman) (Assigned to Vickers Sons & Maxim Ltd.)
- SIMPSON, CLARENCE E.—SPRINGFIELD, MASS.  
Machine gun 1,994,489 19 Mar 1935  
Machine gun 1,982,699 4 Dec 1934  
Machine gun 2,108,817 22 Feb 1938 (Hoppert, Bull & Simpson)  
Firing rate reducer 2,384,854 18 Sep 1945  
Machine gun trainer 2,516,926 1 Aug 1950
- SIMPSON, WILLIAM EDMUND—MANSFIELD, ENGLAND  
Gas-operated gun 589,822 8 Feb 1898
- SJOCREN, THEODOR AXEL CARL—STOCKHOLM, SWEDEN  
Automatic gun 739,732 22 Sep 1903
- SKODA, EMIL—PILSEN, BOHEMIA, AUSTRIA-HUNGARY  
Automatic quick-firing gun 429,819 10 June 1890  
Quick-firing gun 448,841 24 Mar 1891
- SLIWINSKI, ALBIN—PITTSBURGH, PA.  
Trigger mechanism for automatic firearms and pistol-swords 1,221,616 3 Apr 1917 (Solomon & Sliwinski)
- SMITH, A. B.—CLINTON, PA.  
Improved machine gun for throwing projectiles 15,529 12 Aug 1856 (Smith & Weaver)
- SMITH, DAVID J.—WASHINGTON, D.C.  
Motor-operated gun 1,352,319 7 Sep 1920
- SMITH, MORRIS F.—PHILADELPHIA, PA.  
Machine gun 548,096 15 Oct 1895  
Gas-operated machine gun 784,966 14 Mar 1905 (Assigned 3/4 to W. D. Condit)  
Gas-operated machine gun 817,197 10 Apr 1906  
Gas-operated gun 1,291,690 14 Jan 1919 ((Assigned to Driggs Ordnance Co. Inc.)  
Firearm, Automatic gas-operated 814,242 6 Mar 1906
- SMITH, WILLIAM D.—WASHINGTON, D.C.  
Means for preventing erosion and over heating of firearms 1,189,011 27 June 1916
- SOCIETA ITALIANA ERNESTO BREDI—MILAN, ITALY (\*)  
Device for lubricating automatic firearms 1,656,960 24 Jan 1928 (Soncini)  
Machine gun and other automatic firearms 1,773,441 19 Aug 1930 (Soncini)
- SOCIETE ANONYME DES ANCIENS ETABLISSEMENTS HOTCHKISS & CIE.—SEINE, FRANCE (\*)  
Accelerating device for automatic firearms 1,568,005 29 Dec 1925 (Sutter)  
Combined loader ejector and safety mechanism for automatic firearms 1,656,845 17 Jan 1928 (Sutter)  
Gas-controlled automatic firearm 2,052,368 25 Aug 1936 (Sutter)  
Automatic firearm 2,108,026 8 Feb 1938 (Sutter & Bousset)  
Automatic firearm 1,317,633 30 Sep 1919 (Squire & Mercié)
- SOCIETE ANONYME DES ETABLISSEMENTS DELAUNAY—ST. DENIS, FRANCE (\*)  
Automatic firearm 1,382,058 21 June 1921 (Bourdelle)  
Machine gun 1,402,564 3 Jan 1922 (Bourdelle)
- SOLMS, WILLY J.—PARIS, FRANCE (\*)  
Multibarreled machine gun 1,319,882 28 Oct 1919 (Luciani)
- SOLOMON, ANTON—PITTSBURGH, PA.  
Trigger mechanism for automatic firearms and pistol-swords 1,221,616 3 Apr 1917 (Solomon & Sliwinski)
- SOLOTHURN A. G. See WAFFENFABRIK SOLOTHURN A. G.
- SONCINI, CESARE—BRESCIA, ITALY  
Cartridge feed device for automatic firearms 1,611,289 21 Dec 1926 (Soncini & Castelli)  
Automatic firearms with recoiling barrel 1,613,205 4 Jan 1927 (Soncini & Castelli)  
Device for lubricating automatic firearms 1,656,960 24 Jan 1928 (Assigned to Società Italiana Ernesto Breda)  
Machine gun and other automatic firearms 1,773,441 19 Aug 1930 (Assigned to Società Italiana Ernesto Breda)
- SORENSEN, CHRISTIAN A.—LINCOLN, NEBR. (\*)  
Machine gun cooling means 2,416,768 4 Mar 1947 (Monner, R. J.)
- SPATZ, ED AND JOHN (\*)  
Automatic firearm 747,073 15 Dec 1903 (Huntley)

- SPECIALTIES DEVELOPMENT CORP.—BLOOMFIELD, N.J. (\*)  
 Gun charger 2,411,877 3 Dec 1946 (Heizler)  
 Gun charger 2,409,623 22 Oct 1946 (Grant)
- SPENCER, CHRISTOPHER M.—SOUTH MANCHESTER, CONN.  
 Firearm, Breech-loading 34,319 4 Feb 1862
- SPILMAN, J. H.—ATLANTA, GA. (\*)  
 Machine gun 664,952 1 Jan 1901 (Blackburn, Spilman & Bickart)
- SQUIRE, WILLIAM H.—ST. DENIS, FRANCE  
 Gas-operated gun 1,082,916 30 Dec 1913  
 Automatic firearm 1,317,633 30 Sep 1919 (Squire & Mercié) (Assigned to Hotchkiss & Cie.)
- STACEY, ERNEST W.—BEVERLY, MASS.  
 Ammunition feeder 2,494,728 17 Jan 1950 (Stacey & Reinhold) (Assigned to United Shoe Machinery Corp.)  
 Ammunition feeder 2,524,132 3 Oct 1950 (Naugler & Stacey) (Assigned to United Shoe Machinery Corp.)  
 Charger for automatic guns 2,529,822 14 Nov 1950 (Stacey & Willhauck) (Assigned to United Shoe Machinery Corp.)
- STAMBAUGH, HENRY J.—TROY, N.Y.  
 Automatic gun 1,648,469 8 Nov 1927 (Adamson & Stambaugh)
- STAMM, HANS—ST. GALLEN, SWITZERLAND  
 Automatic loading firearm 1,096,324 12 May 1914
- STANGE, LOUIS—SOMMERDA, GERMANY  
 Automatic firearm 1,755,034 15 Apr 1930 (Assigned to Rheinische Metallwaren und Maschinenfabrik)  
 Automatic firearm 1,801,179 14 Apr 1931 (Assigned to Rheinische Metallwaren und Maschinenfabrik)  
 Automatic firearm 1,846,156 23 Feb 1932 (Assigned to Rheinische Metallwaren und Maschinenfabrik)  
 Automatic gun 2,113,202 5 Apr 1938 (Assigned to Rheinische Metallwaren und Maschinenfabrik)
- STAUF, C.—ST. LOUIS, MO.  
 Improvement in portable battery or platoon guns 34,017 24 Dec 1861 (Stauf & Steinbach)
- STECKE, EDWARD—WARSAW, POLAND  
 Automatic firearm 2,089,671 10 Aug 1937
- STEINBACH, C. J.—ST. LOUIS, MO.  
 Improvement in portable battery or platoon guns 34,107 24 Dec 1861 (Stauf & Steinbach)
- STEINBERGER, LOUIS—BROOKLYN, N.Y.  
 Noiseless, smokeless rapid fire gun 1,316,397 16 Sep 1919
- STENSLAND, CORNELIUS—NAGAUNEE, MICH.  
 Machine gun 143,729 14 Oct 1873
- STEVENS, JORDAN & HARRISON, INC.—NEW YORK, N.Y. (\*)  
 Gun 2,387,199 16 Oct 1945 (Vang)
- STINSON, JAMES HENRY—COOKE, MONT.  
 Gun muffler 959,400 24 May 1910
- STOCKHOLMS VAPENFABRIK, AKTIEBOLAGET See AKTIEBOLAGET STOCKHOLMS VAPENFABRIK
- STODDARD, VAUGHN—CHELSEA, IOWA  
 Machine gun 1,242,068 2 Oct 1917
- STONE, BERKLEY C.—MIDDLETOWN, CONN. (\*)  
 Automatic firearm 1,226,479 15 May 1917 (Dichm)
- STONE, J. AUSTIN—WASHINGTON, D.C. (\*)  
 Fire control means for aircraft machine guns 1,466,951 4 Sep 1923 (Edwards)
- STORLE, OLE O.—TACOMA, WASH.  
 Machine gun 1,342,358 1 June 1920
- STOW, A. H.—HUNTER, W. VA.  
 Automatic firearm 726,109 21 Apr 1903
- STRASBURG, ALVIN CHARLES—CRIDERSVILLE, OHIO  
 Automatic firearm 854,771 28 May 1907
- STUCKEY, A. J.—GALVESTON, TEX.  
 Machine gun 1,869,738 2 Aug 1932 (Davis, Halett & Stuckey)
- STUDLER, RENE R.—WASHINGTON, D.C.  
 Blank ammunition firing attachment for automatic guns 2,075,837 6 Apr 1937
- STURGEON, JOHN C.—ERIE, PA.  
 Automatic gas-operated firearm 1,290,849 7 Jan 1919  
 Automatic gas-operated firearm 1,290,850 7 Jan 1919  
 Automatic gun-cartridge supply and feed mechanism 1,290,851 7 Jan 1919  
 Cooling barrel mechanism for firearm 1,290,853 7 Jan 1919  
 Automatic rapid-fire gun 1,290,854 7 Jan 1919
- SUMMERBELL, WILLIAM—WASHINGTON, D.C.  
 Sub-caliber auxiliary barrel and extractor 2,423,471 8 Jun 1947
- SUNDERLAND, OSWALD O.—FAIRFIELD, CONN.  
 Machine gun fire retarder 2,509,530 30 May 1950 (Rosengren & Sunderland)  
 Machine gun fire retarder 2,509,540 30 May 1950
- SUNNGARD, HARALD—CHRISTIANIA, NORWAY  
 Automatic firearm 972,087 4 Oct 1910
- SUSSMAN, WLADYSLAW—BROOKLYN, N.Y.  
 Automatic rifle 1,367,996 8 Feb 1921
- SUTTER, CHARLES—SURESNES, FRANCE  
 Accelerating device for automatic firearms 1,568,005 29 Dec 1925 (Assigned to Hotchkiss & Compagnie)  
 Automatic machine gun 1,431,057 3 Oct 1922  
 Combined loader, ejector and safety mechanism for automatic firearms 1,656,845 17 Jan 1923 (Assigned to Société Anonyme des Anciens Etablissements Hotchkiss & Co.)  
 Gas-controlled automatic firearm 2,052,368 25 Aug 1937 (Assigned to Hotchkiss & Co.)  
 Automatic firearm 2,108,026 8 Feb 1938 (Sutter & Bousnel, A.) (Assigned to Hotchkiss & Co.)

## SUTTON, HARRY A.—DAYTON, OHIO

- Synchronizing gun control 1,496,749 3 June 1924  
 Cartridge mechanism for automatic guns 1,504,393 12 Aug 1924  
 Synchronizing gun control 1,504,394 12 Aug 1924

## SWAIN, ALFRED F.—BROOKLYN, N.Y.

- Machine gun 928,344 20 July 1909

## SWARTZ, WILLIAM L.—WETHERSFIELD, CONN.

- Automatic firearm 2,169,083 8 Aug 1939 (Assigned to Colt's Patent Fire Arms Co.)

## SWEBILIUS, CARL G.—HAMDEN, CONN.

- Gas-operated self-loading firearm 2,373,204 10 Apr 1945  
 Belt holding pawls for machine guns 2,392,012 1 Jan 1946 (Assigned to High Standard Mfg. Corp.)  
 Extractor switch mechanism for machine guns 2,404,325 16 July 1946 (Assigned to the High Standard Mfg. Co.)  
 Automatic firearm 1,402,459 3 Jan 1922 (Assigned to Marlin Firearms Corp.)  
 Automatic gun 1,450,653 3 Apr 1923 (Assigned to Marlin Firearms Corp.)  
 Automatic firearm 1,444,890 13 Feb 1923 (Assigned to Marlin Firearms Corp.)  
 Automatic gun 1,504,584 12 Aug 1924 (Assigned to Marlin Firearms Corp.)  
 Automatic firearm 1,521,730 6 Jan 1925 (Assigned to Marlin Firearms Corp.)  
 Automatic firearm 1,550,759 25 Aug 1925 (Assigned to Marlin Firearms Corp.)  
 Automatic firearm 1,550,760 25 Aug 1925 (Assigned to Marlin Firearms Corp.)  
 Tubular magazine automatic firearm 2,282,903 12 May 1942 (Assigned to Western Cartridge Co.)  
 Self-loading repeating firearm 2,342,824 29 Feb 1944 (Assigned to High Standard Mfg. Co.)  
 Recoil-operated self-loading firearm 2,328,108 31 Aug 1943 (Assigned to Western Cartridge Co.)  
 Self-loading repeating firearm 2,365,307 19 Dec 1944 (Assigned to High Standard Mfg. Co.)  
 Gun barrel lock 2,437,137 2 Mar 1948  
 Ejector detent 2,500,139 7 Mar 1950

## SWENSON, ERIC A.—BEAUKISS, TEX.

- Automatic firearms 2,057,169 13 Oct 1936

## SYMON, ROBERT R.—LONDON, ENGLAND (\*)

- Machine gun 317,161 5 May 1885 (Maxim)

## TALIAFFERRO, N.—AUGUSTA, KY.

- Improvement in revolving ordnance 34,171 14 Jan 1862

## TANSLEY, GEORGE H.—HARTFORD, CONN.

- Automatic machine gun 1,493,846 1 July 1924 (Assigned to Colt's Patent Mfg. Co.)  
 Firing mechanism for machine guns 2,050,539 11 Aug 1936 (Tansley & Moore) (Assigned to Colt's Patent Firearms Mfg. Co.)

## TASKER, V. C.—WASHINGTON, D.C.

- Rapid-fire gun 613,195 25 Oct 1898 (L. L. Driggs & Tasker) (Assigned to Driggs-Seabury Gun & Ammunition Co.)

## TAYLOR, HAMELIN C.—PHILADELPHIA, PA.

- Automatic gun 823,004 12 June 1906 (Assigned to Taylor, Knox)

## TAYLOR, JAMES PATTON—CARTER DEPOT, TENN.

- Gun feeder for machine guns 189,811 17 Apr 1877  
 Machine gun 190,645 8 May 1877  
 Machine gun 206,365 23 July 1878 (Assigned 1/2 to John Baxter)  
 Improvement in repeating ordnance 116,775 4 July 1871 (Assigned to self & N. G. Taylor)  
 Improvement in machine guns 174,873 14 Mar 1876 (Assigned 1/2 to J. Baxter)  
 Improvement in machine guns 177,030 2 May 1876 (Assigned 1/2 to J. Baxter)  
 Improvement in machine guns 174,872 14 Mar 1876 (Assigned to J. Baxter)

## TAYLOR, JOHN A.—PICABO, IDAHO

- Recoil-operated firearm 1,078,224 11 Nov 1913 (Assigned 1/2 to J. H. Carpenter)

## TAYLOR, NATHANIEL G.—ELIZABETHTON, TENN. (\*)

- Improvement in repeating ordnance 116,775 4 July 1871 (Taylor, J. P.)

## TAYLOR, KNOX—HIGH BRIDGE, N.J. (\*)

- Automatic gun 823,004 12 June 1906 (Taylor, H. P.)

## TERNSTRÖM, ERNST—PARIS, FRANCE

- Automatic machine gun 642,018 23 Jan 1900

## TERREL, CHARLES C.—SHULISBURG, WISC.

- Machine gun 14,215 5 Feb 1856 (Assigned to self and Crawford, S.)

## THAYER, C. B.—BOSTON, MASS.

- Improvement in centrifugal guns 21,109 3 Aug 1858 (Assigned to Robinson, C.)

## THIELF, KARL—ESSEN-ON-THE-RHINE, GERMANY

- Recoil gun 911,849 9 Feb 1909 (Assigned to Fried. Krupp Aktiengesellschaft)

## THOMPSON, EUGENE W.—NEW LONDON, CONN.

- Gun silencer and recoil reducer 1,229,675 12 June 1917

## THOMPSON, JOHN T.—WASHINGTON, D.C. (\*)

- Machine gun 1,334,052 16 Mar 1920 (Burleigh)

## THOMPSON, JOHN T.—NEWPORT, KY.

- Automatic gun 1,425,810 15 Aug 1922 (Assigned to Auto Ordnance Corp.)

## THOMPSON, WALTER—BROOKLYN, N.Y.

- Means for preventing the jamming of machine guns 1,371,527 15 Mar 1921

## THORSEN, THEODORE M.—PHILADELPHIA, PA.

- Automatic firearm 696,118 25 Mar 1902

## THURLER, EUGENE—FRIBOURG, SWITZERLAND

- Device for the suppression of the report of firearms 1,000,702 15 Aug 1911



## TOBORG, GEORGE—CHICAGO, ILL.

Automatic firearm 1,017,119 13 Feb 1912  
 Automatic firearm 1,008,498 14 Nov 1911  
 Automatic firearm 1,047,337 17 Dec 1912

## TOLL, HERMAN H.—CLARINDA, IOWA

Machine gun 661,897 13 Nov 1900

## TOWNSEND, ALFRED H.—GEORGETOWN, COLO.

Improvement in repeating ordnance 115,659 6 June 1871

## TRAVAGLINI, ANTONIO—PHILADELPHIA, PA.

Gas-operated firearm 630,136 1 Aug 1899 (Assigned 1/2 to Benedictis, C. D.)

## TRAVERSI, ROBERTO A.—RECCIO EMILIA, ITALY

Gun barrel 2,238,670 15 April 1941 (Traversi & Pegna)  
 (Assigned to Compagnia Commerciale Caproni)

## TREVASKIS, HENRY W.—BIRMINGHAM, ENGLAND

Solenoid 2,403,315 2 July 1946 (Assigned to Dunlop Rubber Co. Ltd.)

Firing mechanism for automatic gun 2,397,387 26 Mar 1946 (Assigned to Dunlop Rubber Co.)

## TUCKER, LEONARD—LONDON, ENGLAND

Trigger mechanism for machine guns and small arms 1,561,756 17 Nov 1925 (Assigned to Vickers Ltd.)

## TUFTS, TIMOTHY—SOMERVILLE, MASS.

Improvement in repeating cannons 46,762 7 Mar 1865  
 (Assigned to Page, J. W. H.)

## TURNER, SAMUEL W.—CLEVELAND, OHIO (\*)

Centrifugal gun 37,159 16 Dec 1862 (Eaton)

## TYPE RELEASE CO., INC.—WILMINGTON, DEL. (\*)

Machine gun 1,362,479 14 Dec 1920 (Dibovsky)

## UMBERTO, ONORATI—TOLEDO, OHIO

Automatic firearm 1,839,621 5 Jan 1932

## UNGE, W. T.—STOCKHOLM, SWEDEN

Firearm operated by gases of explosion 515,064 20 Feb 1894

## UNITED AIRCRAFT CORP.—EAST HARTFORD, CONN. (\*)

Gun charging installation 2,431,079 18 Nov 1947 (Richey)

## UNITED SHOE MACHINERY CORP.—FLEMINGTON, DEL. (\*)

Gun charging mechanism 2,411,934 3 Dec 1946 (Naugler)

Automatic firearm 2,409,251 15 Oct 1946 (Cantley)

Examining the interiors of gun barrels 2,405,245 6 Aug 1946 (Ushakoff)

Gun-loading mechanism 2,425,425 12 Aug 1947 (Jorgensen)

Firing mechanism for guns 2,440,381 27 Apr 1948 (Phillips)

Gun ammunition magazine 2,447,092 17 Aug 1948 (Ray)

Magazine for machine guns 2,489,428 29 Nov 1949 (Mariner)

Ammunition feeder 2,494,728 17 Jan 1950 (Stacey & Reinhold)

Ammunition feeder 2,524,132 3 Oct 1950 (Naugler & Stacey)

Charger for automatic guns 2,529,822 14 Nov 1950 (Stacey & Willhauck)

## UNITED STATES ORDNANCE CO.—WASHINGTON, D.C. (\*)

Automatic firearm 1,376,834 3 May 1921 (Sheppard)

Attachment for gas-operated guns 1,445,583 13 Feb 1923 (Green)

## UNITED STATES ORDNANCE CO.—BOSTON, MASS. (\*)

Machine gun 1,379,339 24 May 1921 (Kaskell)

## UNIVERSAL ELECTRIC ARMS &amp; AMMUNITION CO.—NEW YORK, N.Y. (\*)

Cartridge, Electric 365,842 5 July 1887 (Monfort)

Electrical breech-loading firearms 365,843 5 July 1887 (Monfort)

## UNIVERSAL PATENTS CO.—RHODE ISLAND (\*)

Machine gun belt 1,243,686 23 Oct 1917 (Batchelder)

## USHAKOFF, ALEXIS E.—BEVERLY, MASS.

Examining the interiors of gun barrels 2,405,245 6 Aug 1946 (Assigned to United Shoe Machinery Corp.)

## UTLEY, GREY—LOUISBURG, N.C.

Improvement in repeating ordnance 20,229 11 May 1858

## VANG, ALFRED—NEWARK, N.J.

Gun 2,387,199 16 Oct 1945 (Assigned to Stevens, Jordan & Harrison, Inc.)

## VANKEIRSBILCK, JOHN—HARTFORD, CONN.

Machine gun 504,517 5 Feb 1893 (Broderick & Vankeirsbilck) (Assigned to Gatling Gun Co.)

Feed for machine guns 504,516 5 Sep 1893 (Broderick & Vankeirsbilck) (Assigned to Gatling Gun Co.)

## VICKERS, ALBERT—LONDON, ENGLAND (\*)

Machine gun 317,161 5 May 1885 (Maxim)

Automatic gun 690,799 7 Jan 1902 (Assigned to Vickers Sons & Maxim Ltd.)

## VICKERS-ARMSTRONG LTD.—WESTMINSTER, ENGLAND (\*)

Gas-operated machine gun and automatic small arm 1,811,693 23 June 1931 (Larsson & Higson)

Drum magazine for machine guns and automatic small arms 1,811,694 23 June 1931 (Larsson & Higson)

Machine gun and automatic small arm 1,846,035 9 Feb 1932 (Larsson & Higson)

Machine gun 2,037,244 14 Apr 1936 (Larsson & Higson)

Machine gun and drum magazine therefor 2,113,793 12 Apr 1938 (Larsson & Higson)

Machine gun and automatic small arm 2,137,612 22 Nov 1938 (Higson)

Automatic gun 2,347,559 25 Apr 1944 (Higson)

Machine gun 2,013,312 3 Sep 1935 (Larsson & Higson)

Machine gun 2,048,395 21 July 1936 (Larsson & Higson)

Double-barreled automatic gun 2,509,734 30 May 1950 (Higson)

## VICKERS LIMITED—WESTMINSTER, ENGLAND (\*)

Automatic gun 1,262,169 9 Apr 1918 (Buckham)

Automatic gun 1,262,181 9 Apr 1918 (Dawson & Buckham)

- Bullet deflector for the propellers of aeroplanes and similar aircraft provided with machine guns 1,298,886 1 Apr 1919 (Challenger)
- Automatic gun 1,298,887 1 Apr 1919 (Challenger & Savage)
- Machine gun 1,312,106 5 Aug 1919 (Dawson & Buckham)
- Machine gun 1,314,734 2 Sep 1919 (Dawson & Buckham)
- Machine gun 1,327,086 6 Jan 1920 (Dawson & Buckham)
- Machine gun mounting 1,364,925 4 Jan 1921 (Scarff)
- Machine gun 1,447,246 6 Mar 1923 (Hazelton)
- Machine gun 1,453,974 1 May 1923 (Dawson, Buckham & Haskell)
- Machine gun 1,479,138 1 Jan 1924 (Hazelton)
- Machine gun 1,456,625 29 May 1923 (Dawson & Buckham)
- Automatic gun 1,468,262 18 Sep 1923 (Dawson, Buckham & Larsson)
- Means for controlling the rate of fire of automatic guns carried by aircraft 1,486,909 18 Mar 1924 (Lucas)
- Articulated link for the cartridge belts of machine guns 1,550,787 25 Aug 1925 (Dawson, Buckham & Larsson)
- Automatic gun 1,553,992 15 Sep 1925 (Dawson, Buckham & Larsson)
- Trigger mechanism for machine guns and small arms 1,561,756 17 Nov 1925 (Tucker)
- Gun mounting for use in aircraft 1,628,068 10 May 1927 (Scarff)
- VICKERS, SONS & MAXIM, LTD.—LONDON, ENGLAND (\*)**
- Automatic gun 644,969 6 Mar 1900 (Dawson & Silverman)
- Automatic machine gun 687,130 19 Nov 1901 (Dawson & Buckham)
- Automatic gun 690,799 7 Jan 1902 (Vickers)
- Automatic gun 772,700 18 Oct 1904 (Dawson & Silverman)
- Muzzle attachment for automatic guns 870,497 5 Nov 1907 (Dawson & Ramsay)
- Automatic gun 920,832 4 May 1909 (Dawson & Buckham)
- Automatic gun 942,167 7 Dec 1909 (Dawson & Buckham)
- Cartridge feed mechanism of Maxim guns 951,999 15 Mar 1910 (Buckham)
- Automatic gun 926,052 22 June 1909 (Dawson & Buckham)
- Cartridge feed mechanism for automatic guns 1,091,640 31 Mar 1914 (Dawson & Buckham)
- Automatic gun 1,077,680 4 Nov 1913 (Dawson & Buckham)
- VICTOR P. DE KNIGHT GUN CO.—WASHINGTON, D.C. (\*)**
- Rapid-fire automatic gun 698,107 22 Apr 1902 (De Knight)
- Rapid-fire automatic gun 709,880 30 Sep 1902 (De Knight)
- Rapid-fire automatic gun 709,881 30 Sep 1902 (De Knight)
- Rapid-fire automatic gun 709,883 30 Sep 1902 (De Knight)
- VILLAR PEROSA, OFFICINI DI—VILLAR PEROSA, ITALY (\*)**
- Automatic firearm 1,159,417 9 Nov 1915 (Revelli)
- Machine gun 1,286,884 3 Dec 1918 (Revelli)
- VINCON, GUSTAVO—TURIN, ITALY**
- Automatic firearm 1,464,276 7 Aug 1923
- VINSON, NEAL L.—MILL VALLEY, CALIF.**
- Air-cooled gun barrel 2,363,563 28 Nov 1944
- VOLLER, KARL—DUSSELDORF, GERMANY**
- Gun with recoiling barrel 855,366 28 May 1907 (Assigned to Rheinische Metallwaren u. Maschinenfabrik)
- Recoil mechanism for guns 1,034,171 30 July 1912
- Automatic firing mechanism 887,713 12 May 1908 (Assigned to Rheinische Metallwaren u. Maschinenfabrik)
- VOLLMER, HEINRICH—BIBERACH-RISS, GERMANY**
- Automatic firearm 2,182,907 12 Dec 1939 (Assigned to Gastav Genschow & Co.)
- VOLLMER, JOHN—ESSEN, GERMANY**
- Composite gun barrel assembled by rotary motion of its component parts 1,400,780 20 Dec 1921 (Assigned to Fried. Krupp Aktiengesellschaft)
- VON JEINSEN, E.—NEW YORK, N.Y.**
- Breech-loading firearms 84,922 15 Dec 1868
- WACKERMANN, FRANK—PITTSBURGH, PA.**
- Recoil-operated firearm 516,417 13 Mar 1894
- WAFFENFABRIK MAUSER AKTIENGESELLSCHAFT—OBERNDORF, GERMANY (\*)**
- Rotatable breech bolt for automatic firearm 1,180,784 25 Apr 1916 (Paul Mauser)
- Rotatable lug bolt firearm 1,180,785 25 April 1916 (Paul Mauser)
- Firearm 1,217,974 6 March 1917 (P. Mauser)
- Means for combining the barrel with the receiver in connection with firearms 1,234,783 31 July 1917 (Mauser, Paul)
- WAFFENFABRIK SOLOTHURN A. G.—SOLOTHURN, SWITZERLAND (\*)**
- Automatic firearm 2,015,908 1 Oct 1935 (Rakula & Heilach)
- Automatic gun 2,067,322 12 Jan 1937 (Heilach & Rakula)
- WAGNER, PAUL G.—LOS ANGELES, CALIF.**
- Machine gun starter & recharger 2,180,751 21 Nov 1939
- WAGNON, IRA W.—CASA GRANDE, ARIZ.**
- Automatic rifle 1,398,452 29 Nov 1921 (Assigned 1/2 to Brown, J. F.)
- WALKER, BROOKS—PIEDMONT, CALIF.**
- Air-cooled gun 2,427,374 16 Sep 1947
- WALL, ALEXANDER C.—INDIANAPOLIS, IND.**
- Gun charger 2,389,943 27 Nov 1945 (Assigned to General Electric Co.)
- WALTHER, CARL—ZELLA, GERMANY**
- Automatic firearm with stationary barrel 991,398 2 May 1911

**WALTHER, FRITZ—ZELLA-MEHLIS, GERMANY**

- Automatic firearm 1,457,477 5 June 1923 (Walther, F. & Walther, G.)  
 Automatic firearm 1,481,042 15 Jan 1923 (Walther, F. & Walther, G.)  
 Automatic firearm 2,145,328 31 Jan 1939

**WALTHER, GEORG—ZELLA-MEHLIS, GERMANY**

- Automatic firearm 1,457,477 5 June 1923 (Walther, F. & Walther, G.)  
 Automatic gun 1,481,042 15 Jan 1924 (Walther, F. & Walther, G.)

**WANINGER, CARL—DÜSSELDORF, GERMANY**

- Gun loading device 2,151,288 21 Mar 1939 (Assigned to Rheinmetall-Borsig Aktiengesellschaft)

**WARNER, JAMES HAROLD—NEW YORK, N.Y.\***

- Machine gun 1,273,078 16 July 1918 (McManus, L. M.)

**WATSON, GLENN C.—CLEVELAND, OHIO**

- Automatic rifle 1,377,236 10 May 1921

**WATT, ANDREW K.—LANSING, MICH.**

- Feed mechanism for machine guns 2,519,947 22 Aug 1950  
 (Assigned to General Motors Corp.)

**WEAVER, WM.—CLINTON, PA.**

- Improved machine for throwing projectiles 12,529 12 Aug 1856 (Smith & Weaver)

**WEBB, GEORGE—HARTFORD, CONN.**

- Automatic firearm & combined accessories 2,359,263 26 Sep 1944 (Assigned to Colt's Firearms Mfg. Co.)  
 Automatic firearm 2,375,452 8 May 1945 (Assigned to Colt's Patent Fire Arms Mfg. Co.)

**WEBB, HARRY C.—TACOMA, WASH.**

- Machine gun 569,899 20 Oct 1896

**WEED, JAMES—RAWLINS, WYO.**

- Automatic gun 718,062 6 Jan 1903 (Assigned to Lewis, J. & Brown, A. A.)

**WELIN, ERNST A. M.—LONDON, ENGLAND**

- Quick-firing gun 614,414 15 Nov 1898

**WERKZEUG MASCHINENFABRIK OERLIKON—OERLIKON, SWITZERLAND (\*)**

- Automatic gun 1,556,225 6 Oct 1925 (Kung)  
 Bearing surface for breech bolts in automatic firearms 2,509,043 23 May 1950 (Mühlemann)  
 Automatic inertia-locked firearm with automatic hammer 2,512,014 20 Jun 1950 (Eglin)  
 Automatic firearm breech bolt lock 2,512,027 20 Jun 1950 (Lippert & Mühlemann)  
 Automatic firearm breech bolt locking mechanism 2,523,704 26 Sep 1950 (Lippert & Hepperle)  
 Trigger mechanism for automatic firearms 2,524,258 3 Oct 1950 (Hepperle)

**WESTERN CARTRIDGE CO.—DELAWARE (\*)**

- Gas-operated firearm 2,211,405 13 Aug 1940 (Browning)  
 Tubular magazine automatic firearm 2,282,903 12 May 1942 (Swebilius)

- Gas-operated automatic firearm 2,252,754 19 Aug 1941 (Browning)  
 Gas-operated actuating mechanism for firearms 2,340,962 8 Feb 1944 (Humeston)  
 Recoil-operated self-loading firearm 2,328,108 31 Aug 1943 (Swebilius)  
 Gas-operated self-loading firearm 2,346,954 18 Apr 1944 (Williams)  
 Gas-operated self-loading firearm 2,355,768 15 Apr 1944 (Williams)  
 Gas-operated self-loading firearm 2,370,233 27 Feb 1945 (Crockett)  
 Self loading firearm 2,372,339 27 May 1945 (Rocmer)

**WESTFALL, WALTER E.—MARYVILLE, MO.**

- Silencer for construction firearms 1,111,202 22 Sep 1914

**WHALEN, JAMES A.—BROOKLYN, N.Y.**

- Improvement in revolving firearms 25,052 22 Apr 1862

**WHITCOMB, JAMES O.—NEW YORK, N.Y.**

- Improvement in magazine field batteries 38,350 28 Apr 1863

**WHITE AUTOMATIC GUN CORP.—PORTLAND, ME. (\*)**

- Automatic gun 1,907,163 2 May 1933 (White)  
 Automatic gun 1,907,164 2 May 1933 (White)

**WHITE, HARRY K.—ANNAPOLIS, MD.**

- Recoil-operated magazine firearm 488,409 20 Dec 1892  
 (Assigned to the White Magazine Rifle Co.)

**WHITE, JOSEPH C.—WAKEFIELD, MASS.**

- Automatic gun 1,907,163 2 May 1933 (Assigned to White Automatic Gun Corp.)  
 Automatic gun 1,907,164 2 May 1933 (Assigned to White Automatic Gun Corp.)

**WHITING, WILLIAM JOHN—HANDSWORTH, ENGLAND**

- Automatic revolver firearm 688,216 2 Dec 1901  
 Automatic revolver firearm 688,217 3 Dec 1901  
 Automatic firearm 803,948 7 Nov 1905  
 Automatic firearm 804,694 14 Nov 1905  
 Automatic firearm 827,488 31 July 1906  
 Automatic firearm 863,770 30 Aug 1907  
 Automatic fireman 896,496 18 Aug 1908  
 Automatic firearm 939,882 9 Nov 1909

**WHITNEY, JAMES S.—LOWELL, MASS.**

- Machine gun 311,551 3 Feb 1885

**WHITTIER, WALTER H.—GRAND RAPIDS, MICH.**

- Automatic firearm 1,019,937 12 Mar 1912  
 Automatic firearm 1,034,750 6 Aug 1912

**WIKANDER, OSCAR R.—PITTSBURGH, PA.**

- Automatic gun 2,370,835 6 Mar 1945 (Bell & Wikander) (Assigned to Edgewater Steel Co.)  
 Automatic gun 2,395,211 19 Feb 1946 (Bell & Wikander) (Assigned to Edgewater Steel Co.)

**WILDER, ELIHU—MANCHESTER, N.H.**

- Machine gun 182,729 26 Sep 1876

- Machine gun 563,701 7 July 1896 (Assigned to Moses, H. O.)  
Improvement in machine guns 182,729 26 Sep 1876
- WILDNER, FRANZ—BOHEMIA, CZECHOSLOVAKIA**  
Silencer for firearms 1,462,158 17 July 1923
- WILLIAMS, DAVID M.—GODWIN, N.C.**  
Automatic firearm 2,090,656 24 Aug 1937  
Automatic firearm 2,090,657 24 Aug 1937  
Belt-feeding means for guns 2,027,893 14 Jan 1936  
Gas-operated self-loading firearm 2,346,954 18 Apr 1944 (Assigned to Western Cartridge Co.)  
Gas-operated self-loading firearm 2,355,768 15 Aug 1944 (Assigned to Western Cartridge Co.)  
Piston means for gas-operated firearms 2,376,466 22 May 1945 (Assigned to Olin Industries, Inc.)  
Cartridge-extracting mechanism for firearms 2,412,663 17 Dec 1946 (Assigned to Olin Industries, Inc.)
- WILLIAMS, EDGAR A.—UPPER BLACK EDDY, PA.**  
Interchangeable barrel for guns 1,760,731 27 May 1930
- WILSON, ELIJAH—FRENIER, LA. (\*)**  
Machine gun 1,174,923 7 Mar 1916 (Woodson)
- WILSON, THOMAS—BIRMINGHAM, ENGLAND**  
Revolving magazine gun 481,452 23 Aug 1892
- WINCHESTER REPEATING ARMS CO.—NEW HAVEN, CONN. (\*)**  
Magazine for firearms 285,284 18 Sep 1883 (Mason)  
Gas-operated gun 525,151 28 Aug 1894 (Mason)  
Automatic gun 636,196 31 Oct 1899 (Burgess)  
Automatic firearm 681,481 27 Aug 1901 (Johnson)  
Automatic firearm 694,157 25 Feb 1902 (Johnson)  
Automatic firearm 695,781 18 Mar 1902 (Bennett & Mason)  
Recoil operated firearm 768,665 30 Aug 1904 (Johnson)  
Locking block for automatic guns 760,871 24 May 1904 (Johnson)  
Tubular magazine automatic gun 874,856 24 Dec 1907 (Mason)  
Gas-operated gun 877,657 28 Jan 1908 (Mason)  
Gas-operated gun 885,166 21 Apr 1908 (Mason)  
Automatic firearm 846,591 12 Mar 1907 (Mason)  
Automatic firearm 854,707 21 May 1907 (Mason)  
Recoiling barrel gun 941,006 23 Nov 1909 (Burton)  
Automatic firearm 933,254 7 Sep 1909 (Knous)  
Recoiling barrel firearm 945,328 4 Jan 1910 (Johnson)  
Recoiling barrel gun 946,134 11 Jan 1910 (Johnson)  
Cartridge-ejecting mechanism for firearms 2,101,236 7 Dec 1937 (Burton)
- WINKS, JOHN O.—SAN FRANCISCO, CALIF.**  
Automatic firearm 1,104,947 28 July 1914  
Automatic firearm 1,190,352 11 July 1916
- WINTER, ALFRED—DÜSSELDORF, GERMANY**  
Automatic firearm 2,133,661 18 Oct 1938 (Engel & Winter) (Assigned to Rheinmetall-Borsig Aktiengesellschaft)
- WISMAN, FRANKLIN O.—SOUTH BEND, IND.**  
Automatic machine gun charger 2,410,767 5 Nov 1946 (Wisman & Rohm) (Assigned to Bendix Aviation Corp.)
- WOOD, MARSHALL—LEWISBURGH, W.VA.**  
Machine gun 130,098 30 July 1872 (Assigned to self and Mathews)
- WOOD, STEPHEN W.—CORNWALL, N.Y.**  
Improvement in field artillery 126,607 7 May 1872
- WOODGATE, HERBERT FERDINAND—LONDON, ENGLAND**  
Recoil-operated gun 512,437 9 Jan 1894 (Griffiths & Woodgate)
- WOODSON, HENRY D., JR.—FRENIER, LA.**  
Machine gun 1,174,923 7 Mar 1916 (Assigned 15/100 to Elijah Wilson)
- WOODWARD, JAMES N.—LOUISVILLE, MISS. (\*)**  
Machine gun 282,787 7 Aug 1893 (F. M. Shields)
- WOODWARD, R.—NEW EGYPT, N.J.**  
Improvement in firearms 31,933 2 Apr 1861 (McCord)
- WOODY, GEORGE A.—TILDEN, TEXAS**  
Operating mechanism for machine guns 1,897,099 14 Feb 1933 (Woody & Coupland)
- WRIGHT, ROBERT LEE—LOS ANGELES, CALIF.**  
Machine gun 1,444,768 6 Feb 1923
- WRIGHT, JOSEPH—ENGLAND**  
Firing device for automatic guns 2,135,688 8 Nov 1938 (Wright, Park & Trevaskis) (Assigned to Dunlop Rubber Co. Ltd.)
- WURTZEBACH, L. E.—LEAD, S.D.**  
Silencing device for firearms 1,525,846 10 Feb 1925
- WURZER, MARTIN—PHILADELPHIA, PA.**  
Machine gun 2,029,839 4 Feb 1936
- YOUNG, FRANKLIN K.—BOSTON, MASS.**  
Automatic firearm 624,145 2 May 1899
- YOUNG, LAUTT F.—CHAFFEE, MO.**  
Buffer spring assembly for automatic firearms 2,504,958 25 Apr 1950 (Botts & Young)  
Gun clearing device 2,495,800 31 Jan 1950
- Z. B., See CESKOSLOVENSKA ZBROJOVKA AKCIOVA-SPOLECNOST**
- ZBROJOVKA BRNO NARODNI PODNIK — PRAGUE, CZECHOSLOVAKIA (\*)**  
Inertia member for retarding breechblock movement in automatic firearms 2,495,460 24 Jan 1950 (Koucky)  
Cartridge feeding means for automatic firearms 2,519,582 22 Aug 1950 (Koucky)

# APPENDIX B

## Tabulated Characteristics of Machine Guns and Aircraft Cannon

This table has been compiled as a handy reference to the world's effort in the field of automatic machine guns and cannon. Due to the vast number of models that have been developed from a basic mechanism, no attempt was made to list them all here. To avoid repetition, a representative weapon was chosen that best illustrated the inventor's (or manufacturer's) family of machine guns. (In the foregoing text all models are covered.) Where a weapon is known by more than one name or designation, it has been cross-indexed under each.

In the table, the following code is employed under "Use":

- A—Aircraft
- A-A—Antiaircraft
- A-T—Antitank
- I—Infantry.

## Automatic Machine Guns

Weapon	Bore	Country of origin	Use	Method of operation	Type of lock
Bang Model 1929	Cal. .276	Denmark	A	Muzzle blast jerks piston forward	Rotating bolt head
B. A. R.	Cal. .30	U. S. A.	I	Gas-actuated piston	Propped breech
Beardmore-Farquhar	Cal. .303	England	A	Gas and spring actuated	Rotating bolt head
Benét-Mercié Model 1909	8 mm	France	I,A	Gas-actuated piston	Locking ring
Bergmann Model 1910	7.92 mm	Germany	I	Short recoil	Sliding block
Bergmann Model 1915 N.A.	7.92 mm	Germany	A	Short recoil	Sliding block
Berthier Model 1908	8 mm	France	I	Gas-actuated piston	Propped breech
Berthier-Vickers (G. O.)Mk I	cal. .303	England	A	Gas-actuated piston	Propped breech
Besa Mk I	7.92 mm	England	I	Gas-actuated piston	Propped breech
Besa Mk I (ZB-60 Mod 38)	15 mm	England	A-T	Gas-actuated piston	Propped breech
Breda Model 1924	6.5 mm	Italy	I	Short recoil	Locking ring
Breda-Fiat Model 1930	7.92 mm	Italy	I	Short recoil	Locking ring
Breda Model 1935	7.7 mm (cal. .303)	Italy	I	Short recoil blow-back	Rolling lock
Breda Model 1937	12.7 mm	Italy	A	Gas-actuated piston	Sliding block vertical
Bren Mk I	Cal. .303	England	I	Gas-actuated piston	Propped Breech
Brixia Model 1920	6.5 mm	Italy	A	Short recoil	Rolling lock
Browning Model 1918	Cal. .30	U. S. A.	A	Short recoil	Sliding block
Browning M2	Cal. .50	U. S. A.	A	Short recoil	Sliding block
B. S. A. Model 1924	Cal. .50	England	A	Short recoil	Partial rotation of bolt
Carr	Cal. .30	U. S. A.	I	Short recoil	Toggle
Chatellerault Model 1929	7.5 mm	France	I	Gas-actuated piston	Propped breech by linkage

Type of feed	Capacity of feed	Method of cooling	Weight of gun and feed (in pounds)	Muzzle velocity (ft. per sec.)	Rate of fire (r. p. m.)
Link belt	250	Air	21½	2,400	350-450
Magazine	20	Air	15½	2,680	500
Drum magazine	77	Air	16¼	2,427	450-550
Strip	24-30	Air	27	2,296	650
Fabric belt	200	Water	36	2,952	480-550
Fabric belt	200	Air	34	2,952	750-800
Magazine	20-30	Air	19	2,296	240-400
Flat drum	97	Air	31½	2,427	750-900
Link belt	200	Air	47	2,950	550-800
Link belt	40	Air	125½	3,200	400-500
Magazine	20	Air	20	2,080	450-500
Magazine	20	Air	20	2,952	450-500
Link belt	250	Air	27	2,400	600-650
Tray	20	Air	42½	2,600	450-500
Magazine	25-40-100	Air	23	2,400	450-550
Magazine	50	Air	34	2,080	500-600
Link belt	250	Air	30½	2,750	1,100-1,300
Link belt	Any reasonable amount	Air	61	2,840	750-850
Flat drum	37	Air	46	2,600	400-450
Drum magazine	248	Air	82	2,228	480-500
Magazine	30	Air	22	2,700	450-500

## Automatic Machine Guns (continued)

Weapon	Bore	Country of origin	Use	Method of operation	Type of lock
Chauchat Model 1915	8 mm	France	I	Long recoil	Rotating bolt head
Colt Model 1895	6 mm	U. S. A.	I	Gas operating swinging lever	Propped breech
Darne Type 33, Model 29	7.5 mm	France	A	Gas-actuated piston	Propped breech
De Knight	Cal. .30	U. S. A.	I	Gas-actuated piston	Pivoting
Dreyse Model 1912	7.92 mm	Germany	I	Short recoil	Pivoting lock
FG-42	7.92 mm	Germany	A	Gas-actuated piston	Rotating bolt
Fiat Model 1914	6.5 mm	Italy	I	Retarded blow back	Mechanical disadvantage
Fiat Model 1928	7.7 mm	Italy	A	Short recoil	Pivoting (linkage)
Furrer Model 1925	7.5 mm	Switzerland	I	Short recoil	Toggle
Gast (Double Barrel) Model 1918	7.92 mm	Germany	A	Energy from fired bolt operates other	Partial rotation
Hotchkiss Model 1897	8 mm	France	I	Gas-actuated piston	Swinging
Hotchkiss "Portative"	8 mm	France	I	Gas-actuated piston	Locking ring
Hotchkiss Anti-Balloon Gun	11 mm	France	A	Gas-actuated piston	Swinging
Johnson Model 1941	Cal. .30	U. S. A.	I	Short recoil	Rotating bolt
Kjellman	6.5 mm	Sweden	I	Short recoil	Pivoting locks (2)
Knorr-Bremse Model 35/36	7.92 mm	Germany	I	Gas-actuated piston	Propped breech linkage
Lahti Model 26/32	7.92 mm	Finland	I	Short recoil accelerator	Swinging
Lewis Model 1912	Cal. .30	U. S. A.	I,A	Gas-actuated piston	Rotating bolt
LS Model 26/32	7.7 mm	Finland	I	Short recoil	Swinging
McClellan	Cal. .30	U. S. A.	I	Gas	Rotating bolt
Madsen Model 1904	8 mm	Denmark	I	Short recoil	Pivoting bolt



Type of feed	Capacity of feed	Method of cooling	Weight of gun and feed (in pounds)	Muzzle velocity (ft. per sec.)	Rate of fire (r. p. m.)
Magazine	20	Air	18	2,300	240
Fabric belt	Any reasonable amount	Air	40	2,500	500
Link belt	250	Air	18½	2,700	900-1200
Fabric belt	240	Water	38½	2,228	600
Link belt	200	Water	37½	2,952	550-600
Magazine	20	Air	14	2,750	400-450
Magazine compartments	50	Water	37½	2,085	450-500
Link belt	250	Air	28	2,400	700-800
Magazine	30	Air	18	2,950	400-450
Flat drum	180 (each drum)	Air	60	2,902	1,600-1,800
Strip	24-30	Air (metal doughnuts)	55	2,400	600
Strip	24-30	Air	27	2,400	650-700
Strip	24	Air	66	1,600	400
Clip	5-20	Air	12½	2,750	400-500
Fabric belt	250	Water	28	2,395	500-600
Magazine	25	Air	18½	2,952	450-500
Magazine	25-75	Air	19½	2,952	450-550
Magazine flat drum	47-96	Air radiator	25	2,750	500-600
Magazine	25-75	Air	19½	2,400	450-550
Magazine	90	Air radiator	68	2,570	550
Magazine	25-40	Air or water	21	2,228	500-650

## Automatic Machine Guns (continued)

Weapon	Bore	Country of origin	Use	Method of operation	Type of lock
Madsen Model 1927	11.35 mm	Denmark	A	Short recoil	Pivoting bolt
Marlin	Cal. .30	U. S. A.	A	Gas-actuated piston	Propped breech
Maxim Prototype of 1884	Cal. .45	England	I	Short recoil	Toggle
Maxim Model .08	7.92 mm	Germany	I	Short recoil	Toggle
Mendoza Model 1937	7 mm	Mexico	I	Gas-actuated short piston	Rotating bolt
MG-15 (Rheinmetall)	7.92 mm	Germany	A	Short recoil (muzzle booster)	Locking ring
MG-17 (Rheinmetall)	7.92 mm	Germany	A	Short recoil (muzzle booster)	Locking ring
MG-34 (Mauser)	7.92 mm	Germany	I	Short recoil (muzzle booster)	Rotating bolt head
MG-42 (Mauser)	7.92 mm	Germany	I	Short recoil (muzzle booster)	Roller locking studs
MG-81 (Mauser)	7.92 mm	Germany	A	Short recoil accelerator	Rotating bolt head
Nordenfelt Model 1897	8 mm	France	I	Short recoil (and manual)	Rolling breech lock
Parabellum (Maxim)	7.92 mm	Germany	A	Short recoil	Toggle
Perino Model 1908	7.7 mm	Italy	I	Short recoil	Pivoting
Puteaux Model 1905	8 mm	France	I	Gas-actuated piston	Swinging
Revelli Model 1914	6.5 mm	Italy	I	Retarded blow back	Mechanical disadvantage
Revelli Model 1914	6.5 mm	Italy	A	Retarded blow back	Mechanical disadvantage
Rheinmetall-Borsig MG-131	13 mm	Germany	A	Short recoil accelerator	Locking ring
Safat Model 1928	7.7 mm	Italy	A	Short recoil	Propped breech (linkage)
St. Etienne Model 1907	8 mm	France	I	Gas actuates piston forward	Swinging

Type of feed	Capacity of feed	Method of cooling	Weight of gun and feed (in pounds)	Muzzle velocity (ft. per sec.)	Rate of fire (r. p. m.)
Drum	100	Air	37½ (with loaded drum)	2,475	850-1,000
Link Belt	250-300	Air	22	2,750	600-680
Belt-magazine-clip	333-334	Water	60 (with empty jacket)	1,200	600
Fabric belt	Any reasonable amount	Water	40½	2,750	600
Magazine	20-30	Air	18½	2,750	400-500
Link belt	250	Air	27½	2,952	750-1,000
Link belt	250	Air	27¾	2,552	750-1,000
Link belt	250	Air	24½	2,750	750-800
Link belt magazine	75-250	Air	24	2,570	1,200-1,350
Link belt	250	Air	13¾	2,750	1,200-1,300
Push out link belt	200	Water	37 (empty jacket)	2,300	600
Fabric belt	250-350	Air	22	2,952	600-700
Metal trays	25	Water, Air	50	2,400	600
Strip	25	Air (brass radiator)	54	2,296	650
Magazine, spring-loaded compartments	50	Water	37½	2,080	450-500
Magazine compartments	50	Air	29½	2,080	450-500
Link belt	250	Air	40	2,560	850-960
Link belt	250	Air	28	2,640	700-800
Strip	25	Air (brass doughnuts)	46	2,300	500

## Automatic Machine Guns (concluded)

Weapon	Bore	Country of origin	Use	Method of operation	Type of lock
Schwarzlose Model 1907	7.92 mm	Austria	I	Retarded blow back	Mechanical disadvantage
Scotti Model 1928	7.7 mm	Italy	A	Gas, piston actuated unlocking, and blowback	Rotating bolt head
S. I. A. Model 1918	6.5 mm	Italy	A	Short recoil	Cammed-up locking lug
Sistar Model 1932	6.5 mm	Italy	I	Retarded blow-back, short recoil unlocking	Mechanical disadvantage
Skoda Model 1902	8 mm	Austria	I	Retarded blow-back after unlocking by recoil	Mechanical disadvantage
Scolthurn Model 29	7.92 mm	Germany	I	Short recoil	Locking ring
Scolthurn Model 30	7.92 mm	Germany	I	Short recoil	Locking ring
T. u. F. (Maxim)	12.7 mm	Germany	A	Short recoil	Toggle
Vickers-Berthier Mk I (G. O.)	Cal. .303	England	A	Gas actuated piston	Propped breech
Villar-Perosa (double barrel)	9 mm	Italy	A	Short recoil and blow back	Rotating bolt head
ZB Model 1926	7.92 mm	Czech	I	Gas actuated piston	Propped breech
ZB Model 50	7.92 mm	Czech	I	Short recoil accelerator	Propped breech

Type of feed	Capacity of feed	Method of cooling	Weight of gun and feed (in pounds)	Muzzle velocity (ft. per sec.)	Rate of fire (r. p. m.)
Fabric belt	250	Water	46½	1,875	400-450
Belt magazine	250	Air	22	2,400	450-500
Magazine	50-100	Air	25½	2,085	650-700
Magazine	20	Air	22	2,055	650-700
Hopper	25-50-75	Water	38½ (w/o water or loaded hopper)	2,100	300-400
Magazine	25-50	Air	17	2,952	400-450
Magazine	25-50	Air	18½	2,952	450-500
Fabric belt	100	Air, water	84	2,750	400-450
Flat drum	97	Air	31½	2,400	750-900
Magazine	50	Air	14¼	862	1,500 <sup>1</sup>
Magazine	25-40	Air	19½	2,952	450-500
Link belt	200	Air	34	2,952	550-600

<sup>1</sup> Per barrel.

## Cannon

Weapon	Bore	Country of origin	Use	Method of operation	Type of lock
American Armament	37 mm	U. S. A.	A	Long recoil	Rotating bolt head
Baldwin	37 mm	U. S. A.	A	Long recoil	Rotating bolt head
Becker	20 mm	Germany	A	Blow back	Inertia
Bofors	20 mm	Sweden	A	Short recoil muzzle booster	Swinging locks
Bofors (Twin)	40 mm	Sweden	A-A	Short recoil	Sliding block (vertical)
Breda	20 mm	Italy	A	Gas-actuated piston	Sliding block (vertical)
Browning (M4)	37 mm	U. S. A.	A	Long recoil	Sliding block (vertical)
C. O. W.	37 mm	England	A	Long recoil	Rotating bolt
Elhrhardt	20 mm	Germany	A	Short recoil	Pivoting lock
Flak 18 (Rheinmetall)	37 mm	Germany	A-A	Short recoil	Rotating bolt
Flak 30 (Rheinmetall)	20 mm	Germany	A-A	Short recoil	Pivoting lock
Flak 38 (Mauser)	20 mm	Germany	A-A	Short recoil	Rotating bolt head
Furrer	20 mm	Switzerland	A	Short recoil	Toggle
Gazda	20 mm	Switzerland	A	Blow back	Inertia
Hispano-Suiza (404)	20 mm	France	A	Gas-actuated piston, blow back	Swinging lock
Hotchkiss	25 mm	France	A	Gas-actuated piston	Swinging lock
Lahti	20 mm	Finland	A	Gas-actuated piston, blow back	Swinging lock
Lübbe	20 mm	Germany	A A-A	Gas-actuated piston	Sliding block (vertical)
Madsen	23 mm	Denmark	A	Short recoil	Pivoting bolt
MG-151/20 (Mauser)	20 mm	Germany	A	Short recoil	Rotating bolt head
MK-101 (Rheinmetall)	30 mm	Germany	A	Short recoil	Locking ring

Type of feed	Capacity of feed	Method of cooling	Weight of gun and feed (in pounds)	Muzzle velocity (ft. per sec.)	Rate of fire (r. p. m.)
Magazine	5	Air	250	1,200	50-60
Magazine	5	Air	140	1,320	120
Magazine	12	Air	66	1,570	300-350
Link belt	250	Air	84	2,750	650-700
Clip	8 per barrel	Air	2,300	2,890	260-300
Strip	12	Air	148	2,760	200-220
Magazine	30	Air	248	2,000	135
Magazine	5	Air	140	2,000	60
Magazine	20	Air	160	2,200	250-300
Magazine	8	Air	595	2,520	160-180
Magazine	20, 40, 50	Air	141	2,950	200-280
Magazine	20	Air	123	2,950	420-480
Link belt	200	Air	98	2,920	650-700
Drum magazine	60	Air	102	2,750	1,000
Drum magazine or link belt	60, 200	Air	110	2,750	450-500
Magazine	10	Air	164	2,700	150-180
Drum magazine	60	Air	84	2,750	450-500
Drum magazine	30	Air	107	2,650	360
Link belt	200	Air	115	2,250	350-400
Link belt	50	Air	93½	2,590	700-750
Drum magazine	30	Air	335	2,950	230-260

## Cannon (concluded)

Weapon	Bore	Country of origin	Use	Method of operation	Type of lock
MK-103 (Rheinmetall)	30 mm	Germany	A	Gas-actuated piston	Swinging locks
MK-108 (Rheinmetall)	30 mm	Germany	A	Blow back	Inertia
MK-ST-11 (Rheinmetall)	20 mm	Germany	A	Short recoil	Pivoting lock
Nine Tenths (T2)	Cal. .90	U. S. A.	A	Blow back	Inertia
Oerlikon	20 mm	Switzerland	A	Blow back	Inertia
Polsten	20 mm	England	A	Blow back	Inertia
Puteaux	37 mm	France	A	Long recoil	Rotating bolt
Revelli	25.4 mm	Italy	A	Short recoil	Rotating bolt
Semag	20 mm	Switzerland	A A-A	Blow back	Inertia
Scotti	20 mm	Italy	A	Gas-actuated piston, blow back	Rotating bolt
Solothurn	20 mm	Germany	A-A	Short recoil	Pivoting lock
Szakats	20 mm	Germany	A	Blow back	Inertia
Vickers Armstrong	37 mm	England	A	Long recoil	Rotating bolt



Type of feed	Capacity of feed	Method of cooling	Weight of gun and feed (in pounds)	Muzzle velocity (ft. per sec.)	Rate of fire (r. p. m.)
Link belt	25-100	Air	308	2,820	420
Link belt	200	Air	135	1,640	400-450
Magazine	20	Air	118	2,250	350-380
Flat magazine	48	Air	313	2,850	400-450
Drum magazine	60	Air	136	2,610	280
Magazine	30	Air	121	2,720	450
Magazine	5	Air	198½	1,250	60
Magazine	8	Air	99	1,320	150
Magazine	20	Air	94.6	2,100	350
Magazine	60	Air	156	2,650	350-400
Magazine	20	Air	142	2,505	280
Link belt	100	Air	91	1,500	400-450
Magazine	6	Air	150	2,000	150

# BIBLIOGRAPHY

## BOOKS

- ABBOT, W. J. *Aircraft and Submarines*. 1918.
- ADER, C. *L'Aviation Militaire en France*. 1907.
- Aircraft in War and Commerce*. 1918.
- AMERICAN MACHINIST. *Artillery and Small-Arms Ammunition*. 1942.
- . *Gun Manufacture*. 1942.
- ARNOLD, H. H. *Winged Warfare*. 1941.
- BALLEISEN, CHARLES E. *Principles of Firearms*. 1945.
- BARNES, G. M. *Weapons of World War II*. 1947.
- BARRES, MAURICE. *L'Aviation Pendant la Guerre*. 1916.
- BARTLETT, W. A. and GALLATIN, D. B. *Digest of Cartridges for Small Arms*. 1878.
- . *Weapons of War*. 1883.
- BLACK, ARCHIBALD. *The Story of Flying*. 1943.
- BLANCHI, H. J. *A Century of Guns*. 1909.
- BOND, P. S. *Rifle Company Weapons*. 1941.
- BOOTH, HAROLD H. *Combat Planes*. 1944.
- BORUP, H. D. *Hotchkiss Revolving Cannon*. 1886.
- BRADSHAW, STANLEY O. *Flying Memories*. 1934.
- BROWNING ARMS CO. *A History of Browning Guns from 1831*. 1942.
- BRUCHISS, LOUIS. *Aircraft Armament*. 1945.
- BUTZ, A. *MG-34*. 1941.
- CHAMOT, EMILE M. *The Microscopy of Small Arms Primers*. 1922.
- CLAVARINO, ALFEO. *Armi e Tiro*. 1890.
- COLT'S AUTOMATIC FIRE ARMS CO. *A Century of Achievement, 1836-1936*. 1936.
- COLVIN, FRED H. and VIALI, ETHAN. *United States Rifles and Machine Guns*. 1917.
- CRABTREE, J. B. and others. *The Marvels of Modern Mechanism*. 1901.
- CROZIER, WILLIAM. *Ordnance and the World War*. 1920.
- CURTI, P. *Automatische Waffen*. n. d.
- DAVID, EVAN J. *Aircraft*. 1919.
- DU PONT DE NEMOURS, E. I., AND CO. *The Du Pont Company and Munitions*. 1934.
- FAHRENWALD, F. A. *The Development of Non-corrodible Gun Barrels*. 1921.
- FARROW, EDWARD S. *American Guns in the War with Germany*. 1920.
- . *American Small Arms*. 1904.
- . *Military Encyclopedia*. 3 volumes. 1885.
- FFOULKES, CHARLES. *The Gun-Founders of England*. 1937.
- FLECK, A. *Maschinen Gewehre*. 1909-1913.
- FORTUNE (magazine). *Arms and the Men*. 1934.
- FRANCE. MINISTRY OF WAR. *Fusil-mitrailleur, Model 1915*. 1922.
- . *Instruction pour les Unites des Mitrailleuses d'Infanterie*. 1932.
- FRANCISCO, SAMOYOA C. *Reglamento Tactico de Ametrallador*. 1944.
- GARDNER, W. *Machine Guns and How to Use Them*. 1882.
- GATLING GUN CO. *The Gatling Gun, Official Reports of Trials*. 1878.
- GENERAL MOTORS CORP. *G. M. Frigidaire at War*. 1944.
- GEORGE, J. N. *English Pistols and Revolvers*. 1938.
- GERMANY. *Luftwaffe. 2 cm Flak 30 Waffe*. 1937.
- GIARDINI, W. *Armi e Tiro*. 1943.
- GREAT BRITAIN. WAR OFFICE. *0.45" Gardner Gun*. 1894.
- . *303-in. Hotchkiss Machine Gun*. 1917.
- . *Instructions, Care, Inspection and Repair, etc. of Small Arms, Machine Guns and Bicycles*. 1933.
- . *303-in Maxim Gun*. 1901.
- . *303 and 303" Converted Maxim Machine Guns*. 1911.
- . *0.45" Maxim m. h. Chamber Machine Gun*. 1890.
- . *1" 4 Barrel Nordenfjelt Gun*. 1889.
- . *0.45-inch 5-Barrel Nordenfjelt Guns, Marks I and II*. 1894.
- . *Textbook of Small Arms*. 1929.
- . *300 Vickers Machine Gun Mechanism Made Easy*. 1942.
- GREY, CHARLES G. *The History of Combat Airplanes*. 1941.
- HAMMERTON, SIR JOHN. *Aerial Wonders of Our Time*. 2 volumes. 1937.
- HARPER, HARRY. *The Aeroplane in War*. 1942.
- HATCHER, JULIAN S. *Hatcher's Notebook*. 1947.
- HATCHER, JULIAN S. and others. *Machine Guns*. 1917.
- HAWKS, ELLISON. *Aircraft Armament, Past and Present*. 1915.
- HEARNE, R. P. *Aerial Warfare*. 1909.
- HEIDEN, HERMANN. *Gewehre Frei!* 1938.
- HICKS, JAMES E. and JANDOT, ANDRE. *Notes on French Ordnance, 1717 to 1936*. 1936.
- HICKS, JAMES E. *Notes on United States Ordnance*. 1940.
- . *Our Arms and Weapons*. 1941.
- HODGES, LEROY. *Notes on Post-war Ordnance Development*. 1923.
- HOHM, I. F. *Die Waffen der Luftstreitkräfte*. n. d.
- HOPKINS, OWEN J. *Drill Manual for the Gatling Gun*. 1900.
- HOTCHKISS ORDNANCE COMPANY, LTD. *Descriptive Catalogue of War Material*. 1893.
- Instruction sur la Mitrailleuse Automatique Hotchkiss (Model 1899)*. 1899.
- ITALY. MINISTRY OF WAR. *Istruzione Provvisoria sul Moschetto Automatico Bretta, cal. 8.8, mod. 38A*. 1943.
- JACKLIN, G., and WHIPP, DEREK. *The 303 Lewis Gun*. 1942.
- JANE, F. T. *All the World's Aircraft*. 1917-1919.

- JESSEN, HALVOR. *Automatic Standard Arms of Modern Warfare*. 1946.
- JOHNSON, MELVIN M., JR. *Rifles and Machine Guns*. 1944.
- JOHNSON, MELVIN M., JR. and HAVEN, CHARLES T. *Automatic Arms*. 1941.
- . *Automatic Weapons of the World*. 1945.
- . *Weapons for the Future*. 1943.
- KEITH, C. H. *I Hold My Aim*. 1946.
- KITTREDGE, B. AND CO. *Manual on Breech-loading Gun*. 1876.
- KOEHRNER, ALFRED. *The Hotchkiss Revolving Cannon*. 1879.
- LAHM, FRANK P. *How Our Army Grew Wings*. 1943.
- LEIGH, HOWARD. *Planes of the Great War*. 1934.
- LEONING, G. C. *Military Aeroplanes*. 1918.
- LEWIS, I. N. *Lewis Automatic Machine Rifle*. 1917.
- LONGSTAFF, F. V. and ATTERIDGE, H. A. *The Book of the Machine Gun*. 1917.
- LOW, A. M. *Modern Armaments*. 1940.
- . *Musket to Machine Gun*. 1943.
- MCCCLINTOCK, MARSHALL. *The Story of War Weapons*. 1945.
- MCLEAN, J. H. *Peace Makers*. 1880.
- MANDEL, ROBERIO. *La Guerra Aerea*. 1933.
- MARIOTTI. *Unser Leichtes Maschinengewehr*. 1942.
- . *Unser Maschinengewehr*. 1940.
- MARSH, ROGER. *The First Model Maxim Automatic Machine Gun*. 1945.
- MAXIM, HIRAM S. *My Life*. 1915.
- MINTON, M. V. *Prontuario de Armento*. 1939.
- MOLTER, BENNET A. *Knights of the Air*. 1918.
- MUSGRAVE, DANIEL. *The Automatic Weapon* (manuscript).
- NEWBOLD, J. T. *How Europe Armed for War, 1871-1914*. 1913.
- NEWMAN, JAMES R. *The Tools of War*. 1942.
- NORDENFELT, THORSTEN. *Nordenfelt Machine Gun*. 1884.
- NORTON, CHARLES B. *American Breech Loading Small Arms*. 1872.
- . *Breech Loading Small Arms*. 1882.
- OWEN. *Mitrailleurs or Machine Guns*. 1874.
- PARKER, JOHN H. *History of the Gatling Gun Detachment at Santiago*. 1898.
- PASSOW, KURT. *Taschenbuch der Heere*. 1939.
- PAYNE, CALLOWAY. *The Cross Bow*. n. d.
- PECK, JAMES L. H. *Armies with Wings*. 1940.
- PIERCE, W. O. D. *Air War*. 1937.
- POLLARD, H. B. C. *A History of Firearms*. 1936.
- PRIDHAM, C. H. B. *Anti-aircraft Defense*. 1941.
- . *Lewis Gun Mechanism Made Easy*. 1942.
- . *Superiority of Fire*. 1945.
- REMINGTON ARMS CO., INC. *A New Chapter in an Old Story. Revelli automatic machine gun*. 1917.
- RHEINISCHE METALLWAREN UND MASCHINENFABRIK, DUSSELDORF. *Machine Gun Dreyse*. 1914.
- ROBERTS, B. S. *Solid Shot and Shells*. 1864.
- ROE, JOSEPH W. *Connecticut Inventors*. 1934.
- SAVAGE ARMS CORP. *Handbook of the Lewis Machine Gun (Airplane Type) Model 1917-1918*. 1919.
- . *Handbook of Lewis Machine Gun, Model 1917*. 1919.
- . *Lewis Automatic Machine Gun*. n. d.
- SIMON, LESLIE E. *Report on German Scientific Establishments*. 1945.
- SKODA, E. *La Mitrailleuse Skoda Mod 1902 et Son Emploi*. 1902.
- SMITH, W. H. B. *Basic Manual of Military Small Arms*. 1945.
- . *Mauser Rifles and Pistols*. 1947.
- SPAIN. *Ministry of War. Instruccion de Tiro con Ametralladoras de Infanteria*. 1911.
- SVESHNIKOFF, W. W. *Some Factors Affecting the Life of Machine Gun Barrels*. 1921.
- TILSON, JOHN Q. *Arms, Ammunition, Airplanes and Gas Masks*. 1918.
- TOMBESI, TITO. *Armamento Aereo*. 1943.
- U. S. ARMY ORDNANCE DEPARTMENT. *Anti-aircraft Matériel for Machine Guns*. 1919.
- . *Base Shop Data. Gun, Automatic, 20 m/m, M1 and M2*. 1943.
- . *Base Shop Data. Gun, Automatic, 37 m/m, M4 (aircraft)*. 1944.
- . *Enemy Ordnance Matériel*. 1945.
- . *Handbook of Ordnance Data*. 1919.
- . *Handbook of the Automatic Machine Rifle, cal. 30, Model of 1909*. 1909.
- . *Handbook of the Colt Automatic Machine Gun (cal. 30)*. 1917.
- . *Handbook of the Maxim Automatic Machine Gun, cal. 30, Model 1904*. 1917.
- . *Handbook of the Vickers Machine Gun, Model of 1915*. 1917.
- . *Handbook on the Colt Machine Gun, Model 1917, cal. 30*. 1917.
- . *History of Machine Guns and Automatic Rifles*. 1922.
- . *Vickers Aircraft Machine Gun, Model of 1918, Service Handbook*. 1919.
- U. S. BUREAU OF AIRCRAFT PRODUCTION. *Handbook of Aircraft Armament*. 1918.
- U. S. CHIEF OF NAVAL OPERATIONS. *U. S. Naval Aviation in the Pacific*. 1947.
- U. S. LIBRARY OF CONGRESS. *Firearms, Ammunition, Explosives and Fireworks: A Selected List*. 1943.
- VERY, EDWARD W. *The Hotchkiss Revolving Cannon*. 1885.
- VICKERS SONS AND MAXIM, LTD. *Modern Types of Battleships, Cruisers and Ordnance, as Manufactured by the Firm*. n. d.
- WALKER, JOHN B. *War in the Air*. 1941.
- WELLS, DAVID A. *Annual of Scientific Discovery*. 1861.
- . *Welt in Waffen*. 1933.
- WHITE, GRAHAME C. and HARPER, HARRY. *The Aeroplane in War*. 1942.
- WILSON, R. K. *Textbook of Automatic Pistols, 1884-1935*.
- WOODHOUSE, HENRY. *Textbook of Military Aeronautics*. 1918.
- . *Textbook of Naval Aeronautics*. 1917.
- ZULOAGA, A. M. C. *La Guerra Aerea*. 1938.

## PERIODICALS

Many magazines and journals were consulted in the preparation of this book and supplied much valuable material. A complete list of these references is not given here. However, the following periodicals were used in preparing the volume:

*Aerial Age Weekly.* 1916-1918.  
*Aero Digest.* 1938-1944.  
*Aeronautics.* 1915-1940.  
*L'Aeroplane.* 1936-1938.  
*Aeroplane.* 1939-1940.  
*Aircraft.* 1943.  
*Aircraft Engineering.* 1947.  
*Aircraft Production.* 1939-1941.  
*Army Ordnance.* 1921-1943.  
*Aviation.* 1917-1929.  
*Aviation and Aircraft Journal.* 1921.  
*Aviation Book.* 1918.  
*Canadian Aviation's News.* 1940.  
*Cassier's Magazine.* 1900.  
*Collier's Weekly.* 1918.  
*Commercial Aviation.* 1944-1945.  
*Current Events.* 1914-1916.  
*Current History.* 1917.  
*Current Literature.* 1900.  
*Deutsche Luftwacht.* Luftwehr und Luftwissen. 1934-1940.  
*Flight.* 1934-1943.  
*Flug Sport.* 1934.  
*Flying.* 1914-1919.  
*Flying Aero Club of America.* 1912-1915.  
*Forum.* 1918.  
*La Guerra Aerea.* 1938.  
*Hampton Columbian Magazine.* 1912.  
*Harper's Weekly.* 1898-1903.  
*Hearst's Magazine.* 1913.  
*Illustrated Review.* 1917-1918.  
*Illustrierte Zeitung.* 1916-1917.

*Interavia.* 1935-1938.  
*Leslie's Weekly.* 1916-1918.  
*Literary Digest.* 1912-1918.  
*London News.* 1915-1919.  
*North American Review.* 1930.  
*Popular Aviation.* 1938-1940.  
*Popular Science.* 1872-1918.  
*Review of Reviews.* 1908-1928.  
*Revista Aeronautica.* 1935-1936.  
*Revue d'artillerie.* 1898.  
*Revue de l'armee de l'air.* 1934-1939.  
*Revue des Forces Aeriennes.* 1930-1933.  
*Revista Aeronautica.* 1933-1938.  
*Royal Aeronautical Society. Journal.* 1936.  
*St. Nicholas.* 1918.  
*Scientific American and Supplement.* 1881-1927.  
*Sea Power.* 1916.  
*Technical World Magazine.* 1912-1914.  
*United Service Institution. Journal.* 1863-1870.

## OTHER SOURCES

Of the sources for this publication, perhaps the most valuable were reports and documents from the files of the United States Government. Such material was obtained, among others, from offices of the Department of Defense, the National Archives, the Library of Congress, the Smithsonian Institute, and the United States Patent Office.

The documents include intelligence reports from military and naval attachés, proving ground reports, annual reports of the Army Ordnance Department and the Navy's Bureau of Ordnance, patents on foreign and domestic mechanisms, handbooks, notes on foreign ordnance, correspondence on contracts, etc., and photographs and other illustrations.

Another exceptional source consisted in personal correspondence and conversations with inventors, manufacturers, and researchers in the field of ordnance.

# INDEX

	<i>Page</i>		<i>Page</i>
AB. Bofors-Gullspång	610	Armor	18
Aberdeen Proving Ground, Md.	480,	Armor-piercing ammunition	315
481, 511, 514, 571, 574, 578, 580, 581, 583, 586		Armor-piercing projectiles	115
AC Spark Plug Div., General Motors Corp.	339	Armor plate on aircraft	314
Accles, James G.	57, 60, 63	Armstrong, William G., Co.	55, 77
Accles feed	60	Armstrong-Whitworth Co.	532
Adams, Capt. F. R. S.	579	<i>Army and Navy Register</i>	289
Ader, Clement	260, 261, 264	Army-Navy Board	167-168
Aerodrome	261	Arnold, (Gen.) Henry H.	267, 1076
Ager, Wilson	37	Arrows dropped from planes	347
Ager gun	37-40, 48	Arsiad synchronizer	301
Agnelli, Giovanni	374	Auray, Battle of	18
Aircraft, Early	259-274	Auto Ordnance Co.	237
Aircraft, Naval	269-271	Automatic aircraft cannon, cal. .90 series	573,
Aircraft armament, Early	268-278	607-609	
Aircraft Armament Board	325-326	Automatic Arms Co.	275,
Aircraft Armament Unit	588	278, 279, 285, 286	
Aircraft cannon ( <i>See</i> Individual names of cannon)		Aviation, French	265-266
Aircraft launching	269-271	Aviation, German	266
Alfonso XIII	562	Aviation, Russian	265
Allen, Capt. Henry B.	182	Avion	261
American Armament aircraft cannon, 37 mm	593-595	"Avions-cannons"	508
American Armament Co.	593		
AN-M1 adapter	583	B.A.R. (Browning automatic rifle)	175-176,
AN-M2 aircraft cannon, 20 mm	576-577,	180-181, 342-343, 401	
578-583, 585-590		B.S.A. aircraft machine gun	412-415
( <i>See also</i> Hispano-Suiza aircraft cannon, Type 404, 20 mm; M1 aircraft cannon, 20 mm; M2 aircraft cannon, 20 mm)		Bacon, Roger	11, 259
AN-M1 electric trigger	582-583	Bailey, Fortune L.	107, 108, 109
AN-M1 feed mechanism, 20 mm	581	Bailey machine gun	107-109
AN-M1A1 feed mechanism, 20 mm	581	Baker, Newton D.	180
Anciens Etablissements Pieper	243	Baldwin, A. S.	526, 529
Ansaldo Co. ( <i>See</i> Società Italiana Ansaldo)		Baldwin, F. W.	264
Antiaircraft guns	315, 553, 554-555, 604-606	Baldwin, Capt. Thomas G.	267
Antitank guns	315, 316, 499	Baldwin aircraft cannon, 37 mm	526-530
Archery laws	9	Ballista	5, 8
Armes Automatiques Lewis	279	"Ballon poste"	260
		Balloon gun	202-203
		Balloons	259, 260
		Bang, Soren Hansen	464
		Bang aircraft machine gun	464

- |  | <i>Page</i>                               |   | <i>Page</i> |
|--|---|---|-------------|
| Barnes, C. E. ....   | 24  | Blanchard, Thomas .....                                   | 30          |
| Barnes machine cannon .....  | 24-25                                     | Bleriot, Louis .....                                      | 265, 346    |
| Battery guns .....   | 15  | Boer war .....  | 144         |
| Battleax .....   | 3   | Bofors aircraft cannon .....                              | 610-613     |
| Beals, Fordyce .....   | 28  | Bofors Co. ( <i>See</i> AB. Bofors-Gullspång)             |             |
| Beardmore, William, & Co. ....   | 389                                       | Bolle, Rettmeister .....                                  | 457         |
| Beardmore-Farquhar aircraft machine<br>gun .....   | 389-392                                   | Bombard .....   | 15          |
| Becker, Reinhold .....   | 512, 514, 515, 520                        | Bombs, Aerial .....                                       | 270-271     |
| Becker aircraft cannon, 20 mm ..   | 512-514, 515                              | Bombsight .....   | 273         |
| Becker Stahlwerk .....   | 512                                       | Borchardt, Hugo .....                                     | 310         |
| "Belgian rattlesnake" .....  | 284                                       | Borg Warner Corp. ....                                    | 580         |
| Bell, Alexander Graham .....   | 264                                       | Bow .....   | 4, 5        |
| Belts, Disintegrating link .....   | 304                                       | ( <i>See also</i> Crossbow; longbow)                      |             |
| Belts, Metal link .....  | 321                                       | Bowden cable control system .....                         | 582         |
| Bendix Aviation Corp. ....   | 574, 575, 576, 579, 582                   | Boxer cartridge .....                                     | 56          |
| Benét, Laurence V. ....  | 187, 188, 191                             | Breda aircraft cannon, 20 mm .....                        | 598-601     |
| Benét, (Gen.) Stephen V. ....  | 54, 80, 187                               | Breda Co. ( <i>See</i> Società Italiana Ernesto<br>Breda) |             |
| Benét-Mercié machine rifle .....   | 195-200,<br>287, 345-347                  | Breda machine guns .....                                  | 416-424     |
| ( <i>See also</i> Hotchkiss machine gun)   |   | Breda-Safat machine gun .....                             | 423-424     |
| Bergman, Capt. W. ....   | 204                                       | Bren machine gun .....                                    | 432-433     |
| Bergmann, Theodor .....  | 214, 453                                  | ( <i>See also</i> ZB machine gun)                         |             |
| Bergmann Industrie Werke Abt.<br>Waffenbau .....   | 214, 364, 365                             | Brescia Metallurgical Works .....                         | 393         |
| Bergmann machine guns ....   | 214-216, 364-367                          | Brevets-Aero-Mecaniques S. A. ....                        | 574         |
| Berthier, André V. P. M. ....  | 243,<br>244, 245, 246, 247                | Brevetti-Scotti S. A. ....                                | 461, 563    |
| Berthier machine guns .....  | 243-247, 441                              | Brewster Aeronautical Corp. ....                          | 576         |
| ( <i>See also</i> Vickers-Berthier machine gun)  |   | British Manufacture and Research Co. ....                 | 568         |
| Berthier-Pacha rifle .....   | 243                                       | British Sten Co. ....                                     | 521         |
| Besa machine gun .....   | 436-440                                   | Brixia machine gun, model 1920 .....                      | 393-396     |
| ( <i>See also</i> ZB machine gun)  |   | Brno ZB machine gun ( <i>See</i> ZB machine gun)          |             |
| Bessemer, Sir Henry .....  | 24  | Brooks, Sidney .....                                      | 288         |
| Bettington, Maj. A. V. ....  | 301                                       | Brown-Lipe-Chappin Div., General Motors<br>Corp. ....     | 339         |
| Billingham Co. ....  | 36  | Browning, J. M. & M. S., Co. ....                         | 158, 179    |
| Billingham Requa battery .....   | 35-36                                     | Browning, John M.:  |             |
| Bilney, Christopher .....  | 565                                       | Auto-loading pistol invented .....                        | 166         |
| Birkigt, Louis .....   | 562                                       | Contrast with Maxim's career .....                        | 156         |
| Birkigt, Marc .....  | 508, 562, 563                             | Demonstrates B.A.R. and water-cooled<br>gun .....         | 175-177     |
| Birkigt aircraft cannon, Type 404 ( <i>See</i> AN-<br>M2 aircraft cannon, 20 mm; Hispano-<br>Suiza aircraft cannon, Type 404, 20 mm;<br>M1 [etc.] aircraft cannon, 20 mm; Mark<br>I [etc.] aircraft cannon, 20 mm) |   | Development of cannon .....                               | 531-532     |
| Birkigt aircraft motor cannon .....  | 562                                       | Early rifle inventions .....                              | 157-161     |
| Birmingham Small Arms aircraft machine<br>gun ( <i>See</i> B.S.A. aircraft machine gun)  |   | Eulogized after death .....                               | 186         |
| Birmingham Small Arms Co. ....   | 131,<br>279, 286, 291, 413, 432, 436, 502 | First machine gun .....                                   | 160-163     |
|  |   | Inspects Baldwin cannon .....                             | 527         |
|  |   | Patents water-cooled gun in 1901 .....                    | 170         |
|  |   | Refinement of cal. .50 machine gun ....                   | 334         |
|  |   | Royalties in World War I .....                            | 179-180     |
|  |   | Undertakes cal. .50 machine gun ...                       | 182-186     |
|  |   | Browning, Jonathan .....                                  | 156-158     |
|  |   | Browning, Matthew S. ....                                 | 158, 161    |

- |   | <i>Page</i>           |   | <i>Page</i>   |
|---|-----------------------|---|---|
| Browning aircraft cannon, 37 mm . . . . .           | 531-536               | Chandler, Capt. Charles DeForest . . . . .      | 267,<br>275, 276  |
| Browning auto-loading pistol . . . . .              | 166                   | Chargers, Hydraulic . . . . .                   | 582   |
| Browning auto-loading shotgun . . . . .             | 166                   | "Chars de cannon" . . . . .                     | 13  |
| Browning automatic rifle ( <i>See</i> B.A.R.)       |                       | Chassepot rifle . . . . .                       | 65  |
| Browning machine guns:                              |                       | Chatellerault aircraft machine gun, Model       |   |
| Aircraft model, 11 mm . . . . .                     | 330-331               | 1934 . . . . .                                  | 405-406   |
| Caliber .30:  |                       | Chatellerault feed . . . . .                    | 569, 580, 581, 585, 587   |
| Model 1900 . . . . .                                | 169-173               | Chatellerault machine gun . . . . .             | 401-406   |
| Model 1917 . . . . .                                | 175, 176-180          | Chatellerault tank, armored-car, fortress       |   |
| Model 1918 . . . . .                                | 327, 328-330          | machine gun . . . . .                           | 405   |
| Model 1921 . . . . .                                | 332-333               | Chauchat, Col. . . . .                          | 242   |
| M2 . . . . .  | 333                   | Chauchat machine rifle . . . . .                | 238-242   |
| Caliber .50:  |                       | Chicago Flexible Shaft Co. . . . .              | 581   |
| Model 1918 . . . . .                                | 181-186, 331-332, 333 | Chuo Kogyo Kaisha Co., Ltd. . . . .             | 688   |
| M1921 . . . . .                                     | 334                   | Citröen Motor Car Co. . . . .                   | 568   |
| M2 . . . . .  | 334-342, 614          | Civil War machine guns . . . . .                | 35-36,<br>37-47, 48, 50, 51   |
| Tabulation of models . . . . .                      | 343-344               | Claxton, F. S. . . . .                          | 41  |
| ( <i>See also</i> B.A.R.; Colt machine gun; Mar-    |                       | Claxton machine gun . . . . .                   | 41  |
| lin aircraft machine gun)                           |                       | Club . . . . .                                  | 3   |
| Buckham, George Thomas . . . . .                    | 296                   | "Coffee mill" gun ( <i>See</i> Ager gun)        |   |
| Buckham incendiary bullets . . . . .                | 296, 297              | College Park, Md. . . . .                       | 273, 275, 276, 278  |
| Buffalo Arms Corp. . . . .                          | 339                   | Collier, Elisha . . . . .                       | 20  |
| Buhrle, Emil . . . . .                              | 515                   | Coloney, Myron . . . . .                        | 104, 105, 106   |
| Burton, Bethel . . . . .                            | 379                   | Colt, Samuel . . . . .                          | 22, 25  |
| Burton machine gun . . . . .                        | 379                   | Colt automatic guns, 20 and 37 mm ( <i>See</i>  |   |
| C.C. synchronizing gear ( <i>See</i> Constantinesco |                       | Browning aircraft cannon)                       |   |
| synchronizing gear)                                 |                       | Colt machine guns:                              |   |
| C.O.W. automatic cannon, 37 mm . . . . .            | 500-504,<br>593       | Mark I . . . . .                                | 168   |
| ( <i>See also</i> Vickers-Armstrong automatic       |                       | Mark III . . . . .                              | 169   |
| cannon)   |                       | Model '95 . . . . .                             | 160-169, 320  |
| C.O.W. machine gun ( <i>See</i> Laird-Menteyne      |                       | Model 1917 . . . . .                            | 169   |
| machine gun)  |                       | ( <i>See also</i> Browning machine guns; Marlin |   |
| C.S.R.G. machine rifle ( <i>See</i> Chauchat ma-    |                       | aircraft machine gun)                           |   |
| chine rifle)  |                       | Colt revolving rifle, Model 1855 . . . . .      | 30-31   |
| Cannon, Aircraft ( <i>See</i> Individual names of   |                       | Colt's Patent Fire Arms Co. . . . .             | 22,<br>29, 30, 54, 55, 57, 58, 60, 63, 71, 79, 148, 161,<br>163, 165, 169, 177, 178, 179, 180, 181, 182, 183,<br>305, 306, 316, 331, 333, 334, 335, 336, 337, 338,<br>342, 531, 532, 536. |
| cannon)   |                       | Confederate cannon . . . . .                    | 46  |
| Cannon, Recoilless . . . . .                        | 495-499               | Confederate machine guns . . . . .              | 36, 42-47   |
| Cannon, Repeating . . . . .                         | 22                    | Constantinesco, George . . . . .                | 301   |
| Carpenter, E. W., Co. . . . .                       | 581                   | Constantinesco synchronizing gear . . . . .     | 301,<br>302, 321, 323   |
| Carr, Howard . . . . .                              | 224, 225, 226, 227    | Cook, Asa . . . . .                             | 30  |
| Carr machine gun . . . . .                          | 224-227, 281          | Cooper, James . . . . .                         | 66  |
| Cartridge, Development of . . . . .                 | 25-26                 | Cooper Fire Arms Manufacturing Co. . . . .      | 51, 54  |
| Catapult . . . . .                                  | 5, 6                  |   |   |
| Cayley, Sir George . . . . .                        | 259, 260, 263         |   |   |
| Ceskoslovenska Zbrojovka Akciova Spolec-            |                       |   |   |
| nost v Brne . . . . .                               | 429, 434, 435, 440    |   |   |
| Challenger, George H. . . . .                       | 302                   |   |   |

	<i>Page</i>		<i>Page</i>
Coventry machine gun ( <i>See</i> Laird-Menteyne machine gun)		Dormus, Col. von	150
Coventry Ordnance Works	256, 500	Drake gas machines	126
"Covered bridge" guns	36, 39	Dreyse, Johann Nikolaus von	65, 216
"Cow" gun ( <i>See</i> C.O.W. automatic cannon)		Dreyse Co.	216
Crank-operated machine cannon	24	Dreyse machine gun	216-219, 364, 368-370
Crécy, Battle of	10	Driggs-Seabury Gun and Ammunition Co.	224
Crissy, Lt. Myron S.	271	Driggs-Seabury Ordnance Co.	281
Crossbow	9	Drummond, William	16
Crozier, Gen. William	232, 285, 297, 289, 299	Eclipse Machine Div., Bendix Aviation Corp. ( <i>See</i> Bendix Aviation Corp.)	
Culley, Lt.	296, 297	Edgewater Steel Co.	580
Curtiss, Glenn H.	264, 265, 268, 270	Ehrhardt, Heinrich	450, 550
Curtiss Aircraft Co.	497	Ehrhardt aircraft cannon, 20 mm	550
Curtiss-Wright Aircraft Corp.	580, 588	Ely, Lt. Eugene	269
Curtiss-Wright Field	587	Enfield Royal Arms Manufacturing Arsenal	432, 436
Custer, Gen. George	58	Experimental Battery, Annapolis, Md.	96, 119
D.R.R.S. machine gun ( <i>See</i> Madsen automatic machine gun)		F.N. machine gun ( <i>See</i> Browning machine guns)	
D.W.M. ( <i>See</i> Deutsche Waffen- und Munitionsfabrik A. G.)		Fabbrica d'Automobili Isotta-Fraschini	461, 545, 546, 563
Dai Nippon Heiki Munitions Works	517	Fabbrica Italiana Automobili Torino (Fiat)	252, 356, 358, 360, 361, 374, 416, 505
Danish Recoil Rifle Syndicate ( <i>See</i> Dansk Rekylriffel Syndikat)		Fabrique Nationale d'Armes de Guerre	166, 186, 337, 342
Dansk Rekylriffel Syndikat	209, 407, 408, 464, 537, 538	Fafschamps, Capt.	64
Darne, Pierre	384	Fahrzeug Fabrik	523
Darne, Regis	384	Farquhar, Col. Moubray Gore	389, 391
Darne aircraft cannon, 25 mm	388	Farries, Samuel	22
Darne aircraft machine gun	384-388	Farrington, DeWitt C.	89, 92, 93, 95, 99
Davis, Cmdr. Cleland	495, 497	Farman, Henry	264, 265
Davis, Dwight F.	186	Farwell, W. B.	69
Davis recoilless cannon	495-499	Farwell machine gun	69-70
Degaille, Pierre A.	256	Feed mechanisms	580-582
De Knight, Victor P.	207	Feld machine gun	68
De Knight water-cooled machine gun	207-208	FG-42 paratroop machine gun	489-491
Deperdussin, Armand	346	Fiat Co. ( <i>See</i> Fabbrica Italiana Automobili Torino)	
de Reffye, Commandant	50, 64, 65, 67	Fiat machine gun	356-363
Deringer, Henry	28	( <i>See also</i> Revelli machine gun; Safat machine gun)	
Desvignes cartridge	305	Fickel, Lt. Jacob E.	268
Detonating powder	20	Flak 18 antiaircraft cannon, 37 mm	554-555
Deutsche Waffen- und Munitionsfabrik A. G.	310, 450, 459, 472, 602	Flak 30 antiaircraft & tank gun	553
Device 104 (recoilless cannon)	499	Flak 38 antiaircraft cannon, 20 mm	604-606
Dibovsky, Victor V.	301, 304	Fleck, Kurt	603
Dibovsky rate-of-fire attachment	304	Flintlocks	16, 20
Dietrich, L. O.	479	Flying machines	259
Dirigibles	260, 267	Fokker, Antony H. G.	312, 313, 314, 347
( <i>See also</i> Zeppelins)			
Doerge, Dr.	603		



- |   | <i>Page</i>             |   | <i>Page</i>             |
|---|-------------------------|---|-------------------------|
| Fokker synchronization system . . .           | 304, 312-314            | General Motors Corp. ( <i>See</i> AC Spark Plug, Brown-Lipe-Chappin, Frigidaire, Oldsmobile, and Saginaw Steering Gear Divs., General Motors Corp.) |                         |
| Fonck, René . . . . .                         | 509, 562                | General Ordnance Co. . . . .  | 497                     |
| Forsyth, Rev. John Alexander . . . . .        | 20-21                   | German armament nomenclature . . . . .  | 602                     |
| Fosbery, Maj. George V. . . . .               | 39, 67                  | German ordnance plant designations . . . . .  | 555                     |
| Foulois, Lt. Benjamin D. . . . .              | 267, 268, 272           | Gladiator, M. . . . .   | 242                     |
| Foure, Ferdinand . . . . .                    | 562                     | Gliders . . . . .   | 259, 260, 263           |
| Frankford Arsenal . . . . .                   | 184                     | Goethals, Geo. W., Co. . . . .  | 381                     |
| French Military Competition . . . . .         | 266                     | Gorgas, Gen. Josiah . . . . .   | 47, 48                  |
| Friberg, Lt. D. H. . . . .                    | 248                     | Gorgas machine gun . . . . .  | 46-47                   |
| Frigidaire Div., General Motors Corp. . . . . | 339                     | Gorloff machine gun . . . . .   | 57, 145                 |
| Frommer, Rudolf . . . . .                     | 238                     | Gotha armored plane . . . . .   | 314, 315                |
| Front gun, Spad . . . . .                     | 248                     | Gotha Waggonfabrik A.G. . . . .   | 314                     |
| Furrer, Col. Adolf . . . . .                  | 425, 427, 591           | Graham, Lt. Harry . . . . .   | 272                     |
| Furrer aircraft cannon . . . . .              | 591-592                 | Grandi Co. . . . .  | 461                     |
| Furrer machine gun . . . . .                  | 425-428                 | "Grape shooter" ( <i>See</i> Mitrailleur)   |                         |
| Fuze . . . . .                                | 15                      | Green, Dr. Samuel G. . . . .  | 334, 335, 336, 337      |
| Gardner, William . . . . .                    | 79, 85, 86, 88          | Greenwood, Miles, and Co. . . . .   | 49                      |
| Gardner machine gun . . . . .                 | 79-88, 163              | Grossfuss, Johannus, Metall- und Locier-<br>warenfabrik . . . . .   | 487                     |
| Garros, Roland . . . . .                      | 301, 304, 347           | Grunow, Dr. . . . .   | 484, 485, 487           |
| Garros bullet deflector . . . . .             | 347                     | Guidoni, Capt. Alessandro . . . . .   | 271                     |
| Gaskell, Lt. Penn . . . . .                   | 282                     | Gun, Automatic, 20 mm, M1, M2, & AN-<br>M2 ( <i>See</i> M1, M2, & AN-M2 aircraft can-<br>non, 20 mm)  |                         |
| Gast, Carl . . . . .                          | 379                     | Gunpowder . . . . .   | 11-12                   |
| Gast aircraft machine gun . . . . .           | 379-383, 388            | Gunsmithing . . . . .   | 20, 21-23, 29-30        |
| Gatling, Dr. Richard Jordan:                  |                         | Gustloff Werke . . . . .  | 478, 487                |
| Association with Colt's Co. . . . .           | 54                      | Guthrie and Lee Explosive Arms Co. . . . .  | 41                      |
| Challenge to other inventors . . . . .        | 58                      | Guynemyer, Georges . . . . .  | 509, 562                |
| Correspondence with Lincoln . . . . .         | 50, 52                  | Haemmerli, Rudolf . . . . .   | 425                     |
| Demonstrations of gun . . . . .               | 50                      | Hall, John H. . . . .   | 28                      |
| First machine gun . . . . .                   | 48                      | Hall, Robert Clark . . . . .  | 500                     |
| Improvements on gun . . . . .                 | 60-63                   | Hall rifle . . . . .  | 21                      |
| Negotiations with France . . . . .            | 50                      | Hambroe, Mr. . . . .  | 407                     |
| Origins and education . . . . .               | 48                      | Hatcher, (Gen.) Julian S. . . . .   | 336, 527                |
| Production of 1865 model . . . . .            | 51                      | Hazelton, George . . . . .  | 304                     |
| Gatling Gun Co. . . . .                       | 57, 60, 163             | Hazelton attachment . . . . .   | 292, 304                |
| Gatling machine guns:                         |                         | Heinemann, Karl . . . . .   | 310, 311, 364, 453, 472 |
| Adoption by Great Britain . . . . .           | 58                      | Henning, Hermann . . . . .  | 453                     |
| Adoption by the United States . . . . .       | 54                      | Henry, Tyler . . . . .  | 28, 129                 |
| Automatic model . . . . .                     | 63                      | Henry Rifle Barrel Co. . . . .  | 129                     |
| Competition with Colt machine gun . . . . .   | 163                     | Herlach, Fritz . . . . .  | 453, 551, 553           |
| Demonstrations . . . . .                      | 50                      | High Standard Manufacturing Co. . . . .   | 337, 338                |
| Improvements in design . . . . .              | 60-63                   | Higson, Percy R. . . . .  | 502                     |
| International acceptance . . . . .            | 55-57                   | Hispano-Suiza aircraft cannon, 23 mm  | 565, 570                |
| Model 1862 . . . . .                          | 48-51                   |   |                         |
| Model 1865 . . . . .                          | 51-54                   |   |                         |
| Performance in Spanish-American War . . . . . | 59                      |   |                         |
| Gazda, Antoine . . . . .                      | 515, 516, 517, 519, 520 |   |                         |
| Gazda aircraft cannon . . . . .               | 519-520                 |   |                         |

	<i>Page</i>		<i>Page</i>
Hispano-Suiza aircraft cannon, Types 7 and 9 ( <i>See</i> Oerlikon aircraft cannon, 20 mm)		Hotchkiss machine guns (continued):	
Hispano-Suiza aircraft cannon, Type 404, 20 mm:		Japanese models . . . . .	350-351, 353
Adoption by Great Britain . . . . .	566-569	Model '97 . . . . .	182-192
Adoption by the United States . . . . .	575	Model 1900 . . . . .	192-194
American and British designations	577-578	Model 1914 . . . . .	200-201
American negotiations for . . . . .	570-574	Model 1922 . . . . .	429
Bendix attempts to obtain licensing rights	574	Tabulation of models . . . . .	351-352
British modifications . . . . .	568, 569	( <i>See also</i> Benét-Mercié machine rifle;	
Contract for American production . . . . .	575	Puteaux machine gun; St. Etienne machine gun)	
Evaluation after World War II . . . . .	589-590	Hotchkiss Ordnance Co., Ltd. . . . .	77, 187
Feed mechanisms . . . . .	569, 580-581, 585, 587	( <i>See also</i> Société Anonyme des Anciens Etablissements Hotchkiss & Cie.)	
First model . . . . .	563-565	Hotchkiss "Portative" machine rifle ( <i>See</i> Benét-Mercié machine rifle)	
Japanese version . . . . .	615	Hotchkiss revolving cannon . . . . .	71-78
Licensing agreement with United States . . . . .	574-575	Humphreys, Lt. Frederick E. . . . .	267
Operation . . . . .	566	Hurley Machine Div., Thor Corp. . . . .	581
Related models (Types 405, 406, and 407)	574	Hussey, (Adm.) George F., Jr. . . . .	336
Sources of basic principles . . . . .	563-564		
Tested by United States . . . . .	571-572	Ignition of ammunition . . . . .	15-16
Types . . . . .	582-583	Incendiary bullets . . . . .	297, 310
( <i>See also</i> AN-M2 aircraft cannon, 20 mm; M1 aircraft cannon, 20 mm; M2 aircraft cannon, 20 mm; Mark I [etc.] aircraft cannon, 20 mm)		Inertia firing, Origin of . . . . .	92-93
Hispano-Suiza aircraft engines . . . . .	508, 516, 562, 573	Inter-Allied Control Commission . . . . .	316, 450, 550
Hispano-Suiza S. A. ( <i>See</i> Société Française Hispano-Suiza S. A.)		Interchangeability of parts . . . . .	21, 30
HO-5 aircraft cannon, 20 mm . . . . .	614	International Business Machines Corp. . . . .	577
HO-401 aircraft cannon, 57 mm . . . . .	615	International Harvester Co. . . . .	577, 579, 586
Hoff, Gen. Samuel . . . . .	336	Irwin, Will . . . . .	644
Holek, Emanuel . . . . .	429	Isenberg, H. C. . . . .	381
Holek, Vaclav . . . . .	429, 436, 437	Isotta-Fraschini Co. ( <i>See</i> Fabbrica d'Automobili Isotta-Fraschini)	
Hollandische Industrie und Handels Mattschapv (HIH) . . . . .	450, 550	Japanese aircraft cannon . . . . .	614-617
Hopkins and Allen Co. . . . .	181, 247	Japanese machine guns . . . . .	350-351, 353-355
Horder Bergwerk . . . . .	450	Johnson, Capt. Melvin M., USMCR . . . . .	480, 483
Horsman, Paul . . . . .	610	Johnson Automatics, Inc. . . . .	480
Hotchkiss, Benjamin B. . . . .	71, 72, 76, 77, 78, 187, 495	Johnson light machine gun . . . . .	480-483
Hotchkiss aircraft cannon, 25 mm	542-544, 570	Joyce, B. P. . . . .	593
Hotchkiss cannon, Model 1885, 37 mm . . . . .	508		
Hotchkiss & Cie. ( <i>See</i> Société Anonyme des Anciens Etablissements Hotchkiss & Cie.)		Keith, Capt. C. H. . . . .	565
Hotchkiss machine guns:		Kelsey Hayes Wheel Co. . . . .	339
Aircraft guns . . . . .	345-351	Kendall, Dennis . . . . .	568
Balloon gun, 12 mm . . . . .	202-203	Kjellman, Rudolf H. . . . .	248, 249, 250
		Kjellman-Friberg machine gun ( <i>See</i> Kjellman machine gun)	
		Kjellman machine gun . . . . .	248-250
		Knife . . . . .	4
		Knorr-Bremse Manufacturing Co. . . . .	469
		Knorr-Bremse machine gun . . . . .	469-471

	<i>Page</i>		<i>Page</i>
Krieghoff, Heinrich, Waffenfabrik .....	459, 479, 489, 555	Longbow .....	9
Krum, Alfred .....	453	Lossnitzer, Otto Helmutt von .....	603
Krupp, Friedrich, A. G. ....	450, 555, 610	Lowe, Prof. ....	260, 295
L/S light machine rifle .....	446-449	Lowell Firearms Manufacturing Co. ....	89, 91, 93, 96, 99
Lahm, Lt. Frank P. ....	267, 271	Lowell machine gun .....	89-99, 461
Lahti, Aimo Johannes .....	446, 596	Lübbe, H. F. A. ....	548
Lahti aircraft cannon, 20 mm .....	596-597	Lübbe aircraft cannon, 20 mm .....	548-549
Lahti (Suomi) light machine rifle ( <i>See</i> L/S light machine rifle)		Luger, Georg .....	310
Laird, Charles W. ....	256	Luger pistol .....	310
Laird-Menteyne machine gun .....	256	M1 aircraft cannon, 20 mm .....	576, 578, 579, 582, 583
Langley, Samuel P. ....	261, 264	M2 aircraft cannon, 20 mm ..	576-577, 585, 589
Larimer, Adm. E. B. ....	337	M3 aircraft cannon, 20 mm .....	589
Lauf, Hans .....	469, 470, 471	M1 feed mechanism, 20 mm .....	587
LePrieur rocket .....	348-349	M2 feed mechanism, 20 mm .....	587
Lewis, Col. Isaac Newton .....	275, 276, 278, 279, 281, 284, 285, 289, 290, 291, 293, 297, 298, 299.	M1 gun adapter, 20 mm .....	580
Lewis automatic machine gun:		M6 gun adapter, 20 mm .....	580, 583
Accessories for air use .....	291	M7 gun adapter, 20 mm .....	580, 583
Adoption by United States Navy ...	293-295	M1 magazine, 60 round, 20 mm .....	580
Aerial use by British .....	282-284	M1A1 magazine, 60 round, 20 mm .....	580
Aircraft models .....	293	M2 manual charger .....	583
British production in World War I	279-281	M1 muzzle brake .....	582, 583
Comparison with B.S.A. machine gun ..	412	M1 sear mechanism .....	583
Comparison with FG-42 machine gun ..	491	McClellan, Samuel N. ....	232, 235, 237, 279
Derivation .....	279	McClellan automatic cannon .....	232-237
Ends Zeppelin menace .....	295-297	McClellan-Lissak automatic rifle .....	237, 279
European demonstrations .....	278-279	McClellan machine gun ( <i>See</i> McClellan-Lissak automatic rifle)	
First aerial firing .....	275-278	McClellan Ordnance and Arms Co. ...	232, 237
Memorandum by Chief of Ordnance	285-288	McClellan, Gen. George B. ....	39, 40
Operation .....	281	McClung, Cmdr. Edgar R. ....	336, 337
Presentation to Army Board .....	278	McCurdy, J. A. D. ....	264
Press comments on .....	288-289	Machine gun 08 ( <i>See</i> T.u.F. machine gun)	
Production by Savage Arms Co. ...	279-281	Machine guns ( <i>See</i> Individual names of weapons)	
Production in World War I .....	293	Machine tools .....	29
Reasons for failure in American tests	289-291	McLean, Dr. James H. ....	104, 105, 106
Speeding up of weapon .....	291-292	McLean's "Peace Makers" .....	104-106
Tabulation of models .....	299-300	McWhinny, Rindge and Co. ....	49
Use since World War I .....	299	Maddox, Ens. Charles H. ....	273
Lewis automatic rifle .....	284	Madsen aircraft cannon .....	537-541, 570, 572, 573
LH-33 machine gun ( <i>See</i> Knorr-Bremse machine gun)		Madsen machine guns .....	209-213, 407-411
Lille, Sir James S. ....	24	Magazines ( <i>See</i> Feed mechanisms)	
Lincoln, Abraham .....	39, 40, 50	Maget Co. ....	478, 487
Linden, Thomas E. ....	24	Magnavox Co. ....	582
Lissak, Col. O. M. ....	237	Mahoney, Cmdr. John J. ....	336, 337
Loiseau, M. ....	345	Mancini, Niccolo .....	465

- |   | <i>Page</i>        |  | <i>Page</i>        |
|---|--------------------|--|--------------------|
| Mandl, Fritz .....                          | 451                | Maxim machine guns:                        |                    |
| Manly, Charles E. ....                      | 261                | Adoption by Germany .....                  | 146                |
| Mannlicher, Ferdinand .....                 | 473                | Caliber .75 gun .....                      | 143                |
| Mannlicher self-loading pistol .....        | 239                | Description of 1884 model .....            | 131-134            |
| Manton, Marcus D. ....                      | 282                | Early use in battle .....                  | 142, 144-147       |
| Manufacture d'Armes de Chatellerault ..     | 401,               | European trials .....                      | 136-139            |
|   | 403, 406           | First purchase by British .....            | 136                |
| Manville, Eli J. ....                       | 30                 | First working model .....                  | 128-131            |
| Marek, Anton .....                          | 429, 435           | German model '08 .....                     | 309-310            |
| Mark I aircraft cannon, 20 mm .....         | 577                | Operation .....                            | 134-136            |
| Mark II aircraft cannon, 20 mm .....        | 577,               | Performance with various cartridges        | 140-141            |
|   | 578, 579, 585      | Pom-pom shell gun .....                    | 143-144            |
| Mark V aircraft cannon, 20 mm .....         | 585                | Rapid-fire performance .....               | 141                |
| Marlin, J. M. ....                          | 320                | Russian model M1910 .....                  | 146                |
| Marlin aircraft machine gun .....           | 320-326            | Tabulation of models .....                 | 317-319            |
| (See also Colt machine gun, Model '95)      |                    | Trials in United States .....              | 147                |
| Marlin Firearms Co. ....                    | 320                | (See also Parabellum machine gun;          |                    |
| Marlin-Rockwell Corp. ....                  | 181, 320, 321, 328 | T.u.F. machine gun; Vickers machine        |                    |
| Mascarucci, Giuseppe ....                   | 358, 360, 423, 424 | gun; Vickers-Maxim machine gun)            |                    |
| Maschinenfabrik-Augsburg-Nuremburg          |                    | Maxim-Nordenfelt Guns and Ammunition       |                    |
| A. G. ....                                  | 316                | Co. ....                                   | 142                |
| Mass production .....                       | 21, 23             | Maxim-Nordenfelt rifle-caliber machine gun | 143                |
| Massuger, Louis .....                       | 562                | Maxim-Weston Co. ....                      | 128                |
| Mausser, Andreas .....                      | 472                | Mayo Radiator Co. ....                     | 181                |
| Mausser, Paul .....                         | 472, 473           | Means smoke telegraph system .....         | 274                |
| Mausser A.G. (See Waffenfabrik Mauser       |                    | Mendoza, Rafael .....                      | 397, 398, 400      |
| A.G.)                                       |                    | Mendoza light machine gun .....            | 397-400            |
| Mausser automatic cannon (See MG-151 air-   |                    | Menteyne, Paul M. ....                     | 256                |
| craft cannon, 20 mm; Flak 38 antiaircraft   |                    | Mercié, Henri A. ....                      | 187, 188, 196      |
| cannon, 20 mm)                              |                    | Mercury fulminate .....                    | 20-21              |
| Mausser machine guns (See MG-34 light       |                    | Mergenthaler Linotype Co .....             | 575                |
| machine gun; MG-81 aircraft machine         |                    | MG-151 aircraft cannon, 20 mm .....        | 602-604            |
| gun)  |                    | MG-15 aircraft machine gun ...             | 454-455, 478       |
| Maxim, Hiram Stevens:                       |                    | MG-17 aircraft machine gun .....           | 455-457            |
| Activities in electrical engineering        | 127-128            | MG-81 aircraft machine gun .....           | 478-479            |
| Article published in <i>Engineering</i> ... | 140-141            | MG-131 aircraft machine gun .....          | 457-460            |
| Demonstrations of weapon .....              | 131,               | MG-13 light machine gun .....              | 367-370, 550       |
|   | 134, 136-139       | MG-30 light machine gun .....              | 453-454            |
| Departure for Europe .....                  | 127                | MG-34 light machine gun .....              | 473-478, 484       |
| Designs flying machine .....                | 261                | MG-42 light machine gun .....              | 484-488, 489       |
| Designs gas machines .....                  | 126                | Military aviation, Early .....             | 265-268            |
| Early years .....                           | 123-128            | Milling, Lt. T. DeWitt ....                | 267, 272, 273, 276 |
| First automatic machine gun .....           | 128-131            | Minié-type bullet .....                    | 39                 |
| Improvements on guns .....                  | 134                | Miranda, I. J. ....                        | 593                |
| Later inventions .....                      | 143-144            | Mitrailleuse weapons .....                 | 64-68              |
| Production facilities .....                 | 142                | Mitsubishi Tank Factory .....              | 517                |
| Reception of gun by European                |                    | MK-101 aircraft cannon, 30 mm .....        | 555-556            |
| public .....                                | 136-140            | MK-103 aircraft cannon, 30 mm .....        | 557-558            |
| Maxim Gas Machine Co. ....                  | 127                | MK-108 aircraft cannon, 30 mm .....        | 558-561            |

- |   | <i>Page</i>                  |   | <i>Page</i>               |
|---|------------------------------|---|---------------------------|
| MK-ST-11 aircraft cannon . . . . .                | 552                          | Oerlikon aircraft cannon, 20 mm (continued):                  |                           |
| (See also Solothurn cannon)                       |                              | Derivation from Becker cannon . . . . .                       | 515                       |
| MK-ST-5 antiaircraft cannon . . . . .             | 553                          | Fired in competition with Hispano-Suiza                       |                           |
| (See also Solothurn cannon)                       |                              | Type 404 cannon . . . . .                                     | 565                       |
| MK S-18-100 semiautomatic antitank gun . . . . .  | 554                          | Japanese adaptations . . . . .                                | 614                       |
| MK S-18-1000 semiautomatic antitank gun . . . . . | 554                          | Models . . . . .  | 515                       |
| Model 98 automatic cannon, 20 mm . . . . .        | 615-617                      | Operation . . . . .   | 522                       |
| Mohammed II . . . . .                             | 15                           | Produced by Hispano-Suiza under license . . . . .             | 563                       |
| Mondragon, Manuel . . . . .                       | 282                          | Test by U. S. Navy authorized . . . . .                       | 570, 572                  |
| Mondragon self-loading rifle . . . . .            | 282                          | Oerlikon Co. (See Werkzeug Maschinenfabrik Oerlikon)          |                           |
| Montgolfier brothers . . . . .                    | 259                          | Oerlikon-Zurich Co. . . . .                                   | 515, 545, 563             |
| Montigny, Joseph . . . . .                        | 64, 68                       | Oldsmobile Div., General Motors Corp. . . . .                 | 577,                      |
| Montigny mitrailleuse . . . . .                   | 64-68                        | . . . . .   | 579, 580, 585, 586, 587   |
| Moore, Fred T. . . . .                            | 334, 337, 527, 531, 536      | Ordnance Committee (See U.S. Ordnance Committee)              |                           |
| Moore-Brabazon, Col. . . . .                      | 504                          | Organ guns . . . . .  | 15                        |
| Morse, George W. . . . .                          | 26                           | Orgues des Bombardes . . . . .                                | 15                        |
| Mountings, Aircraft cannon . . . . .              | 579-580                      | Otis Steel Works . . . . .                                    | 60                        |
| Multifiring weapons . . . . .                     | 12-15, 24-25                 |   |                           |
| Muzzle blast . . . . .                            | 160                          | Pacha machine rifle (See Berthier-Pacha machine rifle)        |                           |
| Muzzle brakes . . . . .                           | 581-582                      | Paget and Co. . . . .   | 55                        |
|   |                              | Palmcrantz, Heltge . . . . .                                  | 110, 111                  |
| Nambu, Gen. Kijiro . . . . .                      | 353                          | Parabellum machine gun . . . . .                              | 310-312                   |
| Nambu machine gun . . . . .                       | 353-355                      | (See also Maxim machine gun)                                  |                           |
| Nambu Rifle Manufacturing Co. . . . .             | 354                          | Parachute . . . . .   | 259                       |
| National Arms Co. . . . .                         | 397, 398                     | Paris, Siege of . . . . .                                     | 260                       |
| National Pneumatic Co. . . . .                    | 575, 581                     | Parker, Col. John H. . . . .                                  | 59, 182, 203              |
| Naval Proving Ground, Dahlgren, Va. . . . .       | 119, 336                     | Parkhurst, E. G. . . . .                                      | 79, 191                   |
| Naval Proving Ground, Indian Head, Md. . . . .    | 119, 224                     | Parmalee, P. O. . . . .                                       | 268, 271                  |
| Needle gun . . . . .                              | 65, 66                       | "Pavement buster" . . . . .                                   | 561                       |
| Nelson synchronizing gear . . . . .               | 323, 328                     | Perino, Giuseppe . . . . .                                    | 220, 462                  |
| New England Westinghouse Co. . . . .              | 178, 179, 328                | Perino machine gun . . . . .                                  | 220-223                   |
| Nobel, Alfred . . . . .                           | 610                          | Pershing, Gen. John J. . . . .                                | 182, 292, 315, 333        |
| Norddeutsche Maschinenfabrik G.m.b.H. . . . .     | 479                          | Platex sear cover assembly . . . . .                          | 582                       |
| Nordenfelt, Thorsten . . . . .                    | 110,                         | Podrabsky, Antonin . . . . .                                  | 429                       |
| . . . . .   | 111, 115, 116, 142, 206, 315 | Polsten automatic cannon, 20 mm . . . . .                     | 520-521                   |
| Nordenfelt machine guns . . . . .                 | 110-116, 204-206             | Polybolus . . . . .   | 5                         |
| Nordenfelt Co. . . . .                            | 110, 112, 113, 204           | Pom-pom shell gun . . . . .                                   | 143-144, 315              |
| North, Simon . . . . .                            | 28                           | Poniatowski, Prince Stanislaus . . . . .                      | 562, 570                  |
|   |                              | Poolc Engineering and Machine Co. . . . .                     | 237,                      |
| Odkolek, Adolph von . . . . .                     | 187, 188, 194                | . . . . .   | 526, 529, 531             |
| Odkolek machine gun (See Hotchkiss machine guns)  |                              | "Potato digger" machine gun (See Colt machine gun, Model '95) |                           |
| Oerlikon aircraft cannon, 20 mm:                  |                              | Pratt, Francis A. . . . .                                     | 30, 79, 83, 85, 136       |
| Acceptance by various nations . . . . .           | 516, 517                     | Pratt and Whitney Co. . . . .                                 | 30,                       |
| Comparison with Gazda cannon . . . . .            | 520                          | . . . . .   | 79, 85, 86, 136, 163, 207 |
| Comparison with Polsten cannon . . . . .          | 520                          | Prideaux, William de Courcey . . . . .                        | 304                       |
| Comparison with Scotti cannon . . . . .           | 545                          |   |                           |
| Comparison with T2 cal. .90 cannon . . . . .      | 608                          |   |                           |

- |  | <i>Page</i>                                      |   | <i>Page</i>                            |
|--|--|---|--|
| Prince, Norman   | 508  | Rifling, Progressive  | 29                                     |
| Propeller arc. Firing through  | 301  | Ripley, Ezra  | 26, 28                                 |
| Puckle, James  | 17-19  | Ripley gun  | 26-28, 48                              |
| Puckle revolving firearm   | 17-19  | Robertson machine gun   | 88                                     |
| Puteaux Arsenal  | 194  | Robinson and Cottam   | 45                                     |
| Puteaux aircraft cannon  | 508-511, 593                                     | Rockets in World War I  | 348-349                                |
| Puteaux machine gun  | 194  | Roosevelt, Quentin  | 315, 333                               |
| ( <i>See also</i> Hotchkiss machine gun)   |  | Rossmann, Wolfgang  | 453                                    |
| Radio, First aviation  | 273  | Rounds indicator  | 291                                    |
| Rakula, Theodor  | 551, 553   | Royal Fire Arms Factory   | 472                                    |
| Rasmussen, Julius A.   | 210  | Russell, Charles Edward   | 289                                    |
| Reber, Maj. Samuel   | 271  | Russia—Aeronautical schools                                     | 265                                    |
| Recoilless weapons   | 495-499  | Russo-Japanese War, 1904-05                                     | 145-146                                |
| Reliners, Gun barrel   | 427  | S-2-200 machine gun ( <i>See</i> MG-30 light machine gun)       |  |
| Remington, Elihu   | 28   | S.A.M.M. cradle   | 568, 579                               |
| Remington Arms Co.   | 160, 166, 178, 179, 260                          | S.I.A. aircraft machine gun                                     | 374-378                                |
| Requa battery  | 35-36  | Safat Co. ( <i>See</i> Società Anonima Fabbrica Armi Torino)    |  |
| Research and Development Service   | 587  | Safat machine gun   | 419                                    |
| Revelli, Bethel Abiel  | 251, 252, 358, 360, 371, 505                     | ( <i>See also</i> Fiat machine gun; Breda machine gun)          |  |
| Revelli aircraft cannon, Model 1917  | 505-506  | Saginaw Steering Gear Div., General Motors Corp.                | 339, 487                               |
| Revelli machine guns   | 251-255, 356-363, 416                            | St. Etienne Arsenal   | 194                                    |
| ( <i>See also</i> Fiat machine gun)  |  | St. Etienne machine gun   | 194                                    |
| Revolving firearms   | 16, 19   | ( <i>See also</i> Hotchkiss machine gun)                        |  |
| Revolver, Automatic  | 22   | St. Petersburg Convention                                       | 71, 495, 512                           |
| Rexer machine gun. ( <i>See</i> Madsen automatic machine gun)  |  | Salvator, Grand Duke Karl                                       | 150                                    |
| Reynolds, John A.  | 23   | Santos-Dumont, Alberto  | 260, 265                               |
| Rheinische Metallwaren und Maschinenfabrik A.G.  | 216, 364, 450, 451, 453, 454, 456, 457, 548, 550 | Savage, Arthur  | 281                                    |
| Rheinmetall aircraft cannon, 20 mm   | 550  | Savage, Edmund  | 28                                     |
| Rheinmetall-Borsig A.G.  | 450, 457, 459, 473, 499, 554, 555, 602           | Savage Arms Corp.   | 279, 288, 291, 292, 293, 295, 298, 338 |
| Rheinmetall-Borsig cannon  | 570, 572   | Scanlon, Bob  | 508                                    |
| ( <i>See also</i> Ehrhardt aircraft cannon, 20 mm; Flak 18 antiaircraft cannon, 37 mm; Flak 30 antiaircraft and tank gun; MK-101 aircraft cannon, 30 mm; MK-103 aircraft cannon, 30 mm; MK-108 aircraft cannon, 30 mm) |  | Scarff, Frederick William                                       | 301                                    |
| Rheinmetall-Borsig machine guns ( <i>See</i> MG-15 aircraft machine gun; MG-17 aircraft machine gun; MG-131 aircraft machine gun; MG-30 light machine gun; Soltuthurn machine gun, Model 1929)                         |  | Scarff-Dibovsky synchronizing gear                              | 301                                    |
| Ribauld  | 12   | Schmeisser, Louis   | 216, 364, 453, 550                     |
| Ribeyrolle, M.   | 242  | Schneider, Franz  | 312, 313                               |
| Rider, John  | 28   | Schneider synchronizer  | 312-314                                |
|  |  | Schoeffel, (Adm.) Malcolm F.                                    | 337, 338                               |
|  |  | Schouboe, Lt. Theodor   | 210                                    |
|  |  | Schouboe machine gun ( <i>See</i> Madsen automatic machine gun) |  |
|  |  | Schwartz, Barthold  | 11, 12                                 |
|  |  | Schwarzlose, Andreas W.   | 228                                    |
|  |  | Schwarzlose machine gun   | 228-231                                |
|  |  | Schweizerische Industrie A.G.                                   | 282, 461                               |
|  |  | Scorpion catapult   | 5                                      |

	<i>Page</i>		<i>Page</i>
Scott, Lt. R. E. ....	273	Solothurn A.G. ( <i>See</i> Waffenfabrik Solothurn A.G.)	
Scotti, Alfredo ...	461, 473, 545, 563, 564, 570	Solothurn aircraft cannon, 20 mm .	551-552, 570
Scotti aircraft cannon, 20 mm	545-547, 563-564	Solothurn machine gun, Model 1929 ..	451-453
Scotti machine gun .....	461-463	Soyer, Abraham .....	17
Scotti-Zurich Co. ( <i>See</i> Brevetti-Scotti S.A.)		Spad airplane .....	346
Seebach Maschinenbau A.G. ....	514	Spencer, Christopher .....	28, 30
Selfridge, Lt. Thomas E. ....	264, 265, 266	Springfield Armory .....	60, 168, 192, 256, 316, 328, 332, 337, 381, 488
Semag cannon, 20 mm .....	514-515	Springs, Driving .....	406
Semag Co. ( <i>See</i> Seebach Maschinenbau A.G.)		SS machine gun ( <i>See</i> T.u.F. machine gun)	
Seng Co. ....	580	Stampede cannon .....	11
Seven Pines, Battle of .....	42	Standardization of cartridges and small arms .....	167
SG-113A (Recoilless cannon) .....	499	Stange, Louis ..	453, 455, 457, 458, 459, 473, 477
SG-116 (Recoilless cannon) .....	499	Stanley, Sir Henry .....	136
Shackleton, W. S. ....	593	Starr, Eben .....	28
Sharps, Christian .....	25	Steam guns .....	24
Shaw, Joshua E. ....	21	Stecke, Edward .....	484
Shelldrake Arms Co. ....	63	Stevens Co. ....	160
Sherman, (Adm.) Forrest P. ....	336, 337	Steyr Arms Factory .....	228, 453
Shoulder weapons, Repeating .....	28	Steyr-Daimler-Puch A.G. ....	478, 487
Siegen-Solingen-Gusstahl A.V. ....	316	Stone, Henry .....	30
Simson and Co. ....	368	Stone, Lt. Cmdr. ....	293, 294
Sistar Co. ....	465	Strange, L. A. ....	282
Sistar machine gun .....	465-468	Suhl Gun Works .....	487
Skoda machine gun .....	150-155	Suterrc, M. ....	242
Skoda Werke A.G. ....	151, 429, 432	Swebilius, Carl G. ....	320, 321, 563, 564
Sling .....	4	Swebilius locking system .....	563
Slow match .....	15	Sweet, Lt. George C. ....	267
Smith and Wesson, Inc. ....	26	Swiss Industrial Society ( <i>See</i> Schweizerische Industrie A.G.)	
Smokeless powder .....	141	Synchronizers .....	301-304, 312-314, 321
Snaphance .....	16	Szakats, Gabriel .....	523
Società Anonima Fabbrica Armi Torino (Safat) .....	358, 419, 423	Szakats aircraft cannon, 20 mm .....	523-525
Società Italiana Ansaldo .....	374, 461	T.u.F. machine gun .....	315-317
Società Italiana Ansaldo machine gun ( <i>See</i> S.I.A. machine gun)		( <i>See also</i> Maxim machine gun)	
Società Italiana Ernesto Breda .....	416, 419, 423, 601	T1 aircraft cannon, caliber .90 .....	607-608
Société Aeronautique Lorraine .....	517	T2 aircraft cannon, caliber .90 .....	608-609
Société Anonyme des Anciens Etablissements Hotchkiss et Cie. ....	71, 76, 77, 187, 188, 190, 191, 195, 200, 202	T3 aircraft cannon, caliber .90 .....	609
( <i>See also</i> Hotchkiss Ordnance Co.)		T26 aircraft cannon, 20 mm .....	585
Société d'Applications des Machines Motrices .....	568	T27 aircraft cannon, 20 mm .....	586
Société Francaise Hispano-Suiza S. A. ...	562, 563, 565, 566, 568, 570, 571, 574, 575	T28 aircraft cannon, 20 mm .....	586
Sokolov mounting .....	146	T29 aircraft cannon, 20 mm .....	586
Solenoids .....	582	T31 aircraft cannon, 20 mm .....	586, 587
		T32 aircraft cannon, 20 mm .....	589
		T33 aircraft cannon, 20 mm .....	589
		T4 feed mechanism .....	587
		T14 feed mechanism, 20 mm .....	587

	<i>Page</i>		<i>Page</i>
<i>Tank Buchse</i> cannon .....	554	U. S. Army. Ordnance Department (continued):	
<i>Tank und Flieger</i> machine gun ( <i>See</i> T.u.F. machine gun)		Industrial Division .....	334
Tanks, Introduction of .....	315	Lack of funds for cal. .50 development	335
Taylor, James P. ....	117, 118	Modifications on Hispano-Suiza cannon	586
Taylor machine gun .....	117-118	Modifications on Lewis machine gun	291, 292
Tempini-Brescia Co. ....	393	Negotiations with Browning for cal. .50 gun	182
Ten Bosch, A. ....	317	Obtains Becker gun .....	514
Thompson, M. H. ....	397	Offered T.u.F. machine gun .....	317
Torpedoes, Aerial .....	272	Orders Browning cal. .50 machine gun ..	183
Tracer ammunition .....	305, 330	Orders rechambering of cal. .30 to 11 mm	182
Trebuchet .....	6	Procures Hispano-Suiza cannon for study	571
Tredegor Iron Works .....	43	Production of T31 cannon .....	586
Union Metallic Cartridge Co. ....	80	Program for cal. .90 cannon .....	607
United Shoe Machinery Co. ....	511	Progress on Browning guns .....	328
United States Cartridge Co. ....	96	Report on Baldwin cannon .....	530
United States Electric Lighting Co. ....	127	Report on Colt '95 machine gun ...	168-169
United States Machine Gun Co. ....	247	Report on Lewis machine gun ....	285-289
U. S. Army:		Seeks information on Hispano-Suiza cannon	570
Aeronautical Corps .....	260	Tests on:	
Aeronautics Division .....	267, 271	Baldwin cannon .....	526-527
U. S. Army Air Force:		Berthier machine gun .....	247
Demand for closed bolt on Hispano-Suiza cannon	585	British and American Hispano-Suiza cannon	578
Development of T14 feed .....	587	De Knight machine gun .....	208
Interest in solenoid for M2 cannon ...	582	Gardner machine gun .....	86
Production of Hispano-Suiza initiated ..	575	Gast machine gun .....	381
Report on cal. .50 machine gun .....	337	Gatling machine gun .....	50, 54
Selection of feed for M2 cannon .....	581	Hotchkiss machine gun .....	192-194
Request for T31 cannon .....	586	Johnson light machine gun .....	480
Use of Browning cannon .....	532	McClellan machine gun ....	232, 235-236
U. S. Army. Ordnance Department:		Madsen machine gun .....	210
Adoption of Gatling machine gun .....	54	Putcaux cannon .....	511
Adoption of Maxim-Vickers machine gun	148	Revelli machine gun .....	252
Adoption of Oerlikon cannon .....	516	Skoda machine gun .....	151, 153-154
Agreement on royalties for Browning weapons	179-180	Vandenberg machine gun .....	45
Aircraft Armanent Board report ..	325-326, 328-332	U. S. Army. Signal Corps .....	272, 321
Aircraft Armanent Division .....	527	U. S. Marine Corps ..	294, 295, 338, 480, 481
Attempt to copy MG-42 .....	487	U. S. Military Academy:	
Board of Ordnance and Fortification ..	261, 278, 290	Ordnance Laboratory .....	46
Conference on Marlin machine gun ...	321	West Point Museum .....	43, 200
Consultation with Browning on new cannon	531	U. S. Naval Academy .....	497
Contract to manufacture Hispano-Suiza cannon	574	U. S. Navy:	
Controversy over Lewis royalties ...	297-299	Aid to inventors of automatic weapons ..	119
		Bureau of Aeronautics ..	572-574, 576, 588
		U. S. Navy. Bureau of Ordnance:	
		Allots funds for aircraft cannon development	572



- |   | <i>Page</i>        |  | <i>Page</i>  |
|---|--------------------|--|--|
| U. S. Navy. Bureau of Ordnance (continued):                 |                    | Vickers G.O. machine gun ( <i>See</i> Vickers-Berthier aircraft machine gun) |  |
| Approves Berthier machine gun . . . . .                     | 247                | Vickers, Ltd. . . . .  | 287, 302, 307, 441, 442                              |
| Aviation Ordnance Section . . . . .                         | 293, 294           | Vickers machine gun . . . . .  | 148  |
| Development of T14 feed . . . . .                           | 587                | ( <i>See also</i> Maxim machine gun; Vickers-Maxim machine gun)              |  |
| Financial cooperation on cal. .50 machine gun . . . . .     | 337                | Vickers-Maxim machine gun . . . . .  | 144-149, 301   |
| Improvements on Hispano-Suiza cannon . . . . .              | 582, 586, 587      | Vickers Ordnance Co. . . . .   | 500  |
| Interest in machine gun development . . . . .               | 294                | Vickers rifle-caliber gun . . . . .  | 287  |
| Main user of Hispano-Suiza cannon . . . . .                 | 588                | Vickers Sons & Maxim, Ltd. . . . .   | 144, 145   |
| Order for T31 cannon . . . . .                              | 586                | Vickers trigger actuator . . . . .   | 301  |
| Orders Hispano-Suiza cannon from Bendix . . . . .           | 576                | Vieille, Paul . . . . .  | 141  |
| Report on cal. .50 machine gun . . . . .                    | 338                | Villar Perosa aircraft machine gun . . . . .                                 | 371-373  |
| Report on Hispano-Suiza cannon after World War II . . . . . | 589-590            | Vinci, Leonardo da . . . . .   | 15, 259  |
| Report on machine guns, 1896 . . . . .                      | 163-165            | Volcanic bullet . . . . .  | 26   |
| Studies performance of European cannon . . . . .            | 570                | Voller, Karl . . . . .   | 453  |
| Tests:  |                    | Volley-fire weapons . . . . .  | 16   |
| Baldwin cannon . . . . .                                    | 527                | Vorwerk and Co. . . . .  | 380, 381   |
| Carr machine gun . . . . .                                  | 224-226            | Waffenfabrik Mauser A.G. . . . .   | 472, 478, 479, 487, 555, 602, 603, 604, 605          |
| Colt Model '95 machine gun . . . . .                        | 163                | Waffenfabrik Solothurn A.G. . . . .  | 450, 451, 453, 550, 555                              |
| Davis nonrecoiling cannon . . . . .                         | 498                | Waffenwerke Brunn A.G. . . . .   | 440, 478, 479  |
| Gardner machine gun . . . . .                               | 79, 83             | Wagner, I. C. . . . .  | 459, 479   |
| Gatling machine gun . . . . .                               | 55, 57             | Walker, Otto . . . . .   | 427  |
| Hispano-Suiza cannon . . . . .                              | 575                | Washington, D. C., Navy Yard . . . . .                                       | 51, 79, 107, 270                                     |
| Hotchkiss machine gun . . . . .                             | 190                | Water jackets . . . . .  | 23   |
| Lowell machine gun . . . . .                                | 89, 91-98          | Watervliet Arsenal . . . . .   | 575, 580, 586  |
| McClellan machine gun . . . . .                             | 237                | Werkzeug Maschinenfabrik Oerlikon . . . . .                                  | 461, 515, 517, 563                                   |
| Use of Lewis gun in World War I . . . . .                   | 293-295            | Wesson, Maj. Gen. C. M. . . . .  | 575  |
| Use of AN-M2 cannon in World War II . . . . .               | 588                | Wesson brothers . . . . .  | 28   |
| U. S. Navy:   |                    | West Point Museum ( <i>See</i> U. S. Military Academy)                       |  |
| First aviation radio . . . . .                              | 273                | Westinghouse Co. ( <i>See</i> New England Westinghouse Co.)                  |  |
| First naval aircraft . . . . .                              | 269-270            | Wheel-lock ignition . . . . .  | 16   |
| Naval Acceptance Board . . . . .                            | 119                | Wheeler, Gen. Joseph . . . . .   | 232  |
| Use of repeating cannon, War of 1812 . . . . .              | 22                 | Whitney, Amos . . . . .  | 83, 84, 85   |
| U. S. Ordnance Committee . . . . .                          | 582, 583, 584, 586 | Whitney, Eli, Jr. . . . .  | 23   |
| Valtion Kivääritehdas . . . . .                             | 446                | Whitney, Eli, Sr. . . . .  | 21, 30   |
| Vandenberg, Gen. O. . . . .                                 | 43, 44, 45         | Wilder, Elihu . . . . .  | 100, 102, 103  |
| Vandenberg volley gun . . . . .                             | 43-46              | Wilder machine gun . . . . .   | 100-103  |
| Veeder Manufacturing Co. . . . .                            | 291                | Williams, D. R. . . . .  | 42   |
| Vickers, Albert . . . . .                                   | 137                | Williams machine gun . . . . .   | 42-43  |
| Vickers aircraft cannon, 37 mm . . . . .                    | 502, 505           | Winchester, Oliver . . . . .   | 28   |
| Vickers aircraft machine gun . . . . .                      | 301-308            | Winchester Repeating Arms Co. . . . .  | 26, 107, 129, 157, 158, 160, 181, 182, 183, 184, 186 |
| Vickers-Armstrong automatic cannon, 40 mm . . . . .         | 502-504            | Winchester repeating rifle, Model '86 . . . . .                              | 158-159  |
| Vickers-Armstrong Co. . . . .                               | 502, 593           |  |  |
| Vickers-Berthier aircraft machine gun . . . . .             | 441-445            |  |  |

	<i>Page</i>		<i>Page</i>
Wood, Gen. Leonard .....	278, 289	ZB machine guns (continued):	
Wright, Orville .....	262, 263, 264, 265	Model 1934 .....	436
Wright, Wilbur .....	262, 263, 264, 267, 275	ZB-50 .....	434-436
Wright brothers aircraft .....	262-264	ZB-53, Model 1937 .....	436
ZB machine guns:		ZB-60, Model 1938 .....	439
Japanese models .....	433-434	Zeppelin, Count Ferdinand von .....	260, 295
Model 1926 .....	429-432	Zeppelins .....	295-297, 310
		( <i>See also</i> Dirigibles)	