



# *Blasters' Handbook*

DESCRIBING THE  
PRACTICAL METHODS OF USING  
EXPLOSIVES FOR VARIOUS  
PURPOSES

Compiled under the Direction of  
**ARTHUR LA MOTTE**  
*Manager of the Technical Section  
of the du Pont Company*

E. I. DU PONT DE NEMOURS & COMPANY  
Incorporated  
EXPLOSIVES DEPARTMENT  
WILMINGTON                      DELAWARE

②  
TN 279

D'15

11200



② 13079

COPYRIGHT 1922

E. I. DU PONT DE NEMOURS & COMPANY

INCORPORATED

WILMINGTON, DELAWARE

NOTE: This book is printed with inks made  
from du Pont pigments.

A1307\* Nov. '22



## Explosives Service

For more than 120 years it has been the constant aim of the du Pont Company to deliver explosives where they are needed—**when** they are needed. Today this aim has been achieved by a system of mills and magazines, strategically located near practically every great industrial district.

Prompt delivery is but one factor of du Pont Service. We aim to see that our customers use the kind of explosives that will give the best results for their particular work at the least expense—and that they are handled, stored and used most efficiently.

In short, du Pont Service is the result of a sincere effort on the part of the du Pont Company to meet and follow the demand, and to pass on to the users of its products, in a practical way, the results of its 120 years of experience and research in the manufacture and use of explosives.

When you buy from du Pont, you buy more than explosives, you buy du Pont Service.





# FOREWORD

**EXPLOSIVES** are each year becoming more and more a necessity for a number of classes of work. They are necessary for mining all our metals, for quarrying our stone, for improving our means of travel and for developing farm lands. The alarm clock that announces getting-up time is made of metal blasted out by explosives. The stove on which the breakfast is cooked is made of iron mined with explosives. The coal with which the stove is heated was also mined with explosives. The knives, forks and spoons, with which the meal is served, at one time met with an explosive experience. The paving on the street or road is also the result of blasts, for the stone, concrete or shale of which they are made was blasted from some place in the earth. Railroads are built, ship channels opened, fields cleared and drained, and soils tilled by explosives.

To supply handy information for the various users of explosives is the purpose of this book. It gives information on a variety of uses for explosives, but does not go into exhaustive detail in many cases. For further information references are made to:

**HIGH EXPLOSIVES**, Sections 1 and 2, which give detailed information on high and low explosives.

**BLASTING ACCESSORIES**, which covers fully the subject of blasting accessories and their uses.

**BLASTING POWDER**, describing the uses of blasting powder.

**EXPLOSIVES FOR QUARRYING**, relating to the selection and use of explosives in quarrying.

**ROAD BUILDING AND MAINTENANCE**, which is a treatise on road building.

**FARMERS' HANDBOOK OF EXPLOSIVES**, which deals with a variety of uses, especially with drainage and land clearing.

**DITCHING WITH DYNAMITE**, which explains the methods of ditching and gives many concrete examples.

Any of these can be had free of cost by addressing the Advertising Department, E. I. du Pont de Nemours & Co., Inc., Wilmington, Delaware.

This company has in its employ a large number of experts in the use of explosives, who will gladly give those interested the benefit of their suggestions. Those writing for such help should give as much detailed information as possible on the work they have in mind.

EXACT SIZE OF GRAINS OF "A" AND "B" DU PONT BLASTING POWDERS



DU PONT "A" BLASTING



DU PONT "A" BLASTING



DU PONT "A" BLASTING



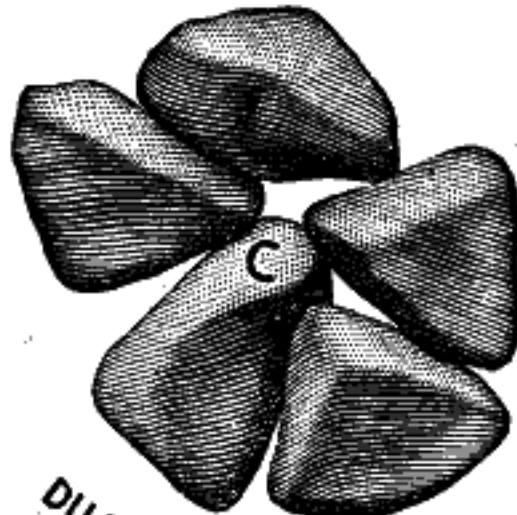
DU PONT "A" BLASTING



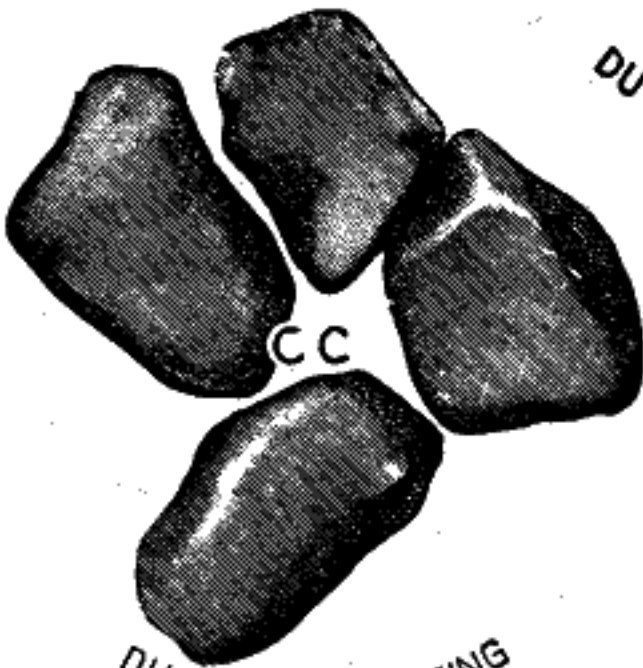
DU PONT "A" BLASTING



DU PONT "A" BLASTING



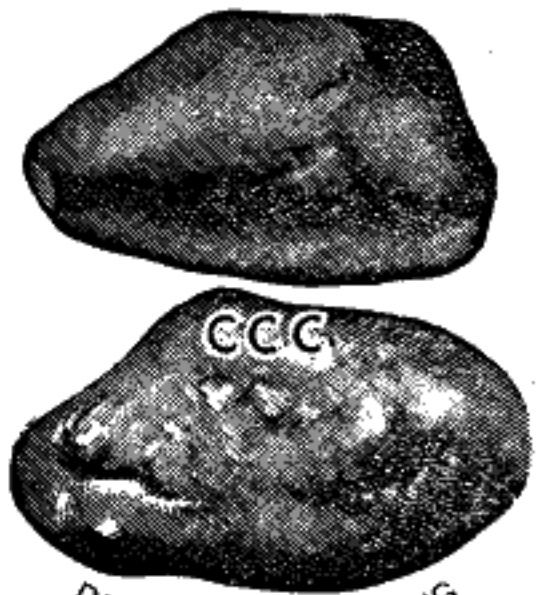
DU PONT "B" BLASTING



DU PONT "B" BLASTING



DU PONT "B" BLASTING



DU PONT "B" BLASTING



DU PONT "B" BLASTING



DU PONT "B" BLASTING



DU PONT "B" BLASTING

Action of Explosives. Blasting Powder

## ACTION OF EXPLOSIVES

**C**OMMERCIAL explosives are solids or liquids that can be instantaneously converted by friction, heat, shock, sparks or other means into large volumes of gas. While the conversion of explosives into gas is much quicker than converting water into steam, it is essentially similar. There is no magic about explosives. When fired or exploded, they simply change into another form, largely gaseous, having many times greater volume. This increased volume exerts both a blow and pressure on that which tries to confine the action. It is this action that is effective in blasts. The pressure acts equally in all directions, but the gas tends to escape through the path of least resistance, or the easiest way out. All explosives, in this respect, act in exactly the same manner, and, no matter what explosive is used, loading and tamping must be performed very carefully.

For performing his work the blaster has to consider the choice of explosives; supplies for firing the explosives used; methods of preparing bore holes; and methods of loading and firing.

In choosing explosives the selection may be made from:

(1) Blasting powder and (2) high explosives, which include all of the dynamites, gelatins, and permissible explosives.

## BLASTING POWDER

The oldest and most widely known explosive is blasting powder, which is a black material, prepared in grains closely resembling fine lumps of high-grade coal. It is manufactured in two grades, "A" and "B." The "A" powder contains saltpeter or potassium nitrate, and is slightly more water resistant, stronger and quicker than "B" powder, which contains nitrate of soda instead of the saltpeter. In both powders, the other ingredients are sulphur and charcoal. The difference in composition makes "A" powder much more expensive than "B" powder. For this reason "A" powder is but little used, except in certain classes of difficult blasting, as in quarrying fine dimension stone. "B" powder is extensively used in quarrying stone, stripping, road and railroad building, clay mining, coal mining and general excavating.

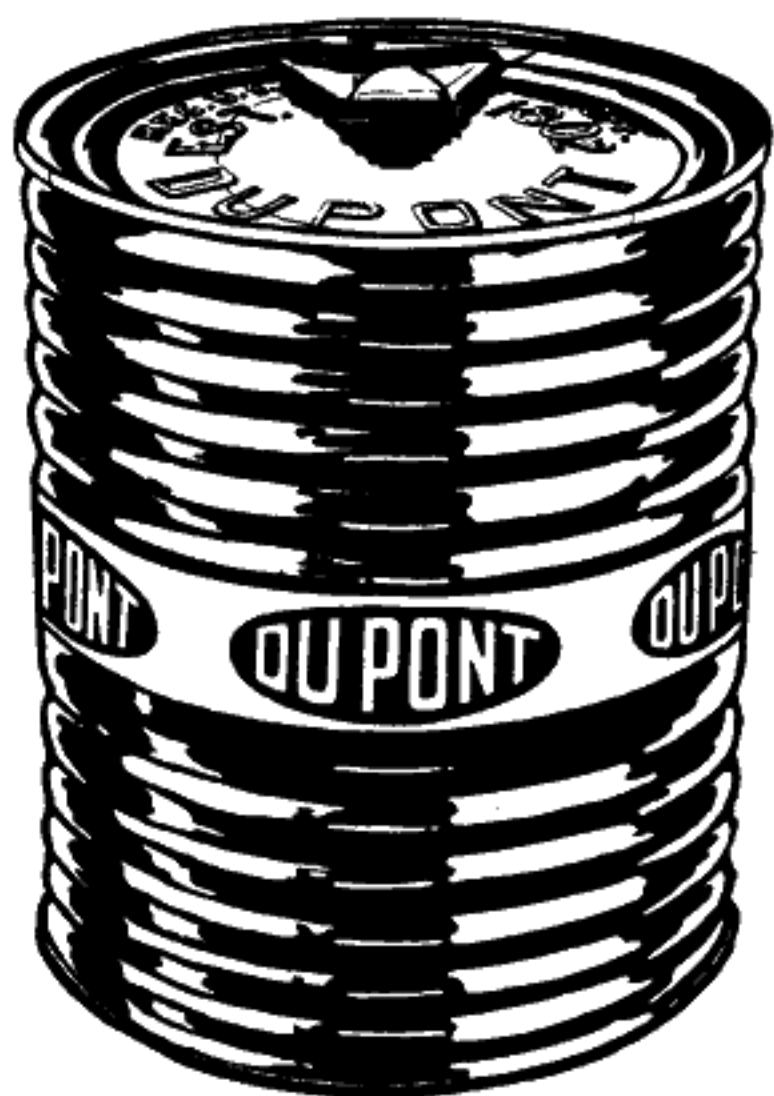


Fig. 1.—25-pound keg of du Pont Blasting Powder.

It is the slowest acting of all of the explosives. It has a heaving, not a shattering, action, and hence tends to break down coal or



**Blasting Powder—Firing. High Explosives—Strength**

stone in large fragments. Blasting powder is not water resisting and cannot be used in moist or wet work. It must be carefully loaded and well tamped, as the slightest avenue of escape for the gases will seriously diminish the effects of the blast.

Both "A" and "B" powders are manufactured in grains of different sizes which are shown in the illustrations on page 6. The finer grained powders are quicker than the coarse grained ones. There is another granulation of "B" blasting powder called R. R., or "Railroad," which is a mixture of all sizes from FF to FFFF. It is an excellent explosive for many classes of blasting, as it packs well in bore holes and explodes with great uniformity. A bore hole of a given size will hold more pounds of R. R. than of grains of any other size. All blasting powder is packed in metal kegs, each holding twenty-five pounds net. For heavy blasting where more than one keg is used to a charge, the R. R. granulation of blasting powder will be found to be the most effective. The density of the R. R. granulation is about 10% greater than that of any single granulation and this means 10% more explosive in a given space. Where heavy charges of blasting powder are shot by means of dynamite primers any variation in action of the different sized grains is practically neutralized, the density of loading being the principal effective factor.

More complete information is contained in **BLASTING POWDER** booklet, which may be had on application.

**Firing Charges of Blasting Powder.**—Both grades of blasting powder are fired by means of sparks or flame. A charge may be ignited by means of fuse, electric squibs or miners' squibs, or, in large blasts, by primers of high explosives. These are all described in another chapter.

## HIGH EXPLOSIVES

High explosives include all of the dynamites, straight, extra, gelatin and permissible explosives, and the "low" powders. In selecting high explosives, especially for under-ground work, many factors must be taken into consideration. Some of the principal characteristics are: strength, velocity or smashing effect, water resistance, density, fumes, temperature of freezing, and length and duration of flame.

**Strength.**—By this term is meant the power or force developed by the explosive. The straight dynamites are rated on the percentage, by weight, of nitroglycerin contained in them. Thus a 40% strength straight dynamite contains actually 40% of nitroglycerin. The strength developed by this type of explosive serves as a basis for the grading of all other dynamites. Thus the per cent. strength grading of any other kind of dynamite means that it will release as much force as an equivalent grade of the straight dynamite weight for weight.

Mention is sometimes made of bulk strength. In this case the reference is to the volume strength of the explosive and the percentage

High Explosives—Relative energy of different strengths

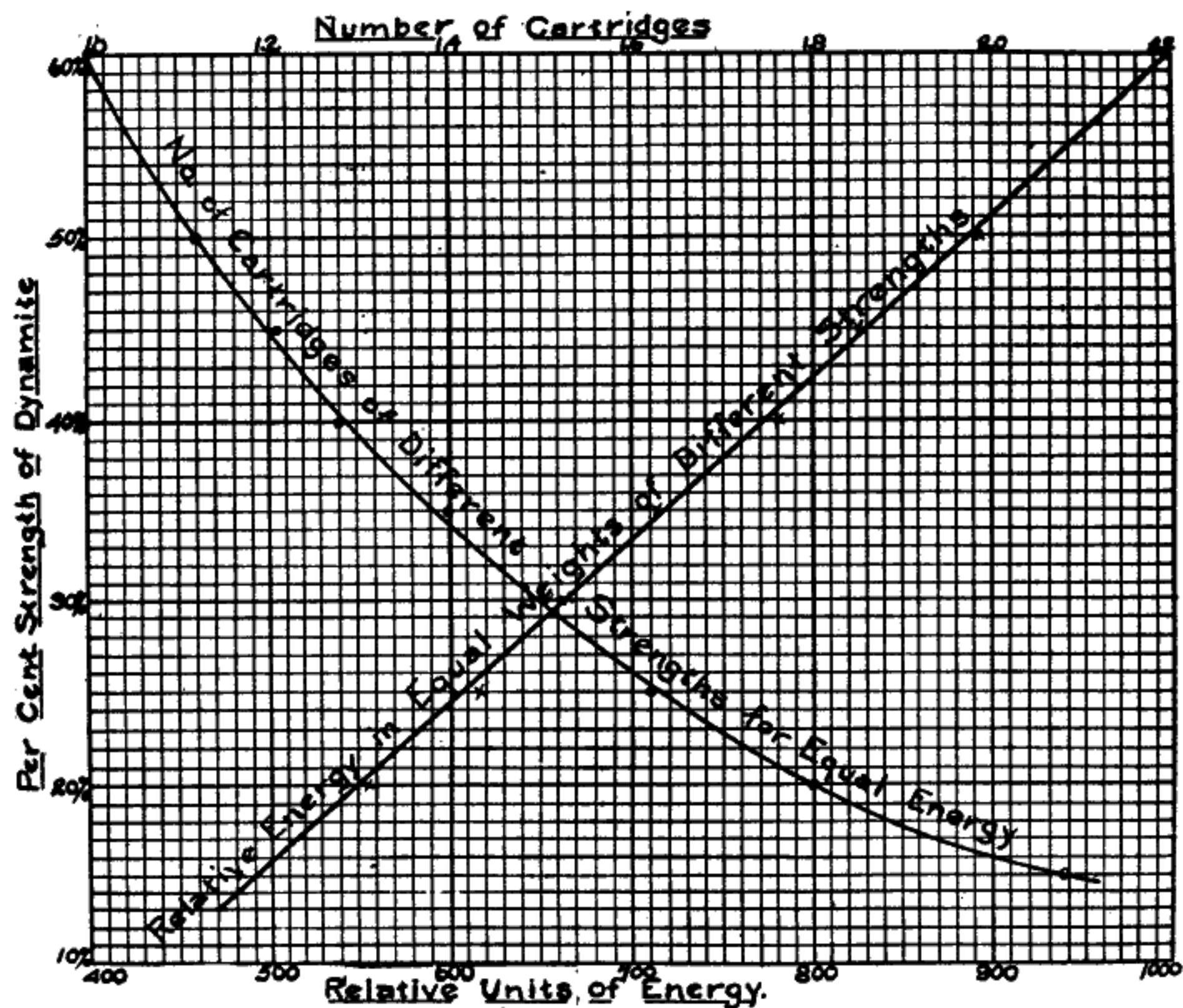


Fig. 2.—Curves showing relative energy contained in different per cent. strengths of dynamite.

figures show a comparison with the volume or bulk of the explosive in question. Some high explosives, such as Duobel, Monobel, Carbonite, Durox, and certain others developed for special classes of work, are not given a percentage marking, but are designated by numbers. The general trend of users of explosives is to select lower strengths and practice more careful loading.

The relative energy contained in the different strengths of dynamite is greatly misunderstood by many users. The prevalent opinion is that the actual energy developed by the different strengths is in direct proportion to the per cent. markings. Thus, it is thought that 40 per cent. dynamite is twice as strong as 20 per cent., and 60 per cent. is three times stronger than the 20 per cent.

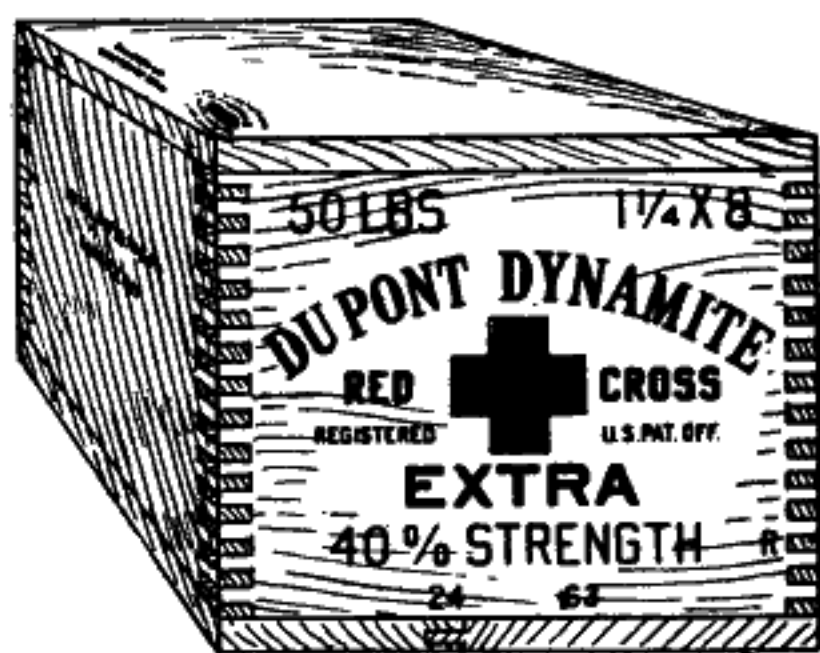


Fig. 3.—A Case of Red Cross Extra Dynamite.

## High Explosives—Relative energy of different strengths

That this, however, is not true has been proven by careful laboratory tests, the results of which are shown graphically on page 9. Horizontally across the bottom of the cross-sectioned area are figures 400, 500, 600—1,000, spaced at equal intervals and representing the relative units of energy. Vertically on the left-hand side are the figures representing the per cent. strength. To find the comparative energy in equal weights of different strengths, for instance, 20 per cent. and 50 per cent., follow the horizontal line marked 20% across until it intersects the diagonal line marked "Relative energy in equal weights of different strengths," then, follow the vertical line from the point of intersection down to the bottom line. Here it falls midway between 500 and 600, or at 550 relative units of energy. Now, follow the line marked 50% across until it meets the same diagonal line; thence follow the vertical line straight to the bottom. It intersects the bottom line at nine-tenths of the distance between 800 and 900, or 890 relative energy units. This shows that instead of 50 per cent. dynamite's being  $2\frac{1}{2}$  times as strong as 20 per cent., as is popularly supposed, it is actually only 890 divided by 550, or approximately 1.62 times as strong.



Fig. 4.—A Cartridge of Red Cross Extra Dynamite.

To find the number of cartridges of different strengths of dynamite which give off an equal amount of energy, refer to the curved line "No. of cartridges of different strengths for equal energy" in the figure on page 9. The figures at the top of the cut represent the number of cartridges, and those at the left-hand side the per cent. strength of dynamite. The line marked 60% intersects the curve at 1 cartridge. Follow the 40% line across to its intersection with the curve; thence follow the vertical line up to the horizontal line marked 60%. It will fall between 1.2 and 1.4 or at 1.28, which indicates the number of cartridges of 40 per cent. to equal 1 cartridge of 60 per cent. If the 20% line is followed across to its intersection with the curve and thence the vertical line to the top, it will be seen that 1.8 cartridges of 20 per cent. are equal to one of 60 per cent.

The requisite amount of dynamite of any strength to equal one cartridge of a given strength is well shown in the table on page 11. Thus, one cartridge of 40 per cent. is equal to .78 cartridge of 60 per cent., or 1.40 cartridges of 20 per cent., and one cartridge of 20 per cent. is equal to .62 cartridge of 50 per cent., or 1.15 cartridges of 15 per cent. In soft material this ratio may be lowered on account of the better work due to greater spreading and heaving effect of lower grade high explosives.



## High Explosives—Relative energy of different strengths; velocity; water resistance

One Cartridge	60%	50%	45%	40%	35%	30%	25%	20%	15%
60% . . . . .	<b>1.00</b>	1.12	1.20	1.28	1.38	1.50	1.63	1.80	2.08
50% . . . . .	0.89	<b>1.00</b>	1.07	1.14	1.23	1.34	1.45	1.60	1.85
45% . . . . .	0.83	0.93	<b>1.00</b>	1.07	1.15	1.25	1.36	1.50	1.73
40% . . . . .	0.78	0.87	0.94	<b>1.00</b>	1.08	1.17	1.27	1.40	1.59
35% . . . . .	0.72	0.81	0.87	0.93	<b>1.00</b>	1.09	1.18	1.30	1.50
30% . . . . .	0.67	0.75	0.80	0.85	0.92	<b>1.00</b>	1.09	1.20	1.38
25% . . . . .	0.61	0.69	0.74	0.78	0.85	0.92	<b>1.00</b>	1.10	1.27
20% . . . . .	0.55	0.62	0.67	0.71	0.77	0.83	0.90	<b>1.00</b>	1.15
15% . . . . .	0.48	0.54	0.58	0.61	0.66	0.72	0.78	0.86	<b>1.00</b>

Table showing number of cartridges of any given strength required to equal one cartridge of any other strength.

While these results were obtained by carefully conducted laboratory tests, they are not exactly accurate, but only an approximation for practical work, since the conditions encountered in practice are quite variable, and there is no way of controlling them as there is in the laboratory. In general, when changing from a higher strength explosive to a lower, it may be found necessary slightly to increase the ratio, as shown in the table of the number of cartridges required, on account of the lower velocity of detonation and the increased bulk of the charge, which may make a difference in the point of location of the charge, and the degree of expansion in the bore hole. However, a little practical experimenting in the direction of pointing and location of the bore holes, coupled with the aid of the table, will enable the blaster to select the lowest strength and lowest cost explosive that will do the work efficiently and economically.

**Velocity.**—The rate of exploding or detonating is spoken of as velocity, or sometimes as quickness. Some high explosives explode much more quickly than others. The higher the velocity, or the greater the speed of an explosive, the more shattering the effect. For large stone or lump coal a slow explosive should be selected. This is quite noticeable in the use of "low" powders and blasting powder for breaking down large dimension stone, and the slow-acting permissible explosives for lump coal; and of quicker-acting explosives for breaking down stone for crushers.

**Water Resistance.**—High explosives differ greatly in their power to resist water. In dry work this is not of importance, but

CHARACTERISTICS OF HIGH EXPLOSIVES

Variety	Name	Strength	Freezing	Water Resistance	Fumes	Velocity
Dynamite Straight	Du Pont	15-60%	Low	2	Poor	Very quick and shattering
Dynamite Extra	Red Cross Du Pont	20-60%	Low	3	Fair	Fairly quick
	Du Pont	20-60%	High	3	Fair	Fairly quick
Gelatin	Du Pont	25-90%	Low	1	Best	Quick (c)
	Repauno	25-90%	Low	1	Best	Quick
	Red Cross	40-90%	Low	1	Best	Quick
	Forcite	25-90%	Low	1	Best	Quick
Permissible explosives (For coal mining only)	*Monobel No. 1 L. F.	.....	Low	4	Good	Permissible explosives vary in speed of detonation from slow to very quick.
	*Monobel No. 2 L. F.	.....	Low	4	Good	
	*Monobel No. 4 L. F.	.....	Low	4	Good	
	*Monobel No. 5 L. F.	.....	Low	4	Good	
	*Monobel No. 6 L. F.	.....	Low	4	Good	
	*Monobel No. 8 L. F.	.....	Low	4	Good	
	*Monobel No. 9 L. F.	.....	Low	4	Good	
	*Duobel L. F.	.....	Low	4	Good	
	*#Duobel No. 2	.....	Low	4	Good	
	†Carbonite No. 1	.....	High	3	Fair	
	†Carbonite No. 2	.....	High	3	Fair	
	†Carbonite No. 3	.....	High	3	Fair	
	†Carbonite No. 4	.....	High	3	Fair	
	†Carbonite No. 5	.....	Low	3	Fair	
†Carbonite No. 6	.....	Low	3	Fair		
†Carbonite No. 7	.....	Low	3	Fair		
Dynamite Low density	#Durox	70% by weight 29% by bulk	Low	4	Good	Moderately quick
Blasting Gelatin	.....	100%	High	1	Good	Very quick and shattering

\*Nitrate of ammonia type. †Nitroglycerin type. (c) Gelatin dynamites are quick only when confined in well-tamped bore holes. #Rated on a comparative basis. Those in Class 1 are highest in water resistance.



**High Explosives—Density; fumes; temperature of freezing**

when much water is encountered a water-resisting explosive is necessary. If the blasts are fired soon after loading, the use of an explosive intermediate as to water resistance is found satisfactory. This is well illustrated in the use of Red Cross Extra where water stands in the holes. Relative water-resisting characteristics are shown on page 12.

**Density.**—Some dynamites are more bulky than others, and naturally a pound of a bulky one will fill up more of a bore hole than will a pound of a dense one. In large holes, such as tunnels, gopher holes, and as a rule, in well-drill holes, this is not so important. In hand-drill or hammer-drill holes, and sometimes in tripod-drill holes, the extremely bulky explosives may be objectionable. The difficulty of getting a sufficient amount of explosives in a bore hole is frequently overcome by springing the bottom of the holes. This is described in another chapter (see page 64). Frequently a bulky explosive is desirable, as it can be distributed along the bore hole to the best advantage, so that its force affects a greater area or distance.

**Fumes.**—When dynamite, or any other explosive, is fired, varying amounts of gas or fumes are given off. For work in the open, the nature of these does not matter, but for underground work an explosive that gives off objectionable or dangerous fumes should not be used. The Monobel and Duobel explosives develop a minimum of objectionable gas, and are therefore highly recommended for coal, clay and salt mines and similar operations. The gelatins and du Pont Straight Dynamite are found best for extremely hard rock. Red Cross Extra proves a highly acceptable explosive in fairly well ventilated mines. Durox is advised for open work, for salt mining, and for other under-ground work where Duobel would give good results but where a permissible is not required.

In all classes of underground work attention should be given to improving the ventilation as much as possible.

Several features influence the amount and quality of fumes given off by the explosion of dynamite. Burning dynamite gives the worst and most poisonous fumes, and incompletely detonated dynamite follows closely. The more complete the detonation, the better the fumes. Complete detonation is obtained by confining the explosive as strongly as possible, eliminating air spaces, tamping strongly with enough material, and using a strong detonator. In tunneling, for instance, with seven-foot bore holes, at least three feet of the hole should be filled with tamping. If the bore hole blows out or does not bring the burden as it should, the natural impulse is to load more explosive in it the next time. What should be done generally is to confine the explosive more strongly.

If better confinement is impossible it is well to use a stronger explosive or to spring the hole so as to get a better explosive effect at the bottom of the hole where it is most needed.

**Temperature of Freezing.**—Some high explosives freeze at comparatively high temperatures. Frozen explosives are dan-

**High Explosives—Permissibles; du Pont R.R.P., F, FF and FFF**

gerous to use, and do not develop their full strength when fired. As the freezing points of dynamites vary, the selection of a low-freezing explosive should be made for cold weather. Carbonite Nos. 1, 2, 3 and 4 freeze at about 45 to 50 degrees F., while the others, such as du Pont Straight, Red Cross Extra, all Monobels and Duobel, Duobel 2, Carbonite Nos. 5, 6 and 7 and Durox are low-freezing explosives. The freezing point is hard to determine, as it is affected by the length of time they are exposed to the cold. The gelatins, except Blasting Gelatin, are low freezing. All of the "low" powders are low freezing. R. R. P. does not require thawing if the frozen lumps are broken down by rubbing them between the hands before loading. Blasting powder is non-freezing. Advice with regard to thawing dynamite will be found on pages 36 to 39.

**Permissible Explosives.** — Permissible explosives are designed primarily and almost exclusively for mining coal in workings where there is inflammable gas or inflammable dust. All explosives when fired give a flash or flame which varies in length, duration and temperature. Black blasting powder gives the largest flame and longest lasting. Dynamites of various kinds give a flame which is not as large and does not last as long as that of blasting powder but is very much hotter. Permissible explosives are especially designed to give the least possible quantity of flame and the flame of the briefest possible duration.

Any explosive, even a permissible, if overloaded in a bore hole and improperly confined under unfavorable conditions, may ignite gas or dust in the mine air, but permissible explosives, when loaded in amounts within what is called the "charge limit," 1½ pounds, when properly thawed and when detonated by a sufficiently strong detonator, preferably an electric detonator, give such a small flame and of such brief duration and low temperature, that there is very little likelihood of ignition of gas or dust taking place.

Permissibles have other advantages besides their safety in a gaseous and dusty atmosphere. They are comparatively safe to handle, insensitive to ordinary shocks of transportation and loading; they are difficult to set on fire and their fumes are not objectionable. Some types of permissibles are noticeably free from obnoxious fumes.

Some of the permissibles may be used in other kinds of work, where a comparatively slow, heaving action is desired, as in soft rock, clay, sand and sandstone, and other material which is not especially hard, tough or brittle, but in such cases Durox is generally better.

**Du Pont R. R. P., F, FF and FFF.**—These low strength, high explosives are intermediate in their action between blasting powder and the dynamites. They are all detonating explosives. There are four grades of strengths: R. R. P., F, FF, and FFF. The R. R. P. grade is granular and is packed in

**High Explosives—Du Pont R.R.P., F, FF and FFF. Handling and Storing Explosives**

12½-pound bags, two or four of which are in turn packed in wooden shipping cases. R. R. P. is well adapted to quarrying, road and railroad building, stripping and many kinds of work where a slow-acting explosive somewhat stronger and more shattering than blasting powder is needed. It has poor water-resisting power, and should not be used in moist or wet work. Small charges of R. R. P. can sometimes be fired by means of No. 6 or No. 8 Blasting Caps or Electric Blasting Caps, but large charges should always be fired by means of primers made of 40% dynamite,

using about 1 pound of dynamite for every 25 pounds of R. R. P. In firing large charges of R. R. P. in hard rock some blasters increase the amount of the dynamite primer to 10% of the load.

The general characteristics of F, FF and FFF low powders are the same as of R. R. P. They differ principally in being stronger and quicker. FFF is the strongest; FF is intermediate and F the weakest. They are all packed in cartridges and are detonated by means of blasting caps or electric blasting caps. They find ready use in practically all conditions named above where R. R. P. has not sufficient strength to do the desired

work, but where a slower acting, more heaving explosive is desired than the higher grade dynamites.

More specific information concerning all of the high explosives named is given in **HIGH EXPLOSIVES CATALOGUE**, Sections 1 and 2.

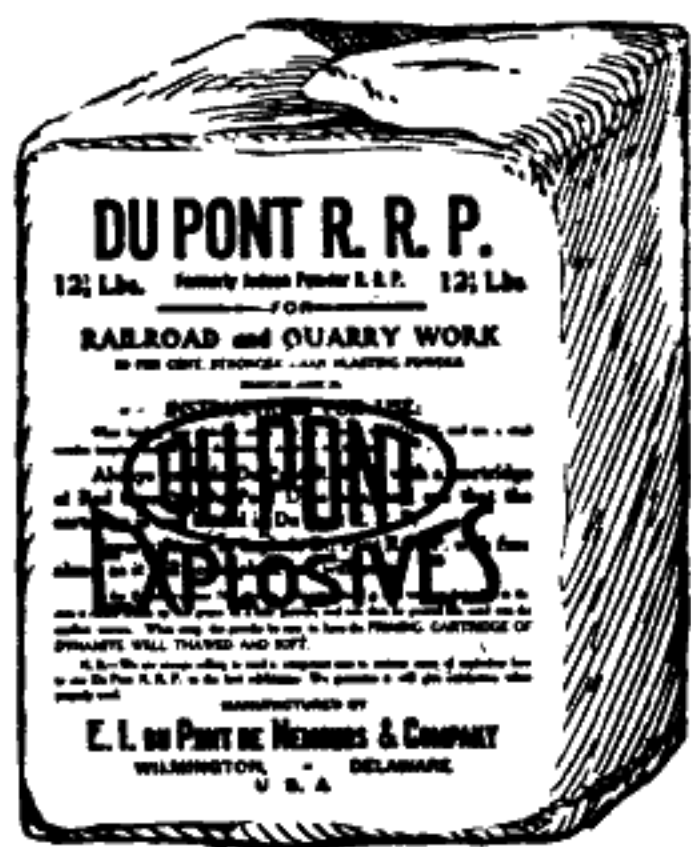


Fig. 5.—Package of R. R. P., a low-strength high explosive.

**HANDLING AND STORING EXPLOSIVES**

While explosives are dangerous when abused, they are safe to handle when treated with due respect for their properties. Carelessness and rough handling are likely to cause explosions and accidents.

Any person having occasion to handle or use explosives should familiarize himself with all state and local regulations and comply with them.

Attention is called to the Federal Act of March 4, 1909, revised March 9, 1921, which provides in Sections 232, 233, 234, 235 and 236 that it is a criminal act:—

To carry or cause to be carried any explosives (other than exceptions named) in a train, boat, trolley or other vehicle carrying passengers for hire:—or

To deliver or cause to be delivered to a common carrier for transportation any explosives under false or deceptive marking or description on the package, invoice or shipping order:—or



## AMERICAN TABLE OF DISTANCES

Blasting and Electric Blasting Caps		Other Explosives		Inhabited Buildings Barricaded*	Public Railway Barricaded*	Public Highway Barricaded*
Number Over	Number Not Over	Pounds Over	Pounds Not Over	(Feet)	(Feet)	(Feet)
1,000	5,000			15	10	5
5,000	10,000			30	20	10
10,000	20,000			60	35	18
20,000	25,000		50	73	45	23
25,000	50,000	50	100	120	70	35
50,000	100,000	100	200	180	110	55
100,000	150,000	200	300	260	155	75
150,000	200,000	300	400	320	190	95
200,000	250,000	400	500	360	215	110
250,000	300,000	500	600	400	240	120
300,000	350,000	600	700	430	260	130
350,000	400,000	700	800	460	275	140
400,000	450,000	800	900	490	295	150
450,000	500,000	900	1,000	510	305	155
500,000	750,000	1,000	1,500	530	320	160
750,000	1,000,000	1,500	2,000	600	360	180
1,000,000	1,500,000	2,000	3,000	650	390	195
1,500,000	2,000,000	3,000	4,000	710	425	210
2,000,000	2,500,000	4,000	5,000	750	450	225
2,500,000	3,000,000	5,000	6,000	780	470	235
3,000,000	3,500,000	6,000	7,000	805	485	245
3,500,000	4,000,000	7,000	8,000	830	500	250
4,000,000	4,500,000	8,000	9,000	850	510	255
4,500,000	5,000,000	9,000	10,000	870	520	260
5,000,000	7,500,000	10,000	15,000	890	535	265
7,500,000	10,000,000	15,000	20,000	975	585	290
10,000,000	12,500,000	20,000	25,000	1,055	635	315
12,500,000	15,000,000	25,000	30,000	1,130	680	340
15,000,000	17,500,000	30,000	35,000	1,205	725	360
17,500,000	20,000,000	35,000	40,000	1,275	765	380
		40,000	45,000	1,340	805	400
		45,000	50,000	1,400	840	420
		50,000	55,000	1,460	875	440
		55,000	60,000	1,515	910	455
		60,000	65,000	1,565	940	470
		65,000	70,000	1,610	970	485
		70,000	75,000	1,655	995	500
		75,000	80,000	1,695	1,020	510
		80,000	85,000	1,730	1,040	520
		85,000	90,000	1,760	1,060	530
		90,000	95,000	1,790	1,075	540
		95,000	100,000	1,815	1,090	545
		100,000	125,000	1,835	1,100	550
		125,000	150,000	1,900	1,140	570
		150,000	175,000	1,965	1,180	590
		175,000	200,000	2,030	1,220	610
		200,000	225,000	2,095	1,260	630
		225,000	250,000	2,155	1,295	650
		250,000	275,000	2,215	1,330	670
		275,000	300,000	2,275	1,365	690
		300,000	325,000	2,335	1,400	705
		325,000	350,000	2,390	1,435	720
		350,000	375,000	2,445	1,470	735
		375,000	400,000	2,500	1,500	750
		400,000	425,000	2,555	1,530	765
		425,000	450,000	2,605	1,560	780
		450,000	475,000	2,655	1,590	795
		475,000	500,000	2,705	1,620	810

\*Barricaded, as here used, signifies that the building containing explosives is screened from other buildings, railways, or from highways by either natural or artificial barriers. Where such barriers do not exist, the distances should be doubled.

**Handling and Storing Explosives—Magazine locations**

To violate or cause to be violated any regulations of the Interstate Commerce Commission relating to the marking, shipping or handling of explosives.

A violation of any of the provisions of this law is punishable by fine of not more than \$2000 or by imprisonment of not more than eighteen (18) months or both; or if injury or death results from such violation by fine of not more than \$10,000.00, by imprisonment for not more than ten (10) years, or both.

In handling explosives reasonable care should always be taken. Do not let "familiarity breed contempt."

Users of explosives often seriously neglect providing proper and adequate facilities for the storage of explosives, frequently storing them in any old, ramshackle building available, sometimes underground in caves of abandoned mine workings dripping with moisture, or even in the open entirely unprotected from the weather. Such improper storage results in very rapid deterioration, particularly by the absorption of moisture which reduces the explosive power, and can be figured often into a very heavy dollars and cents loss. A little expense for providing proper storage is money well spent.

**Magazine Locations.**—The American Table of Distances is considered a standard on which should be based the location of magazines in relation to surrounding improvements such as dwellings, railroads and highways.

Where there are two or more magazines on the same property the following rule for their separation one from the other should apply:—

Pounds of explosives	Separation of magazines
Over 50	Detached
“ 5000	200 feet
“ 25000	200 feet plus 2-2/3 ft. for each 1000 lbs.

These distances between magazines are not required where the total quantity stored in the several magazines complies with the American Table of Distances as regards proximity to inhabited buildings, railways and highways, except that magazines containing blasting caps or electric blasting caps should not be within less distance than 100 ft. from any other magazine.

A magazine location should be selected with a view to both accessibility and safety. The topography of the country will depend on the region in which the magazine is located, and where the country is flat, greater distances are, of course, necessary. A good location is an isolated ravine where the surrounding hills provide protection and such a location permits the reduction of distances to surrounding improvements. Where possible, damp locations should be avoided. Where not possible to do so, good drainage and proper ventilation should be provided.

Storage of daily requirements of explosives for mining, quarrying or other operations should be carefully considered and maga-

**Handling and Storing Explosives—Magazine construction**

zines should not be located where serious damage from explosion would result to life or property. The quantity of explosives so stored should be kept at a minimum consistent with the operations involved.

As a general proposition, storage within city limits should be avoided. When, however, the city limits include large undeveloped areas, magazines can sometimes be located in compliance with the American Table of Distances, unless prohibited altogether by local ordinance. A majority of cities permit storage of a maximum of 50 or 100 lbs. for current consumption or distribution, such storage being generally under license and under the cognizance of the Police or the Fire Department, and always in proper magazines.

**Magazine Construction.**—Magazines for high explosives should be bullet-proof, fire-proof and weather-proof, and well ventilated. The magazine should be built of a medium soft brick or should be a frame building covered with iron and sand filled. We recommend a medium soft brick instead of a hard or vitrified brick and disapprove of concrete because of the tendency of these latter materials to distribute dangerous missiles in case of accident. The sand-filled magazine is a frame structure sheathed both on the outside and the inside of the studding with the space between filled with dry sand. The outside of the building is then completely covered with iron. The quantity of sand required will depend on the nature of the rifles and ammunition in use in the locality. The thickness of the sand walls should vary from 4 inches where low powered rifles are in use to 11 inches where steel jacketed bullets and Government military rifles are used.

High explosives magazines should be provided with a door of at least three layers of  $\frac{7}{8}$ -inch hard wood covered with a  $\frac{3}{8}$ -inch steel plate. The du Pont standard magazine mortise lock is the best lock we know of for magazines.

Where the roof of a magazine can be readily shot into from surrounding hills, it is good practice to bullet-proof the roof. This can be done very readily by putting in ceiling joists at the plate line as if a second story were to be built, laying on these joists a tongue and groove floor with a 4-inch fence or border around it so as to form a shallow box, and filling this box with 4 inches of dry sand. In warm climates this sand box is not only satisfactory as a protection against rifle bullets but is an aid in keeping the temperature of the magazine uniform.

All high explosives magazines should be carefully ventilated. In the foundation wall screened openings should be provided under the floor but far enough above the ground line to prevent water from running into the openings. Complete circulation of air thru the magazine is provided by stopping the magazine floor 2 inches from the wall on all sides, and by stopping the bullet-proof roof 2 inches from the wall on all sides. By placing a lattice lining inside the building a complete circulation of air back of the explosives is provided. There are various methods of ventilating the roof to complete the circulation, but the simplest is by the use of



**Handling and Storing Explosives—Magazine construction; magazine operations**

standard globe or star ventilators, or their equivalent, which can be purchased from any hardware store.

Magazines for blasting powder or sporting powders should be fire-proof and weather-proof. Tests have indicated that ventilation is not necessary in such magazines and that its elimination is a benefit in preventing sweating of the metal kegs. If ventilator openings in the foundations are needed in order to protect the floor against dry rot, the floor should be laid close against the walls so as to eliminate the ventilation within the building. Blasting powder magazines are generally frame buildings covered on the outside with metal. The doors need be only slightly heavier than the walls but should be well provided with locks.

Blasting powder may be stored in a high explosives magazine if only one magazine is needed and such combined storage is of definite advantage.

Blasting accessories magazines should be fire-proof and weather-proof, the usual construction being frame covered with iron, similar to blasting powder magazines. The blasting accessories magazines, however, should be ventilated. Where large valuable stocks of blasting accessories are carried or where local conditions offer an unusual risk of the magazine's being shot into, it is well to build a bullet-proof magazine for caps and electric blasting caps, of similar construction to that required for high explosives.

**Never store blasting caps or electric blasting caps in the same magazine with other explosives.**

Magazines known as portable magazines of the knock-down type of construction, sections being of heavy sheet iron, are in considerable use for temporary or small storage or where it is definitely understood that a magazine will be moved from one location to another from time to time. When high explosives are to be stored in such magazines they should be bullet-proofed. This can be done by erecting a single layer of brick inside the magazine or by building an inner wall and sand-filling it.

Complete plans and specifications for any of these magazines can be obtained on request from E. I. du Pont de Nemours & Co., Inc., Wilmington, Delaware, or from any of its branch offices.

**Magazine Operations.**—Only a few of the principal points in connection with proper magazine operations can be given here.

Always ship old stocks first. In receiving new consignments, arrange stocks so that the balance of the old stock will be readily accessible.

Metal tools should not be used in handling explosives or opening cases, and should never be kept in the magazines.

Regulations against matches, fire or lamps and other spark or fire-producing devices should be rigidly enforced.

Cases of high explosives should be stored top side up; in other words, so that the cartridges are lying flat and not standing on end.

Powder kegs may be stored on sides or ends. If stored on ends in a magazine, it is better to put the bungs down, and if stored on

**Handling and Storing Explosives—Transportation; old dynamite**

the sides, to put the seams down, to assist in keeping the material dry. It is well to shake with the hands the kegs of powder every thirty to sixty days to prevent caking.

Do not store miscellaneous material in magazines with explosives. Never store blasting caps or electric blasting caps with other explosives.

Keep the grounds around about the magazine free of brush and dry leaves. Do not open packages of explosives in a magazine or do any reworking of packages in a magazine.

**Transportation.**—Rail transportation is thoroughly regulated by the Interstate Commerce Commission, and these regulations should be familiar to all persons having occasion to make rail shipments.

In handling by truck or wagon, the principal points to be considered are that the body of the vehicle should be clean and that any exposed metal should be covered with boards or canvas or similar material. Where explosives are not transported in a closed body, the stock should be covered by tarpaulin. In hauling through cities, avoid congested streets and unnecessary stops.

Never haul blasting caps or electric blasting caps with other explosives.

**Old Dynamite.**—When properly stored and cared for, dynamite will remain in good condition for years, but it will deteriorate rapidly if improperly treated. Old, deteriorated dynamite becomes very dark brown, sometimes almost black in color, gets very soft and mushy, and the cases are frequently discolored by dark brown stains, due to leaking of the cartridges. When in this condition, the dynamite should be handled very carefully, especially when it shows evidence of being leaky. In some instances, deteriorated dynamite will fail to explode, causing misfires, and in other cases it will burn instead of detonating, giving off poisonous fumes.

Such dynamite should be destroyed by taking it to a safe distance from houses and roads, opening the cases very carefully, taking the cartridges out, slitting them, and spreading them over the ground instead of piling them up. If the dynamite appears to be too wet to burn readily, a little kerosene may be poured over it. A small pile of paper, shavings or other combustible material should be placed close enough to the dynamite so that the flame will burn along the paper and ignite the dynamite. After lighting the paper, one should retire immediately to a safe distance until the dynamite is completely burned. The cases should be piled and burned separately. Not more than one hundred pounds of dynamite should be burned at one time. When more than that amount must be destroyed, a new space should be selected for each lot, for it is not safe to place dynamite on the hot ground of the preceding burning.



Blasting Accessories—Safety fuse; miners' squibs

## BLASTING ACCESSORIES

For firing the different explosives in the great variety of ways in which they are loaded, many different devices known by the general name "blasting accessories" are needed. The selection of the correct accessories is just as essential to the best work as is the selection of the correct explosives.

**Blasting Accessories for Firing Charges of Blasting Powder.—Safety Fuse.**—For firing small charges of blasting powder, one at a time, especially where there is no objection to smoke, safety fuse is satisfactory. The fuse is placed in the bore hole after the charge is loaded, but before the hole is tamped. The fuse should be cut long enough to reach from the charge of powder to at least four inches above the mouth of the bore hole, and must be long enough to allow the blaster to reach a place of safety after the fuse is lighted. When using fuse, it is impossible to fire two or more charges at exactly the same time. It is customary to tie a knot in the end of the fuse to prevent the possibility of the fuse's being pulled out of the charge. Several notches are made in the fuse in the knot cutting the powder train and the knot is placed in the center of the charge.

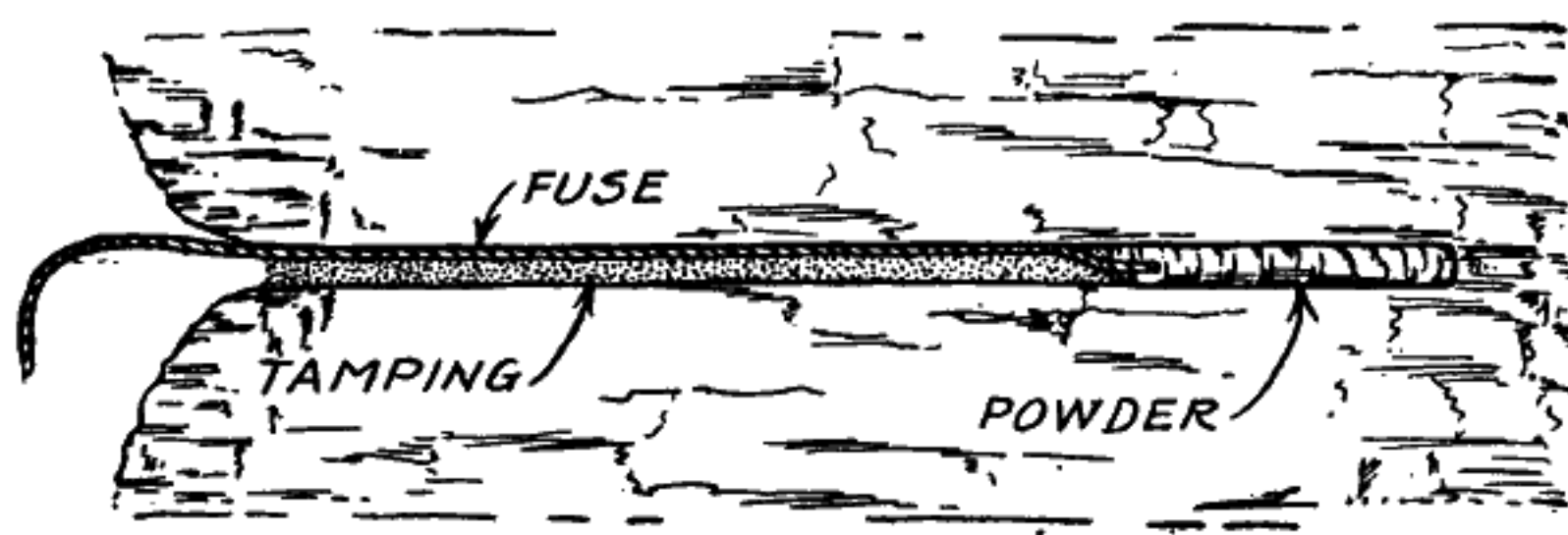


Fig. 6.—Bore hole in coal mine loaded with blasting powder, showing the outside cartridge primed with fuse. The location of the fuse is exactly the same when the powder is loaded loose instead of in a bag or cartridge.

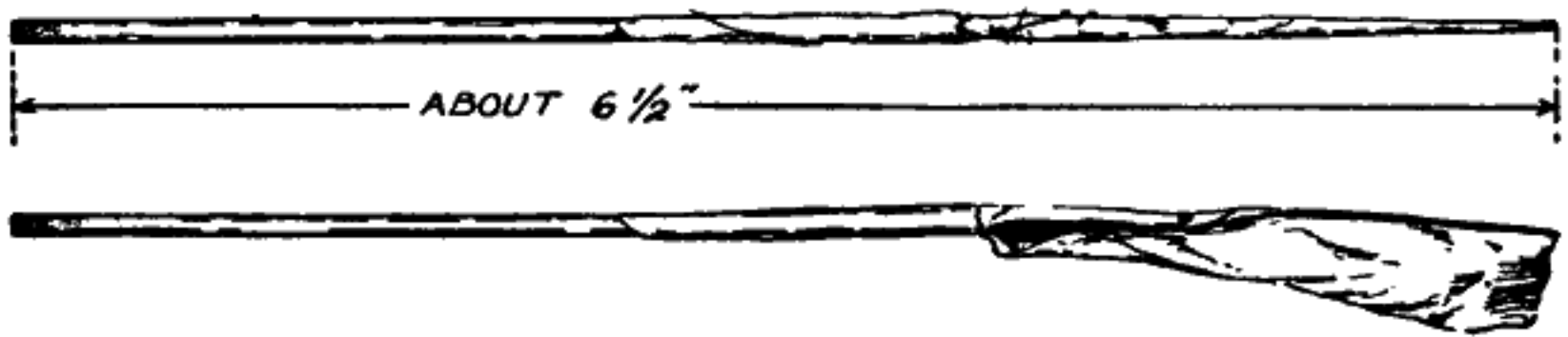
**Miners' Squibs.**—These are still used for firing charges of blasting powder (Fig. 8). They are not so sure or safe as fuse or electric squibs. In use, they require that a small opening be left



Fig. 7.—A bore hole loaded and tamped with miners' needle in place. The needle is withdrawn, and a miners' squib inserted in the opening thus made.

**Blasting Accessories—Miners' squibs; electric squibs**

from the charge all the way through the tamping. When a hole is loaded, a miners' needle, Fig. 7, is placed in the bore hole and the hole tamped. The needle is then withdrawn, the squib placed in the mouth of the opening and lighted. The pressure of the powder burning in the squib forces the squib shell back into the hole where the sparks ignite the charge. The objections are: the considerable amount of smoke given off, the danger of the squib's being stopped in the needle hole, the ineffective tamping due to the needle hole, the large number of blasts that are delayed or that miss, causing serious inconvenience or accidents. Do not use tamping bags or "dummies" for stemming around a needle. The paper may block the needle hole and stop the travel of the squib.



**Fig. 8.—Miners' Squib and Flagged Miners' Squib.**

In order to prevent the closing of the needle hole by particles of stemming material a piece of quarter-inch gas pipe, called a blasting barrel, is sometimes used instead of the miners' needle. One end of this is imbedded in the end of the outside powder cartridge, while the other end extends from the mouth of the bore hole, and the tamping is packed around it just as when the needle is used. The blasting barrel is not withdrawn, however, and the squib shoots back to the powder through it, the blasting barrel being thrown out with the material blasted when the explosion takes place. It is then recovered, and sometimes is used a number of times before it is destroyed. This is a much more certain method than the use of the miners' needle, but is almost, if not quite, as expensive as the use of fuse, its cost depending on the number of shots the blasting barrel will withstand. It is no improvement in the matter of smoke and incomplete tamping, as a hole all the way back to the powder charge is left.

**Electric Squibs.**—The best practice for firing blasting powder is with the use of electric squibs. These are small shells containing an explosive compound that is fired by means of an electric current brought in through wires. The use of these permits the initial ignition of the charge at any point desired; the closing or tamping of the bore hole tightly; the elimination of all excess smoke or fumes; the firing of any number of shots at exactly the same time; the overcoming of the danger of hang-fires, and the elimination of all waiting. A blasting powder charge when properly loaded is fired immediately when the electric current is applied. The use of electric squibs goes far in introducing safe blasting in mines where blasting powder is used.

**Blasting Accessories—Electric squibs**

When the electric squib is used to explode blasting powder charges in cartridges, the cork is removed from the electric squib, the paper shell already referred to is filled half full of powder, the electric squib put in, and then the remainder of the shell is filled



Fig. 9.—Electric Squib.



Fig. 10.—Tamping bag or cartridge filled with blasting powder and primed with an Electric Squib.

with powder above the electric squib and about the wires. Enough empty shell is left at the top to tie securely about the wires. The cartridge is primed in this manner, and if the charge is to consist of more than one cartridge, this one, known as the primer, is placed at or near the center of the charge. Electric squibs have a conical inside bore which allows an ordinary blasting cap to be fixed permanently inside and used as a substitute for an electric blasting cap. This should be used only in case of emergency when electric blasting caps cannot be obtained. A special electric squib is required for the two largest granulations of blasting powder.

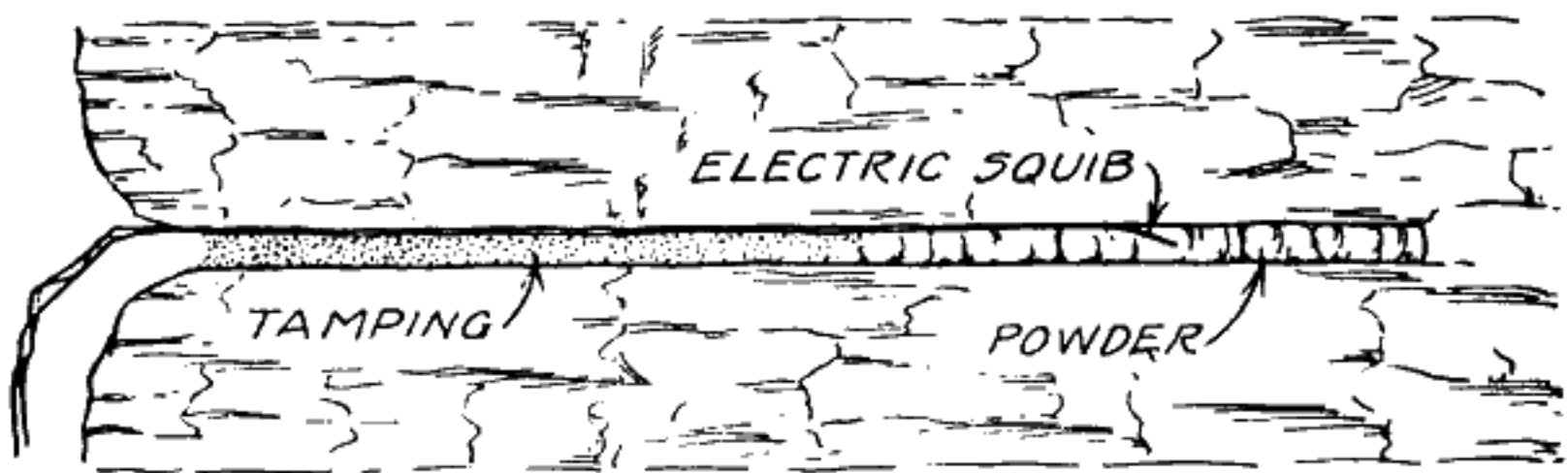


Fig. 11.—Bore hole charged with three cartridges or tamping bags, middle one primed with Electric Squib. Note how completely bore hole is closed and how the charge is ignited from the center.

Large charges of blasting powder are usually fired by means of dynamite primers. (See pages 37, 40–44 for more detailed information with regard to making primers.)

**Blasting Accessories for Firing Charges of High Explosives.**—Unlike blasting powder, high explosives are not fired by sparks or flame, but by means of intermediate agents, or detonators, such as blasting caps or electric blasting caps. These are charged with a powerful explosive which fires or detonates the explosive.



**Blasting Accessories—Blasting caps; safety fuse**

Single charges are fired by means of a blasting cap and fuse or an electric blasting cap, but when several charges must be fired together, the use of electric blasting caps is essential. See pages 37, 40-44 for methods of making dynamite primers with both cap and fuse and electric blasting caps.

Du Pont F, FF and FFF and sometimes small charges of R. R. P. are fired in exactly the same way as other high explosives, but large charges of R. R. P. are fired by means of dynamite primers. Such primers for blasts of R. R. P. should be not less than 4% by weight of the total charge of R. R. P.

**Blasting Caps.**—Blasting caps are the detonators used for firing high explosives when electric blasting is not practiced. They must always be used with safety fuse, and are in no way interchangeable with electric blasting caps.



Fig. 12.—No. 6 Blasting Cap—exact size.

It is not possible to fire a number of blasts simultaneously with blasting caps and fuse. Such blasting must be done with electric blasting caps.

Blasting caps are small copper cylinders closed at one end, and loaded with a charge of a very sensitive and violent explosive that is exploded by the spit or sparks from safety fuse. They are manufactured in the same strengths as electric blasting caps (Nos. 6 and 8), and have exactly the same strengths as the same numbers of electric blasting caps.

**Description of Blasting Caps**

	No. 6	No. 8
Color of Box.....	Red	Green
Length of Copper Shell.....	1½"	2¼"
Diameter of Copper Shell.....	.234"	.24"

**Safety Fuse.**—Safety fuse is the medium of bringing sparks to blasting caps to fire them and to ignite charges of blasting powder. It is made up of a fine train of powder tightly wrapped in, and more or less water-proofed by inner and outer wrappings or coverings of tape, yarn or twine.

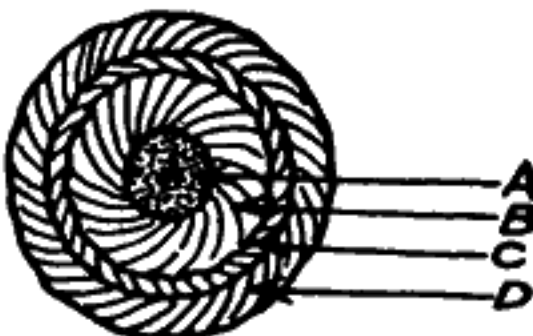


Fig. 13.—Cross section of safety fuse enlarged—showing "A," the train of powder, and "B," "C," "D," the layers of protecting and water-proofing materials. The powder train burns while the protecting layers usually do not.

**Blasting Accessories—Safety fuse**

The rate of burning of fuse varies considerably with the different brands, speeds of from 32 to 40 seconds per foot being obtained. Even the same brand and make of fuse may vary as much as ten per cent. either way from the average. The above figures are for the rate of burning in the open, as there can be no absolute standard rate in the confinement of the bore hole due to the many kinds of stemming material and different degrees of tightness of tamping. The greater the confinement the faster the fuse will burn, and the burning speed, under these conditions, may be considerably faster than in the open. A rule-of-thumb method is to allow one minute for each two feet of fuse.

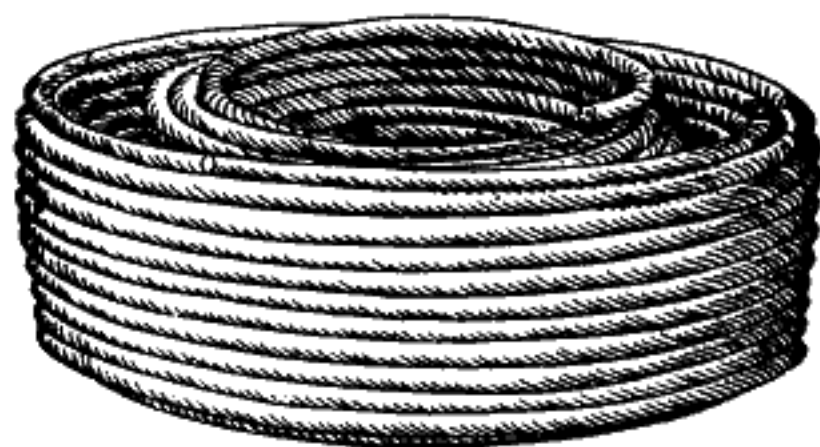


Fig. 14.—Double roll of safety fuse with paper wrapping removed.

The classification of brands of fuse sold by the du Pont Company is:

Dry	Damp	Wet	Under Water
Hemp*† Cotton* Jute‡	Single Tape*†† Beaver* Sylvanite‡ Blue Label‡ Charter Oak* Comet‡	Double Tape*†‡ Charter Oak* (Gray and Black) Anchor or Crescent* Reliable* White Monarch‡ Black " ‡ Acme‡ Dreadnaught‡ Bear†‡ Victor‡ Comet Special‡	Triple Tape*†‡ Clover* Stag* Shield‡ Pacific‡ Eclipse Special‡

\*Is sold east of Montana, Wyoming, Colorado and New Mexico, or in the Eastern States.

†Is sold west of North Dakota, Wyoming, Colorado and New Mexico, or in the Western States.

‡Is sold in the States of Wyoming, Colorado and New Mexico, or in the Middle Western States.

The different kinds of safety fuse made are thus divided into four classes, according to the kinds of blasting for which they are intended. These classes are:

Dry work  
Damp work

Wet work  
Under water

It should be remembered, in all classes of blasting where water is encountered, that the loading should be done and the shots fired as soon as possible. While the brands listed for use under water

### Blasting Accessories—Cap crimpers; du Pont Cap Sealing Compound

will burn through water when first loaded, they will not withstand wetting for a long time, especially when under pressure of several feet of water.

Hemp Fuse and Cotton Fuse are too small in diameter to fit the standard blasting cap properly, and should be used only for exploding blasting powder charges where, unless a dynamite primer is used, a blasting cap is unnecessary.

**Cap Crimpers.**—No blasting equipment for either blasting caps and safety fuse or electric detonators is complete without a cap crimper. It is a special tool for fastening blasting caps to

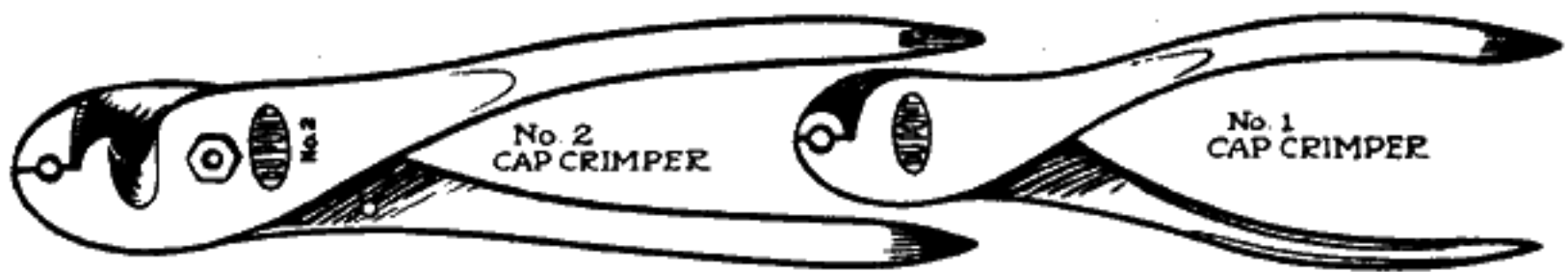


Fig. 15.—The cap crimpers are necessary for attaching blasting caps to fuse. They are also useful for making holes in cartridges of high explosives when making primers. The one shown at the right is the No. 1 type. The No. 2 type has a fuse cutter.

safety fuse and for punching holes in cartridges of dynamite for inserting the detonator.

Blasting caps must be securely fastened to the safety fuse, both to prevent the fuse from being pulled out of them when the primer cartridges are loaded and the bore holes tamped, and also to facilitate the process of water-proofing the blasting caps and primers. Experience and careful tests have shown conclusively that blasting caps crimped tightly on the fuse are much more effective than those fastened loosely or not crimped at all. Crimping can be accomplished successfully only by the use of an instrument made especially for the purpose. Cap crimpers are essential for safety and for efficiency. They make the flat sleeve crimp shown in the accompanying cut that holds the cap securely on the fuse in such a way that but a small amount of any of the water-proofing substances is required to protect the cap charge from water.

They are so made that they cannot squeeze the blasting cap far enough into the fuse to interrupt the burning of the powder



Fig. 16.—Cap crimped to fuse.

train and cause misfires. They are well made of good material, and if used only for the purposes intended will last for a long time.

**Du Pont Cap Sealing Compound** is a material for sealing water-tight the space between the shell of a blasting cap and the fuse which is inserted into the blasting cap.



**Blasting Accessories—For multiple and rotation shots; electric blasting caps**

Fig. 17.—Du Pont Cap Sealing Compound.

However well the cap may be fastened to the fuse by the crimper, it is almost impossible to make a joint that will prevent water from leaking in and spoiling the cap.

After the blasting cap is crimped on the fuse, the cap with two or three inches of the fuse is dipped for a few seconds into the Cap Sealing Compound and hung up to dry. It is not necessary to soak the cap in the compound. By the time the compound has dried for about thirty minutes, a water-tight joint is formed which will resist almost any amount of water commonly encountered in blasting with cap and fuse. The cap should be used soon after it is dry, as the Cap Sealing Compound becomes brittle after a few days and is likely to crack and admit water.

Du Pont Cap Sealing Compound is put up in half-pint, pint, quart and gallon cans.



Fig. 18.—Cap Sealing Compound applied to crimp.

**Multiple Shots.**—When the charges in a number of bore holes are fired simultaneously, one of the following detonating agents must be used:

- (a) Electric blasting caps for instantaneous firing under normal conditions.
- (b) Water-proof electric blasting caps for instantaneous firing under water.
- (c) Submarine electric blasting caps for instantaneous firing under large heads of water.
- (d) Cordeau, a detonating fuse.

**Rotation Shots.**—Where the separate charges are to follow each other in sequence, the following are applicable:

- (a) Delay electric blasting caps for firing blasts in quick succession with a single application of the electric current.
- (b) Delay electric igniters for firing blasts in quick succession with a single application of the current.
- (c) Safety fuse and blasting caps as previously described.

All of these various detonators are described in the following paragraphs:

**Electric Blasting Caps.**—Electric blasting caps, or detonators, as the name implies, are special detonators fired or exploded by an electric current.

The illustrations, Figures 19 and 20, show electric blasting caps complete and in section.

## Blasting Accessories—Electric blasting caps

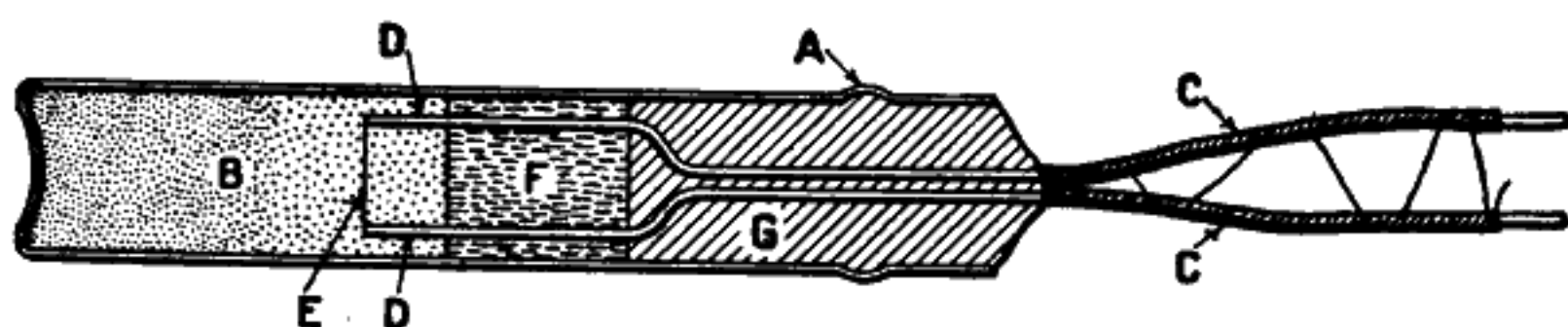


Fig. 19.—Electric Blasting Cap (Section). "A" is a copper shell, having a corrugation thrown out from the inside, which holds the filling material more firmly in place; "B" is the chamber containing the explosive charge; "C" the insulated copper wires entering the cap; "D" the bare ends of the copper wires projecting through the plug into the charge; "E" the small wire or "bridge" soldered to and connecting the two ends of the copper wires, which is heated by the electric current; "F" the composition plug holding the wires firmly in place; "G" the filling and water-proofing material.

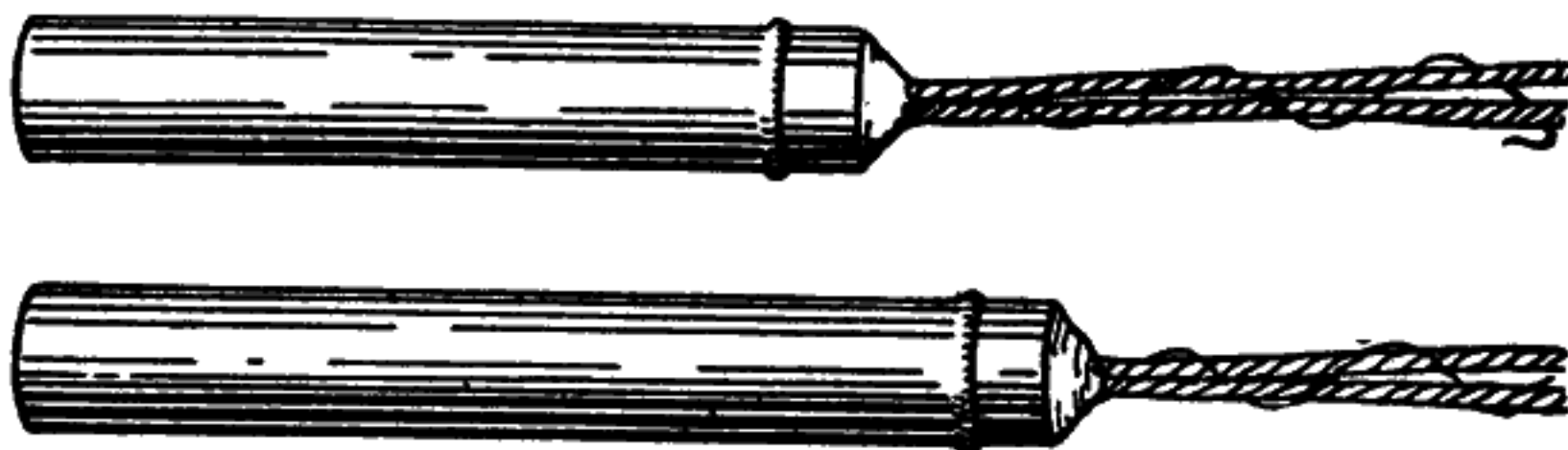


Fig. 20.—No. 6 and No. 8 Electric Blasting Caps. The wires are cut different lengths to suit different depths of bore holes.

The strength of electric blasting caps is governed by the amount of the explosive charge contained, and is expressed by the numbers "6" and "8."

The following table describes fully the two sizes or strengths:

Grade.....	No. 6	No. 8
Color of Label.....	Red	Green
Length of Shell.....	$1\frac{9}{16}$ "	2"
Caliber of Shell.....	.273"	.273"

Du Pont Electric Blasting Caps are coated with red shellac so that they are easily distinguishable from other makes.

The blasting cap wires vary in length to suit different depths of bore holes and different classes of work. They should always be long enough to reach a few inches out of the bore hole, and, when possible, to the wires of the adjoining bore holes.

Stock lengths of copper wires are:

4 ft.	10 ft.	16 ft.
6 "	12 "	18 "
8 "	14 "	20 "

Longer length wires may be had on special order.

Electric blasting cap wires are well insulated.



**Blasting Accessories—Electric blasting caps, with iron wires, submarine**

Copper wires are ordinarily used on account of the low electric resistance.

Electric blasting caps are packed in paper cartons.

**Electric Blasting Caps with Iron Wires.**—Iron wires are used to a great extent in coal mining on account of cheapness when only one or two shots are fired at one time. On account of the electric resistance of iron being about six times as great as that of copper, a given size of blasting machine cannot fire as many electric detonators when iron wires are used as when copper wires are used. The standard lengths of iron wires are 2, 4, 6 and 8 feet. The iron wires are carefully insulated.

**Water-proof Electric Blasting Caps.**—Although electric blasting cap wires and copper shells are well insulated against water, they are not intended for extreme conditions. If used in water, particularly under pressure, water may penetrate and spoil the charge, or, they may develop electrical "leaks," so that the electric current may "short circuit" through the water instead of passing through the bridge wire, which is of higher resistance. For such work electric blasting caps with a longer shell and special insulation for wet work are used. These specially insulated electric blasting caps are called water-proof electric blasting caps. The wires of water-proof electric blasting caps are enameled. When the wires are cut care should be taken to scrape off the enamel as well as the cotton insulation, to insure a good electrical contact.

They are made in the same strengths, No. 6 and No. 8, with the same lengths of insulated copper wires as the electric blasting

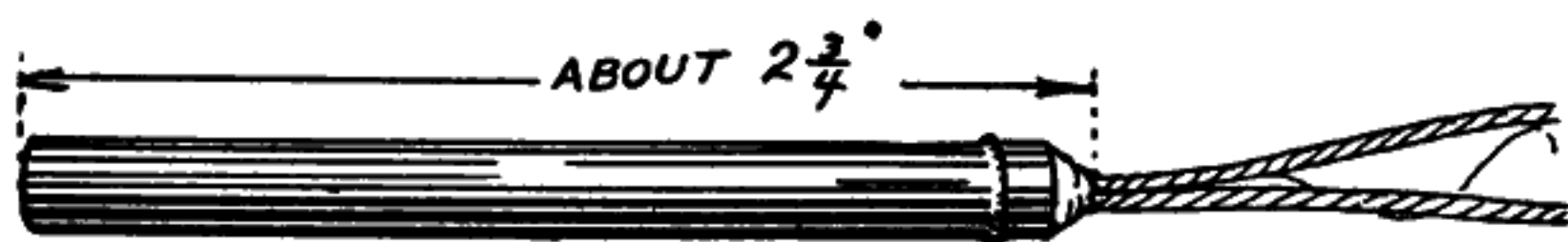


Fig. 21.—Water-proof Electric Blasting Cap.

caps. Iron wires are not used. Water-proof electric blasting caps are designed for use in water up to 30 feet in depth.

**Submarine Electric Blasting Caps.**—For extreme water conditions, such as submarine work, where the greatest safeguards against water are necessary for safety and for developing the full strength of explosives, a special submarine electric blasting cap is used.

This is well safeguarded by having a heavy covering of gutta-percha enclosing the copper shell and the lower or cap ends of the wires.

The strength of submarine electric blasting caps is the same as for Electric Blasting Caps, Nos. 6 and 8.

To meet the requirements for extreme conditions, submarine electric blasting caps are furnished (on special factory orders only) with gutta-percha insulated wires.

## Blasting Accessories—Delay electric blasting caps

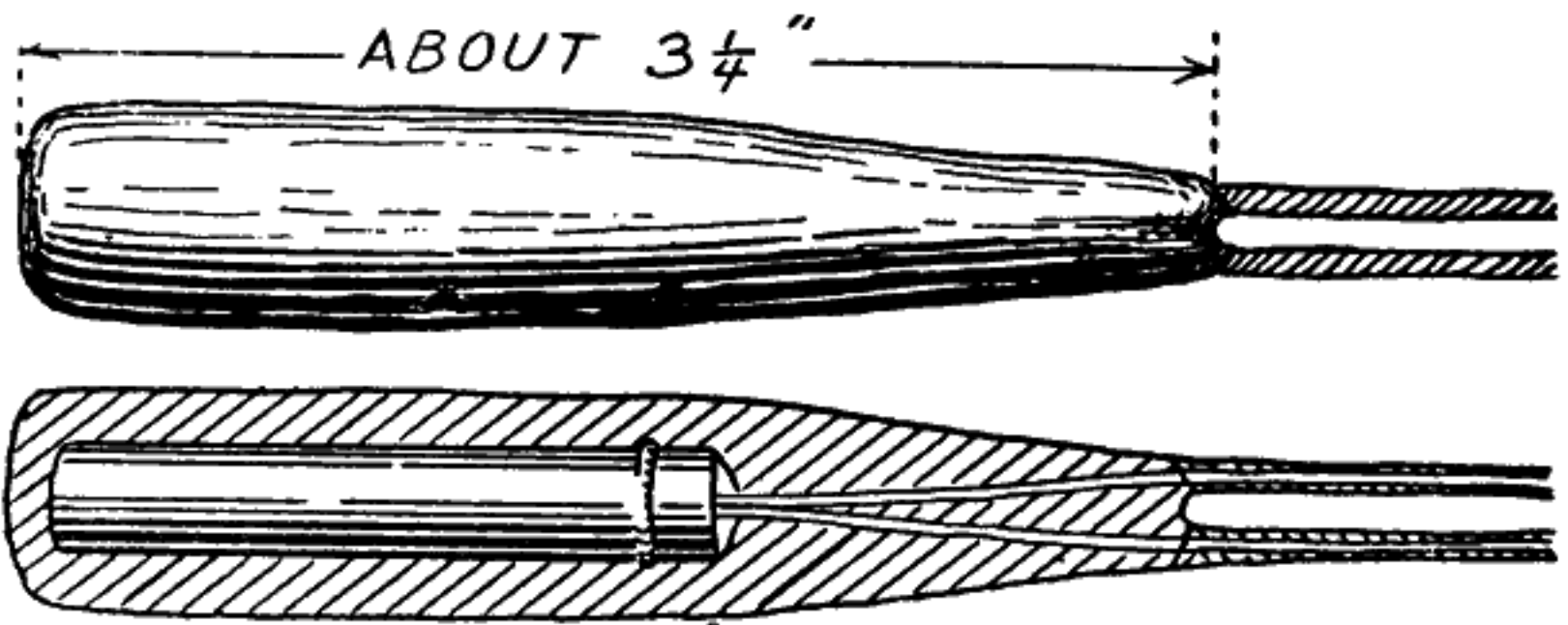


Fig. 22.—Submarine Electric Blasting Cap—Showing gutta-percha covering for water-proofing.

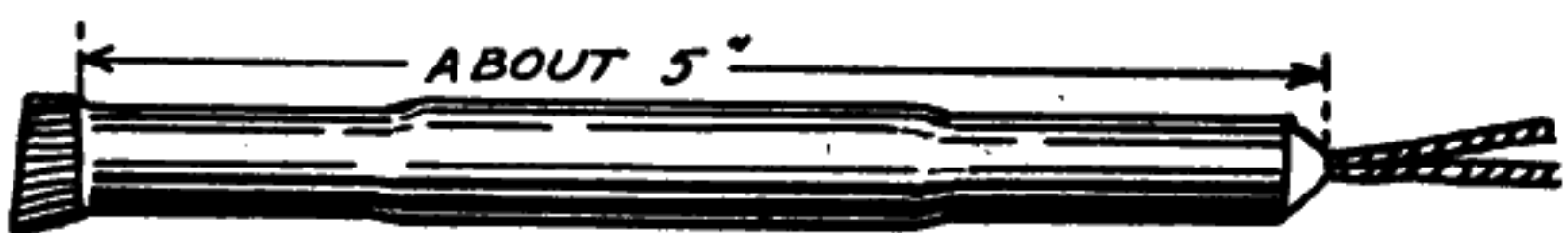
**Delay Electric Blasting Caps.**—In some kinds of blasting, particularly in tunnel and shaft work, it is necessary to blast each round of bore holes in sections or in rotation. It is generally a saving in time if this can be done in such a way as to overcome the necessity of returning to the working face after each section has been blasted to arrange for the next blast. When fuse and blasting caps are used to detonate the explosive, the fuse for the different bore holes is cut in different lengths so that the charges will explode in the proper sequence if the fuses are lighted at about the same time. There is practically no limit to the number of charges which can be exploded in sequence with fuse and blasting caps in this way, but electric firing is much more satisfactory for the many reasons of safety and effectiveness already pointed out. Under most conditions there is nothing to be gained by dividing the round of holes into more than three sections. This permits of cut, relief and rib shots.



No. 6 Electric Blasting Cap.



First Delay Electric Blasting Cap.



Second Delay Electric Blasting Cap.

Fig. 23.—Comparison of Size of Electric Blasting Caps and Delay Electric Blasting Caps.

**Blasting Accessories—Delay electric blasting caps; delay electric igniters**

Delay electric blasting caps have been developed for such conditions, so that these three classes of shots may be fired in rotation with a single set of wiring and with but one application of the electric current, and in such a way that there is no trouble from the first round of shots breaking the wires for the second and third rounds, as is the case when two or three sets of wires are used for series shots using only electric blasting caps.

There are three kinds of delay electric blasting caps—first delay, second delay, and third delay. These are so constructed that there is a short lapse of time after the current is applied before the first delays explode, and a longer delay before the second delays explode. It should not be understood that all first delays explode simultaneously, but the variation in time is very little, and all first delays explode before any of the second delays and all the second delays before the third delays. There is also a little variation in the time of explosion of the second delays.

In practical work the delay electric blasting caps are used in connection with electric blasting caps. As the electric blasting caps explode immediately upon receiving the electric current, they are used in the holes, such as cut or breaking in holes, that are to fire first, thereby relieving the burden on the second set of holes, such as relief shots, which are primed with first delays. The last set of holes, such as rib or trim shots, are primed with second delays and fired after all of the others are out of the way. A better understanding of this loading may be obtained by a close study of Fig. 154, page 123.

Delay electric blasting caps are manufactured in the same strengths (Nos. 6 and 8) as electric blasting caps. They are fitted with copper wires only. The lengths of the wires are the same as for electric blasting caps. The wires on the first delays are white, those on the second delays are blue, and those of the third delays are red, to distinguish them from one another and from electric blasting caps, which have black insulation, before and after loading.

Delay electric blasting cap wires are connected for blasting just as are electric blasting caps. They may be connected in the same series with any of the other electric detonators or with delay electric igniters.

**Delay Electric Igniters.**—These are made up of a cylindrical copper tube, into one end of which the wires, plug and bridge are inserted, and into the other end is crimped a piece of fuse 2 inches, 4 inches, 6 inches, 8 inches, 10 inches or 12 inches in length, and designated as first delay, second delay and on to sixth delay, respectively, the fuse acting as the delay. They are made with insulated copper or iron wires of the same length as the electric blasting caps. They are adapted for firing charges of explosives in rotation, by placing an electric blasting cap in the cut holes or the first set of holes to be fired, the first delay in the second set, the second delay in the third set, and then following with the other delays in order.



**Blasting Accessories—Delay electric igniters; connecting wire; leading wire; cordeau**



**Fig. 24.—Delay Electric Igniters.** These are manufactured in six lengths for six delay periods, and are loaded after a blasting cap has been crimped to the fuse, according to the delay, in exactly the same manner as delay electric blasting caps. See Figs. 16 and 148.

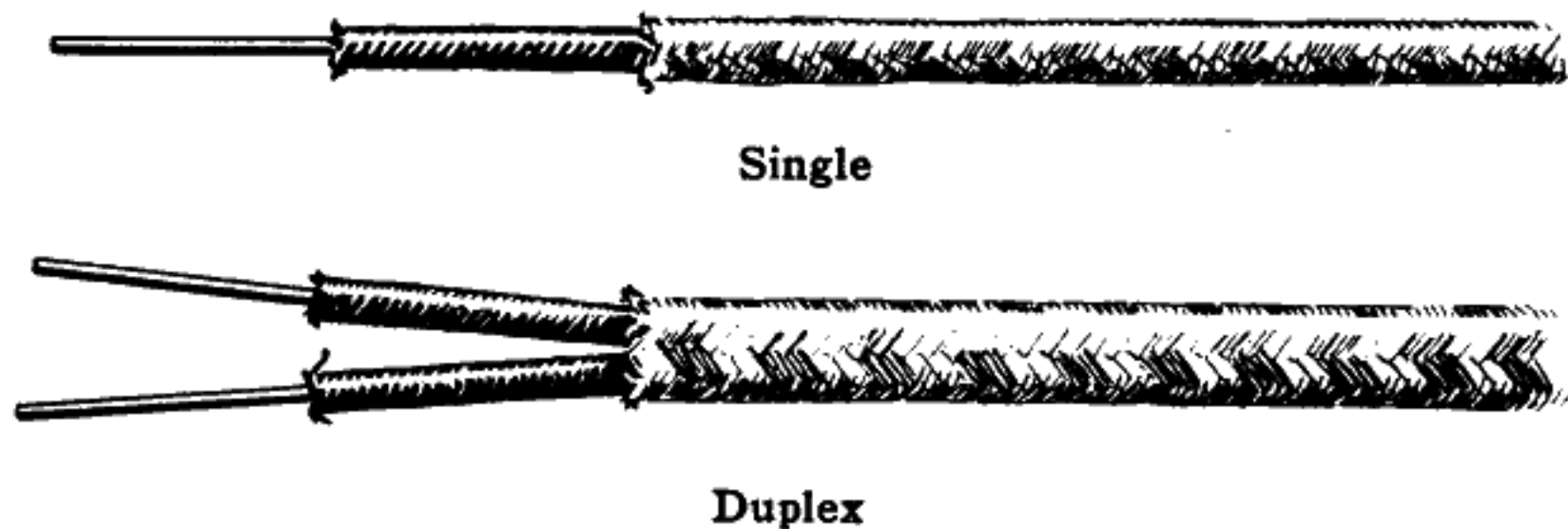
When a delay electric igniter is used with dynamite, it is necessary to crimp a No. 6 or No. 8 Blasting Cap to the fuse and insert it in a cartridge of dynamite as a primer. When used with blasting powder, it is not necessary to use a blasting cap.

The use of delay electric igniters is strongly recommended for all metal mining and for coal mining where it is unsafe to fire more than one shot at a time. By their use it is possible to load as many as six shots, and with one set of connections and one application of the current, have each shot fire singly. This applies to the use of both blasting powder and dynamite.

Before using a half inch should be cut off the end of the fuse, as the water-proofing compound in which it is dipped may affect the powder core at the end.

**Connecting Wire.**—This small No. 20 and No. 21 insulated copper wire is furnished on spools weighing either one or two pounds. It is used for splicing electric blasting cap wires when they are too short to reach between holes. No. 20 runs about 210 ft. to pound, No. 21 about 260 ft. to pound.

**Leading Wire.**—Leading wire is used to carry the current from the blasting machine to the electric blasting cap wires in the bore holes and return. It is heavily insulated No. 14 copper wire and comes in coils of 200 ft., 250 ft., 300 ft., and 500 ft. in length. Leading wire is made either single or duplex.



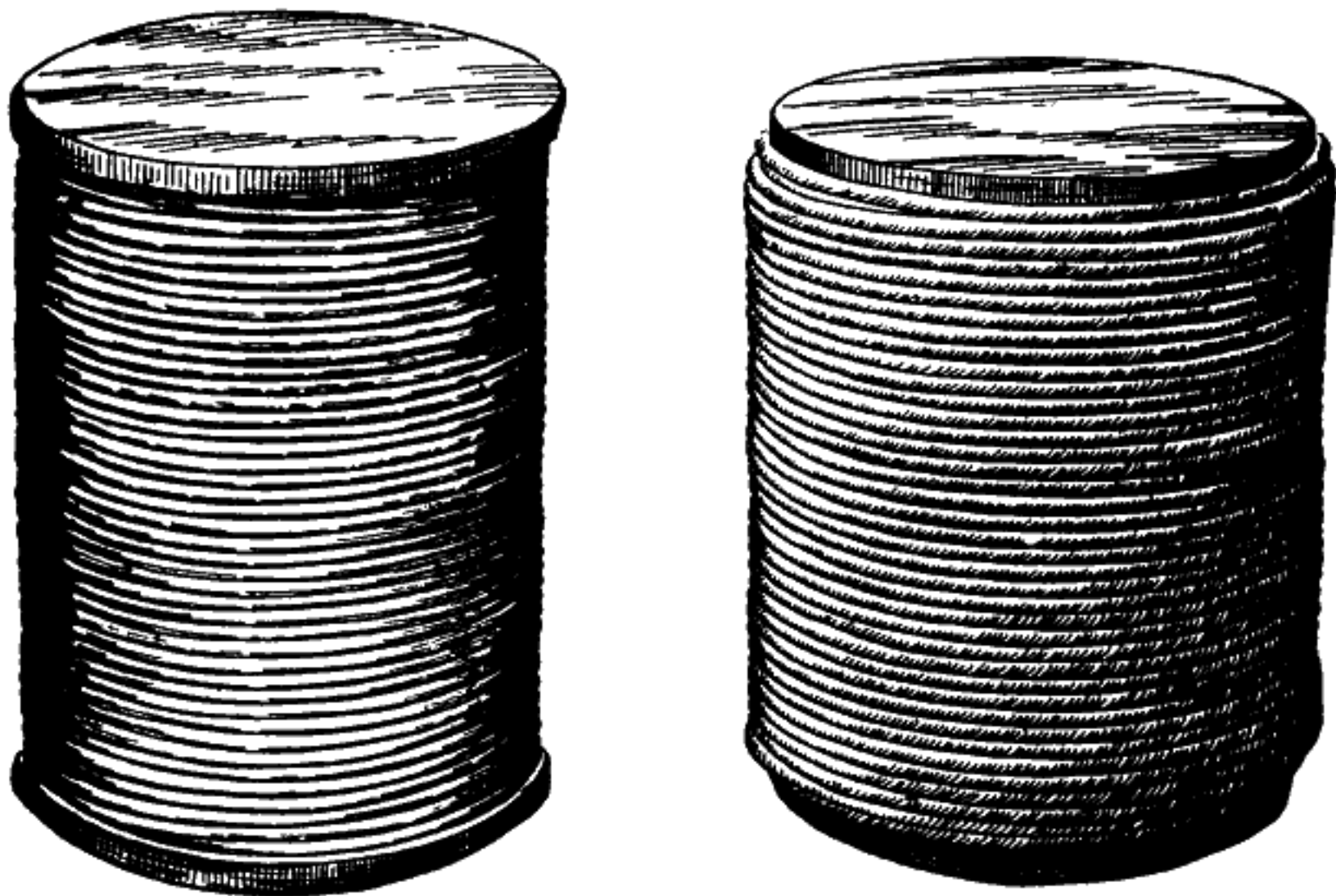
**Fig. 25.—Leading wire.**

**Cordeau.**—Cordeau, or detonating fuse, is a small lead tube, about the same diameter as double tape fuse, filled with an explosive compound which has a velocity of detonation of about 17,500 feet (more than 3 miles) per second. It is now used principally in deep well drill blast holes and similar large blasts.

**Blasting Accessories—Cordeau; tamping bags**

In spite of the great velocity and strength of the detonation of cordeau, it is very insensitive and cannot be exploded by hammering, pinching or burning. It is exploded in actual use by blasting caps or electric blasting caps, which must be in actual contact with the explosive compound contained in the cordeau. Only indented or flat end caps should be used as these allow a better contact between the blasting cap charge and the explosive in the cordeau. Water-proof electric blasting caps should not be used to detonate cordeau because they are made with a rounded end.

The extreme violence of the explosion of cordeau is sufficient to detonate high explosives lying alongside it in a bore hole.



Plain

Fig. 26

Countered

Spools of Cordeau.

Cordeau is furnished either with the plain lead covering or with the lead covering surrounded with a second covering of cotton cord, the first being called "plain" and the second "countered."

See page 71 for specific information regarding loading holes with cordeau.

**Tamping Bags.**—Tamping bags made of heavy paper are used as containers for sand, clay and other material for tamping. They save time and trouble when loading bore holes, particularly those pointing upward.

They are also employed as containers for blasting powder when the miner or blaster desires to make up the charge in cartridge form, as is generally the custom when it is used in mines, in open work that is damp and where the holes point upward.

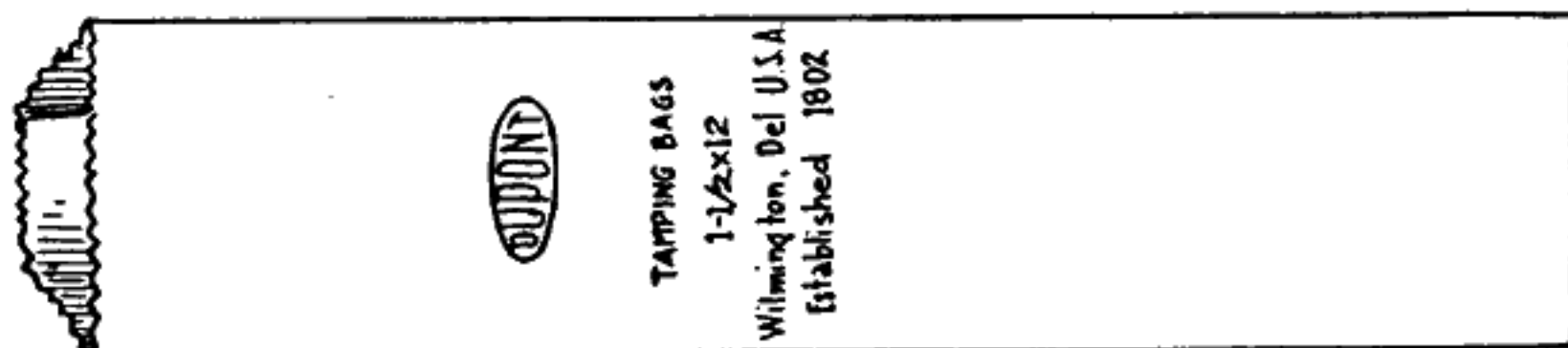
In use, the desired amount of explosive or tamping is poured into the bag, the ends of paper are folded over, and the bag then placed in the bore hole in the same manner as are cartridges of high explosives. Tamping bags are made in the following sizes:

## Blasting Accessories—Tamping bags; blasting mats

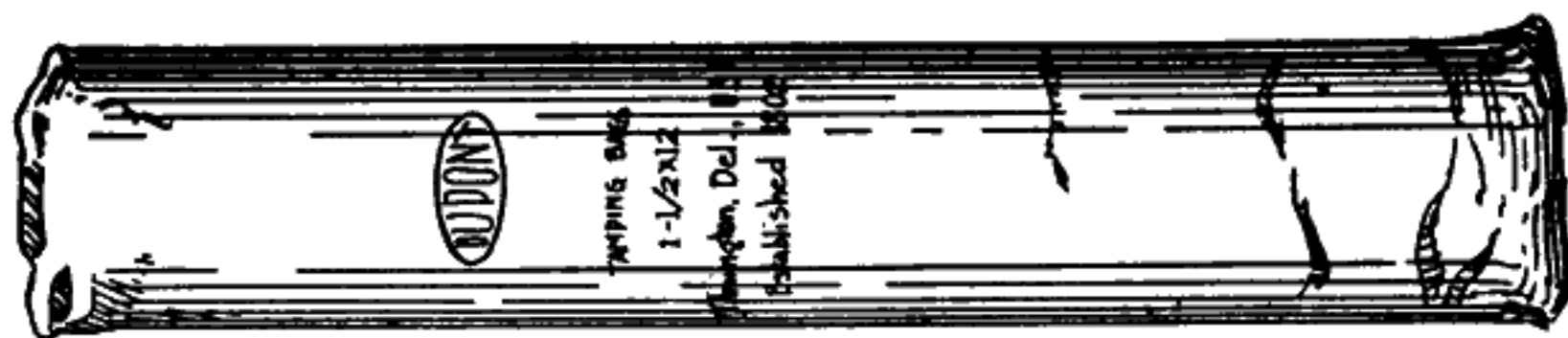
All our tamping bags are made approximately 2 inches longer than the length shown above, in order to provide for folding or lapping at the open end after the bags are filled with tamping material.

Tamping bags are packed in bundles of 500 each, and 10 bundles to a bale—a bale containing 5,000, as indicated above.

Size No.	Sizes in Inches.		No. in Bale.	Shipping Weight Per Bale.	
	Diameter.	Length.			
A	1	x 8	5 M	24	lbs.
B	1 $\frac{1}{4}$	x 8	5 M	28 $\frac{1}{2}$	"
C	1 $\frac{1}{4}$	x 10	5 M	33 $\frac{1}{2}$	"
D	1 $\frac{1}{4}$	x 12	5 M	38 $\frac{1}{2}$	"
E	1 $\frac{1}{2}$	x 8	5 M	33	"
F	1 $\frac{1}{2}$	x 10	5 M	39 $\frac{1}{2}$	"
G	1 $\frac{1}{2}$	x 12	5 M	44	"
H	1 $\frac{1}{2}$	x 16	5 M	67 $\frac{1}{4}$	"
J	2	x 18	5 M	82	"



(Empty)



(Full)

Fig. 27.—Tamping bags for loading granular explosives and tamping material (stemming).

**Blasting Mats.**—Blasting mats are heavy mats made of rope. In city blasting, they are placed over blast holes to catch or hold material flying from the blasts. Hemp rope is generally used and is considered the best, although steel wire rope has been tried with success. The mats are made of 1-inch, 1 $\frac{1}{4}$ -inch or 1 $\frac{1}{2}$ -inch rope, according to the demands of the customer. They are not carried in stock, but are woven on order and are made in any size required.



**Blasting Accessories—Blasting mats**

If the blasting mats are to cover light charges of explosives, they may be spread directly over the bore holes; but if heavier charges are used, railroad ties or logs should be put down first and the mats on top of them. Sometimes the mats are propped on lightly supported uprights several feet above the blast, so that when the blast is fired the débris is caught on the underside of the mat.

Use is also made of fiber board, heavy planks, timbers, cross-ties, logs and brush. These are placed over the blasts to form a blanket for holding down the broken fragments that might fly from the blast. As practically all blasting conditions vary, little exact advice can be given, so the blaster must depend largely on his own judgment in placing mats.

These arrangements are very effective in preventing the rock from being thrown into the air, and should always be adopted when blasting is done near thoroughfares or buildings.

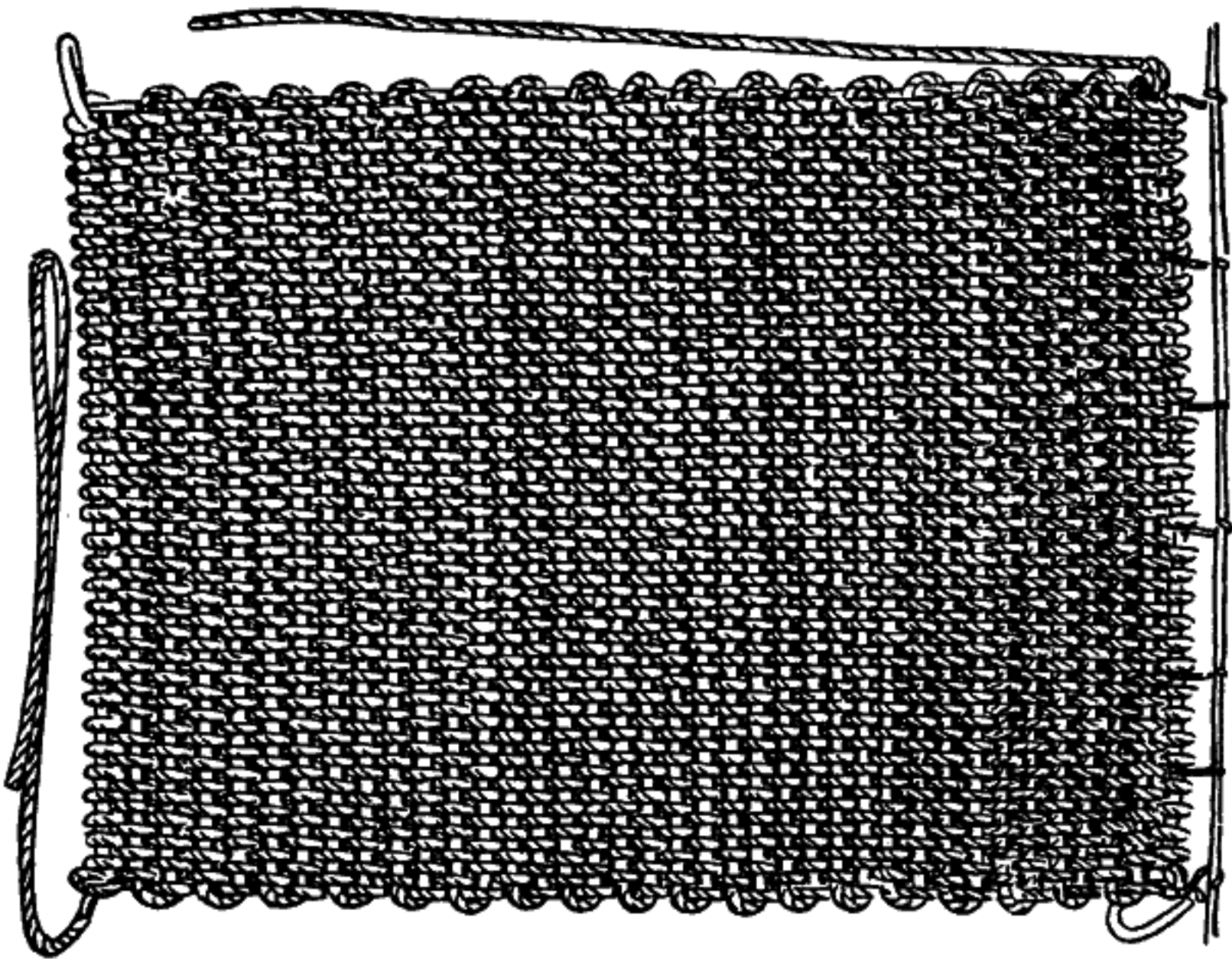


Fig. 28.—A hemp blasting mat for preventing material from flying from blasts.

Thawing Dynamite—Du Pont thawing kettles

## THAWING DYNAMITE

While with the present development of low freezing dynamite, thawing is rarely necessary, some high explosives containing nitroglycerin chill or freeze and become insensitive in cold weather. When frozen, dynamite is difficult to detonate or it may burn instead of exploding. Burning dynamite gives off fumes so poisonous that men have been killed by them. Dynamite when chilled or frozen cannot develop its full strength in a blast. Some provision, therefore, must be made for thawing it and for **keeping it thawed** until it is loaded into the bore hole.

The fundamental rule of thawing dynamite is to thaw slowly with the cartridges lying on their sides and not to place the dynamite over an active source of heat. Nitroglycerin crystallizes as it freezes and consequently separates from the absorbent to a small extent in minute crystals. If thawing is done slowly with cartridges lying flat the nitroglycerin will be re-absorbed as fast as it liquefies. Quick thawing at high temperature tends to cause leakage.

On work where these explosives are used in large quantities, thawing houses are necessary; but even then a thawing kettle should be employed to take the explosives from the thawing house to the place where they are to be used, to prevent them from becoming chilled or frozen again.

If not more than two or three hundred pounds of explosives are used at one time, three or four large thawing kettles are all that are necessary, as they will thoroughly thaw that quantity of frozen dynamite in a few hours.

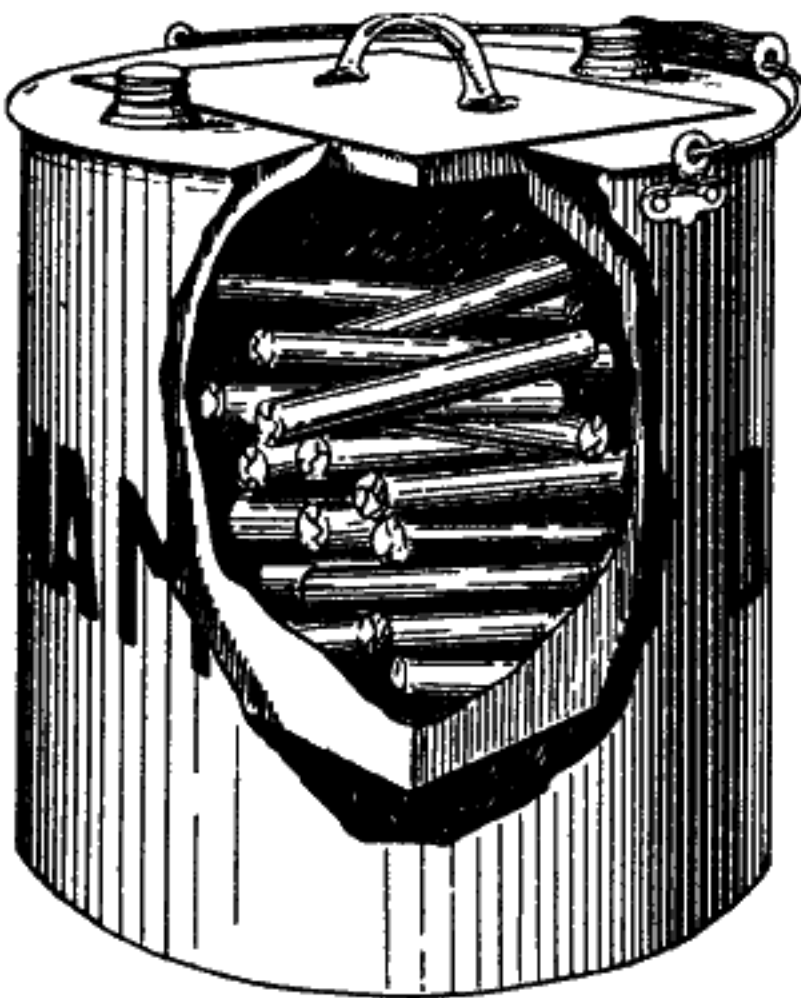


Fig. 29.—Du Pont Thawing Kettle, showing two compartments and dynamite. See table on next page for sizes.

Du Pont Thawing Kettles are all made with a water-tight compartment for the explosives, which is surrounded by the receptacle for the hot water used to furnish the heat for thawing. This hot water must not come in contact with the dynamite. The entire kettle is made in one piece.

While thawing kettles will retain their heat and keep the explosive thawed for a considerable time, depending, of course, on the nature of the weather, this effective period can be increased to about five times as long if the warm kettle is kept in a barrel or box with dry hay surrounding it. This hay can be held in place by a cylinder of wire screen, so that the thawing kettle can easily be re-



**Making Primers—With blasting cap and fuse**

moved and replaced. If the barrel be mounted on two wheels with a tongue attachment, it can be readily drawn from point to point about the outside work, so that it will not be necessary to expose the dynamite to the cold air until it is to be loaded in the bore hole. Somewhat similar benefits result from wrapping old blankets or sacks around the warm kettle.

Under no circumstances must the water be heated in the thawing kettle itself, even though the explosives be first removed, because nitroglycerin exudes readily from warm dynamite, and enough of it is likely to be found in the bottom of the explosives compartment of a thawing kettle that has been in use for some

	Capacity	Weight Empty	Weight of Water	Total Weight Filled	Outside Dimensions
Du Pont No. 1	30 lbs.	12½ lbs.	40 lbs.	82½ lbs.	14" x 14½"
Du Pont No. 2	60 lbs.	17½ lbs.	77½ lbs.	155 lbs.	17½" x 21"

time, to cause a serious accident if the thawing kettle should be placed over a fire. It is necessary to heat the water in something else before filling the water jacket. *The hot water must always be tested before filling the dynamite compartment. If it is hot enough to burn the hand, do not put the explosives into the thawing kettle.* Never fill the water jacket unless the explosives compartment is empty. See that the explosives compartment is perfectly dry before it is filled.

Thawing kettles should be kept clean at all times. Should any of the explosive compounds leak out, the explosives compartment should be thoroughly cleaned with a solution of sal soda.

The use of the thawing kettles can, to a large extent, be done away with by using low-freezing explosives, such as du Pont Straight Dynamite, Red Cross Extra Dynamite and du Pont Gelatin.

**MAKING PRIMERS**

A high explosive cartridge with an electric blasting cap or other detonator inserted is called a primer. Primers should be carefully made:

To insure the complete detonation of the explosive.

To keep the detonator from pulling out of the explosive.

To guard against moisture.

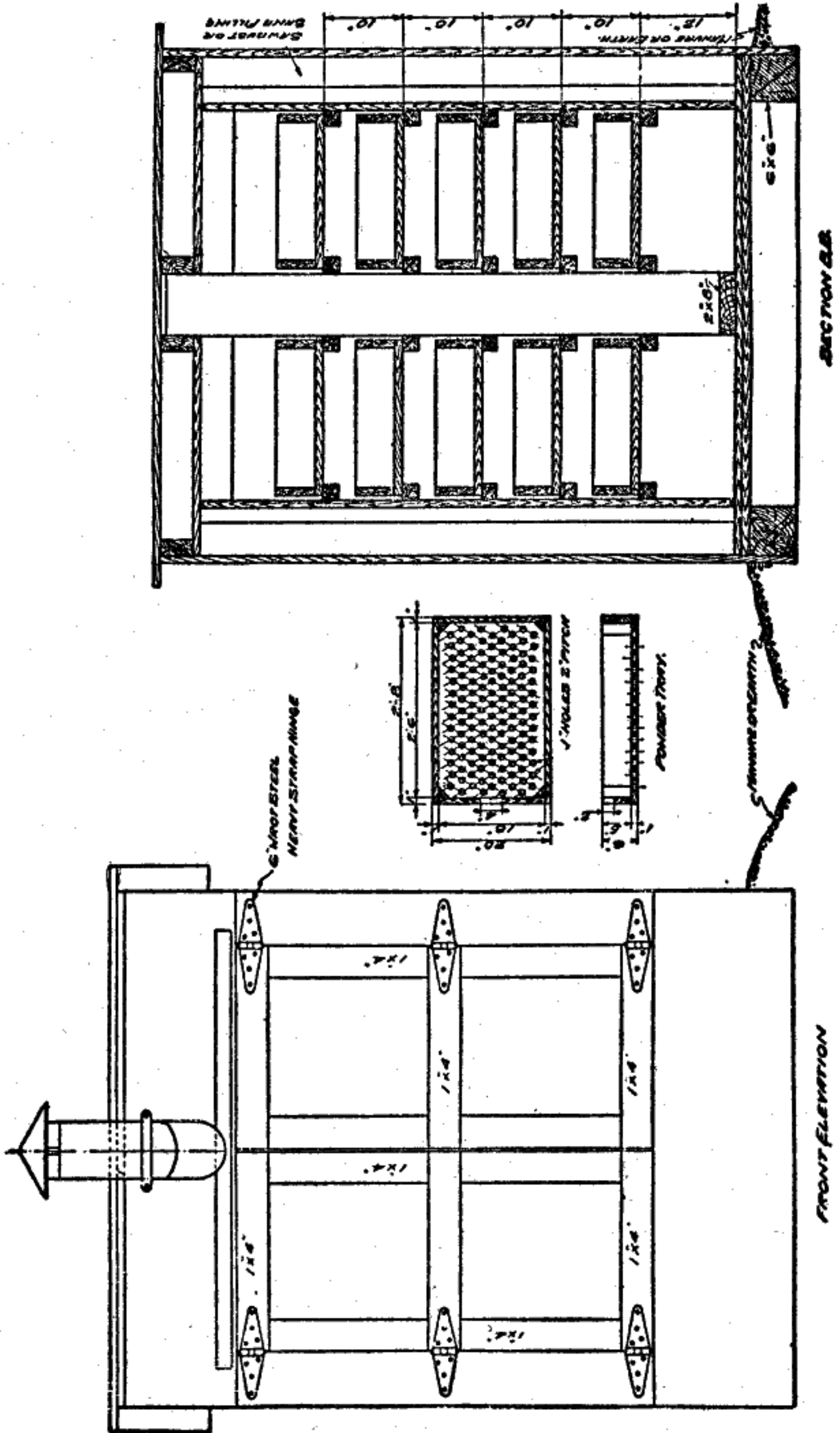
To permit easy and safe loading of bore holes.

To keep the safety fuse when blasting caps and safety fuse are used, from pulling out of the blasting cap.

**Making a Primer with Blasting Cap and Safety Fuse.**—In making a primer with blasting cap and fuse, cut off a sufficient length of fuse to reach from the charge of explosives loaded in the bottom of the bore hole to three or four

DYNAMITE THAWING HOUSE

Plans and specifications for different types are furnished on application.





## Making Primers—With blasting cap and fuse

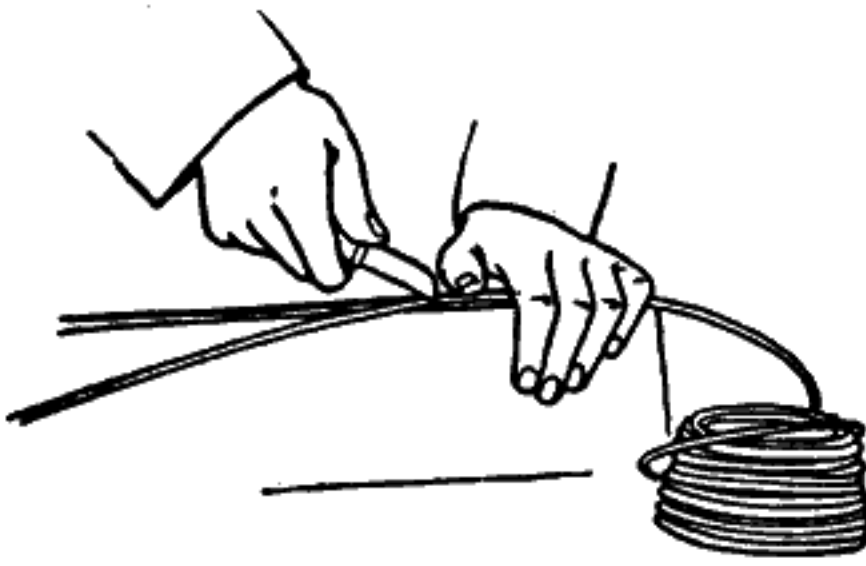


Fig. 30.—Cut off a sufficient length of fuse.



Fig. 31.—Take one cap from the box with the fingers.

round with a cap crimper, and slip the blasting cap gently over the end of the fuse, so that the fuse reaches down to the explosive charge in the blasting cap. (See Fig. 32.) Do not twist the fuse into the blasting cap, and do not use violence or force when handling the blasting caps or when making primers.

When the blasting cap is placed on the fuse, fasten it securely in place with a cap crimper (Fig. 15). The crimp must be made close to the open end of the blasting cap, as is shown in Fig. 16, page 26.

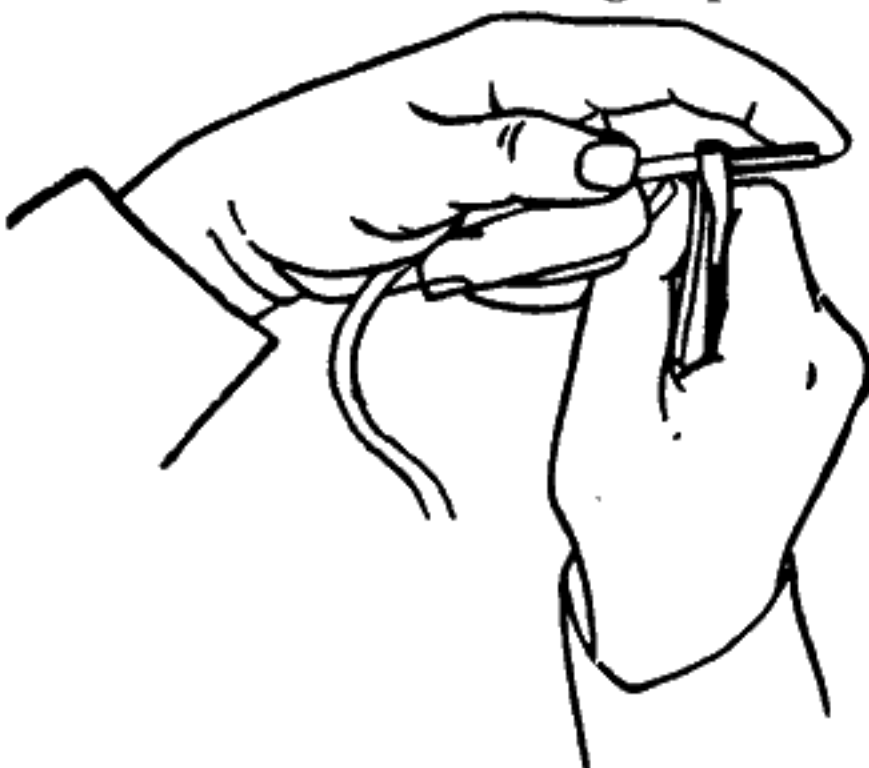


Fig. 33.—Crimp cap to fuse with cap crimper.

inches above the collar or top of the bore hole. In all classes of blasting, the length of the fuse must be governed by the time required for the blaster to reach a safe place after lighting the fuse for a proper rotation of shots.

After removing the cover of the blasting cap box, allow a single blasting cap to slide gently into the hand (Fig. 31). Never try to pick a blasting cap out of the box with a wire, knife blade, stick, or other hard tool. See if any foreign matter, such as trash or grit, is in the open end of the blasting cap; if so, shake it out gently. If the end of the fuse is flattened, roll it between the thumb and finger to round it out again or squeeze it

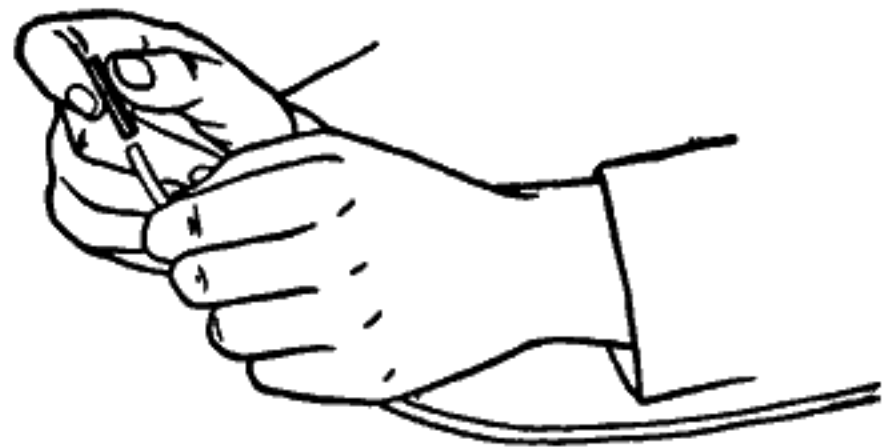


Fig. 32.—Slip cap on end of fuse.

To make the crimp farther down might cause an explosion and seriously injure the blaster.

When the primer is to be used under water, the union between the blasting cap and the fuse should be protected against moisture by a coating of soap, axle grease, wax or du Pont Cap Sealing Compound. Never use any substance for sealing a cap that contains any oil, as it will injure fuse.



### Making Primers—Priming in end of cartridge

**Priming in the End of Cartridges.**—There are two good methods of priming cartridges in the end.

(a) With the handle of the cap crimper or a wooden awl, punch a hole straight into the end of the cartridge to a sufficient depth to receive all of the copper shell of the blasting cap (Fig. 34). Insert the cap with the fuse attached into the hole and fasten it there by means

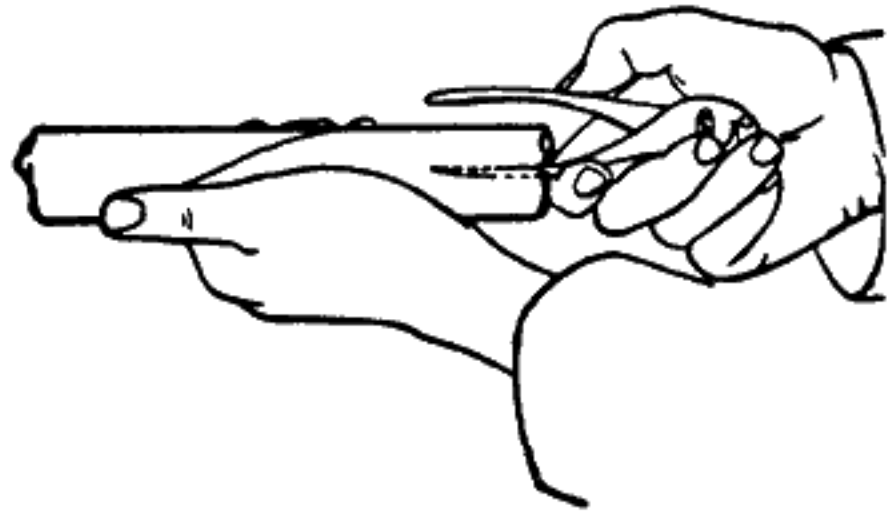


Fig. 34.—Punch hole with handle of cap crimper.

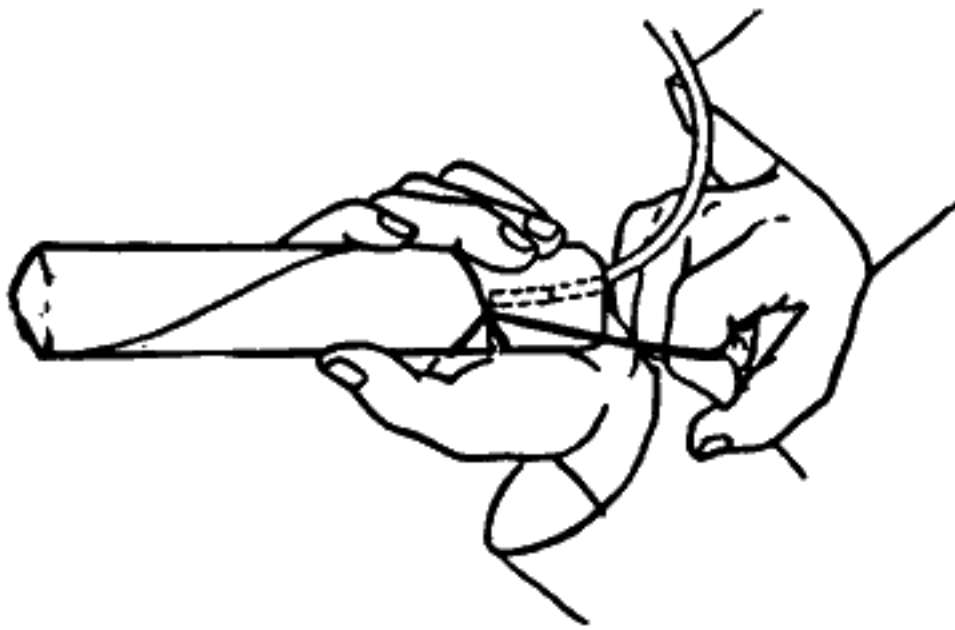


Fig. 35.—Tie cord around cartridge and

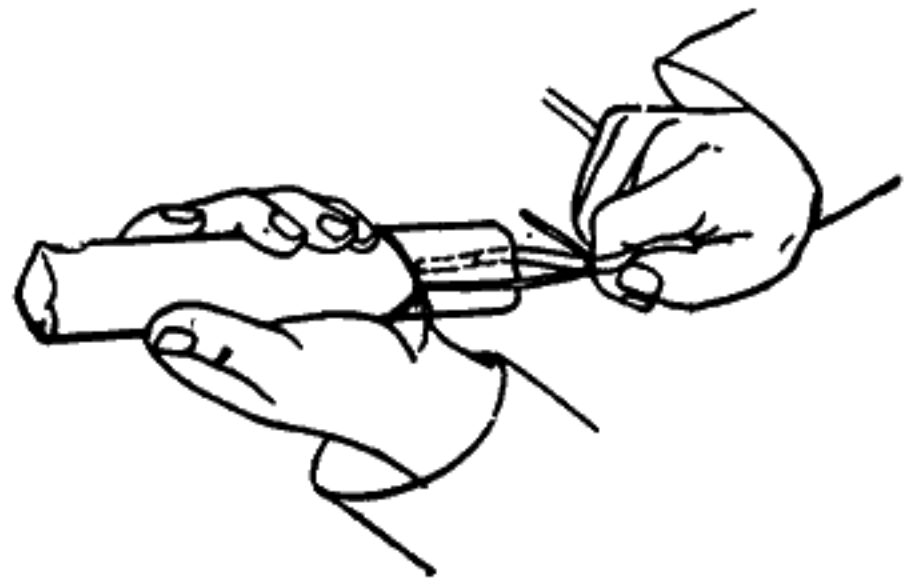


Fig. 36.—Then around fuse.

of a cord tied first around the cartridge (Fig. 35), and then around the fuse, Fig 36. This is an easily made and highly satisfactory primer.

To water-proof such a primer, close the hole where the fuse enters the cartridge with any of the sealing materials mentioned in an earlier paragraph under this general heading.

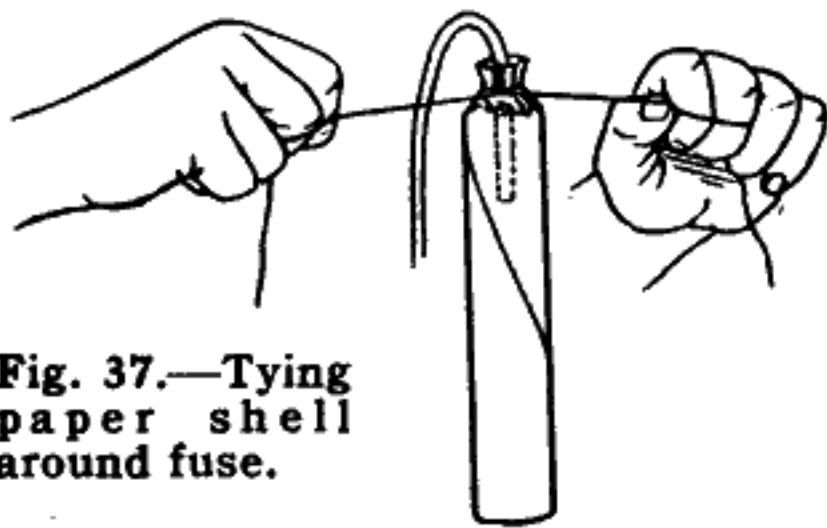


Fig. 37.—Tying paper shell around fuse.

(b) The other method is to unfold the paper from the end of the cartridge and punch a hole directly into the center of the exposed dynamite, close the loose part of the paper shell around the fuse, and tie it tightly (Fig. 37). The process of water-proofing is the same as in the first method described.

Priming in the end has the advantage of placing the blasting cap or other detonator in the best possible position for detonating the explosives used; but it sometimes has the disadvantage, especially when the bore holes are small, of not leaving sufficient room to place the tamping stick on the primer to slip it into place in the charge in the bore hole.

## Making Primers—Priming in side of cartridge

**Priming in the Side of Cartridges.**—To prime a cartridge in the side, the hole is begun about an inch or an inch and a half from one end of the cartridge. It should point in and toward the other end, so that when the blasting cap is inserted it will be as nearly parallel as possible to the sides of the cartridge. It should never be punched straight through the cartridge, as such a hole would not place the blasting cap in the proper place for detonating the explosive. A blasting cap in such a hole would be easily displaced or injured in loading. The correct location and angle of such a hole are indicated in Fig. 38. The hole should be deep enough to receive the entire copper shell of the blasting cap.

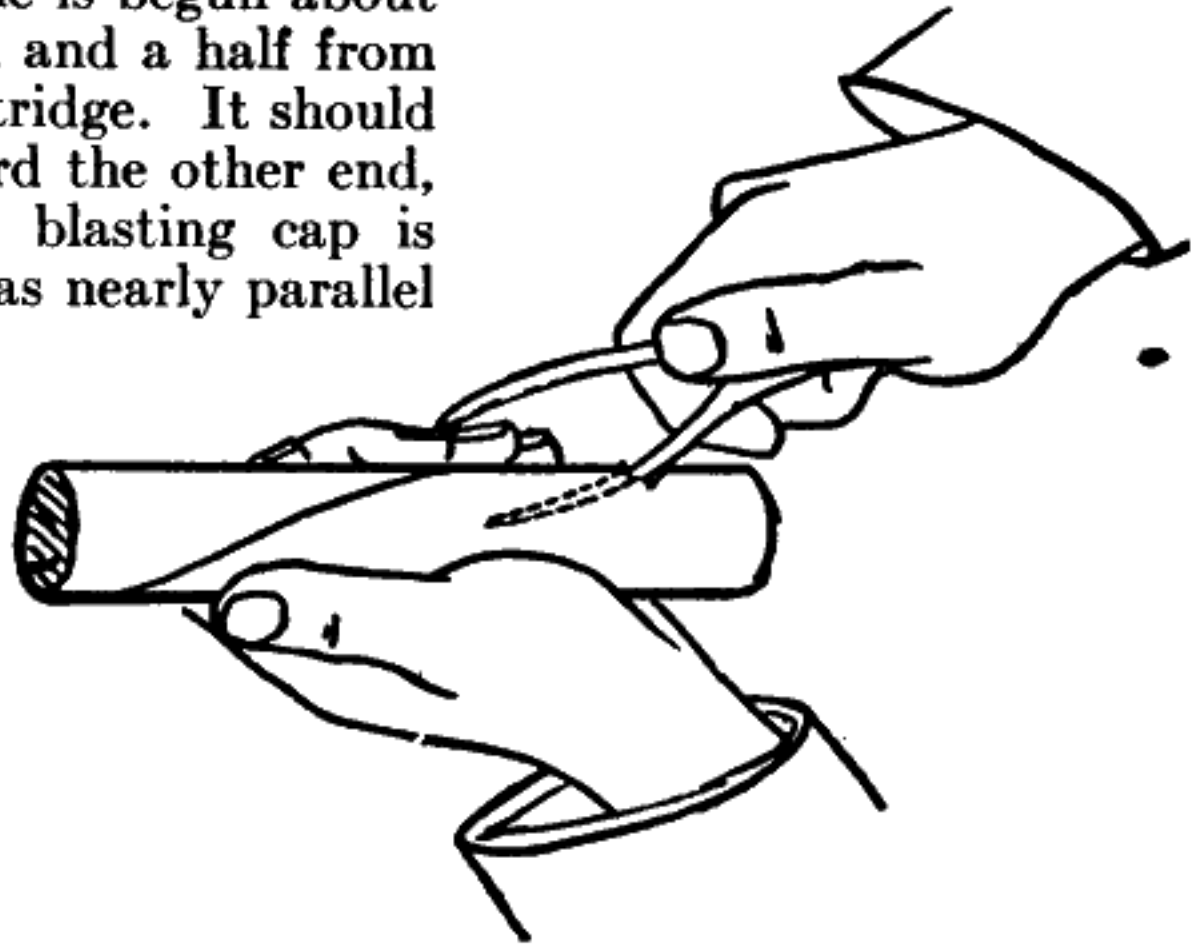


Fig. 38.—Punch a hole in side of cartridge with handle of cap crimper.

The blasting cap with fuse attached is slipped into the hole and securely fastened by means of a cord tied firmly around the fuse (Fig. 39), and then around the cartridge (Fig. 40). By this means, the cap is held securely to the cartridge, eliminating any danger of its slipping out and causing a misfire.

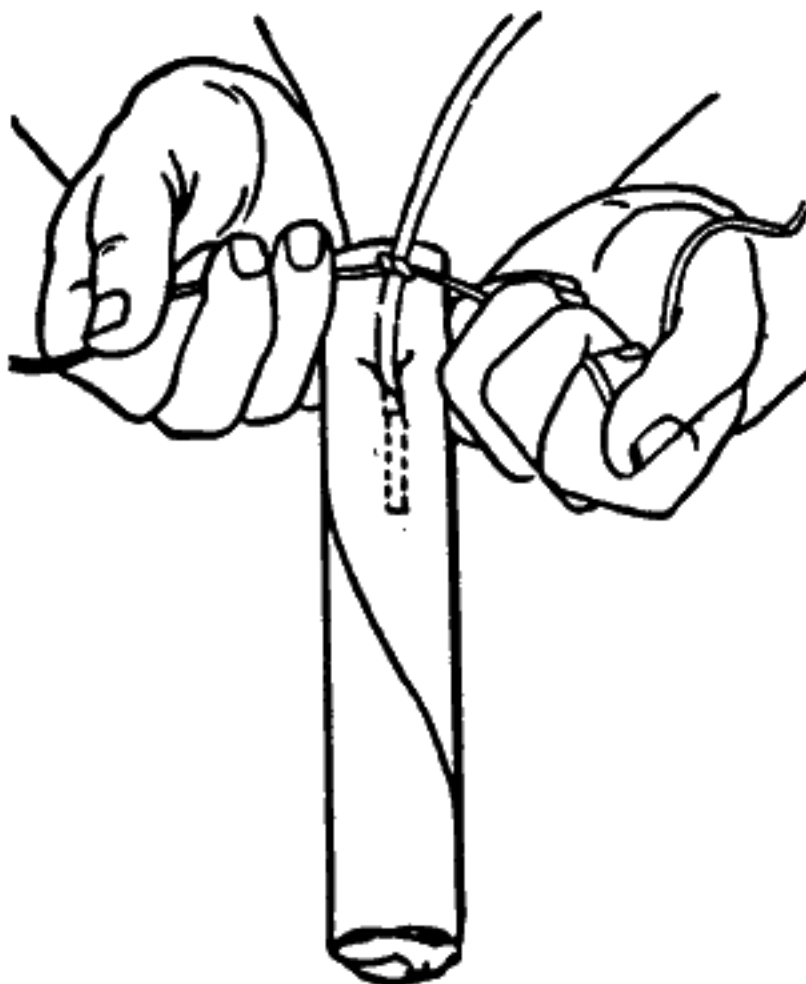


Fig. 39.—Tie cord around fuse.

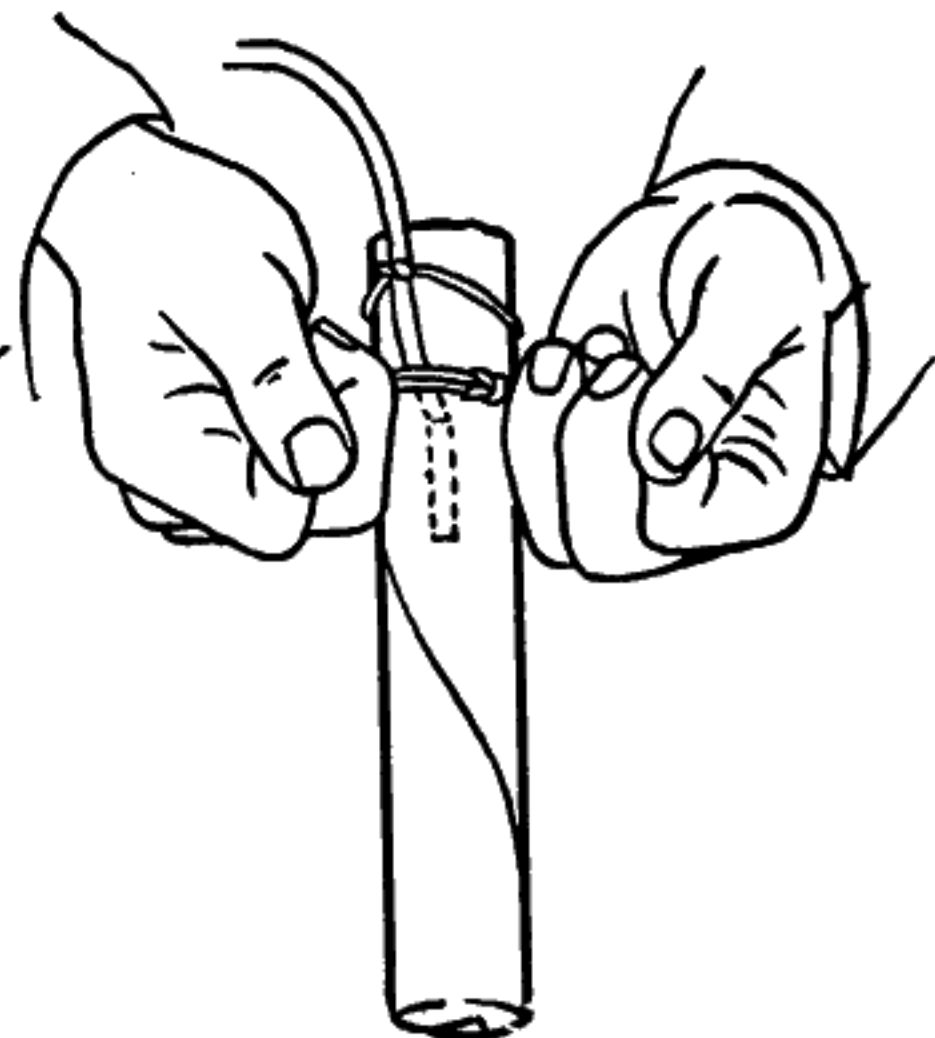


Fig. 40.—Complete by tying around cartridge.

**Making Primers—With electric blasting caps**

The method of priming in the side has the advantage of leaving more space for placing the tamping stick on the primer, without

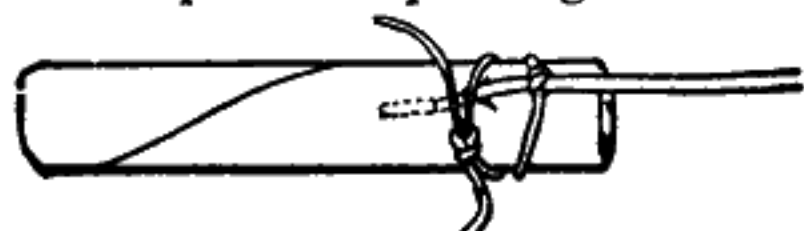


Fig. 41.—Completed primer ready to load.

bending the fuse, but it cannot be used in such small holes as can the end primers, on account of the fuse lying alongside the cartridge and thereby increasing the total diameter.

This method does not place the blasting cap in quite so good a position as priming in the end.

Such a primer is water-proofed by covering the joint between the fuse and paper shell with any of the water-proofing materials already described.

There are a number of other methods of making primers, but the three methods described are the only ones that have proved to be safe and reliable.

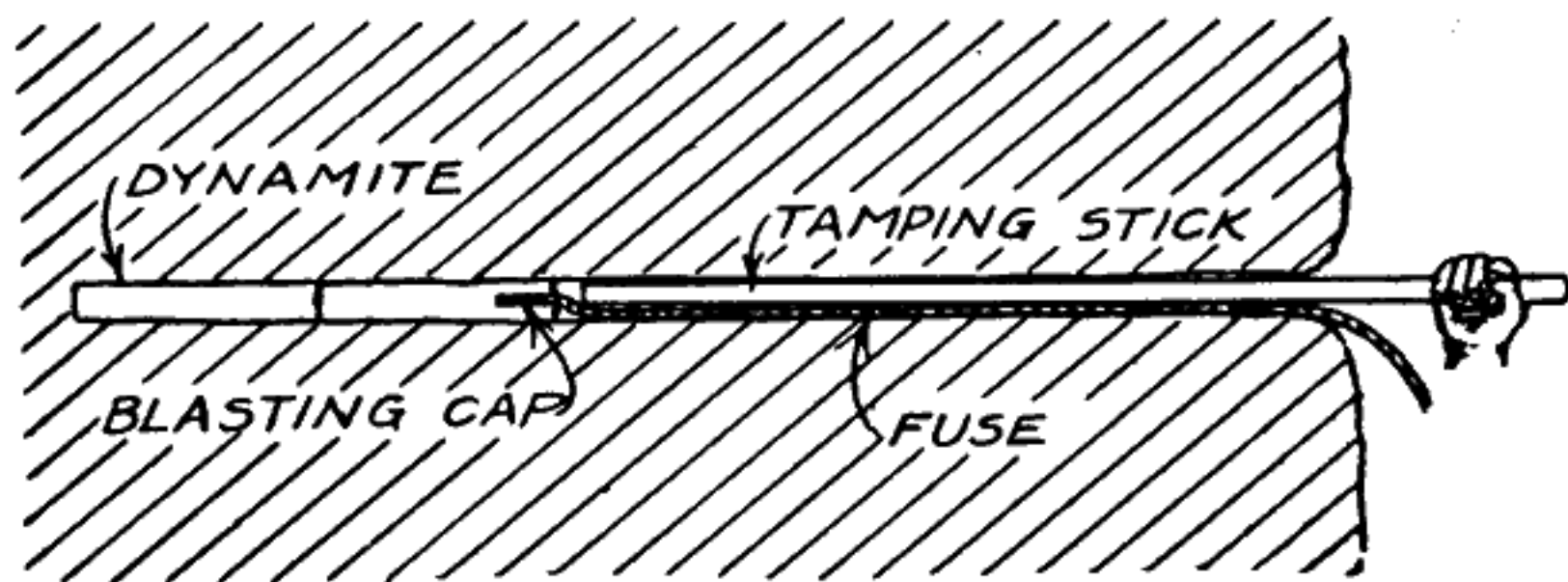


Fig. 42.—For very small bore holes, priming in the end is best, but has the disadvantage of having no place for the tamping stick. Note the bad bend in the fuse.

Fuse should never be laced through cartridges of high explosives, as the powder inside of the fuse may burn through the covering or "side spit" and ignite the dynamite before the cap explodes. This materially reduces the force of the blast and gives rise to poisonous fumes.

Care must always be taken to avoid injuring the fuse in any way while loading and tamping bore holes.

**Making Primers with Electric Blasting Caps.**—Primers can be made with electric blasting caps or other electric detonators by any of the methods described for the use of blasting cap and fuse. The water-proofing is done in exactly the same way. See Fig. 34, page 41, and Fig. 38, page 42.

Many blasters, however, prefer to use a slightly quicker method, which has been found entirely satisfactory.

Punch a hole from the center of the end of the cartridge in a slanting direction so that it will come out at the side two or three inches from the end, insert the end of the doubled-over wires of the electric blasting cap (Fig. 43A), loop these around the cartridge

**Making Primers—With electric blasting caps; with delay electric igniters**

(Fig. 43B), and punch another hole in the top a little to one side of the first and straight down. Insert the capsule in this last hole as far as possible and take up the slack on the wires (Fig 43C).

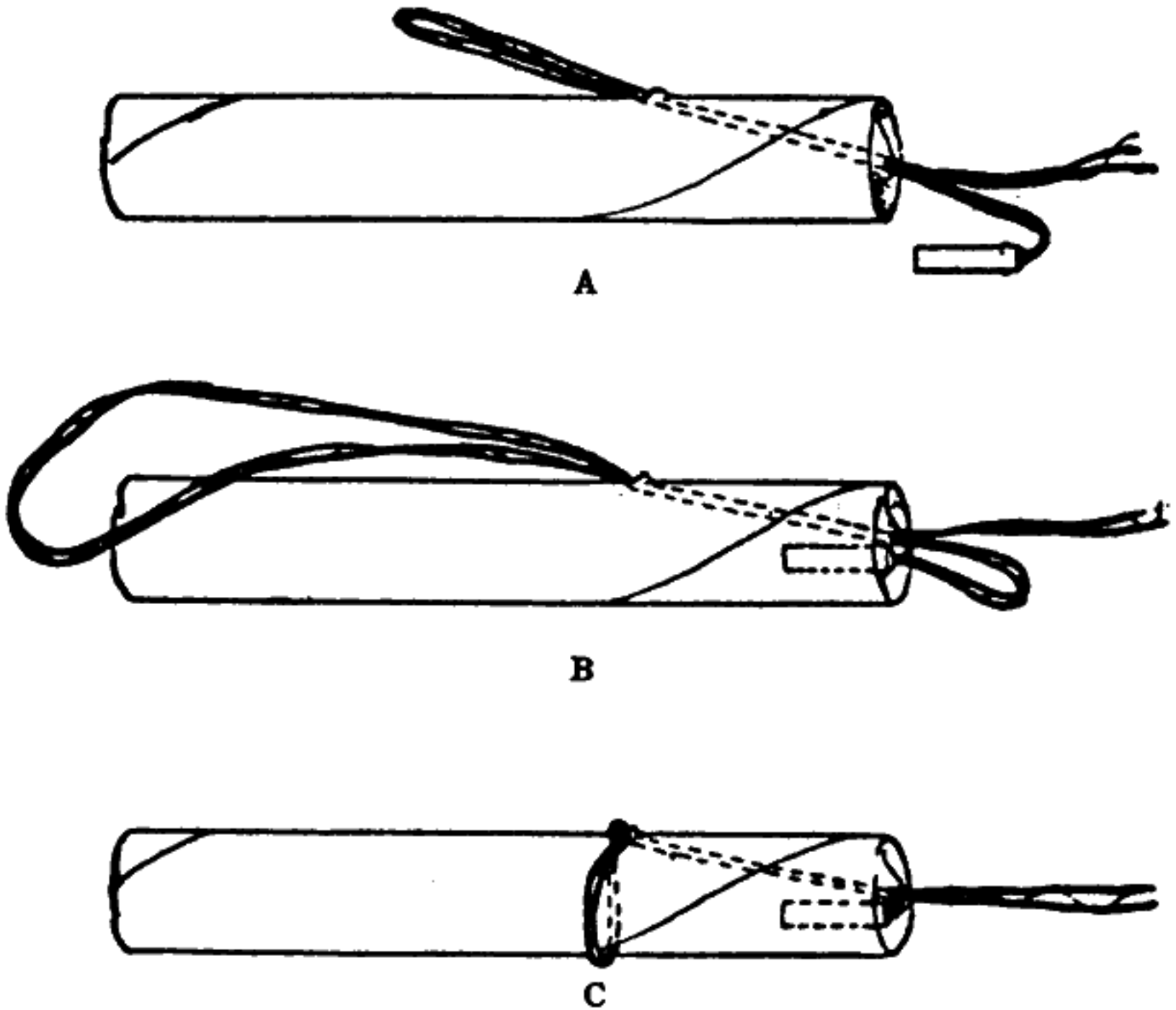


Fig. 43.—Priming with Electric Blasting Caps.

You now have a primer where the wires do not cross each other at any point, the capsule or detonator is lying nearly along the center line of the cartridge and the primer hangs vertically, so that it is possible to load it in a vertical bore hole without its lodging against the sides.

The wires of electric blasting caps should never be fastened around high explosive cartridges by half-hitching them, as a strong pull is likely either to break the wires or to cut the insulation.

**Priming with Other Electric Detonators.**—Primers with other electric detonators, such as delay electric blasting caps, submarine electric blasting caps and water-proof electric blasting caps, are made exactly as are primers with electric blasting caps, with the single difference that larger or deeper holes in the explosive cartridges are required to receive the detonators.

**Priming with Delay Electric Igniters.**—A delay electric igniter must have a blasting cap crimped to the exposed end of the fuse, from which a half inch has been cut off for reasons previously stated. The priming is done as with blasting caps and fuse, either in the end or in the side. In wet work the caps should be water-proofed.



## Wiring Blasting Circuits—Connecting wires

WIRING, TESTING AND FIRING ELECTRIC  
BLASTING CIRCUITS

The wiring or connecting of an electric blast must be correctly done to insure success. The work of wiring may be divided into three parts:

Connecting the detonator or squib wires either directly or by means of connecting wires;

Connecting the proper detonator wires to the leading wire;

Connecting the leading wires to the blasting machine.

**Connecting Detonator Wires.**—Connections between detonator wires or between detonator wires and connecting wires must all be carefully made. First scrape the bare ends of the wires with a knife blade, and then join them with a long twist (generally known as "Western Union twist"), such as is shown in Fig. 44.



Start



Finish

Fig. 44.—Correct method of splicing connecting and detonator wires.

Such a twist should be made tightly to keep the resistance in the joint down to a minimum. If there is no bare end to the connecting wire, skin off about two inches of the insulation. A later paragraph will give detailed information about protecting these bare joints. Never, under any circumstances, loop wires together.

**Connecting Detonator Wires to Leading Wires.**—In making this connection the ends of the wires must be cleaned. Wrap the detonator or connecting wires tightly around the end of the leading wire about one inch from the end (Fig. 45). Then bend the end of leading wire back sharply and take a turn or two



Fig. 45.—One method of attaching connecting wire or an Electric Blasting Cap wire to a leading wire.

of the detonator wire around the loop. This last loop is simply to make a stronger connection to withstand any accidental pull on the leading wire that might tear the connection loose.

## Wiring Blasting Circuits—Protecting joints; series connections

**Connecting the Leading Wire to Blasting Machine.**—The connection of the leading wire to blasting machine is made by loosening the wing nuts on the two binding posts and inserting the ends of leading wire into the two small holes in the binding posts and tightening the wing nuts down on the wires.

**Protecting Bare Joints in Wiring.**—The naked joints in the wires of a blasting circuit must always be protected against short circuiting, especially through water. This is done in several ways. When connections lie on moist ground, they may be held up by supporting them on stones, blocks or sticks, so that only the insulated parts of the wires touch the ground and supports; or the joints may be insulated with tape (Fig. 46). While not generally needed where the joints can be held off the ground, the taping of joints is strongly recommended where the joints are covered by



Fig. 46.—A properly taped joint.

tamping, where they cannot be held out of the water on props, and where blasting must be done during a rainstorm.

**Series Connections.**—When using a blasting machine, all blasting circuits must be connected "in series." This is done by connecting one wire from each hole to one wire in the next hole, and so on to the end, when only the two end wires are left free. These are connected to the ends of the leading wire. All of this is shown in the accompanying cut, Fig. 47.

This method of wiring can also be used when a power or lighting circuit is used for firing the blast.

When using this method,  $1\frac{1}{2}$  amperes for each series will be required and a sufficient voltage to overcome the resistance of the circuit, as is shown by the resistance table on page 54.

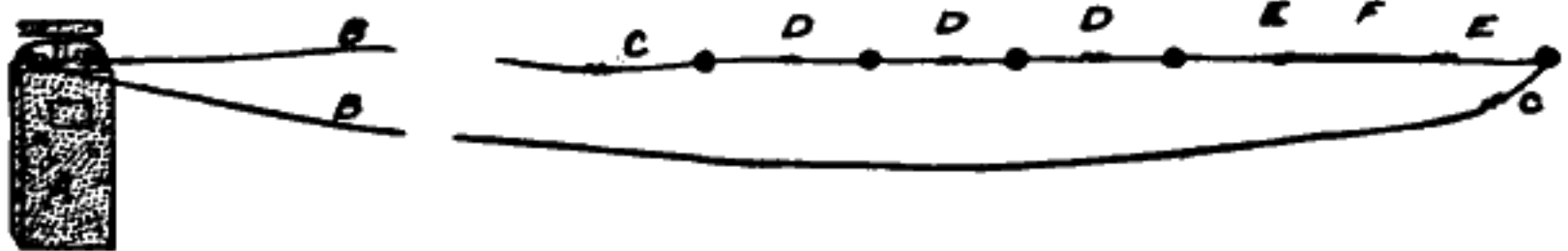
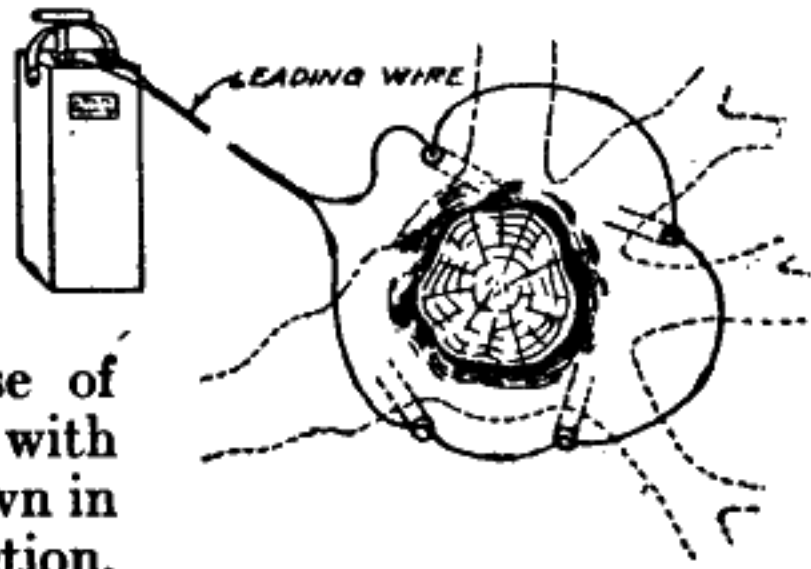


Fig. 47.—Series connections. A. Blasting machine. B. The two strands of single leading wire. C. Connections between leading wire and electric blasting cap wires. D. Connections between electric blasting cap wires. E. Connections between electric blasting cap wires and a short piece of connecting wire F, used to connect electric blasting cap wires that are too short to reach from hole to hole. This may be left out when long electric blasting cap wires are used, or it may be used between all holes in some cases.

When duplex wire is used a piece of connecting wire, "A," is required to connect the extreme end to the leading wire, as is shown in Fig. 49. This has a single objection in that it introduces an additional connection which will increase the resistance.

Wiring Blasting Circuits—Series connections

Fig. 48.—Showing a stump blast, with four Electric Blasting Caps connected in series; the leading wire; and blasting machine.



Some blasters prefer a slightly different method of making connections which obviates the use of connecting wire in connection with duplex leading wire. This is shown in Fig. 50. It takes one less connection, but is slightly more expensive on account of requiring longer electric blasting cap wires and requires the closest attention in order to get a good circuit.

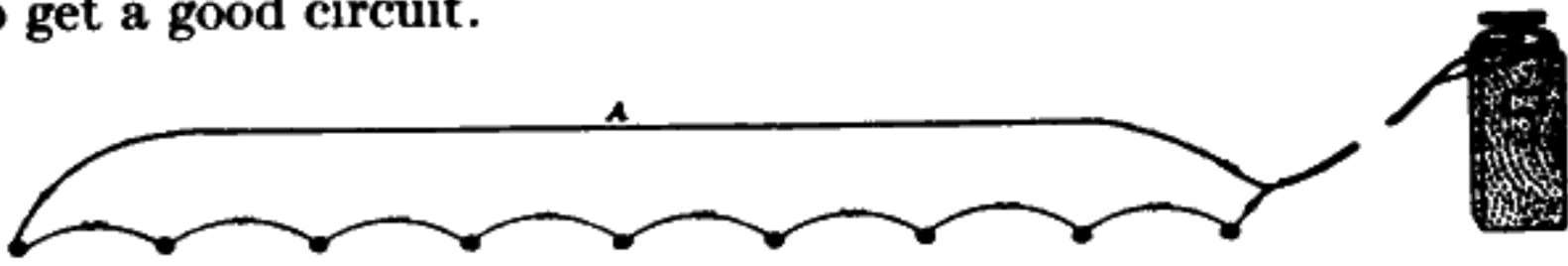


Fig. 49

An excellent method of making a series connection where two lines of holes are used is shown in Fig. 51. This is of especial advantage when using two lines of holes with delay electric blasting caps or delay electric igniters and in blasting wide ditches. Either single or duplex leading wire may be used.

How three lines of holes for the use of delay electric blasting caps or delay electric igniters or for

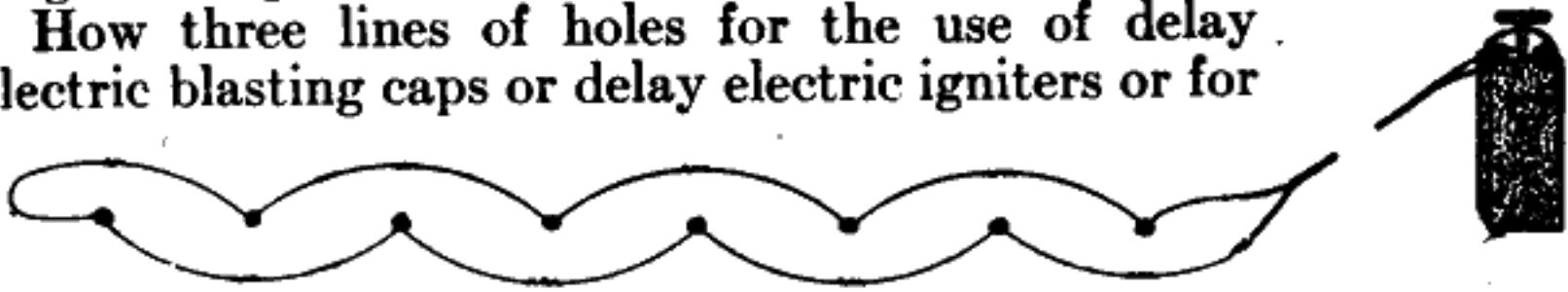


Fig. 50

very wide ditch blasts may be connected in series is shown in Fig. 52. Either single or duplex leading wire may be used.

All blasts to be fired with a blasting machine must

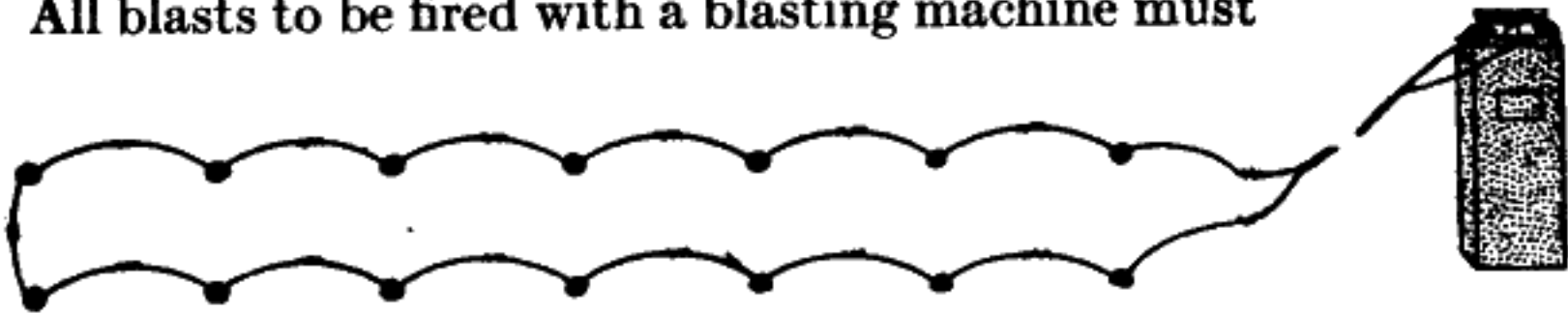


Fig. 51

be connected in series. These series connections may be used with a power or lighting circuit.



Fig. 52

## Wiring Blasting Circuits—Parallel circuits; parallel series circuits

**Parallel Circuits.**—Another method of connecting for electric blasting when power or lighting circuits are used for firing is "in parallel." This type of circuit differs materially from the "in series" circuit, and is shown graphically in Fig. 54 and Fig. 55. For such a circuit the firing current must have  $1\frac{1}{2}$  amperes for each detonator or squib, but the voltage of the current can be less than when the connections of the same number of detonators are "in series."

**Parallel Series Circuits.**—This type of circuit is a number of "in series" circuits, two or more, connected in parallel, as is shown in Fig. 56. It can be used only with a power or lighting current. Such a circuit requires  $1\frac{1}{2}$  amperes for each series, voltage required, if the

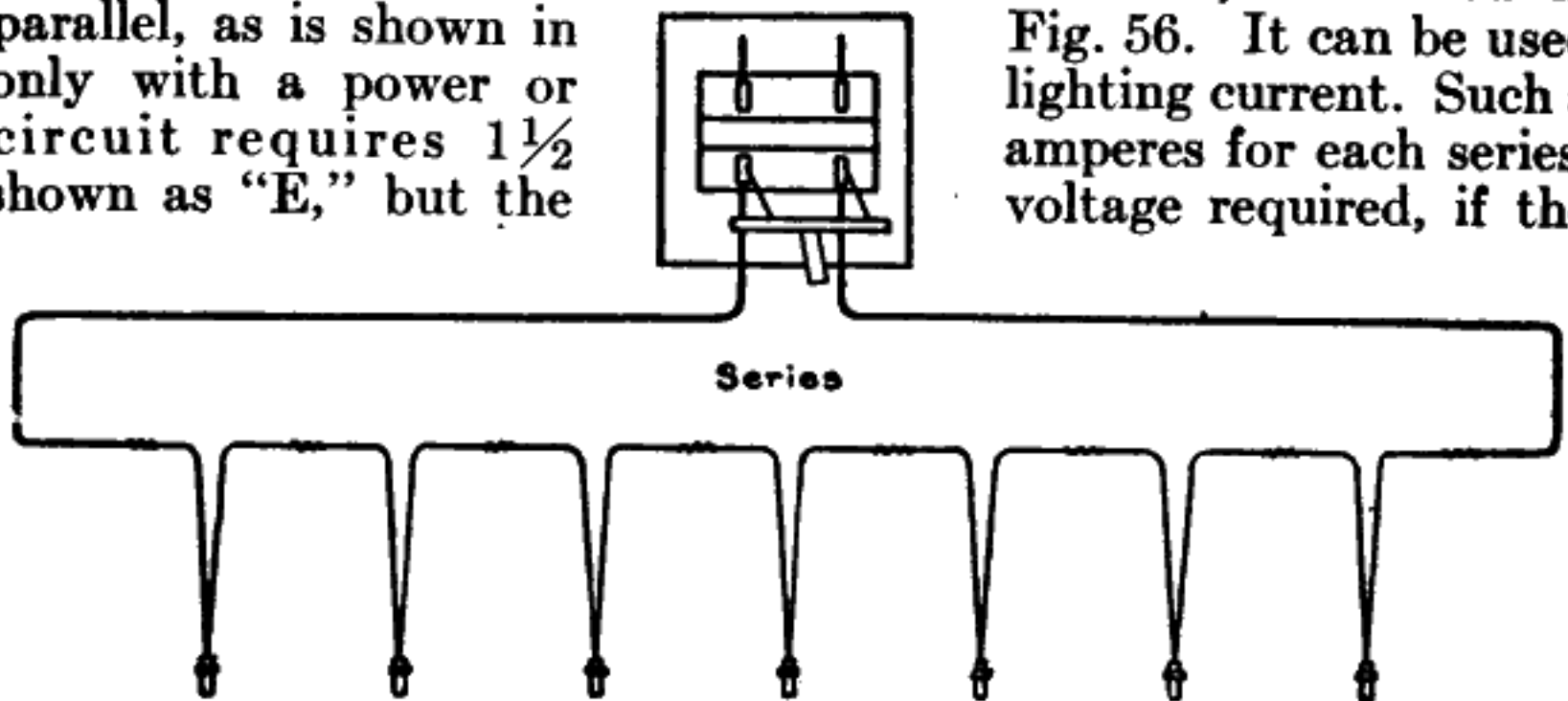


Fig. 53.—Another view of "in series" connection, using a power current.

resistance of the leading wire is neglected, is less than the amount required to overcome the resistance in the series having the greatest resistance. The determination of this point is a slightly complicated mathematical problem for the blaster, and it is best to allow a good margin of safety in the way of too much voltage.

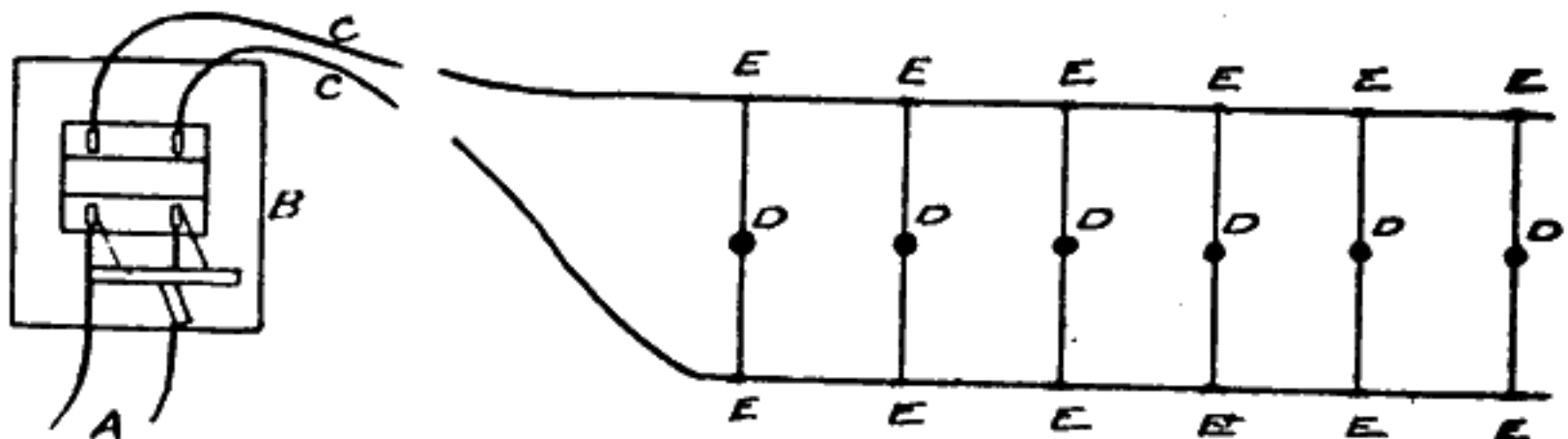


Fig. 54.—Parallel connections. A. Power or lighting circuit. B. Blasting switch for closing circuit. C. Leading wires of sufficient length to keep the switch "B" a safe distance from the blast and to reach to the last hole to be fired. D. Bore holes with electric detonators. E. Connections between the detonator wires from holes "D" to the leading wire "C."

Neither parallel nor parallel series wiring can be used with a blasting machine.

**Wiring Delay Electric Caps, Delay Electric Igniters and Electric Squibs.**—All of these, without regard to their



Testing Blasting Circuits—Du Pont Galvanometer

character or the time of the delay, are wired exactly as has been described for electric blasting caps, the same principles of series and parallel circuits applying in all cases. Care must always be exercised to get the correct delay in the right hole.

**Using Alternating Current.**—When using a power current for blasting, any chance of a building-up effect in the blasting circuit is to be avoided as much as possible. No electric blasting cap is fired in less than .014 seconds. The half cycle or alternation of an alternating current to be used for firing electric blasting caps should be less than this period. Consequently no alternating current of less than 40 cycles should be used to fire a blast by electricity. An alternating current of above 40 cycles can be used in the same manner as a direct current.

**The du Pont Galvanometer.**—This, Fig. 58, is an instrument used by blasters to test individual electric blast-squibs; to determine whether or not a blasting circuit is "closed" condition for the blast, or whether it is "open," be-

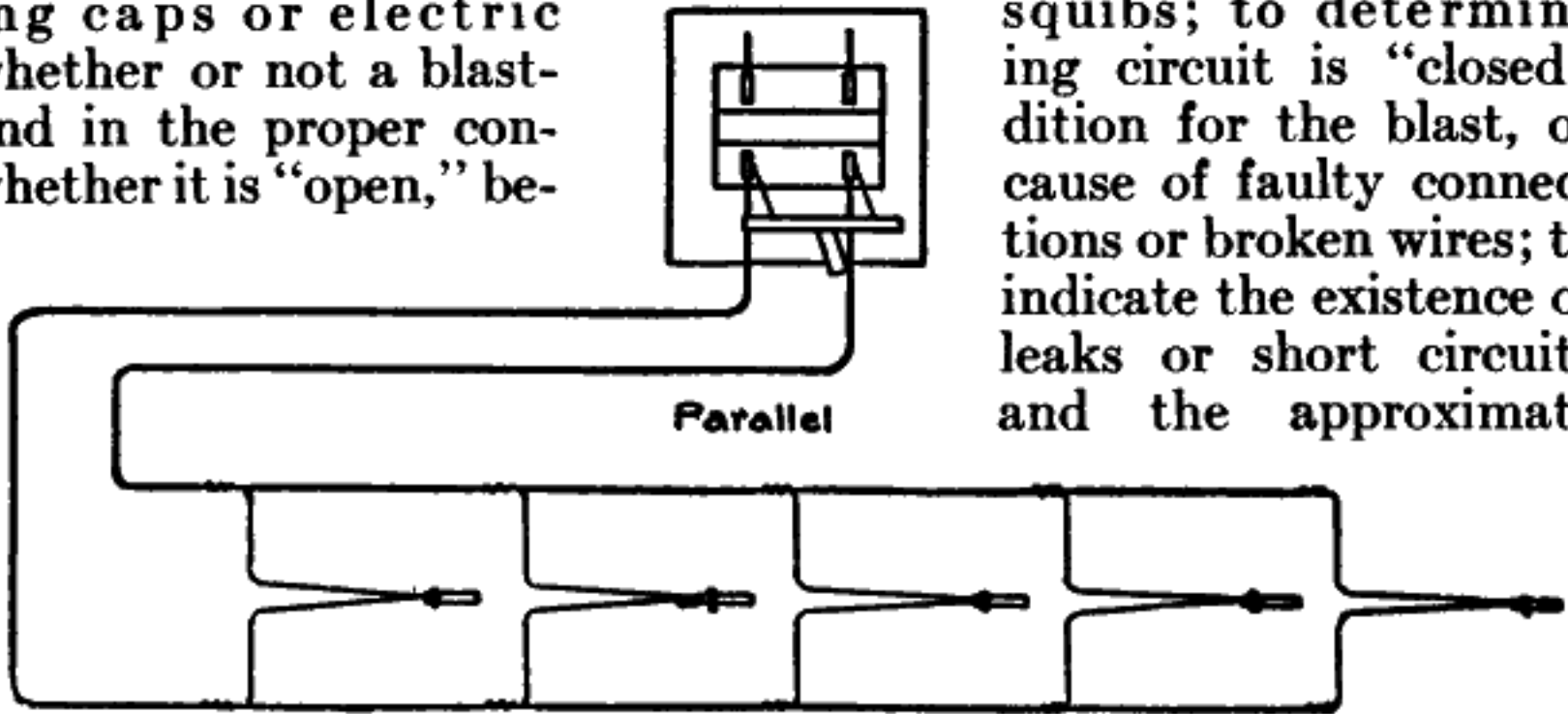


Fig. 55.—Another view of parallel connections. This method cannot be used with a blasting machine.

cause of faulty connections or broken wires; to indicate the existence of leaks or short circuits and the approximate resistance of a circuit.

It is a magnetic device which in use moves a pointer across a scale. The pointer is moved by an electric current from a small

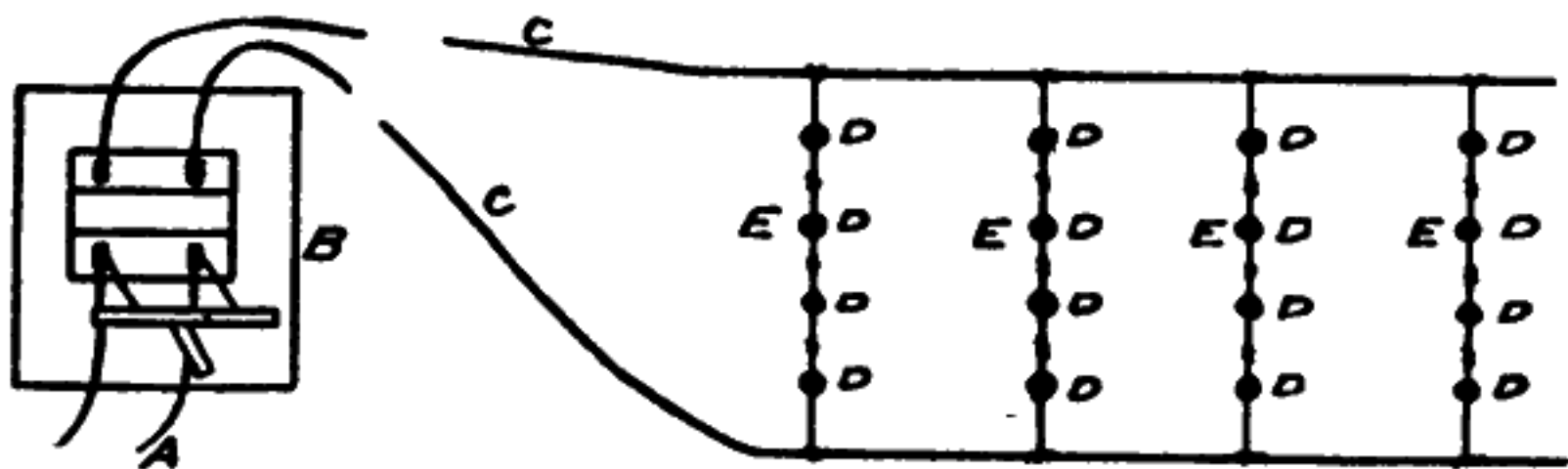
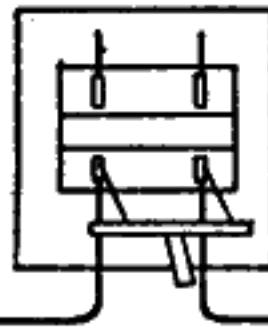


Fig. 56.—Parallel series connections. A. Wires of power or lighting circuit. B. Blasting switch for closing circuit. C. Leading wires of sufficient length to keep the switch "B" at a safe distance from the blast and to reach past the last hole. D. Bore holes with electric detonators. E. Individual series of holes "D."

## Testing Blasting Circuits—Du Pont Galvanometer

chloride of silver dry cell. Two contact posts for connections are conveniently located. It will work in any position. The cell and needle are contained in a leather carrying case, which is small and flat, and



is contained in a case made of leather, which is in turn contained in a carrying case. The instrument is of a convenient size to

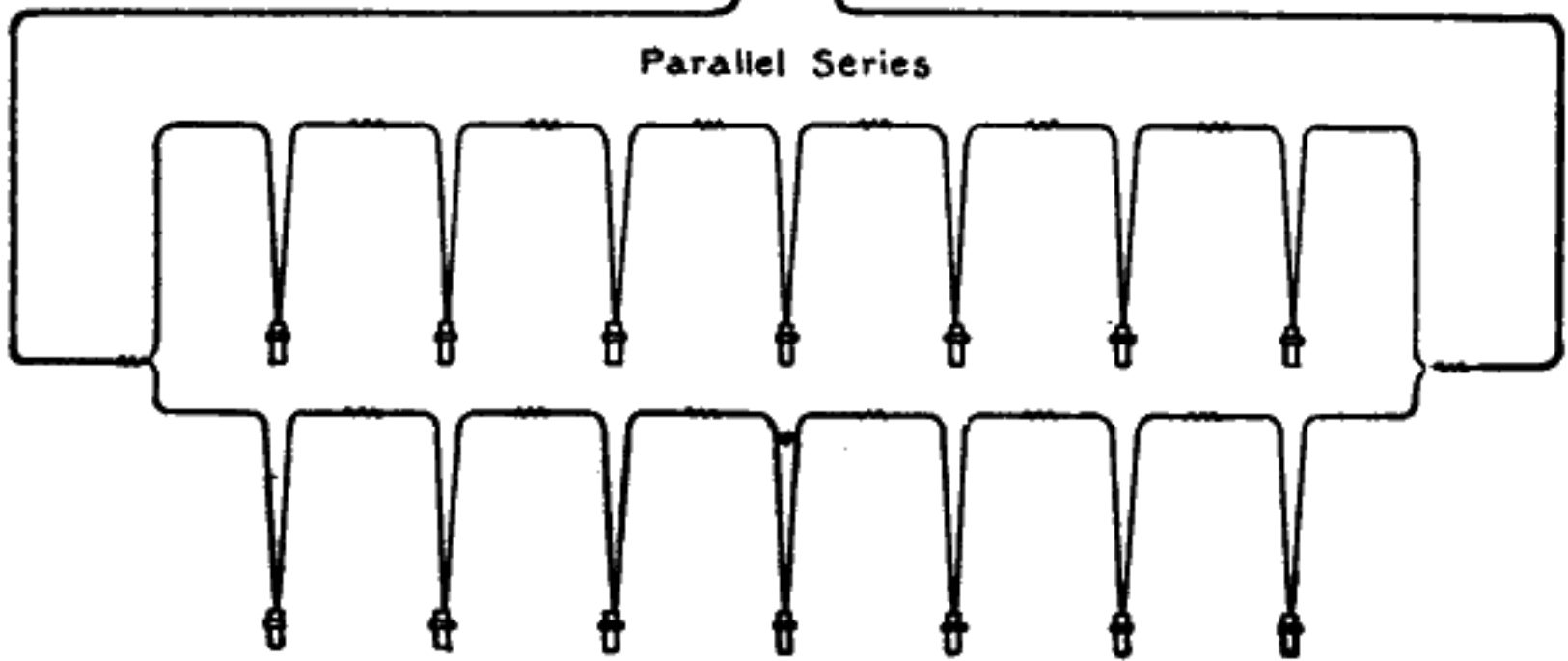


Fig. 57.—Another view of parallel series connections.

carry in the pocket. The battery cell is one selected after a long series of experiments. While of long life and of great constancy, it

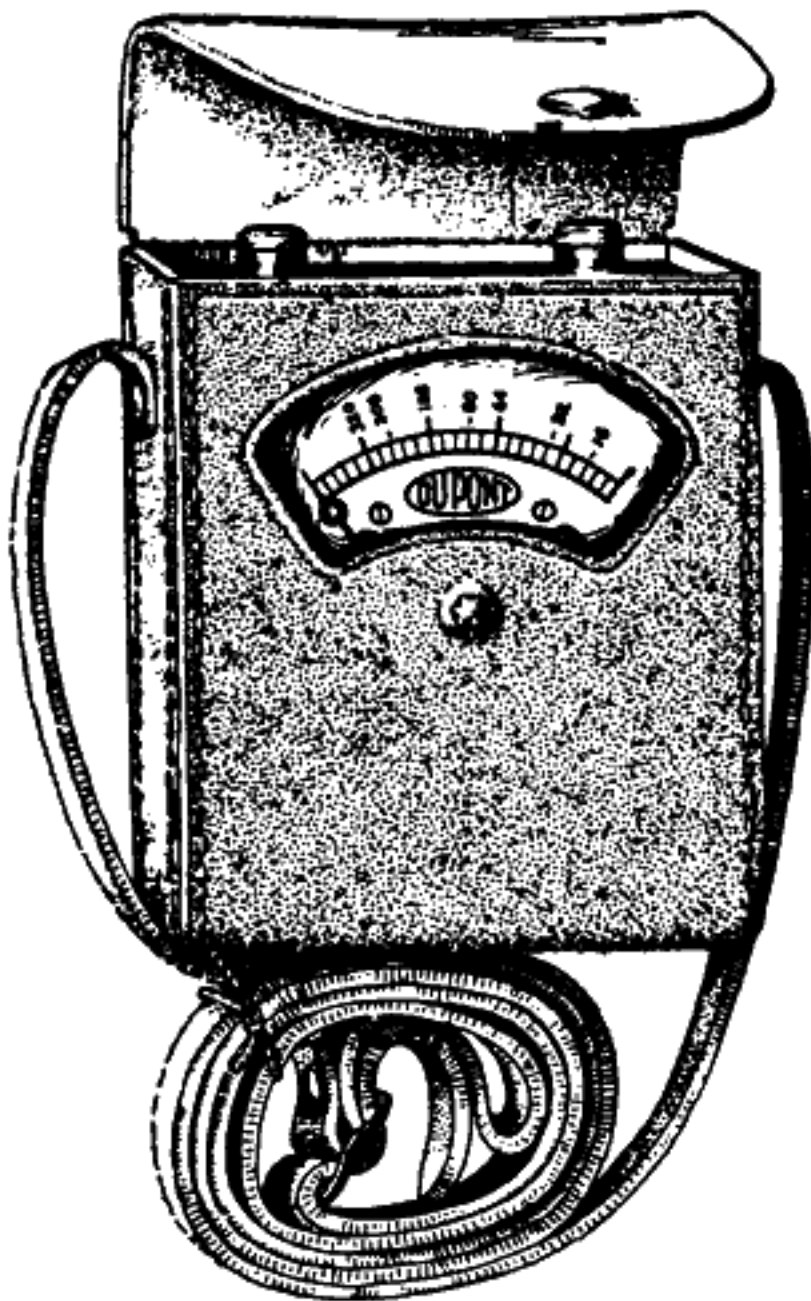


Fig. 58.—Du Pont Galvanometer with carrying case and strap.

is very weak. The current which is sent through an electric detonator when making a test with the assembled instrument is less than one-tenth of the strength required to explode it. The length of time a battery cell will last depends, of course, upon how frequently it is used and how long the current is allowed to flow in making each test. When properly used, one cell is sufficient for several thousand tests. The simple form of connection enables the user to replace the exhausted cell easily with a new one. The cell is very small and light, and can be sent by mail.

In use, the instrument in its leather case is carried by the blaster at his side, slung from the strap which passes over his shoulder. To make a test it is necessary only to touch the ends

of the two wires to the two contact posts. If there is a circuit, the indicator will immediately move over the scale. Breaks are

**Testing Blasting Circuits—Du Pont Galvanometer**

quickly located by following the simple instructions given later. The instrument and the methods of using it are such as apply to the requirements of the practical blaster, as distinguished from the trained electrician, whose finer instruments and methods would be at a disadvantage under the conditions prevailing on the ordinary electric blasting job. Such extremely accurate electrical tests are seldom needed in blasting work.

This instrument is recommended because it is a convenience and a time-saver, and also because the more exact methods which it makes possible not only enable the blaster to secure better execution from explosives, but, most important of all, minimize danger and lessen the risk of blast failures and accidents.

**Testing the Galvanometer.**—The Galvanometer should be tested before being used by placing a short piece of copper wire across its two binding posts. The wire having almost no resistance, the needle should be deflected to its widest limit. If it does not move entirely across the scale, the battery cell is exhausted or weakened and must be replaced by a fresh one. It can be calibrated by comparing its reading with the resistance of a du Pont Rheostat.

**Operation of du Pont Galvanometer.**—The operation of the Galvanometer is quite simple. When a passageway (circuit) is offered, so that the electric current can pass from one binding post to the other, the current from the battery cell flows through this circuit, traversing the Galvanometer coil on the way, causing the pointer to be deflected.

Although the Galvanometer is simple in design, and as substantially made as possible for such an instrument, some of the parts are necessarily of delicate construction. It should, therefore, be handled carefully and kept perfectly dry.

**To Test a Circuit.**—To test a circuit with the Galvanometer, connect or touch the leading wires to its two binding posts, after all connections are ready for the blast. If the current is perfect, the needle will move along the scale. If the needle does not move, or not as far as it should, there is a break in the circuit, or some high resistance like a bad joint.

**To Locate a Break.**—To locate a break, make sure that the ends of the leading wires, to be attached to the blasting machine, are separated and not touching anything (see Fig. 59, page 52). Secure a piece of connecting wire, "N," to one end connection, "D," of the circuit. This wire must be long enough to reach from the joint "D" to joint "C." Hold the bare end of "N" against the contact post "L" and touch contact post "O" either direct or through the second piece of leading wire "M," to the joint "C." If the Galvanometer now shows circuit, while it did not when the test was made from the other end of the leading wires, the break is in the leading wires, and they must be repaired.

Testing Blasting Circuits—Resistance of copper wire; resistance table

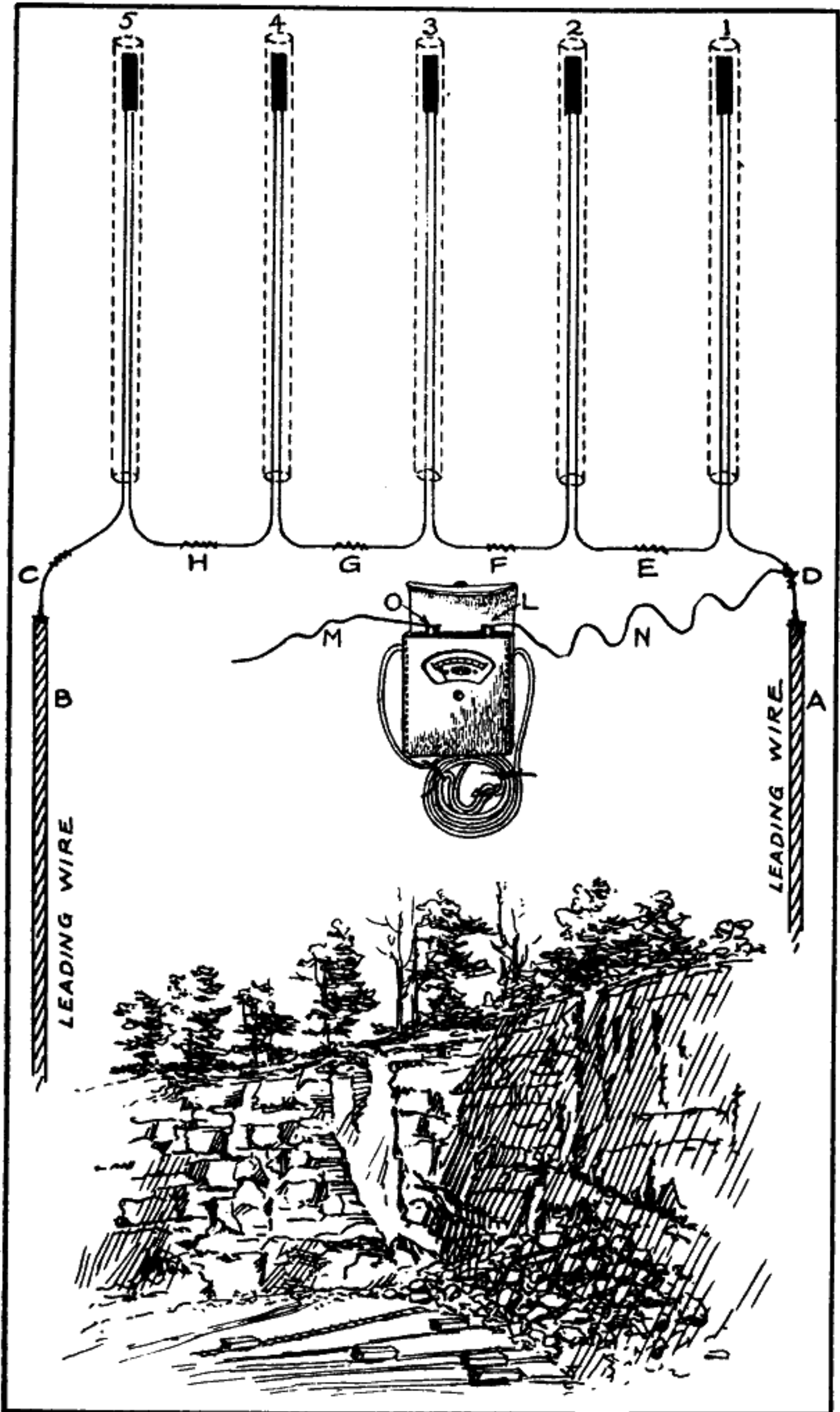


Fig. 59.—Diagram showing method of locating a break with a du Pont Galvanometer.



**Testing Blasting Circuits—Resistance of copper wire**

If it does not show circuit, find the break in the electric blasting cap or connecting wires by touching the contact post, "O" (or the short piece of wire "M," connecting with binding post, "O," whichever is more convenient), to each of the bare joints "E," "F," "G" and "H" in succession. As long as you are "inside" the break, these contacts will cause the needle to be deflected. As soon as you get beyond the break, or point of high resistance, you get either a very slight deflection or none at all. In this way the trouble can be quickly traced to the break or bad joint. For instance, if a wire in bore hole No. 3 is broken, you get a deflection when "O" or "M" is touched to "F" but none on touching "G"; showing that the break is between "F" and "G." The break can then be easily repaired if above the tamping. If below the tamping and there are two electric detonators in the hole, the broken one can be left out of the wiring and the hole fired by the good one.

If there is but one electric blasting cap in the hole and its wires are broken off below the tamping, the hole must be handled as a misfired shot.

Single electric blasting caps can also be tested, both before and after putting them in the bore hole, simply by touching the ends of the electric blasting cap wires to the two contact posts. It is an excellent practice to test all electric blasting caps after finishing the loading, but before tamping the hole, as well as while tamping, if the tamping is several feet deep.

The battery cell in the Galvanometer must be renewed when it is exhausted, and the Galvanometer frequently tested to make sure it is in good working order.

Use no other kind of cell than the chloride of silver cell supplied with the Galvanometer. A carbon cell is dangerous.

**Resistance of Copper Wire.**—B. & S. gauge in ohms per thousand feet of wire.

No. 14 (Leading wire).....	2.531
No. 20 (Connecting wire).....	10.14

When exceptionally long lengths of leading or connecting wire are used in blasting circuits, the resistance should be computed and added to that of the electric detonators to guard against overloading the blasting machine.

**Resistance Table—How to Use.**—The following table gives the resistance of copper and iron wire electric blasting caps, water-proof electric blasting caps, submarine electric blasting caps, delay electric blasting caps, delay electric igniters and electric squibs, singly and connected in series.

The Table of Resistance shows the resistance of a single detonator only. The total resistance of a number of detonators is obtained by multiplying the resistance of one detonator by the total number that are connected in series. If the detonators are connected in other ways, the total resistance of the circuit must be computed by the ordinary methods applying to parallel or parallel series connections.

## Testing Blasting Circuits—Du Pont Blasting Machines

Table of Resistance in Ohms of Electrical Firing Devices

Length of wires of electric firing devices in feet.	Regular copper wire Electric Blasting Caps and duplex copper wire Electric Blasting Caps.	Submarine and Waterproof Electric Blasting Caps with enameled copper wires.	"Panama" Electric Blasting Caps with copper wires only.	Delay Electric Blasting Caps, Delay Electric Igniters and Electric Squibs with copper wires.	Electric Blasting Caps with iron wire.	Electric Squibs and Delay Electric Igniter with iron wire.
4	1.255	1.255	.....	0.935	2.093	1.857
5	.....	.....	.....	.....	2.261	2.000
6	1.343	1.343	.....	1.000	2.448	2.261
8	1.439	1.439	.....	1.068	3.000	2.529
10	1.500	1.500	.....	1.143	3.280	3.000
12	1.608	1.608	.....	1.206	3.690	
14	1.679	1.679	.....	1.272		
16	1.727	1.727	.....	1.325		
18	1.803	1.803	.....	1.400		
20	1.857	*1.479	1.479	1.459		
22	1.913	1.521	1.521	1.521		
24	1.970	1.564	1.564	1.586		
26	2.030	1.631	1.631	1.655		
28	2.093	1.679	1.679	1.727		
30	2.158	1.727	1.727	1.777		

\*Submarine or Waterproof Electric Blasting Caps have 22 gauge wires up to and including 18 ft. 20 ft. and longer wires are 20 gauge.

**Du Pont Blasting Machines.**—Blasting machines are used to generate the current for firing blasts by electricity. All du Pont Blasting Machines, except the pocket size, are small portable dynamos, in which the armature is rotated by the downward thrust of the rack bar, thereby converting muscular energy into electrical energy. They are not magnetos, although they are often erroneously so called.

A magneto has a permanent magnet for a field, whereas the dynamos in the du Pont Blasting Machines have electro-magnets. They are wound somewhat differently from a dynamo built for delivering a continuous current for power or lighting purposes, in that the current in the du Pont Blasting Machines is short circuited through the field magnets for the purpose of building up, intensifying and storing the current until the end of the rack bar stroke, when the whole accumulated current is sent out through the firing line.

They are rated according to the number of electric blasting caps that they can be depended upon to fire when connected in series.

Firing Blasting Circuits—Operating blasting machines

Size of Machine	Maximum Capacity with Leading Wires		Weight in Pounds		
	30 ft. Copper Wire Electric Blasting Caps	8 ft. Iron Wire Electric Blasting Caps	Gross	Net	Tare
Pocket	4	4	6	4½	1½
No. 2	10	7	22	16½	5½
No. 3	30	22	33	25½	7½
No. 4	50	39	50	45	5
No. 5	100	75	75	58	17
No. 6	150	112	53	42	11

**Operating a du Pont Push-Down Blasting Machine.**—To operate the push-down blasting machine, set it squarely on a solid, level place, connect up the wiring as is pointed out on pages 45 to



Fig. 60.—Operating a push-down Blasting Machine.

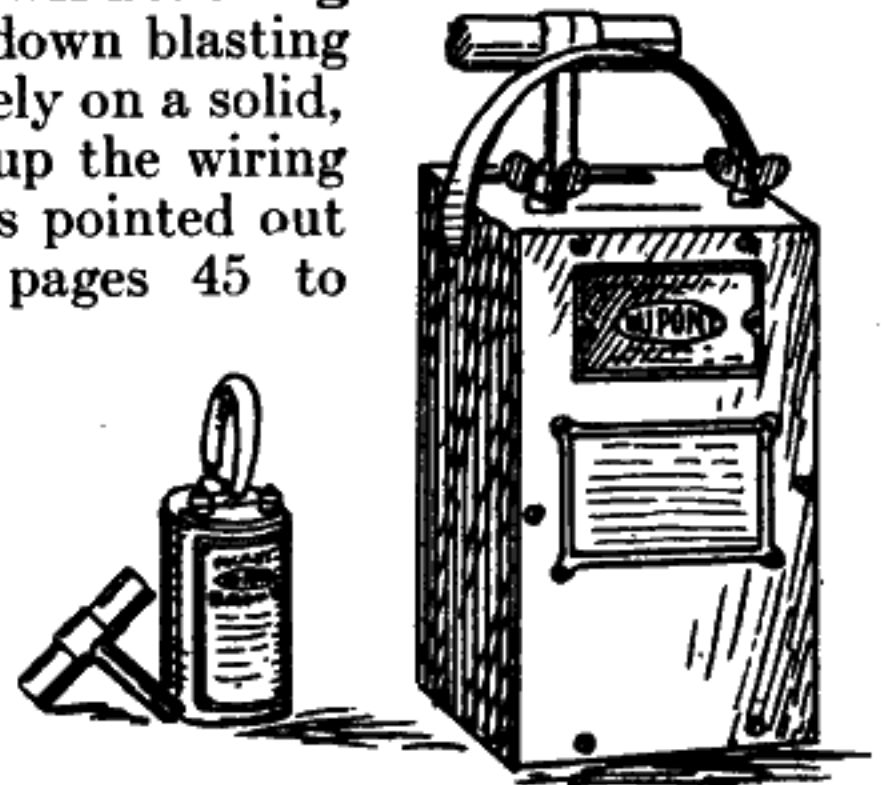


Fig. 61.—Showing the two types of Blasting Machines.

49, lift up the rack bar by the handle (No. 34, Fig. 63) to its full extent, and with one quick, hard stroke push it down to the bottom of the box with a solid thud, using both hands. "Try to knock the bottom out of the machine."

As the rack bar approaches the bottom, it becomes more difficult to operate, because of the "building up" of the current; but the speed of the thrust should not be diminished, because the

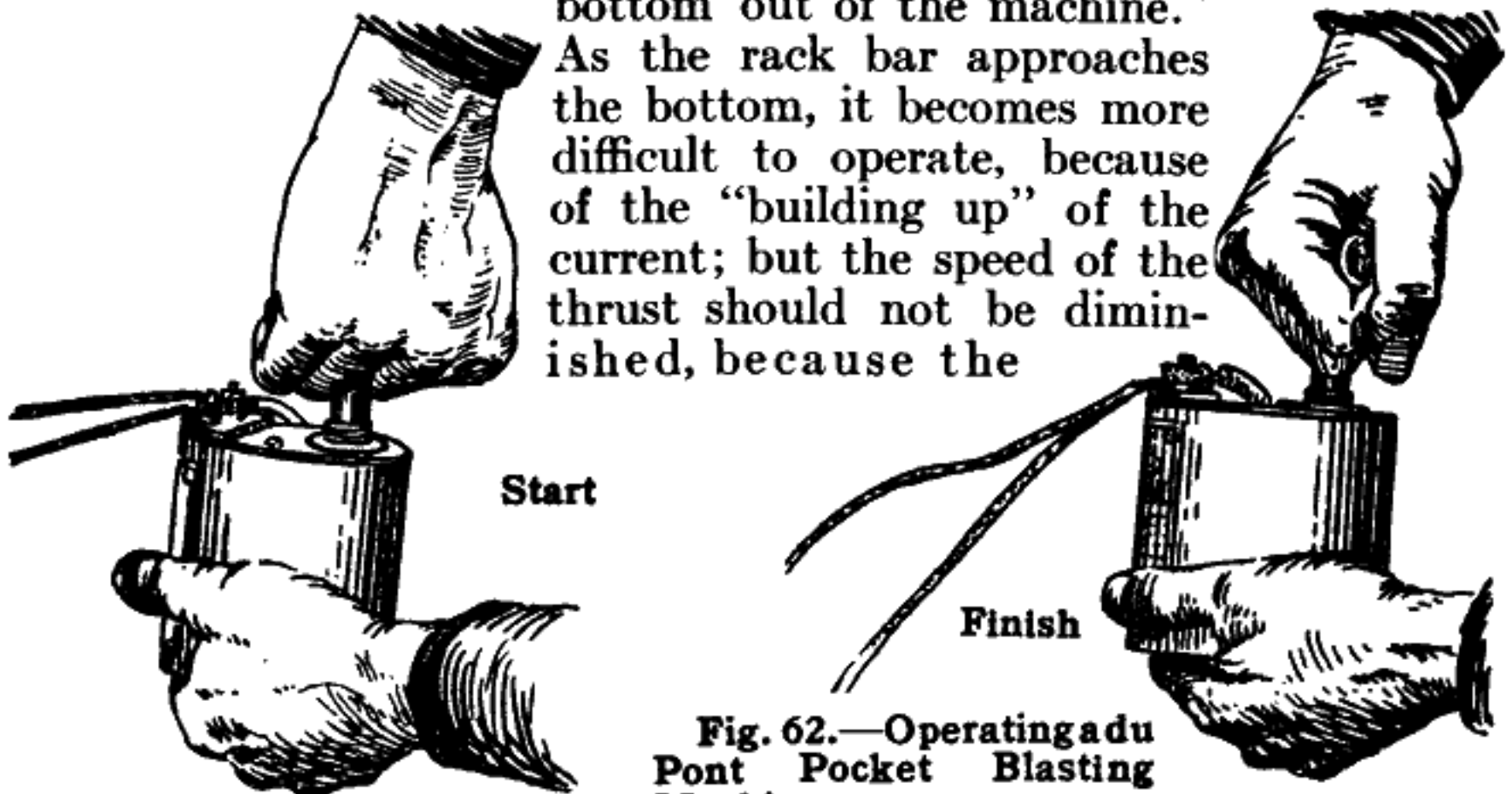


Fig. 62.—Operating a du Pont Pocket Blasting Machine.



**Firing Blasting Circuits—Operation and care of blasting machines**

finish of the operation is just as important as the start. Do not be afraid of pushing the rack bar down too hard. The machine is built to stand it, and this is the only way to use it successfully.

**Operating a Pocket Blasting Machine.**—To operate the du Pont Pocket Blasting Machine, remove the carrying handle from the screw socket and insert the firing handle so that the slot engages with the crosspiece. Hold the bottom of the machine in the left hand, with the binding posts away from you. Grasp the handle with the right hand, with the back of the hand toward you. After the wires are connected, and when ready to fire, give the handle a quick, hard twist to the right (clockwise)—the quicker the twist, the more current is developed.

**Care of Blasting Machines.**—Du Pont Blasting Machines are strongly made, and will stand with little deterioration the treatment to which it is necessary to subject them. Their mechanism, though designed as simply as possible, is more or less complicated and delicate. They will withstand the usage to which it is necessary to put them, but they must be treated with at least some consideration. There can be no possible excuse for throwing a blasting machine about, or permitting it to remain exposed to wet weather or lying in the mud. When a blasting machine is treated in this way, its life will be short and its usefulness limited.

Remember that good care will prolong the usefulness of the blasting machine, will reduce the necessity for repairs and will help to maintain its efficiency. The bearings and gearings should be lightly oiled occasionally, but on the commutator, which is the small copper-covered wheel on the end of the armature shaft (see

16 in Fig. 63), use a little graphite, but never use oil. See that the two slots cut in the copper part of the commutator are clean, and with no particle of metal or anything else in them which might cause a short circuit. Keep the copper brushes clean, and see that they bear firmly on the commutator. Keep the circuit-breaking contacts clean and bright.

When a blasting machine is not in use, store it in a dry and comparatively cool place; not in a leaky tool box or on top of a boiler.

Every blasting machine is tested thor-

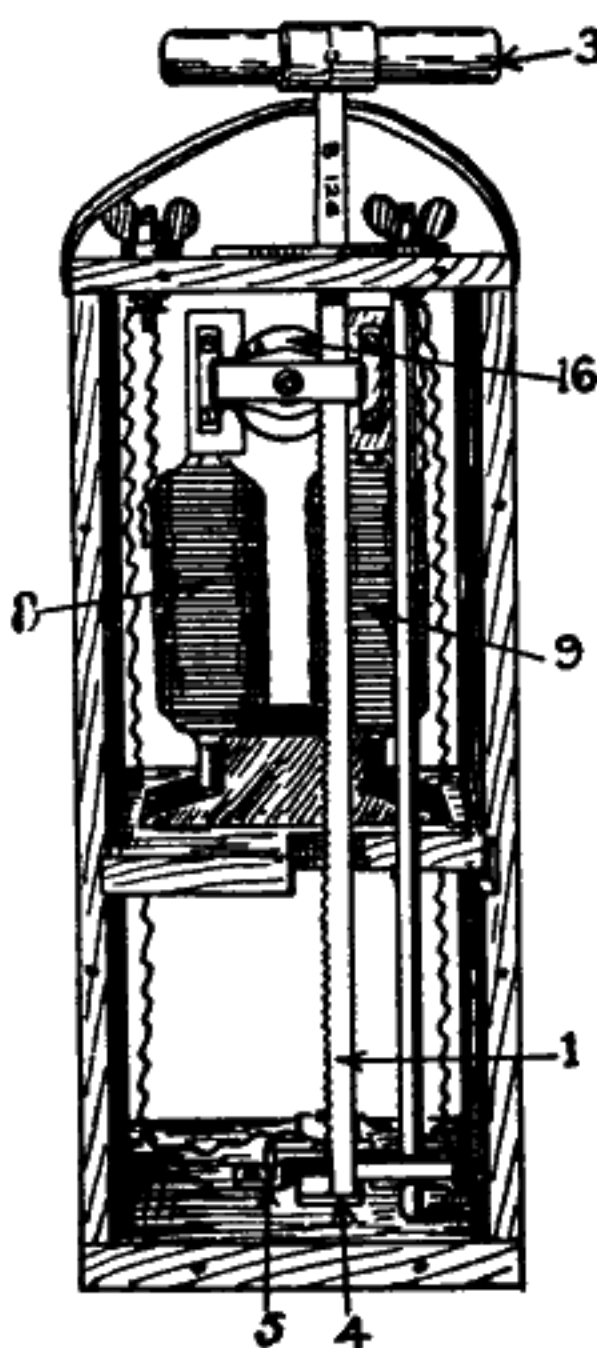


Fig. 63.—Working parts of a push-down Blasting Machine. 1, rack bar, showing teeth which engage the pinion; 4, 5, the contact spring 4, which, when struck by the bottom of the descending rack bar, breaks the contact between two small platinum contacts, one on the upper face of the contact spring 4, and the other on the under side of the bridge 5, and in this way throws the entire current through the outside circuit, that is, leading wire, electric blasting caps and connecting wire; 8, 9, field magnets; 16, revolving armature; 34, rack bar handle.



### Firing Blasting Circuits—Du Pont Rheostat for testing blasting machines

oughly before leaving the works. If a new one does not give satisfactory results when received, it is probable that the machine is not being operated properly or has been injured by rough handling during transportation.

Every blasting machine should be tested occasionally with a rheostat.

**Du Pont Rheostat.**—This is a simple little instrument used for testing the efficiency of blasting machines in an economical and positive manner.

One way to test a No. 2 Blasting Machine, which has a capacity of ten electric blasting caps, is to connect ten electric blasting caps in series and then to the blasting machine and operate the machine. If all the electric blasting caps fired, the machine would be working up to its rated capacity; if the electric blasting caps did not fire, the machine would not be up to standard. This method of testing is illustrated in Fig. 64. The results obtained would be absolutely accurate. The objection is to the use of so many electric blasting caps, especially if a No. 5 or 6 Blasting Machine were being tested, when one hundred or one hundred and fifty electric blasting caps would be required for the test. This would cause needless expense. The firing of so many electric blasting caps in the open would be dangerous.

To obviate this expense, the du Pont Rheostat is substituted for all but one of the electric blasting caps, as is indicated in Fig. 65, the wires X and Y being connected to the proper posts to give a resistance equal to the number of electric blasting caps desired.

When such a series connection is made and the blasting machine operated, the single electric blasting cap either fires or does not fire, and thus indicates whether or not the blasting machine is up to capacity. An electric squib can be used instead of an electric blasting cap.

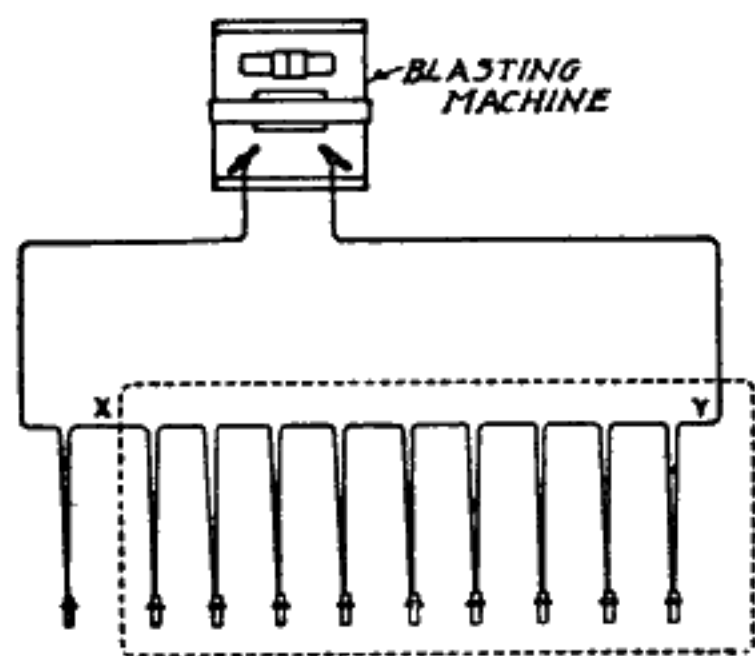


Fig. 64.—Testing a Blasting Machine without a Rheostat.

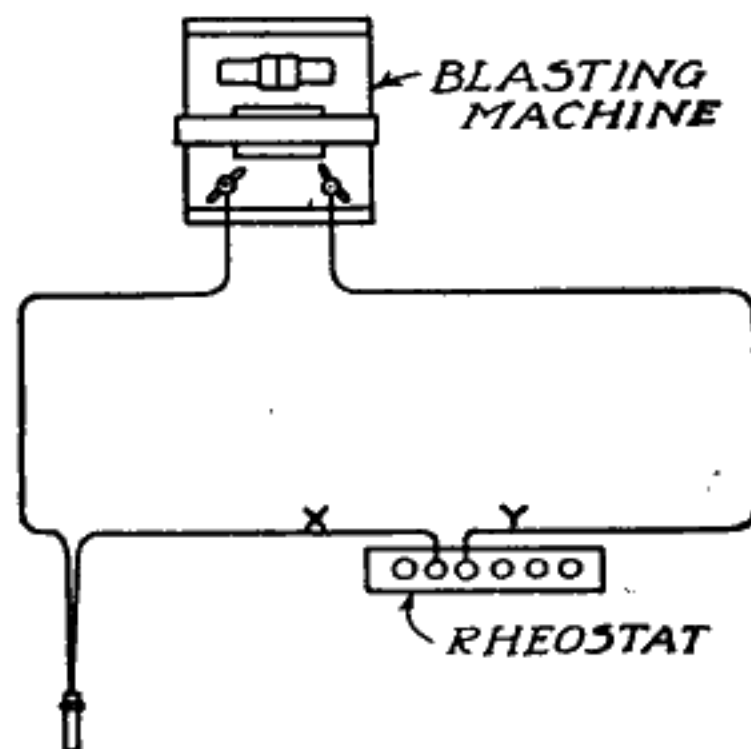


Fig. 65.—Testing a Blasting Machine with a Rheostat.

The internal construction of the Rheostat is shown diagrammatically in Fig. 67. It is an arrangement of coils of high-resistance wire of a certain length, with the binding posts 1 and 6 attached to

### Firing Blasting Circuits—Du Pont Rheostat for testing blasting machines

its ends, and the binding posts 2, 3, 4 and 5 attached to it at intermediate points. The entire length of the resistance wire in the Rheostat has a resistance sufficient to represent a test of one hundred 30-foot electric blasting caps, with a factor of safety to allow for the leading wire, connecting wire and all connections in the blasting circuit.

It will be noted in Fig. 67 that the binding posts, 1, 2, 3, 4, 5, and 6, are not attached to the resistance wire at equal distances. The purpose of this is to afford different resistances between different binding posts, each representing a test of a certain number of electric blasting caps. If wires X and Y are attached to binding posts 1 and 2, the test represents a test of five electric blasting caps; if to posts 2 and 3, of ten electric blasting caps; to posts 3 and 4, of twenty electric blasting caps; or to posts 4 and 5, of twenty-five electric blasting caps. But the wires X and Y need not be attached to adjoining posts. If, for instance, they are



Fig. 66.—Rheostat.  
Dimensions.....  $\frac{3}{4}$ "x $1\frac{3}{4}$ "x $4\frac{3}{8}$ ".  
Weight..... 5 oz.

attached to posts 1 and 4, the test represents the sum of the intervening numbers, five, ten and twenty, or a total of thirty-five electric blasting caps.

By a study of the numbers stamped on the hard rubber between the posts, it will be found that many combinations of tests ranging from five to one hundred electric blasting caps can be easily secured. When it is desirable to make tests, less, by units of five, than is indicated between any combination of post (say between 1 and 5), the reduction is made by connecting two posts by means of a coin or thick wire. If the wires X and Y, Fig. 65, were connected to posts 1 and 5 and a coin inserted between posts 2 and 3, the total of the test would be 60 less 10, or 50.

Should it be necessary to test a blasting machine for ninety detonators, the resistance of ten, between posts 2 and 3, must be blocked out. This is done by connecting these posts by means of a piece of heavy copper wire or a coin. In this way the resistance

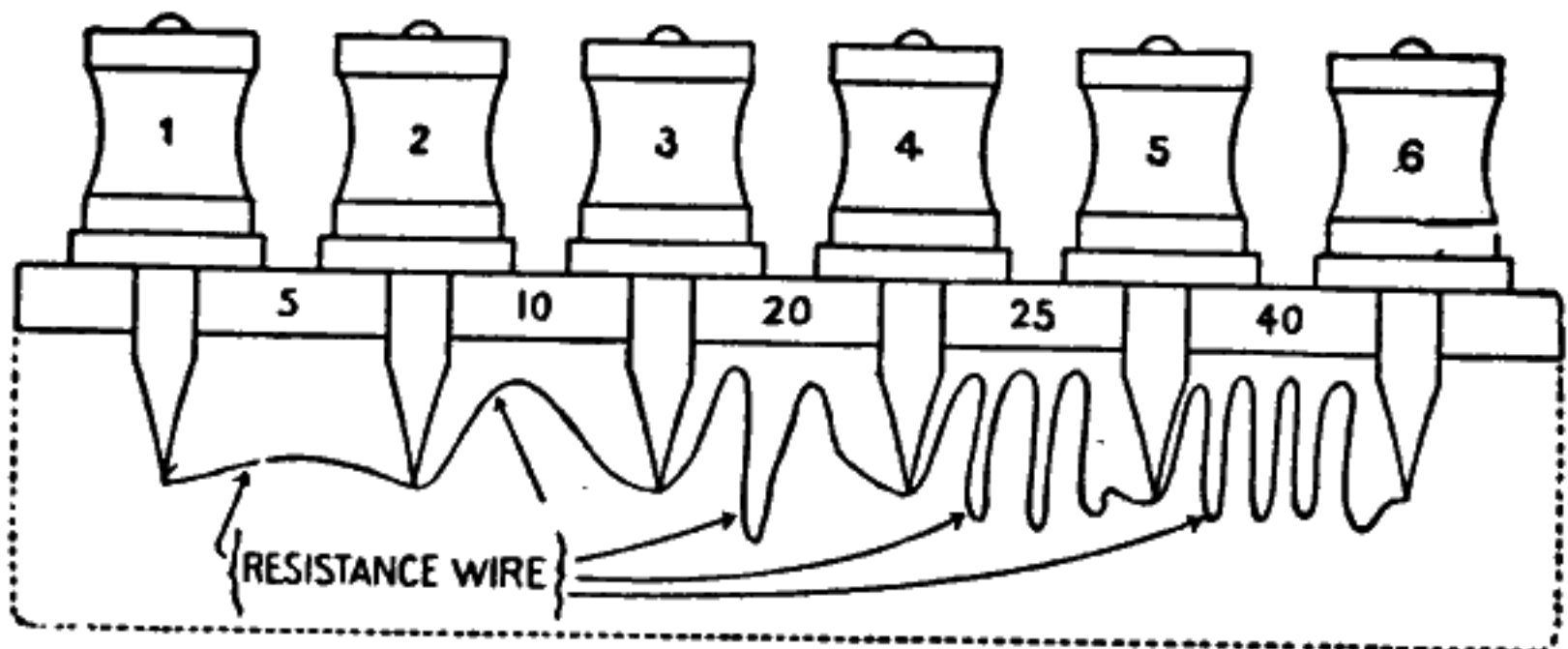


Fig. 67.—Diagram of construction of a Rheostat.

**Firing Blasting Circuits—Du Pont Rheostat for testing blasting machines**

between any two posts can be subtracted from the total resistance or the resistance between any two posts outside of the two that are blocked out.

The resistances in the Rheostat are based on 3.2 ohms per unit of resistance, this being the resistance of a 12-foot copper wire electric blasting cap with a factor of safety of 2. If the electric blasting caps in use are of shorter lengths, it will be possible to fire a greater number than this test will indicate, even, in some cases, up to twice the number. On the other hand, there may be circumstances which will cut down the number that can be fired below what the Rheostat test will indicate. Chief among these is leakage of electric current in some part of the blasting circuit, either from bare joints or wire touching damp ground, or other conductors, or from fluids of great penetrating qualities coming in contact with the insulation of the wires for too long a time before firing. Of these fluids, the worst are the strong saline liquids, even though they be in small amounts, and the bore-hole washings in certain kinds of rock. If the electric blasting caps differ greatly in sensitiveness to the firing current, this will also cut down the number that can be depended upon to fire simultaneously.

When testing blasting machines having capacities of more than one hundred detonators, two Rheostats are used in series.

Be sure to use only one electric detonator in testing a blasting machine with a Rheostat.

**Table of Resistances of Rheostat in Ohms**

The resistances furnished between the different posts of the Rheostat are as follows:

Between 1 and 2.....	16 ohms
Between 2 and 3.....	32 ohms
Between 3 and 4.....	64 ohms
Between 4 and 5.....	80 ohms
Between 5 and 6.....	128 ohms
Between 1 and 3.....	48 ohms
Between 1 and 4.....	112 ohms
Between 1 and 5.....	192 ohms
Between 1 and 6.....	320 ohms
Between 2 and 4.....	96 ohms
Between 2 and 5.....	176 ohms
Between 2 and 6.....	304 ohms
Between 3 and 5.....	144 ohms
Between 3 and 6.....	272 ohms
Between 4 and 6.....	208 ohms

**MAKING BORE HOLES**

The openings or cavities into which explosives are loaded are known as "bore holes." These may be anything from a shallow, hand-drill hole in a boulder to a deep, well-drill hole or a tunnel many feet long.

**Making Bore Holes—Soil punch; soil auger; coal auger**

The great variety of bore holes needed for different classes of loading demands the use of different types of drills or other devices.

**Soil Punch.**—For shallow holes in clay, soft shale and hardpan the soil punch made of 1½-inch round or hexagonal tool steel drawn at one end to a pencil point (Fig. 68) is most serviceable. This should seldom be longer than 4 feet. It is driven into the ground with sledges and loosened by pounding on the side. In extreme cases it can be drawn up by means of a chain and lever. It is suitable for making bore holes for cuts in hard ground, for pole hole blasts, for ditching and for almost all kinds of agricultural blasting.



Fig. 68.—Soil punch or drill for making bore holes in clay, hardpan and rotten shale.

**Soil Auger.**—For making bore and test holes and deepening other holes in clay a 1½ or 2-inch auger having an extension handle of ¾ or ½-inch gas pipe in 3 foot sections is useful. (Fig. 69.) This is always used by hand. When dry soil does not stick to the twist of the auger and falls back into the bore hole, a little water poured into the hole will quickly overcome the difficulty.

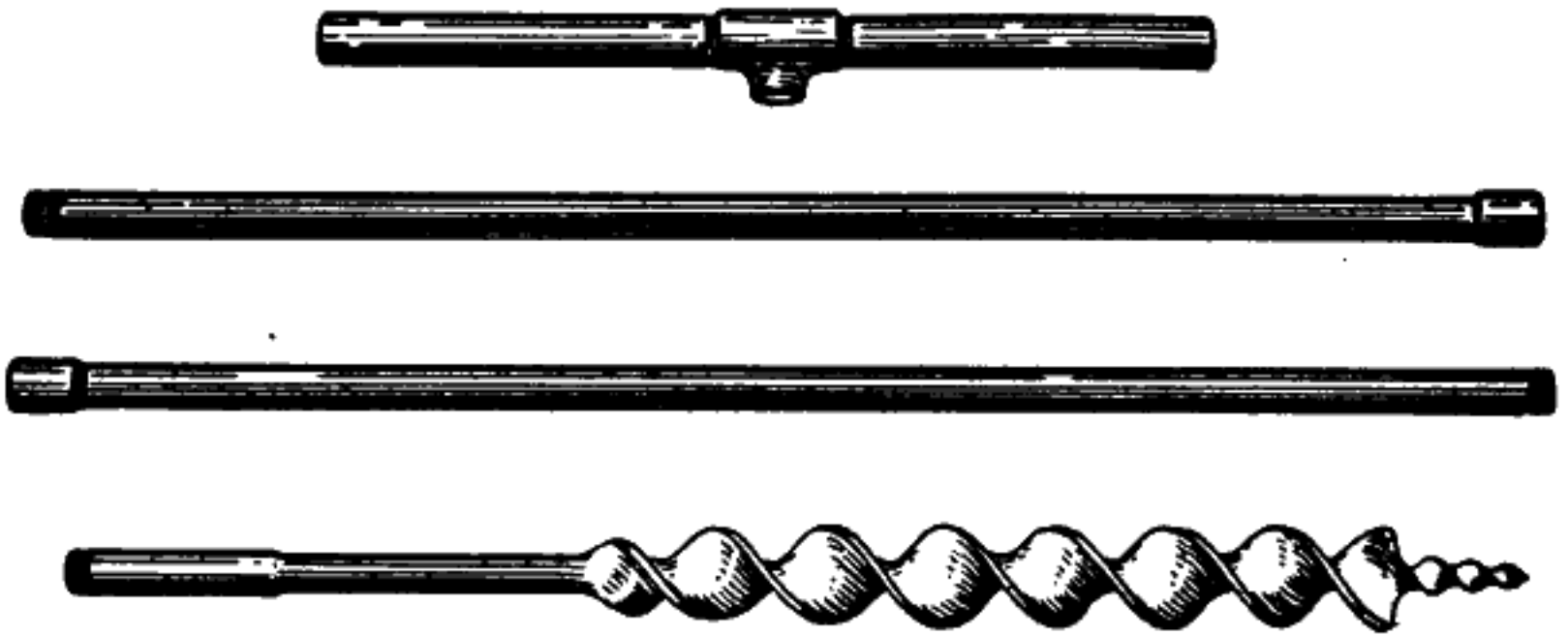


Fig. 69.—Soil auger for making test holes in soft ground and for deepening holes started with a soil punch.

**Coal Auger.**—Bituminous coal is usually drilled for blasting by means of rough adaption of the ordinary brace and bit. The auger itself is usually about six feet long and has a peculiarly shaped cutting edge which can be readily kept sharp by filing. It is screwed into the brace, which is worked with both hands while being held against the miner's body.

Power drills run by either electricity or compressed air are used in harder coal, such as anthracite. The bit is similar to the hand drill bit, and the drill may be supported on a column or crossbar, with a power feed under the control of the drill runner.



### Making Bore Holes—Hand, churn, hammer and tripod drills

**Hand Drill.**—For a few holes in hard material, the ordinary drill and sledge (Fig. 71) are still used. Where there is much work a power drill will prove more economical. For single-handed work a hammer weighing from 3 to 4 pounds is ordinarily used, while in double-handed work one man holding the drill and one striking, a 7 to 8 pound sledge is more satisfactory. These holes are seldom over five feet deep and one inch in diameter.

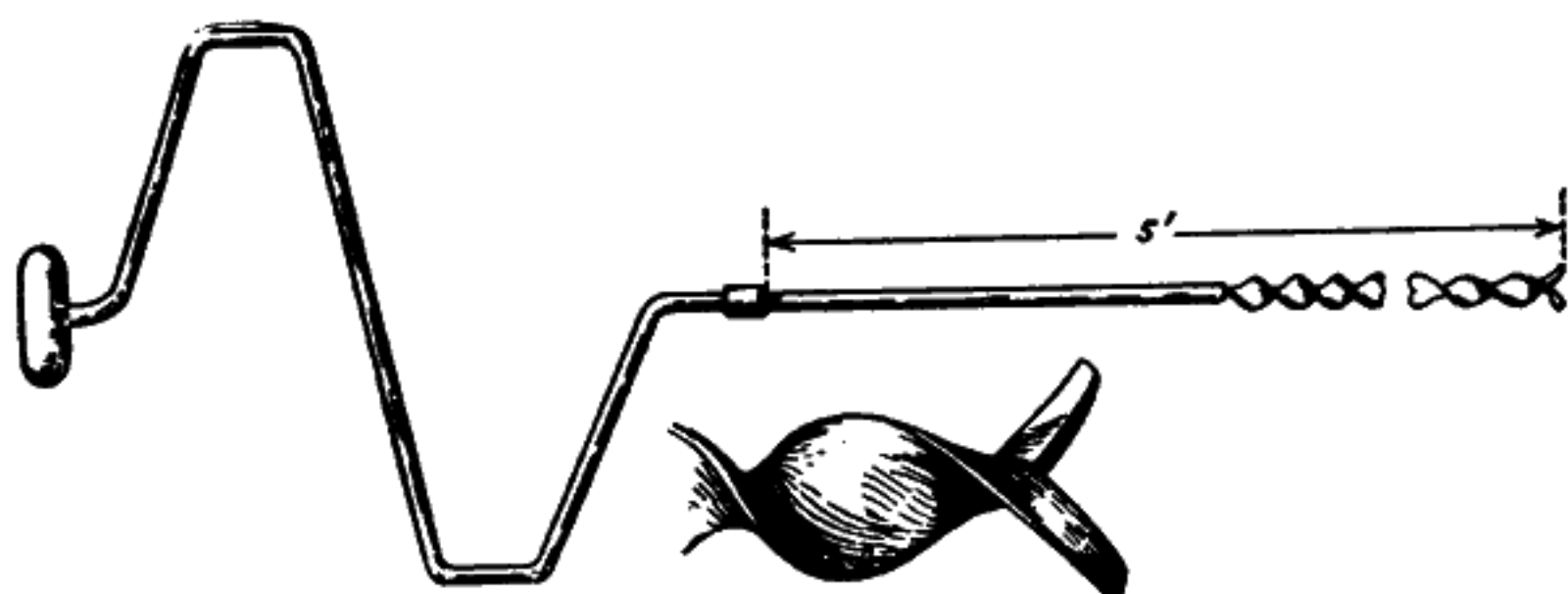


Fig. 70.—Coal auger for making bore holes in coal and shale.

**Churn Drill.**—A churn drill made of a solid piece of drill steel from  $\frac{7}{8}$  to  $1\frac{1}{2}$  inches in diameter or of a drill bit on to the shank of which a gas pipe is shrunk is effective for putting down deep holes in all classes of material. The drill should be long to give it the necessary weight and to reach to the bottoms of deep holes. It is operated by hand, being lifted up and dropped back into the hole. The hole must be kept partly filled with water while the drilling is in progress. The bit or cutting edge of the churn drill is similar to the hand drill.



Fig. 71.—Hand drill and drilling hammer.

**Hammer Drill.**—This drill (Fig. 72), which is usually operated by compressed air, is most serviceable for drilling holes up to 10 feet in depth, and finds ready use in all kinds of rock blasting from railroad cuts, shafts, tunnels and similar heavy work, to blasting field and road boulders. The drill is comparatively light and easily carried. The required air is furnished by a portable compressor (Fig. 77), when a stationary compressor outfit is not convenient.

**Tripod Drills.**—These, both the piston and hammer type, find their readiest use in heavier work than that to which the light hammer drill is suited. (Fig. 73.) They drill larger holes, from 1 to 3 inches in diameter, can work to greater depths, and even under water. Either steam or compressed air can be used to

**Making Bore Holes—Mounted drills; well drills**

Fig. 72.—Hammer drill on road work.

furnish the power. Their chief use is in quarry, railroad and canal construction, heavy cuts and similar work.

The same type of machine mounted on a column or crossbar and driven by compressed air is used in tunneling. Sometimes two machines are mounted on the same column or bar.

**Mounted Drills.**—A slight modification of the mounting permits the hammer or piston drill to be mounted on a vertical column or horizontal bar in a tunnel or shaft. (Fig. 75.) This permits rapid drilling, and is much used in tunneling and sinking operations.

**Well Drills.**—These machines find their chief use in quarries, railroad and canal construction, pits and cuts where high faces or ledges are to be blasted down. (Fig. 74.) They drill holes from 4 to 12 inches in diameter,  $5\frac{5}{8}$  inches in diameter being the most common, and to almost any required depth. They can be used for vertical holes only. The large diameter of the holes drilled gives the blaster the opportunity of distributing the explosive to the best advantage.

Well drills may be operated by steam, electric, or gasoline power.

**Care of Drill Bits.**—In addition to the attention that drills and drilling machinery should have from the standpoint of efficiency, care should be taken that the wear on the bit is watched so that the gauge does not fall below the size corresponding to the diameter of the dynamite cartridges. A lazy drill runner will usually allow his drill bit corners to wear to such an extent that the dynamite will with difficulty go to the bottom of the bore hole. This is likely to cut down the useful work of the explosive—for instance, where the cartridge cannot be placed in the bottom of the hole—and is always dangerous.

**Tunnels for Blasts.**—These tunnels are sometimes called gopher holes, or coyote holes. In some instances, it is desirable to concentrate large charges of low-grade powders under the rock in blasting down a large tonnage of material. This is especially true in quarries, open-work mines, and heavy side hill cuts,

### Making Bore Holes—Tunnels for blasts; pumps and spoons for bore holes

where the nature of the rock is such that it is impossible to shape perpendicular faces, the face always assuming a decided slope; or where the stratification of the rock makes well drilling difficult and expensive; or where small but deep drill holes cannot be sprung. This method of loading overcomes these troubles, and, in many kinds of stone, such as jetty stone, is an ideal method of loading for breaking down large fragments. It is used much more extensively in the

west than in the east. The tunnels are usually horizontal,

about 3 by 4 feet in section, and are driven in much the same manner as standard tunnels, except that the depth of drill holes and the number of holes in a "round" are less. For method of driving tunnels, see page 122. If conditions permit, better confinement and action will be obtained if the explosive charges are placed in pits sunk below the level of the tunnel floor.

Short flat holes of large diameter approximating gopher holes in softer material are often made by the use of a long chisel-pointed bar and a long-handled spoon or hoe.

**Pumps and Spoons for Bore Holes.**—In drilling downwardly inclined holes, water is used to lubricate the hole producing a mud with the spoil made by the drill bit. To facilitate drilling, this mud must be removed from time to time. In deep vertical



Fig. 73.—Tripod drill at work.

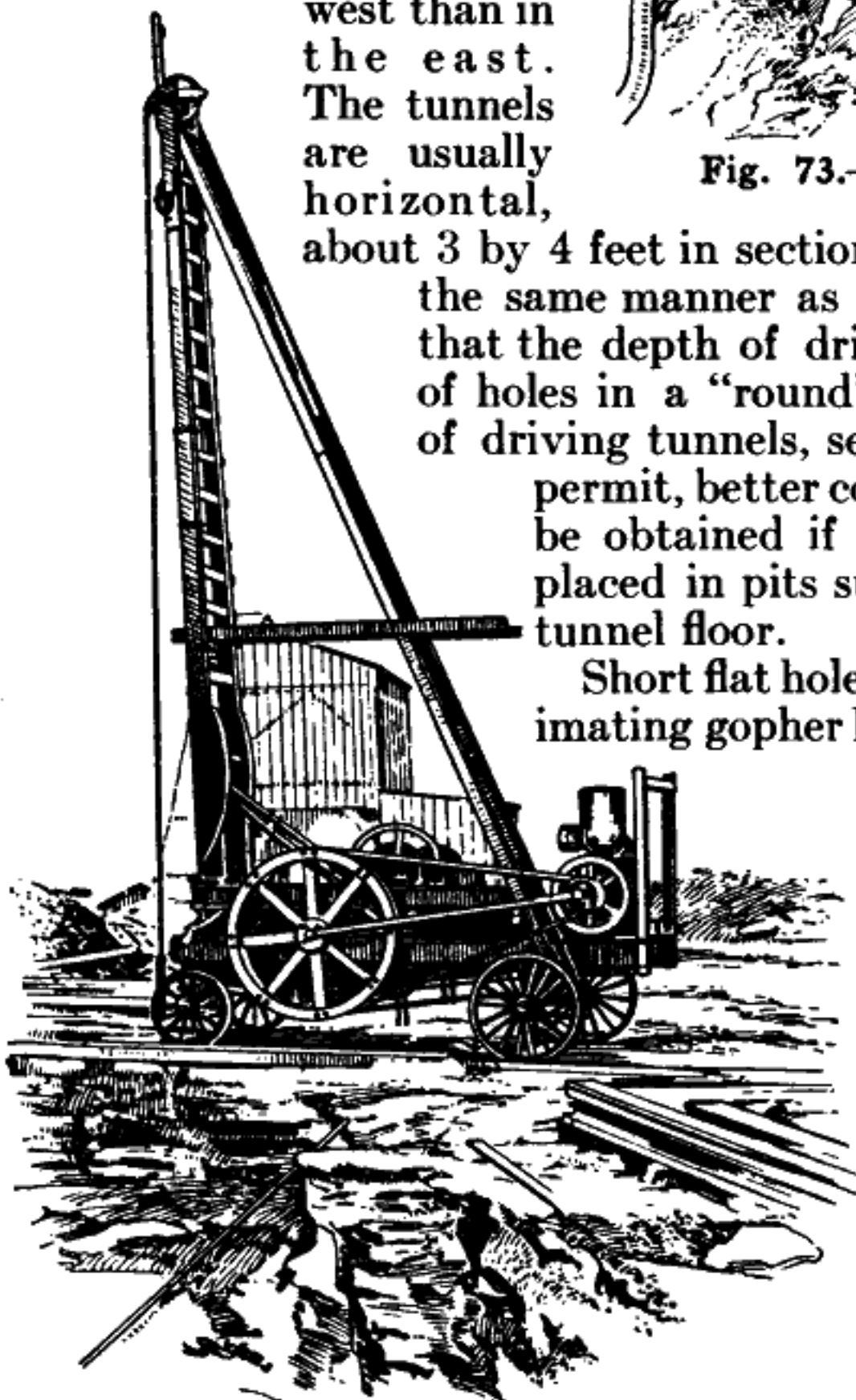


Fig. 74.—View of a well drill for making deep blast holes.



## Making Bore Holes—Springing bore holes

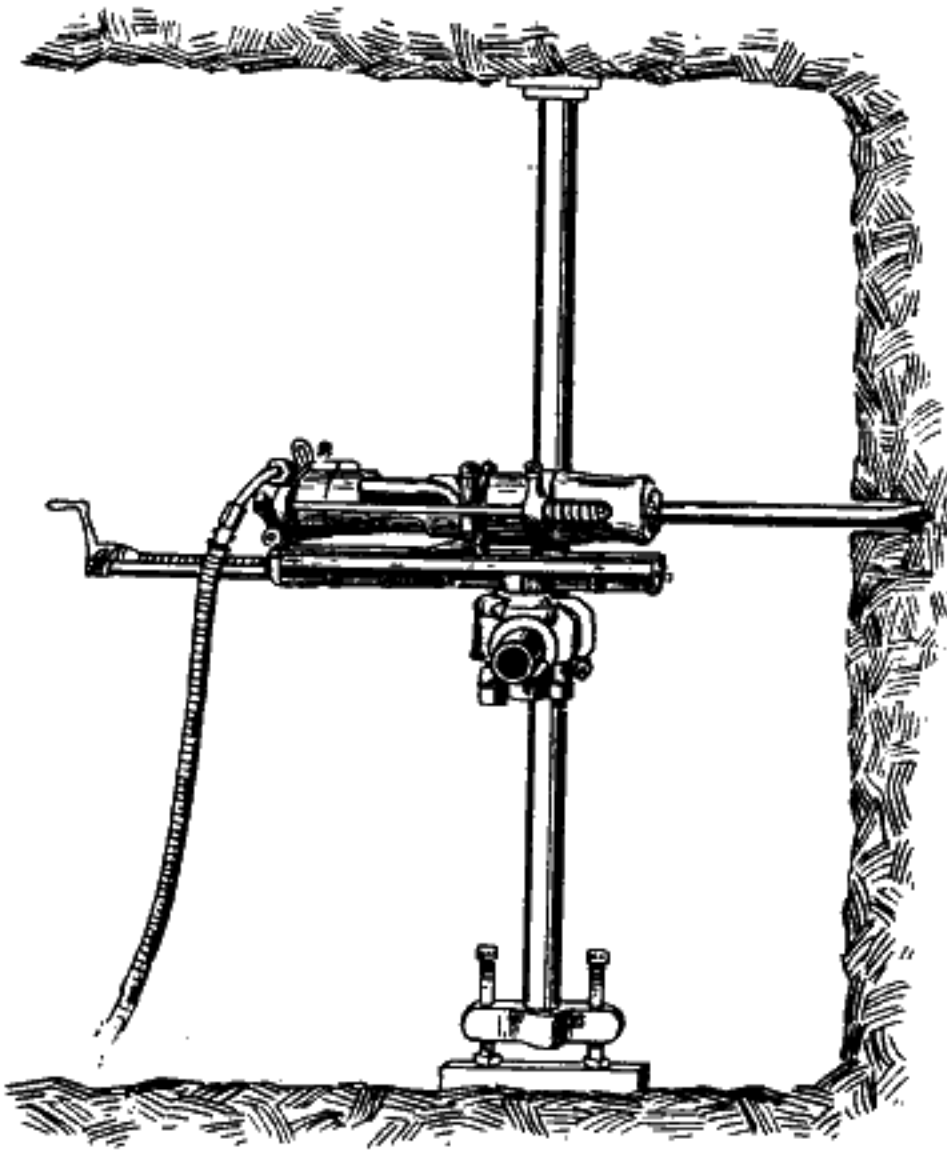


Fig. 75.—A column or post drill for work in a tunnel heading in hard rock.

charges of dynamite, one after the other. The first charge usually consists of one or two cartridges, this being increased in subsequent charges until the chamber is sufficiently large to hold the requisite quantity of explosives. In a bore hole smaller than  $2\frac{1}{2}$  inches in diameter, not more than six or eight  $1\frac{1}{4}$  in. x 8 in. cartridges of dynamite should be exploded at one time, because heavier charges may cause the bore hole to cave and close up. Slight caving often occurs with light charges, but the bore hole can usually be opened with the drill or any steel bar. The explosion of each chambering charge increases the bore hole slightly in depth and in diameter at the bottom. After a little experience the approximate size of the cavity can be estimated by noting the in-



Fig. 77.—Portable compressor supplying air to hammer drill.

Fig. 76.—A wooden tamping stick is needed for testing the depth and direction of bore holes, to press the charges of explosives into place, and to tamp the stemming material over the charge. No metal parts are permissible.

holes a pump, sometimes called a sand bucket, is used, while in slanting shallower holes a spoon is used.

**Springing Bore Holes.**—Bore holes are frequently “sprung” or chambered with dynamite, especially if they are to be charged with blasting powder or other bulky explosives. This makes it possible to keep the charge well down in the bottom of the bore hole, where it is generally most needed, and also to place the required quantity of explosives in the bore hole.

A bore hole is “sprung” or chambered by exploding in the bottom several



### Making Bore Holes—Springing bore holes

crease in depth or by dropping a short bar of wood attached to a rope. (Fig. 78.)

It is usually well to use a little dry sand or, in some cases, a little water for tamping the springing shots as it results in better execution.



Fig. 78.—A tamping block for deep holes. The hole for the rope is bored diagonally from the center of the end and the rope knot countersunk into the side. For use under water, a hole is bored as shown by the dotted line and almost filled with babbitt or lead, then a wooden plug is driven in to close the hole. This makes the block sink in water.



Fig. 79.—A pump for removing mud from deep well-drill holes. It is made of iron pipe with a valve in the bottom and a bail for attaching rope at top.

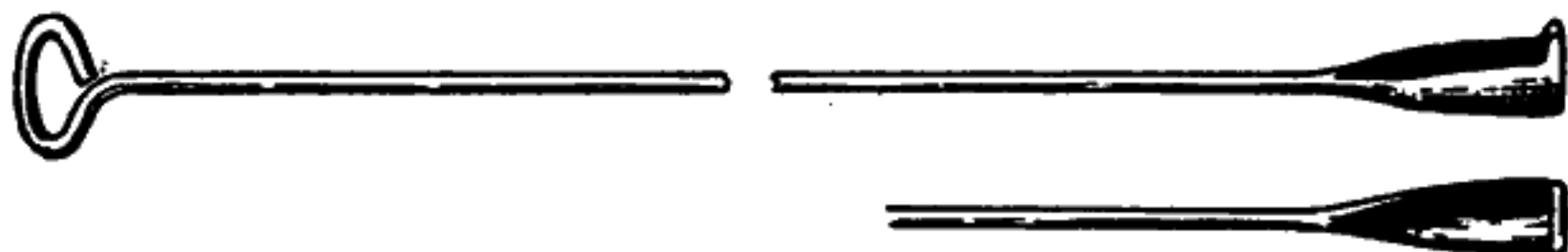


Fig. 80.—One type of spoon, or scraper, for shallow bore holes.



Fig. 81.—Another type of spoon, which is a modification of the pump for shallow bore holes.

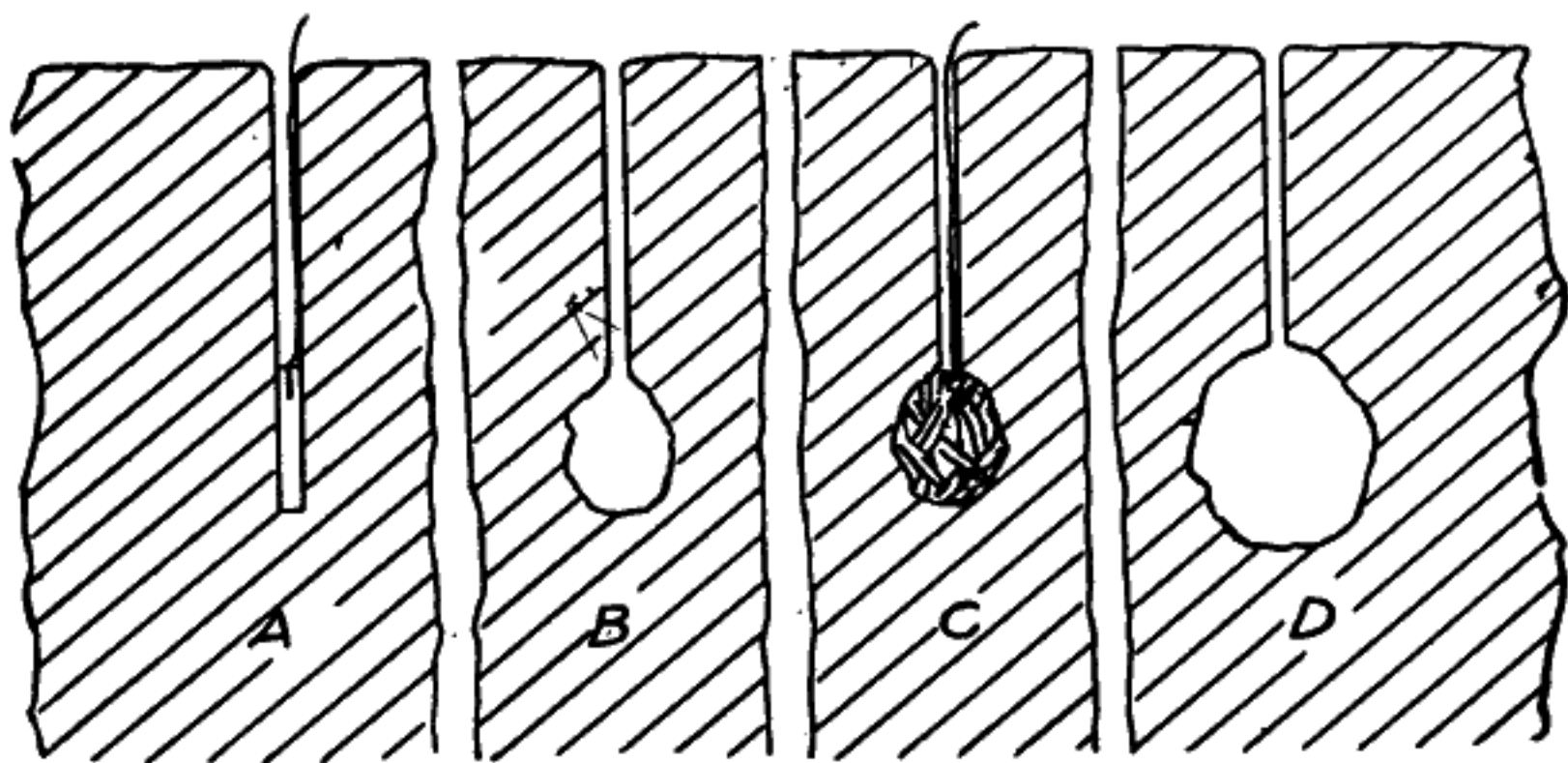


Fig. 82.—Process of springing a bore hole. "A" shows a single cartridge (2 or 3 can be used) in position for the first springing shot in a bore hole of small diameter. "B" shows the result of the first shot. "C" shows the second charge in place. "D" shows the result of the second shot. Additional shots are made until the chamber is enlarged to the desired size.

**Making Bore Holes—Springing and loading bore holes**

The number of chambering shots necessary depends on the hardness of the rock and the size of chamber desired. In solid rock the chamber or cavity is the result of the dynamite explosions burning or grinding off and forcing out through the bore hole small spalls and fine particles of the rock, and is not the result of compressing the surrounding rock walls. Therefore a quick-acting dynamite generally gives the best results in springing, because its effect is partly expended in shooting out of the bore hole the material which it first pulverizes. The powerful and quick-acting dynamites are not as likely to cave and close the bore holes as are the slower-acting ones. Du Pont Gelatin Dynamite from 40% to 75% strength will usually be found most satisfactory for this work, especially from the safety standpoint. The quantity of this dynamite required for chambering cavities of any given size depends upon the rock, but may be roughly estimated by allowing from three to six  $1\frac{1}{4}$  in. x 8 in. cartridges ( $1\frac{1}{2}$  to 3 lbs.) for each twenty-five pounds of blasting powder the chamber is to hold.

In soft, clayey or similar ground the action of the springing charge is to pack the disturbed material into the walls and thus enlarge the chamber. For such ground almost any fairly quick-acting dynamite will serve.

It is absolutely necessary, in order to avoid accident, that ample time be given the bore hole to cool off after each springing shot and before charging it with blasting powder or any other explosive. Many serious injuries have been caused by lack of attention to this rule. Just how much time should be allowed is governed by the quantity and the kind of dynamite used for springing, the number and frequency of the springing charges, and the character and condition of the rock, but under no circumstances should an attempt be made to load a bore hole sooner than a couple of hours after the explosion of the last springing charge, and it is better to wait four or five hours unless the hole fills with water. The possibility that a springing charge will heat the rock enough to explode the detonator in a subsequent springing charge must also be taken into account, and the blaster should always stand as far back from the mouth of the bore hole as possible when loading any of the springing charges after the first one.

**LOADING BORE HOLES**

Loading is the placing of a charge of explosives in a bore hole, or tunnel, or placing a mud-cap charge, and adding the tamping.

**Loading a Small Bore Hole with Cartridges of High or Low Explosives.**—First try the hole with the tamping stick to see that it is open and sufficiently deep and large. The required number of cartridges should be slipped in, one at a time, and pressed into place with the tamping stick. The primer should be placed in last or next to last. Care should be taken to avoid leaving air or empty spaces around the charge.

**Loading Bore Holes—Small holes with dynamite cartridges**

It is an excellent practice to begin the tamping with a small wad of dry paper, leaves or rags (Fig 86).\* The rest of the tamping should be packed in as firmly as possible, using the wooden tamp-

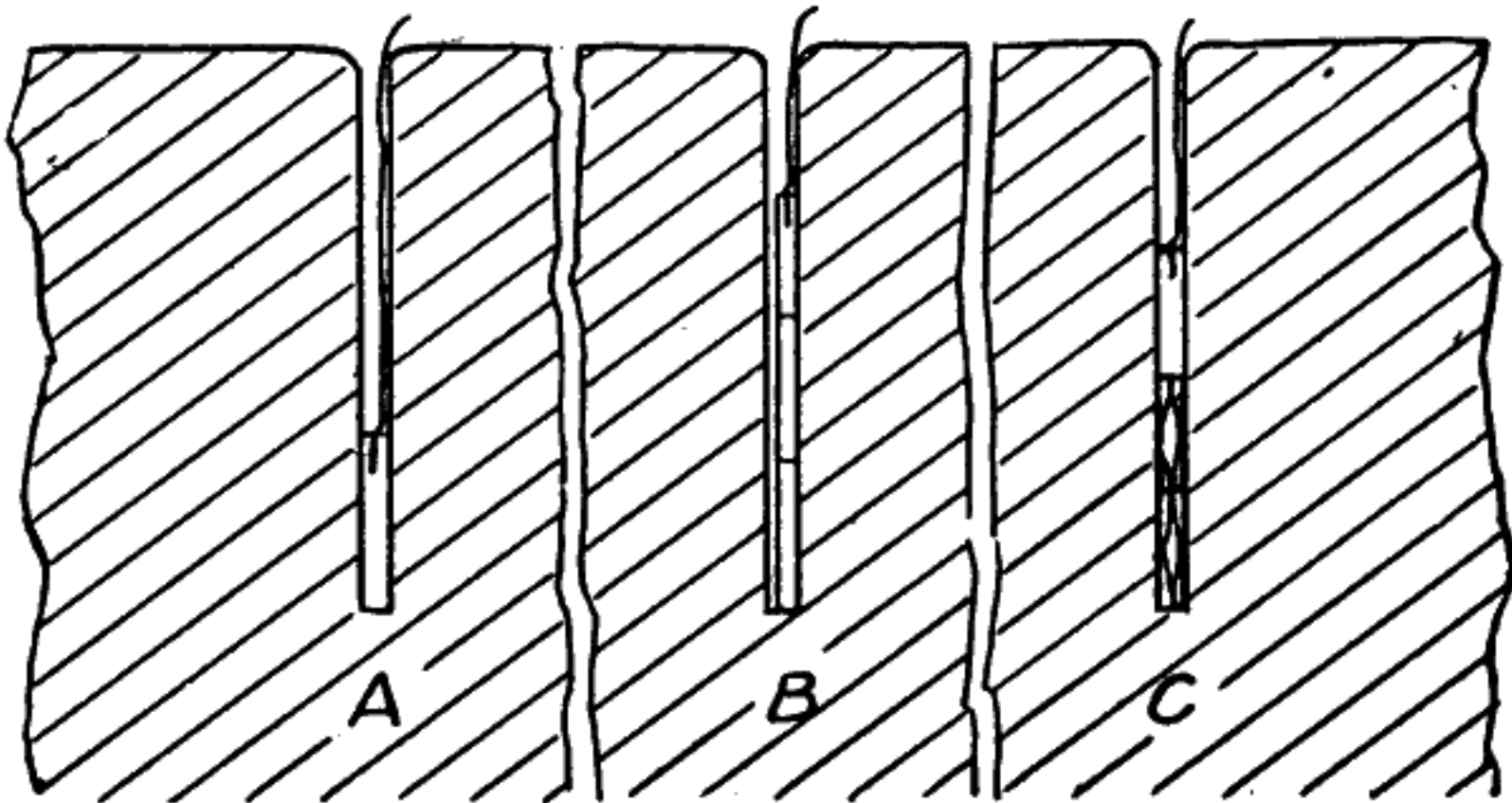


Fig. 83.—“A” shows a single (or a half) cartridge charge loaded into a bore hole. “B” shows several cartridges loaded into a hole without slitting paper wrapper in order to protect the explosive from moisture if the hole is wet. The primer should be at or next to the top and the cap should point toward the main part of the charge. “C” shows how, when the holes are dry, the cartridges are slit from end to end and pressed down to fill the entire diameter of the hole and leave no air spaces. The primer should not be slit.

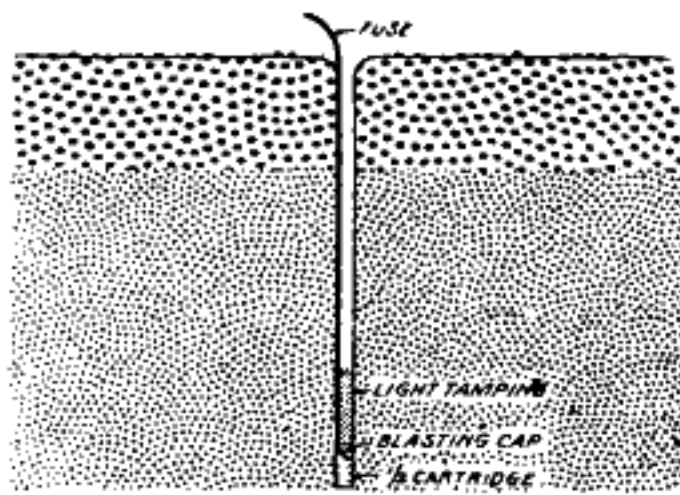


Fig. 84.—The tamping immediately over the charge should be light in order to avoid jarring the cap.

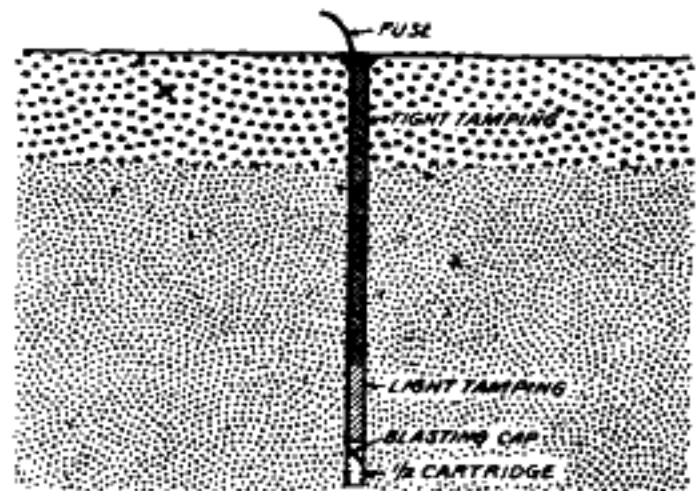


Fig. 85.—The rest of the tamping should be tight and firm in order to confine the gases as much as possible.



Fig. 86.—The use of a plug of paper, leaves or rags between the explosive charge and the tamping serves as a safety indicator of where to stop in removing tamping in case of misfires.

\*This practice should not be followed in coal mines because the detonation temperature of the explosive, even of a permissible, may cause bits of burning material to be thrown out into the open.



**Loading Bore Holes—Small holes with blasting powder or R.R.P.; sprung holes**

ing stick in one hand and taking care to avoid losing the end of the fuse or electric blasting cap wires in the hole (Fig. 85). When tamping a hole containing fuse, the fuse should always be kept straight, for if a sharp kink or bend is formed, there is danger of a hang fire or misfire.

**Loading Small Holes with Blasting Powder or du Pont R. R. P.**—In loading small holes with either of these explosives, the desired amount is poured in from the keg or bag and packed down with the tamping stick. See page 69. When blasting powder is used a fuse or electric squib is inserted into the centre of the charge and the hole tamped. If a miners' squib is used, the needle is inserted before tamping is begun and withdrawn as soon as the hole is completely tamped (Fig. 7). For R. R. P., a blasting cap or electric blasting cap is used for very small charges, but for large charges the use of a 40% or stronger dynamite primer is advised. Both of these explosives require careful tamping, as the slowly developed gases may compress the bottom of the tamping or blow it out entirely. These explosives are quickly affected by moisture, and should not be used in moist holes. When the bore holes point up rather than down, it is a difficult matter to get the explosive into the bottoms of the holes without the use of tamping bags. (See description on page 33.) The granular explosive is loaded into these and pressed to the desired place in the bore hole. The detonator, or electric squib, is placed in one of the bags with the explosive. To facilitate tamping, the stemming material is also put in tamping bags and pressed into place. Loading in tamping bags permits the use of blasting powder in holes that are slightly moist if firing is done immediately.

When the charging is completed, all powder spilled around the mouth of the bore hole should be carefully brushed into it.

Bore holes should never be charged with blasting powder when a steam shovel, locomotive or any other source of sparks or hot coals is operating in the vicinity, without complete protection in the way of screens and covers to protect the powder. Sparks and hot cinders are thrown considerable distances from the smokestacks of these and other boilers, and numerous fatal accidents have been due to them. It is much safer not to charge the bore holes at all during the time the steam shovels and locomotives are operating in the vicinity.

**Loading Sprung Holes.**—Sprung holes are loaded in exactly the same manner as has been described for small holes. A careful examination of the hole before loading should be made to be sure that it is open, and most especially to see that it has cooled off from the heat of the springing shot. Failure to make this last observation may be the cause of serious accidents, due to premature explosions, caused by the hot ground or rock igniting the charge.

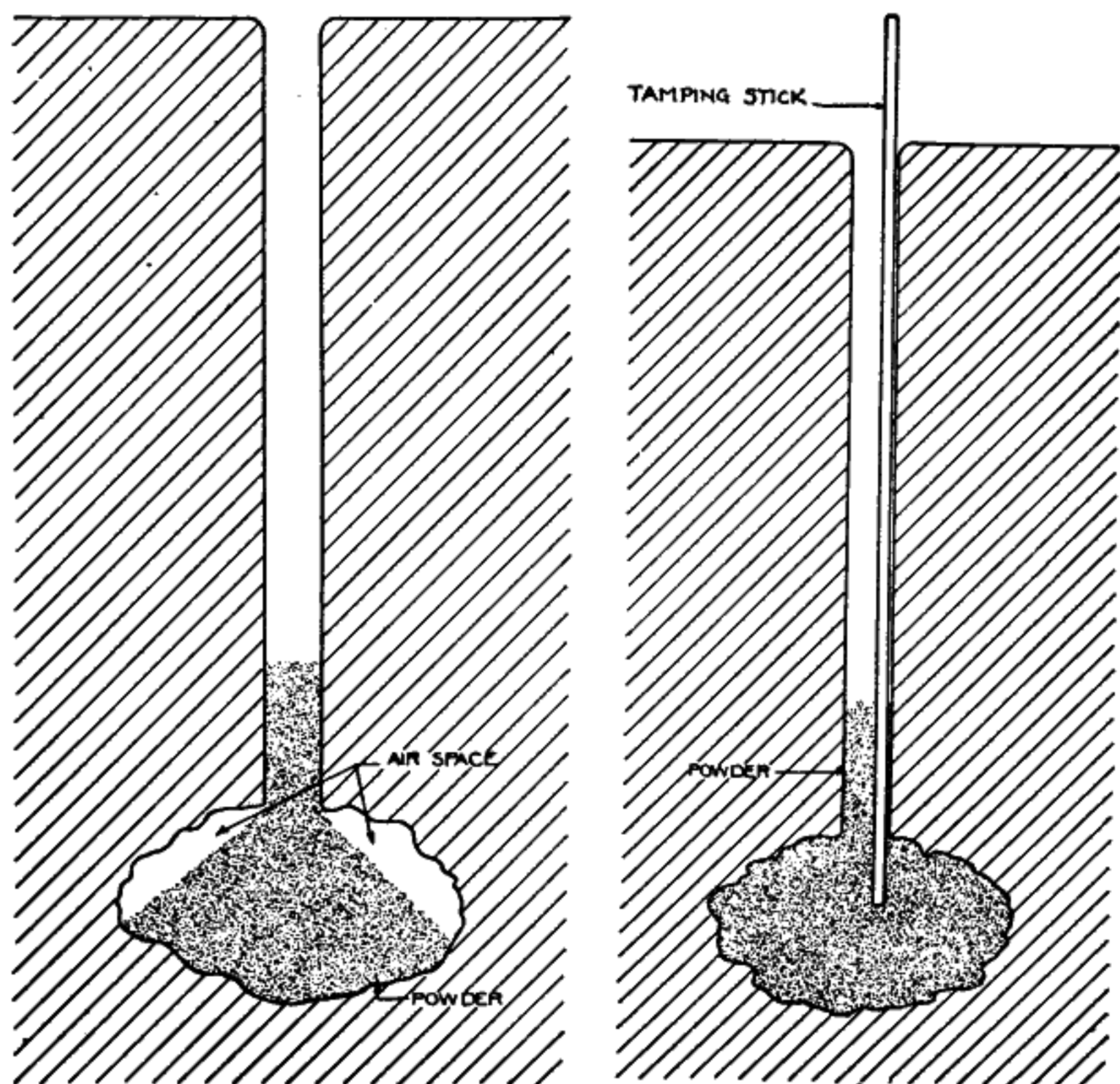


**Loading Bore Holes—Sprung holes; well drill holes**

Horizontal sprung holes are usually loaded by means of a long, light stick, or bamboo pole, similar to a tamping stick, except that one end has a slim, sharp point. Each cartridge of dynamite is stuck firmly onto this point, inserted carefully to the bottom or back of the hole, and shaken off there. Another method is to have a long tin or brass tube extending to the back of the hole through which the cartridge can be inserted.

**Loading Well-Drill Holes.**—Well-drill holes are seldom sprung, and require the most careful loading to ensure the best results. The hole should first be examined with the tamping block (Fig.78) to see that it is in good condition. Sometimes a ray of light can be thrown into the hole by means of a mirror or a flashlight.

As much water should be bailed out as is possible, but it is never practicable to get the last few quarts out of deep holes, and usually if the hole taps wet ground it fills up so rapidly that bailing does not accomplish much. Where water is running into the hole, only a gelatin dynamite should be used, or a fairly water-resisting dynamite in cartridges of as large a size as will go easily to the bottom without sticking and without slitting the wrappers.



Vertical bore hole chambered and showing powder filled to top of chamber and not spread out, leaving an air pocket.

Vertical bore hole chambered with powder spread out and packed in the chamber, properly filling chamber and leaving no air pocket.

## Loading Bore Holes—Well drill holes

The method of loading will depend on the diameter of the cartridges of explosive used, the depth of the hole, and the kind of detonator.

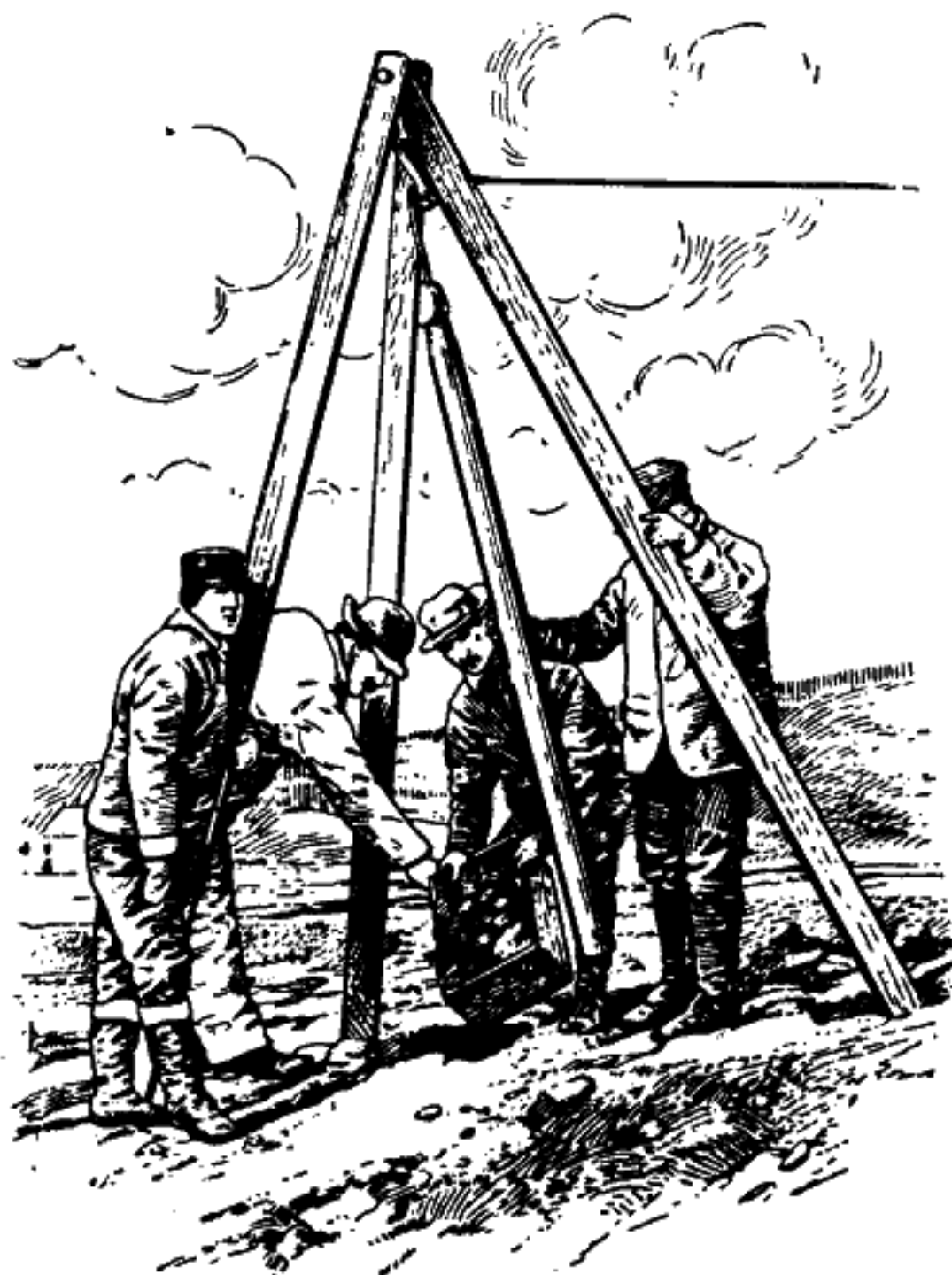


Fig. 87.—Loading a deep well-drill hole. Note the tripod and suspended wooden tamping block.

The skewer is stuck into the cartridge just deeply enough so that it will hold when suspended. It is then lowered in the hole and a quick jerk of the string releases the cartridge.

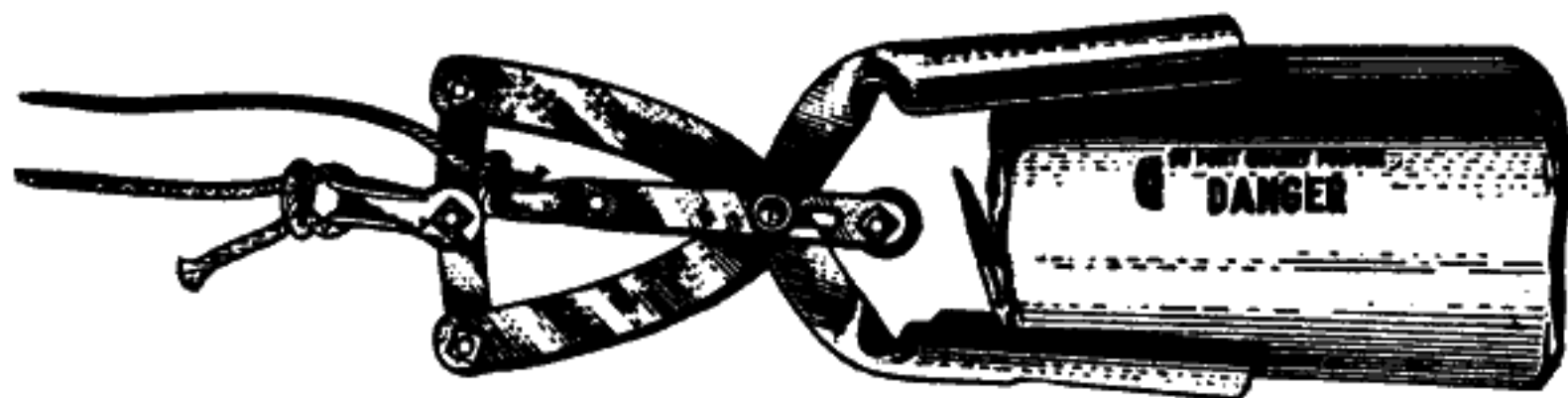


Fig. 88.—Loading tongs for lowering cartridges of large diameter to the bottom of deep well-drill holes.

For shallow holes the use of the tongs is not necessary. If the explosive settles well in the hole, it is not necessary to use the tamping block for settling it, but if it does not, the block should be used quite frequently. Care should be exercised to avoid injuring the cordeau or electric blasting cap wires with the block. Many

When cordeau is used, a strand is suspended for the full depth of the hole; when electric blasting caps are used, a primer should be placed about every 15 to 25 feet in the charge.

When loading deep holes with cartridges of large diameter, the cartridge so nearly fills the bore hole that, in dropping, an air cushion is formed under it, which prevents it from striking with any degree of force. If the cartridge does not fit the bore hole so as to form an air cushion, either loading tongs or a wooden skewer on the end of a string may be used for loading the first few cartridges.

## Loading Bore Holes—Well drill holes using cordeau

expert loaders refuse to use a block in a hole containing cordeau, either when loading the charge or when tamping the hole.

When loading with cartridges of small diameter they should be slit, or better, cut into small pieces and these dropped in a few at a time. Unless cordeau is used they should be slightly packed with the block. Where only cartridges of small diameter are available and the work is wet, they may be securely tied together in bunches of seven and then loaded in the same way as large cartridges.

Well-drill holes must be thoroughly tamped. Some prefer not less than 20 feet of tamping, insisting that this be tightly packed by means of the tamping block, while others prefer simply to shovel in the earth, especially if cordeau is used. In deep holes, the tamping block rope is frequently run over a pulley at the top of a wooden tripod and operated by one or two men on the rope.

Cordeau is especially valuable for use where the charges are broken, that is charges of explosives are loaded at more than one point, as in deep well-drill holes and in quarry tunnel blasting. Being just like one big cap extending the full length of the explosive charge, it assures a thorough detonation of the explosive. More holes can be fired with cordeau with certainty than by electricity. It is supposed to increase the efficiency of the less sensitive explosives, like ammonias or gelatins, according to some, from 10 to 25 per cent. In experiments with cordeau and gelatin it has been found that the breakage is at least 10 per cent. better and that the stone is thrown off the benches cleaner than when electric blasting caps are used. It does not seem to enhance the efficiency of

straight dynamite.

Cordeau is best adapted for well-drill work and then only in holes of some depth where a considerable quantity of explosive is used. If holes are shallow and only 50 to 75 pounds used per hole, the gain, if any, in explosive efficiency is offset by the additional cost of cordeau.

**Methods of Using Cordeau.**—The end of the cordeau is tied to or laced through a dynamite cartridge and it is allowed to run off the spool until cartridge reaches bottom and the cordeau extends full length of the hole. The rest of the charge is loaded in the usual manner. If there is water in the hole the end of the cordeau should be sealed by hammering the lead together. When the hole is tamped the cordeau is cut, allowing six inches to extend above the collar of the holes. An electric blasting cap

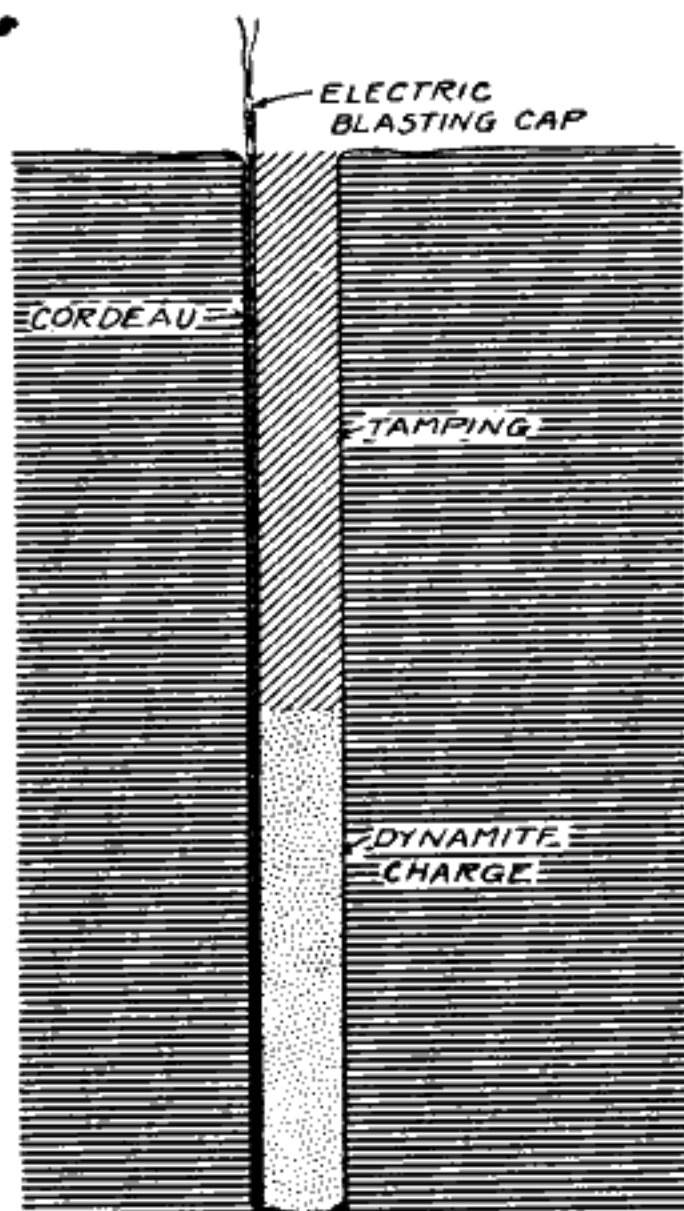
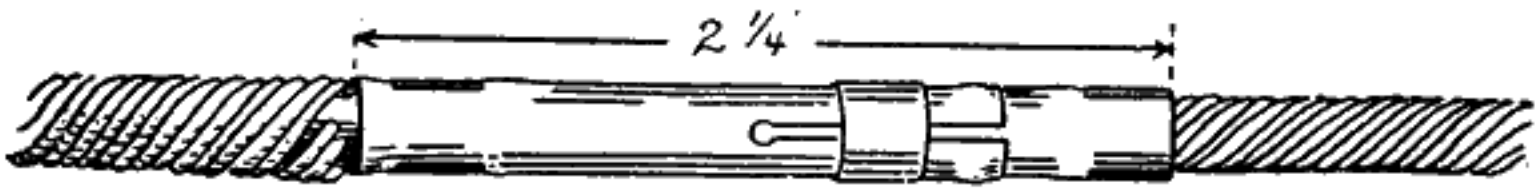


Fig. 89.—Cordeau extending to bottom of bore hole.

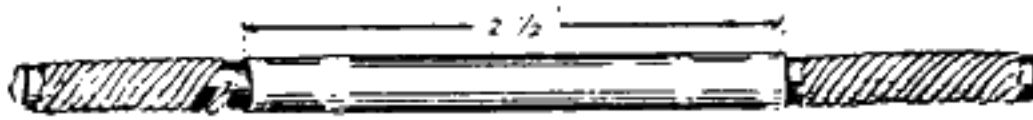




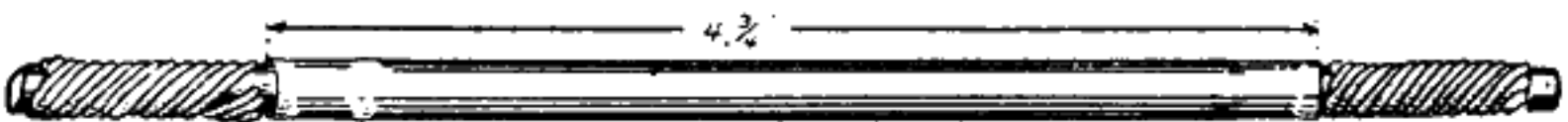
UNION FOR ATTACHING A BLASTING CAP TO CORDEAU



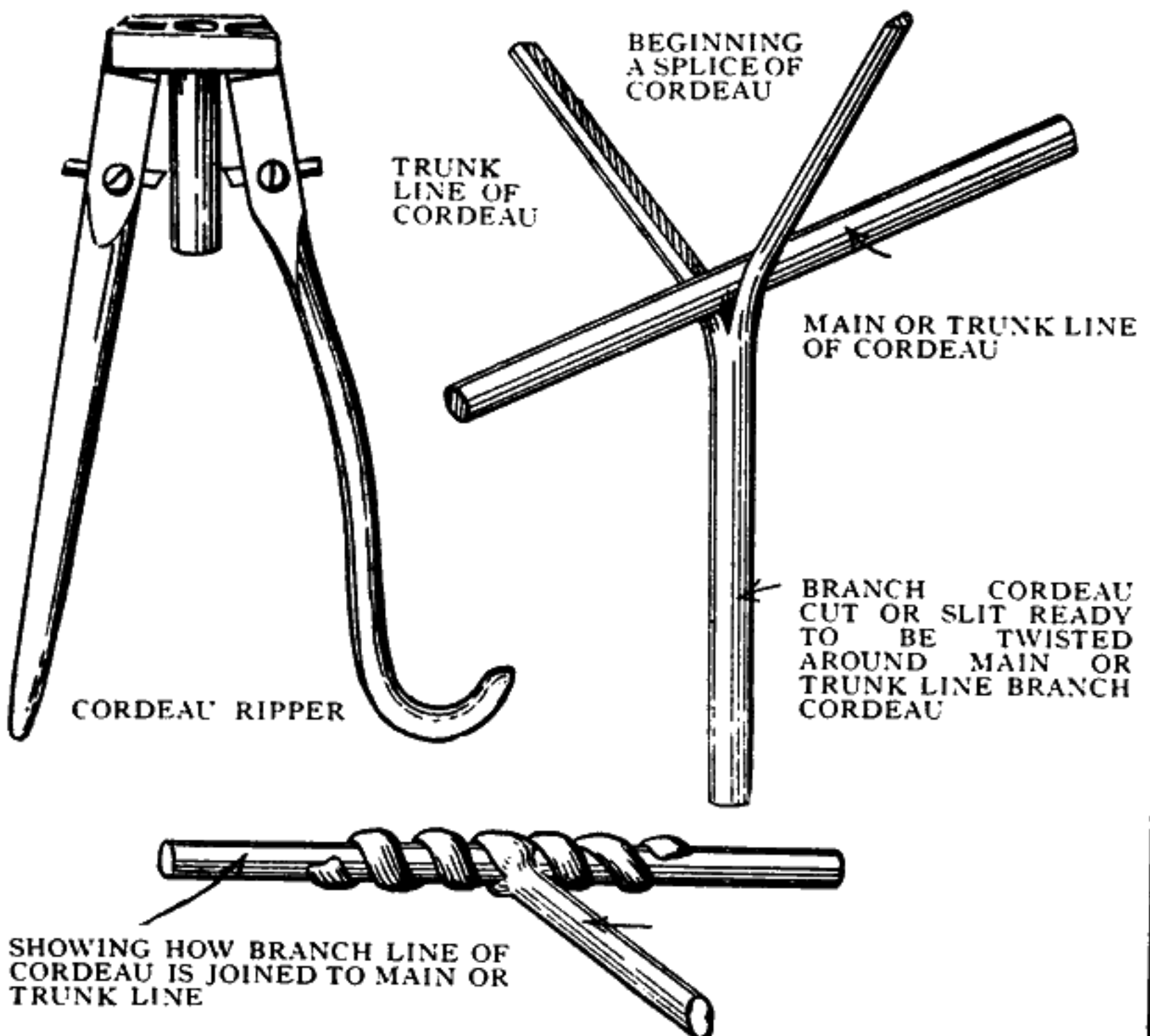
SPECIAL UNION FOR ATTACHING AN ELECTRIC BLASTING CAP TO CORDEAU



COUPLING FOR FASTENING TWO PIECES OF CORDEAU TOGETHER



SLEEVE FOR FASTENING TWO PIECES OF CORDEAU TOGETHER



Accessories required in the use of cordeau and splicing methods recommended.



**Loading Bore Holes—Using cordeau; tunnel, gopher or coyote holes**

is attached to the end of cordeau at each hole by means of a brass union made for the purpose and then the electric blasting caps are connected up and fired in the usual manner. The use of an electric blasting cap at each hole is cheaper than using a surface cordeau connection. The surface line does no work other than carry detonation.

It may be necessary or desirable sometimes to use the surface connection. It is made thus. The end of cordeau extending from the hole is split in half for about three inches in length and separated. A special tool called a "ripper" or "slitter" is used for this. A main or trunk line is laid across the top of holes on the surface so that the main lines lie in the crotch formed by the split ends. These ends are twisted tightly around the main line, one to right, other to left.

A blasting cap or electric blasting cap is connected to the end of main line and fired, thus detonating the whole blast. As many as 76 holes 86 feet deep have been fired with one blasting cap. Great care should be used to see that connections are tight and that the angle between the main line and branch line is a right angle. The explosive in the tube will not stand water and extreme care is necessary if surface connections are used in rainy weather. The load in well-drill holes may be broken as many times as desired and only the one line of cordeau is required.

If the cordeau is broken while loading the explosives no harm is done, but if it is broken while tamping, some dynamite should be loaded at that point and the tamping continued. The dynamite so loaded will assure the continuation of the detonation with no danger of a misfire.

**Loading Tunnel, Gopher or Coyote Hole Shots.**—For this loading the hole is large enough to enable the blaster to carry in the explosive by hand. The chambers or recesses into which the explosives are loaded (Fig. 161, page 133) should be large enough to accommodate the charge easily, but should not be larger than necessary, as air pockets are likely to be formed. These chambers should never face the tunnel entrance, but should be offset so that the gases would have to force the tamping around a corner to escape into the open. Some blasters prefer, where practicable, to sink pits deep enough to hold the charges, claiming that better confinement is thus obtained and that the quarry floor is kept down to grade in better shape.

No matter what explosive is used, it should be stacked snugly into the recesses. It is not necessary to pour blasting powder out of the kegs or to open cases of other explosives, as the primers are sufficiently strong to disrupt the cases or kegs. This loading in bulk is more convenient and much safer than opening packages. The dynamite primers used for blasting powder should be 1% or more of weight of blasting powder, and from 4 to 10% of the weight of du Pont R. R. P. It is not necessary to use special primers with other explosives, as they are sufficiently sensitive to detonate completely. For high explosives two or three extra cartridges are

**Loading Bore Holes—Tunnel, gopher, coyote holes. Tamping**

tied to the primer and the entire bundle placed back in the case from which they were taken, the cover tacked on and the "primer case" placed near the center of the large charge. The same method of making large primers is used for detonating large charges of blasting powder or R. R. P. Du Pont Straight is recommended for priming when blasting powder is used. The use of electric flash lights while loading is recommended.

Great care is necessary in loading these large quantities of explosives, especially if they are removed from the original cases. Open lights should not be allowed and possibilities of sparks must be reduced to a minimum.

Detonation must be by means of electric blasting caps or cordeau, either of which must be carefully protected from injury when loading and tamping. This is usually done by nailing strips to a heavy board, thus forming a trough through which the wires can be conducted. The board is covered with a second board for safety, and is laid on the floor. Suspending leading wires on the roof is not so good a practice.

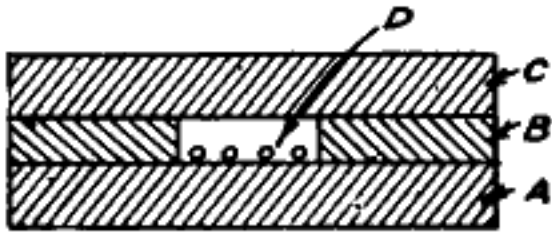


Fig. 90.—Section of conduit for protecting leading wires or cordeau for tunnel or gopher hole blasts. "A." A heavy board for bottom. "B." Piece of 1 inch x 4 inch board. "C." A heavy board for top. "D." Leading wire or cordeau protected from injury. Such a conduit is placed on the floor of the tunnel.

All detonators should be tested with a galvanometer before being made into primers. All of the connecting and leading wires should be tested before tamping is begun, and at frequent intervals during the tamping. Not less than two detonators should be used at least every ten feet in each charge, so that if one set of wiring becomes damaged, the shot can be fired by the other.

Each unit of explosives in the tunnel should have two electric blasting caps. The leading wires should be brought out to the mouth of the tunnel. It is bad practice to have the connections inside of the tamping, but where necessary, they should be carefully made and well taped.

The tamping must be very secure. Ordinarily the muck taken out of the tunnel is used for tamping. This must be piled securely against the face of the charge. Some blasters prefer bags of sand or loam. These can be used to the best advantage. Bulkheads of heavy timbers notched into the side walls and the tamping packed behind them, or brick or lean concrete bulkheads, are sometimes used. Ordinarily it is sufficient to pile the muck closely and carry the tamping on out to the very mouth of the tunnel. Partial bulkheads placed every ten feet ensure better packing of the stemming material at top of the tunnel.

**TAMPING**

Ordinarily the word "tamping" is used to cover both the act of closing a bore hole and the earthy material used. A better use is

**Tamping—Water tamping; tamping stick and block**

to designate the act or work as "tamping" and the material as "stemming."

Stemming, except for gopher holes and tunnels, should be free from stone and grit. For large holes where the weight of the stemming gives the confinement, dry, free running sand is good. For other work, a moist, easily packed sand, clay or loam is best. Dry light material such as the "bug dust" from drills, augers or cutting machines should never be used.

Good tamping is one of the prime essentials of successful blasting.

**Water Tamping.**—When a large amount of water covers a charge of high explosives in a "down" hole, further tamping is sometimes omitted, as the water makes fair tamping. When the explosive used has good water-resisting power and an adequate supply of water is convenient, it can be used instead of earthen tamping, even though it is not as effective.

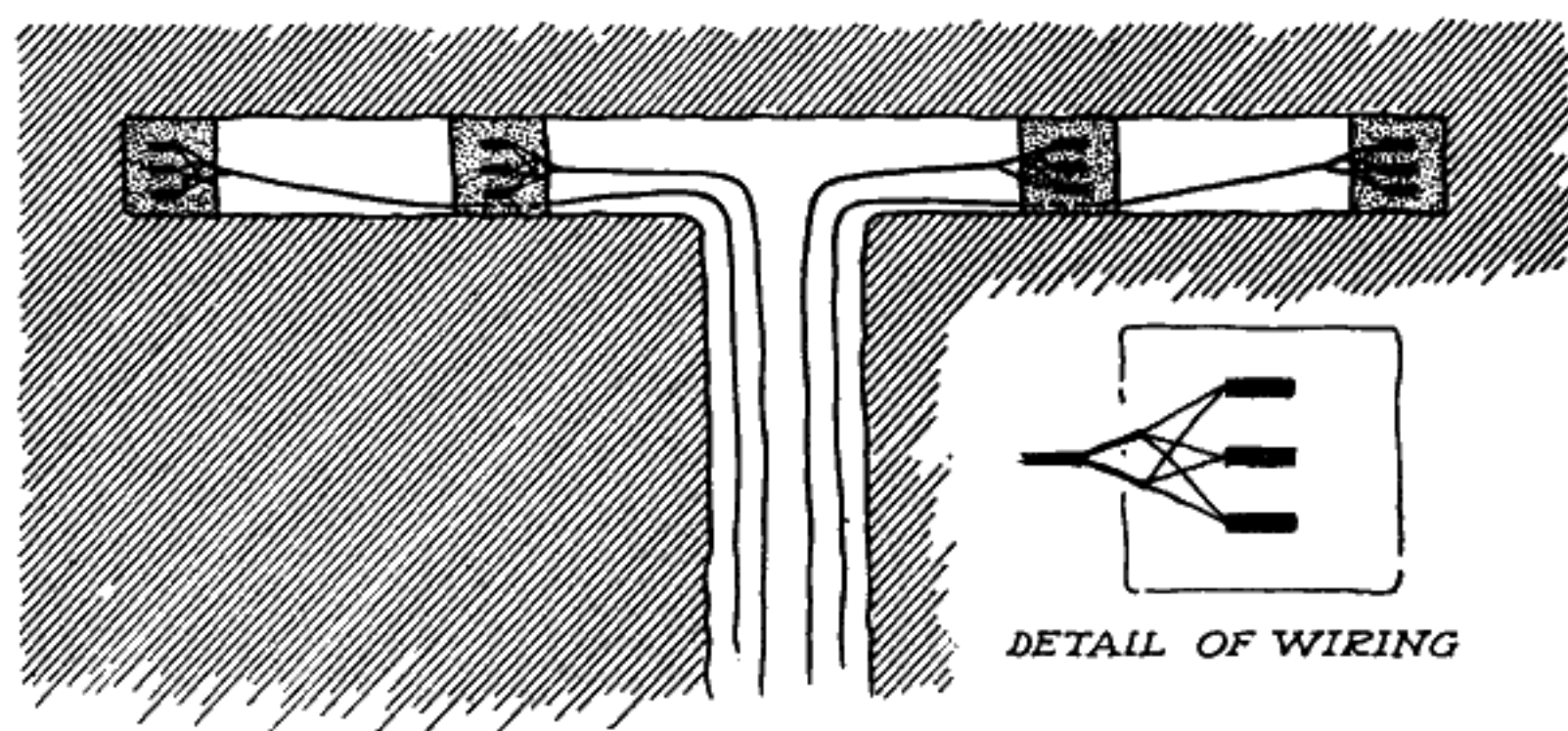


Fig. 91.—Diagram of wiring for tunnel blast.

**Tamping Stick.**—For loading and tamping only a wooden tamping stick (Fig. 76) should be used. For shallow work an old broom or shovel handle is ideal. For deep holes when a long stick is needed, a straight sapling can be used to good advantage.

For tamping horizontal holes, especially in the face of a quarry, several feet above the floor, a heavy tamping stick, such as oak or hickory, would be very difficult to manipulate, and for this purpose a lighter wood, such as white pine or bamboo, is very desirable. Bamboo fishing poles are light, straight, and strong, and in some conditions make ideal tamping sticks. It is distinctly dangerous for a powerful man to ram a charge of high explosives in a bore hole, especially if it has been sprung, with a heavy tamping stick, even if it is made of wood.

**Tamping Blocks for Well-Drill Holes.**—In deep holes a very long, heavy, cumbersome tamping stick would be necessary, so the tamping block is used in holes that are vertical or nearly so.



**Firing Blasts**

This consists of a round piece of wood of a size to slide easily down the hole and usually from three to six feet in length, with a small rope attached in the center of one end to permit it to hang vertically. The block should be of hardwood to resist wear, must not have any metal parts, and should not be too heavy (see Fig. 78). It is operated by raising a foot or two and letting drop upon the stemming material as the tamping progresses, being withdrawn when fresh material is dropped into the hole.

**FIRING**

By "firing" is meant the setting off or exploding of blasts. This should never be done until the blaster is sure that all charges are properly loaded and tamped and that all persons or animals are at a safe distance. What constitutes a safe distance must be governed by the individual blast. It is usually safe within a few yards of a subsoil shot, as there is practically no danger of soil or stone being thrown into the air; but boulder, stump, ditch, quarry and many other blasts throw fragments of earth, wood and stone a considerable distance and several hundred feet away from the blast may still be in the danger zone.

If the blaster cannot get under safe cover he should always face the blast with his back to the sun, as this gives him the best chance to watch and avoid any flying matter.

The firing of a blast should always be preceded by a careful look to see that everything is safe, by establishing a patrol of the roads to prevent anyone from approaching the neighborhood of the blast, and by a shout to warn all present that the blast is about to go.

When the fuse is to be lighted it should be done in a quick but orderly manner. This can be hastened by slitting the ends of the fuse to expose the powder train for easy ignition. The blaster should immediately retire to a safe distance.

When electric blasting caps and electric firing are used the same care must be taken with regard to safety before the wires are connected to the blasting machine or electric switch. When the blaster is assured that everything is all right, the connections are made and the blast fired.

In case of a failure of the blast to go when using electric blasting caps the blaster is safe in disconnecting his wires and returning immediately to look for the trouble.

When using fuse and blasting caps it is not safe to return to look for the cause of a failure until a considerable time has elapsed—preferably several hours.

This matter of waiting is an additional argument for the use of electric blasting caps instead of blasting caps for almost all classes of blasts.

After a blast is fired the blaster should wait a sufficient length of time to allow the falling matter to drop, and for the smoke, fumes and dust to be partially dissipated or blown away.



**Firing Blasts—Misfires**

**Handling a Misfire.**—The use of high-grade explosives and detonators and careful loading will reduce the dangers of shots failing to fire. When a misfire does occur the blaster should be governed by conditions.

When electric blasting caps are used and one or all of the holes fails, disconnect the wires from the blasting machine, then it is safe to go back immediately to investigate the trouble. The investigation should first consist of a search for broken wires, faulty connections or short circuits. If such are found, make the proper repairs, reconnect the leading wires and operate the blasting machine. Many so-called failures are the result of poor connections or connections being in contact with wet ground, or other conductive material.

When caps and fuse are used greater care must be exercised. It is never safe to go back immediately to a delayed shot that is primed with a cap and fuse. The fuse may have been injured in tamping, and instead of burning rapidly may smoulder for a long time, then re-ignite the powder in the lower end of the fuse and fire the blast. The interval of waiting should be as long as possible, preferably until the next day if the firing is done in the afternoon. In all cases it should be several hours. When lighting fuse be sure that the powder column is on fire, as time may be wasted in waiting for a blast whose fuse is not even lighted.

If the missed hole is untamped or is tamped with water, make up another primer, place it on top of the charge and fire. If the ground is soft and wet, put down another charge far enough away for drilling in safety, but close enough to cause detonation by concussion.

There are laws in several states forbidding the removing of tamping or the charge from a missed hole.

When it is not specifically forbidden, blasters sometimes remove the tamping by means of a spoon, which is not entirely a safe proceeding, put in another primer and fire. Other blasters wash out the tamping by means of a powerful water jet, which is not as dangerous as digging it out with an iron spoon, but which, of course, ruins the explosive, unless it is water-resisting. This is dangerous in the hands of a reckless operator, as the iron pipe is likely to strike the explosive charge. Another practice is to blow the tamping out by means of compressed air brought in at the end of an iron pipe. This has possibilities of danger similar to the water method, but it has not the disadvantage of wasting the explosive.

With well-drill holes or with holes which have been sprung, it is not practicable nor safe to drill another hole alongside of them to blast out the charge. It is better, when a second hole is drilled, to put it so that the two holes lie in a plane parallel to the face and not behind the missed hole, as many accidents have occurred from striking unexploded dynamite in the débris from a blast.

One quarry superintendent of a large limestone producer always measures carefully the distance from the collar of the well

**Firing Blasts—Misfires. Road and Railroad Building**

drill holes to the top of the explosives charge. He then uses good clay tamping free from grit. If a charge misfires a hole is carefully made in the tamping by means of a hard wood bar, large enough to take a 1¼-inch diameter cartridge, to within an inch or two of the top of the charge. This hole is then loaded with several cartridges of the strongest and quickest dynamite easily obtainable, tamped and shot. As a rule this rarely fails to explode the missed charge below. If the tamping is softened by adding a little water from time to time as the auxiliary hole is deepened, the work will be much easier. This operation requires the very greatest care.

While there is no perfectly safe method for handling a charge which has missed fire, it is usually entirely possible to prevent a misfire by the use of the highest grade blasting supplies, by testing each electric blasting cap with a galvanometer before loading, before tamping and after tamping, and by using two or more electric blasting caps in each charge. While the latter may seem expensive, it is very much cheaper than a misfire, as the cost of a misfire may run into thousands of dollars.

When, for any reason, misfires may be expected, a good practice is to use a wad of paper or dry leaves immediately over the charge of explosive and pack the tamping on top of this (Fig. 86). If it becomes necessary to remove the tamping, this dry material makes an excellent index of just how far down it is safe to remove the tamping. This should not be used in blasting coal, as the blast may leave the material burning in the open.

All misfires should be placed under the direction of a careful and experienced workman, who should make his examination in a slow, methodical manner before beginning the work of repriming.

The adoption of electric blasting will result in a decrease in misfires, and prevent hangfires, and is to be recommended on all work.

**ROAD AND RAILROAD BUILDING**

Explosives are used in road and railroad building and road repairs for:

- Removing stumps and boulders,
- Opening ditches,
- Opening vertical drains,
- Loosening hard ground in grading,
- Blasting rock in grading,
- Blasting for surfacing and ballasting material.

Stump and boulder blasting on the road are done the same as other blasting of this nature. (See pages 94 to 97 for methods of boulder blasting and pages 91 to 94 for methods of stump blasting.)

For removing stumps and boulders explosives prove a saving in time, effort and cost. High labor costs make hand methods of stumping and clearing prohibitive. The use of explosives in combination with the different light stump pullers or with tractors

## Road and Railroad Building—"Through" cuts

works to advantage in road clearing. Frequently boulders can be blasted out of the road by well-located "snakehole" blasts without using such heavy charges as would be required to break them up.

**Blasting "Through" Cuts.**—Hard ground whether clay or rock is loosened in through cuts by blasts loaded in either flat or vertical holes. The selection of the direction of the holes will depend on the nature of the ground. For ground having flat or horizontal seams the vertical hole (Fig. 93) is usually preferred; while flat holes (Fig. 92) are usually best when the seams are vertical or the ground hardest at the top.

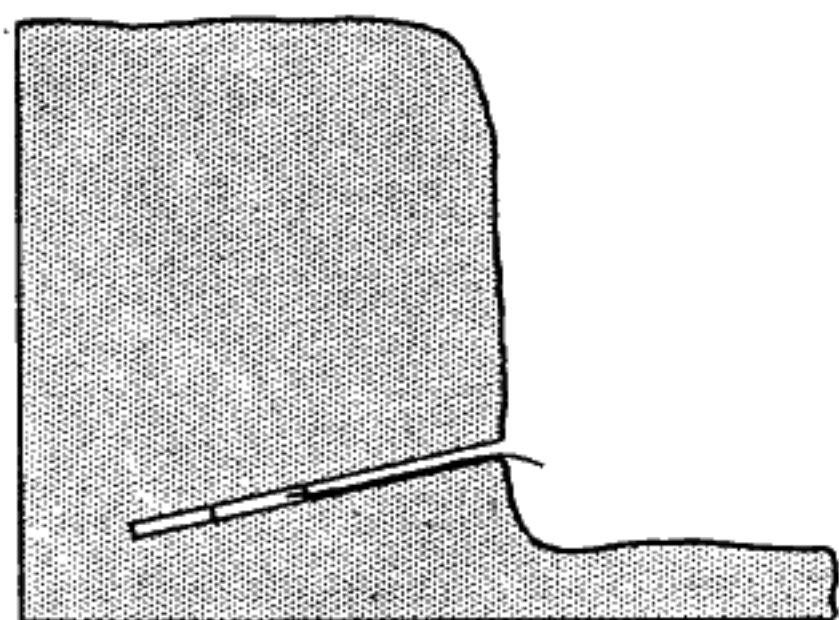


Fig. 92.—Location of a flat or "horizontal" bore hole in a road cut. When a bulky explosive is used, the hole is sprung.

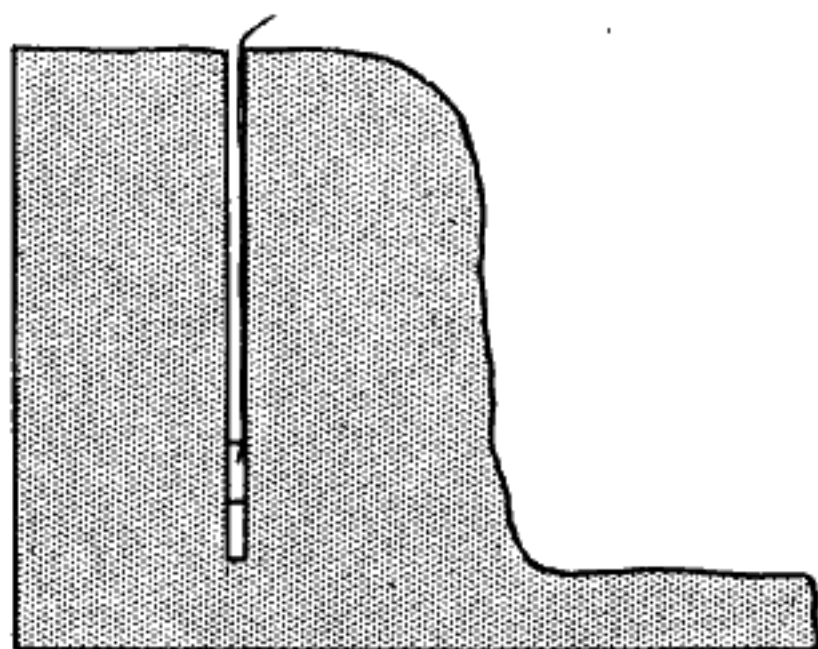


Fig. 93.—Location of a deep, vertical bore hole in a road cut. When R. R. P. or blasting powder is used, the hole is usually sprung.

When vertical holes (Fig. 95) are used the best practice is to drill a line of holes all the way across the cut. These should be drilled somewhat below the grade, usually about one foot, to insure that no high spots are left between and in front of the bore holes.

These holes can usually be spaced apart a distance from three-quarters to four-fifths of their depth for holes less than 6 feet deep. Deeper holes are usually spaced from one-half to three-quarters of their depth apart.

The burden or distance back from the face (Fig. 94) must be governed by the resistance of the ground to breaking. This distance can usually be slightly greater than the spacing between the holes.

For this blasting electric firing is to be most strongly recommended, as a given amount of explosives in such a load will do more work when all holes are fired together than when fired singly.

The spacing between holes is about the same for flat as for vertical holes, but as a rule, flat holes can be drilled deeper, or in other words, a heavier burden can be handled.

Either the soil punch (Fig. 68) or the churn drill will make a good tool for putting down the holes in clay or hardpan. For small amounts of harder drilling the use of hand drills (Fig. 71) is satisfactory; but if there is much hard drilling to do either a ham-



### Road and Railroad Building—"Through" cuts

mer drill (Fig. 72) or a piston drill (Fig. 73) will prove an economy. The piston drill generally makes a larger and more easily loaded hole, but the hammer drill is easier to handle and lighter to move. A hammer drill outfit, with a light portable compressor, is a valuable addition to road building equipment when much hard material is encountered in either construction or repair work.

The explosive used should be in keeping with the ground encountered. The following general recommendations will usually apply:

*For Rock.*—Red Cross Extra 40% Dynamite in holes not sprung; either du Pont R. R. P. or blasting powder in sprung holes.

*For Shale or Slate.*—Red Cross Extra Dynamite 20 to 40% in unsprung holes; and either Red Cross Extra 20%, du Pont R. R. P. or blasting powder in sprung holes which usually carry a heavier burden (Fig. 82) than those not sprung. The last part of the recommendation applies especially to heavy or deep cuts.

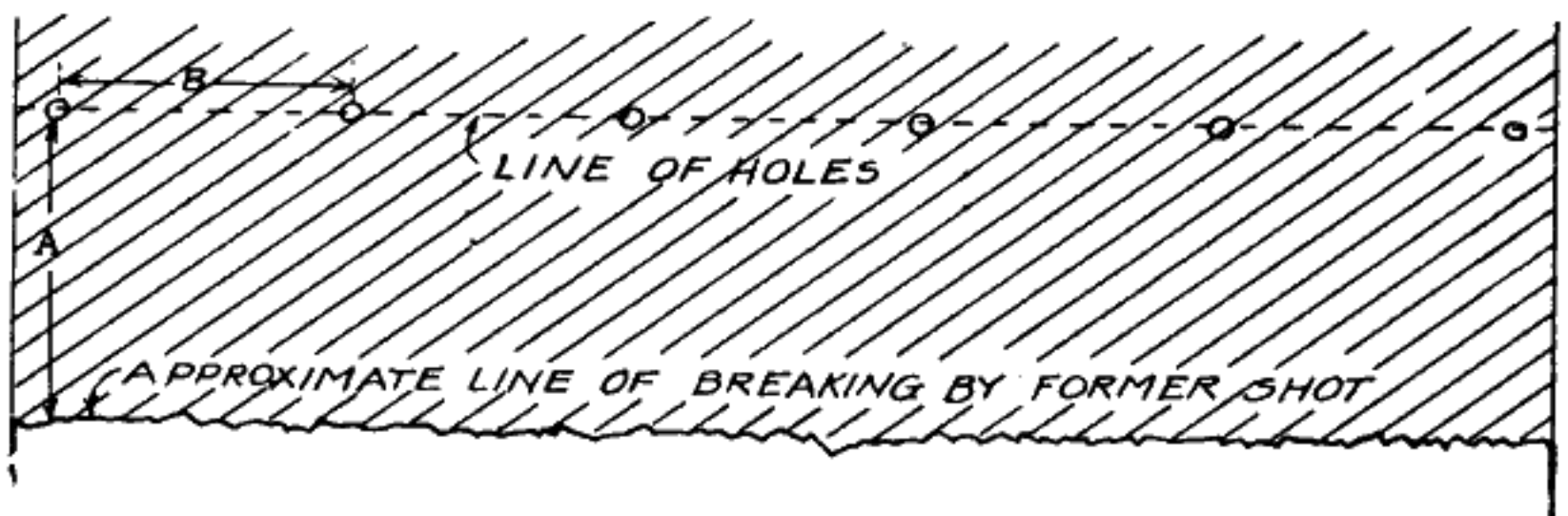


Fig. 94.—Plan of approximate loading for cut work. For shallow cuts the burden "A" is usually slightly greater than the depth of the cut and the spacing "B" slightly less. For deeper cuts, especially in rock, the spacing is usually one-half to three-quarters of the depth and the burden about equal to the spacing.

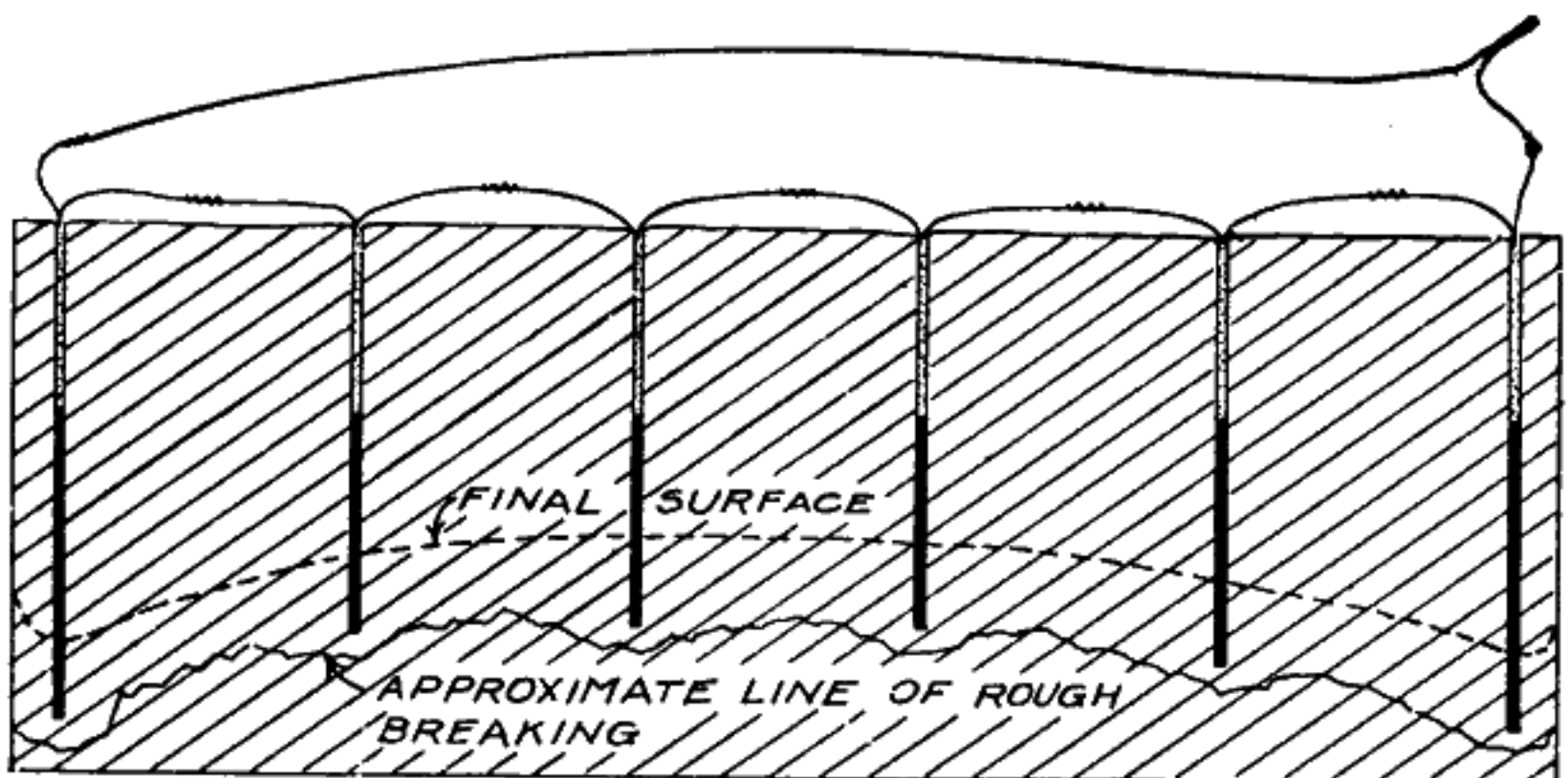


Fig. 95.—Elevation of approximate loading for cut work. To give the proper crown and sufficient depth for the side ditches, the holes away from the center are drilled deeper.

## Road and Railroad Building—Side hill cuts; high sides

*For Clay and Hardpan.*—Red Cross Extra 20% is ordinarily most satisfactory, though du Pont R. R. P. or blasting powder in sprung holes gives good results in deep cuts.

The amount of explosive to use in each bore hole is a matter that must be determined by test. The following recommendations may be of use to the beginner in deciding on loading:

In clay, load unsprung holes about half full of Red Cross Extra 20%. In sprung holes use about the same amount.

In shale, load slightly heavier, using the same explosive.

In rock, load unsprung holes slightly over half full of Red Cross Extra 40%.

If R. R. P. or blasting powder is used the amount must be increased. The only real information is obtained by a trial shot which, if there is no danger to property from flying matter, should be loaded somewhat heavier than seems to be required. The loading is reduced to the desired amount for the other shots.

**Side Hill Cuts.**—There are two methods of making these cuts. In one method (Fig. 96) all of the ground is excavated and the roadbed is on solid ground. In the other (Fig. 98), the cut is not made so wide, but the spoil is used in filling up the lower side to get the desired width.

In either case the cut can be worked from the side or the end. Working the full width of the cut from the end is better, especially if the spoil or muck is to be used elsewhere for a fill. This keeps a better cart way open.

In working from the end, the general rules laid down for through cuts apply, and the same explosives and loading are recommended.

In working from the side, slight variations are made depending on whether the excavated ground is used again for fill, or is wasted down the hill. If it is to be used for filling, the loading should be barely heavy enough to break the ground in good condition for handling. When it is to be wasted down the hill, heavy loading will throw it away so that little rehandling is required.

**High Sides.**—In highways the removal of high sides, ridges and "thank you marms" of compacted clay or of rock is accomplished by drilling shallow holes (Fig. 97) and loading with Red Cross Extra 20%. Such blasts so

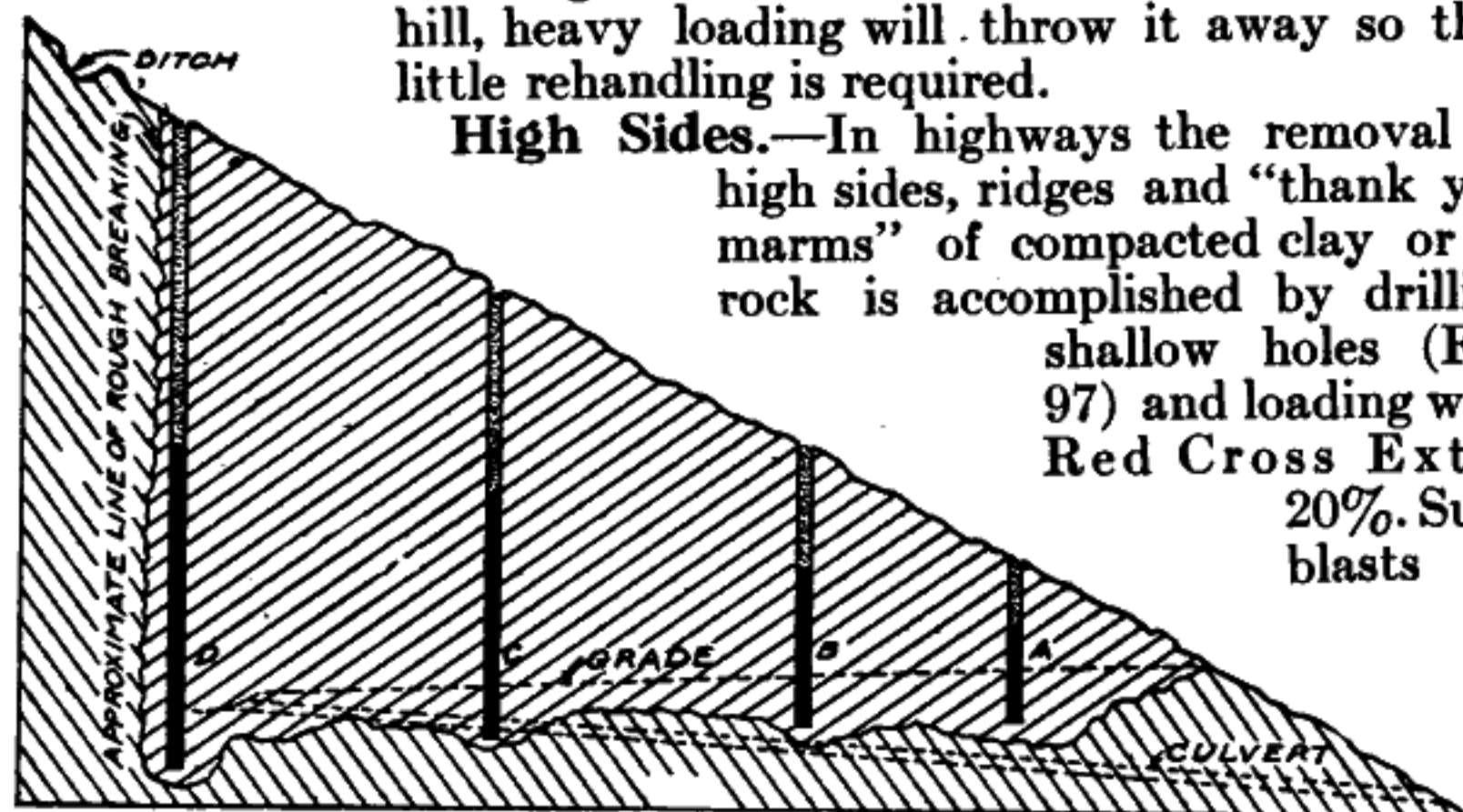


Fig. 96.—Approximate method of loading for side hill cut where excavated material is to be wasted or hauled elsewhere. In earth the side of the cut should be left sloping instead of vertical, to prevent caving.

## Road and Railroad Building



Fig. 97.—Blasting out a high side, "A" should be fired before "B." Where the high side continues along the road for some distance each set of holes should be fired together by the electric method.

loosen the ground or rock that it can be moved by means of scrapers and little or no hand labor is required.

**Miscellaneous Road Building.**—Digging outfall or discharge ditches for either roads or railroads is accomplished by blasting in exactly the same manner as is described for general ditching on pages 110 to 116. Side ditches are blasted in the same way. Light blasts are used to loosen the ground for road machines or hand digging. The blasting of trees, stumps and boulders from both side and outfall ditches is most effective. For the general drainage of the right of way much good can be done by blasting for stream connection. (See page 117.) Vertical drainage is

frequently effective (see page 118) for draining land-locked basins through which roads must pass.

For widening and straightening cuts the loading and explosives used are the same as for side hill cuts. Blasting down

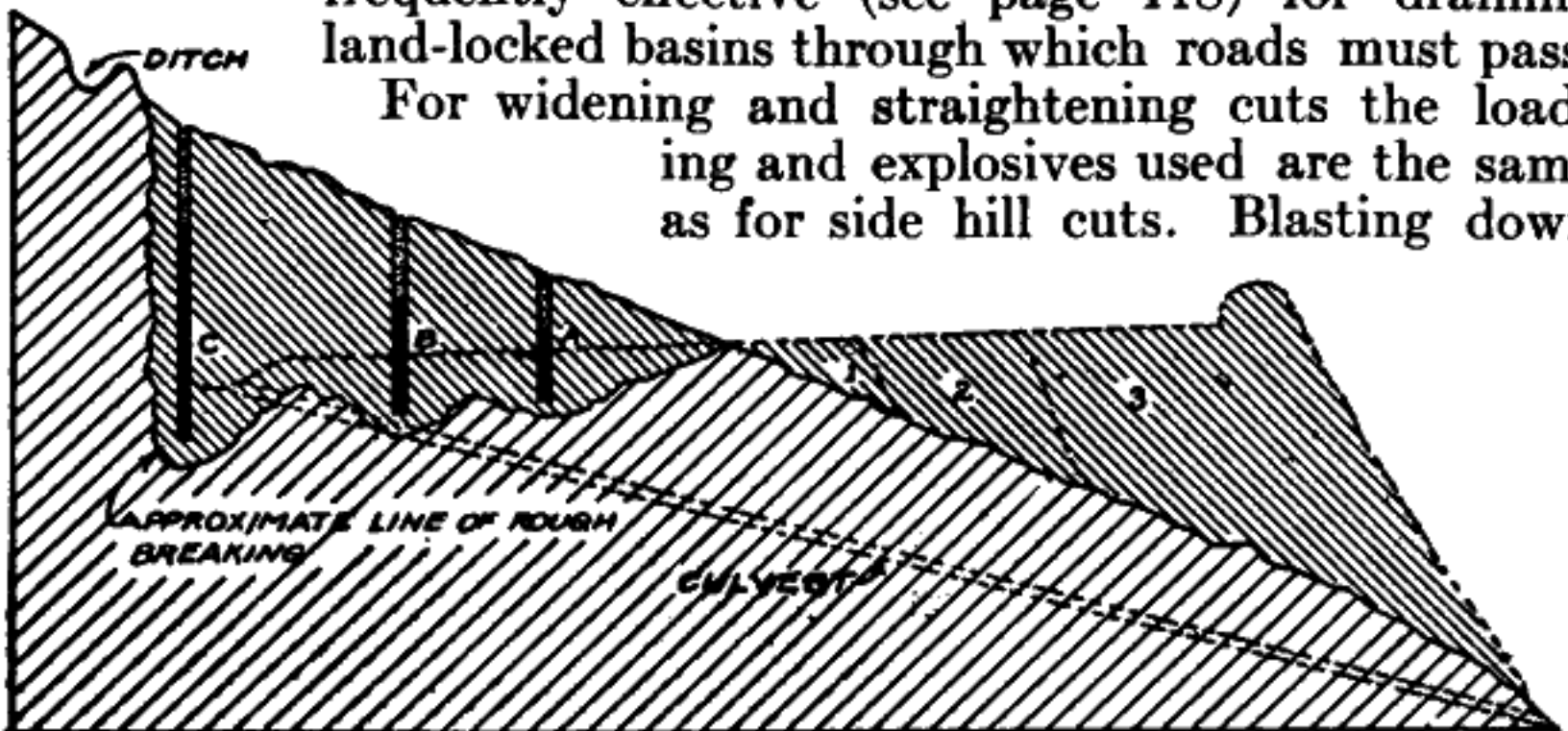


Fig. 98.—Approximate method of loading for side hill cut and fill. In earth or clay the side of the cut should be sloping to prevent caving. Another short-hole in the top of the bank will aid in making this slope.



### Digging Post and Pole Holes

gravel and other road surfacing reduces the amount of labor required for loading. (See methods on pages 129 to 138 similar to quarrying.)

Blasting for speeding up steam shovel excavation is effective. The bore holes are spaced about as for other blasting but, unless rock is encountered, are loaded much lighter, the object being simply to blast enough to loosen the material, making the digging easy.

### DIGGING POST AND POLE HOLES

Dynamite is useful in digging both shallow and deep holes for fence posts and for telephone and other classes of poles.

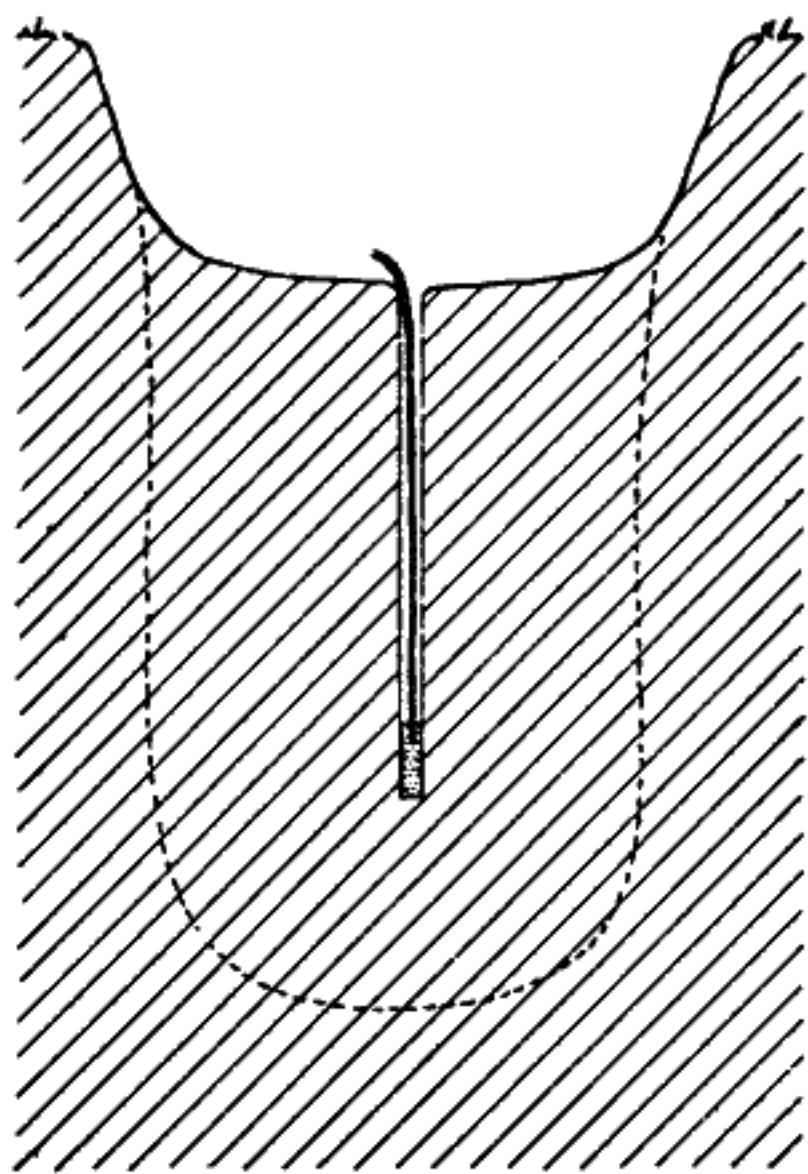


Fig. 99.—Method of loading to blast a shallow pole or post hole. The object is to loosen the soil so that it can be easily shoveled.

First remove the soft surface to a depth of from 6 to 8 inches, or down to the hard ground, and to the full diameter of the desired hole. This will prove helpful even where there is but a few inches of soft ground. The hole is then ready for punching the bore hole for loading.

**Shallow Holes.**—For shallow holes drill or punch a bore hole in the center of the shallow hole by a suitable method (page 59) to about the depth of the desired hole and load it with a small charge of Red Cross Extra 20%, primed with a blasting cap and fuse. A test shot will show whether the holes should be tamped or not. Such a blast will so loosen the hard ground or shale as to make shoveling easy (Fig. 99).

**Deep Holes.**—For deep holes the bore hole should be several inches deeper than the desired pole hole. The charge is prepared by cutting the dynamite cartridges into pieces from 1½ to 4 inches long and tying them to a lath as is shown in Fig. 100, the extreme end piece being primed. The entire charge is lowered into the hole (Fig. 101), so that the primer is some 18 ins. to 20 ins. below the surface, and fired. The effect of the blast is to spring the soil back and form the hole. As the blast has affected the soil to its full depth the hole is deeper than needed.

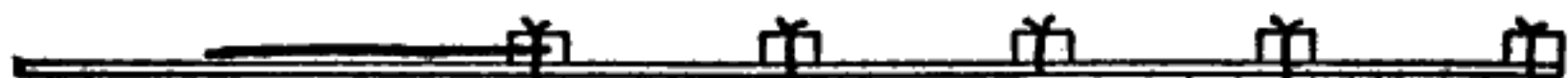


Fig. 100.—The size of each cartridge and distance apart on the stick are changed to suit the condition of the ground.

## Digging Post and Pole Holes. Digging Trenches

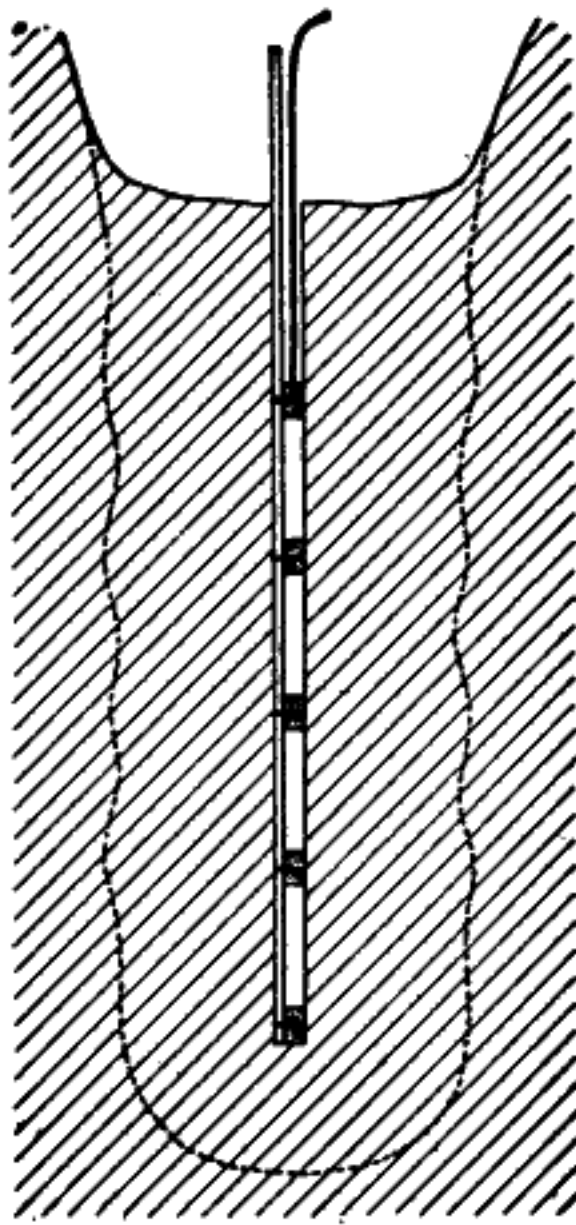


Fig. 101.—Loading a deep hole, showing the relative positions of the charges and primer tied to the lath. Dotted line indicates size and shape of the blasted hole.

the rock to the full depth of the blast. When the loose fragments have been removed, drill another hole to about the same depth and load as before.

The explosive used for this work should never be of a lower strength than Red Cross Extra 40%, and for hard rock 50 or 60% strength is often better.

This allows a space for the trimmings chiseled off the sides to fall, thereby reducing the amount of spooning required to complete the hole. The explosive recommended is du Pont Straight 40% or stronger.

As it is impossible to force back the sides of the holes in solid rock, as is done in blasting in hard clays, modifications in the method of loading are required for these holes.

After excavating the hole down through the soil, if any is present, drill a hole from 12 to 18 inches into the rock. Load this with a full cartridge primer pressed well to the bottom, tamp the hole tight, and fire.

If the loading is heavy enough this will shatter

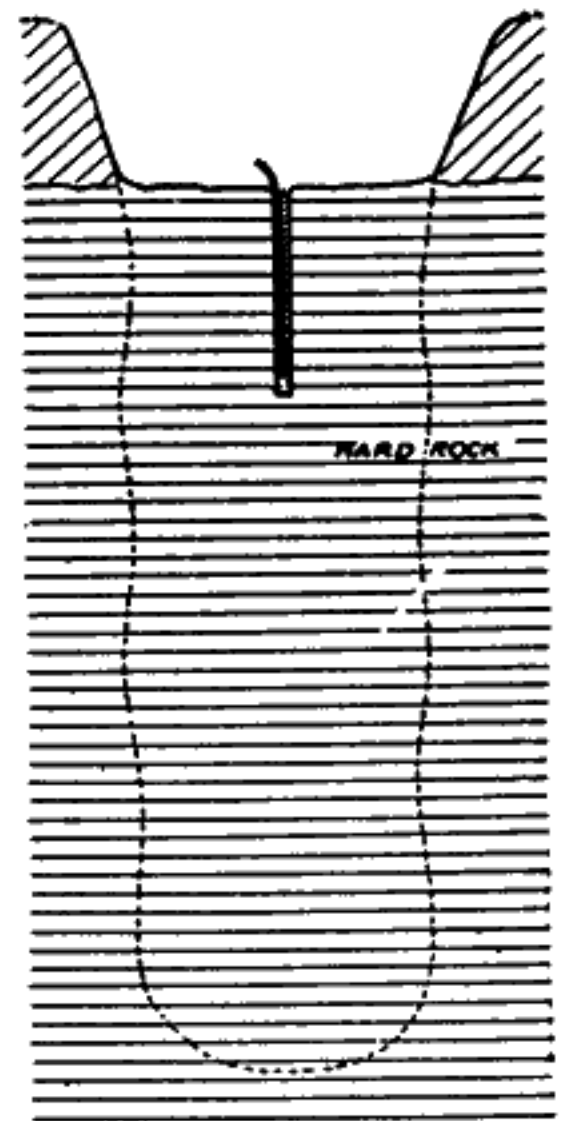


Fig. 102.—Method of loading to blast a pole hole in solid rock. The bore hole must not be deep. After the first blast clean out the fragments and drill a second hole. Dotted line indicates the shape of the blasted hole.

## DIGGING TRENCHES WITH VERTICAL WALLS

For blasting in vertical wall trenches such as pipe line and sewer trenches, the methods recommended for open drainage ditches are not applicable, as the soil is blown away, the top is too wide, and back filling is expensive. In this case all that is needed is a complete loosening of the rock or ground.

The soft, easily dug earth is removed from the top so that the hard ground or rock is exposed to the full width of the trench. One or two sloping holes similar to the cut shot (Fig. 103) are used to loosen the ground to the desired depths. This creates a pit or opening into which subsequent blasts throw the loosened earth.

## Digging Trenches. Scrapping Heavy Machinery

Holes are then drilled along the center line of the trench as is indicated in Fig. 103. Ordinarily these should be fired in succession in order to overcome the difficulties encountered when long lines are fired. In cities or towns each hole should be fired separately with an electric blasting cap, for added safety.

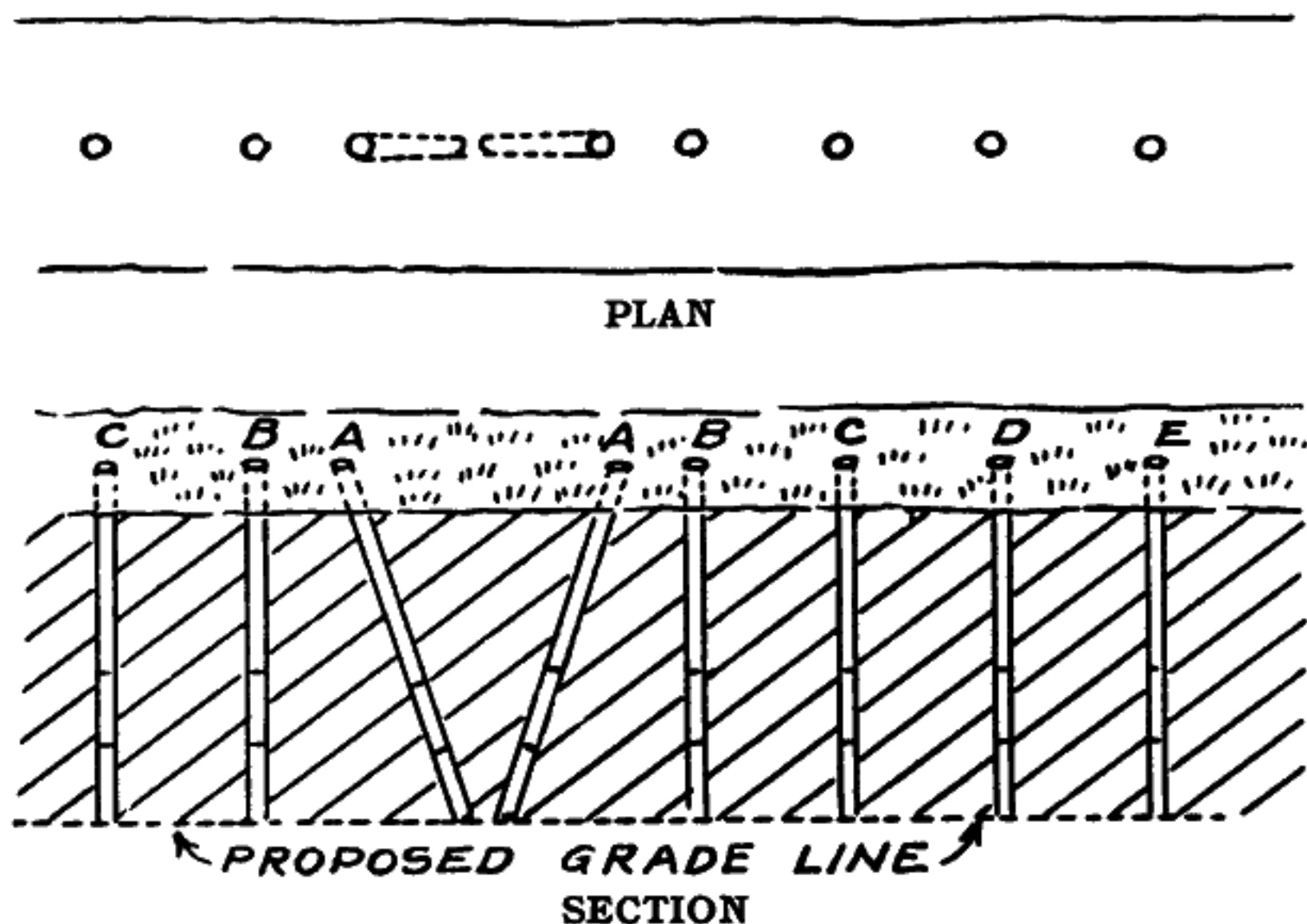
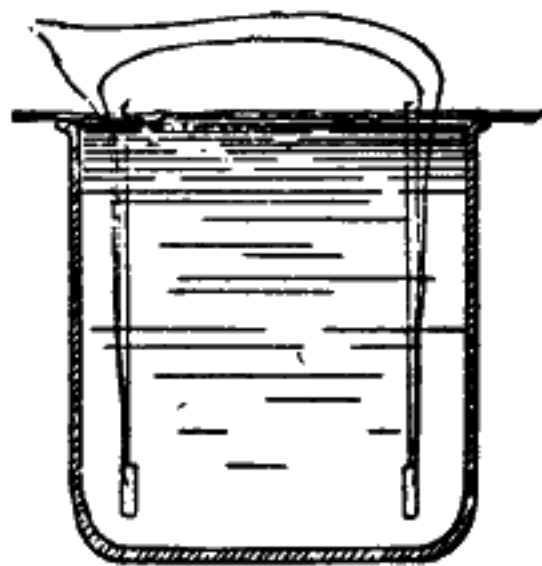


Fig. 103.—Method of loading a sewer or pipe line trench. The holes AA are fired and the débris cleaned out. Then the other holes, B, C, D, and on down the trench line are drilled and fired in succession.

## SCRAPPING HEAVY MACHINERY

The method of blasting heavy machinery for breaking it into scraps must depend on the nature of the material. Large castings are usually broken by mudcaps used in the same manner as for boulders. (See Fig. 120, page 96.) The explosive recommended

Fig. 104.—An open vessel is filled with water and a charge of dynamite, properly primed, lowered to a point near the thickest or strongest metal. This charge must not be actually in contact with the metal. For large vessels, two or more charges are used and fired electrically. The dynamite causes the water to transmit a powerful blow to the sides.



is Red Cross Extra 40% for small pieces and du Pont Straight 50% for hard or large pieces. Occasionally a bolt hole makes an excellent place for loading a block hole shot.

Old retorts, stills and other hollow castings can be easily broken by filling with water and suspending charges of one-half cartridge of any available dynamite so that they hang in the water and about 6 or 8 inches from the side of the vessel. Electric firing is always preferable and must be practiced when more than one



**Scrapping Heavy Machinery. Blasting Frozen Material in Railroad Cars**

charge is used in a vessel. In this blasting the concussion is carried through the water to the sides of the vessel. (See Fig. 104.)

Old boilers may be scrapped as has been described for retorts, or sheared apart by using long mudcaps along the plate seams.

When there are buildings near at hand that may be damaged by flying bits of iron, use should be made of either blasting mats or a substitute of tree boughs or planks.

Structural steel shapes and forms consisting of riveted plates can be very easily broken up and sheared off by using 50% du Pont Straight in a long mudcap strung along the riveted seam or joint. (See Fig. 105.)

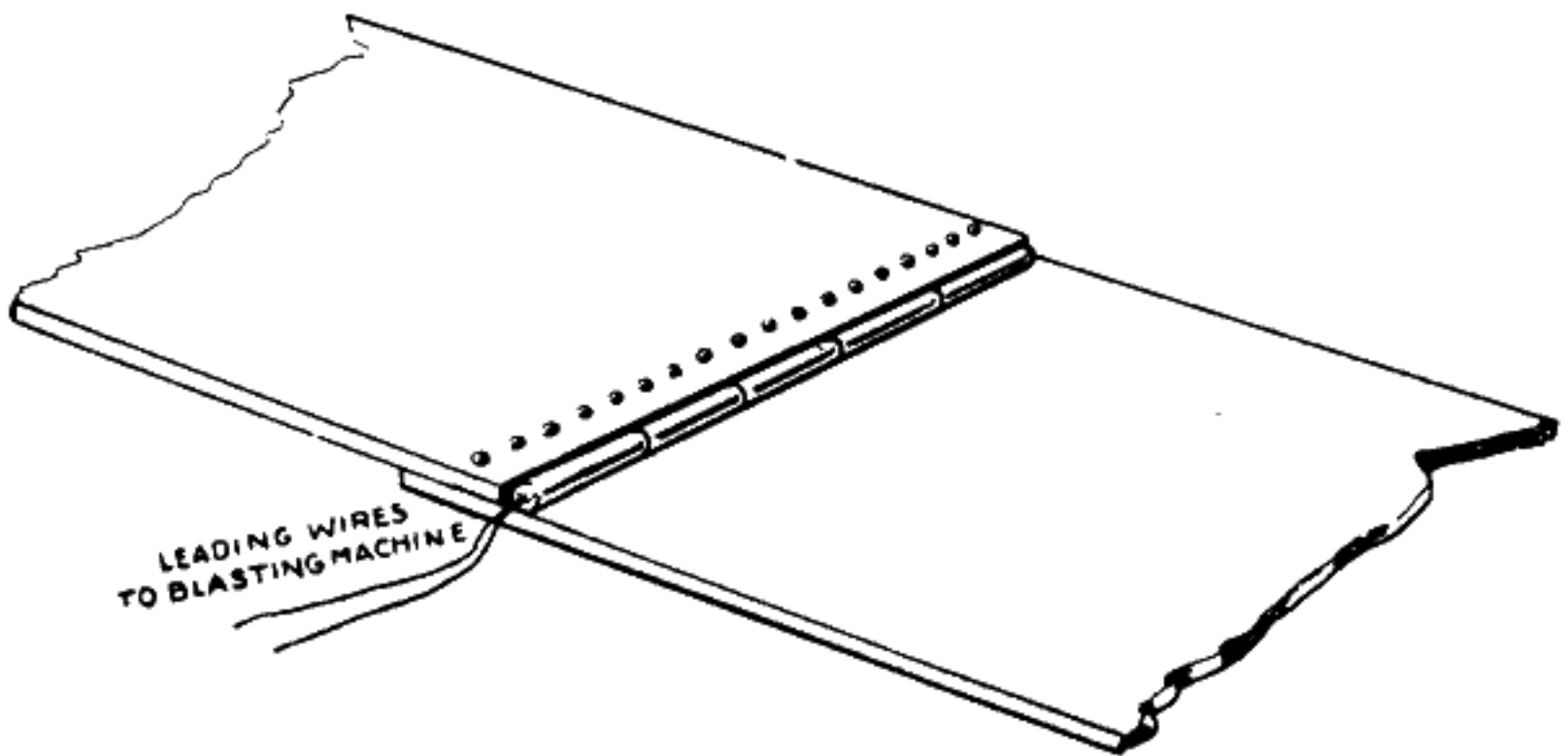


Fig. 105.—By stringing cartridges along the seams and covering with mud the plates can be easily sheared. Sometimes the cartridges can be split lengthwise into halves or quarters for light plates.

**BLASTING FROZEN MATERIAL IN RAILROAD CARS**

In cold weather such material as ore, sand, gravel, cinders and coal frequently freezes after having been loaded into cars and this seriously interferes with unloading. Blasting with light charges of explosive is very effective, quick and economical, the frozen material being shattered and broken up for easy handling.

In hopper bottom and gondola cars, which are unloaded through chutes or hoppers in the bottom of the cars, the freezing generally occurs in the hoppers or chutes. This plugs the outlet so that the loose, unfrozen material above cannot run out through the chute. In blasting to open up the hoppers, the door is swung open and a hole large enough in diameter to accommodate a cartridge of dynamite is driven into the frozen material (see Fig. 106). The hole should extend just barely through the stratum of frozen material. If the hole is too deep, and the dynamite cartridge loaded in the loose material back of the frozen stratum, much of the force of the explosion will be expended upon the already loose material instead of shattering the frozen stratum.

One hole is usually sufficient for each chute, and the amount of dynamite generally used is from one-half to a whole cartridge per hole. Red Cross Extra 40% is the most satisfactory for this work, as it is low freezing. Blasting caps and fuse may be used

**Blasting Frozen Material in Railroad Cars. Blasting Old Foundations**

to detonate the explosive, but electric blasting caps fired by a blasting machine are much safer and more satisfactory in every way. By their use considerable time is saved in waiting for the fuse to burn and the dynamite is not exposed to the cold for so long a time.

If the dynamite is frozen, care should be taken that it be well thawed before loading. The holes should be well tamped and fired as soon as possible after loading before the explosive has become chilled from contact with the frozen material.

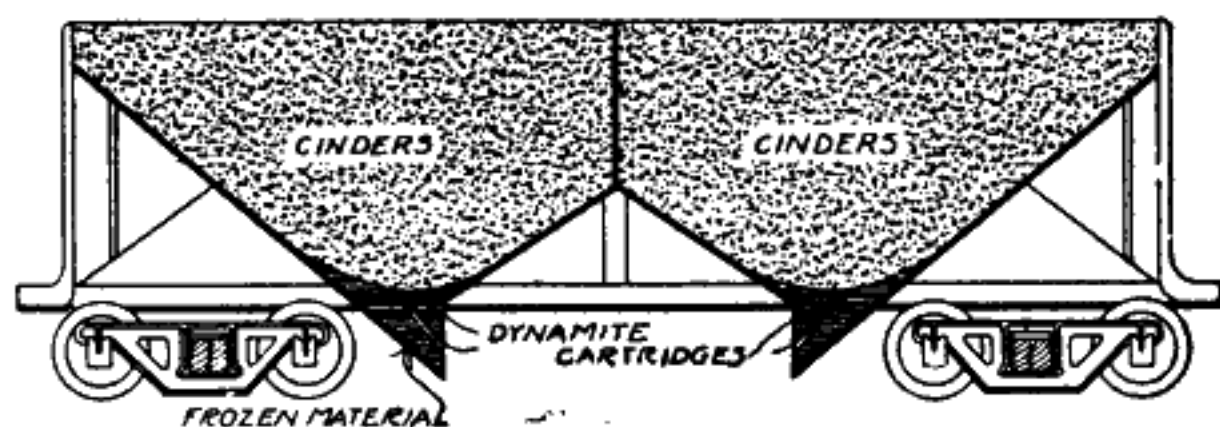


Fig. 106.—Showing charges of dynamite in place for blasting frozen material from hopper bottom railroad cars.

In open top cars the material sometimes freezes on top. Where this occurs, several holes driven down just barely through the frozen crust, about three feet apart, loaded and fired electrically as above described, will shatter up the crust so that it can be easily handled.

**BLASTING OLD FOUNDATIONS**

Old concrete walls, foundations or engine beds can be most economically removed by means of explosives.

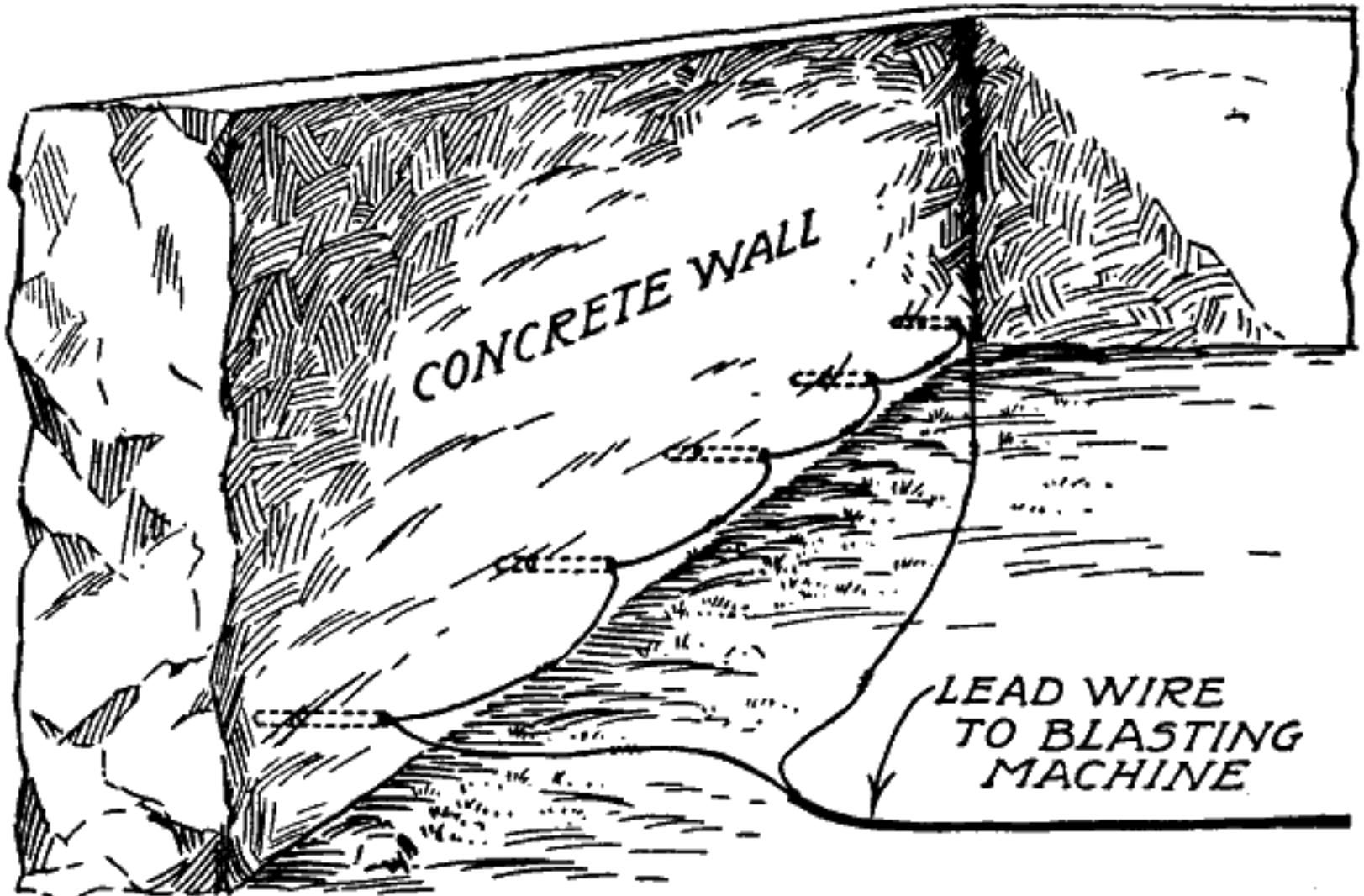
If it is found necessary to remove a wall of concrete or brick, it can be best done by boring holes either with a hand or power drill at the bottom of the wall. Holes should be drilled to a depth equal to three-quarters of the thickness of the wall and about 4 feet apart for walls 10 feet high or under. From one-half to one cartridge of Red Cross Extra 40% should be loaded in each hole and all connected up electrically and fired at one time. If any fear is felt in regard to throwing debris out of bounds, heavy ties or other lumber should be piled against the wall in front of the holes.

For removing concrete foundation or engine beds inside a building, especially if there is other machinery nearby, great care is necessary in the use of explosives. It is best to shoot one hole at a time. If an engine bed, a vertical hole should be drilled a depth nearly equal to the thickness and one-half cartridge of Red Cross Extra 40% used per hole. Holes should be well stemmed with clay. As a general rule about one-quarter of a pound of Red Cross Extra 40% should be used per cubic yard of concrete. As an extra precaution it is well to protect adjacent machinery by stacking railroad ties or other heavy timber between it and the blast, or the

**Blasting Old Foundations. Blasting Ice Gorges**

concrete to be blasted can be covered with a blasting mat before the shot is fired.

Sometimes best results are obtained, especially if the mass is of small section and high, by drilling a horizontal hole near the base.



**Fig. 107.**—Light charges electrically fired in the bottom of walls and foundations will shatter them so that they are easily removed.

In this case the hole should be drilled to a depth equal to three-quarters the thickness of the block as in blasting a wall and loaded in same proportion, one-quarter of a pound to the cubic yard. In all cases be sure to tamp holes solidly and take every precaution to protect nearby machinery.

Experience has taught that the better the concrete the more easily it is broken. It is not necessary in work of this kind to shatter or throw the material too much, but to crush and break it so that it can be easily barred or picked down.

If work is done in the open several holes can be loaded and fired at one time, electrically, with greater efficiency.

When blasting inside a building all doors and windows should be opened so as to avoid breakage from the concussion.

**BLASTING ICE GORGES**

Frequently ice gorges so choke running streams as to cause serious danger to bridges, dams and other structures. Blasts to break these up should be directed at the key or pivotal points of the gorge. The most common mistake is to underload. Two general methods of loading are practical:

(1) Holes are cut through the ice at frequent intervals and the charges, the quantity of which must be governed by the thickness of the ice, tied to blocks of wood, thrust through the holes and allowed to float under the ice a little way from the holes. Such blasts heave the ice and thus break it apart. (See Fig. 108.)



### Blasting Ice Gorges

(2) Large mudcaps are loaded on the top of the ice at frequent intervals, and fired.

As this work must, as a rule, be done on short notice little time is afforded to obtain the correct explosive, so the recommendation is made for any low freezing dynamite available. Electric firing should be used for safety as well as for the benefits derived from all charges firing at exactly the same time.

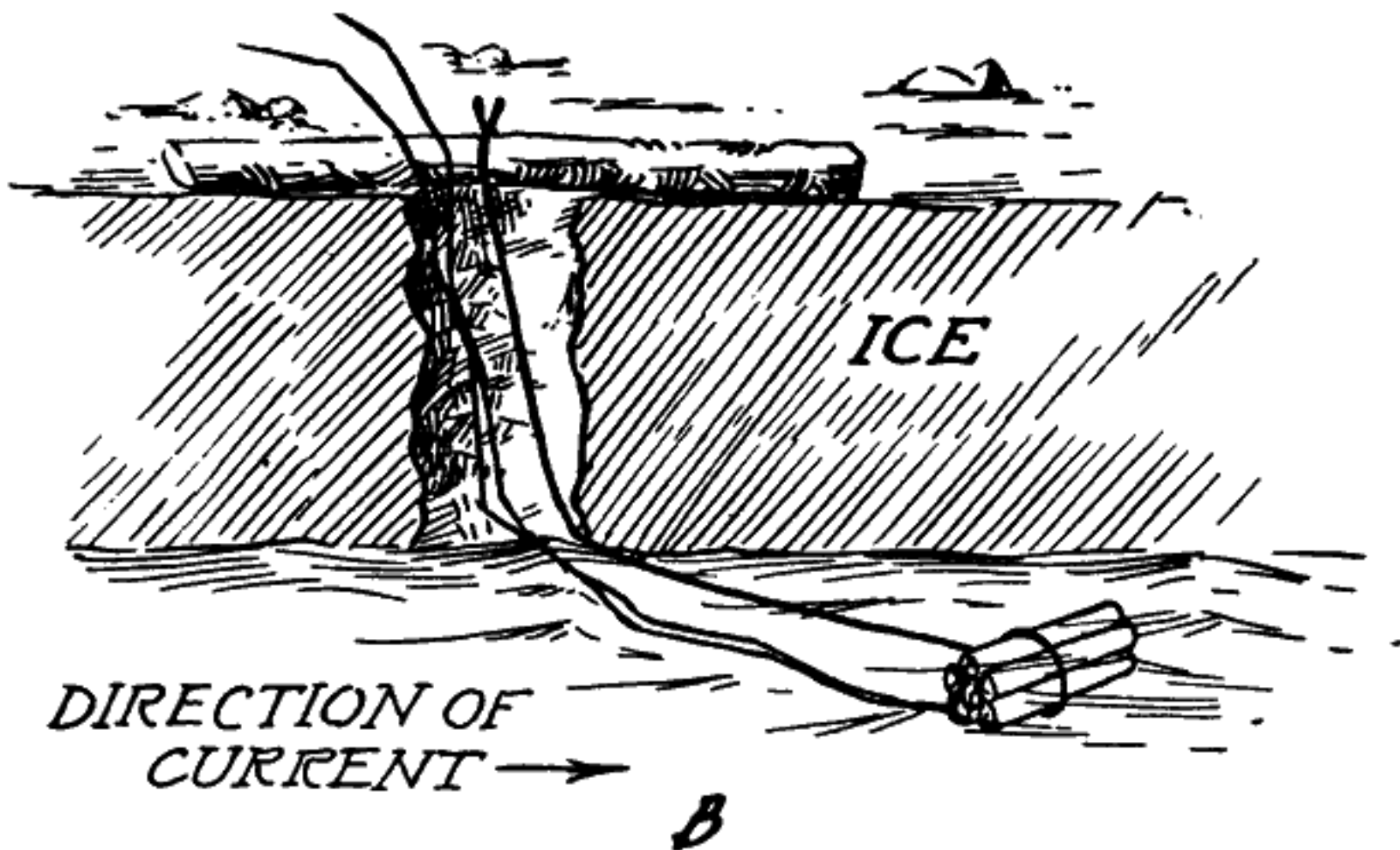


Fig. 108.—A bundle of cartridges primed with electric blasting cap floating under an ice floe. When fired, this breaks up the ice and allows it to float away.

Moving floes of ice must usually be broken by the second method. The explosive primed with a blasting cap and a short section of fuse can be dropped on the floe from the shore or from the down stream side of a bridge. (See Fig. 109.)

It is difficult to give any definite amounts of explosives to be used for blasting ice, but where the broken ice is three or four feet thick, the charge of explosives should be not less than ten pounds. Where the ice gorge runs up to twenty and thirty feet in depth, it may require 1,000 or 1,500 pounds of dynamite fired under it to obtain any results.



Fig. 109.—Showing bundle of cartridges tied together with fuse and cap, used to mudcap floating pieces of ice.

## BLASTING LOG JAMS

Log rafts or jams, on careful examination, are usually found to be tied together or held by a log or several logs that act as a key or pivot. It is against this point that attention should be directed. The use of heavy charges of dynamite is usually necessary. The loading should be done as quickly as possible, as it is usually dangerous to remain long on the jam. The dynamite can be loaded into a bag or box, primed and placed in the water as near the key logs as possible. Firing should be by means of electric blasting caps, as there is danger of the loader having difficulty in reaching a point of safety when using blasting caps and fuse.

## CLEANING OUT SMOKESTACKS

In many industrial plants there are large smoke or kiln stacks that become clogged with soot. It is necessary, in order to maintain draft, that they be cleaned frequently.

A simple, economical and most efficient method to accomplish this is to shoot the stack with the "stack gun" and FFF Blasting Powder. This gun can be used in cleaning either lined or unlined stacks, brick or steel, without any fear of injury to the stack or lining.

The gun can be made out of an old piece of shafting about 4 ins. in diameter and 14 ins. to 16 ins. long. Bore a hole  $1\frac{3}{4}$  ins. in diameter and 10 ins. long in the center of the piece. Then bore a small horizontal hole quarter of an inch in diameter through the piece to the bottom of the center bore. This hole serves as a touch hole for inserting the fuse.

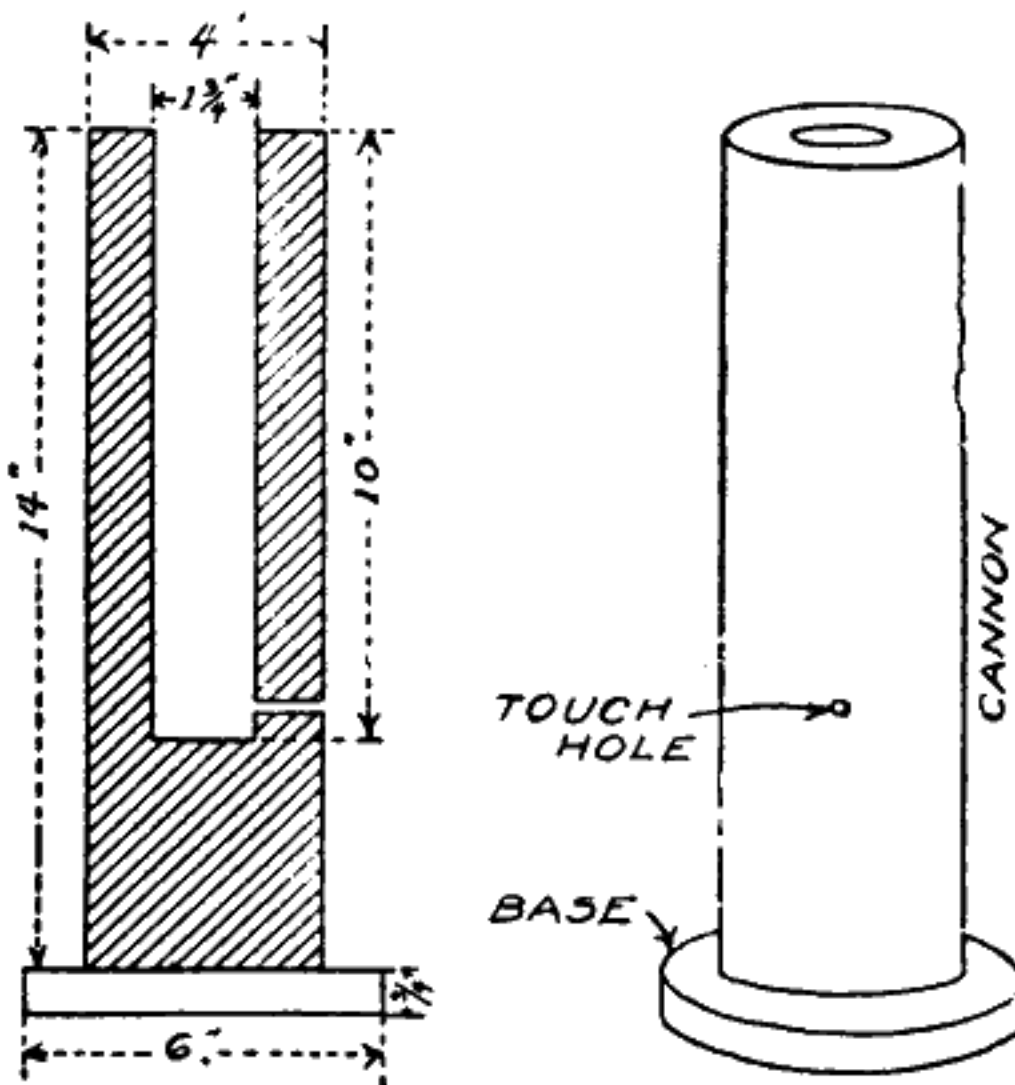


Fig. 110.—Details of a stack gun or cannon. This is loaded with blasting powder placed in the bottom of the stack and fired.

The whole thing can be mounted on a pedestal about 6 ins. in diameter so that it will stand in an upright position.

The method of operation is as follows. Pour some FFF Blasting Powder into the mouth of the cannon to about 2 ins. from the top. Tamp to the collar with dry clay. A short piece of fuse is inserted in the touch hole and in contact with the main powder charge. Open the flue door at the bottom of the stack, set the cannon on the bottom and in the center of the stack, light the fuse and close the flue door.

**Stump Blasting—Tap-rooted stumps**

The explosion shakes and loosens the soot adhering to the sides causing it to fall to the bottom. It can then be removed through the flue opening.

A charge of 8 inches of FFF Powder, one and three-fourths inches in diameter, is sufficient for a stack up to 100 feet high, and four feet in diameter, or over. The number of shots necessary to thoroughly clean a stack depends upon its condition. Ordinarily three or four shots will clean a stack, but if very dirty it may require more. The size of the charge and length of the cannon can be regulated to suit the height and diameter of the stack.

There is no doubt about the efficiency of this "gun" for cleaning smokestacks. One of the largest manufacturing concerns in the country has used this method for several years, without an accident or injury in any way to the stacks.

**STUMP BLASTING**

Stumps take up room in the field and reduce yields; prohibit the use of improved machinery and increase the cost of cultivation; break and destroy tillage equipment; harbor vermin, plant diseases and weeds; are unsightly and detract from the value of a farm.

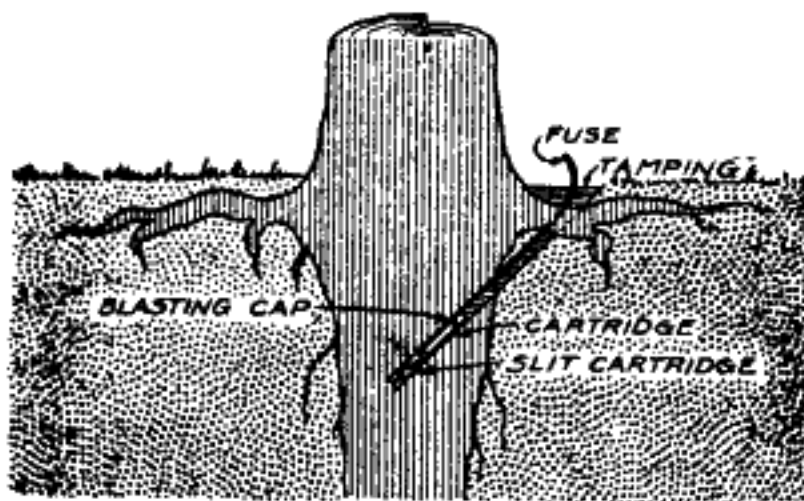


Fig. 111.—Loading of a tap-rooted stump with a single charge, using cap and fuse.

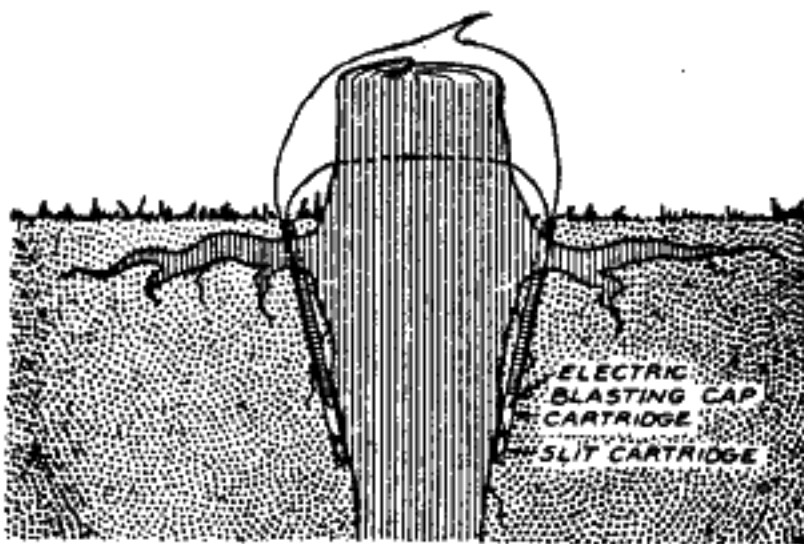


Fig. 112.—Loading a tap-rooted stump for an electric blast. Two or more charges are used.

Different classes of stumps have very different roots. Some have heavy tap roots, others only lateral, spreading roots, while some have both kinds. The loading must suit the nature of the roots, and be placed to break their hold in the soil.

Green stumps are harder to blast than dead ones, and require a larger amount of explosives. Stumps are easier to blast out of firm soils than out of loose sandy soils, and allowance for this must be made in placing the charges. Some clay soils become very springy when wet and do not afford good confinement for the exploding charges. A few small stumps should be tried first to arrive at a correct loading. Sandy soil when it is wet confines the explosive better.

**Blasting Tap-Rooted Stumps.**—There are two methods of loading tap-rooted stumps:

(1) Remove a little soil and expose the tap-root to a depth of about 18 inches, with a wood auger bore a hole diagonally downward and a little more than half way through the tap-root, pack



**Stump Blasting—Small stumps; large stumps**

the charge into the hole and tamp well. (Fig. 111.) The amount of charge should conform to the diameter of the tap-root and size of the stump.

(2) Bore or punch two or more holes into the earth immediately alongside of the tap-root. These should be spaced equally around the root and put down to a sufficient depth to break off and lift out the stump and roots. The charges must be fired together with electric blasting caps. (Fig. 112.)

The first method requires the most labor.

The second method required the most explosives.

The first method, because it splits the wood up better, is best when the fragments are to be used for fuel or distillation, but the second method is best where the brace roots are very heavy or it is desirable to get out all of the tap-root.

Red Cross Extra 20%, or if the soil is light—Red Cross Extra 40% is the explosive recommended.

**Loading Small Stumps.**—To blast a small green oak or similar lateral rooted stump out of a sandy soil, punch a hole

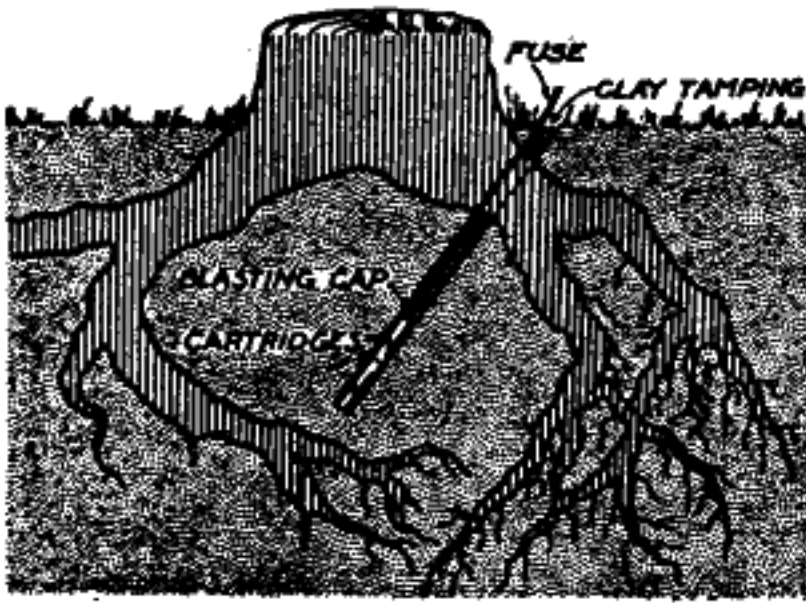


Fig. 113.—Method of loading a small stump. Keep the charge well down.

diagonally under the main part of the stump to a depth of not less than 3 to 3½ feet, and load with Red Cross Extra 30% or Red Cross Extra 40%. In firm clay soil the hole may be shallower, and Red Cross Extra 20% substituted in the loading.

A single hole is punched well under the main part of the stump and carefully loaded. Blasting caps and fuse are generally used.

**Loading Large Stumps.**—To blast a large green oak stump from a firm soil, place a hole diagonally under the main part of the stump as has been described for small stumps, and place other holes under the heavy brace roots. Use Red Cross Extra 20%; or 30% for light soils. Load the center hole heavily, and the other holes more lightly, and fire with electric blasting caps.

**General Notes on Stump Blasting.**—Hollow stumps should be blasted by electrically fired shots. It is often advisable to tamp the hollow full of soil. Small hollow stumps can be blasted by punching a deep hole through the hollow, loading and tamping tightly both the bore hole and the hollow in the stump.

In stump blasting the charge is loaded at the bottom of the hole, and breaks out through most soils in such a way as to form an inverted cone, the top of which is a little less than twice the depth of the hole. The charge should be deep enough to make the cone include all of the stump and part of the main roots, and must be heavy enough to lift this entire cone of soil and the stump into the air.

## Stump Blasting

To remove the stumps from a large area where most of them are large and have heavy brace roots, use a combination of blasting and pulling, using dynamite for removing those easily blasted and splitting the large ones and pulling the fragments by means of a puller, traction or donkey engine.

The exclusive use of dynamite is recommended when the stumps are scattered, or where there is but a little work to do, because it is much cheaper in that there is no outlay for expensive equipment, and the machinery need not be moved so often.

Electric blasting is used in preference to cap and fuse where the stumps are so large that more than one hole is necessary in blasting, and where hollow stumps must be blasted by means of a circle of holes. In boring into the roots of large stumps a heavy wood auger with a solid handle not less than  $4\frac{1}{2}$  feet long is needed. Either a crow bar or punch bar and a soil auger is useful for making holes in the ground under stumps. Deep holes are desirable.

The explosives recommended for blasting stumps are: Red Cross Extra 20% for heavy firm soils or in wet soils that offer good resistance; Red Cross Extra 30% in lighter soils; and du Pont Straight or Red Cross Extra 40% in loose sandy soils where quicker action is necessary. These are all low-freezing explosives.

With several cartridges in a bore hole under a stump, place the primer last or next to the last cartridge toward the top of the hole, with the blasting cap or electric blasting cap pointing toward the main part of the charge. The tamping should be carefully and thoroughly done.

In water try not to injure the paper shell so as to guard as far as possible against injury from water. Fire soon after loading. If the water covers the charges to a depth of a foot or more, no other tamping is needed.

The same care as to safety of the blaster and all spectators should be observed as noted on pages 76 to 78.

Where there are any gullies, dispose of stump fragments by throwing them into the bottoms where they will help catch the silt

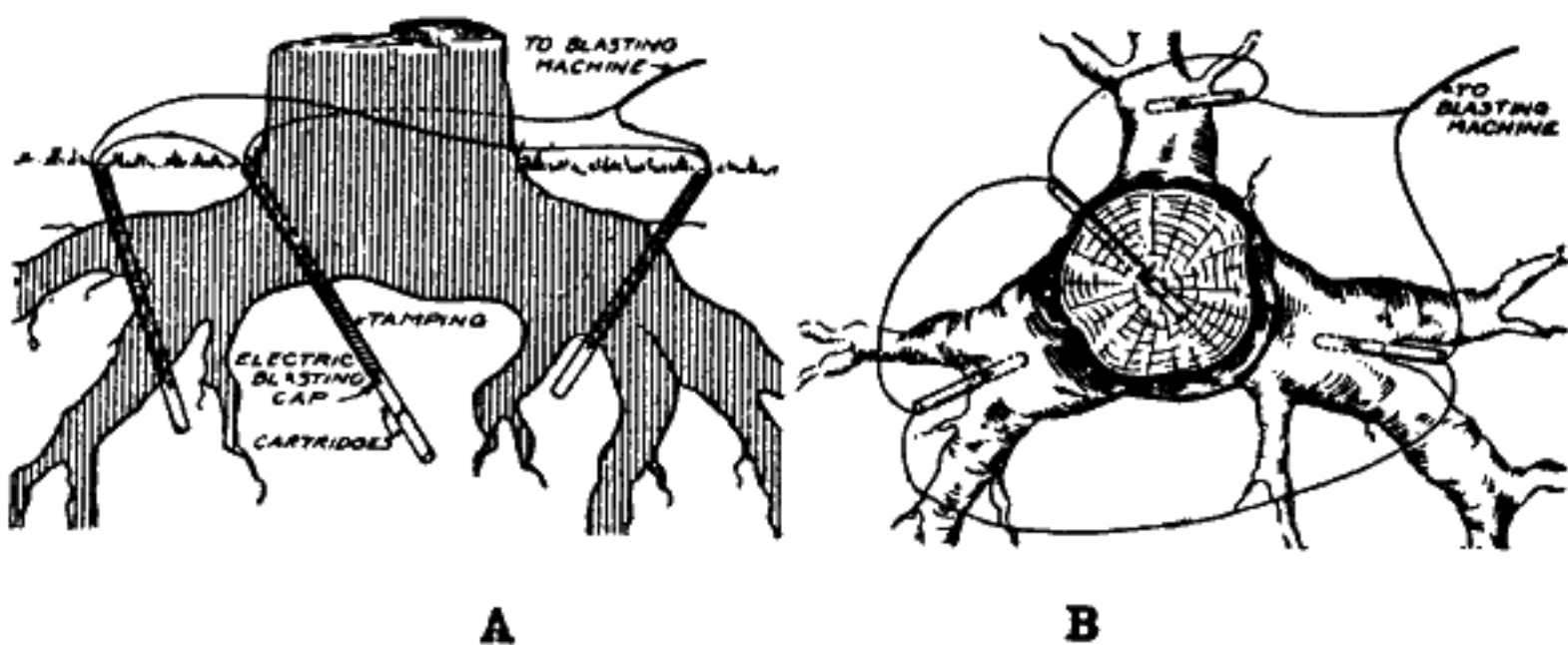


Fig. 114.—Method of loading large lateral rooted stumps with distributed charges, for an electrically fired blast. "A" shows where the holes should be started, and in a general way, how they should point, and how the wires are connected in series to the leading wire. "B" shows the location of the holes under the stump.

**Boulder and Ledge Blasting—Blockholing**

and sand, and where they will act as blind drains when the gullies are finally filled.

Fat pine stumps are sold to companies interested in wood distillation when the distance to the plant is not too great to make it unprofitable. By selling the wood, such stumps can usually be disposed of for enough to pay the cost of clearing the land. They can sometimes also be sold to homes for fire wood or kindling at good prices.

**BOULDER AND LEDGE BLASTING**

Boulders offer the same troubles as stumps, in fields, roads and in construction work. Blasting with dynamite is the quickest and easiest method of disposing of boulders. There are three methods of loading: (1) Blockhole. (2) Snakehole. (3) Mudcap.

**Blockholing.**—Blockholing consists of drilling a hole into the boulder and charging it with a small amount of dynamite. It is the best method for breaking very hard or very large boulders, especially those of the "nigger-head" type that are difficult to break by other methods. The hole should usually be drilled about half way through the boulder and may be an inch or larger in diameter.

The explosive is sometimes removed from the shell and packed firmly into the bottom of the hole. When the entire charge is in, make a hole for the cap in the top of the powder with a pointed hardwood stick. Press the cap into the hole and tamp it in with moist soil. The hole should be tamped full.

As the confinement is perfect in such loading any of the du Pont high explosives recommended in this book will give good results. Red Cross Extra 20% is especially recommended.

Blockholing is very effective in blasting out-cropping ledges that are too large to remove entirely.

A good tool for examining the size and location of submerged boulders can be fashioned from quarter inch iron rod (Fig. 117). The sharpened end is punched into the ground.

Boulder fragments can be most easily loaded on sleds or stone boats. For long hauls, wagons or carts should be used. They

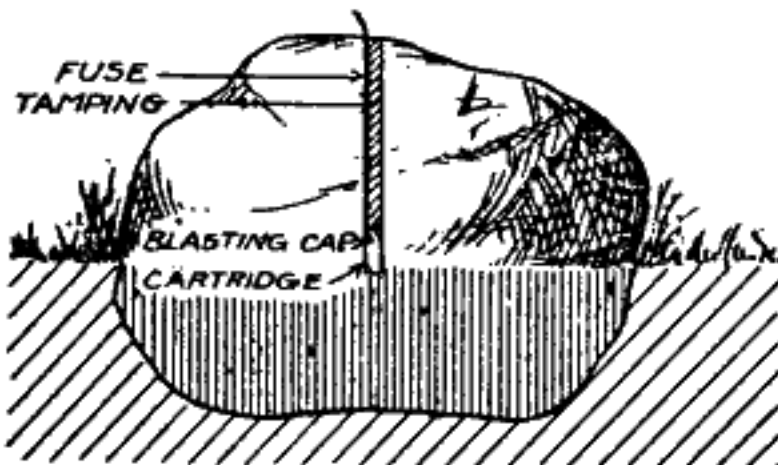


Fig. 115.—Properly placed block hole charge for shattering a large boulder. The hole is drilled about half way through the boulder, carefully loaded, tightly tamped and fired with cap and fuse.

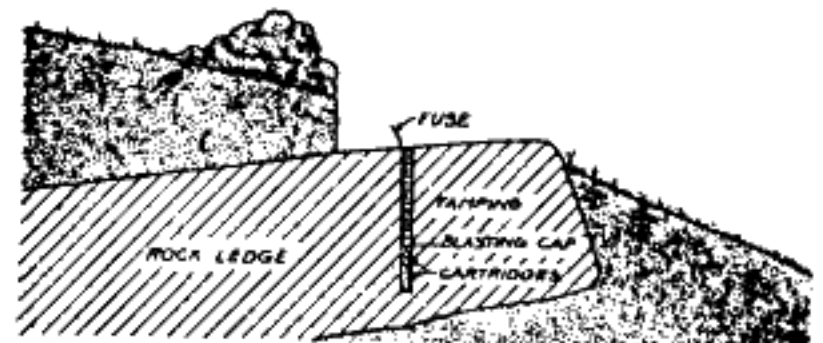


Fig. 116.—Correct method of loading the out-crop of a rock ledge.



**Boulder and Ledge Blasting—Snakeholing**

make excellent material for roads, fences, stone for concrete and filling for gully bottoms.

**Snakeholing.**—Snakeholing consists of punching a hole under but immediately against the bottom of a boulder and placing the charge of explosives in as compact a shape as the size of the hole will permit. A better idea of the method can be had by studying Fig. 119. The explosive, being confined on the underside by the earth, can exert a powerful blow on the boulder and will roll it out, or if a sufficient charge is used will break it in fragments.

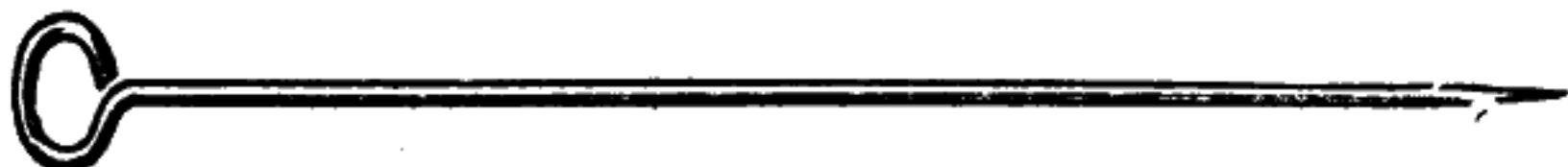


Fig. 117.—Sounding rod for examining the size and location of buried boulders.

This is one of the easiest and most successful methods of boulder blasting. The best explosives for this work are either Red Cross Extra 30% or Red Cross Extra 40%. Red Cross Extra 20% is good where the soil is heavy and offers enough resistance. Electric blasting is not generally used unless the boulders are very large and more than one charge is used to blow them out. Some blasters prefer to roll boulders out with a snakehole shot and later break them with a mudcap.

Frequently a combination of a mudcap or even several mudcaps with one or more snakeholes is most effective.



Fig. 118.—Stone boat suitable for hauling boulder fragments for short distances.

**Boulder and Ledge Blasting—Mudcapping; table of charges for boulder blasting**

**Mudcapping.**—Mudcapping is known by a variety of names, such as “bulldozing,” “blistering,” “poulticing” and “adobe shooting.” It is made possible by the fast, shattering action of the higher grades of dynamite. One method of mudcapping consists of removing the dynamite from the shell and packing it in a compact conical heap on the boulder, and, after inserting a cap and fuse, covering it with several inches of thick, heavy mud. Where there is a great deal of this work to be done, the explosive is not removed from the wrapper, but whole or half cartridges, sometimes slit, are arranged as compactly as possible at a given point on the boulder. The cap is inserted in the end of one of the cartridges, and the whole charge covered with mud.

The explosive should be placed on the boulder at the place where the rock would be struck with a hammer were it small enough to break in that way. This may be on the top or the side. If the boulder is embedded in the ground, a snakehole shot to roll it out on the surface should first be made, because the confining dirt makes it much harder to break with a mudcap shot. The mud

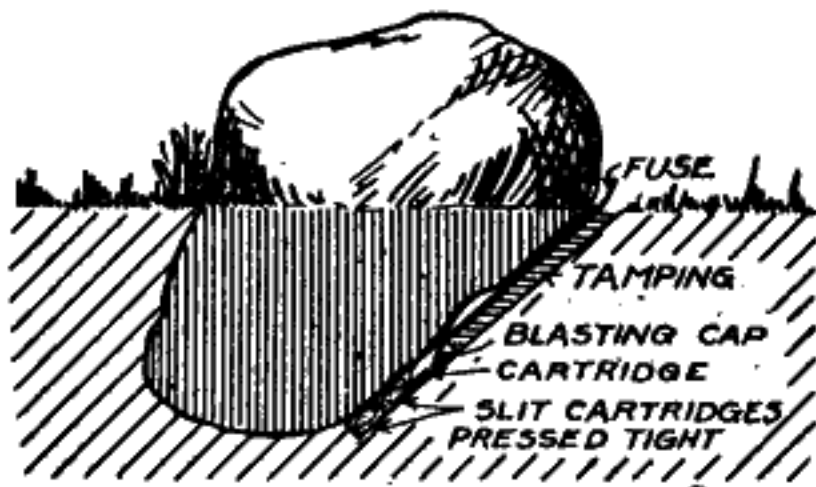


Fig. 119.—Proper method of placing and loading a boulder for breaking or moving it with a snake-hole shot.

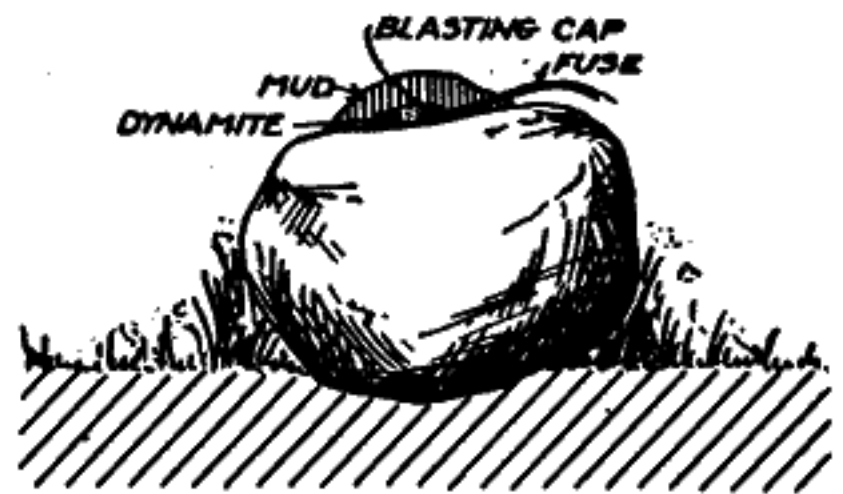


Fig. 120.—Correctly placed mud-cap. The mud covering should be several inches thick.

**Table of Charges for Boulder Blasting**

Diameter of boulder in feet	Approximate number of cartridges, 1 1/4" x 8",— in average hard stone—required for:		
	Mudcapping	Snakeholing	Blockholing
1 1/2	2	1	1/4
2	3	1	1/4
3	4	1 1/2	1/2
4	7	4	3/4
5	12	6	1

Above figures are for du Pont Straight 50% Dynamite, and should be increased somewhat if a slower acting explosive like Red Cross Extra 40% is used.

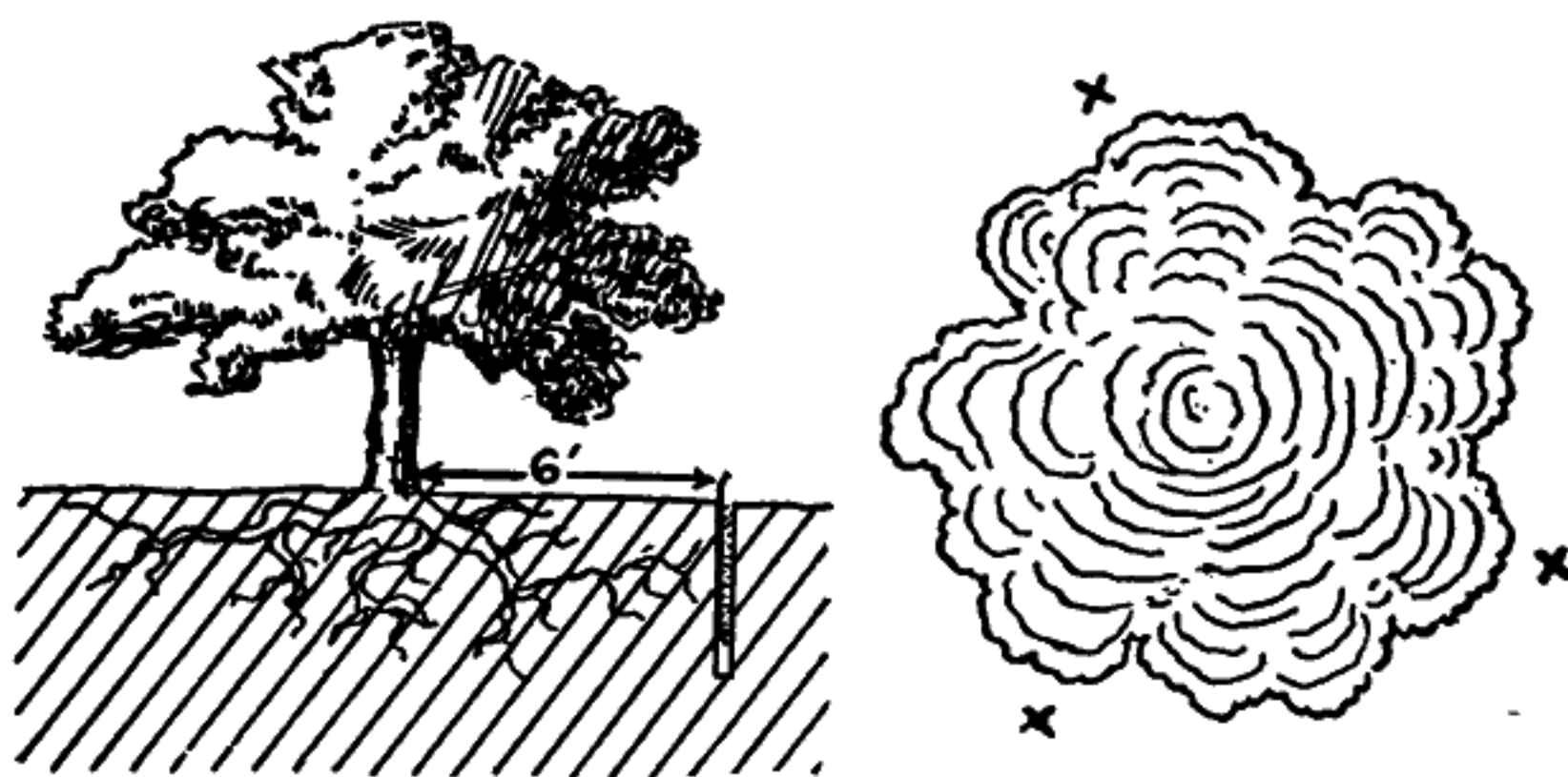
### Tree Rejuvenation and Planting

covering should be as thick as it is convenient to make it, not less than 5 or 6 inches, and free from stones, as the blast will throw them as though they were bullets. Never lay a stone on top of the mud, for the same reason.

The explosives used are Red Cross Extra 40% for easily broken rock and du Pont Straight 50% for hard "nigger-head" boulders.

## TREE REJUVENATION AND PLANTING

By tree rejuvenation is meant blasting around the roots of grown fruit, shade and other trees to invigorate their growth. It proves beneficial especially on tight clay and hardpan soils where the trees are not growing properly.



A—For small tree.

B—For large tree.

Fig. 121.—Location of charges for rejuvenating trees.

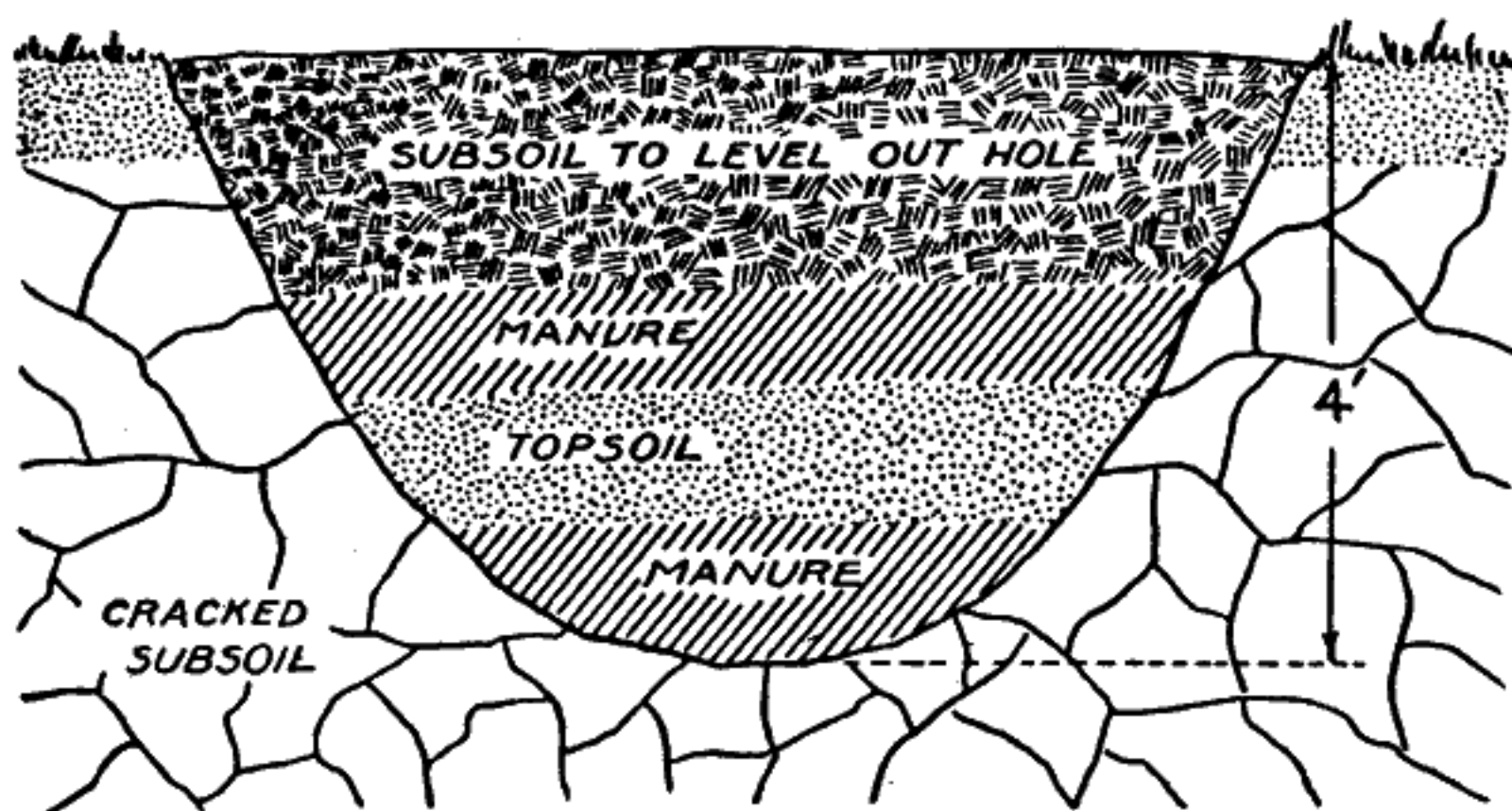


Fig. 122.—On poor soils holes for rejuvenating failing trees should be blasted quite heavily, and the craters filled with layers of manure and soil or with a rich mixture of soil and fertilizers.



## Tree Rejuvenation and Planting

The blasting should be done in exactly the same manner as blasting for subsoiling or tree planting. If the soil is deficient in plant food or organic matter the holes should be loaded quite heavily so that the blast will blow out an open hole which can be filled with layers of soil and manure or with soil mixed with fertilizers. If this is not done the pot hole formed at the base of the blast must be filled up to prevent caving.

For young trees the blasts should be placed not closer than 6 to 8 feet from the trunk of the tree (Fig. 121A); for old trees they should be about under the extreme spread of the branches (Fig. 121B). Such treatment has been known to have a considerable effect in relieving nematoids and similar diseases of the roots.

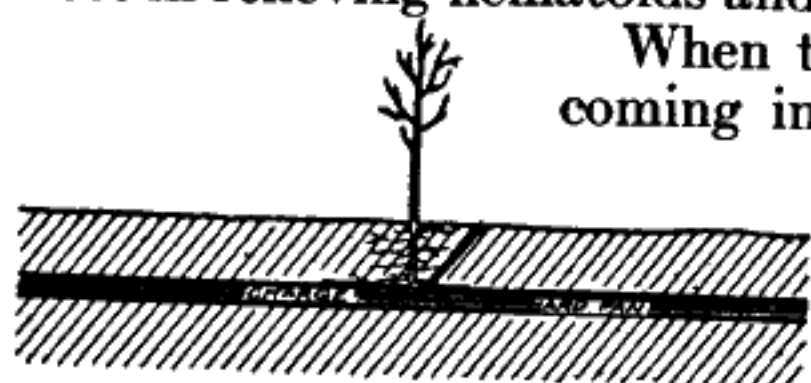


Fig. 123—Correct location for a blast in the hardpan under a tap-rooted tree. The charge must be light.

When trees are stunted by the tap-root coming in contact with hardpan, relief is obtained by shattering the hardpan immediately under the tap-root with a blast placed as shown in Fig. 123. The charge must be very light, usually about one-quarter of a cartridge of Red Cross Extra 20%. A heavy blast would so damage

the roots as to injure the tree. This treatment should be accompanied by blasts placed around and among the lateral roots.

Blasting for planting trees is advised on lighter and more open soils than for ordinary subsoiling. It is not advised on open, well drained sandy and gravel soils. The work is done when the soils, especially clay soils, are dry. When such subsoils are blasted wet, there is trouble from the soil around the blast being compacted. The blasting can be done at planting time, but a better practice is

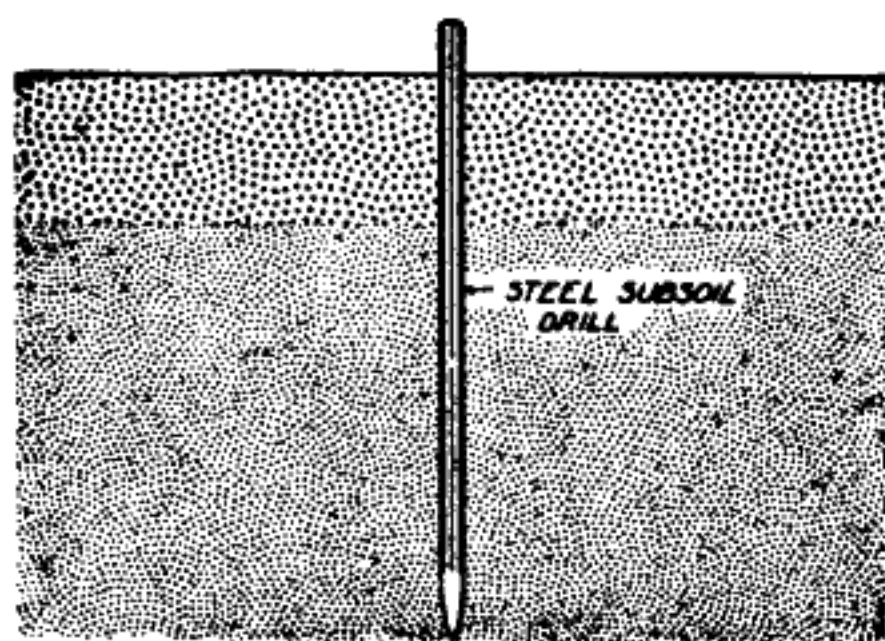


Fig. 124.—Punching the hole. This is usually done with a subsoil punch, Fig. 66.

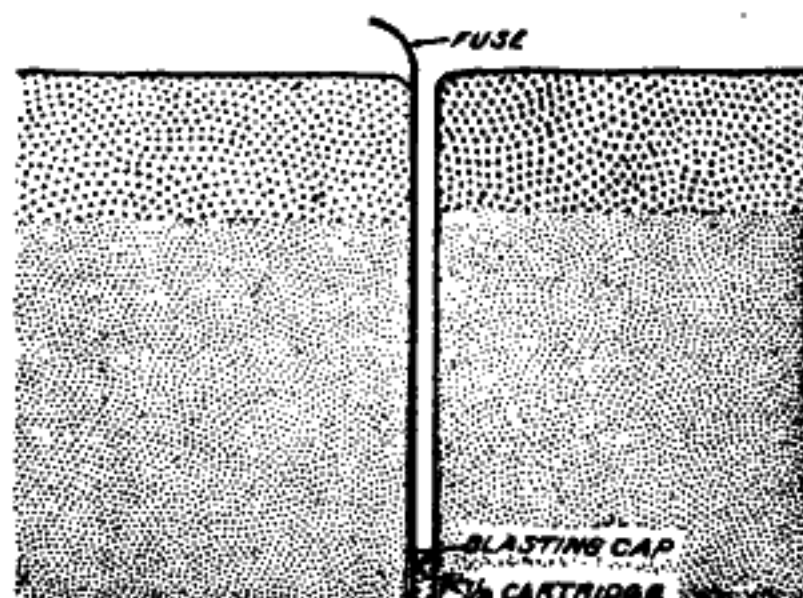


Fig. 125.—The charge in place. A half-cartridge charge of a slow-acting dynamite is usually sufficient.

to blast some time in advance. Manure, commercial fertilizers or ground limestone can be added to the holes if needed.

The work is simple. A borehole is punched into the ground (Fig 124). This is loaded with a half-cartridge charge of Red Cross Extra 20%, or if the soil is hard to break or the holes are deeper

Tree Rejuvenation and Planting. Subsoil Blasting

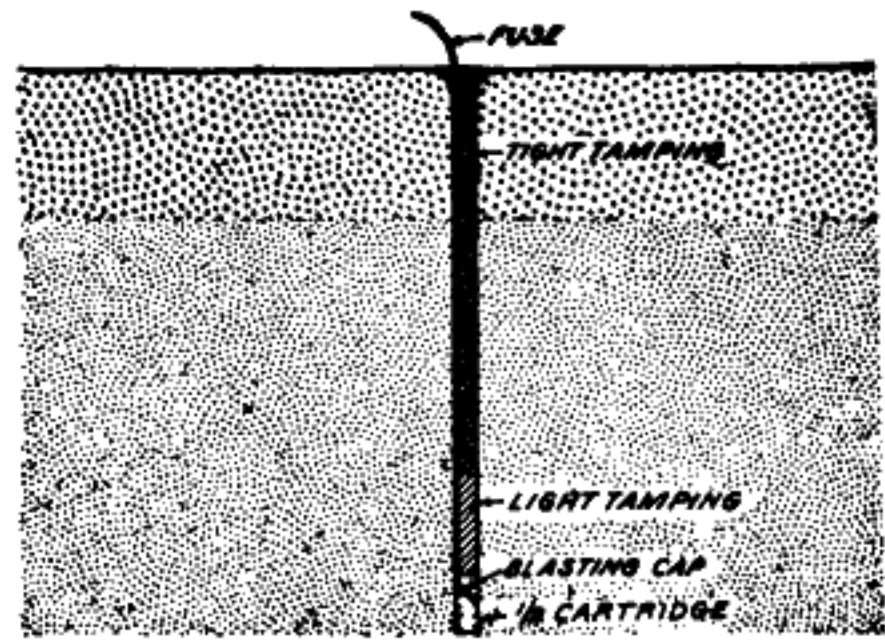
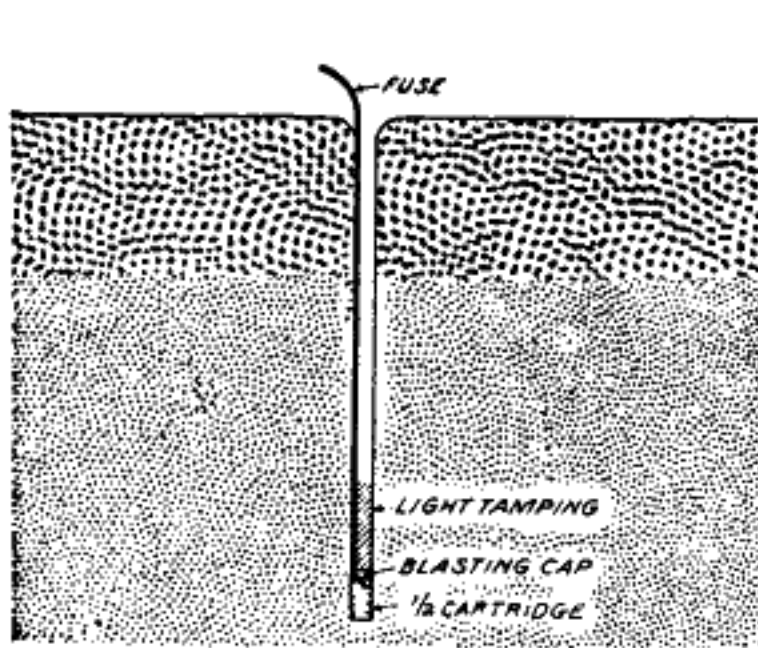


Fig. 126.—Loose tamping over charge. This should be about 3 to 6 inches in depth.

Fig. 127.—Top of hole tamped tight by means of a tamping stick used in one hand.

than 36 inches, with a slightly heavier charge, blasting caps and fuse are used (Fig. 125). The hole is well tamped.

The shot will loosen the soil for a considerable distance and form a pothole or cavity at the base (Fig. 128). The loosened soil is shoveled out to expose the pot hole, which is then filled with top soil up to the level where the tree is to be set (Fig. 129). This filling must be tamped or tramped to prevent any settling after the first heavy rains.



Fig. 128.—The blast thoroughly cracks the soil, but usually leaves a cavity or pothole at the bottom. This must be filled.

The tree is set in a natural position. Both top and roots should be pruned.

This method of planting is advisable for all kinds of fruit, shade, and ornamental trees.

When the subsoil is extremely hard, it should be blasted at frequent intervals between the trees. (See also Tree Rejuvenation on page 97.)

SUBSOIL BLASTING

Subsoil blasting is a new, deep soil treatment intended to loosen hardpan and tight clay subsoils so that a ready movement of the soil water is permitted; so that the roots can grow unhampered; so that the soil can become better aerated or ventilated; and so that the crops can grow better.

This blasting must be done when the subsoil is dry. Holes are punched (Fig. 124) at intervals of about 15 to 18 feet. The

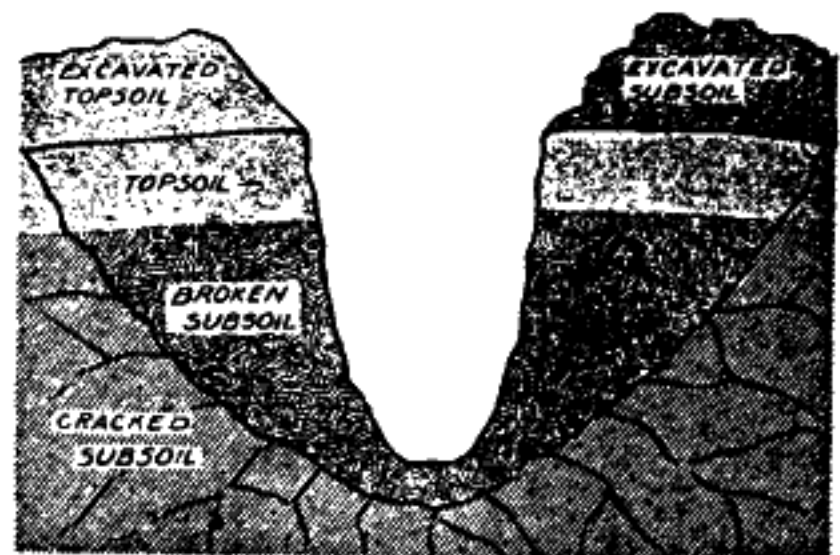


Fig. 129.—The best practice is to shovel out the loose soil and expose the pothole. This is easily done in the freshly blasted holes.



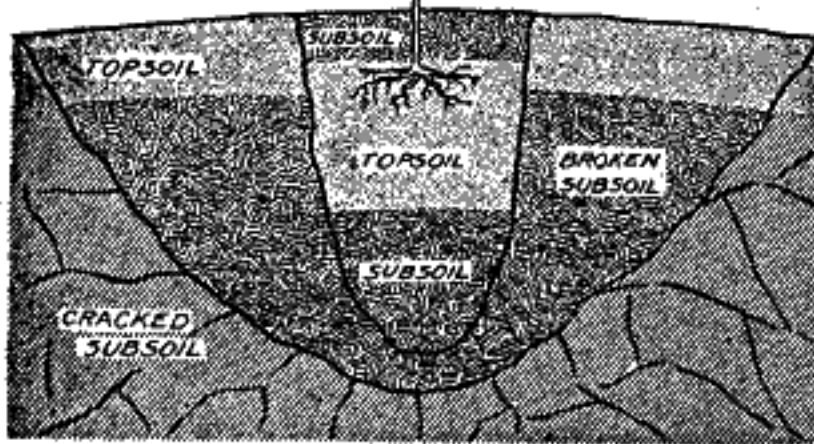
**Subsoil Blasting—Tile Drains. Control of Erosion and Gully Filling**

depths of the holes must be in keeping with the nature of the soil. For clay or hardpan soils that are uniformly hard to considerable depths, the holes are usually from 30 to 36 inches deep. For thin and well-defined layers of hardpan, they should be down to the center of the hardpan. Their depth varies with the depth of the hardpan, ranging from 24 to 40 inches. (Fig. 131.)

Each hole is loaded with a half-cartridge charge of Red Cross

Fig. 130.—  
hole as possi  
filled with rich  
this enough to  
tling and set  
they were in

As much of the  
ble should be  
top soil. Pack  
prevent set-  
the roots as  
the nursery.



Extra 20% unless the loading is very deep or the hardpan hard to shatter, when a slightly heavier charge is used. The hole is well tamped and fired. The surface should show a slight bulging, but no dirt should be thrown into the air. The pot-hole made at the base of the blast must be filled by caving in the top soil.

The blasting is in all respects exactly the same as for tree planting. (Pages 98 and 99.)

### Quantity of Red Cross Extra 20% Required per Acre for Subsoiling or Planting Trees.

Distance Between Trees Square Method	Trees Per Acre	Amount of Dynamite Per Acre Using $\frac{1}{2}$ Cart. Per Tree.	No. 6 Blasting Caps, Per Acre	*Fuse Per Acre, $2\frac{1}{2}$ Ft. Per Tree.
15 ft.	196	49 lbs.	196	490 ft.
20 ft.	110	28 lbs.	110	275 ft.
30 ft.	49	13 lbs.	49	122 ft.
40 ft.	25	7 lbs.	25	63 ft.

\*It is necessary to have as many feet of fuse per hole as the hole is deep.

**Blasting to Increase the Action of Tile Drains.**—To correct the troubles caused by impervious hardpan or subsoil holding subdrainage waters out of tile and other blind drains, subsoil blasts are placed about 8 to 10 feet away from the drains. A better practice is to blast such soils before the tile is laid.

### CONTROL OF EROSION AND GULLY FILLING

The stopping and filling of gullies is becoming more and more a matter of importance as the need for more agricultural land grows. The control should be begun from the very top or up-hill end of



## Control of Erosion and Gully Filling

gullies, for work started farther down the slope cannot be expected to be successful on account of the amount of water that would be brought down from above on the freshly made fill.

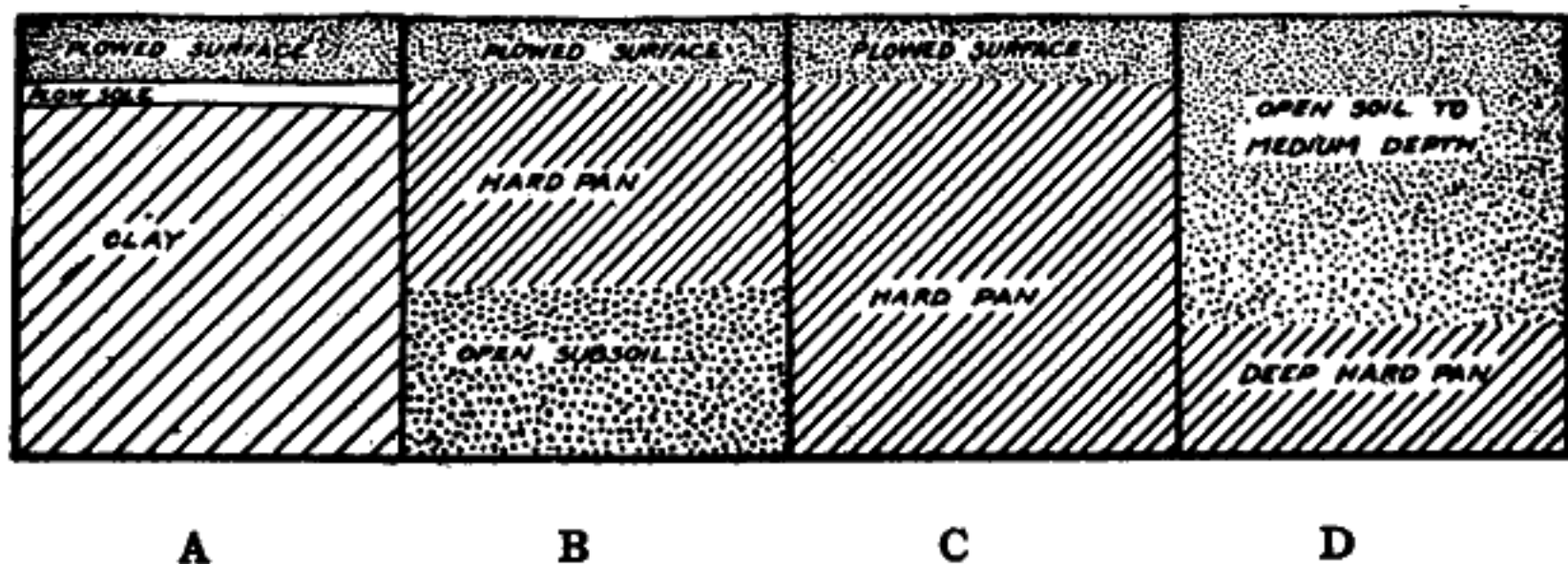


Fig. 131.—Different types of hardpan encountered in the orchard.

If the arrangement of the soil is like that in illustration "A," place the explosive well down into the clay and plow deeper to destroy any shallow plow sole. The best depth for blasting in such soil is usually from thirty to thirty-six inches.

In soils like the one represented in "B," place the charge toward the bottom of the hardpan so that the entire layer may be pulverized, but do not go below the bottom of it, as the force of the blast will tend to raise the hardpan in chunks rather than shatter it. The depth is governed absolutely by the depth of the hardpan.

Illustration "C" shows one of the most common subsoil troubles. This type of hardpan or tight clay is usually too deep to blast through, and relief is obtained by pulverizing several feet of the top, which, if well blasted, will be found to be sufficient to store moisture and furnish room for an ample root development. For such a condition the blast should be made not less than three feet deep.

Occasionally a soil is found like that shown in "D," and will usually be found to require deeper blasting. The explosive should be placed well down in the hardpan—the deeper the better.

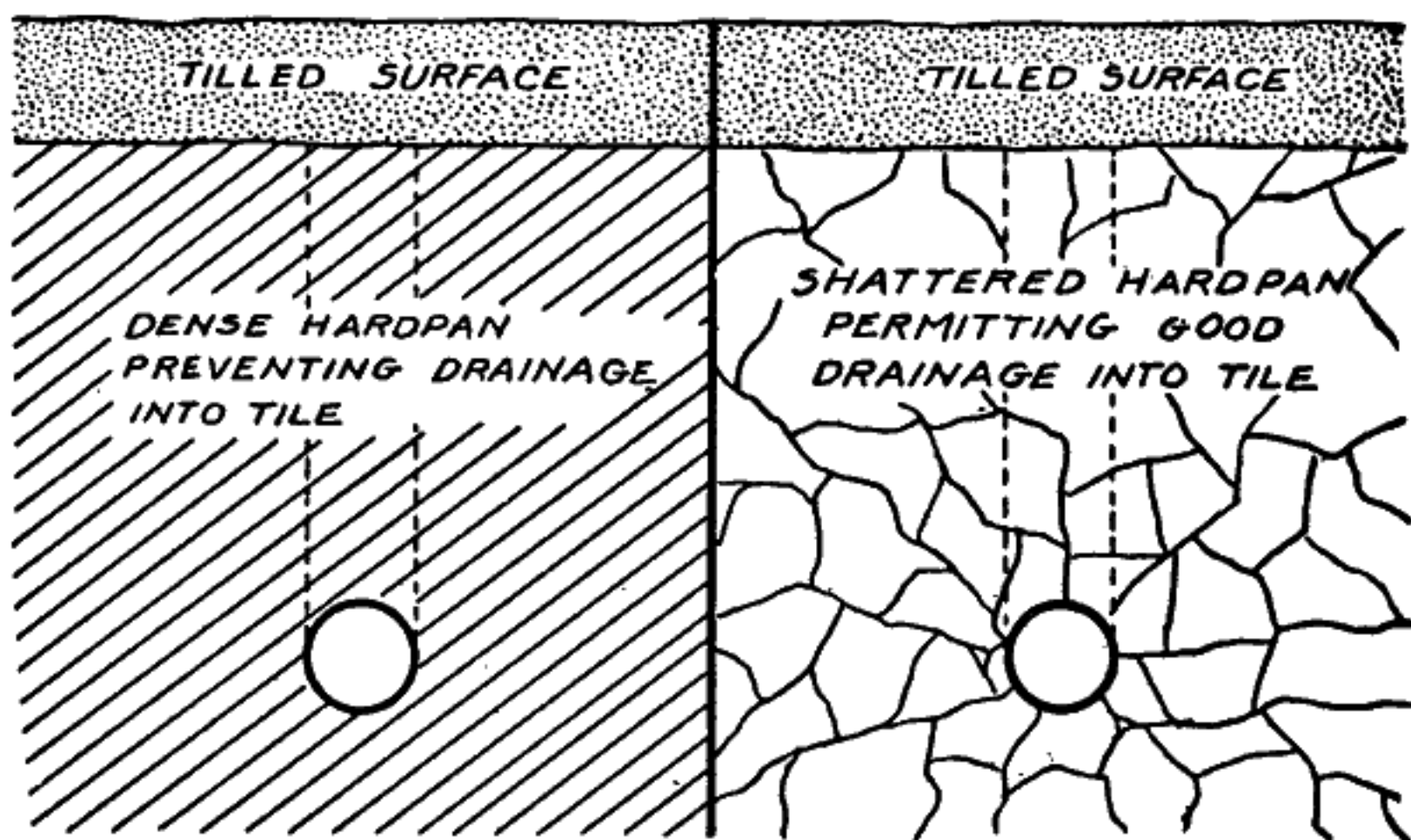


Fig. 132.—Often hardpan prevents the drainage water from passing into tile or open drains. The relief is through blasting, which opens up the needed drainage courses. Such blasts are loaded exactly as for subsoiling, but must be kept well away from the tile.

### Control of Erosion and Gully Filling

The control at the top may be accomplished by better plowing or by subsoil blasting the adjacent land, by terraces, or by diversion ditches.

Before beginning the actual filling of the gully a little attention given to the bottom of it may make it a suitable place for laying a tile drain. Frequently an excellent blind ditch can be made by filling the bottom with brush, logs, or boulder and stump fragments.

An occasional anchor should be formed to hold the new fill in the gully. It may be made by constructing a rough log dam or building a woven wire fence across the bottom. Above this there should be a pile of brush, corn stalks or other rubbish.

To blast down the sides of the banks, bore holes are made from the top as in A, Fig. 135, or from the bottom as in B, Fig. 135. These should be loaded quite heavily to blast the banks down; or bore holes may be loaded lightly and the explosion shakes the bank, which is removed by drag scrapers. A comparatively light blast in combination with the scraper usually gives the best results. Red Cross Extra 20% is recommended for this work.

While good work can be done with single shots using blasting caps and fuse, better results are obtained by firing a series of holes with electric blasting caps.

Where washes are broad and shallow, thorough subsoil blasting is usually sufficient, though it is always necessary to protect the upper end of the wash against danger from flood water.

To facilitate the use of teams on the scrapers a long chain or rope hitch is frequently serviceable. This enables the teams to stay on the firmer and more level bank while the scraper is at work on the rough sides of the blasted gully. The subsoil should be blasted for some distance on both sides to give greater water absorption. This acts as a safeguard against erosion starting again.

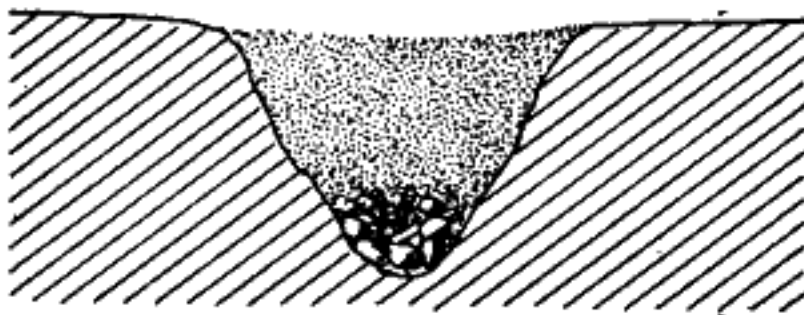


Fig. 133.—Gully after filling, showing the use that can be made of boulder and stump fragments in forming blind drains.

For blasting down or loosening the banks of gullies, either vertical holes, A, or flat (snake) holes may be used. For broad, sloping banks the first method is best, but for steep high banks the last method is preferable. The depth of the holes and the amount of dynamite used must be governed by the amount and depth of dirt to be moved and by the method employed to complete the job.

## EXCAVATING FOR CELLARS, FOUNDATIONS, UNDERGROUND SILOS, WELLS AND SIMILAR PITS IN HARD GROUND

For loosening the ground or stone for most classes of excavations the use of dynamite proves a decided economy, as it does the work



## Excavating for Cellars and Foundations



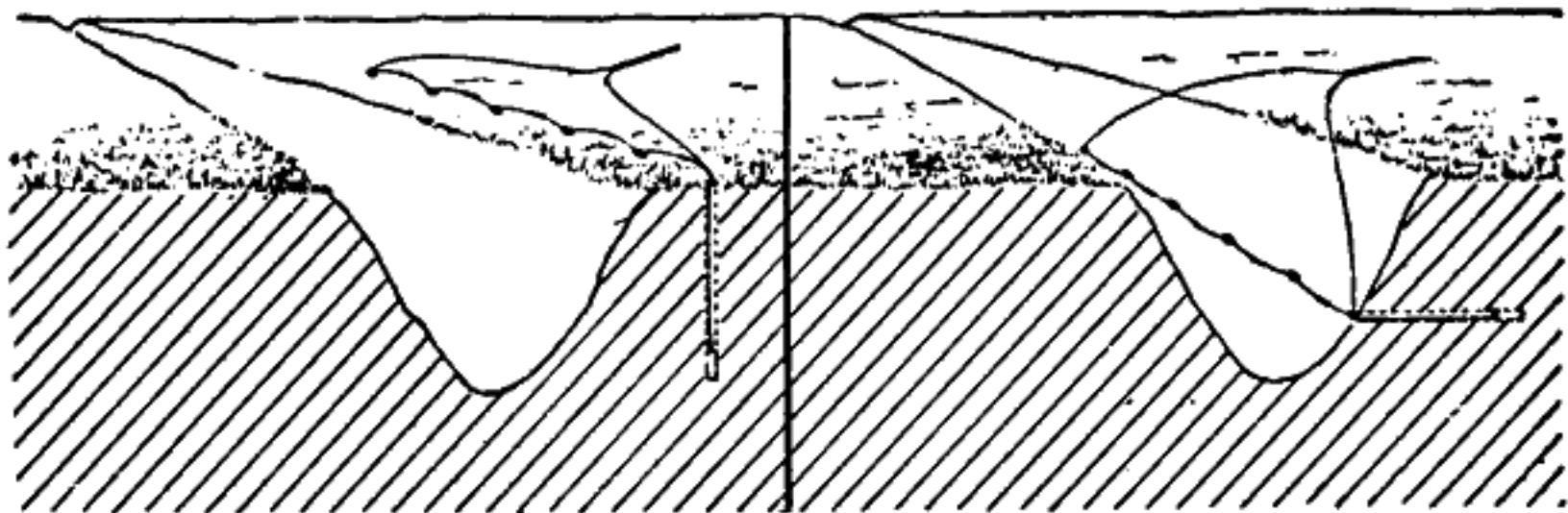
Fig. 134.—Showing a log and brush dam built across a gully to form an anchorage for the moved soil. A woven wire fence with the top set level with the ground is also good.

quickly, easily and more effectively than can be done by means of picks.

When the excavation is on a hill or in a location where the cutting begins at nothing or at a few inches, the blasts are placed and loaded as is advised for road cuts. (See page 81, Fig. 96.)

For starting excavations on level ground or deepening all kinds of excavations, the blasting is done similarly to shaft sinking.

For soft material the "cut" or first shot may be a single hole. Harder rock will require from 2 to 4 cut holes, fired electrically



A

B

Fig. 135.—For blasting down or loosening the banks of gullies, either vertical holes A or flat (snake) holes may be used. For broad, sloping banks the first method is best.



## Excavating for Cellars and Foundations

(Fig. 136). The excavation is enlarged by other holes drilled around the crater opened by the "cut" shot (Fig. 137). For heavy clay, hardpan and shale, Red Cross Extra 20% is recommended. For harder rock the recommendations made for shafts and tunnels are applicable.

When such an excavation is a cellar and the floor is to be the foundation for a building, care should be exercised to avoid shaking the bottom in such a manner as to injure the ground that must support the foundation of any wall or building.

In blasting foundations in rock where it is desirable to excavate to the furthest possible extent but not to crack the rock beyond a certain line, as in cities where an expensive foundation may be injured by careless blasting in the adjoining property, the method used is to drill a number of vertical holes at close distances, four to six inches apart, along the line parallel to the party line and as close as practicable. Blast holes are then drilled two or three feet further from the party line, spaced closer to each other than for open country blasting, and fired with light charges. Usually the break or crack will extend up to the line of empty holes and will follow that, not running into the rock beyond the party line.

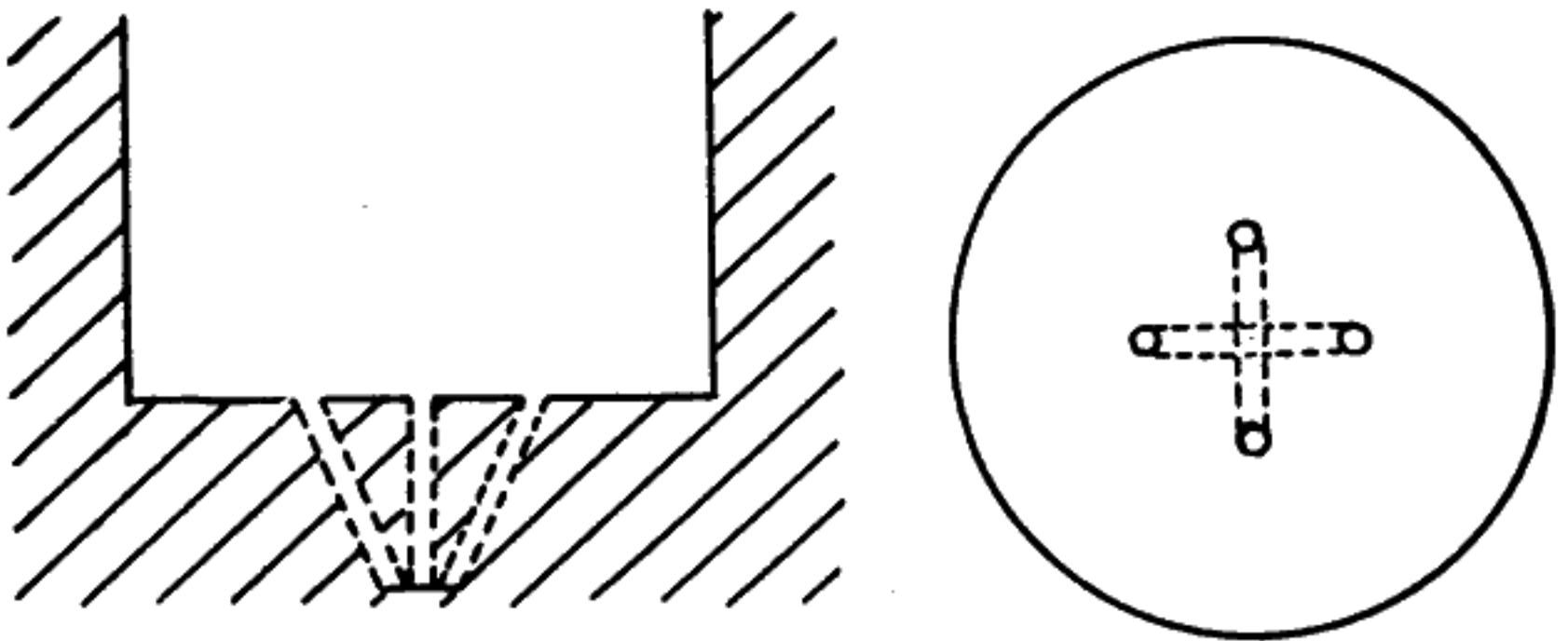


Fig. 136.—Diagram of loading a cut shot in a well.

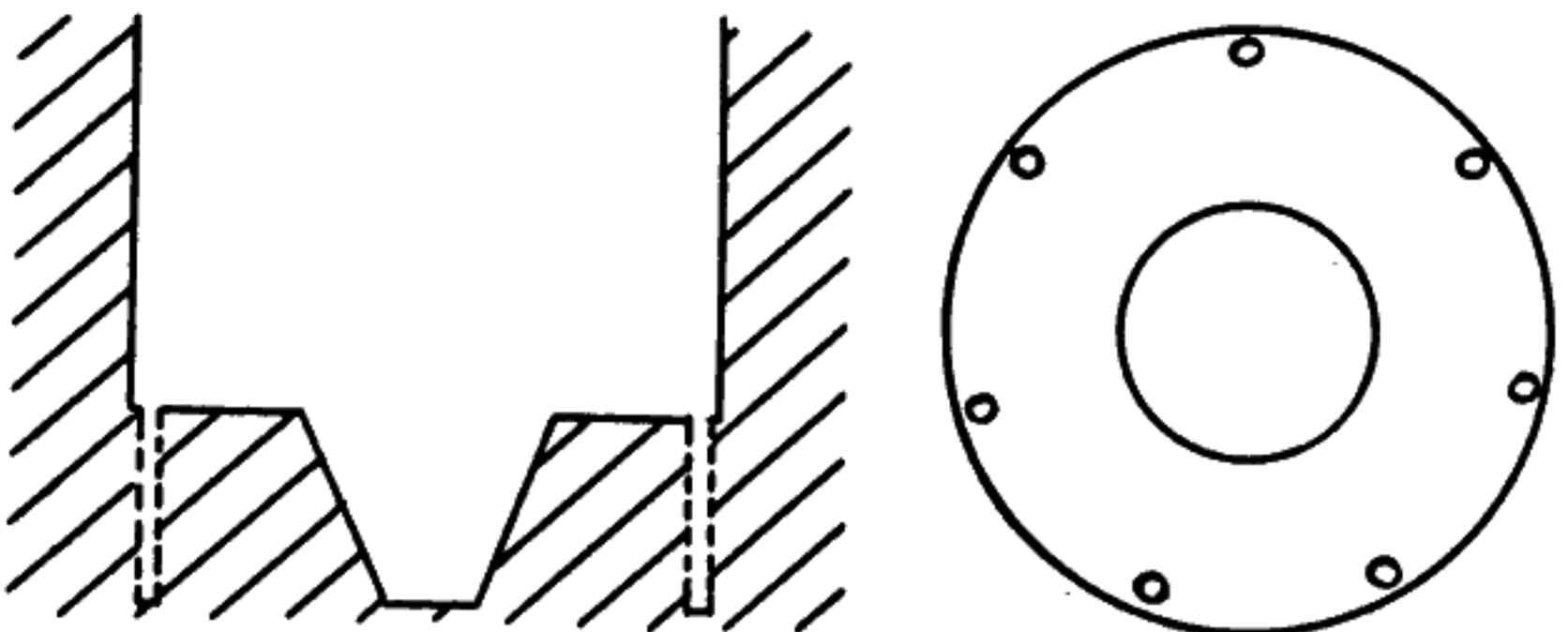


Fig. 137.—The excavation is completed by a circle of holes near the wall.

**Blasting Wells and Silos. Blasting Drilled Wells to Increase Water Supply**

Wells are often sunk through rock or ground which cannot be dug to advantage without the aid of explosives. When rock is reached and the earth above is properly supported, a circle of four or five drill holes should be started about half-way between the center and the sides of the well and pointed at such an angle that they will come closer to each other near the center when they are three or four feet deep. These holes should be loaded about half full of Red Cross Extra Dynamite 40%, with damp clay or sand tamping packed firmly above to the top of the hole and then exploded all together from the surface by electricity. This shot will blow out a funnel-shaped opening in the center, and the well can then be made full size with another circle of holes drilled straight down as close to the sides as possible. If the well is large it may be necessary to drill a circle of holes between the inner and outer circle. The above process should be repeated until the well has passed through the rock or has been sunk to the necessary depth. Do not in any case enter a well until all the fumes of the last blast have come out. If in doubt, lower a lighted candle to the bottom; if it continues to burn clearly and brightly the well may usually be entered safely. Electric blasting caps will give the best results, as they are much safer than blasting caps and fuse and result in better execution by exploding the holes together.

**BLASTING DRILLED WELLS TO INCREASE WATER SUPPLY**

Shooting oil wells, exploding a charge of nitroglycerin in the well to increase the flow of oil, is a common practice throughout the oil fields. Various torpedo companies, as they are called, make a business of sending experienced blasters to the oil operators with the necessary explosives and accessories required. The methods of oil-well shooting are pretty well established.

Within recent years explosives have come into use for increasing the flow of drilled water wells. The methods of blasting drilled water wells are much the same as those employed in the oil fields, but the desirability of blasting such a well should first be determined by careful study of its location, its drilling record, and the water supply it is designed to draw upon. While oil wells are usually located in segregated districts at some distance from a town, the drilled water well may be near a farm-house, in the town itself, or even in the cellar of a metropolitan hotel. Whether it is safe to blast depends largely upon the proximity to buildings and the depth of the well. If the well is in a city close to or within large buildings, it may be dangerous to blast, lest the shattering of the rock underground weaken the foundations of the buildings, or flying fragments of rock do damage above ground. If the well is shallow, any risk there may be of injury to surrounding property is increased. However, wells within a few feet of houses have been blasted without the slightest damage and it is probably safe to say that if the size of the charge is proportioned to the depth of the well and the work is carefully done, blasting can be carried out in most places with little risk.

## Blasting Drilled Wells to Increase Water Supply

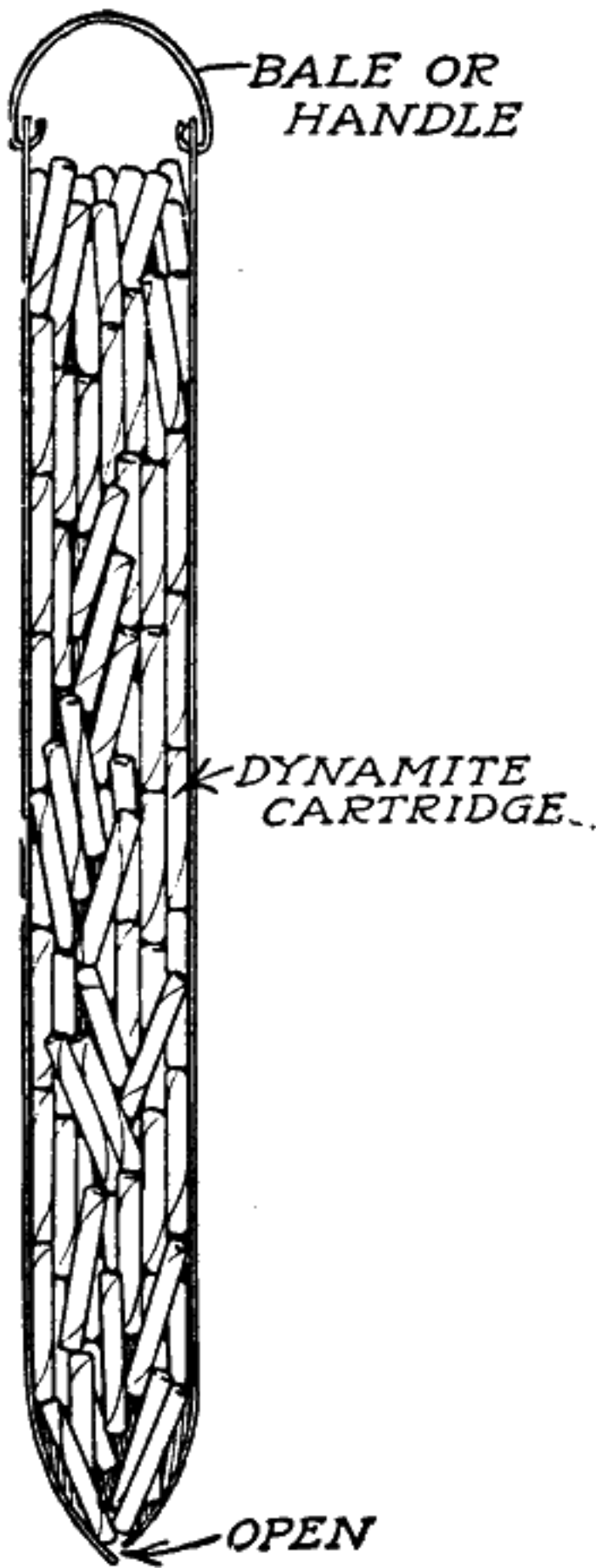


Fig. 138. — Cylindrical shell containing dynamite or nitroglycerin.

Whether it will be profitable to blast a drilled water well depends upon the quantity of water in the earth or rock surrounding the borehole, and the character of the formation. Just as it is a fallacy to suppose that there is plenty of water in the earth at any point if one only goes deep enough, it is unjustifiable to expect that blasting a dry drilled well will always make it yield water. Underground waters exist at varying depths, in varying quantities, and in varying degrees of accessibility determined by the climate of the region, the conformation of the surface, and the structure of the earth's crust. That portion of the rainfall which does not immediately evaporate or run off into surface streams sinks into the ground. A small part of it is retained by capillary attraction in the surface soil to be later returned to the atmosphere through direct evaporation or through plants, but the greater part seeps downward into deeper layers of soil or rock, often completely saturating them. The water in this saturated zone is called the ground water and is the great source of supply for lakes, springs and wells. Like surface water, although much more slowly, it is in constant movement from higher to lower levels, flowing evenly through layers of sand or gravel con-

finned by relatively impervious strata, or in rock strata, trickling through the pores of the rock and along joint cracks, bedding planes, solution channels and other crevices. When the water-bearing strata strike the surface, as often happens along hillsides or in valley bottoms, the water issues as a spring or forms a lake. It is, of course, to this ground water that wells are drilled. The United States Geological Survey has made studies of underground water supply in most sections of the country and can furnish maps and other information concerning the depth, abundance and composition of underground waters and the character of both the water-bearing strata and the strata between them and the surface which will be found of great value alike in selecting the well location and drilling the hole and in blasting to increase the flow of water.



### Blasting Drilled Wells to Increase Water Supply

If a well is sunk into sand or gravel it generally produces water in direct proportion, first, to the quantity carried by the strata, as the water moves freely through all portions of such material, and second, to the angle of the strata, the steeper the dip of the water-bearing strata toward the bottom of the hole, the greater always the pressure and, consequently, the rapidity with which the water will rise in the hole. Firing a blast at the bottom of a well in sand or gravel would have practically no effect on the flow of the well; the sand or gravel would simply settle back after the explosion into its original place in the porous mass.

If sunk into water-bearing rock, however, a well may draw only from the particular pores or crevices which it intersects and their tributary pores and fissures, and thus secure only a relatively small portion of the water carried by the whole stratum at that point. If passages could be opened into the borehole from the whole area of the surrounding rock, the flow of the well would be immediately increased. Here, therefore, is the function of explosives, for a heavy charge fired at the bottom of the well would increase the sectional area of the hole, making a collecting cavity for water, and would open up radiating fissures throughout a considerable area of the enclosing rock.

The methods of blasting drilled water wells are derived directly from oil-well shooting. The explosive is usually placed at the bottom of the hole. If a record of the hole has been kept by the driller, as should always be done, showing the kinds of material encountered in drilling, the depth and thickness of each successive layer and the point or points at which a water-bearing stratum was struck, this should be consulted by the blaster before deciding the location of the charge. It sometimes happens that a hole is drilled through a water-bearing area into a lower dry area and in such a case the shot should be fired, not at the bottom of the well, but at the level of the water-bearing rock.

Inasmuch as the greatest possible fracturing of the rock is desired, it is advisable to use a quick, powerful explosive and a heavy charge. The best explosive for the purpose is probably du Pont Solidified Nitroglycerin, but, if this is not obtainable locally, du Pont 60% Straight Dynamite will also do satisfactory work, provided the column of water which may be standing in the well is not over 200 feet high. The exact size of the charge is governed by the depth of the well, the nature of the rock to be blasted, and the proximity to buildings. For a well 100 feet deep an efficient and safe charge would be from 100 to 200 pounds of Solidified Nitroglycerin or from 150 to 300 pounds of 60% Straight



Fig. 139.—Special hook for bail of nitroglycerin container.

### Blasting Drilled Wells to Increase Water Supply

Dynamite. For every additional 100 feet this loading could be increased by about 100 pounds.

The cartridges are carefully packed in a cylindrical shell (Fig. 138), ranging usually from 3 to 5 feet in length, made of tin or galvanized iron drawn out to a point at the lower end to prevent it from catching in its descent down the hole, open at the upper end and provided with a wire handle or bail. Such a container can be easily made from an ordinary stovepipe. It should always be at least an inch smaller in diameter than the borehole. If there is standing water in the hole, as is usually the case, and the hole is of considerable depth, there should be an opening in the lower end of the shell, as shown in the illustration, so that the water may pass through the shell and equalize the pressure on the explosive.

When the shell is loaded, the bail is placed over a special hook (Fig. 139) on the end of a stout line and the shell is slowly lowered down the hole. By a few motions of the line the hook can then be freed and drawn up. In shooting a very deep well, several shells may be necessary to hold the required charge.

If so, they can be lowered successively and one allowed to rest on another. In case a charge is to be located at some distance up the hole instead of at the bottom, a shell provided with an anchor tip is used, that is, a tube about  $1\frac{1}{4}$  inches in diameter projecting a few inches from the lower end. A tin pipe long enough to reach to the bottom of the well is securely fitted over this tip and lowered into the hole ahead of the shell to serve as an anchor for it.

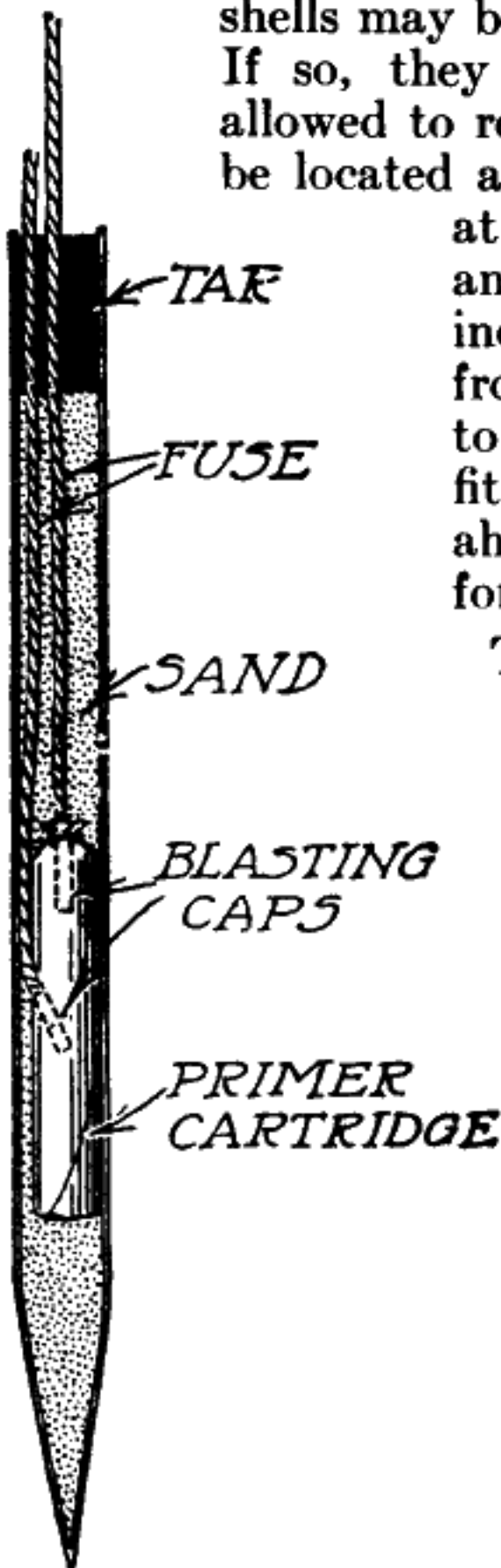


Fig. 140.—“Jack Squib” for exploding nitroglycerin container.

The charge being seated, the next step is to explode it. This can be done by either the jack-squib (Fig. 140) or the electric squib (Fig. 141), both devised originally for oil-well shooting.

The jack-squib consists of galvanized pipe about 2 inches in diameter and 36 inches in length, pointed at the lower end, which is filled as follows: Sand is poured into the pipe to a depth of about 6 inches; a cartridge of 60% Straight Dynamite, primed with two No. 8 blasting caps and two fuses, is seated on the sand, and more sand is poured in until it fills the space around the cartridge and covers it to within four inches of the top of the pipe. This remaining space is then filled with thick tar. As soon as the squib is prepared, both fuses are lighted, two being used

**Blasting Drilled Wells to Increase Water Supply**

in case one should fail, and the squib is dropped into the hole, point down. The length of the fuse should be so calculated that the squib will explode about the time it strikes the charge and thus detonate it.

The electric squib of the oil-well shooter, which should not be confused with the du Pont Electric Squib, is similar in construction to the jack-squib, but shorter and larger in diameter with a less sharply pointed end. It is usually about 5 inches in diameter and 20 inches long. It is filled to a depth of about 6 inches with sand and then a primer charge consisting of from one to three cartridges of 60% Straight Dynamite is placed in the sand, one of the cartridges having been previously primed with a No. 8 Submarine Electric Blasting Cap. To the wires of this cap, at a point that will come well within the squib shell, are spliced No. 14-gauge copper wires long enough to reach to the bottom of the hole, and the splices are well taped. The remaining space is filled with sand topped with a layer of tar. This squib is carefully lowered by the wires until it rests upon the charge and is then fired by means of an electric blasting machine.

If the well has struck water there will probably be some standing water in the hole. Every foot of water in the hole exerts a pressure of .434 pounds per square inch. Consequently a column of water 100 feet high over a charge of explosives exerts a pressure of .434 pounds on every square inch of the area of the charge. It is this pressure which makes it necessary to protect the detonator from moisture by placing it in a sand-filled and tar-sealed metal shell. As the pressure may tend to force out the nitroglycerin from the cartridges, it is important to fire the shot as quickly as possible after loading. All preliminary preparations such as removing objects within danger and notifying people should be completed before the explosive is lowered into the hole so that no time need be lost thereafter.

Most drilled wells contain a casing throughout a part or the whole of their depth; that is, a closely fitting iron pipe which has been inserted either to prevent sand, gravel or shale walls of the bore hole from caving or to shut off from the well, seepage from water-bearing strata nearer

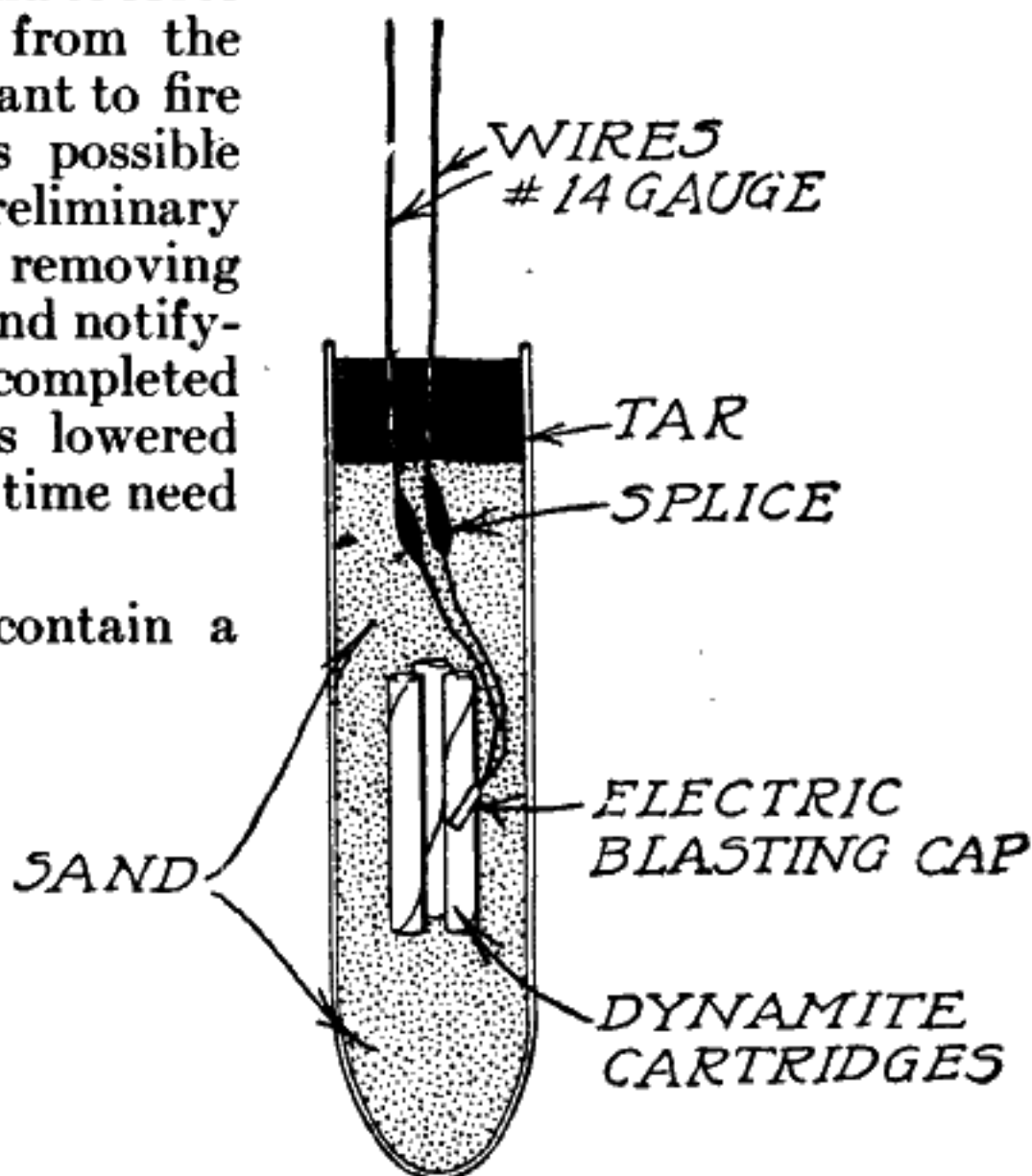


Fig. 141.—Showing method of preparing nitroglycerin charge for exploding by means of an electric blasting cap.



**Blasting Drilled Wells to Increase Water Supply. Ditching and Drainage**

the surface than the strata being drawn upon, which is apt to be polluted with organic matter. Exploding a heavy charge at the bottom of the well is likely to damage this casing, either blowing it out in fragments, which may do harm if allowed to fly into the air, or causing it to collapse within the borehole, or splitting it longitudinally along the seam.

To prevent the casing from flying into the air it is well to build a heavy grill work over the mouth of the hole. This should be securely anchored to the ground. It is hardly possible to prevent splitting the casing, but this is not necessarily a serious result, for a casing that is merely split can easily be pulled out and replaced.

If the casing collapses, however, it is more difficult to remove. In a well 300 or 400 feet deep there is less likelihood that the casing will be blown out or split than in a shallower well, but there is danger of collapse whatever the depth of the well. To prevent the casing from collapsing, the hole should be either full of water to the top or empty of water for fifty feet below the bottom of the casing. This last would mean that the hole was cased through only a part of its length and that the explosive charge was seated at least fifty feet below the casing. Suppose, for example, a well 100 feet deep containing 50 feet of casing from the surface down and 75 feet of water. The explosion of the charge would probably cause the casing to collapse at the surface of the water. If the top of the water column was a few inches or a few feet below the casing, the collapse would probably occur at the bottom of the casing. If, however, the water was 50 feet below it, there would probably be no collapse at all. So it is advisable before firing either to fill the hole full of water or to bale it out to a point 50 feet below the bottom of the casing.

Well blasting is neither difficult nor dangerous, and it has been found very successful in numerous instances in increasing the flow of water. Under ordinary conditions careful following of the methods described should produce satisfactory results. If peculiar conditions exist, it is well to secure advice from an experienced blaster or an explosives manufacturer.

**DITCHING AND DRAINAGE**

Ditch blasting is effective for digging open ditches in all classes of ground from solid rock to loam; it is not effective in loose sand or gravel.

In size, blasted ditches vary from about 2 to 6 feet in depth and from 4 to 16 feet in width, depending on the method of loading and the amount of explosive used.

There are two distinct methods of blasting ditches; the propagation method and the electric method. The propagation method can be used only in wet soils, while the electric method can be used in either wet or dry soils. The explosives and blasting supplies needed and the methods of loading vary considerably in the two methods.

## Ditching—Propagation method

Among the most striking advantages of ditching with dynamite, as compared to other methods, is the reduction in cost, the absence of a large soil pile along the ditch, the little time required, the absence of overhead expenses for equipment, the ability to dig

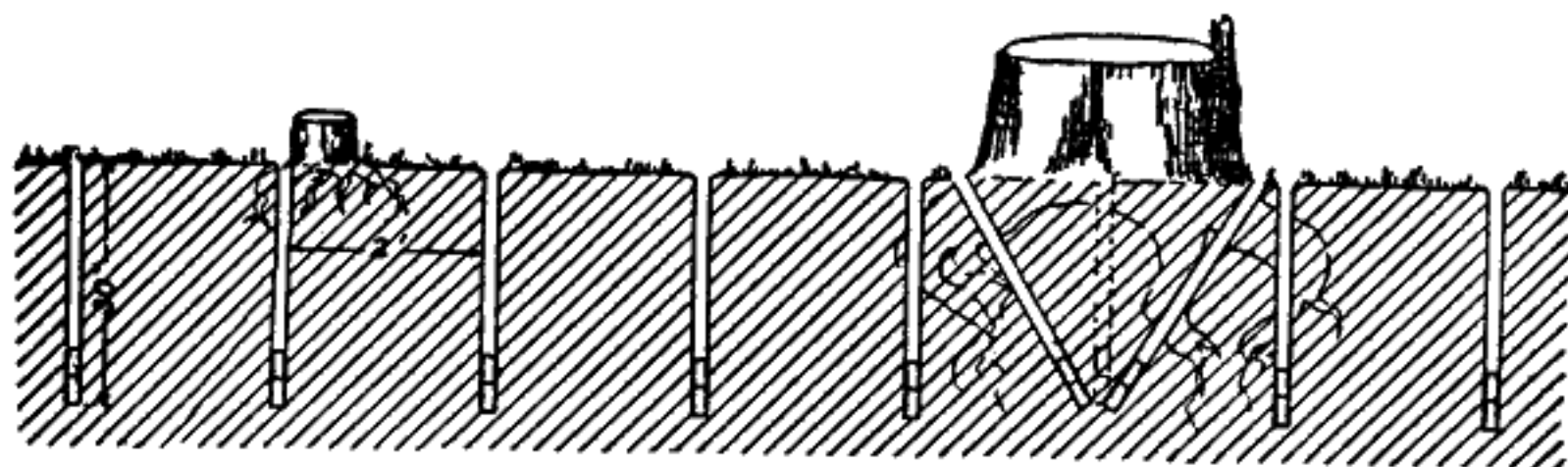


Fig. 142.—Line of holes loaded for a propagated ditch blast in wet soil. The holes are spaced 18 to 24 inches apart, loaded with Straight 50% Dynamite, and the entire blast fired by a single cap. Increased charges are used under large stumps and boulders.

successfully where the conditions are too difficult for other methods, the adaptability to dig both large and small ditches, and the simplicity of the methods. These are discussed in full in the **FARMERS' HANDBOOK OF EXPLOSIVES**.

#### Ditching in Saturated Soils without a Blasting Machine.

—In wet soils, where holes two feet deep will stand half full of

water, the quickest and generally the most economical method of ditching is the propagation method with 50% Straight Dynamite. Only a straight dynamite can be used for this method of loading, as other grades are too insensitive to be detonated by the shock from a single primer in a central hole. This method can be practiced in the roughest of swamps, even where the surface is covered with the heaviest of swamp stumps and several inches of water.

The simplicity of the propagation method and the excellent results obtained must be seen to be fully realized.

The course of the ditch having been decided on



Fig. 143.—A short test shot for ditch blasting. Note how the excavated ground is lifted and scattered.

**Ditching—Test shots; amount of charge; putting down the holes**

by a survey or close study of the slope, as indicated by the surface drainage and the trees having been chopped from the right of way, the work may be begun.

**Test Shots.**—The first thing to do is to make a few trial shots to ascertain the best depth and spacing for the holes. For ditches up to 3 to 3½ feet deep the depth of bore holes will usually be about 24 to 30 inches, and the spacing between the holes from 18 to 24 inches, although it may be necessary to increase the depth and decrease the spacing in some cases. It is well to begin the test with holes two feet deep and 18 inches apart. Keep these in line and load about 10 of them with one cartridge each. If a little water covers the cartridges in the holes no further tamping will be needed. If not, tamp well with earth. One hole is charged with an extra primer cartridge, and it is also well to put one additional in each hole adjoining the primer.

This loading should lift the soil at least two hundred feet into the air, scatter it over the adjoining area for a distance of 150 feet and leave a good, clean ditch. If it does not, try a different loading. It may be necessary to make the holes deeper in some soils and not so deep in others. Usually in swamp soils the ditch made is a foot or two feet deeper than the charge, but sometimes it is necessary to load to the full depth.

If the test shot makes too large a ditch, the spacing can be increased a little, but should seldom be greater than 24 inches, and then only in warm soil. For very small ditches less than a full cartridge of explosive may be used in each hole.

**Amount of Charge and Size of Ditch.**—Small ditches (for instance, about two feet deep and three feet wide) in such soils, when there is little trouble from roots, can be dug with half cartridge charges, but when using such small loads the spacing between holes can seldom be over 18 or 20 inches.

Larger ditches can be dug by using two or more cartridges in each hole, and a second, or even a third, line of holes may be put down about four to five feet from the original line and loaded in the same way. When two or three lines of holes are used it will be necessary to use one electric cap in each line, or to put in one or two extra charges between the rows to insure the simultaneous detonation of all the charges.

**Putting Down the Holes.**—Ordinarily in swamp soils the bore holes can be put down with little effort. If the soil is at all

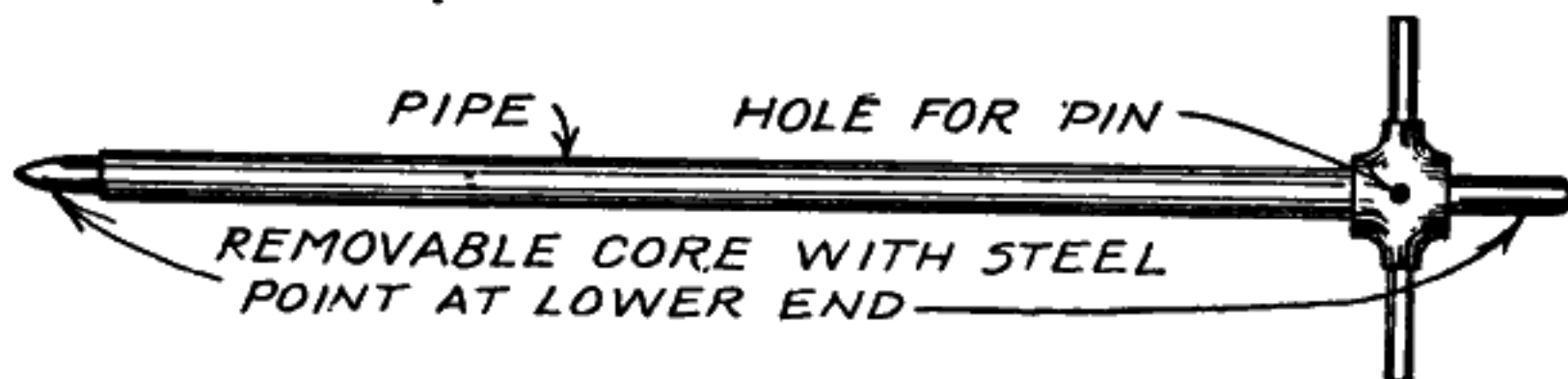


Fig. 144.—Punch for loading holes in muck or quicksand. After the hole is punched, the pin is removed and the core pulled out. The dynamite cartridges are then pushed down inside the pipe and held in the bottom of the hole with a long tamping stick, while the pipe is being pulled up.



**Ditching—With a blasting machine; selection of explosives**

hard, or has a heavy crust, the fastest tool is a good sharp crowbar or punch (Fig. 68), but if soft and mucky, a heavy tamping stick will suffice. The holes should not be left open, but should be loaded at once, as they will cave in or be filled with floating slime.

**Ditching with a Blasting Machine.**—While it is possible to blast ditches by the propagation method, that is, without a blasting machine, only in wet soils, the electric method can be employed in any class of material, dry sand excepted, and low strengths of low-freezing Red Cross can be substituted for the more sensitive straight dynamite.

The layout of the ditch is exactly the same as for the other method, but as an electric cap is used in each hole it is possible to space them farther apart in the row. The normal distances are from 24 to 32 inches for small ditches, and up to 48 and 52 inches for large ditches.

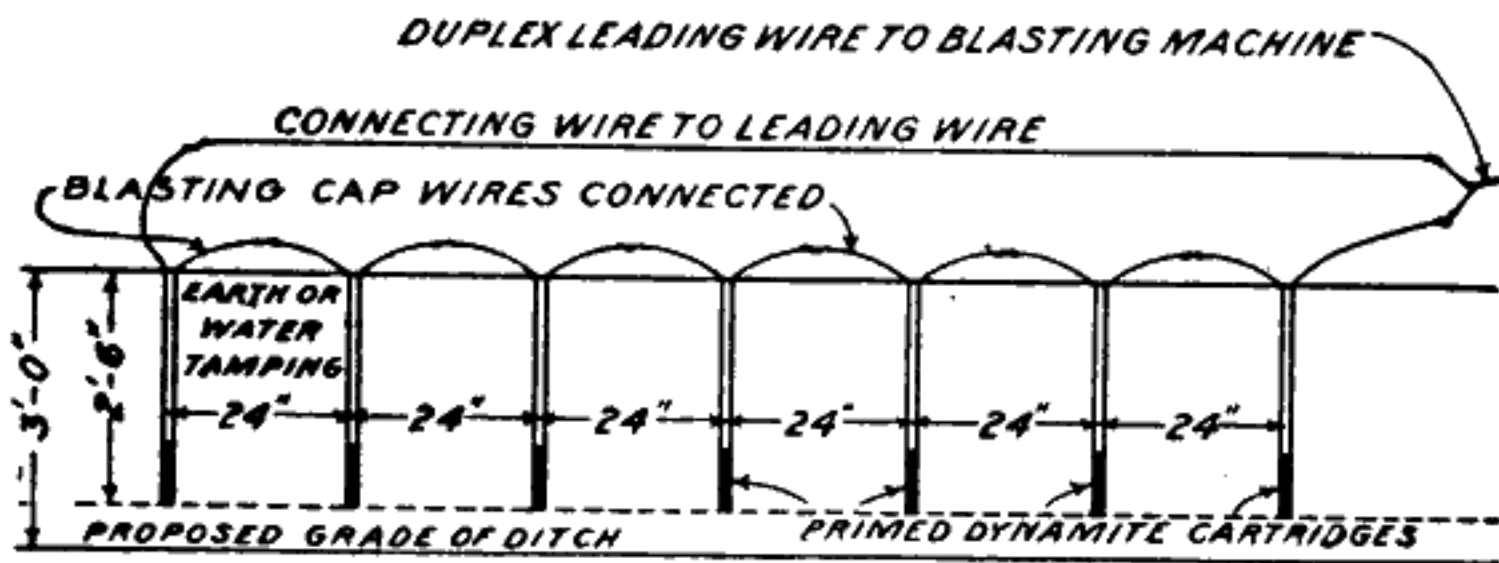


Fig. 145.—Section of loading for an electrically fired ditch blast. The depth and spacing of the holes are determined by test shots.

**Different Explosives for Different Classes of Ditching.**—The explosive selected for electric ditch blasting will depend upon soil and size of ditch. In a medium loam, where only a small ditch (for instance, two feet deep and three feet wide) is desired, the selection may be Red Cross Extra Dynamite 20, 30 or 40%. Where the material is somewhat sandy Red Cross or du Pont Gelatin 40% will give best results. It is practically impossible to blast ditches in dry sand.

For larger ditches, or where there is much trouble with stumps and roots, a stronger explosive will give more economical excavation, and Red Cross Extra 40% or Red Cross Gelatin 40% should be selected. Where the work is very wet, and the charges must be left in the water for a long time, the Gelatin should be selected, as it is more water-resisting than the Extra.

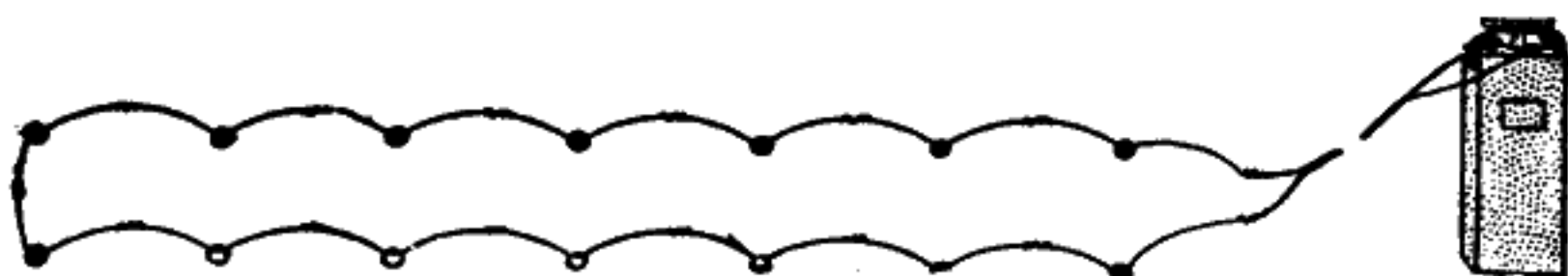


Fig. 146.—Plan of loading for an electrically fired ditch blast using two lines of holes.

**Ditching—Methods of loading.**

**Methods of Loading.**—After three or four trial shots similar to those described for wet ditching have established the proper depth and spacing of the holes, and the amount of dynamite per hole, the blaster is ready to begin actual operations. The holes may be put down with a subsoil punch, crowbar, soil auger or any other tool suitable for the particular class of soil.

Unless water covers all charges they should be thoroughly tamped. It is best to punch only enough holes for one blast, load them and fire, before putting down more, as they are likely to be filled up or covered with trash thrown up by the blast.

When only one cartridge is used in a hole it must contain the electric blasting cap, and should be pressed well down to the bottom of the hole and tamped so that there is no air space left to reduce the effect of the blast. When several cartridges are used in each hole, the primer should be on top, with the cap pointing downward.

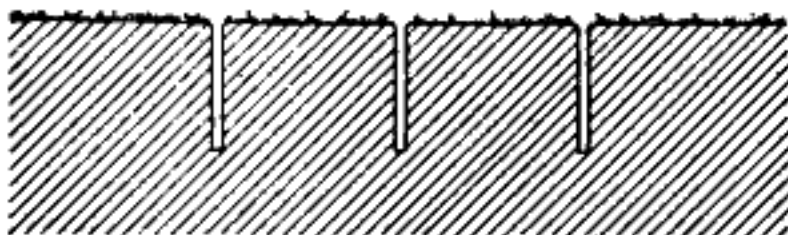
As the work progresses the soil should be carefully watched, and any needed variation made in the loading so that it may always conform to the material to be lifted.

**Blasting Large Ditches with a Blasting Machine.**—When larger ditches are desired the loading may be in deeper holes, using more or a higher strength of explosive; or two or more parallel lines of holes may be employed, especially where wide but shallow ditches are needed. Where very deep ditches are needed, blast a wide, shallow ditch with two or three parallel rows of holes, Fig. 148 A, and then load one or two rows in the bottom of the shallow ditch, Fig. 148 B, thus blasting another ditch in the bottom

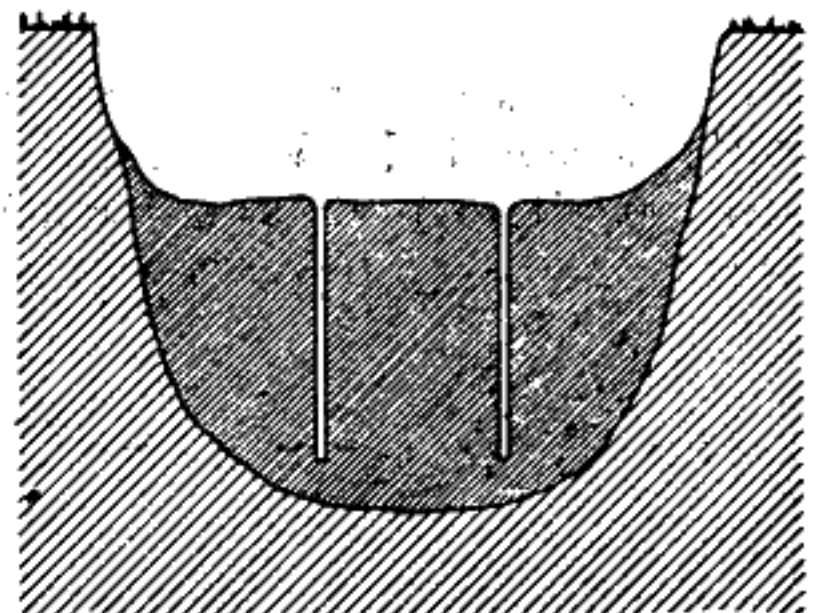


Fig. 147.—Plan of loading for a large electrically fired ditch blast using three lines of holes.

Fig. 148.—Detail of blasting a deep ditch with two shots. For large, deep ditches shallow loading as shown in "A" is used to dig a wide, shallow ditch. In the bottom of this another set of holes is loaded as in "B."



A



B

**Ditching—Table of charges**

of the first one. This latter method has been very efficient in opening large ditches eight or nine feet deep through heavy bottom lands for the correction of stream channels.

When stumps or boulders are encountered heavier loading is needed. This should be in keeping with recommendations made elsewhere in the book.

**Table of Charges of 50% Straight Dynamite for Blasting Ditches by the Propagation Method**

Top Width of Ditch	Approximate Number of Cartridges Per Hole Required for Various Depths				Number of Parallel Rows Required	Distance Between Rows in Inches
	2½ to 3 ft.	4 ft.	5 ft.	6 ft.		
6	1	2	..	..	1	..
8	1	2	3	..	1 or 2	30
10	1	2	3	5	2	36
12	1	2	3	5	2	42
14	1	2	3	5	2	48
16	1	2	3	5	3	36
18	1	2	3	5	3	42

The charges above are approximate for holes spaced 24 inches part—the exact spacing to be determined always by three or four test shots.

**Table of Charges for Electric Ditch Blasting.**

Approximate Top Width of Ditch in Feet	Approximate Number of Cartridges Required for Various Depths			Number of Rows of Holes Required	Distance Between Rows in Inches
	2½ to 3 ft.	4 ft.	5 to 6 ft.		
3	1	..	..	1	..
6	2	4	..	1	..
8	2	4	6	1 or 2	20
10	2	4	6	2	28
12	2	4	6	2	36
14	2	4	6	2	42
16	2	4	6	3	42

**Required Length of No. 6 du Pont Electric Blasting Caps**

4 ft.	6 ft.	6 to 8 ft.
-------	-------	------------



## Quantity of Dynamite Required for a Given Length of Ditch

Spacing	10 Rods			Quarter Mile			Half Mile		
	Number of Holes	Dynamite Required Using Charges Per Hole of		Number of Holes	Dynamite Required Using Charges Per Hole of		Number of Holes	Dynamite Required Using Charges Per Hole of	
		Half Cartridge	Whole Cartridge		Half Cartridge	Whole Cartridge		Half Cartridge	Whole Cartridge
18 inches	110	28 lbs.	55 lbs.	880	220 lbs.	440 lbs.	1760	440 lbs.	880 lbs.
20 "	99	25 "	49 "	792	198 "	396 "	1584	396 "	792 "
24 "	83	21 "	41 "	664	166 "	332 "	1328	332 "	664 "
26 "	76	19 "	38 "	608	152 "	304 "	1216	304 "	608 "
28 "	71	18 "	36 "	566	142 "	284 "	1132	283 "	566 "

1 rod = 16½ feet.

10 rods = 165 feet or 55 yards.

Quarter mile = 1320 feet or 440 yards or 80 rods.

Half mile = 2640 feet or 880 yards or 160 rods.

If longer ditches or larger charges are required, multiply the above figures by two, three or four, according to the number of rows, distance or charges required.

NOTE.—In case of doubt as to proper distance between holes or rows, or depth and strength of charges, try several 10-hole test blasts, with different charges at different distances and depths.

## Ditching and Drainage—Stream correction

**Stream Correction.**—Each spring the big freshets in creeks and rivers are the cause of much property loss. Bottom lands are either washed away or covered with a layer of sand that is too thick to plow under, and the fertility of the soil is greatly reduced.

Permanent control of streams subject to overflow is expensive if all of the material for the new channel is excavated. Equally good results may be obtained with much less expense by undertaking the work in a slower but more systematic way, which will permit the stream to do most of the actual digging itself.

A great part of the trouble from streams is caused by sunken logs and brush, sand bars, overhanging stumps and trees, boulders and rock outcrops, and sharp bends in the channel. These troubles may be overcome quickly and at reasonable cost by the use of dynamite. Shoot out the rafts and logs, and blast a sufficient channel through the confining rock. A well-placed blast will cause the over-hanging stumps to vacate immediately.

The cutting off of sharp turns in the channel will take a little more time and should be well done in the beginning. Locate the line of the new cut-off and blast a ditch that will at all times carry a part of the flow. When this is done and the rafts and logs are out of the way above and below, all there is left to do is to wait for the heavy rains to flood the stream. The increased rate of flow will cause the water to cut and wear away the bottom of the channel as well as the sides. From time to time, it will be best to go over the stream and make sure that no new obstruction is being formed.

Small blasted ditches have been scoured out by the current until they are now carrying the entire flow of large streams. With a little help now and then any stream with a fair fall can be made to do wonders in making for itself a permanent and suitable course.

These methods are applicable to drainage ditches for the reclamation of farm lands, to road and railroad building for outfall and side ditches and to sanitary work for drainage for the control of mosquitoes. The material excavated from the ditch is scattered for considerable distances to each side.

Small boat canals are blasted in exactly the same way as ditches.

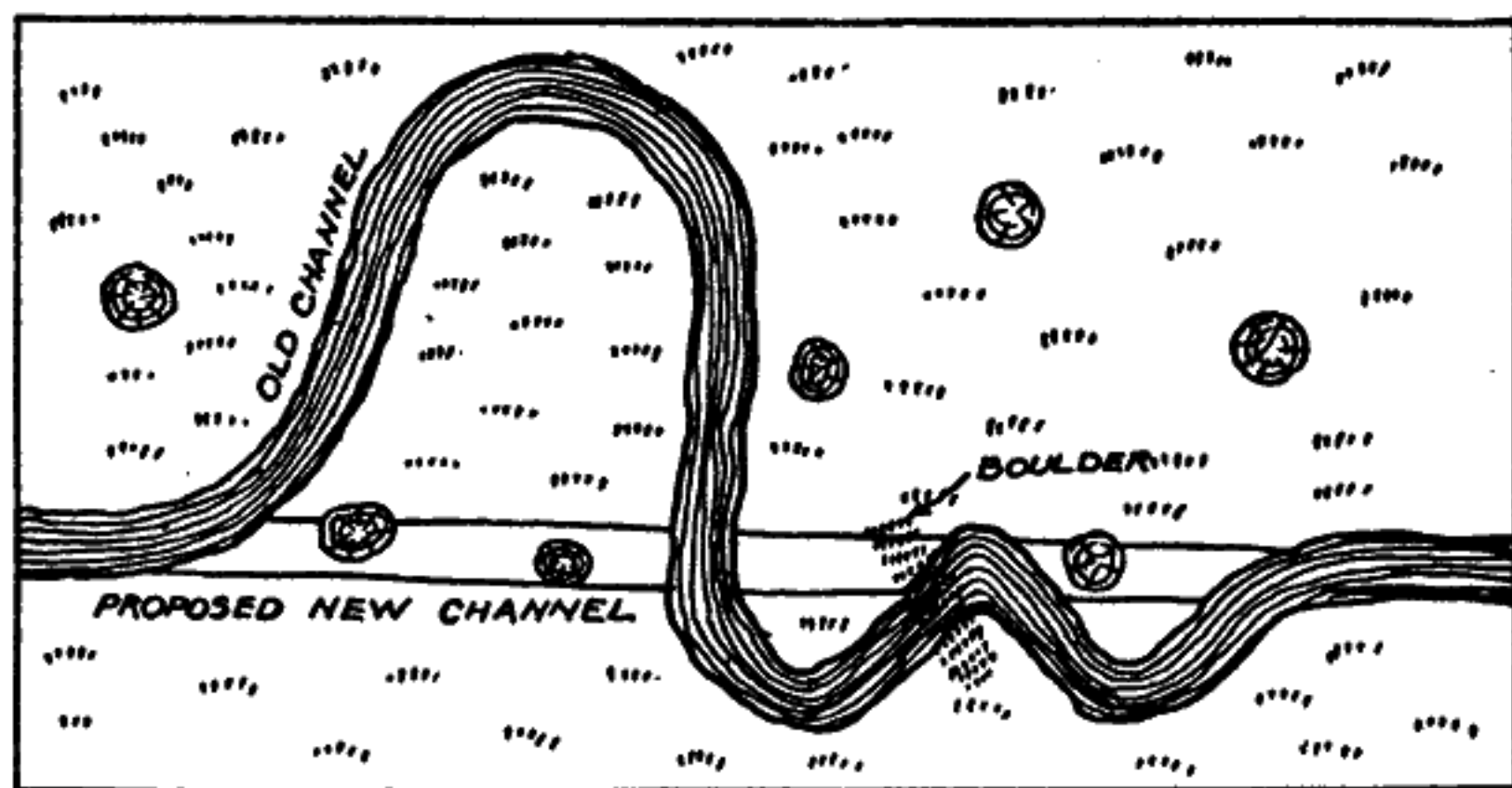


Fig. 149.—Diagram of stream troubles that may be corrected by blasting.

**Ditching and Drainage—Vertical drainage. Digging Ponds**

**Vertical Drainage.**—This type of drainage can be used only when the trouble is caused by hardpan holding the excess moisture on or near the surface of the ground; and where there is an underlying bed of sand, gravel or other loose material through which the water can drain away as is shown in Fig. 150. It is accomplished by drilling a hole almost through the hardpan and loading it with a sufficient amount of Red Cross Extra Dynamite 20% or 40% distributed along the bore hole, to shatter the entire layer of hardpan. When the hardpan is of a gritty nature, no further treatment is needed; but when it is slimy or silty the loading must be heavy enough to create a rough well or crater, which is filled with any sort of available rubbish, such as brush or boulder and stump fragments. This acts as an open drain. The details of the work are shown in Fig. 151.

Vertical drainage is practicable for draining clay pits, roads, railroads, fields, ponds and many other places. In a slightly different application it can be used for the disposal of sewage, spent dyes and laundry waste water. If possible, the blasting should be done when the soil is dry, though good results have been obtained when the water was so deep as to require the use of a boat or float for loading. When the bore holes cannot be kept open long enough to load the explosives, use should be made of old pipe or boiler tubes. These can be slipped into the bore holes, cleaned out with a pump or auger, and the charge loaded inside.

It is best then to hold the charge down with a tamping stick and draw the pipe. When this is not possible the charge must be heavy enough to do double work in splitting the pipe and shattering the hardpan at the same time.

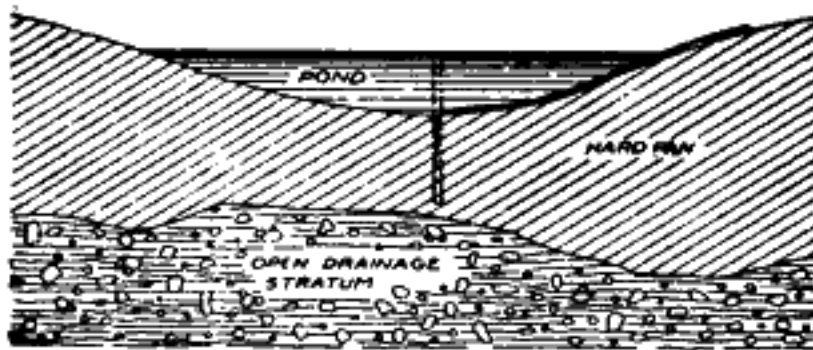


Fig. 150.—When ponds are caused by tight material over open material they can be drained by deep blasting.

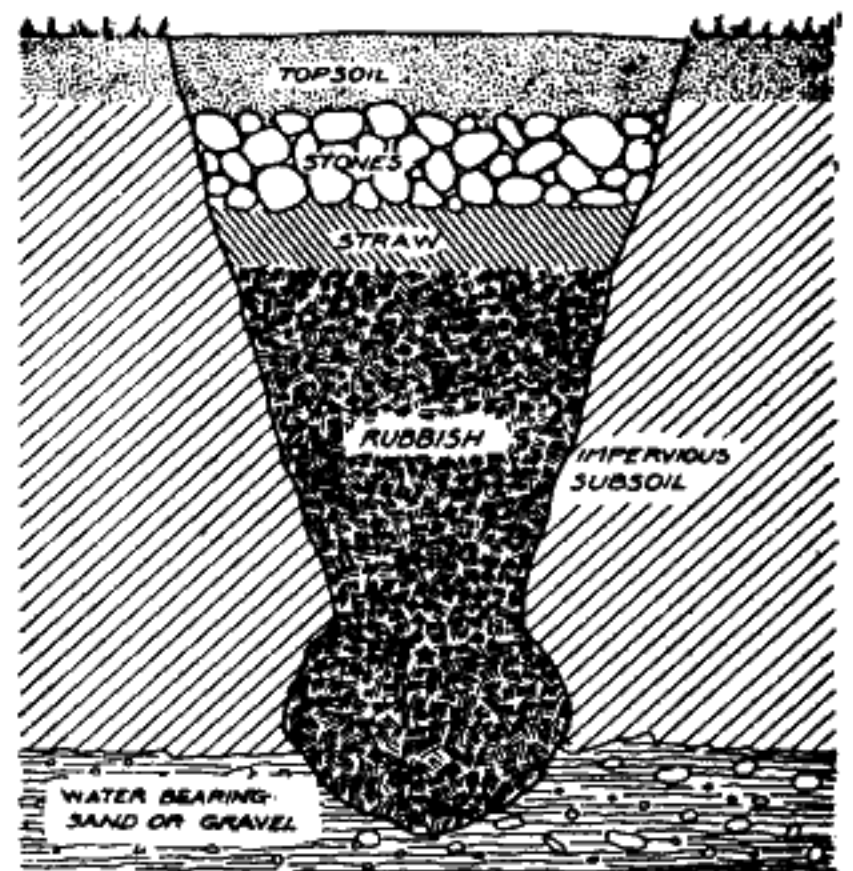


Fig. 151.—Diagram of deep drainage hole, showing the use of trash to prevent the hole becoming clogged with fine clay.

**DIGGING PONDS**

Explosives are used to advantage for blasting out ice and fish ponds. The loading is exactly the same as for ditches and either the propagation or electric method may be employed. (See pages 110 to 116.)



**Digging Ponds. Tunneling and Ore Mining**

There is no limit to the length of pond that may be blasted, but it is quite difficult to blast ponds wider than about 18 feet, as the earth falls back into the hole. For all sizes and kinds of ponds dynamite can best be used for loosening up and blowing out a part of the soil. The rest can be taken out with scrapers. For blowing the soil out entirely the methods of loading are the same as for ditch blasting. For loosening the soil for scrapers, the loading is similar to loosening ground in digging pits, and a slow-acting explosive, such as Red Cross Extra 20%, proves best.

Excellent results are obtained in medium-hard ground by following the methods used in subsoiling as shown on page 99. The loading should be slightly heavier than for subsoiling, and the holes much closer to each other—from four to six feet, depending on the soil.

**TUNNELING AND ORE MINING**

The use of explosives in mines depends on a number of factors, prominent among them being ventilation, amount of water present in the bore holes, nature of the material, methods of working, and also may be added custom.

As to this last, it may be said that miners may be using an explosive by no means the best suited to the purpose for no other reason than that they have always used it. The prejudice in favor of a certain explosive is sometimes so great that the utmost patience and perseverance are required in order to induce miners to use an explosive which is really better adapted for the work in their particular mine.

Where there is much water in the bore holes, a gelatin dynamite with electric blasting caps is generally required, although a Red Cross Extra with cap and fuse water-proofed can be used if loaded and fired with as little delay as possible.

In the matter of fumes a good deal depends on what the miners prefer. One miner objects strongly to the fumes of an explosive to which another miner has become so accustomed that he would not tolerate the fumes from any other. In badly ventilated places, du Pont Gelatin usually gives the least fumes, but where the action of a gelatin is too strong for the material—as in mining gypsum, rock salt and other soft rocks—the Monobels, particularly Monobels 5 and 6, Duobels and Durox, give excellent results. In hard flint rock where it is customary to spring the bore holes before firing there is a certain amount of danger in using a sensitive, granular powder, as small portions of it may sift down into the cracks of the rock, which may move and cause sufficient friction to explode the dynamite. This is overcome by using either a gelatin, which does not sift into the crevices, or a low-grade Red Cross Extra powder, which is not readily fired by friction of this kind. Straight dynamites used for mining have been almost entirely replaced in the last few years by dynamites of the low-freezing ammonia type or by the gelatins, causing a great improvement in fume conditions and reducing the hazard of the use of

**Tunneling and Ore Mining—Delay electric igniters**

explosives by careless and uneducated labor to a very great extent. One of the most desirable features of the permissible explosives of the Monobel type is not only their freedom from liability to ignite gas and dust mixtures, but also their ability to withstand reasonably hard usage in transportation, handling and loading. For ordinary rock a 30%, 35% or 40% dynamite will be found of ample strength for the work, but in some very tough hard rock a 60% strength may be required.

The ventilation of tunnels and mines with a comparatively light overburden can sometimes be very greatly improved by driving a large well-drill hole six inches in diameter from the surface to the working, and, when necessary, installing an air or steam jet in the casing of the six-inch hole in such a way as to suck the fumes out of the tunnel or mine. Very good results have been obtained by this means at comparatively low cost.

In mining, the blast holes are usually not fired together as in quarrying, but in rotation, the space made by the blowing out of the material from one hole furnishing a free face for the next hole to blow into. The firing of shots in rotation is usually accomplished by using blasting caps and fuse, the fuse being cut of varying lengths, the shortest fuse being in the charge desired to fire first, the next longest in the next and so on. The disadvantage of this method is that when there are a number of holes to be fired at one time, that is, at one operation, the blaster is likely to become hurried in lighting the fuse and may fail to light one or more fuses, in which case the entire continuity of the scheme is upset, the holes may fail to break properly and unexploded dynamite may be thrown out into the mine.

**Delay Electric Igniters.**—A more modern practice is to use delay electric igniters, which come in lengths of from two to twelve inches, affording six different periods. When these are placed in the priming charges as described on page 44 and are connected in series as ordinary electric blasting caps and fired either by blasting machine or light circuit, every charge is ignited and every charge is fired in the order desired. There is much less smoke from the burning fuse, the charges are confined better, and the shot-firer is in a safe place at the time the blast is made.

For shaft sinking and tunnel driving and drifting, delay electric igniters used in conjunction with instantaneous electric blasting caps are very effective, particularly in shaft sinking, as it is very desirable that the shot-firer should be out of the shaft at the time the connections are made. With cap and fuse his life depends on the hoisting apparatus not failing after he lights the fuses.

In driving small drifts or tunnels where not more than three periods of delay are required, delay electric blasting caps are very effective and are somewhat more convenient than delay electric igniters. Ordinary electric blasting caps are placed in the cut holes. These are fired first so that there is no doubt about the cut being blown out. In such cases the ordinary electric blasting caps are used to prime the cut holes, first delay electric blasting

## Tunneling and Ore Mining—Tamping

caps are used in the relief holes, and second delay electric blasting caps in the rib, roof and "lifters." These delay electric blasting caps are quite water-proof and require no preparation for wet bore holes.

**Tamping.**—Firing untamped holes is extravagant and expensive, for any explosive will do its best work when strongly confined. In ordinary bore hole blasting when the charges are not tamped, the first, and possibly the second, cartridge nearest the mouth of the hole does no useful work, but merely blows out. It has been found by innumerable experiments and tests that where the bore holes are tamped up solidly with moist sand, loam, clay, or other unflammable material, better execution is obtained with materially less weight of explosive. Not only is the actual work done by the dynamite much more effective, but the stronger an explosive is confined, the more complete is its detonation, and the better are the fumes. In close, badly ventilated work the use of tamping, either in tamping bags or otherwise, will be found to make a marked difference in the character of the fumes. In mining work, effective tamping can usually be depended upon to save at least one cartridge of dynamite, and sometimes more, for each bore hole.

Tamping bags are great time savers, and also savers of dynamite. Small, loose, sharp particles of rock from the muck pile do not make good stemming or tamping material and there is danger of the sharp particles cutting through the fuse or electric wires, causing misfires. The tamping bags can be easily and quickly filled with good earth or clayey material outside the mine and sent in with the dynamite at loading time, thus speeding up the time

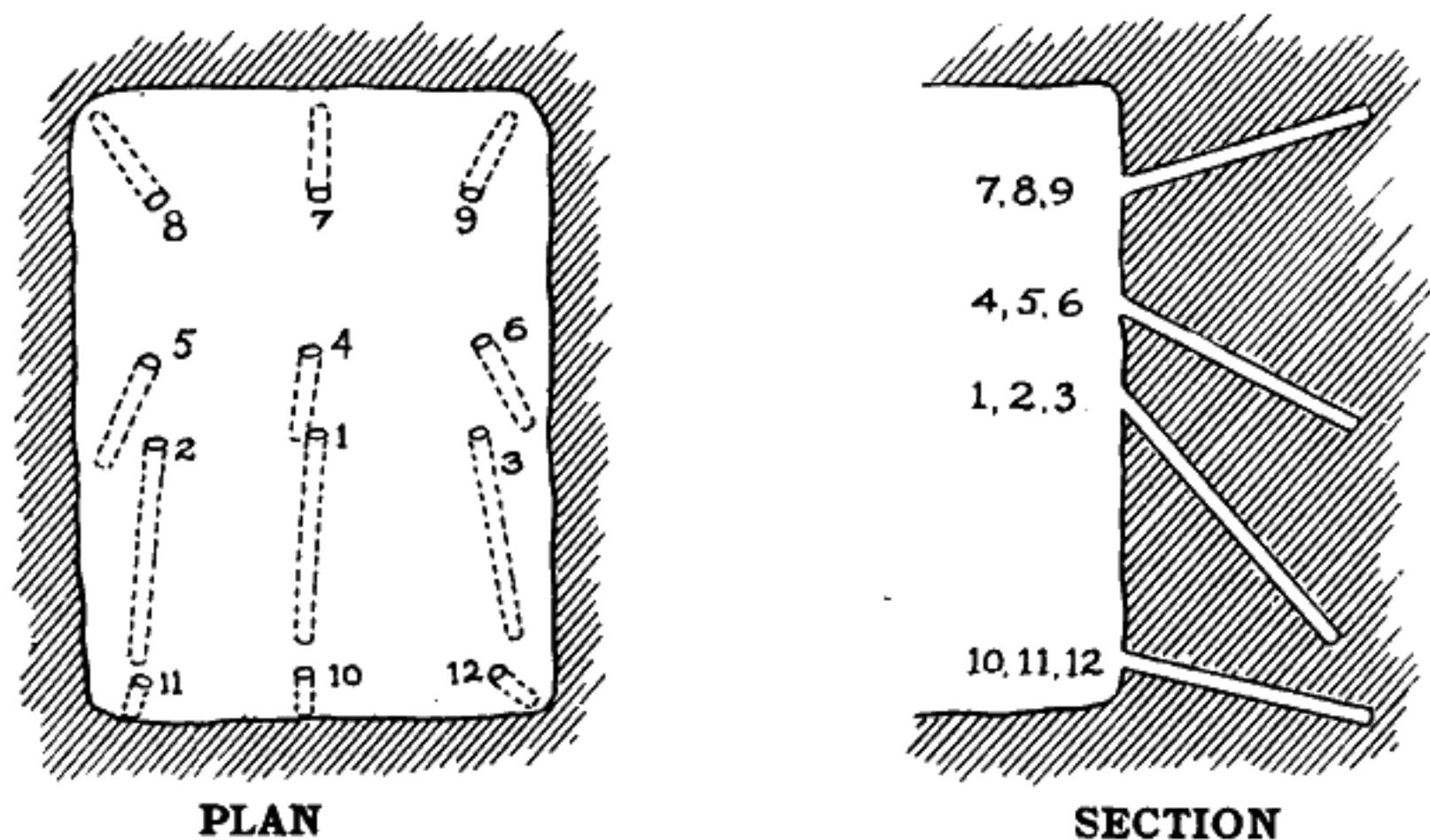


Fig. 152.—These sketches show one arrangement of holes in the breast of a tunnel, or drift, where the cap and fuse method of firing is used. This is the flat cut method and follows in a general way the same idea of undercutting coal. Holes 1, 2 and 3 are fired in the order numbered and blow out the bottom, thus undercutting the breast. Holes 4, 5 and 6 are fired next, and then holes 7, 8 and 9 and then 10, 11 and 12 which break grade and turn the muck back from the face. In small drifts, or in soft, easy-breaking rock, holes 4, 7 and 10 may often be dispensed with.

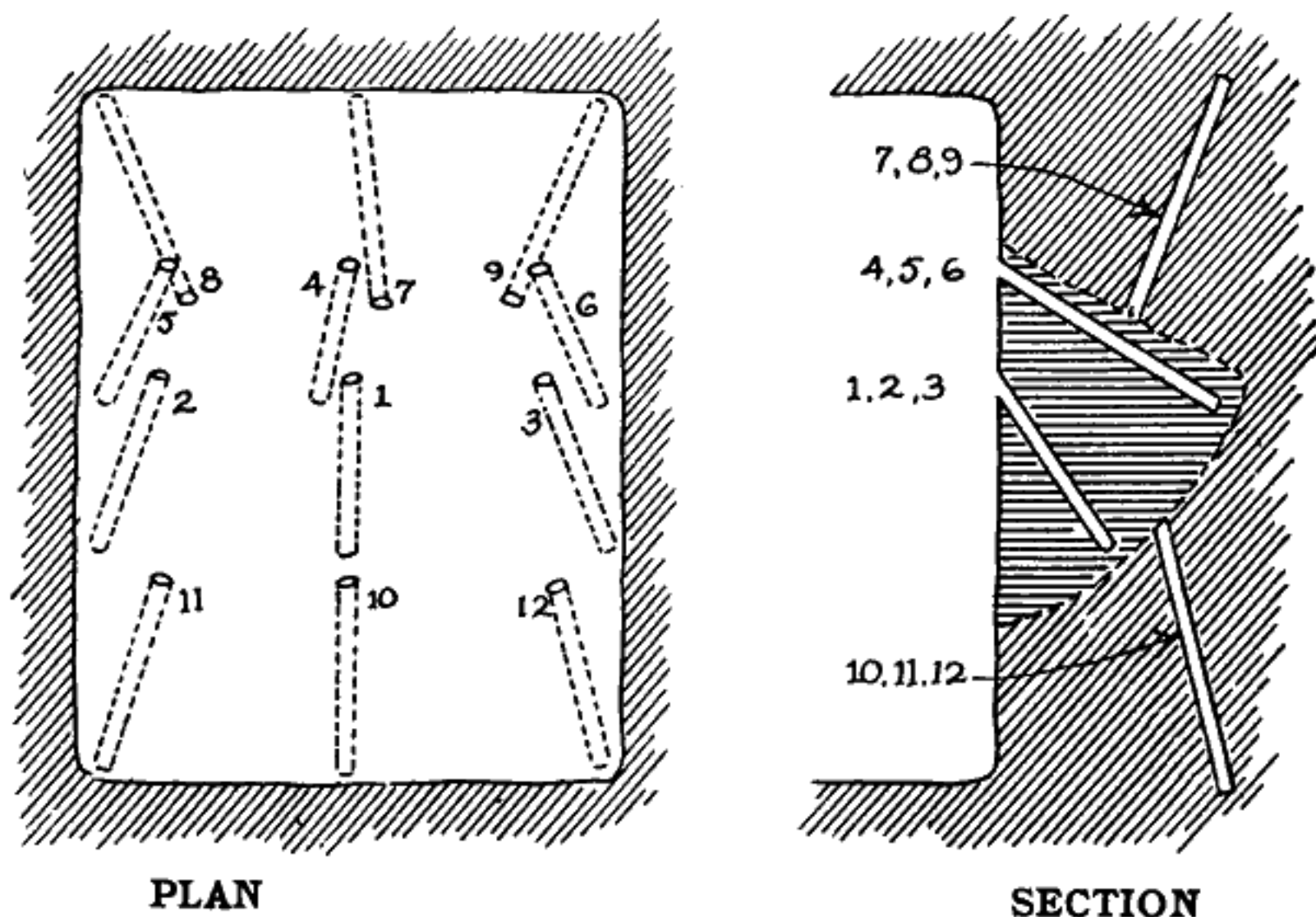


**Tunneling and Ore Mining—Driving tunnels and drifts**

consumed in loading the bore holes and securing better execution and stronger confinement of the dynamite. Their use is particularly beneficial in loading uppers, which are difficult to tamp satisfactorily with loose stemming material.

**Tunnels and Drifts.**—In driving tunnels and drifts in mining, subway, canal, and sewer construction, gopher or coyote holes for blasts and railroad work the bore holes may be drilled either by hand or by power drills. Air drills are usually preferred on account of the good ventilation produced by the exhausting air. For the heading, machine drills mounted on columns or bars are generally used, while in large tunnels on benching work behind the heading, jack-hammer or tripod drills are preferable. Hand drilling is ordinarily more expensive and slower than machine, although in some very small tunnels, such as gopher holes for blasts, it is almost imperative. Downward slanting holes are most economical of drilling, both because the weight of the drill rests against the bottom and because the water used lubricates the hole and drill.

Where machine drills are used, a complete round of bore holes is generally drilled before loading and firing so that the entire tunnel face or header is broken out to the full depth of the holes at one blasting operation, leaving the new face squared up for the next round. The holes are so pointed and arranged with regard



PLAN

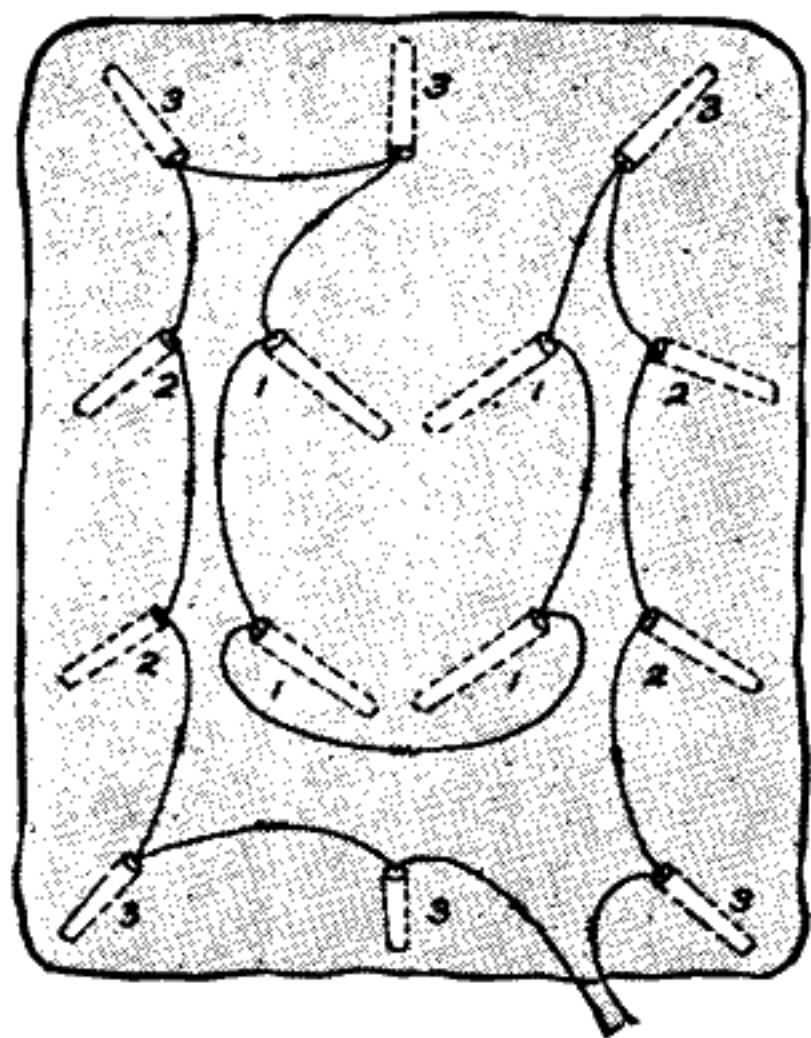
SECTION

**Fig. 153.**—Showing method applicable to tunnel work, using center cut holes when single-hand drilling and cap and fuse firing is done. Holes 1, 2 and 3 are drilled, then fired in order as numbered. These blast out the center cavity, as shown at the right in the vertical section. Holes 4, 5 and 6 are then drilled and fired, taking out the cross-hatched area at the upper right corner of the section. Holes 7 and 8 follow last, blasting out the lower cross-hatched area. Sometimes holes 7 and 8 are started near the floor of the tunnel and given a flatter slope. In hard rock another hole can be drilled at the bottom between 7 and 8, and fired before them. In medium rock, hole 4 can often be omitted, and in softer, easily broken rock, holes 1, 5, 6, 7 and 8 will be sufficient to blast out the face.

## Tunneling and Ore Mining—Driving tunnels and drifts

to spacing that when they are fired in rotation or series of rotations, each preceding hole or series of holes relieves the burden from the next, giving a free face for each hole to break into, and preventing "boot legging," "John Hodges," "blowing off the collar" or "potting out," as it is sometimes called, with a consequent waste of dynamite and drilling time.

The cut holes, or holes which are usually drilled at an acute angle to the face and arranged to blow out a cone or wedge shaped cavity in the center of the tunnel breast, are fired first; these are followed by the relief holes, which are drilled so as to break into and enlarge the cavity; after the relief holes come the rib holes, followed by the top or roof holes and the lifters, which trim and square up the sides, top and floor of the tunnel. In very tough rock that is hard to break and in tunnels of large cross section, several series of relief holes are often necessary, while in smaller tunnels and easy-breaking rock they may be entirely dispensed with, as the rib, roof and lifter holes will break through into the cavity made by the cut holes. The depth and diameter of the bore holes, kind and grade of dynamite used, and the method of firing are also governing factors in the number and direction of pointing of the bore holes in a round.



The advance of a heading with each round depends entirely on the amount pulled by the cut. Also, a careful study of drifting has shown that if the cut holes can be arranged in pairs to form a V, the cut will pull cleaner and the consequent dead drilling or lost ground will be reduced to a minimum.

A number of the large mining companies have in recent years made a careful study of driving drifts and the results of their work have shown that the V cut will pull cleaner and bring

**Fig. 154.**—Showing a round of bore holes drilled by a column mounted drill ready for electric firing. The cut holes numbered 1 are primed with instantaneous electric blasting caps, which fire first. The rib holes, 2, contain first delay electric blasting caps, firing shortly after the cut holes. The holes numbered 3 are the top holes, and the lifters primed with second delay electric blasting caps, and are fired last. The complete round of holes are loaded and primed with the proper electric cap, all being connected in series to the leading wire and fired with one application of the current from the blasting machine or power circuit, blasting out the entire tunnel face to the depth of the bore holes.

Where water is encountered, one of the lifters in the lower corner should be drilled below the floor of the tunnel so as to make a drainage ditch at one side.

**Tunneling and Ore Mining—Sinking shafts**

more ground than any other type of cut, except where favorable slips or cleavage planes may make the drilling of V cuts unnecessary. If the dimensions of the face and working conditions are such that the cut holes can be drilled across the formation in stratified rock, the cuts will pull better and cleaner.

In some mines it has been found that a V consisting of a single pair of holes is sufficient. This V may be placed in any position which is favorable and does not refer to the standard V cut commonly used in tunneling where a vertical V is always blasted from the center of the face. Sometimes in very hard rock it is advantageous to use the center or diamond cut where three or four holes are drilled to meet at a common point.

In hand drilling, the holes are seldom larger than  $1\frac{1}{8}$  inches in diameter or deeper than four feet, and frequently only part of a round of holes is drilled and fired at one time on account of the slowness in drilling the holes and the general practice of firing at the end of each shift. The cut holes and the nearer relief or rib holes are usually drilled and fired first. This often leaves the face in shape so that better locations and direction of pointing for the succeeding holes may be secured.

When machine drilling is used, the entire round is drilled before any firing is done, for it is not economical practice to take down and remove the machine to fire an incomplete round. The holes are generally from six to eight feet deep and from  $1\frac{1}{4}$  to  $1\frac{1}{2}$  inches in diameter.

**Shaft Sinking.**—In sinking shafts, wells, foundation pits, and other work of this character in rock, much the same principles apply as in tunneling. Practically all of the bore holes are down holes, and if power drilling is done, a hammer drill or tripod drill

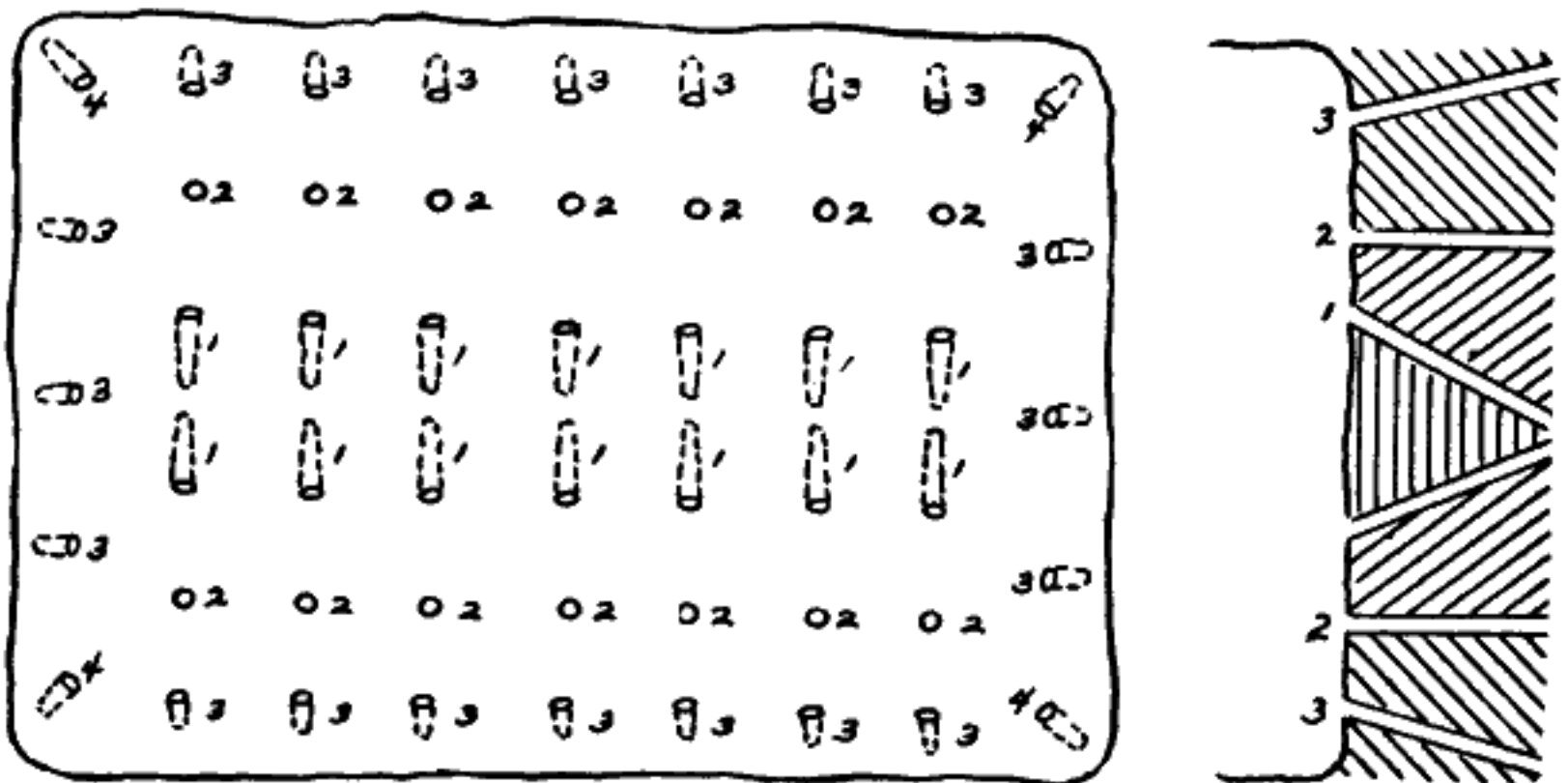


Fig. 155.—A complete round of bore holes in a large shaft in hard rock, in which the use of electric blasting caps in the cut holes and delay electric igniters of varying delays in the other holes, all connected on the same circuit, will give excellent results. The cut holes numbered 1 are primed with instantaneous electric blasting caps, and fire first. The relief holes numbered 2, primed with first delay electric igniters, fire next. These are followed by the rib or trimming holes numbered 3, which are fired with second delay igniters. The corner holes numbered 4 fire last, as they are primed with third delay igniters.



**Tunneling and Ore Mining—Stoping. Coal Mining**

gives good results, although a bar-mounted drill may be used. As a general rule, more dynamite and a larger number of holes are required in shaft sinking than in tunnel work under equal conditions. This is largely because the rock must be lifted vertically and the blasted "muck" from one hole falls back on top of each succeeding hole, requiring greater power to perform the double duty of lifting both its own burden and part of the débris from the preceding hole.

In wet work, some of the bore holes on one side or in one corner are usually bored deeper in order to have a small depression or sump in which the water can collect and be drawn off by the pump suction or bailed out, thus keeping the larger portion of the bottom free from water.

**Stoping.**—In the underground stoping out of large ore bodies, the usual practice is to drive a tunnel, drift or raise to tap the ore body at the lowest point and then work upward. By doing this, the ore is handled more cheaply, as it is blasted down into chutes or on prepared shoveling platforms, thus reducing the labor required. The drilling may be done by hand or by a specially developed light air drill called a "stoper." In many cases the holes are drilled at random in advantageous places, no particular system being followed, and in other mines a raise or header is driven in advance and the ore blasted down in a series of upside down benches or stair-steps. The driving of a raise does not materially differ from ordinary tunnel driving, except that practically all holes are uppers, and timbering must be done behind so that the miners can have something to stand upon while working.

As nearly all bore holes in stoping are uppers, the use of tamping bags in doing the tamping will prove a great advantage. The explosives used in this class of work are the same as used in ordinary mining work.

In another form of stoping sometimes practiced where the ore occurs in horizontal sheets of varying thickness a header is driven in on top of the ore strata after much the same manner as in large tunnels. The balance of the horizontal sheet is lifted up by snake-holing under the bench with heavy charges in sprung holes.

## COAL MINING

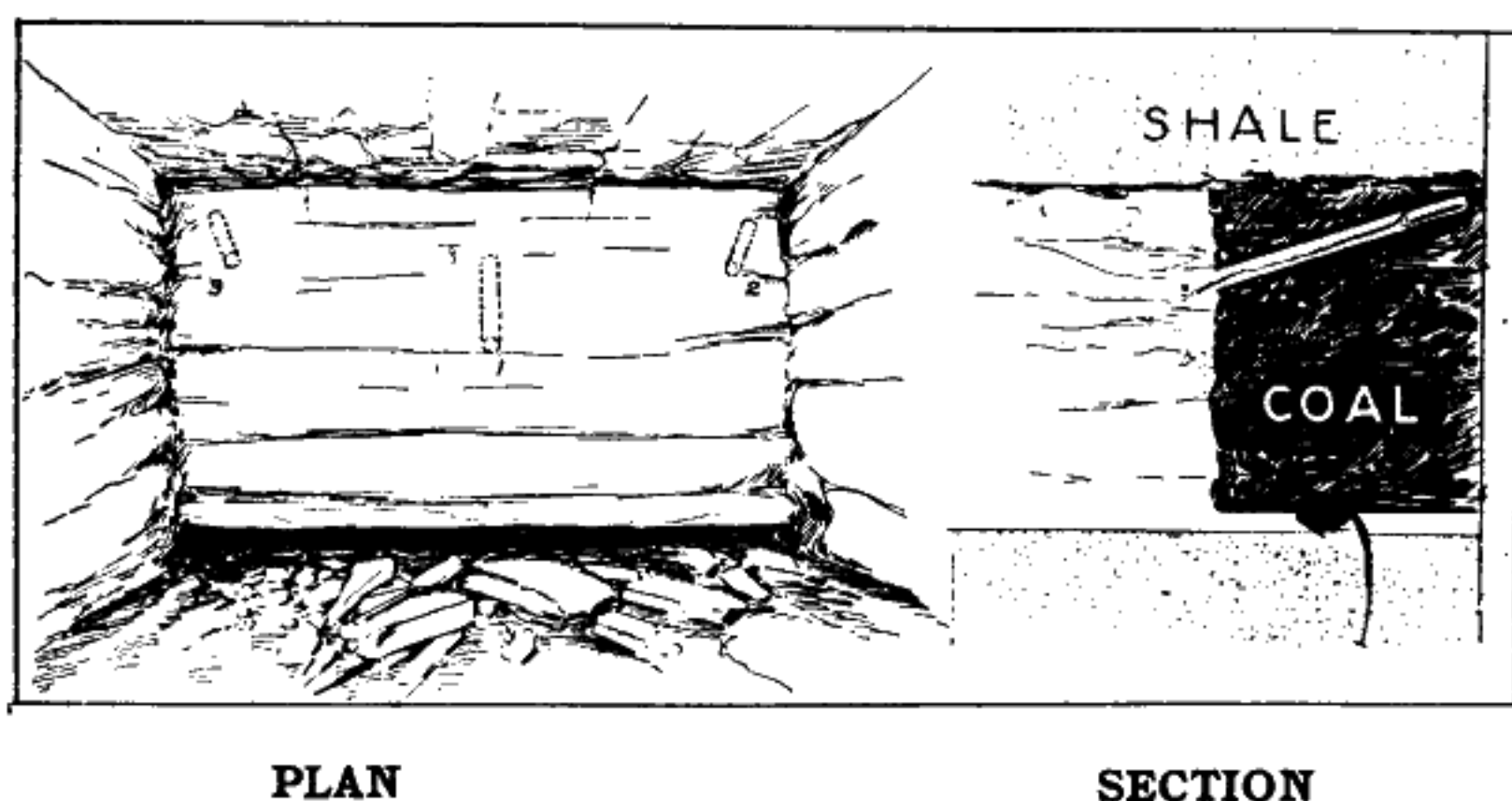
Practically all coal mining done at the present time involves the use of either blasting powder or permissible explosives. Blasting powder has the advantage of a low initial cost, and its use is familiar to miners so that they know how to place the bore holes to best advantage and by proper selection of grain they can break the coal in such a way as to get the maximum of desirable sizes.

Except for coking coal, it is usually desired to get as much of it in large lumps as possible. Where inflammable mixtures of dust, gas and air are present, the use of blasting powder is extremely hazardous, as the ignition of local pockets of gas or dust may bring on a general explosion throughout the entire mine. The constant

**Coal Mining—Permissible explosives**

occurrence of mine fires caused by blasts with blasting powder is a source of great expense and considerable danger.

The use of permissible explosives in the manner described by the U. S. Bureau of Mines almost entirely eliminates the possi-



**Fig. 156.**—The above sketch shows the arrangement of holes for blasting down under cut coal. Hole No. 1 should be fired first, and then can be followed by either No. 2 or No. 3.

bility of ignition of gas or dust. Permissible explosives are short-flame explosives which have passed certain tests in the laboratories of the Bureau of Mines. When properly loaded, exploded with a standard strength detonator, permissible explosives, used in quantities not exceeding one and one-half pounds per bore hole and properly tamped with a suitable tamping material, have the least possible likelihood of igniting gas or dust.

Permissible explosives require a little different pointing and placing of the bore holes from those in which blasting powder is used, but with a little experience the direction is easily learned and the proper quantity of explosive to do the work desired is readily determined.

Permissible explosives may be divided roughly into three classes, Carbonites, Monobels and Duobels. Carbonite resists water very well, but makes more smoke and fumes than Monobel or Duobel.

Monobel and Duobel do not withstand water as well, but are much stronger in their action and give off much less offensive smoke and fumes. Both are permissible when used under conditions mentioned above.

The most serious accidents in bituminous coal mines are due to explosions of mine gas or coal dust or mixtures of both which are started by the flame from the explosives used in blasting the coal. Careful study and tests have proved that mine gas and coal dust can be ignited more easily by some blasting explosives than by others and that large charges of any explosives are more likely to ignite mine gas and coal dust than smaller ones. Charges of explosives in bore holes which are well tamped from the charge to the

**Coal Mining—Permissible explosives**

collar with damp clay are less likely to ignite gas and dust than charges which are tamped only with "bug dust," slack coal or when tamped insufficiently with any material.

Shots which are insufficiently tamped or tamped with "bug dust," coal slack or similar combustible material are exceedingly dangerous, owing to the chance of the flame igniting the coal dust. Moist clay should be used and it should fill the bore hole from charge to mouth.

The practice of placing the primer cartridge, with cap and a short piece of fuse attached, in the mouth of the bore hole, lighting the fuse, ramming the cartridge down into the bore hole with little or no tamping, is exceedingly dangerous, both because the charge is not sufficiently tamped and because the short fuse is liable to burn through and explode the shot before the miner can reach a safe place. This practice is sometimes called short fusing or "skin-'em-back."

It is of the utmost importance that the strongest detonators (blasting caps or electric blasting caps) should be used with permissible explosives; they are less likely to cause ignition of gas or dust when detonated completely. Weaker detonators and detonators which have become damp often ignite the explosives and set them on fire, instead of exploding them, and this invariably ignites mine gas, if any is present, and may cause a more or less disastrous fire or explosion.

The du Pont Permissible Explosives are made expressly for blasting coal in mines where gas or dust may be present. They are made in several varieties, each one adapted for a particular kind of coal. The most satisfactory kind for any one place can only be determined by experience. They are designed for soft coal, medium coal and hard coal and for dry and wet work. Some of them are so made that they will not freeze unless exposed to very severe weather conditions for a long time.

Permissible explosives require a blasting cap or electric blasting cap to detonate them. They cannot be exploded with fuse or squib alone. A No. 6 Blasting Cap or Electric Blasting Cap should be used to explode them, as they are not passed by the Government as permissible explosives if a weaker detonator is used.

Two different kinds of permissible explosives must not be used in the same bore hole and neither blasting powder nor dynamite must ever be used in the same bore hole with permissible explosives.

Firing permissible explosives by electric blasting caps is far safer in gas or dust than firing by means of blasting cap and fuse. For electrical firing a du Pont Blasting Machine, coil of leading wire and du Pont No. 6 Electric Blasting Caps should be used. Two or more bore holes may be fired at the same time, and if they are too far apart for the wires from the electric blasting caps to join each other, it is necessary to have connecting wire between the bore holes.

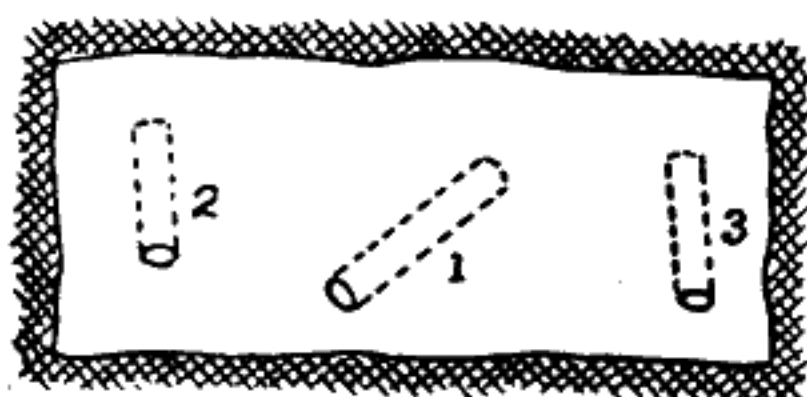


## Mining Flint Clays

## MINING FLINT CLAYS

The underground mining of siliceous fire clays is practiced much as is coal mining, using the pillar and room method. The entry being established, the rooms should be only as wide as the nature of the roof will stand. The pillars should be wide and in keeping with the weight they must bear.

Flint clays occur in a variety of ways. They may overlie softer clay or may be covered with more or less coal. When the height of the coal is sufficient to make the operation pay, it should be



No. 157.—A much-used "break-in" shot. The holes are bored, loaded and fired in order numbered.

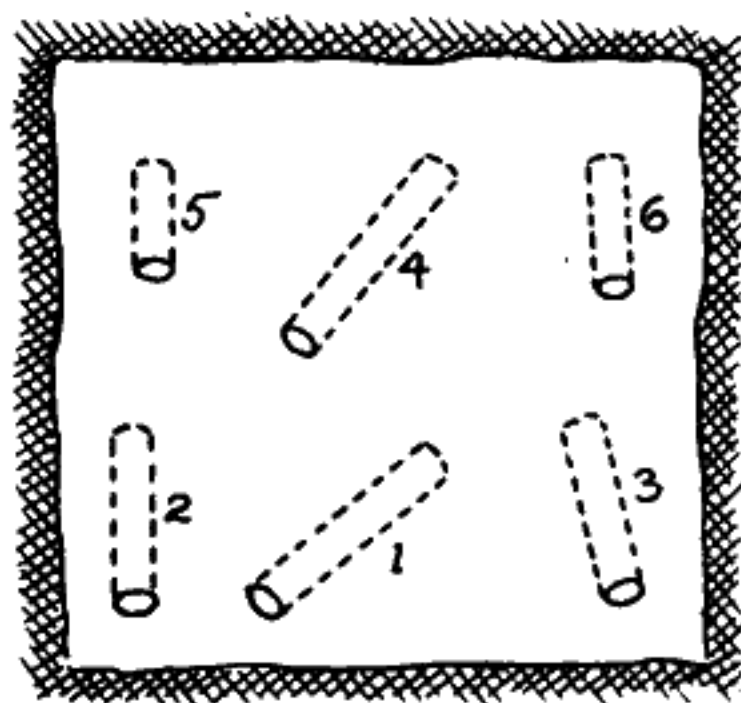


Fig. 158.—A good method of loading the "break-in" in high clay. The shots are bored and fired in order as numbered. Frequently either 2, 3, 5 or 6 can be omitted.

mined off first. Care must be taken not to get the coal mixed with the clay. When the coal is removed for some distance ahead the clay can be lifted by slab shots loaded in deep and nearly flat holes. This method has the additional advantage of getting the coal and waste out of the way before the clay is disturbed, and reduces the danger of mixing objectionable matter with the clay.

When the soft clay is of sufficient height, and the coal not of a quality to mine, the soft material should first be mined out. When this is done, the hard clay is shot down by means of flat holes.

For "breaking-in" or "cut" shots in opening up a header or breast, a variety of methods is employed. The best advantage should always be taken of all slips or faults. Many prefer a single breaking-in shot, such as is represented in Fig. 157, while some, especially where the clay is hard to break, prefer to load two holes pointing together instead of the single shot at 1. For some clays decided variations from these methods are required to suit the peculiarity of the ground.

The rib and slab shots are usually drilled to the full depth of the "cut" or "break-in" and carry a burden of about 3 to 4 feet.

The parting at top and bottom is usually so good that lifters and back shots are not required.

The shooting of flint clay requires much care, as it is likely to be broken so fine that the loss as waste reduces the output of the mine.

**Quarrying—Dimension stone; benching**

Formerly all flint clay was mined with blasting powder, but this is being replaced by 20 to 40% Red Cross Dynamite. For a reduction of the trouble from fumes, the use of Durox is to be recommended. This is a permissible explosive especially prepared for hard underground work, and breaks down the ground in better lump condition than do quicker-acting explosives. The use of electric blasting caps is strongly recommended, as they are more in order with the "safety first" idea.

**QUARRYING**

Quarrying may be roughly divided into two kinds—whether the material moved is to be used for dimension stone or whether it is to be crushed for road building, fluxing stone or other purposes. In the former case it is not desirable to shatter the stone, hence it must be brought down in as large pieces as is feasible. Blasting powder of the correct granulation to give the effect desired is the most satisfactory in this work.

For crushing and fluxing, the stone should be well broken up. This is usually accomplished by the use of high explosives in any of the four general methods of carrying on quarrying operations, benching, snakeholing, well drilling and tunneling or gopher holing.

**Dimension Stone.**—For quarrying dimension stone high explosives are almost never used, as they are likely to start invisible cracks and seams in what appears to be a perfectly sound block. Blasting powder of rather fine granulation is used for starting cracks and seams in the direction desired by firing charges in closely spaced holes in which a rather large air cushion is purposely left. For instance, in a twenty-foot bore hole there might be loaded eight feet of blasting powder, a piece of rope, bagging or the like placed in the bore hole eight feet from the top, and then tamping as tightly as possible on top of that. For breaking blocks of dimension stone loose from their bedding, a fine grained blasting powder is poured into the crack made by the plug and feather method, and, by repeated firing of very small charges only a few ounces at a time, the block can be moved out so that it can be handled.

**Benching.**—In this method the face of the quarry is carried forward in a series of benches corresponding somewhat to stair steps on a large scale. The steps are not always regular, but vary with the thickness of the strata or ledges and location of advantageous bedding seams. They generally average around 12 to 16 feet in height, though 20 feet is frequently met with.

Most of the drilling is done with tripod drills run by steam or compressed air, though for the shallower holes of from 6 to 10 feet the jackhammer type of drill is gaining in popularity. The holes are drilled straight downward and along a line about 8 to 10 feet back from the face and spaced generally from 6 to 10 feet apart.

**Quarrying—Benching; snakeholing**

Owing to the small diameter of the holes, from  $1\frac{1}{8}$  to  $1\frac{1}{2}$  inches, at the bottom, it is frequently necessary to spring the holes so that more explosive can be placed in the bottom. This is especially true in hard rock, or where the seams pitch downward into the face, instead of upward or on a level. Another way, where the rock will not stand springing, is to space the holes closer to each other, or to drill divergent holes from one set-up of the drill.

The holes are usually loaded at least half full of explosive of the type best adapted for the particular rock and degree of shattering desired. Where the rock is not very hard, such as medium limestone—and a minimum of spawls or fine material is desired—Red Cross Extra Dynamite in 25 to 30% strength is satisfactory; but where the rock is somewhat harder and finer shattering is wanted Red Cross Extra or du Pont Straight 40% or stronger is better.



Fig. 159.—Loading the holes in a quarry where snakeholing is practiced.

The holes are well tamped and fired simultaneously by electric blasting caps.

**Snakeholing.**—This method finds much favor in hard massive irregular formations having no particular lines of stratification or cleavage, and in cases where the strata are on edge in such a manner as to prevent the easy drilling of down holes. In the latter case holes should be drilled if possible perpendicular to stratification. Snakeholing is not, as a rule, recommended for faces over 60 feet in height.

The holes are drilled with tripod drills almost horizontally, at the base of the face, starting about two feet above the quarry floor and allowing enough dip to bring the point of the hole on a level with the floor. They are generally drilled from 25 to 30 feet deep and spaced from 8 to 10 feet apart. In order to accommodate enough explosive to blast down the entire face at one shot, these holes are almost always sprung, sometimes five or six times each with increasing amounts of dynamite in each springing shot, so that from 100 to 300 pounds of dynamite, depending upon the



## Quarrying—Snakeholing

burden above, can be loaded in the back of each hole, leaving practically the entire shank of the hole for tamping. In some cases the cartridges are loaded through a tin tube, and in others by means of a long bamboo pole.

In medium rock and where a minimum of spawls is desired, springing with du Pont Straight 40% and loading with Red Cross Extra 40% will give good results. Where harder rock is worked and where more shattering is wanted 50% du Pont Straight for springing with du Pont Gelatin 40% for loading will be more satisfactory. For the extremely hard rocks of the granite and trap types it is sometimes necessary to use 60% Straight or 60% du Pont Gelatin. The charges should always be fired together by electric blasting caps.

In general for work of this kind where the holes must be sprung a number of times in hard rock in order to accommodate a sufficiently large charge, a dense dynamite like gelatin is preferable for the loading charge. A greater weight of gelatin than of any other dynamite can be loaded into a chamber of a given size, hence its use ordinarily results in an economy in the amount of explosive used for springing.

It might also be stated that where springing is regularly practiced in rock that leaves open cracks and sharp spawls in the chambers after each shot, gelatin is a safer explosive to use for springing. It is not so likely as is a straight dynamite to sift down into the cracks where it might get pinched in subsequent loading

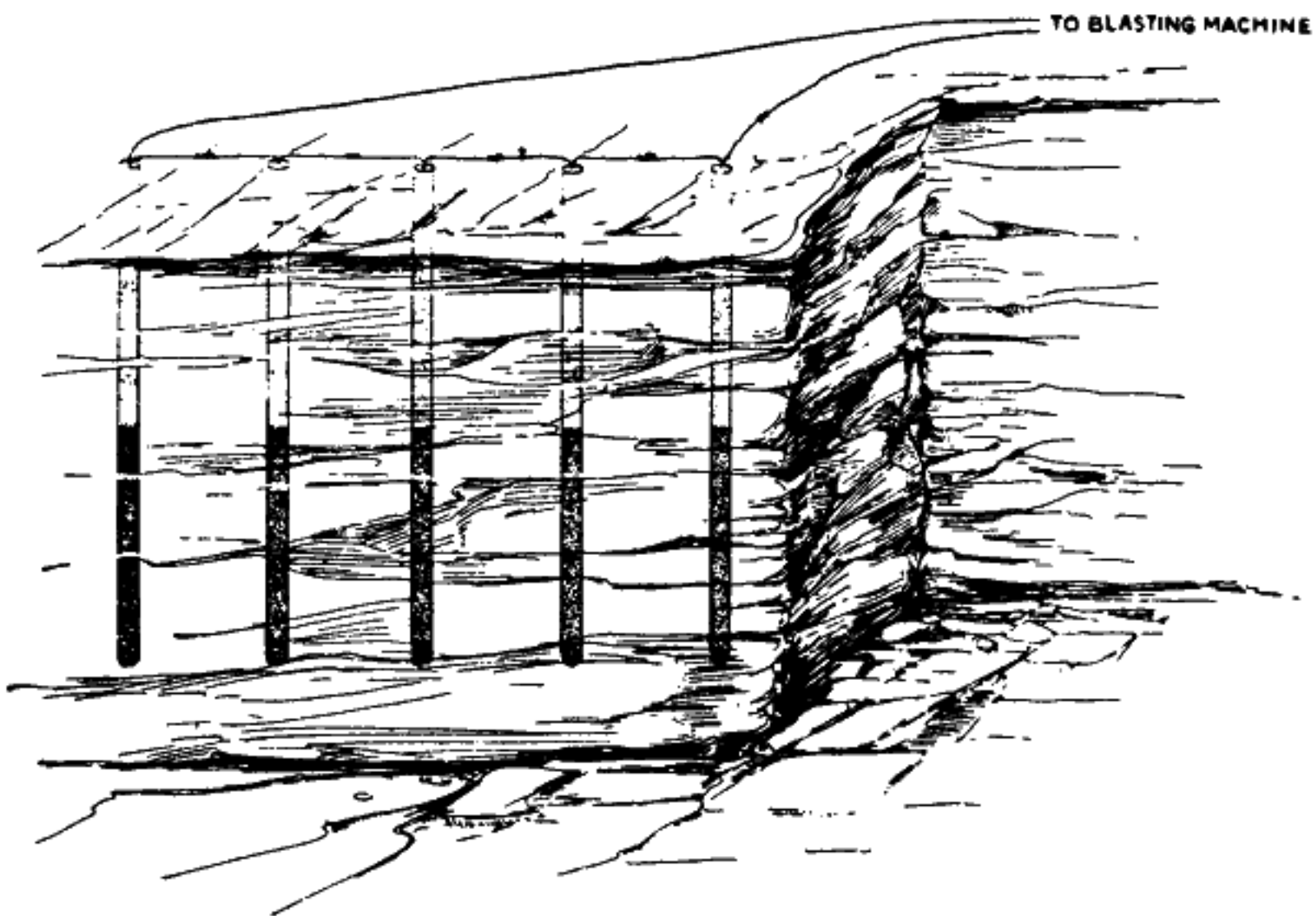


Fig. 160.—Showing a well-drill blast ready for firing. The spacing back from the face and distance apart of the holes depend upon the height of the face and character of the rock. It is better policy for both safety and assured detonation to use two or more electric blasting caps in each hole. Sometimes the loading is broken so that the dynamite is placed at the hardest portions of the face, and the holes are generally filled from two-thirds to three-quarters full of dynamite, the balance of the hole being well tamped.

**Quarrying—Well-drill holes**

and tamping operations and cause an accidental explosion. Where water tamping is used on springing shots, the higher strength gelatins 60% to 75% have been found to give better results than straight dynamite for springing.

**Well-Drill Holes.**—A later method of quarrying that is rapidly gaining in favor is one in which the face is kept vertical or nearly so, the entire face being blasted down at one time by means of deep well-drill holes. This is a very satisfactory way where the face is more than 25 feet high and where the rock is not so badly pitching and cross seamed as to cause binding of the drill bit.

Vertical holes of large diameter, from 4 to 6 inches, are drilled along a line back from and parallel to the full depth of the face or a few feet below the floor level where there is not a good parting or cleavage line at that point. In softer material and the shallower faces the 4 to 4½ inch hole is more often used, while in hard rock and higher faces the 5⅝ inch hole gives better results. The distance back from the face or burden on the line of holes and the spacing apart vary with the depth of the holes and hardness of the material. A general average is somewhat as follows:

Holes 30 to 40 feet deep, burden 15 feet, and spacing 12 feet.

Holes 40 to 50 feet deep, burden 18 feet, and spacing 14 feet.

Holes 50 to 90 feet, burden 20 feet, and spacing 16 feet to 18 feet.

Holes over 90 feet deep, burden 25 feet, and spacing 20 feet.

A second line of holes is sometimes drilled back of the first and both are fired together. This will give best results if there is a free cleavage plane at the bottom of the face and the holes are "staggered."

It is often the case that the face cannot be kept vertical, and there is an extra heavy burden on the bottoms of the holes due to an out-sloping toe. In this type of work it is sometimes necessary to spring the bottoms of the holes in order to concentrate enough explosive at the point where the burden is heaviest. Another way is to drill a number of snakeholes into the heaviest portion of the toe and fire them at the same time with the well-drill holes, thus relieving the burden at this point.

No definite amount of explosive per hole can be given because conditions vary so much, but many good quarrymen figure the cubic yards and tons of stone in the blast and then load at the rate of one pound of explosive to 4 to 6 tons of stone. In deep holes the loading is sometimes broken, that is, 15 to 20 feet of explosive, then 10 or 15 feet of tamping, then more explosive, followed by tamping and so on until the hole is loaded. In broken loading the charges of explosive should be placed at different levels in the different holes, and at advantageous points where the rock is hardest and freest from cracks and seams. At least two electric blasting caps should be contained in each charge. For the manner of loading see pages 69 to 71.

The kind of explosive to use is dependent upon the character of the rock and the degree of shattering desired. As the heaviest bur-

## Quarrying—Tunneling or gopher holing

den is at the bottom of the hole, a stronger dynamite is usually loaded in the bottom and topped off with a lower strength. In wet holes, a gelatin dynamite should be used.

In hard clays and shales, Red Cross Extra 20 to 30% in the bottom with du Pont R. R. P. on top will give good results. In medium rock, such as the softer limestone, 40 to 50% Gelatin Dynamite topped off with 30 to 40% Red Cross Extra, and in harder rock, 50 to 60% Gelatin with Red Cross Extra or du Pont Straight of 40% strength on top does good execution. For the very hard granites du Pont Gelatin or du Pont Straight 60% may be necessary. Red Cross Extra 40% and Durox are largely used for the top loading in medium hard rock.

The holes are always fired by electric blasting caps (see page 27) or by means of cordeau (see page 32).

**Tunneling or Gopher Holing.**—This method is practical for faces between 80 and 150 feet in height, and consists in driving a small tunnel of about 3 feet by 4 feet in cross section horizontally 40 to 50 feet into the face and several feet above the quarry floor in order to take advantage of the underbreak of the blast. Cross cuts of varying lengths are generally run at right angles to the main tunnel, thus forming a T, and the explosives loaded into offsets or recesses made at intervals along the arms of the T and in the ends.

These tunnels can be driven by means of jackhammer drills, small column drills, or by hand-drilling in the same manner as is described under "Tunnels and Drifts" on page 122. As they are smaller, the depths of the drill holes and the number of holes per round are less than for larger sized tunnels.

The cross cuts branch off from the main leg, at intervals ranging from 20 to 40 feet and the recesses for the explosive units are generally 15 to 25 feet apart along the cross cuts, depending upon the hardness of the rock, burden to lift, and the degree of fragmentation desired. These recesses should be of just sufficient size to accommodate the charge without leaving too much air space.

Some blasters prefer, if practicable, to sink pits for loading so that the entire charge is below the level of the tunnel floor, claiming that so doing gives better confinement, better execution from the explosive, and a better grade in the quarry floor.

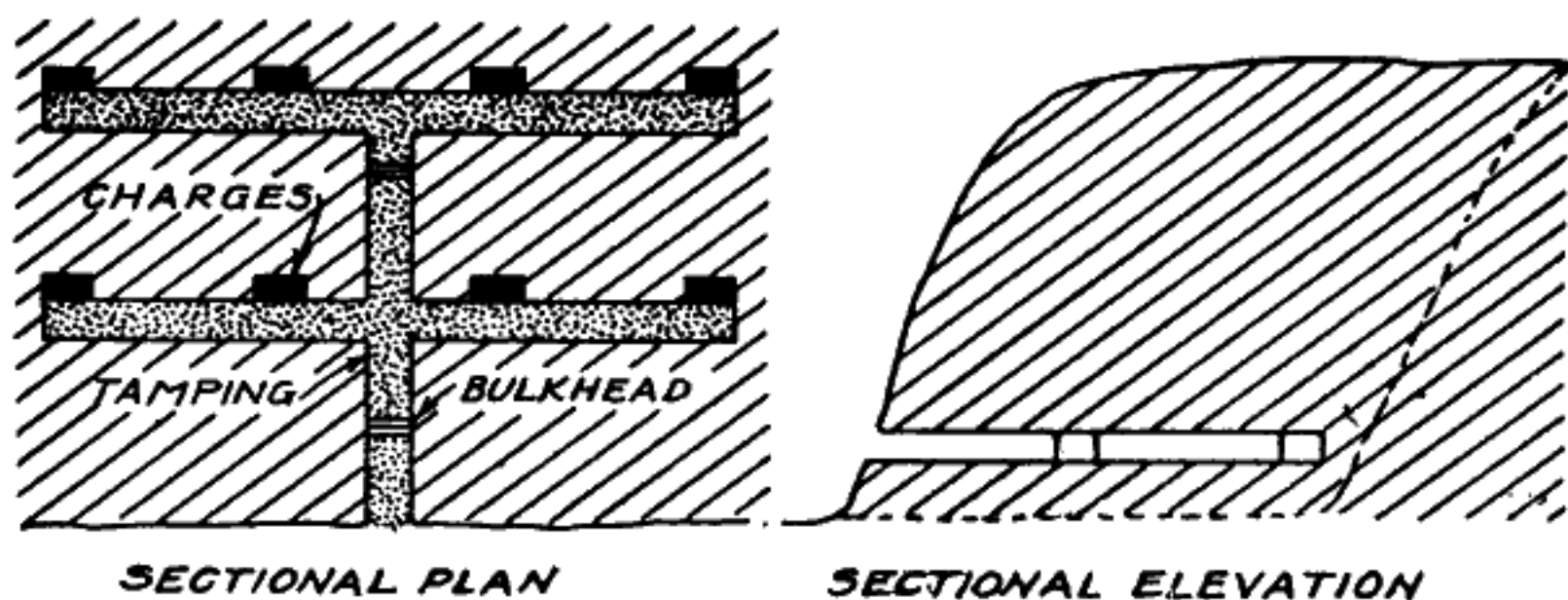


Fig. 161.—Showing the plan and elevation of a tunnel blast. The dotted line shows approximate line of breaking. See Fig. 91, page 75, for method of wiring.



Table Showing the Number of Cubic Yards of Rock Displaced per Foot of Bore Hole at Different Spacings

Distance of Bore Holes Back from Face	Distance Between Bore Holes																																																																																																																																																																																																																																																																																																																																																																																																																																																																																																																																																																																																																																																																																																																																																																																																																																																																																																																																																																																																																																																																																									
	5 Ft.	6 Ft.	7 Ft.	8 Ft.	9 Ft.	10 Ft.	11 Ft.	12 Ft.	13 Ft.	14 Ft.	15 Ft.	16 Ft.	17 Ft.	18 Ft.	19 Ft.	20 Ft.																																																																																																																																																																																																																																																																																																																																																																																																																																																																																																																																																																																																																																																																																																																																																																																																																																																																																																																																																																																																																																																																										
5	.92	1.11	1.3	1.49	1.66	1.85	2.04	2.22	2.41	2.60	2.79	2.98	3.17	3.36	3.55	3.74	3.93	4.12	4.31	4.50	4.69	4.88	5.07	5.26	5.45	5.64	5.83	6.02	6.21	6.40	6.59	6.78	6.97	7.16	7.35	7.54	7.73	7.92	8.11	8.30	8.49	8.68	8.87	9.06	9.25	9.44	9.63	9.82	10.01	10.20	10.39	10.58	10.77	10.96	11.15	11.34	11.53	11.72	11.91	12.10	12.29	12.48	12.67	12.86	13.05	13.24	13.43	13.62	13.81	14.00	14.19	14.38	14.57	14.76	14.95	15.14	15.33	15.52	15.71	15.90	16.09	16.28	16.47	16.66	16.85	17.04	17.23	17.42	17.61	17.80	17.99	18.18	18.37	18.56	18.75	18.94	19.13	19.32	19.51	19.70	19.89	20.08	20.27	20.46	20.65	20.84	21.03	21.22	21.41	21.60	21.79	21.98	22.17	22.36	22.55	22.74	22.93	23.12	23.31	23.50	23.69	23.88	24.07	24.26	24.45	24.64	24.83	25.02	25.21	25.40	25.59	25.78	25.97	26.16	26.35	26.54	26.73	26.92	27.11	27.30	27.49	27.68	27.87	28.06	28.25	28.44	28.63	28.82	29.01	29.20	29.39	29.58	29.77	29.96	30.15	30.34	30.53	30.72	30.91	31.10	31.29	31.48	31.67	31.86	32.05	32.24	32.43	32.62	32.81	33.00	33.19	33.38	33.57	33.76	33.95	34.14	34.33	34.52	34.71	34.90	35.09	35.28	35.47	35.66	35.85	36.04	36.23	36.42	36.61	36.80	36.99	37.18	37.37	37.56	37.75	37.94	38.13	38.32	38.51	38.70	38.89	39.08	39.27	39.46	39.65	39.84	40.03	40.22	40.41	40.60	40.79	40.98	41.17	41.36	41.55	41.74	41.93	42.12	42.31	42.50	42.69	42.88	43.07	43.26	43.45	43.64	43.83	44.02	44.21	44.40	44.59	44.78	44.97	45.16	45.35	45.54	45.73	45.92	46.11	46.30	46.49	46.68	46.87	47.06	47.25	47.44	47.63	47.82	48.01	48.20	48.39	48.58	48.77	48.96	49.15	49.34	49.53	49.72	49.91	50.10	50.29	50.48	50.67	50.86	51.05	51.24	51.43	51.62	51.81	52.00	52.19	52.38	52.57	52.76	52.95	53.14	53.33	53.52	53.71	53.90	54.09	54.28	54.47	54.66	54.85	55.04	55.23	55.42	55.61	55.80	55.99	56.18	56.37	56.56	56.75	56.94	57.13	57.32	57.51	57.70	57.89	58.08	58.27	58.46	58.65	58.84	59.03	59.22	59.41	59.60	59.79	59.98	60.17	60.36	60.55	60.74	60.93	61.12	61.31	61.50	61.69	61.88	62.07	62.26	62.45	62.64	62.83	63.02	63.21	63.40	63.59	63.78	63.97	64.16	64.35	64.54	64.73	64.92	65.11	65.30	65.49	65.68	65.87	66.06	66.25	66.44	66.63	66.82	67.01	67.20	67.39	67.58	67.77	67.96	68.15	68.34	68.53	68.72	68.91	69.10	69.29	69.48	69.67	69.86	70.05	70.24	70.43	70.62	70.81	71.00	71.19	71.38	71.57	71.76	71.95	72.14	72.33	72.52	72.71	72.90	73.09	73.28	73.47	73.66	73.85	74.04	74.23	74.42	74.61	74.80	74.99	75.18	75.37	75.56	75.75	75.94	76.13	76.32	76.51	76.70	76.89	77.08	77.27	77.46	77.65	77.84	78.03	78.22	78.41	78.60	78.79	78.98	79.17	79.36	79.55	79.74	79.93	80.12	80.31	80.50	80.69	80.88	81.07	81.26	81.45	81.64	81.83	82.02	82.21	82.40	82.59	82.78	82.97	83.16	83.35	83.54	83.73	83.92	84.11	84.30	84.49	84.68	84.87	85.06	85.25	85.44	85.63	85.82	86.01	86.20	86.39	86.58	86.77	86.96	87.15	87.34	87.53	87.72	87.91	88.10	88.29	88.48	88.67	88.86	89.05	89.24	89.43	89.62	89.81	90.00	90.19	90.38	90.57	90.76	90.95	91.14	91.33	91.52	91.71	91.90	92.09	92.28	92.47	92.66	92.85	93.04	93.23	93.42	93.61	93.80	93.99	94.18	94.37	94.56	94.75	94.94	95.13	95.32	95.51	95.70	95.89	96.08	96.27	96.46	96.65	96.84	97.03	97.22	97.41	97.60	97.79	97.98	98.17	98.36	98.55	98.74	98.93	99.12	99.31	99.50	99.69	99.88	100.07	100.26	100.45	100.64	100.83	101.02	101.21	101.40	101.59	101.78	101.97	102.16	102.35	102.54	102.73	102.92	103.11	103.30	103.49	103.68	103.87	104.06	104.25	104.44	104.63	104.82	105.01	105.20	105.39	105.58	105.77	105.96	106.15	106.34	106.53	106.72	106.91	107.10	107.29	107.48	107.67	107.86	108.05	108.24	108.43	108.62	108.81	109.00	109.19	109.38	109.57	109.76	109.95	110.14	110.33	110.52	110.71	110.90	111.09	111.28	111.47	111.66	111.85	112.04	112.23	112.42	112.61	112.80	112.99	113.18	113.37	113.56	113.75	113.94	114.13	114.32	114.51	114.70	114.89	115.08	115.27	115.46	115.65	115.84	116.03	116.22	116.41	116.60	116.79	116.98	117.17	117.36	117.55	117.74	117.93	118.12	118.31	118.50	118.69	118.88	119.07	119.26	119.45	119.64	119.83	119.92	120.11	120.30	120.49	120.68	120.87	121.06	121.25	121.44	121.63	121.82	122.01	122.20	122.39	122.58	122.77	122.96	123.15	123.34	123.53	123.72	123.91	124.10	124.29	124.48	124.67	124.86	125.05	125.24	125.43	125.62	125.81	126.00	126.19	126.38	126.57	126.76	126.95	127.14	127.33	127.52	127.71	127.90	128.09	128.28	128.47	128.66	128.85	129.04	129.23	129.42	129.61	129.80	129.99	130.18	130.37	130.56	130.75	130.94	131.13	131.32	131.51	131.70	131.89	132.08	132.27	132.46	132.65	132.84	133.03	133.22	133.41	133.60	133.79	133.98	134.17	134.36	134.55	134.74	134.93	135.12	135.31	135.50	135.69	135.88	136.07	136.26	136.45	136.64	136.83	137.02	137.21	137.40	137.59	137.78	137.97	138.16	138.35	138.54	138.73	138.92	139.11	139.30	139.49	139.68	139.87	140.06	140.25	140.44	140.63	140.82	141.01	141.20	141.39	141.58	141.77	141.96	142.15	142.34	142.53	142.72	142.91	143.10	143.29	143.48	143.67	143.86	144.05	144.24	144.43	144.62	144.81	145.00	145.19	145.38	145.57	145.76	145.95	146.14	146.33	146.52	146.71	146.90	147.09	147.28	147.47	147.66	147.85	148.04	148.23	148.42	148.61	148.80	148.99	149.18	149.37	149.56	149.75	149.94	150.13	150.32	150.51	150.70	150.89	151.08	151.27	151.46	151.65	151.84	152.03	152.22	152.41	152.60	152.79	152.98	153.17	153.36	153.55	153.74	153.93	154.12	154.31	154.50	154.69	154.88	155.07	155.26	155.45	155.64	155.83	156.02	156.21	156.40	156.59	156.78	156.97	157.16	157.35	157.54	157.73	157.92	158.11	158.30	158.49	158.68	158.87	159.06	159.25	159.44	159.63	159.82	160.01	160.20	160.39	160.58	160.77	160.96	161.15	161.34	161.53	161.72	161.91	162.10	162.29	162.48	162.67	162.86	163.05	163.24	163.43	163.62	163.81	164.00	164.19	164.38	164.57	164.76	164.95	165.14	165.33	165.52	165.71	165.90	166.09	166.28	166.47	166.66	166.85	167.04	167.23	167.42	167.61	167.80	167.99	168.18	168.37	168.56	168.75	168.94	169.13	169.32	169.51	169.70	169.89	170.08	170.27	170.46	170.65	170.84	171.03	171.22	171.41	171.60	171.79	171.98	172.17	172.36	172.55	172.74	172.93	173.12	173.31	173.50	173.69	173.88	174.07	174.26	174.45	174.64	174.83	175.02	175.21	175.40	175.59	175.78	175.97	176.16	176.35	176.54	176.73	176.92	177.11	177.30	177.49	177.68	177.87	178.06	178.25	178.44	178.63	178.82	179.01	179.20	179.39	179.58	179.77	179.96	180.15	180.34	180.53	180.72	180.91	181.10	181.29	181.48	181.67	181.86	182.05	182.24	182.43	182.62	182.81	183.00	183.19	183.38	183.57	183.76	183.95	184.14	184.33	184.52	184.71	184.90	185.09	185.28	185.47	185.66	185.85	186.04	186.23	186.42	186.61	186.80	186.99	187.18	187.37	187.56	187.75	187.94	188.13	188.32	188.51	188.70	188.89	189.08	189.27	189.46	189.65	189.84	190.03	190.22	190.41	190.60	190.79	190.98	191.17	191.36	191.55	191.74	191.93	192.12	192.31	192.50	192.69	192.88	193.07	193.26	193.45	193.64	193.83	194.02	194.21	194.40	194.59	194.78	194.97	195.16	195.35	195.54	195.73	195.92	196.11	196.30	196.49	196.68	196.87	197.06	197.25	197.44	197.63	197.82	198.01	198.20	198.39	198.58	198.77	198.96	199.15	199.34	199.53	199.72	199.91	

Approximate Pounds of Explosives Per Foot of Hole—When Cartridges are Slit and Well Tamped

Diam. of Bore. Ins.	Straight	Du Pont FF, FFF	Du Pont R. R. P.	Blasting Powder	Duobel Durox	Extra	Red Cross Extra	Gelatin	All Monobels
1	0.42	0.41	0.36	0.34	0.28	0.42	0.40	0.47	0.32
1 1/4	0.64	0.63	0.56	0.52	0.43	0.64	0.62	0.72	0.49
1 1/2	0.95	0.93	0.82	0.76	0.62	0.95	0.91	1.05	0.71
1 3/4	1.27	1.25	1.10	1.02	0.84	1.27	1.22	1.42	0.96
2	1.65	1.62	1.43	1.32	1.08	1.65	1.58	1.84	1.24
2 1/2	2.55	2.50	2.21	2.04	1.67	2.55	2.45	2.84	1.92
3	3.75	3.67	3.25	3.00	2.45	3.75	3.60	4.17	2.82
3 1/2	5.10	5.00	4.42	4.08	3.34	5.10	4.89	5.68	3.84
4	6.60	6.47	5.72	5.28	4.32	6.60	6.33	7.35	4.97
4 1/2	8.40	8.23	7.28	6.72	5.51	8.40	8.06	9.35	6.33
5	10.50	10.29	9.10	8.40	6.88	10.50	10.08	11.69	7.91
5 1/2	12.6	12.3	10.9	10.10	8.26	12.6	12.10	14.00	9.50
5 3/8	13.2	13.2	11.3	10.44	8.84	13.0	12.53	14.94	10.16
6	15.0	14.7	13.0	12.0	9.83	15.0	14.4	16.7	11.3
6 1/2	17.5	17.2	15.2	14.0	11.50	17.5	16.8	19.5	13.2
7	20.4	20.0	17.7	16.3	13.50	20.4	19.6	22.7	15.4
8	26.7	26.2	23.1	21.4	17.50	26.7	25.6	29.7	20.1
9	33.7	33.1	29.3	27.0	22.10	33.7	32.4	37.6	25.4
10	41.7	40.9	36.1	33.4	27.30	41.7	40.0	46.4	31.4
11	50.4	49.4	43.7	40.3	33.10	50.4	48.4	56.1	38.0
12	60.0	58.8	52.0	48.0	39.30	60.0	57.6	66.8	45.2

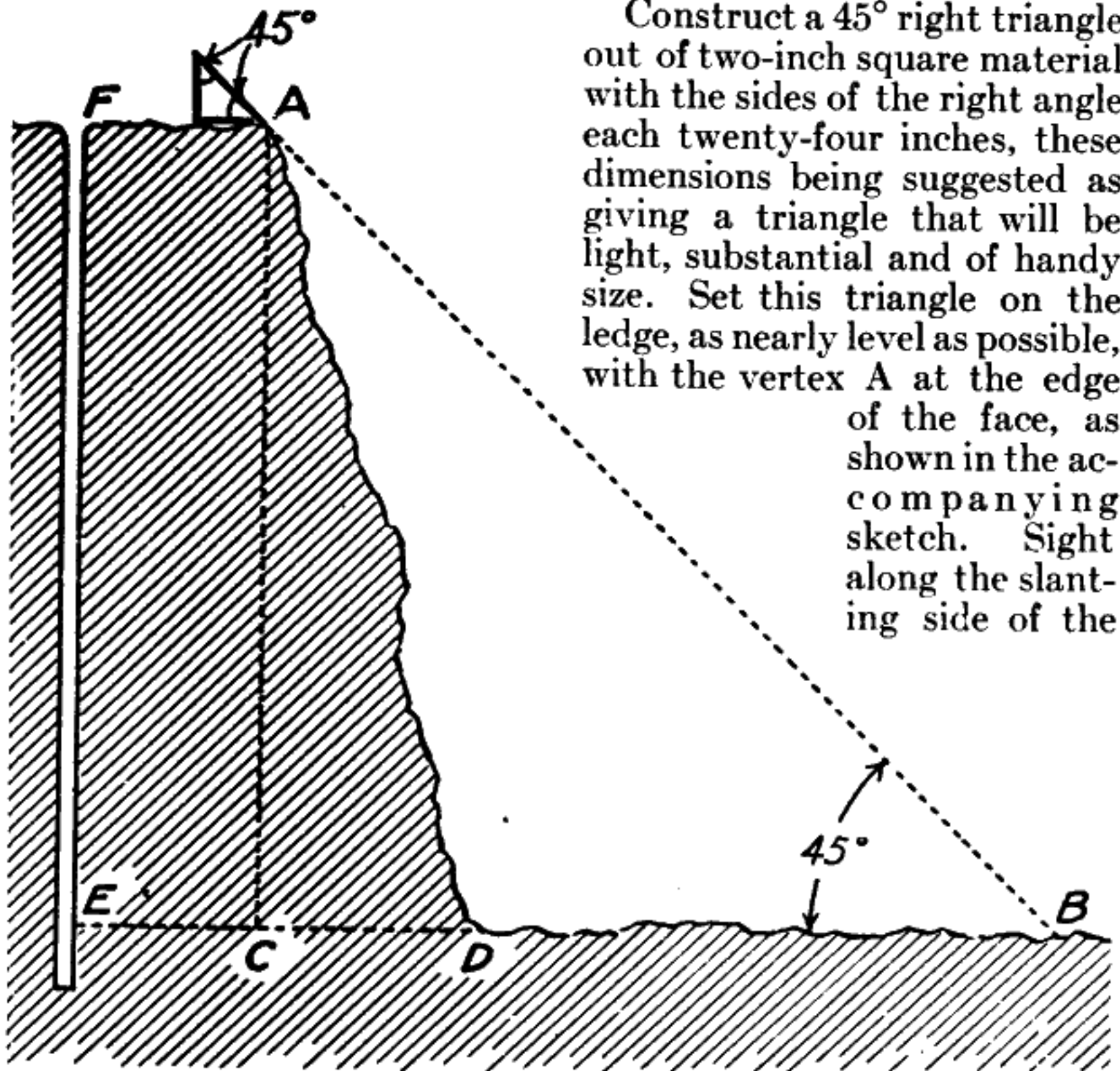
The above figures vary according to conditions. In holes drilled by piston machines this table would hardly apply as all holes drilled in that manner have a taper.

When the cartridges are smaller in diameter than the diameter of the bore holes and are not slit, the above figures would not apply even though the cartridges were well tamped.

**Quarrying—Determining height of quarry face and burden on toe of hole**

The amount of explosive per unit varies with the burden and may be anywhere from several hundred to several thousand pounds, but as a general average from 5 to 7 tons of stone are calculated per pound of explosive. The explosives used are either black blasting powder or du Pont R. R. P. in combination with 40% dynamite. A proportion largely followed is four-fifths of blasting powder or du Pont R. R. P. and one-fifth of dynamite, although many blasters use as low a proportion of dynamite as 1% of the total charge. Where finer fragmentation is desired, the du Pont R. R. P. should be used with 50 to 60% du Pont Straight Dynamite. For methods of loading see pages 73 and 74.

**Easy Method for Determining the Height of a Quarry Face and the Burden on the Toe of a Drill Hole.**—Often when the time comes to load a blast in a quarry, particularly in the case of deep well-drill holes, it is impossible to decide the proper size of the charge with any exactness because the determination of the thickness of rock between the bottom of the hole and the bottom or toe of the face is largely a matter of guess. Many quarrymen will, therefore, be glad to know that there is a quick and simple method of determining this burden to the nearest foot.



Construct a 45° right triangle out of two-inch square material with the sides of the right angle each twenty-four inches, these dimensions being suggested as giving a triangle that will be light, substantial and of handy size. Set this triangle on the ledge, as nearly level as possible, with the vertex A at the edge of the face, as shown in the accompanying sketch. Sight along the slanting side of the

Fig. 162.—Showing the triangle in place at the edge of the face in front of the well-drill hole, FE.



**Quarrying—Determining height of quarry face and burden on toe of hole**

triangle to a point on the quarry floor, B, and measure the distance AB. A helper holding one end of a tape can be sighted along the triangle and the measurement taken at the same time.

The line AB is the hypotenuse of a  $45^\circ$  right triangle, one leg of which is AC, the height of the quarry face, and the other BC. To ascertain the length of either of these legs the mathematical calculation would be to square the distance AB, divide by two, and extract the square root. The necessity of making this calculation can be avoided, however, by use of the accompanying table in which, as soon as the distance AB is known, the distances AC and BC can immediately be read off. Then, by measuring the distance from the point B in the quarry floor to the bottom of the face, D, and subtracting this from the entire distance BC, the distance the toe of the face extends beyond the top of the face, as represented by the line CD, is secured. Finally by adding to this distance CD, the distance from the top edge of the face to the bore hole, AF, the distance ED, or the burden in front of the hole at the bottom of the face, is found. From this the proper load can be determined.

Let us now take a specific problem and see how the table can be used to solve it. Suppose the hole is drilled 12 feet back of the edge of the face; a line run from the edge to the quarry floor at an angle of  $45^\circ$ , AB, measures 78 feet; and the distance from the point B to the bottom of the face is 47 feet. Consulting the table, we find that when the  $45^\circ$  line AB measures 78 feet, AC and BC, which represent respectively the height of the face and the horizontal distance from B to a point directly under the edge of the face, C, measure 55 feet each. Subtracting the distance from B to the bottom of the face, D, from 55 ( $55 - 47 = 8$ ), we find that the toe of the face extends 8 feet beyond the top. Then adding to this result the distance between the bore hole and the edge of the face ( $12 + 8 = 20$ ), we find that the burden in front of the toe of the hole is 20 feet.

This method of calculation can also be used to locate the holes to be drilled for a new blast. Suppose it is desired to locate a line of holes 15 feet apart so that each hole will have a burden of 20 feet on the toe and to drill each hole 3 feet below grade. Given a  $45^\circ$  line, AB, measuring 98 feet, and a distance from B to D at the bottom of the face of 60 feet, the table shows AC and BC both to be 69 feet. The toe then extends ( $69 - 60 = 9$ ) 9 feet beyond the top edge of the face. To make a burden of 20 feet in front of the hole, it will be necessary to measure ( $20 - 9 = 11$ ) 11 feet back from the edge of the face to find the proper place to drill. Since each hole is to extend 3 feet below grade, this one should be drilled 72 feet ( $69 + 3 = 72$ ). Repeating this simple procedure at 15-foot intervals will insure that each hole is drilled to exactly the proper depth and carries the proper burden. Especially when the top of the face is not level is this method of determining easily the exact depth and burden of each hole valuable in order that the most effective and most economical loading may be used.

## Ready Reference Table for Quarrymen

Light-face figures show AB or 45° line in feet. Dark-face figures show AC or BC leg of triangle in feet.

1	0.7	51	36	101	71	151	107	201	142	251	178
2	1.4	52	37	102	72	152	108	202	143	252	178
3	2.1	53	37	103	73	153	108	203	144	253	179
4	2.8	54	38	104	74	154	109	204	144	254	180
5	3.5	55	39	105	74	155	110	205	145	255	180
6	4	56	40	106	75	156	110	206	146	256	181
7	5	57	40	107	76	157	111	207	146	257	182
8	6	58	41	108	76	158	112	208	147	258	183
9	7	59	42	109	77	159	112	209	148	259	183
10	7	60	42	110	78	160	113	210	149	260	184
11	8	61	43	111	78	161	114	211	149	261	185
12	9	62	44	112	79	162	115	212	150	262	185
13	9	63	45	113	80	163	115	213	151	263	186
14	10	64	45	114	81	164	116	214	151	264	187
15	11	65	46	115	81	165	117	215	152	265	187
16	11	66	47	116	82	166	117	216	153	266	188
17	12	67	47	117	83	167	118	217	153	267	189
18	13	68	48	118	83	168	119	218	154	268	190
19	14	69	49	119	84	169	120	219	155	269	190
20	14	70	50	120	85	170	120	220	156	270	191
21	15	71	50	121	86	171	121	221	156	271	192
22	16	72	51	122	86	172	122	222	157	272	192
23	16	73	52	123	87	173	122	223	158	273	193
24	17	74	52	124	88	174	123	224	158	274	194
25	18	75	53	125	88	175	124	225	159	275	194
26	18	76	54	126	89	176	125	226	160	276	195
27	19	77	54	127	90	177	125	227	161	227	196
28	20	78	55	128	91	178	126	228	161	278	197
29	20	79	56	129	91	179	127	229	162	279	197
30	21	80	57	130	92	180	127	230	163	280	198
31	22	81	57	131	93	181	128	231	163	281	199
32	23	82	58	132	93	182	129	232	164	282	199
33	23	83	59	133	94	183	129	233	165	283	200
34	24	84	59	134	95	184	130	234	166	284	201
35	25	85	60	135	95	185	131	235	166	285	202
36	25	86	61	136	96	186	132	236	167	286	202
37	26	87	62	137	97	187	132	237	168	287	203
38	27	88	62	138	98	188	133	238	168	288	204
39	28	89	63	139	98	189	134	239	169	289	204
40	28	90	64	140	99	190	134	240	170	290	205
41	29	91	64	141	100	191	135	241	170	291	206
42	30	92	65	142	100	192	136	242	171	292	206
43	30	93	66	143	101	193	136	243	172	293	207
44	31	94	66	144	102	194	137	244	173	294	208
45	32	95	67	145	103	195	138	245	173	295	209
46	32	96	68	146	103	196	139	246	174	296	209
47	33	97	68	147	104	197	139	247	175	297	210
48	34	98	69	148	105	198	140	248	175	298	211
49	35	99	70	149	105	199	141	249	176	299	211
50	35	100	71	150	106	200	141	250	177	300	212

**Stripping. Open Pit Mining****STRIPPING**

Stripping consists in removing any sort of worthless or useless material from the surface to expose the more valuable material underneath, whether this is clay, shale, quarry rock, coal or ore of any kind. The material to be stripped may be earth or soil of varying degrees of hardness, frozen ground, hardpan or rock of any kind of no value to the operation being undertaken.

Where the material to be stripped is only easily dug soil of a few feet in thickness explosives are not economical, but where the digging is harder the use of Red Cross Extra 20% to loosen the material is advised in much the same manner as in subsoiling (see page 99). Where only a thin layer of hardpan interferes with digging the explosive should be loaded in the layer of hardpan. In frozen ground the holes may be sunk vertically just through the frost, but in many instances better results are obtained by flat holes, sometimes called slab shots, run in immediately against the under side of the frozen crust.

In deeper stripping a vertical face is carried in much the same manner as a quarry face. Vertical holes are sunk almost as deep as the stripping by means of soil augers, churn drills, tripod drills, or even well drills, depending upon the facilities and the character of the material. The work is much like quarry practice except that the material is usually softer, the low grades of dynamite are used and not so much explosive is required. Red Cross Extra 20 to 30%, du Pont R. R. P., du Pont F, FF, and FFF, and blasting powder are the explosives most used. Where blasting powder and du Pont R. R. P. are used the holes are sprung so as to accommodate the bulky explosive. When blasting powder is used, the R. R. granulation will be found to be the most efficient because it makes a denser load.

In many cases, snakeholing is practiced in much the same manner as in quarry work; the bulky explosives are made into rough paper cartridges or used in tamping bags so that they can be loaded into the sprung hole.

Owing to the variable conditions encountered in stripping work, no specific rules as to the amount of explosive required and the spacing of the holes can be given. Many blasters on new work use as a rough basis for the first shot the following, and then regulate the balance of the work according to the first results: for holes up to 7 feet deep, space apart and back from the face equal to the depth; for holes 8 to 20 feet deep, space apart and back 8 to 12 feet. Holes of  $1\frac{1}{4}$  inches in diameter are generally loaded half full of explosive for the first trial shot.

**OPEN PIT MINING**

This consists in simply quarrying out the valuable material whether it be clay, shale, coal, iron ore or other minerals after the waste material has been stripped off. The practices followed in ordinary quarry methods (page 129) are also eminently suited for this work.



**Open Pit Mining. Submarine Blasting—Deepening harbors and channels**

One modification of the tunnel method is sometimes used when a gopher hole just large enough for a man to work in is driven into the face and the explosive loaded into the back end of an offset from this. It is then tamped and fired electrically the same as any tunnel blast.

The explosive to select for the work depends upon the material mined and the method of quarrying. In general the same selections as noted in ordinary quarry work will be applicable. For clays and shales, Red Cross Extra 20 to 30% or Red Cross Extra 40% in combination with du Pont R. R. P. or blasting powder in sprung holes or in well drill holes gives excellent results. In iron ore, the explosive most often used is Red Cross Extra 30 to 35 % strength, while in open coal work blasting powder is the most economical.

**SUBMARINE BLASTING**

Underwater work of all sorts is more difficult than above water work. It is frequently impossible to see what is being done and much of the work is necessarily done by feeling and guess, and the exercise of practical judgment. The water also necessitates very careful attention to the details of water-proofing all electrical connections and primers. As the pressure is greater on all sides in this work than in the open air, the actual work performed by the explosive has to be greater than for similar conditions above water. Hence the loading must be heavier to secure the same effectual results.

**Deepening Harbors and Channels.**—In rock or very hard compacted sand or clay, this deepening process is very tedious and difficult. It calls for expensive machinery and outfits in the way of drill boats, dredges and barges.

In some cases, charges of explosives placed on the surface of the hard material will shatter it in somewhat the same manner as mudcapping boulders. This is not an economical method of using explosives.

Cofferdams, caissons or diving bells are sometimes employed in draining the area, and then the material is drilled and blasted in the usual manner. This is quite expensive and only feasible for comparatively small areas, but is practical in foundation work of all kinds under water.

Another method is to erect platforms supported on spuds and anchored so as to prevent movement in the water. The drilling and loading are done from the platform.

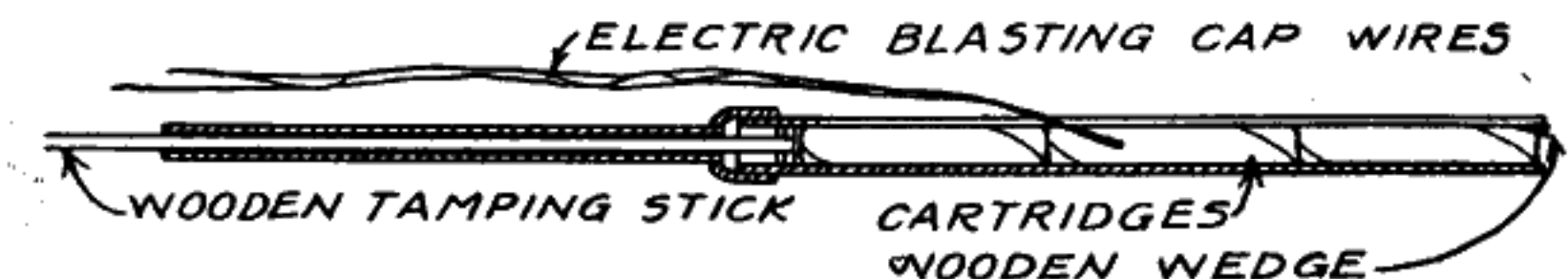


Fig. 163.—Showing section of a loading tube for loading holes under water

**Submarine Blasting—Deepening harbors and channels**

For extended work of this kind, a scow or boat upon which the drilling equipment is mounted is anchored and steadied by means of spuds resting upon the bottom. Each boat carries from one to four large piston drills, or well drills operated by steam or compressed air, mounted in standards somewhat like pile drivers along the side of the boat. The standards can be moved sideways by means of tracks and the drills raised and lowered in the standards.

The bore holes are usually from  $2\frac{1}{2}$  to  $3\frac{1}{2}$  inches in diameter, or when well drills are used 5 to 6 inches and where sand, gravel or other material lies above the rock a weighted pipe of sufficient diameter to accommodate the drill bit with a cone-shaped header above the water surface is used. This serves as a guide in starting the hole and sinks down to the rock surface, thus keeping loose débris out of the bore hole.

The work is usually carried forward in the same manner as a single bench in quarry work, the holes being spaced apart and back a distance equal to the depth of hole, except that holes are seldom spaced farther than six feet back by six feet apart, no matter what the depth. The pressure and resistance of the water preclude wider spacing, as the rock is not broken into small enough pieces for the dredges to handle easily. Holes are drilled as a rule from five to eight feet below grade to insure thorough breaking to full grade depth. As soon as the hole is drilled to the proper depth it is thoroughly cleaned out by means of a jet of water, and immediately loaded.

The loading in smaller diameter holes is done by means of a loading tube, which is a tube of brass, having a longitudinal slot on one side for the electric blasting cap wires to slide in. Of a proper diameter to slide easily to the bottom of the bore hole, this tube is usually from two to six feet long and is screwed to a smaller piece of pipe of sufficient length to extend above the water surface. The dynamite cartridges, of sufficient size to slide easily into the brass tube, are pushed up into the tube from the bottom in the same manner as in loading a bore hole, the electric blasting cap wires being carried out through the slit. The entire charge is loaded into the tube and held there by wedging the bottom cartridge with a wooden wedge. The tube is then lowered into the bottom of the hole. A long wooden rod or tamping stick is inserted through the pipe and the dynamite charge is held down while the tube is withdrawn. Where the hole is to be fired immediately, a spring clip on the top cartridge is often used to hold the dynamite in the hole, and where the hole is to be left for some time before firing, the clip is placed on the bottom of the wooden rod. In this case the electric wires are tied to the top of the rod—the rod being left to indicate the location of the hole and also to support the leading wires when several holes are fired together. In deep water and where large diameter holes are employed, the explosive charge is loaded into shells made of galvanized iron pipe or stove pipe. These shells are loaded on the deck of the boat with required amount of explosive and lowered into the bore hole.

**Submarine Blasting—Wrecked ships**

The amount of explosive to use depends upon the depth of water, hardness of the material and depth of bore holes. As a general rule, from one to four pounds of dynamite is required per cubic yard of rock, the smaller amounts being used in the more easily broken material and shallower water. Where the holes are to be fired immediately in shallow water, and the material is easily broken, Red Cross Extra 50 to 60% may be used. In deeper water, or harder material, du Pont Gelatin of 60 to 80% strength should be used, and in some cases of very hard material and difficult conditions, Blasting Gelatin will be required. Water-proof electric blasting caps not weaker than No. 6, and preferably of No. 8, size should be used. In deep water where the charges must be left for some time, submarine electric blasting caps are better. In this case, also, the dynamite in submarine packing is more desirable. In submarine blasting more satisfactory results will be obtained if primers are made from 60% du Pont Straight Dynamite. The Gelatin should be tightly packed around the primer to water-proof it and the charge should be fired within four hours after being loaded.

There should be no bare joints of the electric wiring touching the water, for it is likely to cause misfires. Care should be taken that the insulation of the electric blasting cap wires is not worn or cut through while loading the hole. A little extra taping at this point is a good practice.

**Blasting Wrecked Ships.**—Frequent necessity arises for the removal of sunken ships, barges, boats and other vessels which have become a menace to navigation. Dynamite is the quickest and most effective agent for breaking these dangerous obstructions up and ridding the channels of them.

Owing to the generally unfavorable conditions and difficulties under which the work must be prosecuted the most propitious time must be selected and the work speedily done. Such varying elements enter into a consideration of this subject that specific directions cannot be given. The height of tide, direction and velocity of wind, height of waves, character of bottom, age of wreck, kind of material in hull, and character of cargo must be considered.

A thorough investigation by divers should be undertaken to ascertain the depth of water, how the wreck lies on the bottom, whether or not it is covered with sand or mud, feasibility of getting inside the hull and a survey of the most advantageous points for the location of the charges of dynamite.

In some instances it is necessary to fire charges at different places around the hull to blast away the sand before an examination can be made. Again in many cases holes large enough to permit the entrance of the diver must be blown in the hull at different points to assist in placing the large charges of explosives in the best location. These preliminary charges may be comparatively small, usually from 25 to 200 pounds being ample, depend-



**Submarine Blasting—Wrecked ships**

ing upon the amount of work to be done at each point. It is sometimes necessary to cut or shear off some of the more important bracing beams, plates and angles. This can be done by stringing the cartridges end to end around the beam or along the plate at the point desired. The cargo, such as coal, for instance, will sometimes prevent the placing of the charges of explosives at the most logical points, and it may be necessary to blast large holes in the bow and stern or along the sides and wait until the action of the water currents has cleared some of the cargo from the hold before proceeding further with the work.

Generally the best results in breaking up wrecks have been obtained by placing large charges inside the hull. The amount to use depends upon the depth of water, character of material in the hull, whether steel or wood, whether or not it is buried in sand and mud, and the size of the vessel. For small hulls one large charge of from 300 to 1000 pounds placed amidships is usually sufficient. Slightly larger vessels will require larger charges, and large steel hulls will frequently require several charges of from 1000 to 2000 pounds each, one charge being placed forward, one amidships and one aft, the whole being fired simultaneously. Where it is impossible to put the charges inside the hull, they should be somewhat larger and spaced at closer intervals and should be placed as far under as possible and immediately against the hull.

The explosives recommended for this work are 75% du Pont Gelatin with small quantities of 60% du Pont Straight for primers packed in extra heavy water-proof submarine packing. The cases of gelatin should be stacked closely together, as more complete detonation is secured than where attempts are made to have the exploding wave propagated from one case to another placed at short intervals.

In making the charges, the case is opened, five or six cartridges of the 75% Gelatin removed, the same number of 60% Straight dynamite cartridges substituted. One of the 60% Straight cartridges should contain the water-proof electric blasting cap well taped and sealed in to prevent the entrance of water, the wires being carried through a small notch cut in the case. The case cover is then nailed on. The primed case is then lowered by means of another strong wire or rope, put in place, and a buoy attached to the top end of the rope. The electric blasting cap wires should be attached to the buoy, but all strain and pulling of buoy should be carried by the rope or heavy wire, as the small electric wires are too delicate to stand any strain. Where the tide or undercurrent is strong, No. 14 leading wires are spliced to very short electric blasting cap wires and carried from the charge at the bottom to the buoys. This makes a strong connection.

The leading wires are connected in series at the buoys to the detonator wires, all joints being well taped. Then as the firing boat drops back the wires are played out carefully until a distance of 500 to 1000 feet is reached. The blast is fired by means of a blasting machine of ample capacity.

**Submarine Blasting—Sunken logs and stumps; cutting off piling**

For deep work, and where the charges are not to be fired immediately, submarine electric blasting caps are preferable, and where the charges are to be left under water for some time, the primers should be sealed up in a water-proof tin or lead cylinder. A No. 8 detonator should always be used in submarine blasting. In this class of work it is much better practice to have two or more primers in each charge, not alone for the better detonation and execution obtained, but as a safeguard against the possibility that the wires of one electric blasting cap will become broken or short circuited, resulting in delays and sometimes the loss of the charge.

It is frequently desirable to shear off sections of steel plates, angles and braces so that as much as possible of the plates can be salvaged undamaged. This can be accomplished by stringing the dynamite cartridges end to end along the plate or around the brace with an electric detonator in every sixth or seventh cartridge if gelatin is used. In using 60% Straight Dynamite the detonators may be spaced farther apart. For very heavy work of this kind it is sometimes found advisable to use Blasting Gelatin.

**Sunken Logs and Stumps.**—In blasting out logs and stumps which have sunk in channels and rivers, thus making navigation dangerous, the general directions apply as for other underwater work. Where the charges must remain under water for some time du Pont Gelatin 40 to 60% should be used, but in shallower water and where the charges are fired shortly after being placed, Red Cross Extra 40 to 60% may be used. The charges should always be fired by electricity. The size of charges varies from five to fifty pounds, depending upon the size of the stump or log, and the depth of water. They should be placed under the center and immediately against the obstruction when possible. Frequently several charges placed at intervals are necessary in blasting out and breaking up long logs or sunken trees.

**Cutting Off Piling.**—When it is desired to remove wooden piles used for bridges, wharves and other purposes, they are most easily cut off well below waterline by using 60% Straight Dynamite detonated with electric blasting caps. The cartridges are tied together end to end, strung around the pile, lowered to the point where it is desired to cut, and there fired.

When piles are sunk in clusters or clumps, commonly called "dolphins," it is usually better practice and economy to cut each one off separately by blasting than to attempt to cut the entire "dolphin" at one blast.

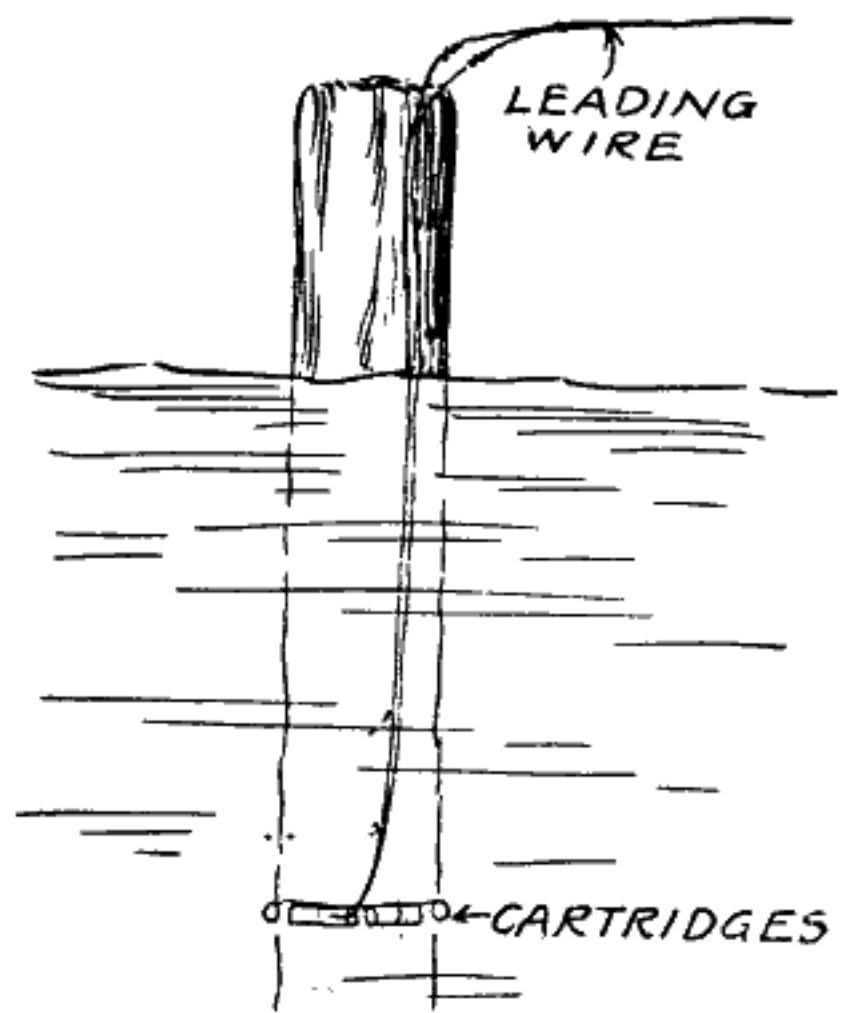


Fig. 164.—Showing method of cutting off piles by stringing the cartridges around them.

## INDEX

	Page
Action of Explosives.....	7
American Table of Distances.....	16
Blasting Accessories.....	21
Blasting Accessories for Firing Blasting Powder.....	21
Blasting Accessories for Firing High Explosives.....	23
Blasting Caps.....	24
Blasting Drilled Wells to Increase Water Supply.....	105
Blasting for Cellars and Foundations.....	102
Blasting for Tile Drains.....	100
Blasting Frozen Material in Railroad Cars.....	86
Blasting High Sides of Roads.....	81
Blasting Ice Gorges.....	88
Blasting Log Jams.....	90
Blasting Machines.....	54
Blasting Machines, Capacity of.....	55
Blasting Machines, Care of.....	56
Blasting Machines, Operation of.....	55
Blasting Mats.....	34
Blasting Old Foundations.....	87
Blasting Powder.....	7
Blasting Powder, Firing Charges of.....	21
Blasting Side Hill Cuts.....	81
Blasting Stumps.....	91
Blasting Sunken Logs and Stumps.....	144
Blasting "Through" Cuts.....	79
Blasting Trenches.....	84
Blasting Wells.....	105
Blasting Wrecked Ships.....	142
Blockholing Boulders.....	94
Bore Holes.....	59
Boulder Blasting.....	94
Boulder Blasting, Table of Charges.....	96
Cap Crimpers.....	26
Cap Sealing Compound.....	26
Cellars, Blasting for.....	102
Chambering Bore Holes.....	64
Churn Drill.....	61
Clay, Mining of.....	128
Coal Auger.....	60
Coal Mining.....	125
Connecting Detonator Wires.....	45
Connecting Detonator Wires to Leading Wires.....	45
Connecting Leading Wire to Blasting Machine.....	46
Connecting Wire.....	32
Cordeau.....	32
Cordeau, Methods of Using.....	71
Cutting Off Piles.....	144
Delay Electric Blasting Caps.....	30
Delay Electric Igniters.....	31, 120
Determining Height of Quarry Face and Burden on Toe of Drill Hole.....	136
Digging Ponds.....	118
Ditching.....	110
Ditching, Amount of Charge.....	112
Ditching, Blasting Large Ditches.....	114
Ditching, Explosives for.....	113
Ditching, Methods of Loading.....	114



	Page
Ditching, Putting Down Holes.....	112
Ditching, Quantity of Dynamite Required.....	116
Ditching, Test Shots.....	112
Ditching with a Blasting Machine.....	113
Ditching without a Blasting Machine.....	111
Drainage.....	110
Drill Bits, Care of.....	62
Electric Blasting Caps.....	27
Electric Blasting Caps with Iron Wires.....	29
Electric Squibs.....	22
Erosion, Control of.....	100
Explosives, Action of.....	7
Firing.....	76
Foundations, Blasting for.....	102
Foundations, Blasting Old.....	87
Frozen Material in Railroad Cars, Blasting of.....	86
Fuse, Safety.....	21, 24
Galvanometer.....	49
Galvanometer, Operation of.....	51
Galvanometer, Testing of.....	51
Gully Filling.....	100
Hammer Drill.....	61
Hand Drill.....	61
Handling and Storing Explosives.....	15
Handling and Storing Explosives, American Table of Distances.....	16
Handling and Storing Explosives, Magazine Construction.....	19
Handling and Storing Explosives, Magazine Locations.....	17
Handling and Storing Explosives, Magazine Operations.....	19
Handling and Storing Explosives, Old Dynamite.....	20
Handling and Storing Explosives, Transportation.....	20
Harbors and Channels, Deepening of.....	140
High Explosives.....	8
High Explosives, Characteristics of.....	12
High Explosives, Density of.....	13
High Explosives, Fumes of.....	13
High Explosives, R.R.P., F, FF and FFF.....	14
High Explosives, Permissibles.....	14
High Explosives, Strength of.....	8
High Explosives, Temperature of Freezing.....	13
High Explosives, Velocity of.....	11
High Explosives, Water Resistance of.....	11
Ice, Blasting of.....	88
Large Stumps, Blasting of.....	92
Leading Wire.....	32
Loading.....	66
Loading Small Bore Holes with Dynamite Cartridges.....	66
Loading Small Holes with Blasting Powder.....	68
Loading Sprung Holes.....	68
Loading Tunnel Holes.....	73
Loading Well Drill Holes.....	69
Loading Well Drill Holes, Using Cordeau.....	71
Locating a Break in Wiring.....	51
Log Jams, Blasting of.....	90
Low Powders.....	14
Magazine Construction.....	18
Magazine Locations.....	17
Magazine Operations.....	19
Making Bore Holes.....	59
Making Primers.....	37
Making Primers with Blasting Cap and Fuse.....	37
Making Primers with Delay Electric Igniters.....	44
Making Primers with Electric Blasting Caps.....	43

	Page
Miners' Squibs.....	21
Mining Clay.....	128
Mining Coal.....	125
Mining, Delay Electric Igniters for.....	120
Mining, Sinking Shafts in.....	124
Mining, Stoping.....	125
Mining, Tamping Holes.....	121
Mining, Tunnels and Drifts.....	122
Miscellaneous Road Building.....	82
Misfires, Handling of.....	77
Mounted Drills.....	62
Mudcapping Boulders.....	96
Multiple Shots.....	27
Old Dynamite, Destroying of.....	20
Open Pit Mining.....	139
Ore Mining, Explosives for.....	119
Parallel Circuits.....	48
Parallel Series Circuits.....	48
Permissible Explosives.....	14
Piles, Cutting Off.....	144
Planting of Trees.....	98
Pole Holes, Deep.....	83
Pole Holes in Rock.....	83
Ponds, Digging of.....	118
Post and Pole Holes.....	83
Post Holes, Shallow.....	83
Priming in Side of Cartridges.....	42
Priming in End of Cartridges.....	41
Priming with Delay Electric Igniters.....	44
Priming with Other Electric Detonators.....	44
Propagation Method of Ditching.....	110
Protecting Bare Joints in Wiring.....	46
Pumps and Spoons for Bore Holes.....	63
Quarrying.....	129
Quarrying, Benching Method of.....	129
Quarrying, Tunneling or Gopher Holing.....	133
Quarrying, Determining Height of Face and Burden on Toe of Drill Hole.....	136
Quarrying Dimension Stone.....	129
Quarrying, Snakeholing.....	130
Quarrying, Table Showing Approximate Pounds of Explosives per Foot of Hole.....	135
Quarrying, Table Showing the Number of Cubic Yards of Rock Displaced per Foot of Bore Hole at Different Spacings.....	134
Quarrying, Well-Drill Holes.....	132
Rejuvenation of Trees.....	97
Resistance of Copper Wire.....	53
Resistance Table.....	54
Rheostat.....	57
Rheostat, Resistance of.....	59
Road and Railroad Building.....	78
Rock and Ore Mining.....	119
Rotation Shots.....	27
Safety Fuse.....	21, 24
Scrapping Machinery.....	85
Series Connections.....	46
Shaft Sinking.....	124
Side Hill Cuts.....	81
Small Stumps, Blasting of.....	92
Smokestacks, Cleaning of.....	90
Snakeholing Boulders.....	95
Snakeholing in Quarrying.....	130
Soil Auger.....	60

	Page
Soil Punch.....	60
Springing Bore Holes.....	64
Stoping.....	125
Stream Correction.....	117
Stripping.....	139
Stump Blasting, General Notes.....	91
Submarine Blasting.....	140
Submarine Electric Blasting Caps.....	29
Subsoil Blasting.....	99
Sunken Logs and Stumps, Blasting of.....	144
Tamping.....	74, 121
Tamping Bags.....	33
Tamping Blocks.....	75
Tamping Stick.....	75
Tap-Rooted Stumps.....	91
Testing a Circuit.....	51
Testing Galvanometer.....	51
Thawing Dynamite.....	36
Thawing Houses.....	38
Thawing Kettle.....	36
Tile Drains, Blasting for.....	100
Transportation of Explosives.....	20
Tree Planting.....	98
Tree Rejuvenation.....	97
Trenches, Blasting of.....	84
Tripod Drills.....	61
Tunnel Driving.....	122
Tunneling, Explosives for.....	119
Tunnels for Blasts.....	62
Tunnel Method of Quarrying.....	133
Underground Silos, Blasting for.....	105
Vertical Drainage.....	118
Water Tamping.....	75
Waterproof Electric Blasting Caps.....	29
Wells, Blasting for.....	105
Well Drills.....	62
Well Drill Holes for Quarrying.....	132
Wiring Electric Blasting Circuits.....	45
Wiring Tunnel Holes.....	123
Wrecked Ships, Blasting of.....	142



## **We Want the Readers of this Book to have a Clearer Understanding of the History, Aims and Products of the du Pont Company**

Its accomplishments during a century of public service are worthy of record and make a history of interest to every American.

The reasons for its entrance into new, though closely related, fields of commercial endeavor clearly define the functions of the du Pont Company in the industrial life of the country. This is a story which brings out the important work of the Chemical Engineer, whose contributions to science have advanced civilization immeasurably since your great-grandfather's day.

\* \* \* \* \*

The first du Pont came to America from France in 1800, a political refugee. He was one of the foremost chemists of his time, a student of Lavoisier, the most famous chemist of his day. He came to the democratic Jefferson with a practical idea—a means of preserving to mankind the boldest experiment ever made by a Government, the United States of America.

President Jefferson recognized the services that this first du Pont could render to our new Republic. He received him and counseled with him and officially helped him in establishing on the banks of the Brandywine Creek the first powder mill in America. Thus Eleuthere Irénée du Pont became powder maker to the United States Government. And succeeding generations have well preserved that tradition.

It was a few years later that Perry won his famous victory on Lake Erie—one of the most inspiring deeds in the history of our Navy—and the powder that repelled the invader, the ammunition that made Perry's victory possible, was sent post-haste in a prairie schooner from that little powder mill on Brandywine Creek.

That same spirit of service helped "Old Zach" Taylor in Mexico; it helped President Lincoln to keep the Union "One and indivisible"; it helped Dewey in Manila Bay and Funston in the Philippines. It went with a small band of courageous men to the walls of Peking, and it was that same spirit of service, that tradition founded in 1802 by two great believers in Democracy; that again helped to defeat Autocracy in five years of bitter toil from August, 1914, to November, 1918.

\* \* \* \* \*

The service rendered by this Company to the cause of the Allies—and later to our own Government—is well illustrated by one small incident.

## Products of the du Pont Company

On being introduced to an officer of the Company in Washington during the past war, General Hedlam, representative of the British Government, exclaimed, "Please let me shake your hand again, sir, and permit me to say to you that the du Pont Company is entitled to the credit of saving the British Empire!"

The task which the Company faced during the World War called for increasing its capacity in the space of a few short months from 12,000,000 pounds of smokeless powder a year to 440,000,000 pounds a year.

There is an interesting fact that goes with this gigantic undertaking:

At the beginning of the war, we sold powder to the Allies at \$1.00 a pound. By November, 1915, powder was priceless, yet the du Pont Company reduced the price to 80c—and in July, 1916, reduced the price again to 60c. In April, 1917, when the United States entered the war, our price was further reduced to 47½c a pound.

Through those years, the Company supplied 40% of all explosives used by the Allied Armies and Navies and, during that period, voluntarily reduced the price by over 50%.

\* \* \* \* \*

The history of the Company as a defender of our country in times of war is inspiring and dramatic. War, thank God, comes but seldom. These instances referred to, merely tell how great emergencies were met—they are but "high-lights" in the long record of service rendered day-in and day-out during the normal years of peace—for the service of peacetime industry is, of course, the foundation on which the du Pont Company is built.

For 120 years du Pont explosives have been an important factor in the development of the nation. They have released the ores from the mines for the service of our basic industries, supplied the coal to keep the wheels of factories turning and to bring warmth to our homes, blasted the way through forest and mountain for our network of railroads, cleared and drained waste lands so that the farmer may grow larger crops.

We have met the peace demands of a busy and growing country without fail, striving always to supply more efficient explosives and safer explosives—at less cost. The peace history of the du Pont Company as well as the war history of the du Pont Company is in close parallel to the history of the United States.

\* \* \* \* \*

These are just a few incidents in the history of the du Pont Company that we want the readers of this book to know.

## Products of the du Pont Company

Far more important, however, as a point of interest and as the key for a clear understanding of the du Pont Company and its products, is *the reason for the present du Pont family of diversified products, and the reason for their outstanding quality and reasonable cost.*

*Each product which bears the du Pont oval is a product developed through chemistry—either made from the same basic materials or through applications of similar chemical control in manufacturing processes.*

Each du Pont product is the result of chemical research and applied chemical knowledge—developed to its present high standard and reasonable cost through the work of du Pont Chemical Engineers.

\* \* \* \* \*

The work of the Chemical Engineer during the past century has advanced civilization by ten centuries!

\* \* \* \* \*

He has brought to mankind comforts and conveniences that a century ago were only wishes.

He has bared the secrets of Nature and laid at the feet of the world's industries new substances, new uses for them, new ways of using the present materials of commerce in satisfying man's wants.

He has helped pack hours into minutes! Working miracles with metals he has made possible the wonders of today's time-saving transportation; . . . the mile-a-minute locomotive, the cross-country truck, the racing motor, the airplane. He has helped produce the telephone, telegraph and wireless, and thus cut the time of communicating with other people to the merest fraction of what it was a century ago. His applications of chemistry to inks, colors and papers have made possible books, magazines, newspapers, publications that reach millions in the time your great-grandfather took to reach a few scores of people.

His paints, varnishes and enamels have placed beauty beyond Time's destroying hands. His movie films flash the world before you and his phonograph records immortalize Caruso's voice for your children's children.

His visions have crowded the highways of commerce. By applying the discoveries of chemistry in a practical way he has intensified the world's production, lowered costs and driven the carriers of commerce to the far corners of the earth, seeking the raw materials industry needs, or carrying to markets its finished goods.

Into your home he has brought a wealth of comforts. Examine the room you are sitting in, its furnishings and fittings, and with that picture in your mind, try to imagine the same room in your great-grandfather's day. Quite a difference in the two rooms. In yours are comforts and conveniences your great-grandfather



## Products of the du Pont Company

never wished for, they were unthought of during his day. Yet this great change in life has come only during the past century, and it is the Chemical Engineer, who, more than any other, has wrought this difference in the surroundings of life and brought into your home a wealth of comforts.

\* \* \* \* \*

The du Pont organization, which for 120 years has been building on this foundation of applied chemistry, takes no little pride in the contributions that du Pont engineers have made in the development of the industry in the United States. . . . and in the work of du Pont Chemical Engineers lies the reason for the present du Pont family of products, widely different in appearance and use, yet closely related as to every other point of manufacture

The founder of the du Pont Company, Eleuthere Irénée du Pont de Nemours, was himself a chemist, and the making of explosives, even in his day, called for the services of a chemist. As dynamite was invented and other high explosives came into use, increasingly higher types of chemical knowledge of explosives were needed. So it was only natural that in the early years of this century, the du Pont Company aimed to have a very extensive chemical staff.

It was a staff of Chemical Engineers, men who knew manufacturing as well as chemistry, and so in the course of research looking to the improvement of du Pont explosives, they came upon other products, alike in their chemical structure, that might be manufactured from the same or similar basic materials or by machinery and process with which the du Pont Company was familiar.

You find the du Pont oval on the *explosives* which release the ores needed by industry and the fuel to keep you warm; which blast paths through mountains and forests for your roads; which clear and drain your land for larger crops; which aid you in planting your orchards, bringing you better fruit and quicker yields.

You find the du Pont oval on the labels of *paints, varnishes, enamels, lacquers*—a complete line of such products to beautify and protect your home, your car, your furniture, etc.

It identifies the exquisite articles of *Pyralin* toileware that adorn your wife's dressing table.

It is stamped upon rolls of *Fabrikoid* used for upholstering or topping your automobile, in making your luggage, in binding your books and in many other articles that you use.

The *dyes* used in making your clothing, your curtains, your blankets, very probably were shipped in containers bearing the du Pont oval.

The *fertilizers* you use to advance and increase your crops; the *disinfectants* you use to keep your home sanitary; the *medicines* which safeguard your health, most likely contain du Pont chemicals.

## Products of the du Pont Company

When you go hunting or trapshooting, the name Du Pont or Ballistite on the carton and top-shot wad of your shotgun shells tells you that you are shooting the finest *smokeless powder* made—and insures safety and accuracy.

The du Pont oval appears on this seemingly unrelated family of products because of the ability of du Pont Chemical Engineers who have been able to utilize the chemical knowledge or the basic raw materials that we need in our prime industry—the making of explosives—in making these articles that the du Pont Company feels are of value and service in other industries and to the public.

This family of products maintains the tradition established over a century ago by Eleuthere Irénée du Pont de Nemours, first powder maker to the U. S. Government—the protection of the nation.

For the manufacture of these products allows the du Pont Company to erect a machine that, in times of our country's peril, can be diverted to the production of explosives and other munitions of war. It is through the production of these normal products of peace that we can maintain not only this machine, so essential to our country's safety, but also an organization of the best chemical minds we can find—an organization always busy in working out new processes, developing new materials, developing new uses for present materials, making new forms out of useless ones, ever seeking to increase quality and reduce costs.

\* \* \* \* \*

In the future—and now we can only glimpse it—the du Pont Company hopes to contribute, as it has in the past, but in increasing measure, to the comfort, the security and the prosperity of the American home and American industry.







# EXPLOSIVES

## For Every Kind of Work

### FOR INDUSTRIAL USES

Dumorite, Red Cross Extra and Gelatin Dynamite, Du Pont Extra, Durox, Gelatin and Straight Dynamites, Repauno Gelatin, Du Pont Blasting Gelatin, Du Pont R. R. P., Permissible Explosives, Blasting Powders

### FOR AGRICULTURAL USES

Dumorite	Pacific Stumping
Red Cross Extra	Du Pont Stumping
Repauno Stumping	Du Pont Straight

Blasting Accessories  
Sporting and Military Powders  
Charcoal, Wood Pulp, Wood Oil,  
Recovered Salt

Send for descriptive booklets and price lists relating to the selection and usage of products listed.

Address our nearest branch office for full information

**E. I. du Pont de Nemours & Co., Inc.**

*Explosives Department*  
**Wilmington, Delaware**

#### Branch Offices

Birmingham.....Ala.	Huntington....W. Va.	St. Louis.....Mo.
Boston.....Mass.	Kansas City.....Mo.	Springfield.....Ill.
Buffalo.....N. Y.	New York.....N. Y.	San Francisco...Calif.
Chicago.....Ill.	Pittsburgh.....Pa.	Scranton.....Pa.
Denver.....Colo.	Portland.....Ore.	Seattle.....Wash.
Duluth.....Minn.		Spokane.....Wash.

Du Pont Products Exhibit  
Atlantic City, N. J.