

Experiments on Knife Sharpening

John D. Verhoeven
Emeritus Professor
Department of Materials Science and Engineering
Iowa State University
Ames, IA

September 2004

page 2	[1] Introduction
page 8	[2] Experiments with Tru Hone knife sharpening machine
page 12	[3] Experiments with steels
page 18	[4] Hand Sharpening with flat stones and leather strops
page 25	[5] Experiments with the Tormek machine
page 32	[6] Buffing wheel experiments
page 37	[7] Experiments with carbon steels
page 40	[8] Experiments with diamond polishing compound
page 43	[9] Summary and Conclusions
page 46	References
page 47	Appendix 1 Edge angle measurements with a laser pointer
page 48	Appendix 2 The Tormek sharpening machine
page 53	Appendix 3 The Tru Hone sharpening machine

Note: This work was supported by the Departments of Materials Science and Engineering and Mechanical Engineering at ISU by providing the author with laboratory space, machine shop service and use of the scanning electron microscope.

[1] Introduction

This report presents the results of a series of tests done on various aspects of knife sharpening. It is divided into sections devoted to each aspect. Each section terminates with a set of conclusions and a Summary of these conclusions is presented at the end of the report.

This work has concentrated on evaluating the effectiveness of various knife sharpening techniques by examining the sharpened edges of the knives in a scanning electron microscope, SEM. Much can be learned by examination of a sharpened knife edge with a magnifying glass or an optical microscope, particularly the binocular microscope. However, the optical microscope suffers from a severe limitation. Its depth of field becomes extremely small as the magnification increases. Because of the inherent curvature at the sharp edge of a knife, the optical images lose their usefulness at magnifications much above around 50x or so. The SEM overcomes this difficulty. One of its outstanding features is that the depth of field is much improved over the optical microscope, on the order of 300 times better. Hence, the SEM is capable of providing clear images of the edge of sharpened knives at magnifications up to 10,000x.

Bur Formation Figure 1 presents three SEM images from the edge region of a commercial razor strip blade made of stainless steel. The blade had a thickness of 0.027 inches (0.68 mm) and a hardness of Rockwell C = 60 (HRC = 60). In the top picture the blade is oriented in the SEM to produce an image that views the blade edge-on, i.e., the edge is oriented at right angles to your line of sight. The two lower pictures view the blade as it lies flat on each of its sides, labeled Up face and Down face. The Up and Down faces are identified on the edge view shown at the top. In all pictures the edge has been rotated to lie along the diagonal of the image in order to maximize the edge length in view. The horizontal line just below the 10 microns label provides a measure of this length on the blade. (25 microns = 0.001 inches = 1 mil.) The edge view picture was taken at a magnification of 600x and the two side views at 2000x. This set of pictures illustrates an important fact about viewing edge quality of knives in the SEM. If one were to examine only the Up face of this blade it would appear that the edge was excellent, very straight along its length with no significant bur. However, the reverse side of the blade, the Down face, reveals a very significant bur. Hence, to fully characterize edge geometry with SEM pictures one must view both faces of the blade as well as the blade edge view, which provides a measure of the cutting edge width.

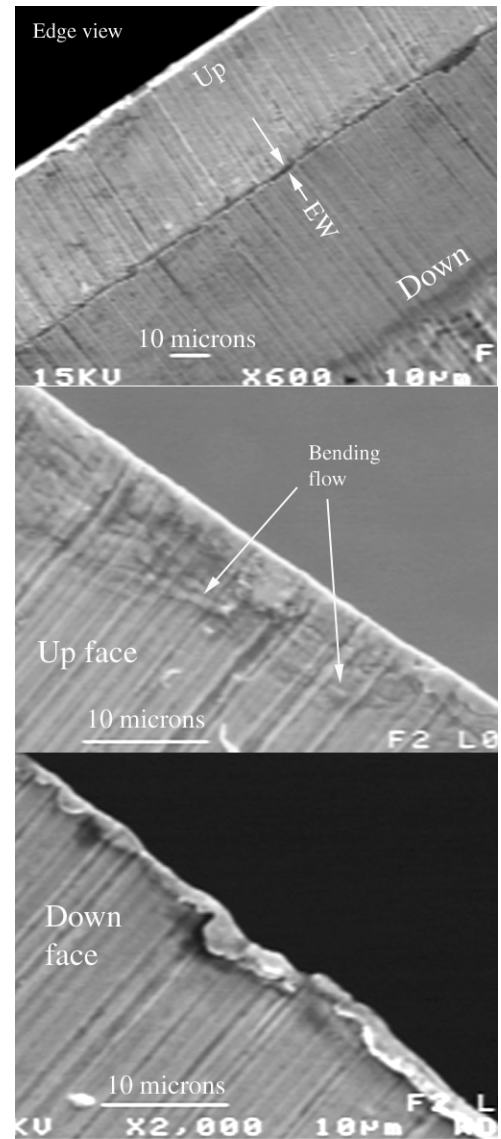
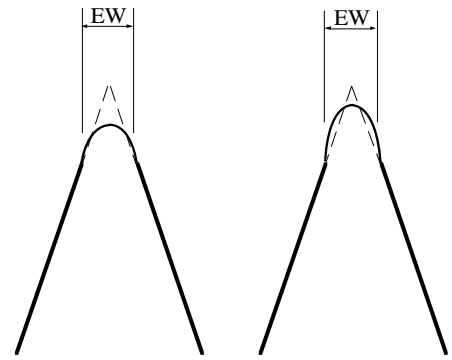
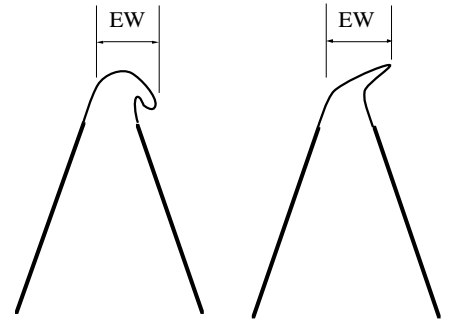

Figure 1 Three SEM views of a commercial stainless steel razor strip blade.

Figure 2 presents schematic cross sectional views of knife edges. The upper sketches in (A) have superimposed dashed lines coming to a sharp point at the edge. If one could sharpen a knife perfectly, with no burrs or rounding at the edge, it would have this shape. The edge views of the SEM provide a picture of the edge looking in the downward direction of Fig. 2, and they allow one to measure the edge width, labeled EW on Fig. 2. The edge view of Fig. 1 shows that the value of EW varies along the length of the edge of this blade and its value near the center of the picture is identified by the arrows labeled EW.



(A) Edge burs



(B) Fold-over burs

Figure 2 Some possible cross sections of knife edges after sharpening.

It seems likely to this author that two mechanisms give rise to bur formation along the edge during sharpening. (1) Debris Deposit The polishing and grinding on the metal faces of a knife blade during sharpening produces an abrasive polishing action. One may think of this action as like having thousands of little ploughs (abrasive particles) that move along the surface pushing scraped up metal, debris, in front of them. If the abrasion direction is away-from the edge, direction A of Fig. 3, then the debris will be deposited along the edge on the face opposite the face being abraded. If the abrasion direction is into the edge, direction I of Fig. 3, one would not expect debris pile-up along the edge as now it is being pushed away from the edge. However, as will be shown later, debris does collect at the edge for abrasion in the I direction, although to a reduced extent. There must be a subtle mechanism of debris deposit along the edge, perhaps involving some type of back eddies at the edge.

(2) Bending The width of the blade at the edge and just behind it is extremely thin. Hence the force against the edge from the abrasive media will result in large stresses, force per area, at the edge, which can lead to plastic flow (bending) of the edge region. (Note: The small bumps running parallel to the edge, such as the two labeled bending flow in the Up face of Fig. 1, result from a small bending flow of the edge region away from your view.)

The combination of the bent edge and the collected debris forms a bur on the side of the edge located away from the abrading media. (Some authors [1] call this deformed edge and accumulated metal debris a "wire", but the term bur will be used here.) Burs that fold around the edge can be called fold-over burs and they have a variety of shapes with two examples shown in Fig. 2(B). The edge burs of Fig. 2(A) show little bur material and appear to be edges that have simply been rounded during sharpening. However, such edges will be termed "edge burs" here to indicate a type of edge formed in sharpening that differs from a fold-over bur.

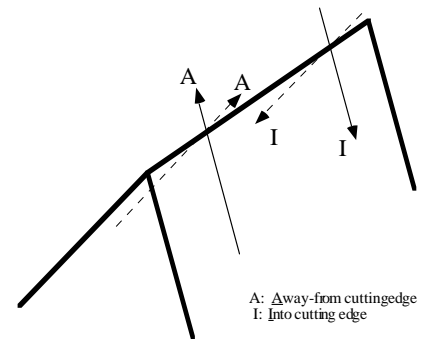

A: Away-from cutting edge
I: Into cutting edge

Figure 3 Two directions of abrasion.

Books that discuss sharpening of steel blades [1-3, see page 46] consistently recommend the detection of fold-over burs

as a guide to good sharpening technique. Formation of a uniform bur along the sharpened edge indicates that the sharpened face has been extended uniformly out to the edge. The bur formation is easily detected by the well trained eye or the use of a fingernail and serves as a good guide for determining when to flip the blade over and grind the opposite face.

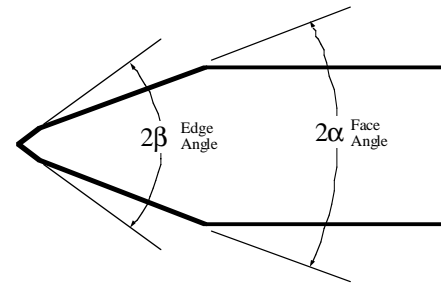

Figure 4 The 2 sharpening angles

Sharpening Angles Most knives are sharpened using 2 distinct sharpening angles, as is illustrated in Fig. 4. Here, the grind angle for the major face is called alpha, α , and the final grind angle at the knife edge is called beta, β . For grinding chisels it is common to use only one grinding angle, α . Most knives are sharpened with a symmetrical edge, which means that using a single wheel to sharpen, or a flat sharpening stone, the blade must be flipped back and forth during sharpening. Hence, the final angle formed at the knife edge is twice beta, or 2β . Unless a jig is used to fix the grind angle, good skill is required to maintain constant grinding angles. Knife sharpening experts [2] teach that maintaining a constant grind angle is one of the most important requirements for producing sharp knives and tools. In this study all hand sharpening was done using a jig which held the sharpening angle constant. In addition two types of sharpening machines were used in which the sharpening angle was automatically held constant.

In the absence of burs, the force required to push a knife through a material is dependent on the sharpening angles and the thickness of the knife blade. The force is reduced as the sharpening angles and the knife thickness are decreased. These factors would indicate that one would want to maintain the smallest possible cutting angles and blade thicknesses for ease of cutting. However, there is an opposing factor that must be considered. As the blade thickness and cutting angle decrease, the mechanical stresses (force per area) produced in the region of the blade edge during the cutting action become higher. This can lead to deformation, i.e., localized bending, at the cutting edge. Hence, a compromise is required, and the sharpening angle and blade thicknesses are smaller for cutting tools used for soft materials than for those used for harder materials or for non-delicate cutting applications like chopping. Table 1 presents some approximate angles used on blades for various applications. There does not seem to be any published hard and fast rules for what angles should be used for various applications. For example, Leonard [1] recommends that 2β for knives used for applications such as cutting rope, whittling tent pegs, etc. be at least 25° and preferably 30° . If used only for skinning and filleting a 15° value would be ample. The author has found that a 2β edge angle of $10-12^\circ$ leads to rapid edge deterioration on Rc = 60 knives in normal kitchen use. Values of 20 to 30° are more acceptable.

Table 1 Some approximate edge angles

Blade	2α	2β
Razors for shaving*	11-12°	15-19°
Knives for kitchen* and filleting knives	3-10°	20-30°
Utility knife blades*	13-20	30
Chopping knives [1]		30-60
Wood chisels [3]	$\alpha = 20-25$	$\beta = 25-30^\circ$

*Measured here on several blades.

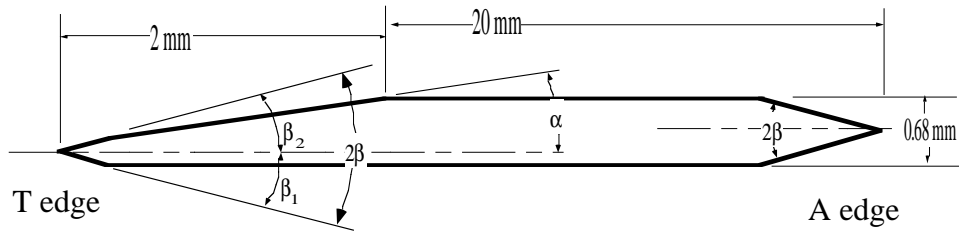

Figure 5 Cross sectional geometry of the AEB-L stainless blades.

Another factor of interest here is the effect of the final edge angle, 2β , upon sharpening characteristics. When 2β becomes very small, like in the 10 to 15° range, the force applied against the grinding wheel or honing wheel can produce sufficient stresses (force per area) upon the edge region to cause not only the edge bending discussed above, but also fracture at the edge. Bending will enhance formation of fold-over burs while fracture will produce chip-outs or cracks along the edge. This latter problem becomes more evident in blades having extremely high hardness, such as Japanese blades containing a central high carbon strip with HRC values in the 64-65 range. Steels in this hardness range have received little or no tempering after quenching and are extremely brittle. Such edges are easily chipped during sharpening.

In this work the edge angles were measured on some blades by cutting them transversely and mounting and polishing them using standard metallographic methods. The edge angles were then measured by making high magnification micrographs, scanning them into a computer and measuring the angles with standard computer graphics software. On most of the blades, however, the angles were measured with a laser beam. The beam is directed at the knife edge and from the position of the beam spots deflected from both sides of the knife edge, the angles are measured. The Cutlery & Allied Trades Research Association, CATRA, of Sheffield England, manufactures a very nice commercial device for edge angle measurement which they call a laser goniometer. In this work a simple home made device was constructed as described in Appendix 1. It provided measurements of 2α and 2β which agreed with the metallographic values within around $\pm 1/2$ degree.

Knife materials studied

The majority of the experiments were done on a commercial stainless steel razor strip used in the meat packing industry. The blades are made from Udeholm AEB-L stainless steel heat treated to a hardness of 60 HRC. Figure 5 presents a sectioned view of the blades. In the as-received condition the blades have been ground to the geometry shown on the left of Fig. 5 and labeled the T edge. Angle α is 17° and angles β_1 and β_2 are both 22° giving a 2β angle at the edge of 44°. The blades were supplied in lengths of 3.8 inches. Figure 1 was made on one of these as-received blades. In some experiments a simple symmetric edge was ground on the opposite side to the T edge, which is shown as the A edge on the right of Fig. 5.

A few experiments were done on carbon steel blades having the cross sectional geometry shown in Fig. 6. The blades had been prepared by the Benchmade knife company, where the α faces were

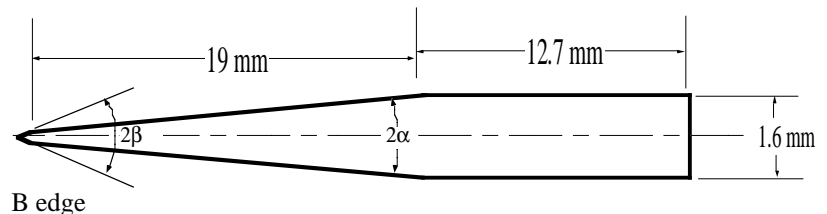

Figure 6 The carbon steel blade geometry. $2\alpha = 9.2^\circ$.

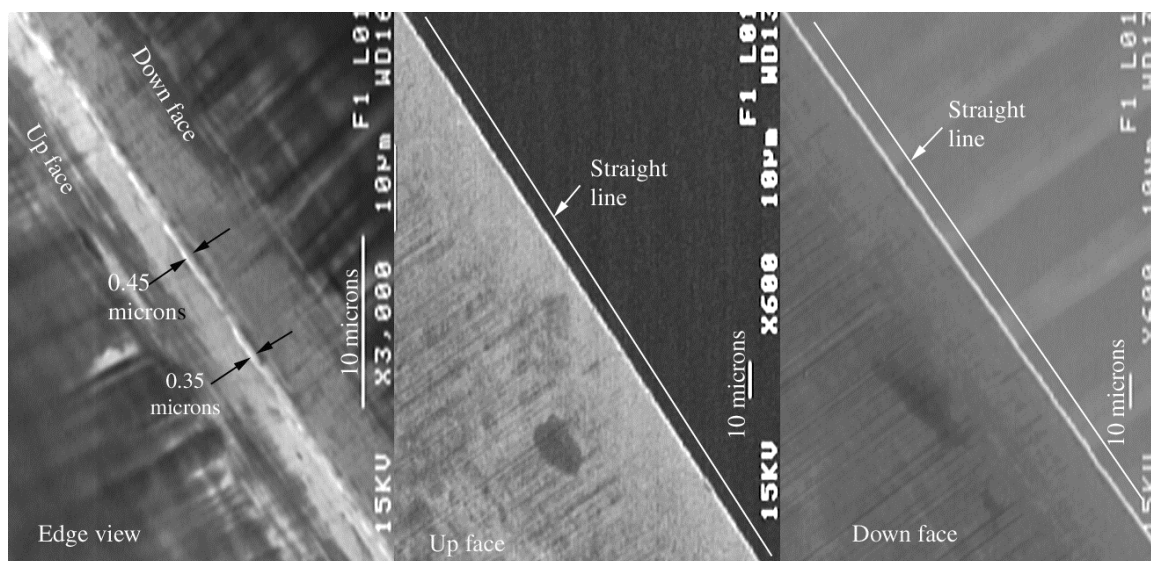

Figure 7 SEM pictures of Gillette blade.

machine ground. The final 2β edge angle was ground here as will be described. These edges will be referred to as B edges, as labeled on the left of Fig. 6. Three different carbon steels were studied as listed in Table 2. The steels had been heat treated to the hardnesses listed in Table 2 by standard quench and tempered methods prior to grinding at Benchmade.

Table 2 Carbon steels studied

Steel	Hardness
1086	$R_c = 40$
1086	$R_c = 64$
52100	$R_c = 60$
Damascus	$R_c = 40$

Sharpening Machines

In addition to sharpening on standard hand stones using a jig to maintain a constant edge angle, two different machines were used to prepare sharpened edges. The operation of these machines and the methods developed to set the grinding angles on each of them are described in appendices 2 and 3.

Razor Blade Standards

Two types of razor blades were used to establish a standard that could be used to compare blades produced in these experiments. The first blade was a Gillette double edged stainless steel blade produced in the early 1980s, when double edge blades were still used in disposable razors. Figure 7 presents SEM micrographs of this blade in the 3 orientations discussed for Fig. 1. Analysis of the edge width (EW) was done at 3 random locations along the edge at magnifications of 3000 to 10000x and values of EW varied on average between 0.35 and 0.45 microns (μm). The arrows on the edge view at the top of Fig. 7 illustrates this range. (Note: The SEM equipment places a line on the micrographs of a length corresponding to the magnification. For example, the vertical text on the Edge View shows the line to the left of x3000. Vertically above x3000 you see 10 μm , which specifies that the vertical line is 10 microns long (micron = μm). The label 10 microns to the left of x3000 was added there by the author, but in future micrographs this additional label will be omitted since it can be found vertically above the x value.) The two face views have a straight line superimposed just to the right of the sharpened edge to allow a measure of the edge straightness. The edge angle, 2β , was measured with the laser device of App. 1 to be 17° , and the 2α face angle was found to be 12° . These values agree well with those reported for Wilkinson razor blades in a 1978 paper [4]. Although that paper reports thinner EW

values, the values measured by this author on the SEM micorgraph presented there, 0.3 microns, comes out close to the values found here. (Note: To switch between the 3 views in the SEM it was necessary to remove the blade from its holder and reorient. A small dot was placed near the edge as a fiducial mark. This permitted the 3 views to be located in the same region along the edge, but not at exactly the same point. This means that the Up and Down faces of Fig. 7 lie near to, but not right at, the Up and Down faces of the Edge view. Hence, in these SEM pictures burs seen in the three different views will not necessarily be the same burs.)

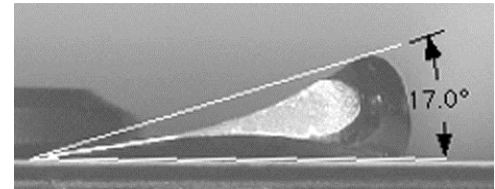

Figure 8 End view of straight razor

Mr. William Dauksch has used a straight razor for several decades. The blade is a stainless steel blade manufactured by the Solingen Co in Germany. As shown by the end view of the blade in Fig. 8, the blade has the hollow ground surface of straight razors, which ensures that stropping on the razor strop will maintain the surface at the edge on a constant abrasion angle with the strop surface. As shown in the figure the Solingen blade will automatically sharpen to give a 2β angle at the edge of 17° . After the blade was freshly stropped pictures were taken in the SEM and are presented as Fig. 9. Measurements of the edge width averaged out at 0.4 microns, which was essentially the same as found for the Gillette blade of Fig. 7. The two face views show that the straightness along the edge was excellent, being very similar to the Gillette blade. However, there is a small amount of roughness on the straight razor, which shows up more clearly on higher magnification pictures, not shown here. It is interesting that both razor blades have an edge angle, 2β , of 17° . These two razor blades will be used here as standards for comparing to the blades sharpened in this study with regard to: (1) edge width, (2) straightness along the edge, (3) roughness along the edge, and (4) smoothness of the face surface.

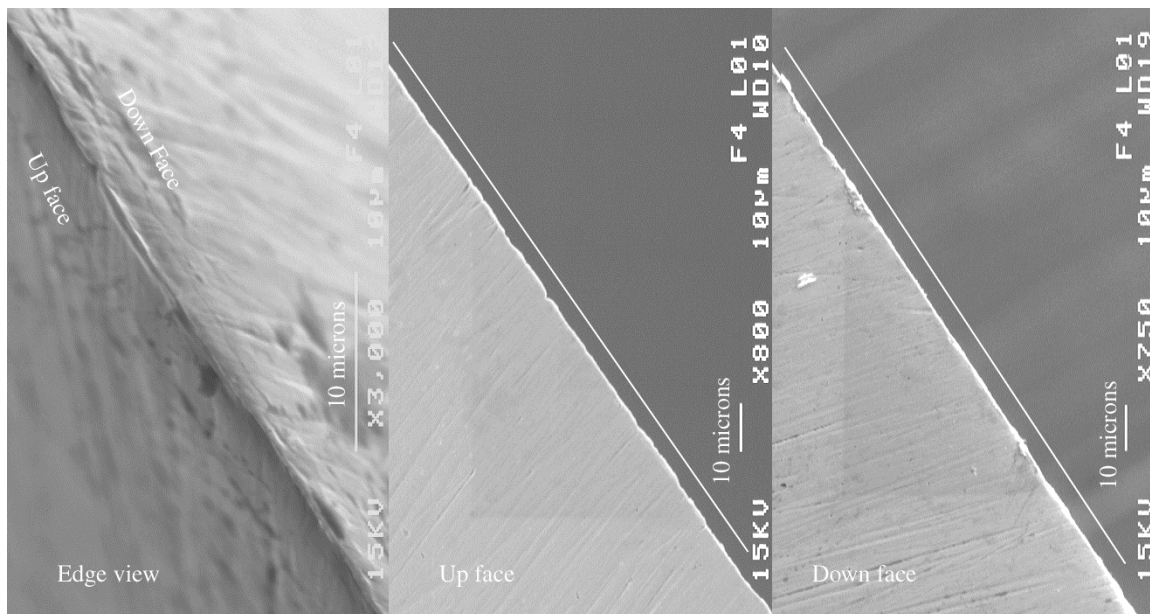

Figure 9 SEM pictures of straight razor.

[2] Experiments with the Tru Hone knife sharpening machine

Appendix 3 presents a fairly detailed description of the Tru Hone sharpening machine used in these experiments. The stainless steel blades of Fig. 5 were sharpened in groups of 4 using the special holder attachment shown in Fig. A10. The holder insured that the blades were held exactly vertically between the sets of sharpening wheels and that the downward pressure could be maintained essentially constant on all 4 blades. The speed control knob is calibrated from $S = 1$ to 10 (slowest to fastest). The general procedure used here was to pass the blades back-and-forth 5 to 10 times with only a light hand pressure using the fastest speed and then to finish with 1 to 2 b & f passes under only the pressure of the holder blade at the slowest speeds of 1 to 2 on the speed control knob. The grind angle was set to desired values using the procedure described in App. 3. Unless otherwise stated, the work was done by simply regrinding the T edge of the blades, shown on Fig. 5, to a 2β edge angle of $39-41^\circ$. Blades ground with the 100, 220, 400 and 600 grit aluminum oxide wheels were all ground dry. The special 1000 grit wheels were used wet. These wheels appear smoother than the standard aluminum oxide wheels, as if the oxide particles are held in a resin material. They were always used following a grind with the 600 grit oxide wheels. The 2β edge angle was increased a few degrees (from 38.8 to 41.3°) to ensure that only the edge region was being ground.

A set of comparison SEM micrographs of the as-ground blades is presented in Figs. 10 to 12. There does not seem to be a real significant difference in blades ground with the 220 grit wheels versus the 600 grit wheels. Both have significant burs on the ground edge and both have fairly rough edges in the face views accompanied by wide abrasive ploughing marks along the face surfaces. The 1000 grit wheels produces a significant improvement in the ground surfaces. The face views show a much reduced size in the groove marks from the abrasive action of the wheels, and the edges are now much smoother. The edge view shows that a small distinct bur occurs on the edge having an edge width which was measured on several blades and found to average 1 to 1.5 microns. It was found that the edge width was increased over these values if the 1000 grit wheels were used dry or if the final pass was not done under light pressure at the slowest wheel speeds.

It was thought that because the wheels of the Tru Hone machine rotated toward the edge during grinding that the abrasive debris would be carried away from the edge and therefore very little bur would be formed along the edge. This is clearly not the case, especially for the wheels of 600 grit and coarser. There must be some type of mechanism that deposits debris along the edge, even with the wheels rotating into the edge. Perhaps it involves debris that clings to the wheels and comes around and is deposited off the wheels as the blade edge emerges from the final wheel that it contacts.

CATRA produces a sharpening machine similar to the Tru Hone machine in that it employs the same geometry of wheels and knife orientation as shown on the left side of Fig. A11. This machine employs a special spiral locking of the grinding wheels. Comparison of blades ground on these machines with those ground on the Tru Hone

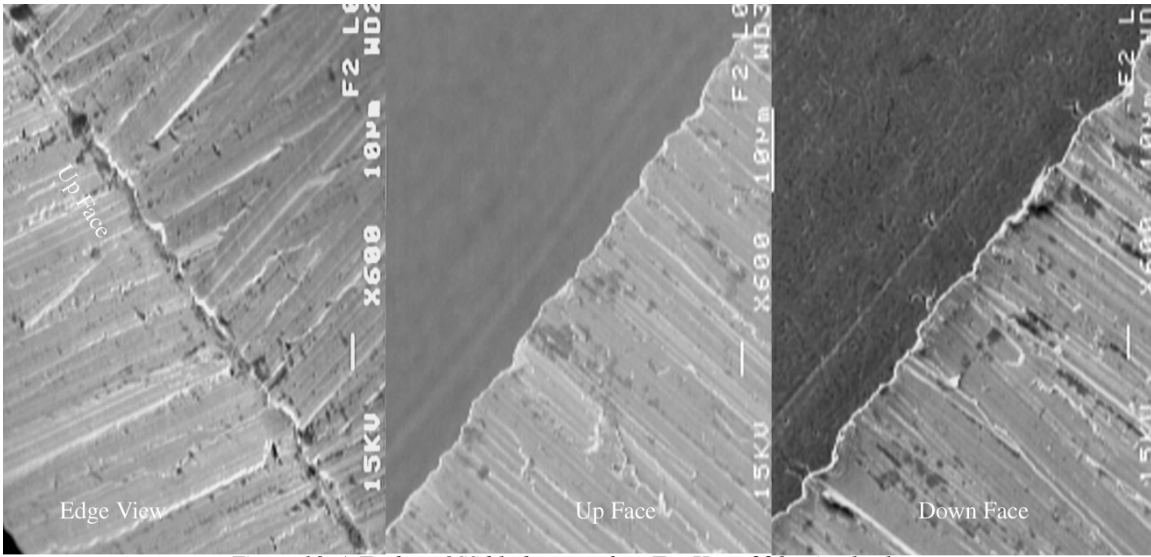

Figure 10 A T edge of SS blade ground on Tru Hone 220 grit wheels

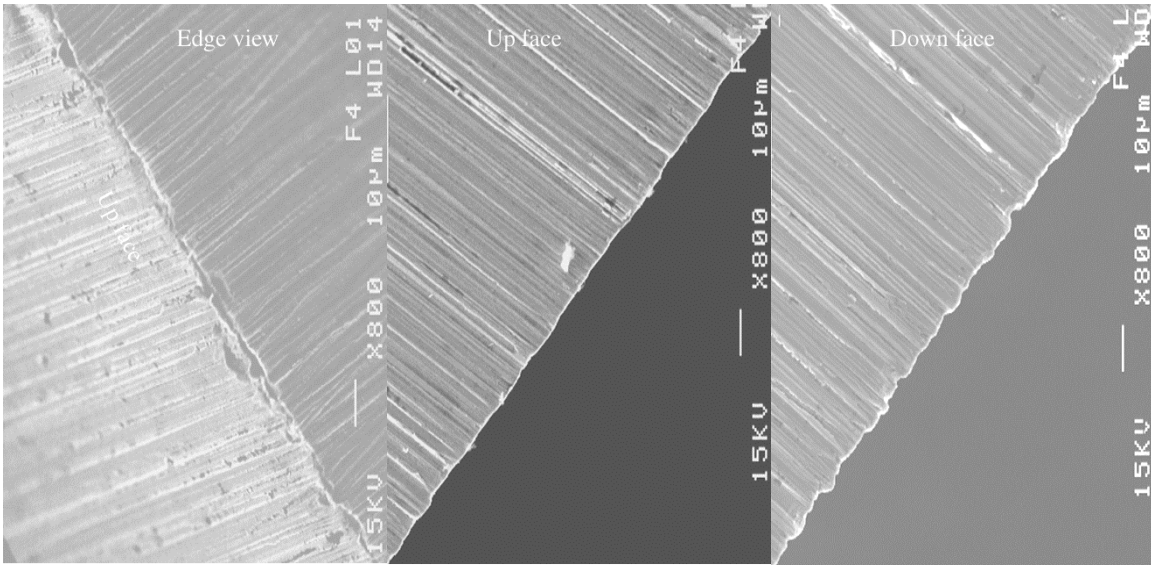

Figure 11 A T edge of SS blade ground on Tru Hone 600 grit wheels.

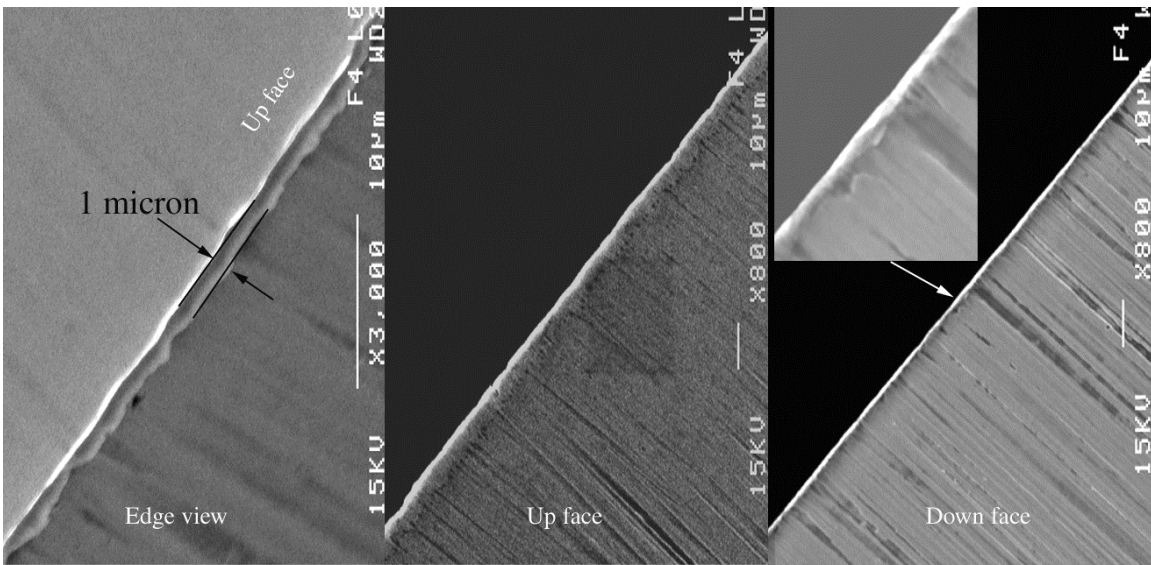

Figure 12 A T edge of SS blade ground on Tru Hone 1000 grit wheels.

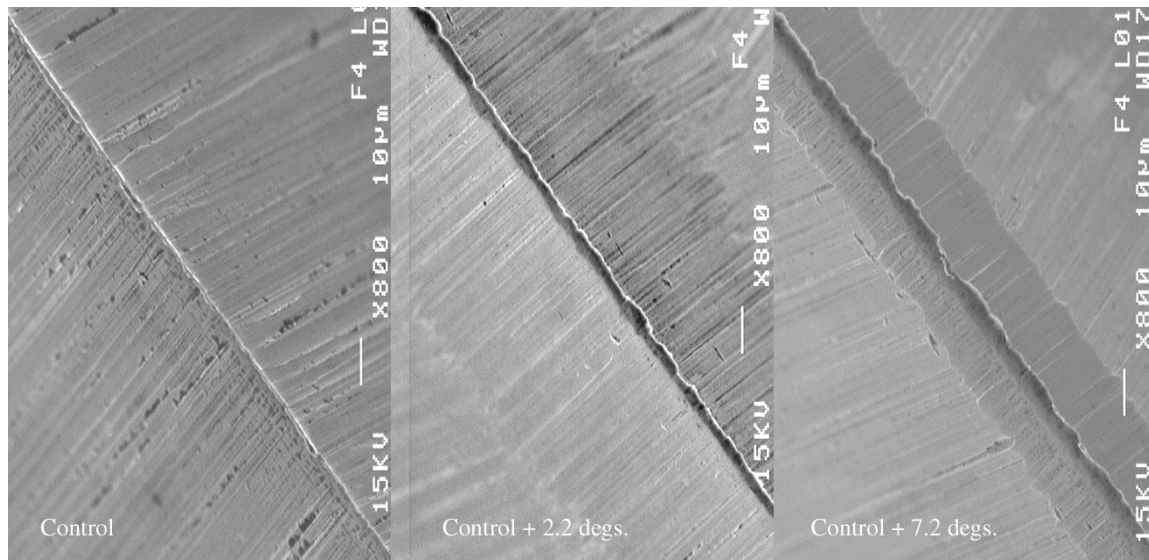

Figure 13 Effect of small increase in 2 Beta edge angle on final grind.

machine, both with a 220 grit coarseness, did not reveal any significant differences in SEM images similar to those presented in Fig. 10.

The Tru Hone directions recommend that the last step of the knife sharpening process should be accomplished by turning the knob that controls the wheel spacing through a specific sequence of colored marks on the knob. It was determined that these directions correspond to an increase of the final 2β edge angle by increments of around 3.5 degrees on each of the last 2 sets of passes. An experiment was carried out using the 1000 grit wheels to examine the effect of incrementing the 2β edge grinding angle on the final pass. A control set of blades was first ground on 600 grit wheel at a 2β edge angle of 38.8 degrees. They were then ground with the 1000 grit wheels at a 2β edge angle of 41.3 degrees with the final step consisting of 3 back-and-forth passes under holder arm pressure (a very light pressure) at the slowest wheel speed, $S = 1$. The pull rate through the wheels was estimated to be around 2 to 3 inches per second. An edge view of a control blade is shown at the left of Fig. 13. The center blade of Fig. 13 was a control blade that had been given one additional back-and-forth pass under holder arm pressure at the slowest speed with the 2β edge angle increased by 2.2 degrees. The right blade of Fig. 13 had the single additional pass done with the angle increased by 7.2 degrees.

Examination of the micrographs of Fig. 13 demonstrate a couple of interesting things. First, one can clearly see the regions along the edge that was ground by the final back and forth pass. This result shows that a single back and forth pass under the light grinding conditions removes a significant portion of the blade surface. Second, the edge bur produced by the small increase of the final 2β edge grind angle does not appear to be reduced in size. So, there does not appear to be a significant advantage of using a small increase in edge angle for the final grind.

A series of experiments was done on the Tru Hone machine with the 2β edge angle reduced to 30 and 20 degrees. As the angle decreases the overlap of the interpenetrating wheels becomes less and any slight non uniformity in wheel radius causes the knife edge to undulate up and down as it passes through the wheel sets. The vertical undulations in turn produce variation in the grind angle and the edge straightness.

Even on freshly dressed wheels a 2β edge angle of 20 degrees was too small to give reasonable edge quality. At 30 degrees the results were only nominally acceptable, but above around 35 degrees consistently good results were obtained.

Conclusions

1 The 1000 grit wheels produce a very smooth surface with a small burr along the edge. The burr width as viewed edge-on in the SEM is consistently in the 1 to 1.5 micron range. The burr formation appears to be an inherent feature of the sharpening action of the Tru Hone machine. It cannot be reduced in size by employing very small added grindings at slightly larger 2β angles. Low speeds appeared best for uniform grinding, but varying the final wheel speeds between 1 and 2 did not have a statistically observable effect on the burr width.

2 The 600 and 200 grit wheels produced surfaces that were difficult to tell apart. In both cases the face abrasion marks were significantly larger and the edge burrs significantly wider and more convoluted than found with the 1000 grit wheels. In addition, the face view of the edges were significantly rougher and less straight than on the 1000 grit wheels. Nevertheless, the edges produced by the 600 and 200 grit wheels are quite thin, with a burr width on the order of 2 to 3 μm on the 600 wheels and 2 to 4 μm on the 200 wheels. And, from a practical point of view, the edges are quite sharp, being able to cut arm hair as well as the 1000 grit edges. Neither cut hair as easily, however, as a razor blade. This later fact is probably due in large part to the much smaller edge angle of the razor blades, 2β of 17° versus 40° .

3 Optimum edge formation requires the wheels to be concentric with the rotating shaft so that there is no motion of the wheel surface along the radius upon rotation. Such motion produces edges that undulate along the edge length. The undulation effect is most pronounced when using the wheels with the smallest overlap, which is required for the smallest 2β angles. The undulations observed in these experiments were minor at 2β values of 35 to 45 degrees. However, at 2β edge angles of around 30° and less the undulations became too severe to allow satisfactory sharpening.

[3] Experiments with steels

Steels are widely used to remove burs after sharpening on stones. Juranitch [2] has a good discussion on the use of steels. His major recommendations are:

- (1) Always maintain a constant angle during the steeling stroke.
- (2) Use a very light and uniform pressure.
- (3) Use a smooth steel, as opposed to a serrated steel.

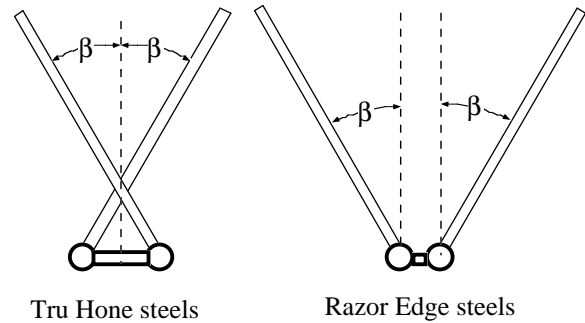

Figure 14 The two types of steels used in this study.

Experiments on steeling were done here using either of the two sets of smooth steels shown in Fig. 14. As supplied, the Tru Hone steels are spring loaded and the 2β angle between them changes as you pull the blade edge through the steels and push down on them. In this work the steels were set at a desired 2β angle using a gauge and clamped in that position to ensure a constant angle. The pair of steels in the Razor Edge set were each fixed at the desired angle and first one side of the blade was drawn along the left steel and then the other side along the right steel. In both cases blades were held as near vertical as possible as they passed along the steels. The majority of the work on steeling was done with the Tru Hone steels, and a final experiments was done with the Razor edge steels for comparison.

Experiments on blades ground on 1000 grit Tru Hone wheels

The initial experiments on steels were all done on stainless steel blades ground through 1000 grit wheels on the Tru Hone machine as described in the above section. Three sets of 4 control blades were studied and Fig. 12 is the control blade from one of these sets. Two variables were examined.

- (1) The number of passes on the steels. Three levels of passes were studied, 15 back-and-forth passes through the steels versus 5 and then 2 back-and-forth passes through the steels.
- (2) The effect of the 2β edge angle set for the steels. The control blade had $2\beta = 41.3^\circ$ and the steeled blades used 2β values increased to various values between 45 and 70° .

A total of 12 blades was examined and the effect of the variables was established. The trends observed in the SEM micrographs were fairly consistent. Consequently, the results of only some of the 12 blades are presented in the following discussion.

The effect of decreasing the number of back-and-forth passes from 15 to 2 is shown by comparing Figs. 15 and 16. Using 15 b&f passes was clearly too severe. In all of the steeled samples the action of the steeling process produced a series of linear scratches running parallel to the edge. With 15 b&f passes these scratch indentations extend back from the edge further than with 5 or 2 b&f passes. Also, with 15 b&f passes it was very common to observe breaking off of ledges of material along the edge as is shown most clearly on the Up face view at the center of Fig. 15. Study on the Edge view at the left of Fig. 15 reveals a region along the edge at the top right where one of these

edges of material has broken out of the edge. Reducing the number of b&f passes to 2 dramatically reduced both the density of such ledge break-out regions along the edge as well as the size of the ledge regions. In both of the face views presented in Fig. 16 there is no ledge breakout, and the edge straightness is very good, however, no better than in the original control blade, compare to Fig. 12. The Edge view of Fig. 16 shows a region at the lower right where breakout has occurred. In regions where no breakout occurs, such as the upper left of Fig. 16, the edge width runs around 1.5 microns, which is at the high end of that observed on the control blades prior to steeling. The blades examined after 5 b&f passes presented results intermediate to those of the 15 and 2 b&f passes, but closer to those of the 2 b&f passes. In summary, the effect of the number of passes was fairly clear, the lowest number of passes studied, 2 b&f passes, produced the best edges. However, even in this case no improvement was found over the control 1000 grit blades of Fig. 12, and some detrimental effect was found from occasional breakout, as illustrated here with the Edge view of Fig. 16.

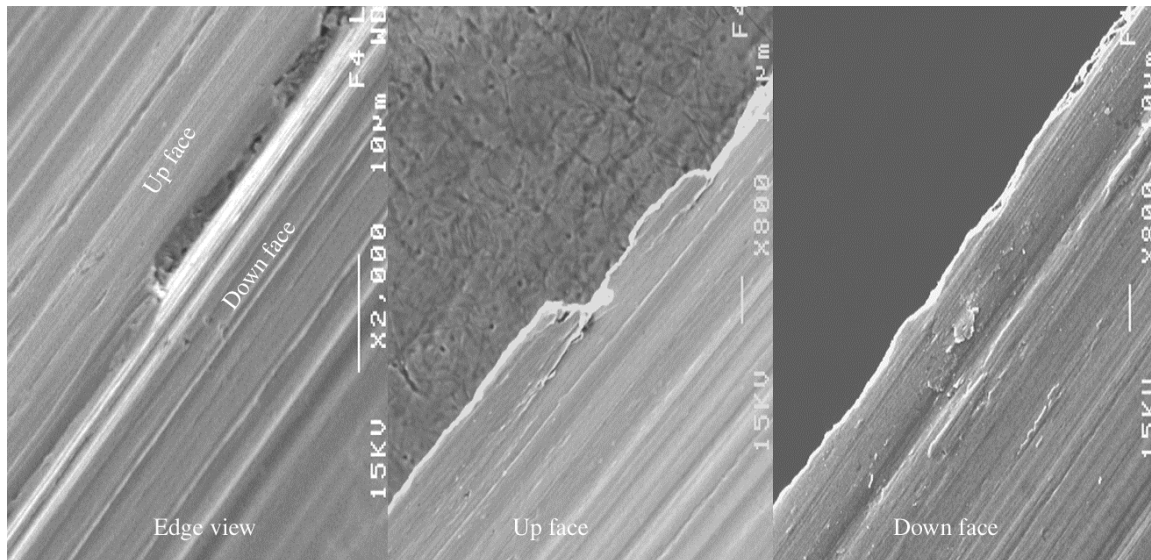

Figure 15 The steeled edge of a 1000 grit blade with 15 b&f passes on Tru Hone Steels at 2 Beta = 50°.

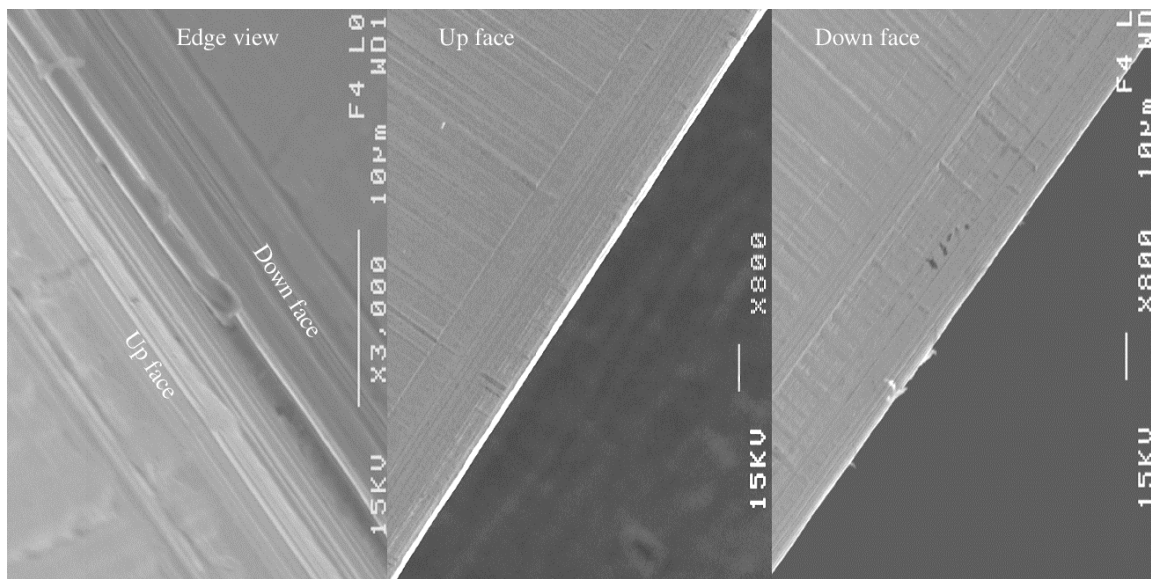

Figure 16 The steeled edge of a 1000 grit blade with 2 b&f passes on Tru Hone steels at 2 Beta = 50°.

The effects of changing the 2β edge angle are illustrated by comparing the blade of Fig. 17 which had $2\beta = 70^\circ$ to Fig. 16 where $2\beta = 50^\circ$. In both cases 2 b&f passes were used. The larger angle produced noticeably more breakout along the edge, an effect which was confirmed to increase as the angle was increased over the 3 values studied, 50, 60 and 70° .

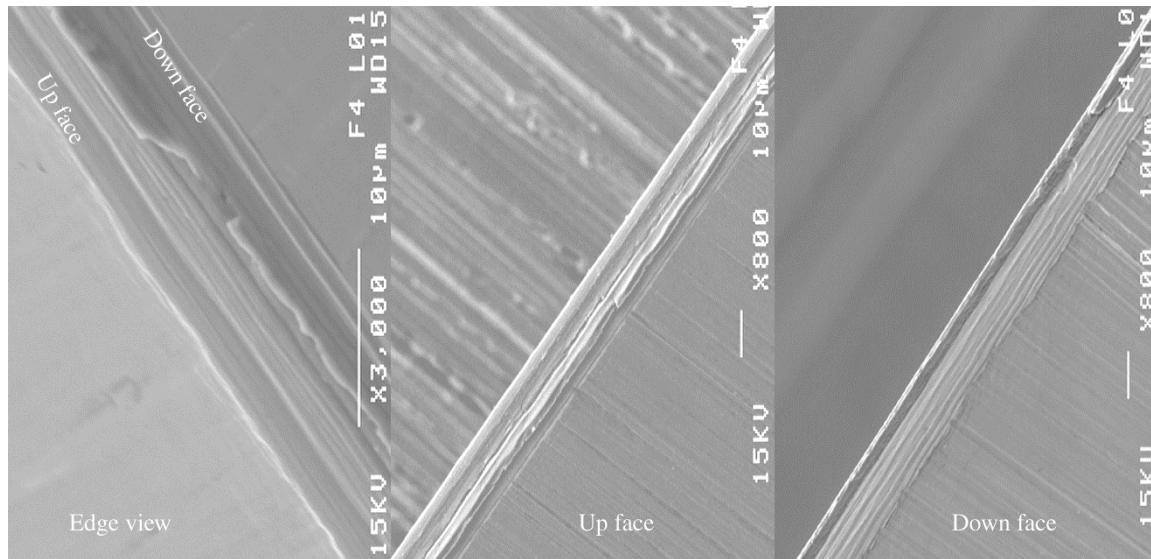

Figure 17 The steeled edge of a 1000 grit blade with 2 b&f passes on Tru Hone steels at $2\beta = 70^\circ$.

Experiments on blades ground on 600 grit Tru Hone wheels

After it was established in the above study on 1000 grit blades that very light steeling was necessary for good edge formation during steeling, subsequent studies were restricted to the use of 1 or 2 steeling strokes. A set of 7 control blades was prepared using the 600 grit aluminum oxide wheels with a 2β angle of 38.8° . Figure 11 presents the SEM micrographs for one of these control blades prior to steeling.

Steeling on the Tru Hone steels was done at 50, 60 and 70° values of the 2β edge angle and the SEM micrographs of the 50 and 70° blades are shown in Figs 18 and 19, respectively. Comparing Fig 18 to the control blade of Fig. 11 one sees a dramatic improvement in the straightness and roughness of the edge in both of the face views. The Edge view shows an edge width on the order of 1.5 to 2 μm . Increasing the 2β edge angle from 50 to 60 to 70° did not seem to have much effect on the edge straightness, edge roughness or edge width as was found on the 1000 grit wheels, compare Figs 18 and 19. It appears that the relatively large and convoluted bur produced by the 600 grit wheels is wrapped around and flattened against one side of the edge by the action of the steeling process. This is shown most clearly in Fig 19. Comparing the 2 face views one sees the wrapped-around and flattened bur remnant on the Up face view at the center of the figure. In Fig. 18 the effect is less clear but the remnant bur appears here to lie on the Down face of the blade. The main effect observed in increasing the 2β edge angle was a small increase in edge width.

Two of the 600 grit blades were honed on the Razor Edge steels shown in Fig. 14

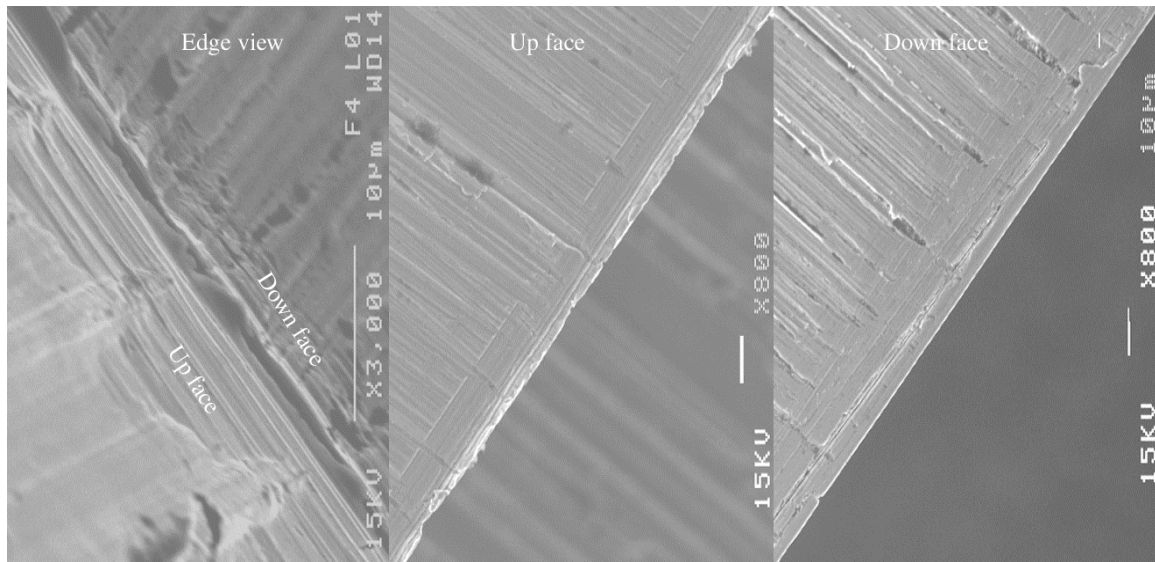

Figure 18 The steeled edge of a 600 grit blade with 2 b&f passes on Tru Hone steels at $2\beta = 50^\circ$.

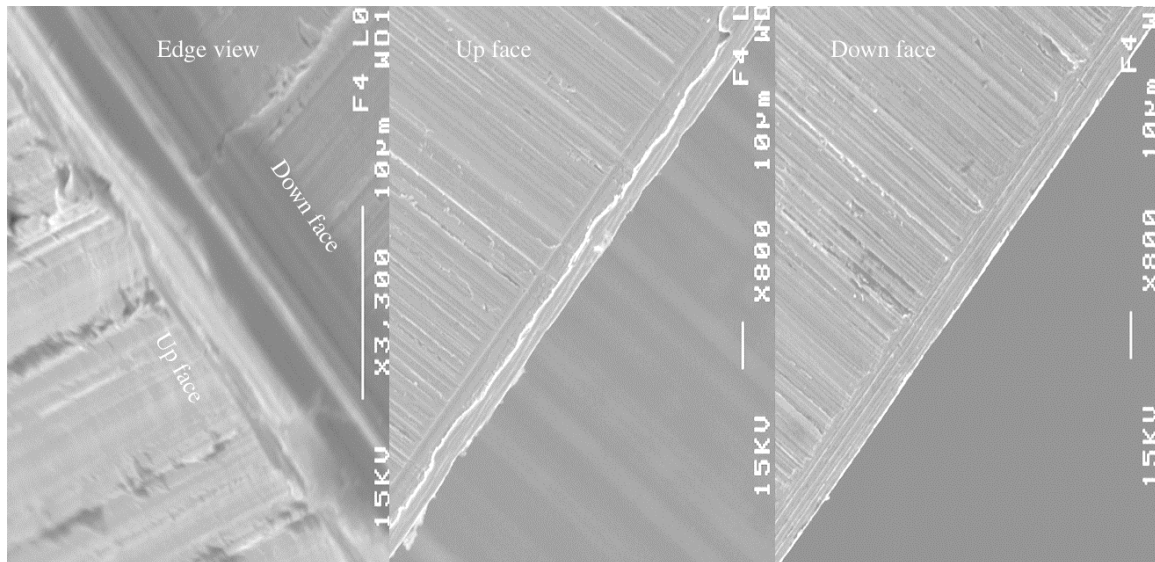

Figure 19 The steeled edge of a 600 grit blade with 2 b&f passes on Tru Hone steels at $2\beta = 70^\circ$.

at the 2β edge angles of 50° and 70° , and the results for the 50° blade are presented in Fig. 20. In this case the blades were passed over the steels with only a single stroke in one direction. The blades of Figs 18 and 19 were given 2 b&f strokes over the crossed Tru Hone steels, so that each side was subject to 4 passes on the hone surface, 2 in one direction and 2 in the other direction. It appears that this difference in the honing process does produce a different effect upon the wrapping of the bur remnant along the final edge of the honed blade. The bur remnant in Fig. 20 appears to not be as severely bent around and plastered to the side face as was found for the burs with the Tru Hone treatment. This same result was apparent in the 70° blade done on the Razor Edge hones and not shown here. Hence the experiments done here on the Razor Edge steels does not allow one to decide on the relative merits of using crossed hones versus separated steels. It is likely that both methods would produce the same result of wrapping around and compacting the bur remnant if each employed the same number of strokes. What the Razor Edge experiments verify is that the steeling action does wrap the bur around to one side of the blade. It seems likely that the side to which the bur is wrapped must be set by the first steel to contact the blade edge in the steeling process that is used. The only

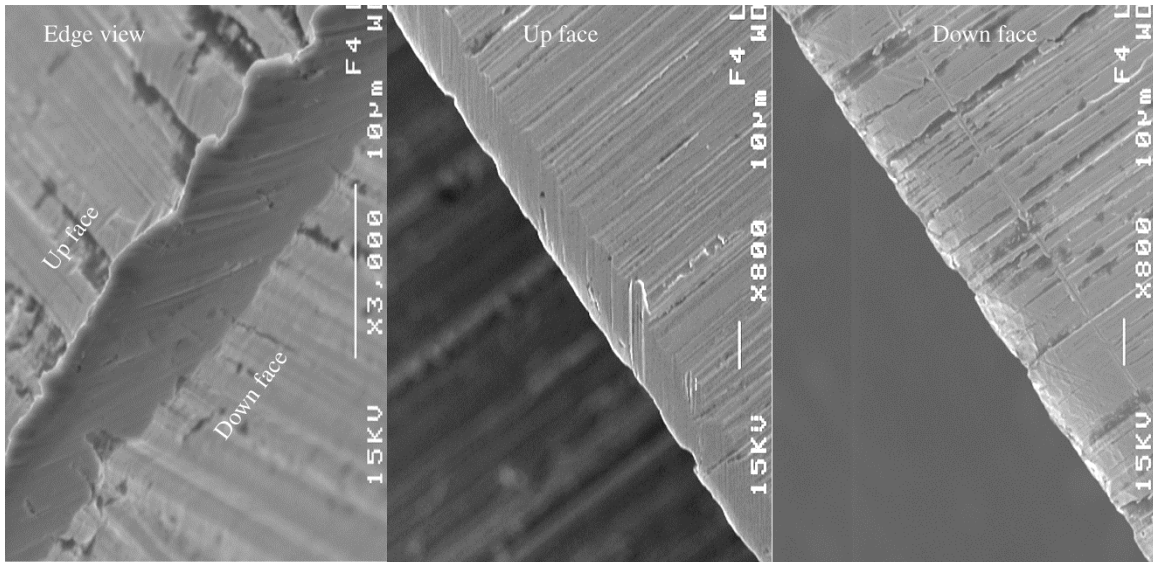

Figure 20 The steeled edge of a 600 grit blade with 1 pass on Razor Edge steels at 2 Beta = 50°.

significant difference in the two processes, aside from ease of use, is the time interval between contact with the steels on the right and left faces of the blade.

Conclusions

- 1 These experiments confirm the recommendation of Juranitch [2] that optimum edge formation in the steeling process requires the use of only a few strokes at a light pressure. Using more than 2 back and forth strokes led to a roughing of the edge by break-off of ledges along the edge of the blade.
- 2 The steeling process does not offer an improvement in edge quality with respect to edge straightness, edge roughness or edge width over that obtained with the fine 1000 grit Tru Hone wheels, and is slightly detrimental.
- 3 With 600 grit aluminum oxide wheels (and presumably with coarser such wheels) the honing does produce a dramatic improvement in edge roughness and straightness and a small improvement in edge width, from around 2-3 μm to 1.5-2 μm .
- 4 The SEM micrographs show that the action of the steeling on the 600 grit blades is one of wrapping the bur formed by the wheels around to one side of the edge and deforming it up against the face. The net effect is a slightly straighter edge with significantly reduced roughness in face views and a more uniform and slightly thinner average edge width in edge views.
- 5 With the 600 grit blades no significant effect was observed for changing the steeling 2β edge angle from 50 to 70 degrees on blades with an as-ground edge angle of 39 degrees.
- 6 The work on the 1000 grit blades that showed ledge breakout with increasing number of passes presents strong evidence that the edge of the blade is very susceptible to fracture as well as plastic deformation in the steeling process. This conclusion is quite reasonable when one realizes how thin the blade is right along its edge.

7 All of the blades that were studied here had a 2β edge angle of close to 40 degrees. In blades where the edge angle is reduced to lower values, like 20 or 30 degrees, the stresses produce by the steeling process at the edge will be higher due to the thinner edge widths below the outer edge. It is likely that to avoid edge breakout along the edge in these cases steeling would require only a couple very light strokes, with a 2β edge angle of no more than 10 degrees above the as-ground edge angle.

8 It also seems likely that the hardness of the blades might have a significant effect on the occurrence of edge breakout during steeling. Hardness values above HRC = 60 would increase the occurrence of breakout above that found here, and values below 60 would decrease occurrence.

[4] Hand Sharpening with Flat Stones and Leather Stropps

All of these experiments were carried out on the stainless steel blades of Fig. 5 with the T edge resharpened on the Tru Hone sharpening machine using either the 600 or 1000 grit wheels. This process, described in more detail above, produced a 2β edge angle of essentially 39° on the 600 wheels and 41° on the 1000 grit wheels. The blades were hand sharpened on various media to be described below with the aid of the Razor Edge sharpening holder shown in Fig. 21. The value of the 2β edge angle was controlled by adjusting the distance the blade extended into the holder. The value was measured with a protractor jig and checked on ground blades with the laser device described in App. 1. The Razor Edge holder was set to produce a 2β edge angle of 48° , giving an edge angle that was 9° larger than the as-ground edge angle of the 600 grit blades and 7° larger than the 1000 grit blades. This increase in 2β ensured that the action of the hand sharpening occurred uniformly along the cutting edge of the as-ground blades.



Figure 21 Razor Edge holder

After some experimentation the method of hand sharpening shown in Fig. 22 was adopted. An alternate 4 stroke cycle was used. On the first stroke the blade was run across the stone or leather to the right with orientation A. The holder was then flipped over and the opposite face run across to the right in orientation B. The procedure was then repeated for orientations C and D with the stroke now going right to left. This procedure alternated the abrasive action between opposite faces and on each face produced abrasion in alternating directions. In all cases for leather stropping the stroke moved the blade in a direction away from the edge, A direction of Fig. 3. For hand sharpening on stones, however, the direction of the strokes relative to the blade edge, either A or I direction of Fig. 3, were varied as will be discussed below.

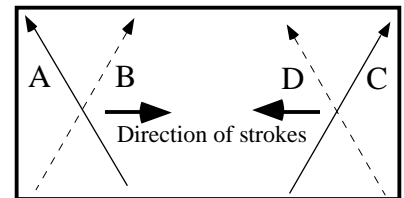

Figure 22 Blade orientation and direction of stroke during hand sharpening.

Experiments done with sharpening stones

A series of experiments was carried out in which the control stainless steel blades were hand sharpened on the following 3 different stones and the diamond hone:

- 1- Suehiro Deluxe 6000-3, a 6000 grit waterstone
- 2- Kitayama Super Polish Stone, a 8000 grit watersone.
- 3- Ultra fine hone from Razor Edge, a dry stone.
- 4- DMT SuperHone Kit, a 1200 grit diamond hone.

The first 2 stones are Japanese waterstones which were used in the wet condition and preconditioned with a Nagura stone following the recommended procedures supplied with the stones. The 3rd stone was a conventional ceramic stone used dry as recommended by the supplier, Razor Edge. The diamond hone was the type with the diamond embedded in a nickel matrix on a perforated steel plate.

Japanese waterstones plus leather stropping

Roughly 10 blades each were sharpened on 6000 and 8000 grit waterstones. Half of each of these experiments were done on blades prepared on the Tru Hone 600 grit wheels and half on 1000 grit wheels. Unless otherwise stated the procedure used involved 10 of the 4-stroke cycles described above. It was found that this number of strokes ground the edges back from the position of the original as-ground edge sufficiently that all remnants of the original burred edges were gone. Consequently, the results obtained from the waterstones were independent of the starting grind, either 600 or 1000 grit. Initial experiments utilized both 10 and 4 of the 4-stroke cycles. It was found that the 4 cycle treatment was not adequate to be certain that all remnants of the as-ground edge had been removed.

The purpose of these experiments was to characterize the nature of the edges produced with the waterstones and then to examine the effects of leather stropping upon the edge quality. It was the opinion of the author at the start of these experiments that clean leather strops would contain sufficient levels of natural abrasives adequate to produce significant improvements in the edge quality. Therefore experiments were done initially on clean leather strops. This was followed by experiments done on leather strops coated with a thin layer of honing compound. The compound used here is called Micro Fine Honing Compound supplied in the form of a wax impregnated bar having a deep green color. The abrasive contained in the wax bar is a 0.5 micron size chromium oxide. Unless otherwise stated this was the honing compound used on the subsequent experiments described here. Most of the experiments were done on a commercial leather strop, a Butz Strop, that was supplied attached to a wooden board. However, initial experiments were done with sheets of clean leather purchased from a shoe repair store and glued to a wooden board. Similar results were obtained using both the hard and soft faces of the leather as well as with the Butz strop.

Figure 23 presents SEM images of a 1000 grit control blade that had been sharpened on the 6000 grit waterstone. The sharpening process utilized 10 of the 4-stroke cycles with only a very light downward pressure and the direction of motion of the blade on the stone surface was into the edge. The two face views at 800x magnification show that the sharpening process has removed metal from a uniformly thin region along

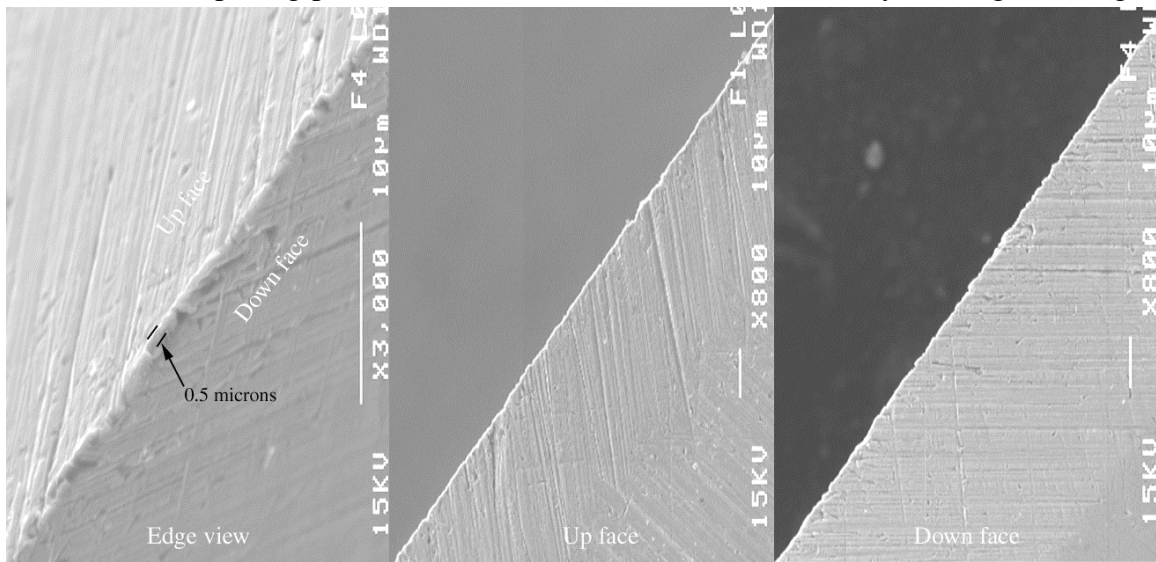

Figure 23 Edge of 1000 grit control blade after sharpening on the 6000 grit waterstone.

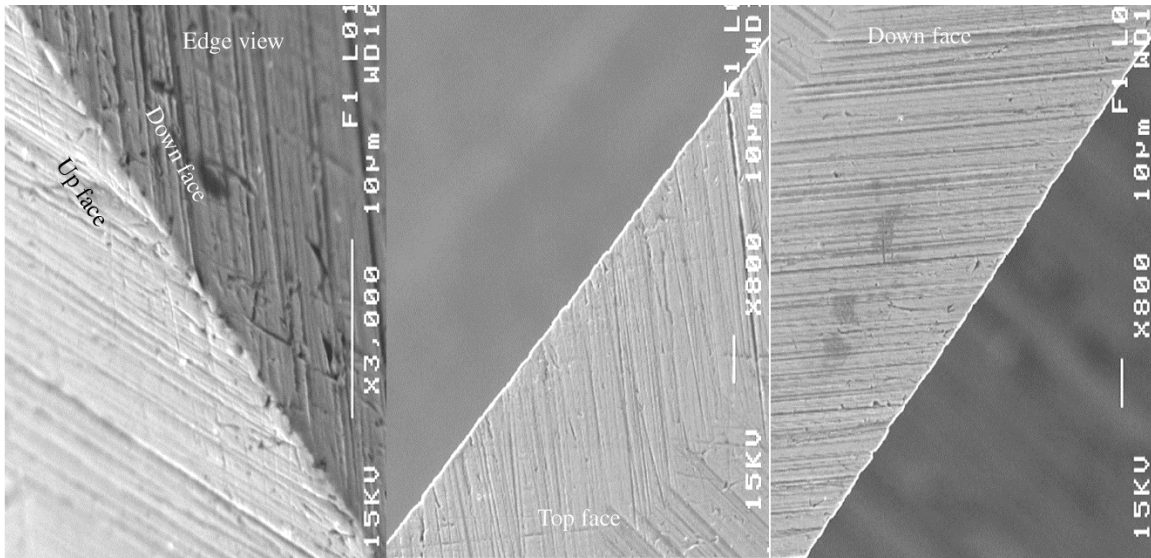

Figure 24 Blade of Fig. 23 after stropping on clean leather.

the original as-ground edge. The edge view shows that the waterstone has produced a fairly thin bur along the edge with an edge width of on the order of 0.5 microns.

Figure 24 presents micrographs of the blade of Fig. 23 after it was stopped on the Butz stop in the clean condition. The stropping procedure used the same 10 4-stroke cycles. The stropping action on the clean leather does not appear to have had much effect on the condition of the as-ground edge. The bur shown in the edge views may be just a bit smaller, but it is only a minor effect. The abrasive grooves along the faces appear to be little affected by the action of the stropping. This result is typical of what was found on additional experiments using the second clean leather stop described above. Experiments with clean leather stropping of blades prepared on 600 grit wheels showed that the clean stop was not effective in removing the larger burs formed on the 600 grit wheels.

The results of using a stop that was loaded with the chrome oxide compound versus using the clean leather is shown by comparing the blade of Figs. 25-26 to that of

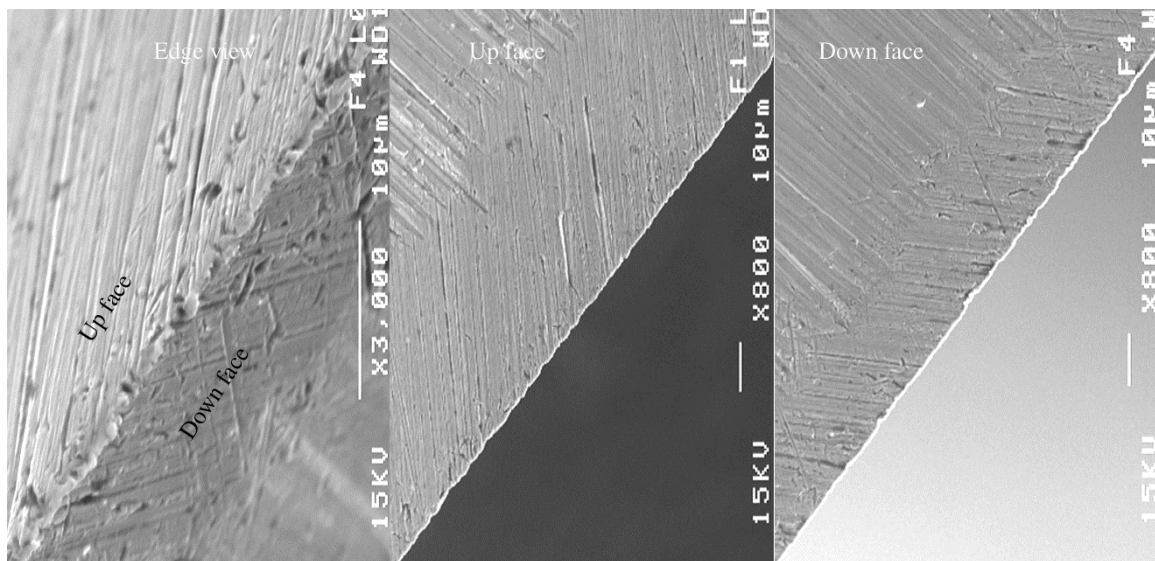

Figure 25 Edge of 600 grit control blade after sharpening on the 6000 grit waterstone.

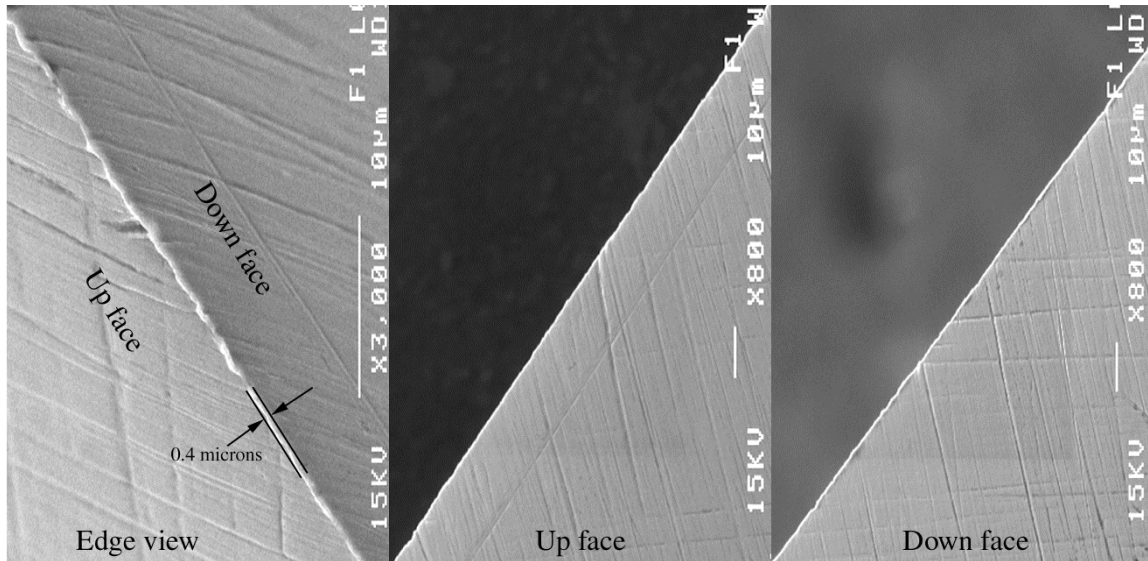

Figure 26 Blade of Fig. 25 after stropping on chromium oxide loaded leather.

Figs. 23-24. The blade of Fig. 25 was sharpened on the 6000 grit waterstone using the same technique as that of the Fig. 23 blade, the only difference being that the control blade of Fig. 25 was ground on 600 grit Tru Hone wheels compared to the 1000 grit wheels for the Fig. 23 blade. The original bur on the as-ground 600 grit blade of Fig. 25 would have been considerably larger than that of the 1000 grit blade of Fig. 23. Compare Figs. 11 and 12 to estimate the difference of the as-ground bur width and edge straightness. Comparing Figs. 23 and 25 one sees that the 6000 grit waterstone has produced edges that are quite similar for both as-ground starting conditions.

The effect of loading the leather strop with the chrome oxide compound prior to stropping is shown by comparing Figs. 24 and 26. The chrome oxide abrasive used on the blade of Fig. 26 has produced a dramatic reduction in the size of the remnant abrasive grooves on the face of the blade. As shown in the edge view of Fig. 26 the bur width is on the order of 0.4 to 0.5 microns. Comparing edge width and edge straightness to that of the razor blade standards of Figs 7 and 8, one sees that the quality of the Fig 26 edge is close to these standards. (As will be shown in the next section, however, sharpening a blade with the 2β edge angle of the razor blades, 17° , is more difficult than a blade with the 2β edge angle of 40° .)

As discussed above, it was initially thought that a clean strop would contain

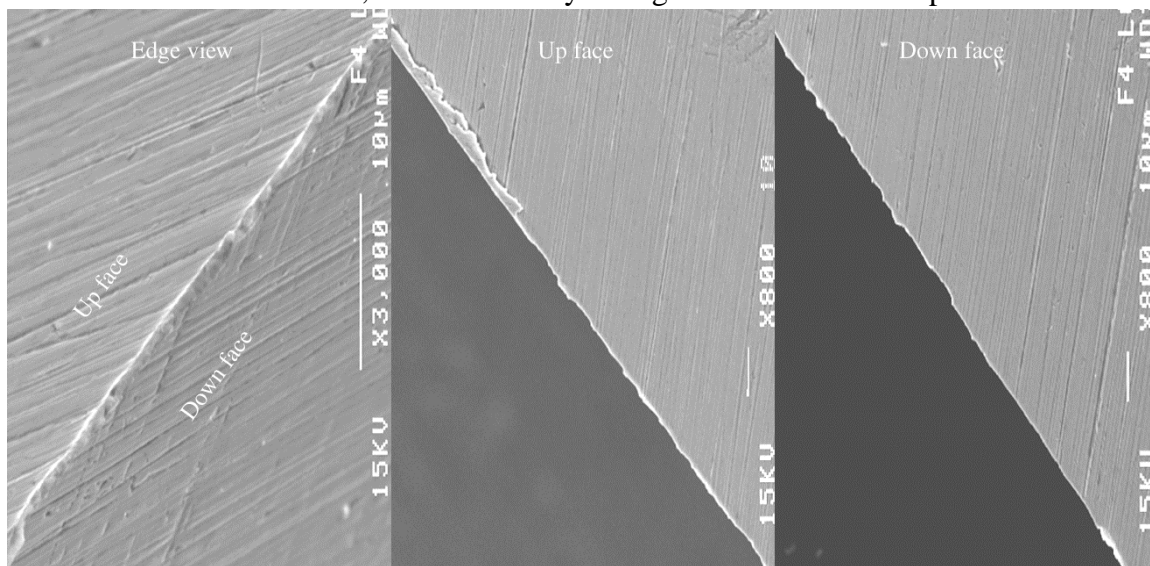

Figure 27 Effect of stroking away from blade edge on 6000 grit waterstone, compare to Figs. 23 & 25.

enough natural abrasive material to produce a marked improvement in the quality of the edge. As a result, several initial experiments were done with clean leather strops, including an experiment with alternate 3 cycles of 4 leather stropping plus a single 6000 grit sharpening. In all cases the clean leather stropping proved ineffective in comparison with the dramatic improvement found with the chrome oxide loaded strop illustrated in Fig. 26.

All of the sharpening done on the waterstones moved the blade along the stone in the direction into the blade edge causing the abrasive debris to move away from the edge. It was theorized that moving in this direction would reduce the bur size at the edge by preventing the debris from being deposited along the edge. To see if this theory was supported by evidence an experiment was done on the 6000 grit waterstone where the 10 4-stroke cycles were all done with the blade edge moving away-from rather than into the stone surface. The results are shown in Fig. 27. Comparing Figs 25 and 27 one sees that moving the blade away-from the edge, as in Fig. 27, does seem to produce a significantly larger bur than moving it into the edge, as in Fig. 25. The larger bur is also accompanied by an increase in edge roughness, as shown in the face views.

A complete series of experiments similar to the blades of Figs. 23 to 26 were done using the 8000 grit waterstone. The results were essentially the same as shown on Figs. 23 to 26 and therefore additional micrographs are not presented here. Interestingly, careful comparison of the edge quality of the blades done with the 2 stones indicated that the abrasive grooves were perhaps slightly finer on the supposedly coarser 6000 grit stone. The results indicate that an advertised finer grit in this 6000 to 8000 size range does not guarantee a finer abrasive action.

Comparison to stones 3 and 4

A control 600 grit blade was sharpened using the Ultra fine hone supplied by Razor Edge. This stone was a fine grained conventional stone, probably of aluminum oxide. The method of sharpening on the stone was identical to that used with the waterstones, Figs. 23 to 26. Figure 28 shows that the Ultrafine Razor edge stone did not produce a uniform abrasion along both sides of the edge, see the Edge view micrograph, which is only at 800x compared to 3000x on

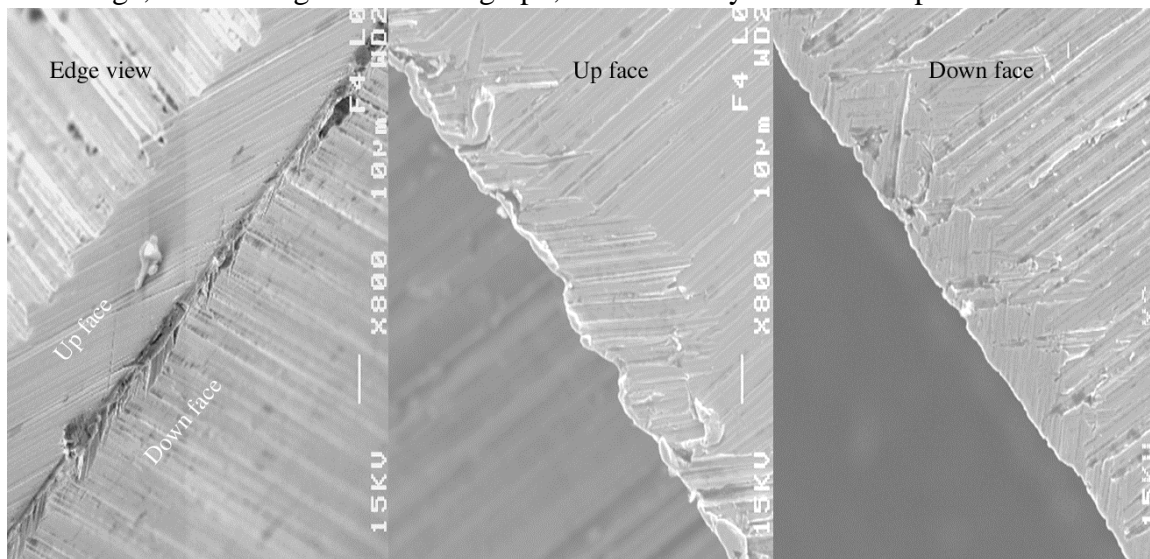

Figure 28 A 600 grit control blade sharpened on the Ultrafine Razor Edge stone.

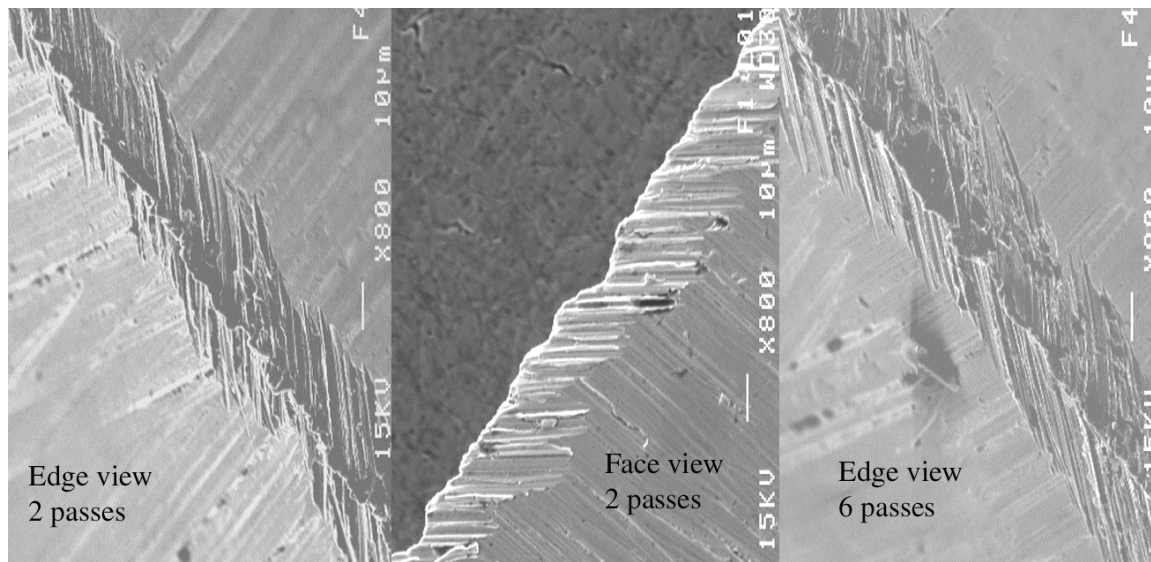

Figure 29 1000 grit control blades after sharpening on diamond hone with either 2 or 6 passes.

Figs 23 to 26. It appears that the conventional ceramic stone does not abrade the metal away as rapidly as the waterstones. The more jagged and burred edge shown in the central Up face micrograph of Fig. 28 might result in part because the lower abrasion rate has not removed adequate material to remove the more highly burred and jagged edge produced on the 600 grit control blades. Although the waterstones appear to be clearly superior to the conventional stone, additional experiments are required to confirm this conclusion. It may be that the conventional stone simply requires more extensive abrasion than the waterstones require.

The DMT diamond hone kit is supplied with a jig to hold the blade at a fixed angle while sharpening. This jig was used for the diamond hone experiment rather than the Razor Edge holder of Fig. 21. As with the Razor Edge holder experiments the holding jig was set to produce the same 2β edge angle of 48° . Two of the 1000 grit control blades were sharpened with the diamond hone using 2 passes per side and 6 passes per side with the direction of the abrasion being into the edge of the blade. Unfortunately the number of passes was significantly less than was used on the above experiments so a direct comparison is limited. Figure 29 presents 2 views of the blade sharpened with 2 passes per side and 1 view of the blade sharpened with 6 passes per side. The lower number of sharpening passes has abraded a narrower region away from the original as-ground edge than was the case for the waterstones. Nevertheless, the results show that the 1200 grit diamond hone has produced significantly larger abrasion grooves on the blade faces and has resulted in a rougher edge than found with the waterstones.

Conclusions

1 Japanese waterstones in the 6000 to 8000 grit range produced an excellent edge on these HRC = 60 stainless steel blades with as-ground 2β edge angles of around 40° . The waterstones produced fairly smooth and quite straight edges as viewed face-on. The remnant bur width was quite small, on the order of 0.5 microns. The edge quality was independent of the size of the burs left from the original grinding with either 600 grit or

1000 grit wheels. The coarser original burs of the as-ground 600 grit blades and the finer burs of the as-ground 1000 grit blades were both replaced with similar edge geometries.

2 The edge roughness and bur size produced with both a fine ceramic stone and a 1200 grit diamond hone were significantly larger than found with the waterstones. However, additional experiments with the ceramic and diamond stones would be required to make a quantitative comparison.

3 Stropping of the waterstone sharpened blades on clean leather strops had little effect upon the geometry of the as-sharpened blades. The abrasive grooves on faces and the bur size along the edge were not significantly modified. The burs on 600 grit pre-sharpened blades were not effectively removed. Apparently, the natural abrasives in clean leather, on either the hard or soft side of the leather, is not adequate to produce a significant abrasion of the surface.

4 Stropping of the waterstone sharpened blades on a leather strop loaded with chrome oxide compound produced a significant change in the edge geometry of the blades. The abrasive grooves from the waterstone sharpening were smoothed out significantly. The edge bur width was not reduced significantly below the 0.5 micron level of the waterstone ground blades, but it was perhaps a bit more uniform along the edge. However, the burs on 600 grit pre-sharpened blades were reduced significantly, to the same level as on the pre-sharpened waterstone blades. The overall geometry of the stropped edges compared favorably to the razor blade standards.

5 In the discussion of the mechanism of bur formation on page 3 it was speculated that grinding a blade with the edge of the blade moving into the stone, called the I direction, would produce less burring than the case with the edge moving away from the stone, the A direction. The hand grinding experiments on waterstones agree with this speculation, see the discussion of Fig. 27.

[5] Experiments with the Tormek machine

The Tormek sharpening machine is described in Appendix 2. The machine rotates 2 wheels at a slow speed, 90 RPM, a 10 inch diameter ceramic wheel and a 8.75 inch leather honing wheel. The machine is supplied with a 220 grit aluminum oxide wheel and a 4000 grit Japanese waterstone wheel is also available. These experiments can be divided into three studies. (1) In the first study comparisons were made between blades sharpened on the aluminum oxide wheel and the waterstone wheel at a 2β edge angle of 40° . (2) The experiments of the previous sections demonstrated the advantages of using chrome oxide polishing compound with leather strops. Hence the leather polishing wheel of the Tormek machine was only used after charging with the chrome oxide compound. The procedure for charging was to coat the leather with mineral oil, apply the wax stick to the rotating wheel to produce a non-uniform heavy layer on the leather and then smooth this layer to a thin thickness with a knife edge on the rotating wheel. Experiments of this second study compared the effect of the leather honing wheel on blades sharpened with the fine waterstone wheel and the coarser aluminum oxide wheel. (3) It was not possible to reduce the 2β edge angle much below 40° with the Tru Hone machine. All of the previous experiments prepared control blades with the Tru Hone machine and were therefore restricted to 40° edge angles. However, smaller 2β angles were easily produced with the Tormek machine. In this 3rd study the stainless steel blades were reground to 2β angles of both 20 and 40° and comparison was made on blades of these two edge angles.

Comparison of as-ground surfaces

The initial studies were all done on blades ground to a 2β edge angle of 40° . All of the work up to this point had been done on the reground T edge of the stainless blades. As shown in Fig. 5, this edge is not centered on the blade centerline. It was not expected that this offset would have any effect on the sharpening characteristics. However, to confirm this expectation a study was done here on several blades which were ground on the opposite un-ground side to give the symmetric geometry shown in Fig. 5 as the A edge. The A edges were ground to a 2β edge angle of 40° using the 100 grit wheels of the Tru Hone machine to ensure that the edge was centered and they were then reground at the same angle with the 220 grit and waterstone wheels of the Tormek machine. Comparison was then made of the edge quality of blades sharpened on both the A and T edges, and as expected no significant difference in edge quality was found between the two. Therefore all of the experimental data presented here for $2\beta = 40^\circ$ blades are for blades sharpened on the T edge.

Figures 30 and 31 compare the edge quality of blades sharpened on the Tormek machine with 220 grit wheel and the waterstone wheel, respectively. The blades were passed back-and-forth several times using very light pressure on the holder jig that was used to ensure a constant grinding angle. The wheel direction was rotating into the blade edge in all of the experiments. Both wheels produced a prominent bur and Figs 30 and 31 show typical results for the two different wheels. The bur produced by the 220 grit wheel, Fig. 30, appears to consist of a thin strip of metal adhering to the edge and folding over predominantly, but not exclusively, to one side of the blade. The bur produced by the waterstone, Fig. 31, was more clearly a folded over bur to one side of the blade. In

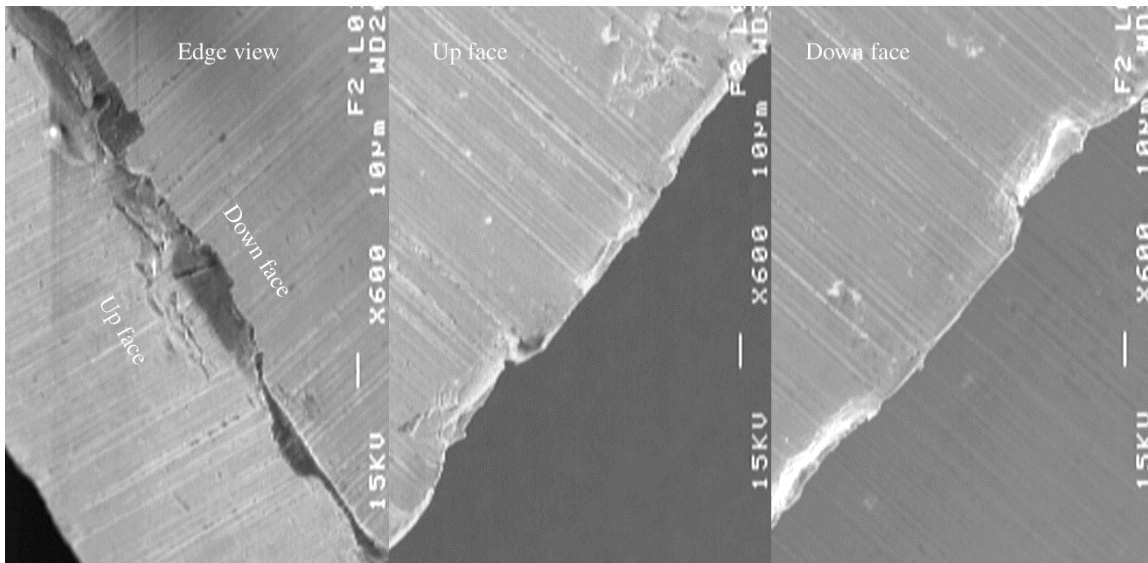

Figure 30 T edge of SS blade ground to $2\beta = 40^\circ$ with Tormek SG-220 wheel

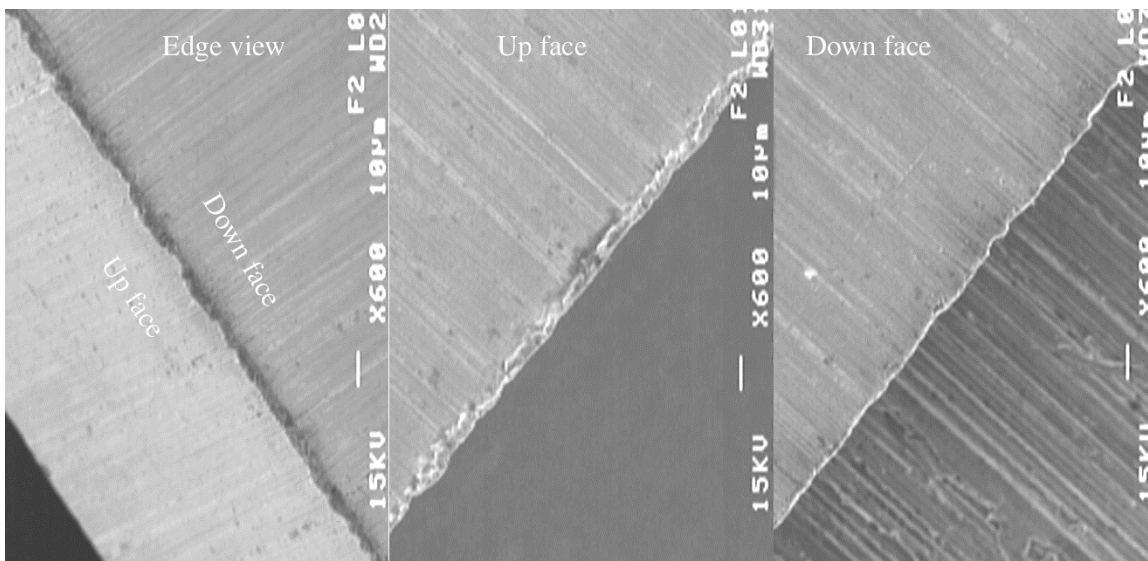

Figure 31 T edge of SS blade ground to $2\beta = 40^\circ$ with Tormek waterstone wheel.

general the edge roughness, as seen in the face views, produced by the 220 grit wheel was larger than that produced by the waterstone wheel. Interestingly, the bur formed by the 220 grit wheel appears to result mainly from the Bending mechanism discussed on page 3, while that formed by the waterstone wheel appears to have formed from the Debris Deposit mechanism.

Honing on the leather wheel

The blades were honed on the chrome oxide loaded leather wheel by adjusting the 2β edge honing angle, first to match the as-ground 2β edge angle of 40° . A series of blades was then honed with the 2β honing angle increased to $45-46^\circ$. Although the increased honing angle did not seem to change the face smoothness or edge straightness much, it did produce a slightly smaller edge width. Therefore, subsequent leather honing experiments presented here were done with

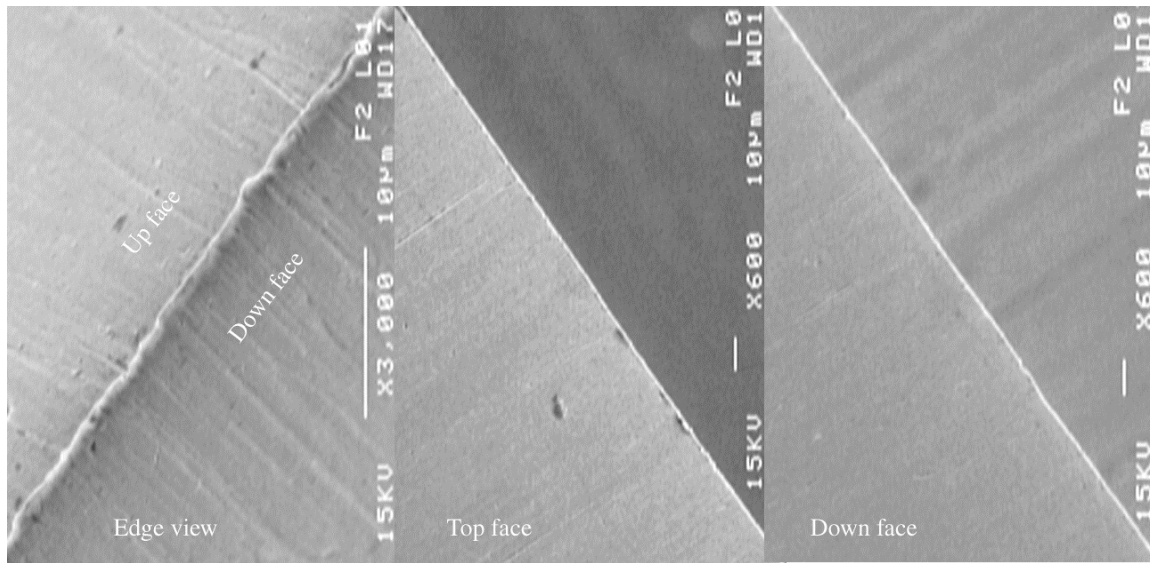

Figure 32 Blade of Fig. 30 after honing on the chrome oxidized loaded leather wheel.

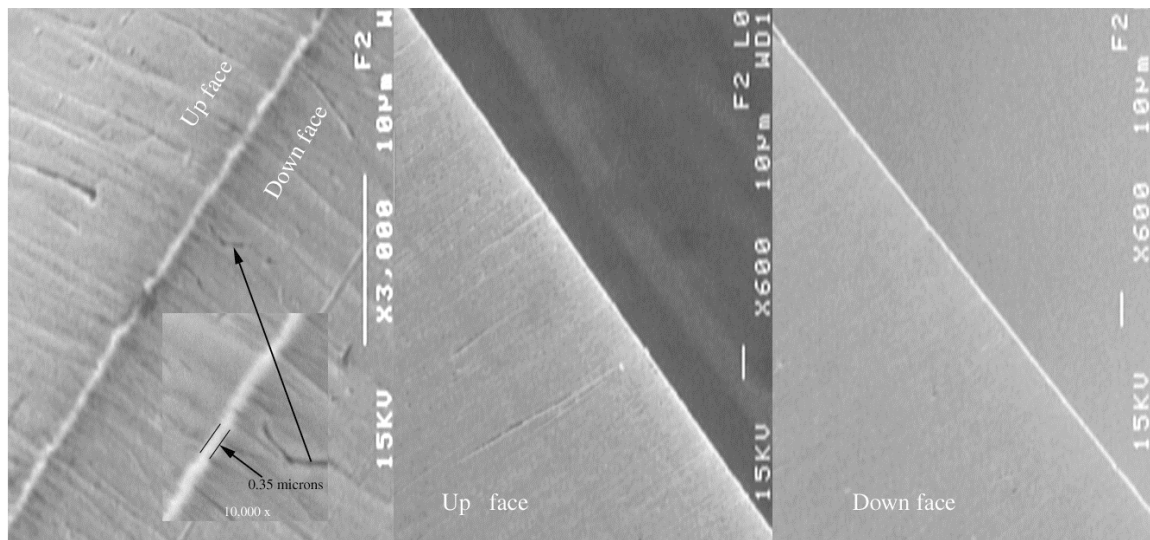

Figure 33 Blade of Fig. 31 after honing on the chrome oxide loaded leather wheel.

the 2β target hone angle set to around 5 to 6° larger than the as-ground 2β angle of the blades. The leather honing was done with very light pressure. The blades were passed back-and-forth across the wheel at a slow rate of around 1 inch per second. A total of 4 to 6 back-and-forth passes were made on alternate sides of the blades. Experiments with increased pressure did not produce significant changes. Figures 32 and 33 present SEM micrographs of the blades of Figs. 30 and 31 after the honing treatment. Increasing the number of back and forth passes to 10 to 12 did not produce significant changes.

Figures 32 and 33 illustrate that honing on the chrome oxide loaded leather strop produces edges of excellent quality on blades as-ground on both the 220 grit and the waterstone wheels. In both cases the face smoothness is excellent and the edge roughness and straightness seen in the face views are also very good. It does appear that the edge width of the blades ground with the 220 grit wheel, Fig. 32, is a bit larger than that of the blade ground on the waterstone, Fig. 33. Figure 33 includes a blowup of the edge at a magnification of 10,000x, superimposed on the edge view. As shown, the edge width is on the order of 0.35 microns. (Note: On sharp edges, the secondary electrons that form

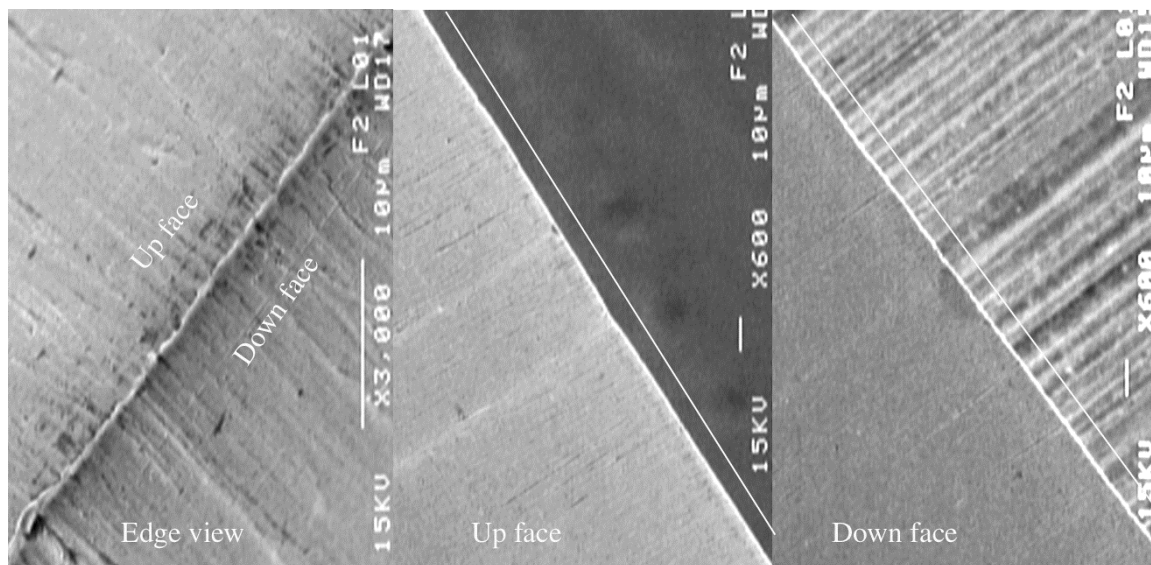

Figure 34 A blade ground originally on Tru Hone 220 grit wheels, then honed on the chrome oxide leather wheel. (the images of SEM micrographs tend to escape from around the side of the edges due to primary beam penetration. This results in a flaring of the edge, so that the real location of the edge is hidden within this flared region. Therefore the true edge width thickness will be a bit less than the total flared edge image seen at very large magnifications.) The edge quality of the blade of Fig. 33 compares quite favorably with the edge quality of the standard razor blades of Figs. 7 and 9. The edge width of the 220 grit blade of Fig. 32 is significantly larger than that of the waterstone blade of Fig. 33. It measures roughly twice the width, around 0.8 microns, and the top face view of Fig. 32 indicates that a very small bur persists along the blade edge. However, comparing Fig. 32 to the initial as-ground state of this blade shown in Fig. 30, it is amazing how well the action of the leather honing has improved the edge of this blade.

Figure 34 presents micrographs of leather honing a blade that had been sharpened to a 2β edge angle of 40° on the Tru Hone machine using 220 grit wheels. Again one sees that the leather honing has produced a very straight and smooth edges as revealed in the face views. The edge view of this blade shows that it has a very thin edge width, but does contain some wider edge regions. The as-ground bur of blades sharpened on the 220 grit wheel of the Tru Hone machine shown on Fig 10 does appear to be of a slightly different geometry than that produced by the 220 Tormek wheel, compare to Fig. 30. Perhaps this accounts for the slightly thinner edge width seen along most of the length of the Tru Hone blade in Fig. 34.

Effect of 2β edge angle change from 40 to 20°

Figures 35 and 36 show the edge of blades ground to 2β edge angles of only 20° . As with the 40° edge angles of Figs. 30 and 31 the 220 grit wheel produces significantly rougher edges in the face views than found with the waterstone wheels. The difference in the leather honed blades shown in Figs. 37 and 38 is similar to that found with the 40° blades of Figs 32 and 33. Only now it appears that the edge straightness, highlighted by comparison to the superimposed straight lines on the face views of Figs 37 and 38, is significantly inferior on the 220 grit blades. Again the 220 grit blade shows an edge width roughly twice that of the waterstone blade. The waterstone blade edge width, although as thin as that of the 40°

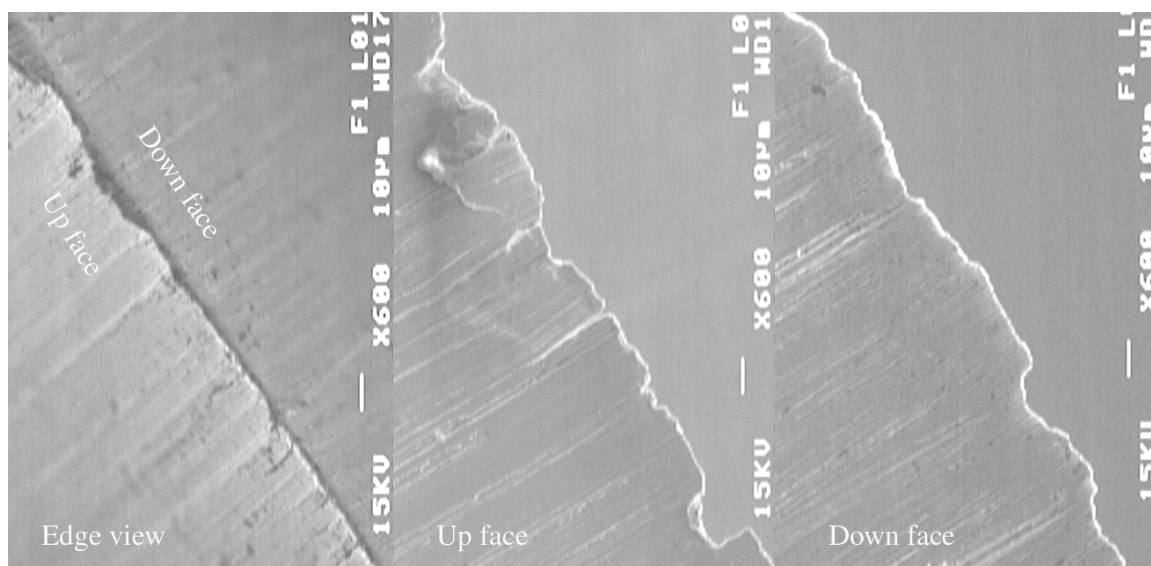

Figure 35 T edge of SS blade ground to $2\beta = 20^\circ$ with Tormek SG-220 wheel

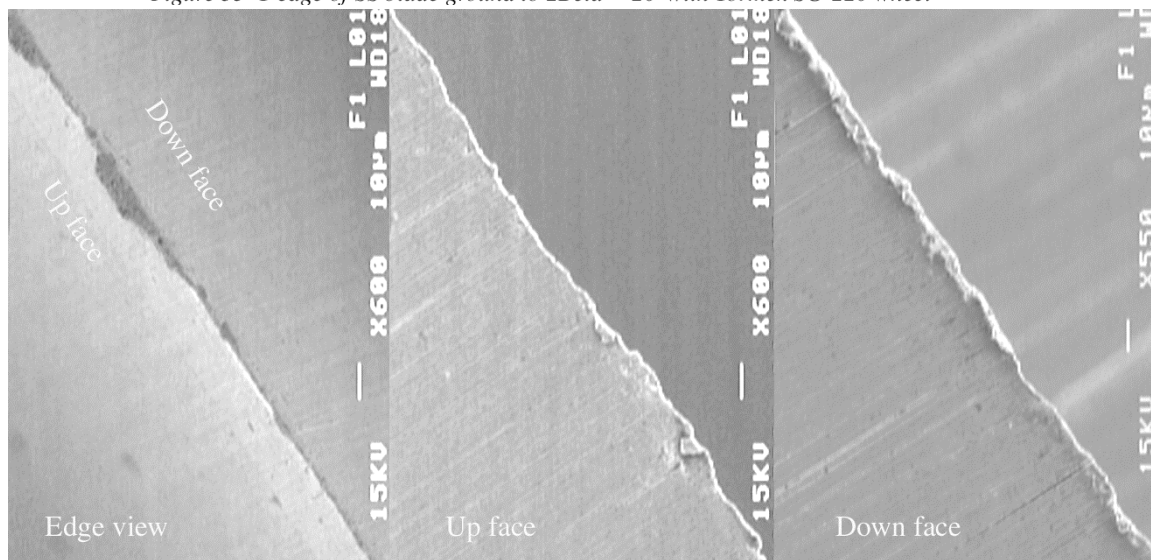

Figure 36 T edge of SS blade ground to $2\beta = 20^\circ$ with Tormek waterstone wheel.

blade of Fig. 33 along part of the length shown, does contain regions where the width increases from around 0.35 microns to around 0.6 microns.

These results indicate that as the 2β edge angle is dropped from 40° to 20° it becomes more difficult to sharpen blades to the same edge quality. This probably results from the reduced thickness of the blade at locations just behind the edge. This reduced thickness will increase bending stresses of the sharpening operation which can lead to bending and cracking of the metal along the edge. Hence, the more gentle abrading action of the waterstone over the 220 grit wheels becomes more of an advantage at the lower 2β angles.

Conclusions

- 1 In the as-ground condition both the Tormek 220 grit wheel and the waterstone wheel produce fold-over burs clearly visible in the face views, with the burs much larger

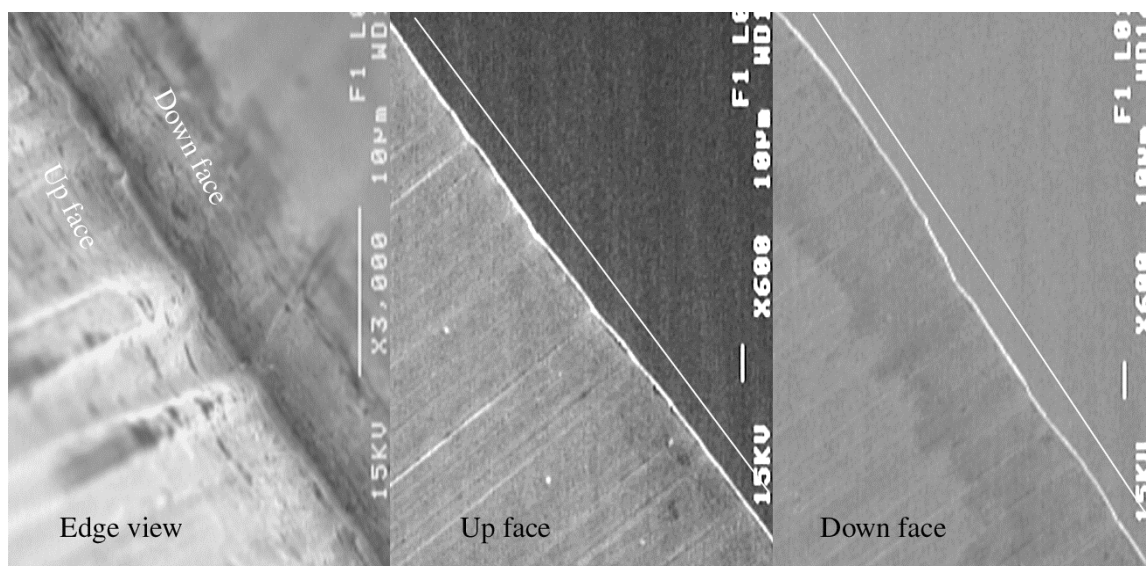

Figure 37 Blade of Fig. 35 after honing on the chrome oxide loaded leather wheel.

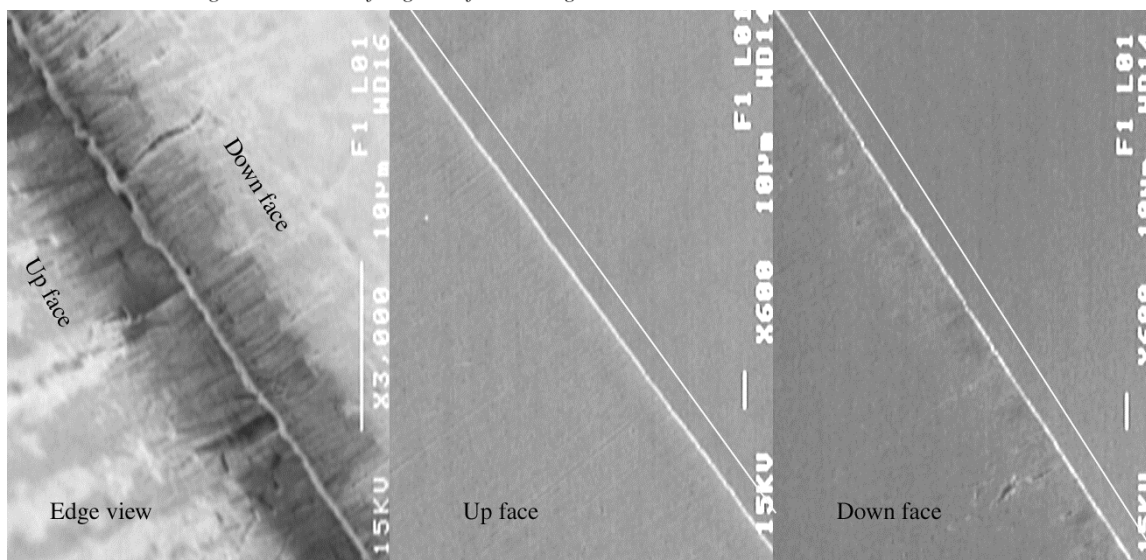

Figure 38 Blade of Fig. 36 after honing on the chrome oxide loaded leather wheel.

for the 220 grit wheel. Honing on the chrome oxide loaded leather wheel was very effective at improving the edge quality of blades sharpened on both wheels. After the honing treatment, the difference in the edge quality of the two blades was much less apparent.

2 The edge view radius of honed blades had an average maximum value of around $0.4 \mu\text{m}$ for the waterstone sharpened wheel as well as the 220 grit Tru Hone sharpened wheels. This radius increased to around $0.8 \mu\text{m}$ for the 220 grit Tormek wheel. Occasional fold-over burrs are apparent in face views of the 220 grit Tormek blades which produce the maximum radius in edge views. Such burrs were rarely seen for the waterstone blades and occasionally seen in the 220 grit Tru Hone blades. The overall quality of the leather honed waterstone ground blades was equivalent to the standard razor blades of Figs. 7 and 9 in all aspects evaluated here: edge width, edge straightness, edge roughness, and surface smoothness.

3 Dropping the 2β edge angle from 40° to 20° had little effect on the edge quality of the waterstone sharpened blades after leather honing. Blades sharpened with the 220 grit wheel showed roughly the same increase in edge width as found with the 40° blades, from around 0.4 to 0.8 microns.. However, for the 2β edge angles of 20° , the edge straightness of 220 grit blades was not as good as for the waterstone blades, with the edge showing a small but distinct waviness, see Fig. 37. It seems unlikely that the small increase in waviness and maximum radius would have a significant effect on cutting performance for most applications. The edge quality of both blades is very good.

[6] Buffing Wheel Experiments

Buffing Wheels

Buffing wheels are commonly used to finish the knife sharpening process. Therefore, a study was done in which the stainless steel blades were finished by buffing on standard felt and cloth wheels. The buffing operation was carried out by Master Bladesmith, Alfred Pendray of Williston FL. The T edge of the stainless blades were resharpened to a 2β edge angle of 40° using progressively the 220, 400 and 600 grit wheels of the Tru Hone machine. In addition blades were produced with the A edge geometry of Fig. 5 using the same procedure. A jig was made to firmly hold the blades into the buffing wheel and the 4 buffing procedures shown in Table 3 were carried out on both the T and A edges. The 555 polishing compound is a product of Brownells, Inc. The compound is embedded in a wax-like bar similar to the green chrome oxide compound used above with the leather strops and wheels. The abrasive is aluminum oxide, and the White has an average particle size of under 1 micron, while the black is in the 1-5 micron size range [5].

Table 3 The 4 buffing procedures

Blade No.	Wheel	Compound	No. passes	Pressure
1	Medium felt	555 White	4	Moderate
2	Medium felt	555 White	2	Medium
3	Stitched cloth	555 White	2	Medium
4 (2 steps)	Cloth	555 Black	2	Medium
	Felt	555 White	2	Med.

To the eye, all samples showed a shinny effect from the buffing procedure, but the effect was distinctly more pronounced on the blade of procedure 4. The blades were examined by two techniques. First, the center 1 inch section of the blades was cut out with a water cooled cut-off wheel and the edge along this section was examined in the SEM. Second, a 1/8 inch length was cut off the remaining blade pieces at each side of the center section. These 2 pieces from each blade were mounted in plastic and polished through one micron diamond using standard metallographic polishing techniques. After mounting the samples were ground heavily on coarse (50 grit) paper to remove any burs that were generated when the cut-off blade sectioned the tip region of the blade. The polished sections were examined in the optical microscope to reveal the cross sectional shape of the sections.

SEM Study of the Buffed Edges

The SEM photos in this study were taken on the blades only in Edge view. An edge view of an unbuffed blade of the as-ground condition is shown in Fig. 39. Comparison of the buffed blade micrographs to it will allow an evaluation of the effect of the buffing operation. All of the 8 buffed blade edges of Table 3 (4 blades each with A & T edges) were examined in the SEM and Fig. 40 presents representative micrographs of three of the blades. The designation of T or A on the micrographs refers to the blade edge examined. For example, 2T means the T edge of blade 2 of Table 3 and 3A means the A edge of blade 3 of Table 3. After buffing the blade edges appeared smooth and shinny to the eye, and Fig. 40 shows that the abrasive grooves produced by

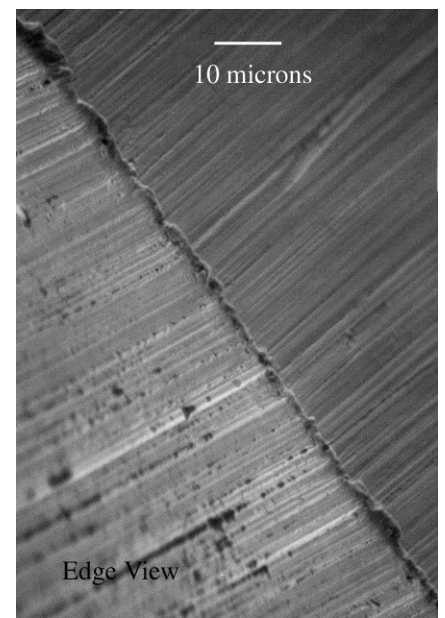

Figure 39 Edge view of as-ground T edge prior to buffing.

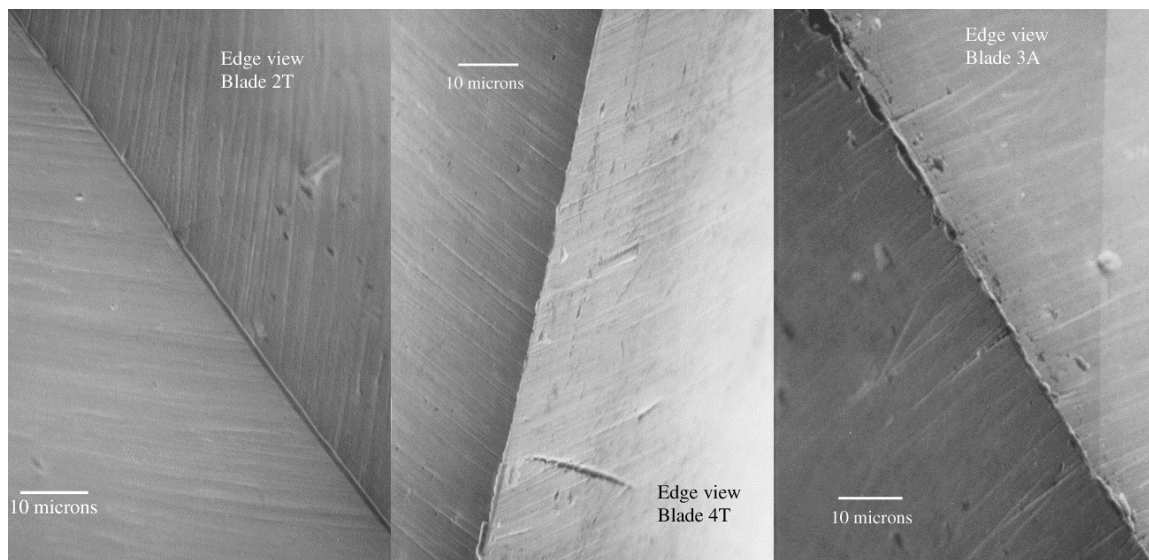

Figure 40 Edge views at original mag. of 1200x of buffed blades.

the 600 grit wheels were largely removed by the buffing operation.

A small bur was consistently found on all of the blades and a measure of the edge width was made on each of the blades using the SEM micorgraphs. Table 4 presents a summary of the range of edge width values found for the 8 blades. There were two clear results of this study. (1) The T edge of the blades possessed thinner burs than the A edges. In addition, the burs along the T edge were more uniform than along the A edge. This result can be seen by comparing Blade 2T to Blade 3A in Fig. 40. (2) The use of the 2-step buffing operation on blades 4, consistently produced thinner burs than any of the single step operations used on blades 1 to 3. The variations of the buffing procedures employed with blades 1 to 3, see Table 3, did not produce any significant change in edge quality.

Table 4 Measurements of edge widths.

Blade	Edge width	Blade	Edge width
1T	0.8-2 μm	1A	1-5 μm
2T	0.8-2 μm	2A	1-5 μm
3T	0.8-2 μm	3A	1-5 μm
4T	0.3 -2 μm	4A	0.5 - 5 μm

The 2-step buffing operation used the coarser compound for the first step on a cloth wheel, followed by the finer compound on a felt wheel. It is common practice in metallographic polishing of metals to proceed from coarse to fine grit abrasives. It has been the experience of this author that employing this progressive type of polishing is much more effective at producing smoother final surfaces. It seems likely that a similar effect occurs here, with the use of a 2-step progressive grit size procedure able to reduce the edge bur more effectively than the use of just the final fine grit compound. Additional experiments would be needed to verify this possibility. The reason why the bur size on the A edges were significantly larger than on the T edges is unknown. Here also, additional experiments are needed to determine the source of this variation.

Cross Sectional Outlines

The optical images of the polished cross sections of the blades were collected digitally. The digital images were then processed on a pc to superimpose a white line along the outer surfaces of the blades, as shown for two of the blades in Fig. 41. The extension of the outlines to the crossover point allows a reasonable estimate of the original shape of the blade prior to buffing. The original geometry of the edge was known from sections of unbuffed blades. It is apparent from Fig. 41 that one

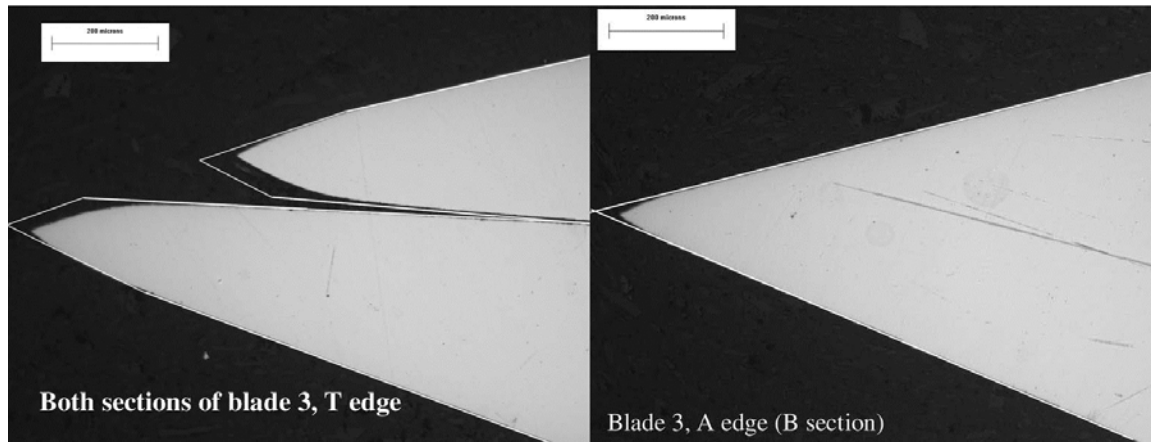

Figure 41 Optical micrographs of T and A blade edges with outline of as-ground blade shapes superimposed on the buffed blades. can estimate from these micrographs how far back the as-ground edge has been polished away by the buffing operation.

The distance of retraction of the tip from the extrapolated lines was measured for each pair of blade sections and the results are presented in the left 3 columns of Table 5 for the A edges. The average retraction distance is 73 and 42 microns for blades 1A and 4A, and 25 and 39 microns for blades 2A and 3A, respectively. One would expect more retraction from blades 1 and 4 because these blades had 4 passes rather than the 2 of the other blades, and the data is consistent with this expectation. The corresponding results for the T sections are not as easy to interpret. The outline of the original blade shape was fitted to that of the buffed blades by moving the outline onto the buffed blade image so the lines from the bottom and top faces fit the buffed blade image. If the buffing removed significant material from the top and bottom faces appearing on the micrographs, then the outline would move further to the right than they should have. This would have the effect of reducing the contraction distance from the true tip position. The average retraction distance for blades 1T and 4T is $(38+54)/2 = 46 \mu\text{m}$, compared to $(51+54)/2 = 52.5 \mu\text{m}$ for blades 2T and 3T, which is not consistent with the larger number of passes for blades 1 and 4. Perhaps this inconsistency results from the fitting problem. Nevertheless, the data do show that the T edges have retracted by a minimum of around 40 to 55 microns during the buffing.

Table 5 Measurement of retraction distances.

Blade	Retraction	Avg. Retr.	Blade	Retraction	Avg. Retr.
S1AB	75 μm	73 μm	S1TB	33 μm	38 μm
S1AD	72		S1TD	43	
S2AB	24	25	S2TB	63	51
S2AD	27		S2TD	39	
S3AB	42	39	S3TB	44	56
S3AD	36		S3TD	68	
S4AB	38	42	S4TB	61	54
S4AD	46		S4TD	48	

The data of this study show clearly that any bur on the tip from the original grinding operation must have been removed by the buffing operation. For example, the data of Table 5 show that the original tip has receded by at least 25 μm on the most lightly buffed A edge and probably by at least 40 to 50 μm on the most lightly buffed T blade. The bur size on the final blades are in the 1 to 5 μm range, and on the original as-ground blades they were probably no larger than 7 μm at the most. Looking at Fig. 41 it is

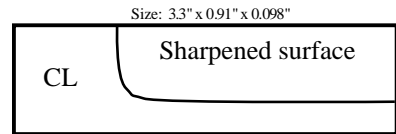

Figure 42 Geometry of 52100 blades.

seen that the buffing action is removing a very significant amount of metal from the tip region, very much larger than the size of the burs involved either on the final or the original as-ground blades. So it is apparent that any bur on the buffed blades was produced by the buffing action itself. At the conclusion of this phase of the buffing study it was surmised that perhaps bur formation in the buffing operation might be reduced if the buffing was done with a lighter pressure and this lead to the following study.

Buffing study on a non stainless steel

To investigate the effects of using a lighter buffing pressure, and expand the buffing study to non stainless steel blades, Al Pendray prepared a set of 3 blades made from austempered 52100 steel. The hardness of the austempered blades was HRC = 56. Figure 42 illustrates the blade shape. The end marked CL was held in a clamp and the opposite end of the blades was sharpened on a belt grinder using 3M Trizact belts A-65, A-30, A-16 and A-6, which correspond to grits of 280, 700, 1200 and 2000, respectively. The blades contacted the belt just after it left the pulley producing a "slack belt" grinding effect. After the belt grinding operation the blades were lightly buffed and/or stropped on leather as described in Table 5.

Table 5 Sharpening procedure of the 4 blades.

No.	Belt Series	Buffing
AP-1	280-700-1200-2000	White 555 on cloth wheel
AP-2	280-700-1200-2000	White 555 on cloth wheel + plain leather strop.
AP-3	280-700	White 555 on felt wheel

Figure 43 presents the SEM micrographs of blade AP-1. The two faces of the blade are fairly smooth indicating that the combination of the 2000 grit belt and the buffing have been effective in giving a well polished surface. However, there is a dominant bur along the edge and the Edge View 3000x micrograph indicates the edge-on bur width to be around 1 to 1.2 μm wide. The bur has been curled around the down face shown on the right of Fig. 43.

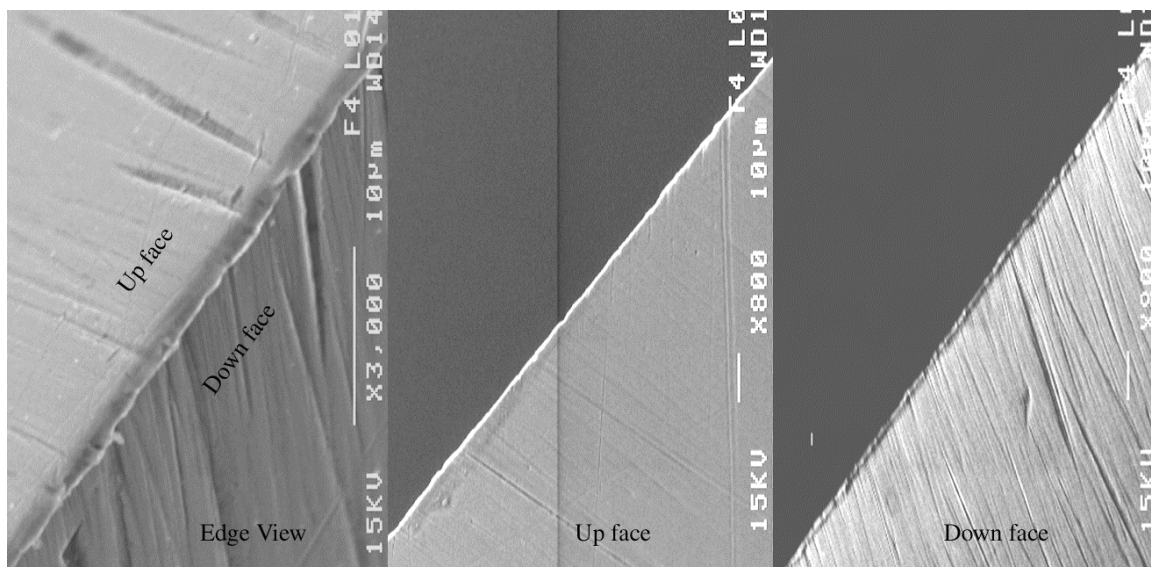

Figure 43 Blade AP-1 after buffing as described in Table 5

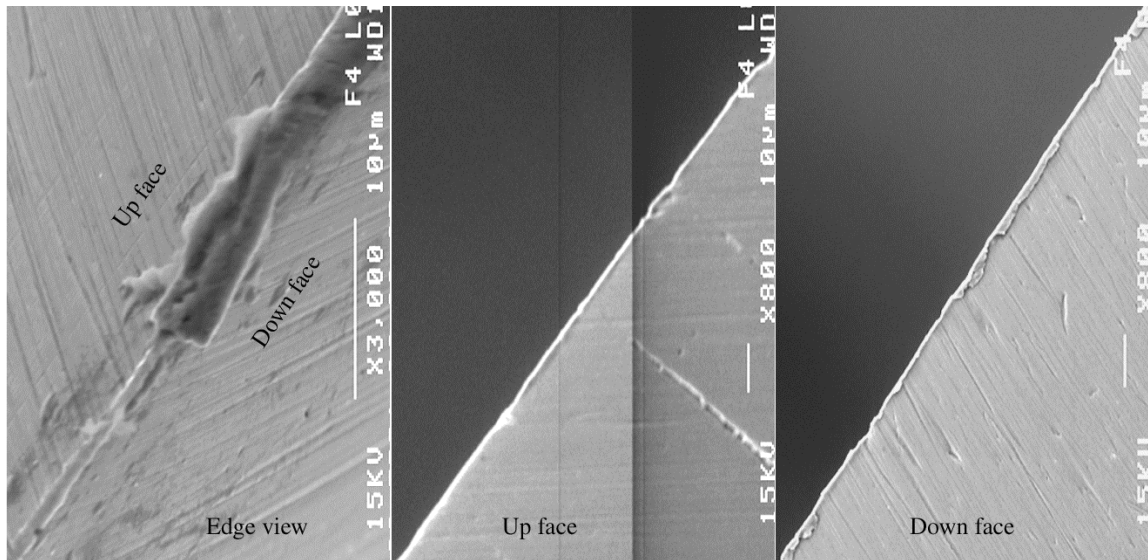

Figure 44 Blade AP-3 after buffing as described in Table 5.

Figure 44 presents the micrographs for Blade AP-3. Its preparation differed from AP-1 in that the final belt was much coarser, 700 vs. 2000 grit, and the buffing wheel was felt rather than cloth. Comparing Figs. 44 to 43 it is seen that the face of the blades have been polished to about the same level. Hence it appears that the felt wheel buff has effectively removed the coarser abrasion marks that must have been produced by the 700 grit belt used with the AP-3 blade. However, the bur produced with the felt wheel is more dominant, displaying a large fold-over bur on the down face view, which is well illustrated in the Down face micrograph of Fig. 44 and at the top right of the Edge view micrograph.

The stropping experiment on clean leather employed a flat leather strop attached to a board. The experiment was similar to that of section [4], p. 19, except that it was done by A. Pendray in his shop, rather than by the author in his lab. As in section [4] study, it was found that the stropping operation on clean leather had little effect on the surface smoothness or bur geometry. To save file space micrographs of blades AP-2 are not presented. Their appearance was very similar to Figs. 43, with the addition of some minor sized scratches produced by the stropping operation.

Conclusions

- 1 These results suggest that buffing on cloth or felt wheels is not the best method for finish sharpening of knife blades. It appears that even a light buffing action removes a significant amount of metal near the thin edge of the blades which leads to a bur along the edge that is consistently larger than the bur formed with leather strops or wheels. However, a single experiment with a two step buffing operation, first with a coarse compound and then a fine compound, did produce improved results and further study of that method may indicate that it is equivalent to the final polishing on leather media.
- 2 The experiment with stropping clean leather confirms the previous experiments. The natural abrasives present on clean leather are not adequate to remove edge burs or surface abrasion grooves on stropping.

[7] Experiments on carbon steels

A series of experiments was done on the carbon steel blades having the geometry shown in Fig. 6 and the composition and hardness shown in Table 2. The main purpose of this study was to evaluate the effect of reducing the hardness of the steels from the HRC = 60 level to the HRC = 40 level. The conventional steels, 52100 and 1086, were heat treated to final hardness of Table 2 by quench and tempering treatments. The Damascus steel was a 1.6 % carbon steel of the genuine Damascus type [6] that was oil quenched from below its A_{cm} temperature to produce the HRC 40 hardness value. It was a pearlitic steel, while the other steels were quenched and tempered martensitic steels.

Experiments with the TruHone machine

These experiments utilized the 1000 grit wheels of the TruHone machine for the final grinding after an initial grind with the 600 grit wheels. The initial experiments were done with a 2β edge angle of 38 degrees using the same procedure as used with the stainless steel blades discussed on page 8 except that the 2β edge angles on both the 600 and 1000 grit wheels was decreased by 3 degrees. Figure 45 presents face views of three steels with HRC varying from 40 to 60. The results show that at the reduced hardness of HRC = 40 there is a definite increase in the degree of edge roughness.

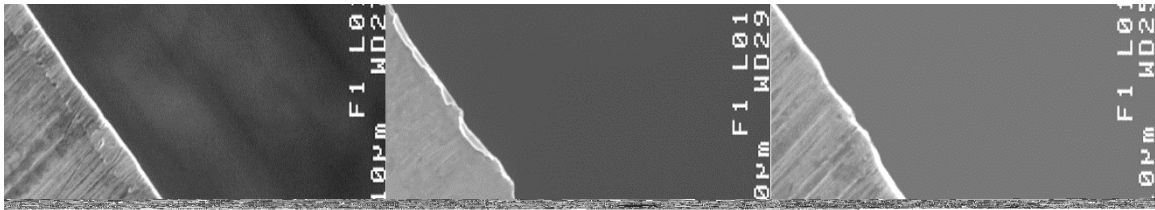

These carbon steel blades were used in the study with the TruHone machine aimed at reducing the 2β edge angle to the minimum possible values. The initial experiments were done at 2β value of 20 degrees. At this small angle the operator could feel a definite vertical pulsating motion as the blades passed over the wheels. At 20 degrees the wheels of the TruHone machine used here had a very small overlap. Hence, any out-of-round wheel shape leads to a significant up-and-down pulsating motion as the edge of the blade passes over the wheels. This action produces edges that are not straight. It was concluded that a 2β edge angle of 20 degrees was too small for good sharpening, and a series of blades were done at what seemed to be the smallest angle

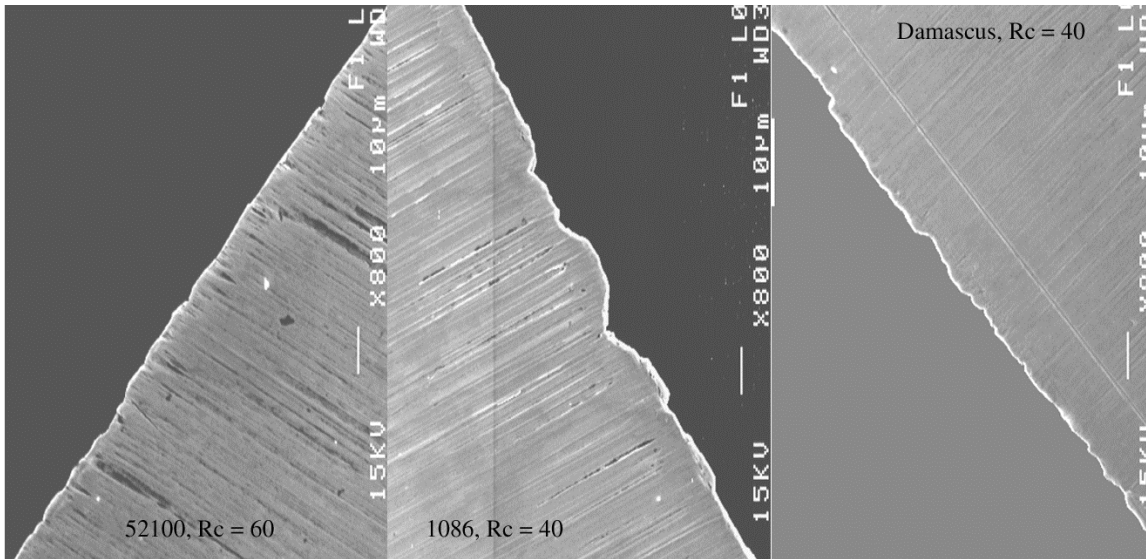

Figure 46 Face views of 3 non stainless steels. As-ground on 1000 grit TruHone wheels at $2\beta = 30$ degrees. useful for the TruHone machine, $2\beta = 30$ degrees. The face profiles of three blades sharpened at this angle are presented in Fig. 46. It is seen that the variation of edge roughness with hardness is similar to that shown in Fig. 45.

Experiments with the Tormek machine

Additional experiments were carried out with the plain carbon steels using the 220 grit ceramic wheel of the Tormek machine. Blades of 1086 steel at the 2 levels of hardness were sharpened at a 2β edge angle of 40 degrees. Face views of these blades are presented in Fig. 47. One may directly compare the two face views of the harder steel on the left to that of the softer steel on the right. As with the TruHone experiments on the finer 1000 grit wheels it is

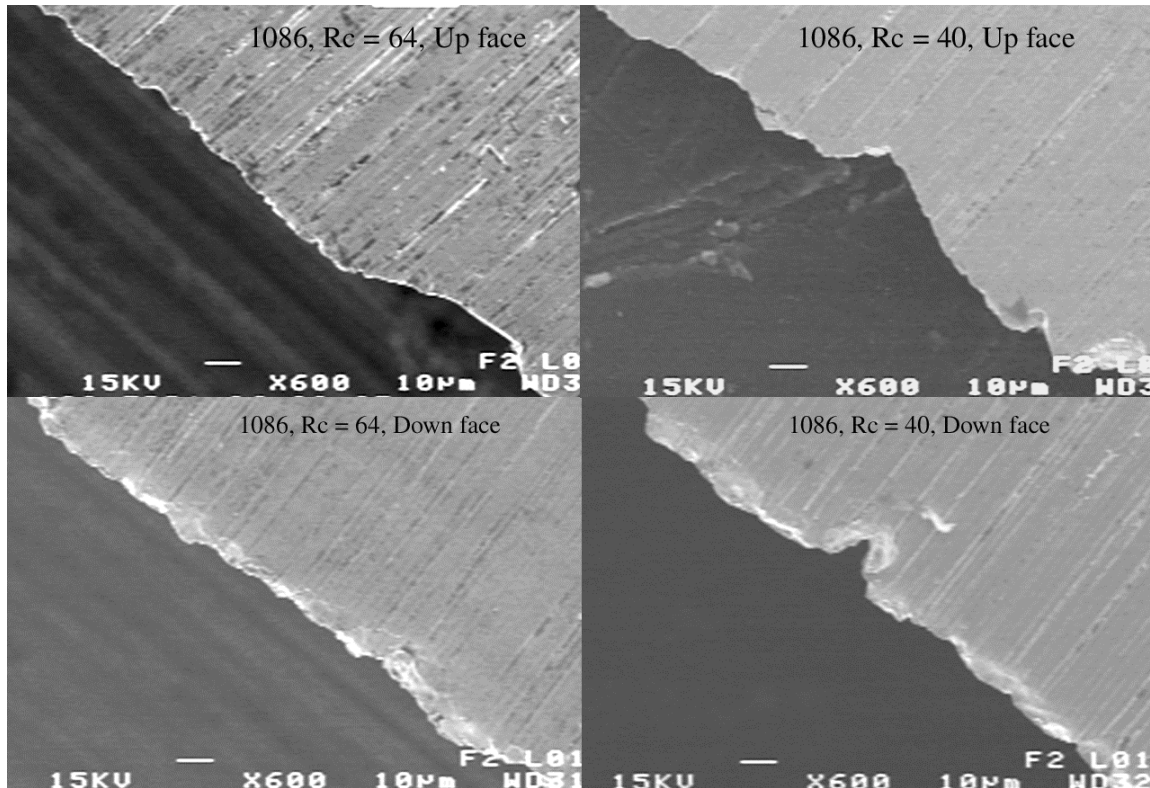

Figure 47 Face views of two 1086 steels. As-ground on 220 grit Tormek wheels at $2\beta = 40$ degrees.

found that the softer steel produces a much rougher edge after grinding. Also, if one compares the edge roughness of the harder steels of Figs 45 to 47 with the stainless steel blades, which also had HRC values of close to 60, it is found that the edge quality is similar.

Conclusions

1 The edge roughness of steel blades sharpened with 1000 grit wheels on the Tru Hone machine and with 200 grit wheels on the Tormek machine show the same dependency on steel hardness. In both cases the edge roughness is significantly larger for blades at a hardness of HRC = 40 than for blades of HRC = 60.

2 At the hardness level of HRC = 60 the edge roughness for 1086 and 52100 steels is essentially the same as for AEB-L stainless steels.

[8] Experiments with Diamond Polishing Compound

The author has considerable experience with standard metallographic polishing of steels. The final stages of polishing employ horizontal polishing wheels covered with some type of a fabric material that is coated with fine abrasive materials. It had been traditional to use fine abrasives of alumina (Al_2O_3) but over the past several decades diamond abrasives have become commercially available. Initially these diamond abrasives were available only in an oil based paste, but they are now available in aerosol sprays. These diamond abrasives are commonly available in a 6 micron and a 1 micron grit size. The author has found that for hardened steels final polishing with diamond is much more rapid than with alumina, and the 1 micron compound produces a surface that appears scratch free at the highest useful magnifications in an optical microscope (1000x). Therefore a final set of experiments was done in which blades were given a final polish on the Tormek leather wheels using diamond abrasive as well as the chrome oxide abrasive.

In this work 3 different leather wheels were available for the final polish.

- 1- a wheel coated with the chrome oxide abrasive as described above.
- 2- a wheel coated with 6 micron diamond aerosol spray.
- 3- a wheel coated with 1 micron diamond aerosol spray.

The diamond compounds used here are a product of the Buehler corporation which they call, "Metadi". The compound was applied to the wheel by simply spraying the rotating wheel briefly until it was well wetted. As above, the 3.8 inch long blades were passed back and forth (b&f) across the leather wheel various number of times while maintaining a grind angle larger than that of the pre-ground blade by a small amount called $\Delta\beta$, after which the centers of the blades were examined in the SEM.

All of these experiments were done on the stainless steel blades. Three sets of blades were pre-ground as follows. Each set consisted of 4 to 8 blades ground on the T edge (see Fig. 5) with the Tru Hone machine using (set 1) 220 grit wheels, (set 2) 600 grit wheels, and (set 3) 1000 grit ceramic wheels, all at a 2β edge angle of around 40° .

In this work the SEM analysis was modified to give a better statistical evaluation of the edge width (EW). For each blade 3 pictures were taken of the edge view at 3000x magnification. The blade was randomly viewed and the first picture was taken. Then the blade was moved along the edge successively in 1 mm increments and the final 2 micrographs were taken at 3000x. A maximum and a minimum edge width was measured on each of the micrographs and the average of the 3 minimum and maximum EW values recorded and reported here. This procedure was adopted to avoid observer bias and to give a better statistical measure of the edge widths.

Experimental Results

The major objective of this phase of the study was to determine the minimum values of EW that could be obtained with diamond polishing compound. Table 6 presents the results of the optimum values that were obtained. These blades had all been pre-ground with 600 grit wheels on the Tru Hone machine to 2β edge angles of 40° . The average values at the bottom of this table provide a measure of the

optimum EW values found for a final polish with 1 μm diamond compound. The \pm numbers following the average values are the standard deviation over the 4 measurements. Polishing first with either the CrO or 6 micron diamond compounds (blades 3-63 and 8-63) did not produce significantly different results.

Table 6 Optimum EW values with diamond polish

Blade number	Procedure	Avg. Min/Max	Overall Avg.
3-63	10 b&f on 6 μm D + 5 b&f on 1 μm D	0.18/0.34	0.26
6-63	11 b&f on 1 μm D	0.20/0.42	0.31
7-63	7 b&f on 1 μm D	0.20/0.38	0.29
8-63	6 b&f on CrO + 5 b&f on 1 μm D	0.34/0.45	0.39
	Overall Average min. = 0.23 ± 0.07 microns Overall Average max. = 0.40 ± 0.05 microns Overall Average = 0.31 ± 0.06 microns		
Gillette		0.17/0.48	0.32

The Gillette blade used as a standard above was also analyzed here with the same procedure as that employed for the Table 6 blades and it gave the results shown at the bottom of the table. So the edge width values obtained here are comparable to that of this razor blade. (Note: The EW values obtained here for the Gillette blade were a bit smaller than those given on p. 6, where the average EW = 0.40. This difference is, however, within the standard deviation of ± 0.06 microns reported in Table 6.)

Comparing the EW values measured on blades pre-ground with either 220 grit or 1000 grit wheels to the results of the pre-ground 600 grit blades of Table 6 found no significant changes, providing an adequate number of b&f passes were made. Blades examined after different numbers of b&f passes revealed that a minimum number of 12 to 15 passes was necessary to produce face smoothness that removed most all of the coarsest abrasive grooves from extending up to the cutting edge. Figure 48 illustrates the effect of increasing the number of b&f passes from 4 to 10 on a blade pre-ground with 600 grit wheels. The results for both the CrO compound and the diamond compounds was essentially the same, a minimum of 12 to 15 passes was best to remove the deepest abrasion grooves from extending up to the cutting edge.

A few blades were final polished with only the CrO compound and with only the 6 micron diamond. In both cases it was found that the EW values were higher than those of Table 6 by around 0.1 to 0.2 microns.

Sets of 2 blades were polished on both 1 micron diamond and CrO wheels with the polishing angle increase over the pre-ground angle, $\Delta\beta$, changed from 3 degrees to 5-6 degrees. The results of this study agreed with that of that presented in Section 5: Values of $\Delta\beta = 5-6$ degrees gave slightly smaller EW values than found for $\Delta\beta = 3$ degrees.

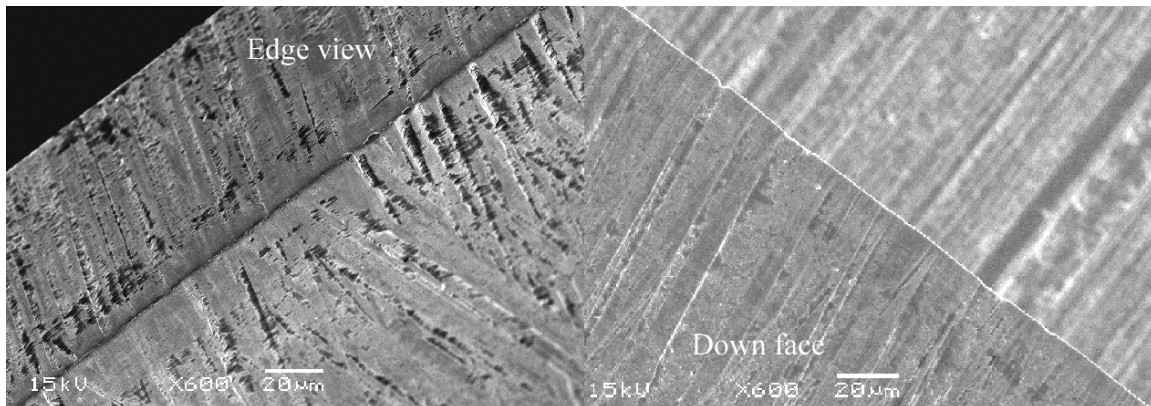

(a) Pre-ground 600 grit blade after 4 b&f passes on 1 micron diamond.

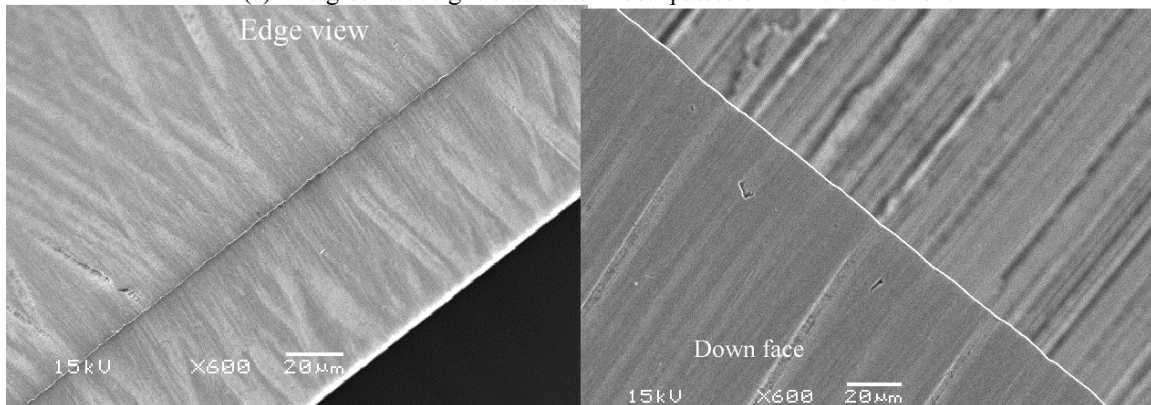

(b) Pre-ground 600 grit blade after 10 b&f passes on 1 micron diamond.

Figure 48 Effect of 4 and 10 b&f passes on the removal of surface abrasion grooves produced by a 600 grit pre-grind.

Conclusions

1 The use of 1 micron diamond polishing compound on the Tormek leather wheel produced excellent results. However, the quality of the edge width and face smoothness was only slightly superior to that obtained with the CrO polishing compound. Optimum edge widths on blades pre-ground at 2β face angles of 40° were around 0.2-0.4 microns with the diamond, compared to around 0.3 to 0.5 microns with the CrO. These values of edge width were made with an improved statistical sampling over that done in the previous sections of this report.

2 No significant reduction in EW values was found for a 2 stage polishing process going from CrO to 1 micron diamond or going from 6 micron diamond to 1 micron diamond.

3 An increased polishing angle for the final polish of $\Delta\beta = 5$ to 6 degrees was found to be slightly better than 3 degrees, in agreement with the results presented in section 5.

4 A minimum of 12 to 15 b&f passes over the leather wheel was found necessary to remove the coarsest abrasion grooves from extending up to the cutting edge on blades pre-ground on 600 grit wheels. This result was found for the use of both 1 micron diamond and the CrO abrasives.

[9] Summary and Conclusions

These experiments have been directed at evaluating the edge quality of the sharpening process with regard to the following properties: 1) Edge width at the tip of the edge, 2) Edge straightness and edge roughness as viewed from the face of the blade, and 3) Face smoothness. All of these properties were evaluated from SEM micrographs taken on edge and face views of sharpened blades.

The bulk of the experiments were carried out on AEB-L stainless steel blades having a hardness of HRC = 60. A small number of comparative experiments were done on three non stainless steels, 1086, 52100 and a genuine Damascus steel, at hardnesses of both HRC = 60 and 40.

The majority of the blades were sharpened with either the Tru Hone sharpening machine, see Appendix 3 or the Tormek sharpening machine, see Appendix 2. A limited number of blades were sharpened on flat stones with a holder jig to maintain a constant sharpening angle.

Two angles were defined to characterize the sharpened edge. Figure 4 shows the two angles: the edge angle, 2β and the face angle, 2α . These angles were measured with both a laser goniometer described in Appendix 1, or by metallographic sectioning followed by measurements on an optical microscope, see Fig. 41 and Fig. A13.

Coarse sharpening was done with both ceramic stones or wheels of 220, 600 and 1000 grit, with a diamond hone of 1200 grit, with a fine aluminum oxide stone, and with Japanese waterstones of 6000 and 8000 grit or a waterstone wheel of 4000 grit.

Final honing was done by three different methods:

- (1) Steeling with smooth steels.
- (2) Polishing on leather, either clean or loaded with sub-micron size chromium oxide compound or diamond compound. The leather polishing was done both by stropping on flat leather or by use of a leather wheel on the Tormek machine. In all cases the edge angle of the polish was carefully controlled to values slightly larger than the as-ground edge angle by an amount called $\Delta\beta$.
- (3) Buffing done on felt and/or cloth wheels loaded with aluminum oxide compound.

Major Conclusion

Knife sharpening experts [1,2] teach that for a knife with a given face angle, 2α , the edge angle, 2β , should be formed on stone or belt media by maintaining a fixed grind angle and gauging when the edge face is ground out to the edge by detection of a bur along the edge. This study addresses the question of which final polishing (honing) technique is best to remove the bur and smooth the edge face. The major conclusion of the study is that of the three honing methods studied, the best method for removing the bur and setting the edge angle is clearly a final polish on leather loaded with a polishing compound such as the chromium oxide or diamond compounds used here. Edge quality

matched that of razor blade standards: Edge widths of 0.3 to 0.5 microns, edge straightness of essentially straight line quality, little to no edge roughness as viewed from the side, and a very good face smoothness.

Minor Conclusions:

1 The leather wheel of the Tormek machine offers an excellent method for final polishing of blades. Experiments were done using abrasive compounds of both chromium oxide and 6 and 1 micron diamond aerosol sprays. The 1 micron diamond abrasive produced optimum edge widths of around 0.3 microns, while the CrO abrasive gave only slightly larger EW values, around 0.4 microns. Both abrasives produced excellent face smoothness and edge straightness after 12 to 15 back and forth passes over the leather wheel.

2 A final honing on a smooth steel produced a dramatic improvement in the burred edge from the original ground edge on 600 grit or coarser stone wheels. As taught by Juranitch [2], it was found that only a few strokes on the steels should be used with a very light pressure at a fixed angle. The action of steeling is shown to result from the steels causing the as-ground bur to be bent around to mainly one side of the blade and plastered flat against the face of that side. Edge roughness and straightness were dramatically improved and edge widths in the 1.5 to 2 micron range were obtained. The improvement in edge quality appeared largely independent of the increase in the steeling edge angle over as-ground edge angle. The range of steeling edge angle increase was from 10 to 30 degrees.

3 Final honing on buffing wheels was found to produce very smooth surfaces. However, although the buffing process, even with only a light pressure, removed the bur from the original grinding operation, it replaced that bur with a bur formed by the metal removed during the buffing operation itself. So the buffing process ended up producing edges slightly rougher than the leather polishing, with an edge width roughly twice the size, around 0.8 to 1 micron.

4 Experiments on both flat stones and wheels that compared edges ground on ceramic oxide wheels with Japanese waterstones, consistently found that the waterstones produced a smaller and generally more uniform bur. Following the final polishing on leather the edge quality was very similar as regards face smoothness, edge roughness and edge straightness. However, the edge width of the waterstone prepared blades were generally smaller than the ceramic prepared blades by roughly a factor of 2, commonly around 0.4 microns for the waterstone blades compared to 0.8 microns for the ceramic blades.

5 Two independent sets of experiments utilizing stropping on clean leather showed similar results. Such stropping action is not effective in removing the as-ground burs or surface abrasion marks. Apparently, the natural abrasives in clean leather, on either the hard or soft side of the leather surface, are not adequate to produce effective polishing.

6 When the 2β edge angle is reduced it becomes more difficult to maintain edge quality. Experiments were done at 2β edge angles of 20 and 40 degrees and the burs formed on the as-ground blades were larger for the 20 degree blades. After final polishing on leather the waterstone prepared blades produced equivalent edge quality for both edge angles. However, the 20 degree blades prepared on 220 grit oxide wheels compared to the waterstone prepared blades had slightly rougher edges and less straight edges, in addition to the increased edge width of conclusion 3.

7 It is possible when sharpening on either ceramic stones or waterstones to move the edge of the knife either into the cutting edge, I, or away from the cutting edge, A, see Fig. 3. Bur forming mechanisms are discussed on page 3 and it is concluded that the using the I direction should produce smaller burs. Hand grinding experiments on waterstones (Fig 27) found that grinding in the I direction did produce less burring than the A direction, and therefore all grinding on stones in this study were done in the I direction. However, on compound loaded soft media, such as leather and buffing wheels, polishing must be in the A direction.

8 Final honing on 1200 grit diamond having the diamond embedded in a nickel matrix on a steel plate produced surprisingly large surface abrasion marks, see Fig. 29.

9 The special 1000 grit wheels supplied with the Tru Hone machine produced edges nearly as good as the leather honed edges as regards edge straightness, edge roughness and surface smoothness. The edge widths were significantly higher, however, running around 1 micron versus around 0.3 microns for leather polished surfaces.

10 The set of experiments on 52100 and 1086 steels at essentially the same hardness as the studies on stainless steels, HRC = 60, showed that the quality of the edges formed on these non stainless steels were quite similar to the stainless steel edges.

11 A study was done on three carbon steels, 52100, 1086 and a genuine Damascus steel that compared edge quality of blades at hardnesses of HRC = 40 and 60. The HRC = 60 blades consistently produced superior edge quality after grinding on ceramic stones and waterstones.

The ability of a knife to easily cut a material is altered significantly if the cutting action is changed from a simple pushing action, as employed in shaving, to a back-and-forth sawing action, as employed with serrated knives. The bur formed by grinding stones does produce a rough edge on the microscale and may reduce the required cutting force for some sawing type cutting operations. However, the bur produces a substantial increase in the edge width and for cutting action involving a minimum of sawing motion the bur will be detrimental. The author is not aware of any study that has addressed this question of when, or if ever, a burred edge might be superior for cutting. This study has been directed at the best way to remove as-ground burs.

References

- 1 L. Leonard, *The Complete Guide to Sharpening*, The Tauton Press, Newtown, CT (1995).
- 2 J. Juranitch, *The Razor Edge book of Sharpening*, Warner Books, New York, NY (1985).
- 3 I. Kirby, *Sharpening with Waterstones*, Cambium Press, Bethel, CT (1998).
- 4 J.F. Sackman, A Close Shave, *Physics in Technology*, vol. 9, 208-213(1978).
- 5 E. Kiesler, Personal communication, Technical Services, Brownells, Inc. (2004).
- 6 J.D. Verhoeven, A.H. Pendray, W.E. Dauksch, The key role of impurities in ancient Damascus steel blades, *Journal of Metals*, vol. 50, 58-64 (1998). www.tms.org/pubs/journals/JOM/9809/Verhoeven-9809.html

Appendix 1

Edge angle measurements with a laser pointer

A relatively crude but effective device was built to measure the 2α and 2β edge angles utilizing a laser beam. A simple laser pointer, sold for a pointing device when giving a lecture, was mounted as shown in Fig. A1. The diagram shows how the laser beam is reflected to the 2 sides of the knife edge. The deflected beams strike the calibrated cross board at specific locations, which can be seen well in a lighted room. Scratches on the edge cause the beam spot to become blurry. The sharpness of deflected spots revealed in a darkened room were found useful in evaluating the edge smoothness. The device allowed the distance of the cross board from the knife edge to be adjusted to maintain a fixed value of X . The distance of a deflected spot from the zero deflection point of the laser beam, called d , is related to the face angle, say α , as:

$$\alpha_1 = [\text{arc tangent } (d(\alpha_1)/X)]/2, \text{ where } 2\alpha = \alpha_1 + \alpha_2$$

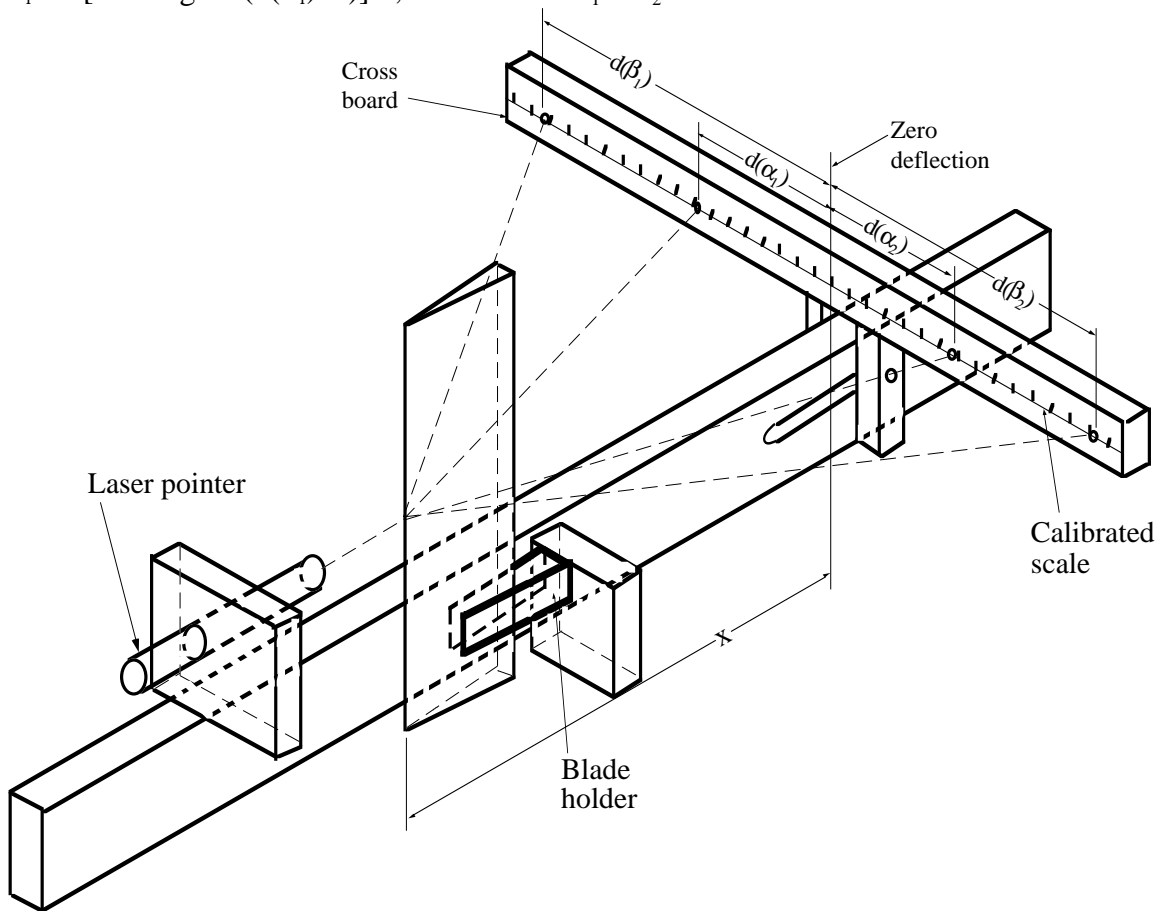

Figure A1 Schematic diagram of the laser device used to measure the face angle 2α and the edge angle 2β .

Using this equation a scale calibrated in degrees was pasted to the cross board. Values of the 4 angles, β_1 , α_1 , α_2 , and β_2 can be read directly from the scale.

Appendix 2 The Tormek Sharpening Machine

The Tormek Supergind 2000 was used to sharpen many of the blades in this study. This system, advertised in virtually all woodworking catalogs, rotates a 10 inch ceramic wheel and a 8.75 inch leather honing wheel on the same shaft at the slow rotation rate of 90 RPM, with the lower part of the ceramic wheel immersed in water. It provides simple jigs to maintain a constant grinding angle, and the long knife jig was used to hold the blades in this work. Fig. A2 presents the general picture of the sharpening of a knife blade on a rotating grinding wheel.

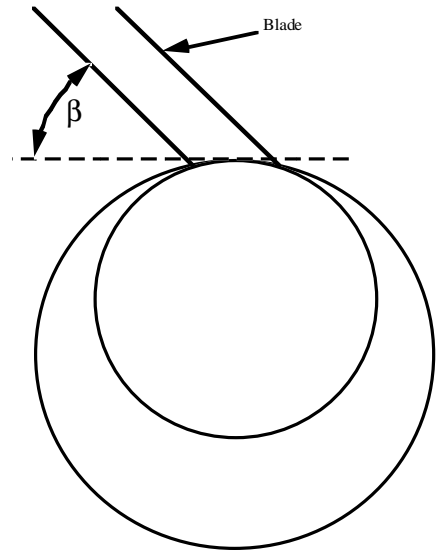

Figure A2 The grind angle beta (β) produced by grinding on wheels of 2 different diameters.

The grind angle is defined here as beta, β , and Figure A2 illustrates that it is an average angle over the curved face ground into the blade. As the blade thickness becomes small the ground face becomes more flat and the β angle is more closely approached at the sharpened edge. The curvature of the wheel will decrease the edge angle from the value of β by a small amount that will be called $\Delta\beta$, where the Greek letter delta, Δ , is used to denote "the change in". Generally $\Delta\beta$ will be small and it will be neglected here initially, and then evaluated at the end of this appendix.

Ceramic Wheels

In this work special effort was made to control the grinding angles to desired fixed values. Because of this, methods were determined to allow desired grind angles to be predicted for a given setup of the Tormek machine, and these methods will be detailed here. Figure A3 shows an overall schematic of the geometry of the Tormek machine with the β angle flipped 180 degrees to the reader from the Fig. A2 view. The knife blade is held in the long knife holder supplied by Tormek, Fig. A4, that allows the operator to make small adjustments to the distance labeled L. This is the distance from the tip of the blade to the base of the holder that rests on the holder bar. The holder bar can be adjusted up and down, and the distance from the top of the holder bar to the top of the machine housing is called X here. An equation was derived by Roger Homer, an emeritus professor of the math Department at Iowa State University, that evaluates the grinding angle, β , as follows:

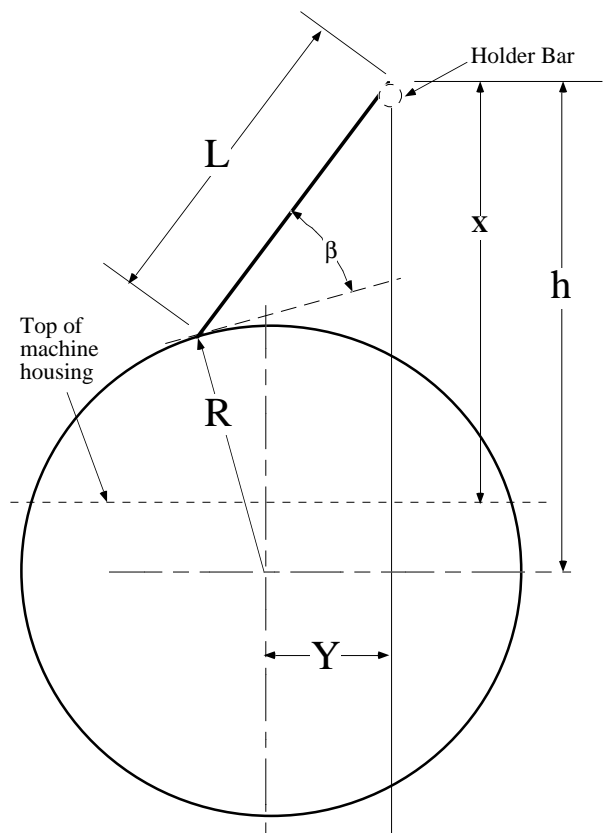

Figure A3 Geometry for the Tormek ceramic wheels

$$\beta = \arccos((R^2 + L^2 - Y^2 - h^2)/(2 * R * L)) - 90 \quad \text{Eqn. 1}$$

There are 4 variables that need to be specified to set the value of β . Two of these are fixed by the machine and 2 are set by the operator.

Machine variables:

R is the radius of the wheel, 127 mm for the SG wheel supplied with the machine.

Y is the distance from the center of the wheel to the vertical plane of the holder bar motion and was found to be -53 mm.

Operator variables:

L must be measured for each setup.

X is the distance from the top of the machine housing to the top of the holder bar and must be measured for each setup. The value of h is then calculated as,

$$h = X + 26.5 \text{ mm} \quad \text{Eqn. 2}$$

The knifeholder geometry

The long blade knife holder jig is shown in Figure A4. There are a couple of important features that set limits on its use. Limit 1: the distance L is adjustable by 2 means, (1) the distance Y that the blade protrudes and (2) the adjustment provided by rotating the handle. Values of L between 12 and 16 cm are generally convenient. Limit 2: the angle beta cannot be reduced below a minimum value that is formed when the distance w goes to zero, because this causes the nut protruding down as shown to hit the grinding wheel. The minimum beta depends most sensitively on the distance Y. Table 1 gives some numbers for minimum beta calculated from Eqn 1 by measuring the value of X needed to reduce w to a value of 1 mm. So for wide blades we can grind small β angles, but for narrow knives, like paring knives, minimums are limited to around 11 degrees.

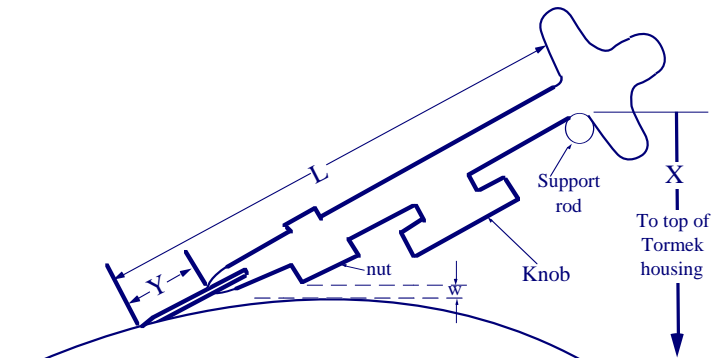

Figure A4 Geometry of the long knife holder jig.

Table A1 Some minimum beta angles

Blade	Y (cm)	L (cm)	X (cm)	β (min)
SS	1.4 cm	15	17	11.2
SS	1.4 cm	12.5	15	11.0
Benchmade	2.8 cm	14.1	14.95	3.4

There is another problem with the Tormek knife holder. When alternate sides of the blade are ground the knob seen in Fig. A4 will be positioned either up or down. The die casting that composes the body of the holder is apparently a bit unsymmetrical, so that the β angle formed in these two positions is a bit different. Experiments show that the angle ground on the side when the knob is up, comes out larger than with the knob is down. The difference was measured by the laser goniometer to be around 3.2 degrees,

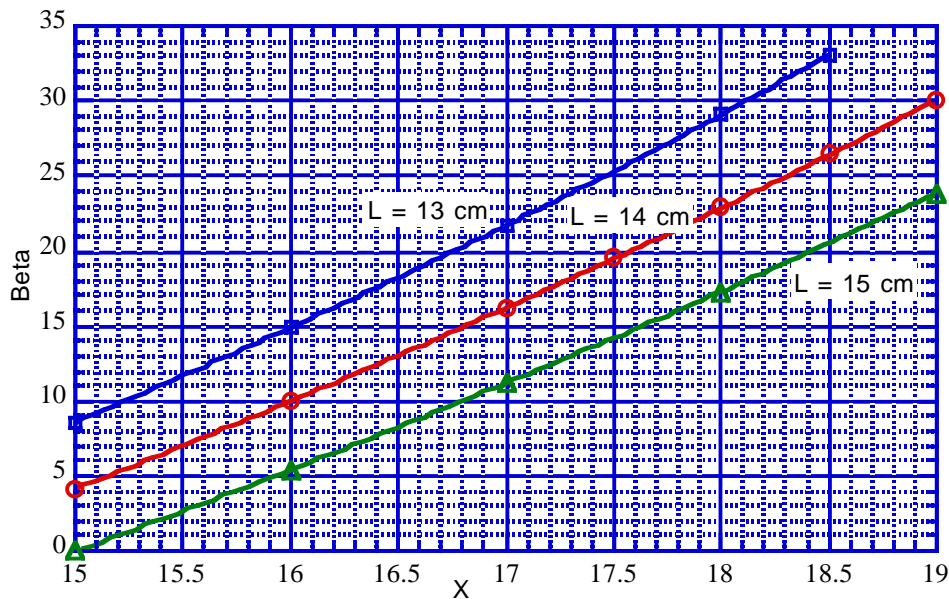

Figure A5 Plot of Eqn 3 for L = 13, 14 and 15 cm.

which means there is an asymmetry of plus or minus 1.6 degrees when the holder is flipped. The ground side of the blade oriented away from the knob has the larger angle by an amount of around 3.2 degrees.

Equation 1 applied to ceramic wheels

The theoretical values of β predicted by equation 1 were checked by measuring β with the laser goniometer. It was found that the predictions were 7 degrees low when the various variables were changed. Hence the corrected equation 3 gives an excellent prediction for the actual angles formed. It was thought that perhaps a systematic error in

$$\beta = \arccos\left(\frac{R^2 + L^2 - Y^2 - h^2}{2 \cdot R \cdot L}\right) - 83 \quad \text{Eqn. 3}$$

measuring the input parameters might be responsible for this discrepancy. However, calculations that examined possible systematic errors did not reveal this to be the case. Eqn. 3 was found to give an excellent estimate of the β angle formed for given sets of the controllable parameters. Figure A5 presents the results of Eqn. 3 in a useful plot for the case of 3 convenient values of L, 13, 14 and 15 cm.

Leather Honing Wheel

Equation 1 can also be used to calculate the β angle for honing on the leather wheel. In this case it was not possible to check the actual hone angle with the laser because the soft action of the leather honing wheel will not change the original ground β angle. However, it was possible to estimate the β angle using the jig provided by Tormek for estimating the grind angle. The jig is positioned on the blade and the leather wheel for a given setting of X and L and gives an estimate of the β angle. The geometry of the setup for the leather honing wheel is shown in Fig. A6. For this case the parameters measured out as:

$$h = X + 81.6 \text{ mm}$$

$$Y = 45.5 \text{ mm}$$

These parameters can be inserted into Eqn. 1 to give β as a function of X. When this was done and comparison was made to the values of β measured with the jig it was found that the values of β were too small by around 2 degrees. Therefore Eqn 1 was modified accordingly to the form:

$$\beta = \arccos((R^2 + L^2 - Y^2 - h^2)/(2 * R * L)) - 88 \text{ Eqn. 4.}$$

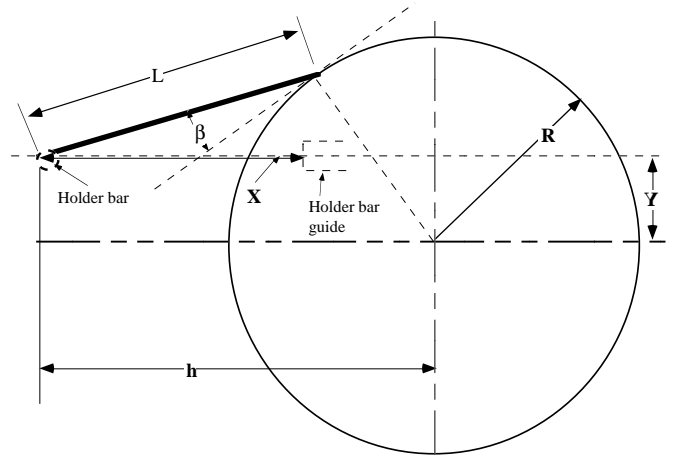

Figure A6 Geometry for the Tormek leather wheel

A plot of this equation using the above leather wheel values for h and Y are shown in Fig. A7 along with the actual β values measured with the Tormek angle measuring jig. The data labeled Cor Rog is that calculated from Eqn. 4, and the data labeled Measured is for that measured with the Tormek angle measuring jig. It is seen that fairly good agreement is obtained.

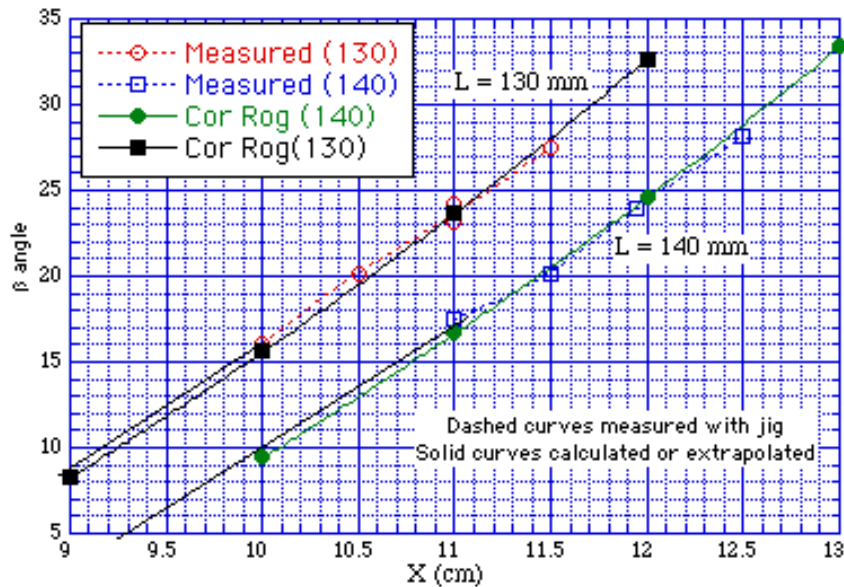

Figure A7 The beta angle for the leather wheel

One of the limitations of the Tormek angle jig is that it cannot be used for β values less than 15 degrees. Therefore the plots of Fig. A7 are quite useful for extrapolating down to values of less than 15 degrees.

After grinding a blade on the ceramic wheel the asymmetry in the β angle must be accounted for when setting up the blade to be honed on the leather wheel. Generally it is desired to have the angle a bit larger on the leather wheel. Calling this increase in angle the overangle, OA, it is desirable to have it be the same on both of the ground faces. Hence, one must be sure to clamp the blade in the holder using the same orientation as

employed for the initial grind on the ceramic wheel. It is a good idea to mark the blade face oriented toward the knob on the initial ceramic wheel grind to avoid problems here.

Effect of curvature of grinding wheel on the grind angle, β

As discussed above the hollow ground effect produced by a circular grinding wheel will cause a decrease in the edge angle below the average grind angle, which is being called β in this appendix. This effect can be explained with the aid of Fig. A8. If the blade in this sketch were ground on a flat stone the ground surface of the blade would lie along the dashed horizontal line as shown in the figure. The angle at the ground edge would be given as β . It is apparent that the curvature of a grinding wheel, shown here with a radius of $D/2$, would cause the edge angle to be decreased by the amount of $\Delta\beta$ shown on the figure. One can see from the diagram, that as the blade thickness T becomes smaller the value of $\Delta\beta$ becomes smaller, but as the diameter of the grinding wheel becomes smaller the value of $\Delta\beta$ becomes larger. It is a relatively simple geometry problem to show that $\Delta\beta$ is related to the blade thickness, T , and grinding wheel diameter, D , as,

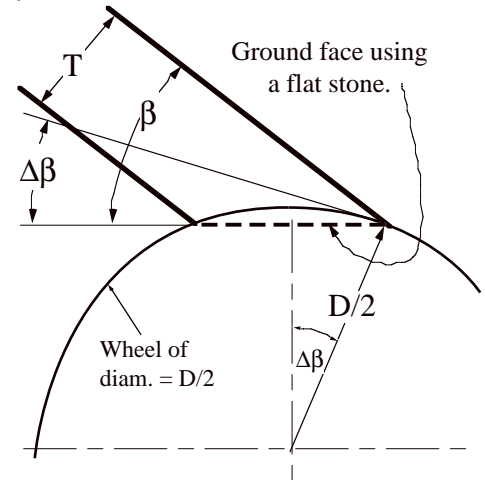

Figure A8 Reduction of edge angle β due to curvature of the grinding wheel.

$$\Delta\beta = \arcsine [T/(D \times \sin(\beta))] \quad \text{Eqn 5}$$

The predictions of this equation are shown in Fig. A9 for the 10 inch Tormek ceramic wheels on blades having thicknesses of $T = 1/8, 1/4$ and $1/2$ inches.

It is seen that the values of $\Delta\beta$ become fairly significant for common grinding conditions used on chisels, with β angles of 20 to 40 degrees and blade thicknesses of $1/8$ to $1/4$ inch. However, if such chisels are finish-honed on a flat stone, as is commonly done with hollow ground chisels [1,3], the edge angle is returned to the value of β .

In the knife sharpening experiments done here with the Tormek machine the final β angle was ground on blades with a previous α grind. The values of α are shown in Figs. 5 and 6. Hence the β grind extended back from the edge only a very small distance and the effective thickness of the blade contacting the wheel at this point was never more than 0.1 mm. Under these conditions the value of $\Delta\beta$ was less than 0.1 degrees, a negligible amount.

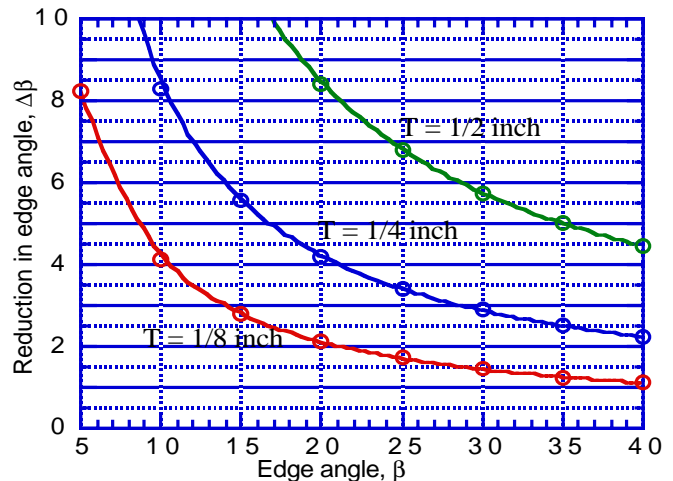

Figure A9 Reduction in edge angle due to wheel curvature for a 10 inch wheel. T = blade (chisel) thickness.

Appendix 3 The Tru Hone Sharpening Machine

The second machine used to sharpen blades in this study was the Tru Hone machine manufactured by the Tru Hone Corp. in Ocala FL. Figure A10 presents a picture of the machine with a special bladeholder attachment made in the Mechanical Engineering shop at Iowa State University to fit the top of the machine. The machine employs 2 sets of interpenetrating wheels located at the front of Fig. A10. Figure A11 presents a front view of the 4 wheels at the left and a top view at the right. As shown at the left the wheels rotate into the knife edge. There is a plastic cover over the wheels that has been removed to clearly show the wheels in Fig. A10. The cover contains a trough that allows the wheels to run wet if desired. Four aluminum oxide wheels, 100, 220, 400 and 600 grit were all used dry. A ceramic 1000 grit wheel of slightly reduced diameter

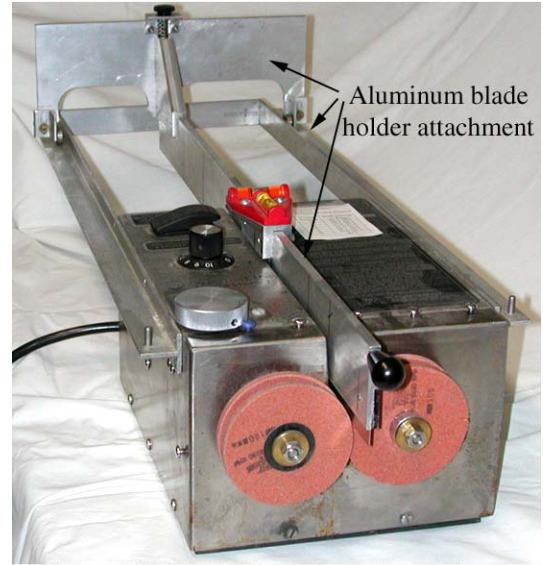

Figure A10 The TruHone sharpening machine with special attachment for grinding thin blades.

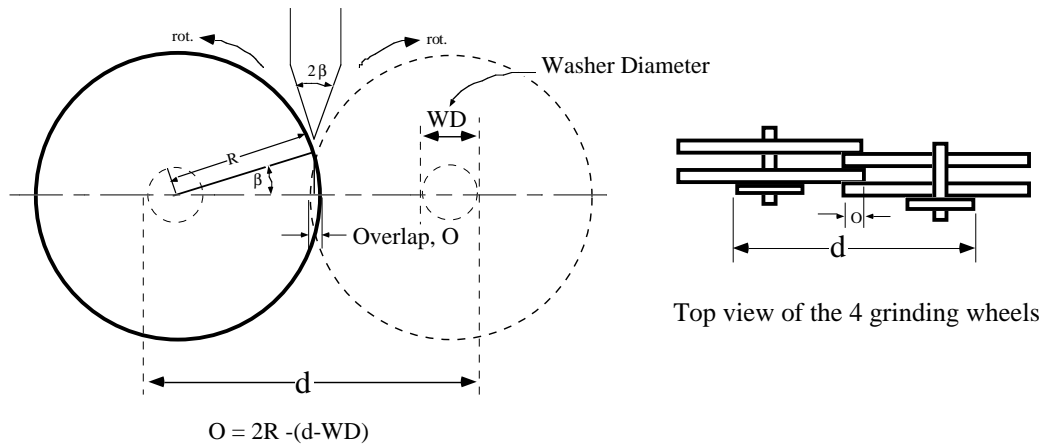

Figure A11 Geometrical relationship between wheel overlap, O , and the tip angle 2β .

was run wet in a water solution supplied by Tru Hone for use with this wheel. Performance was improved by the use of the liquid. Machine adjustments allow variation of the rotation speed and the distance between the wheels. Four of the 3.8 inch long SS blades could be held in the holder and sharpened in the same operation. The holder has a vertical adjustment at the far end which ensures horizontal alignment of the holder bar, measured with a level at the top center of the bar.

Figure A11 at the left shows that the 2β angle ground onto the blade edge depends on the amount of the overlap, O , between the wheels. A brass clamping washer is used on the outer side of the grinding wheels. It is possible to measure the washer diameters, WD , and the distance between these washers, d , accurately with a digital caliper. The diameter of the grinding wheels, $2R$, may also be measure accurately with a digital caliper. Knowing these dimensions one can then calculate a theoretical value for the

grind angle 2β , by combining the equations shown on the lower left of Figs. A11 and bottom of A12. One obtains the result listed here as Eqn. 6.

$$2\beta = 2 \text{ arc cosine } [(d-WD)/2R] \quad \text{Eqn. 6}$$

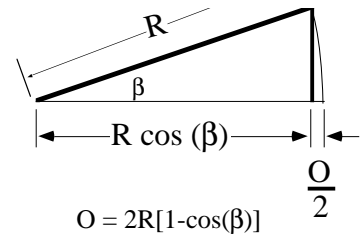

Figure A12 Relation of overlap, O to angle β and radius R of wheels.

Because there is a small but significant difference in the wheel diameters for each of the various grit wheels, the calculation has to be made for each type of wheel.

Experiments were done which systematically varied the overlap of the wheels and then measured the actual 2β angles achieved on grinding, and compared this to the predictions of the equation. The initial study was done on the T edges of stainless blades shown in Fig. 5. The pre-ground edges were reground with the 220 grit wheel using 5 passes per blade. The blades were then sectioned on a water cooled cut-off wheel and 2 sections from the center portion of each blade were mounted

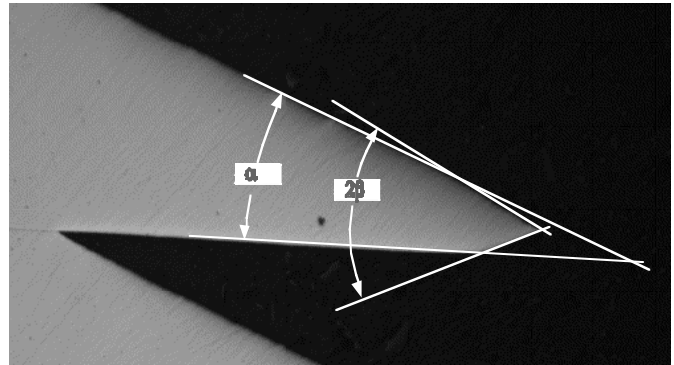

Figure A13 Measurements made on T edges (Fig. 5) of stainless steel blades.

in standard metallographic plastic mounts and polished through 6 micron diamond. Digital images were then taken of the sections and these were examined with a graphical software program to determine the α and β angles shown on Fig. A13. Experiments were done at 5 different overlap settings varying from roughly positions 1 to 5 on the control wheel of the machine. The average value of the α angle was found to range from 16.6 to 17.1 degrees, and the average value of the β half angle was found to vary with the overlap as shown on Fig. A14. At first glance the abrupt drop of the measured β angle below the theoretical value that occurs at around 18 degrees is puzzling. Remember, however, that the measured α angle of these blades is around 17° , which is probably just a bit smaller than the pre-ground α angle on the blades. When one sets the β angle below the original α angle, one wheel is then grinding along the entire length of the original α face of the blade. This will greatly reduce the rate at which the tip angle will change, and it is reasonable to expect that with only 5 grinding passes the tip angle would fall below the theoretical value because there was not enough grinding done to change the angle to the theoretical value. These results show an interesting practical point, which is perhaps obvious after more careful consideration. If one is simply trying to re-sharpen the T edge of one of these stainless blades the overlap should be set to have β either match the original α angle or to be just slightly larger than this angle.

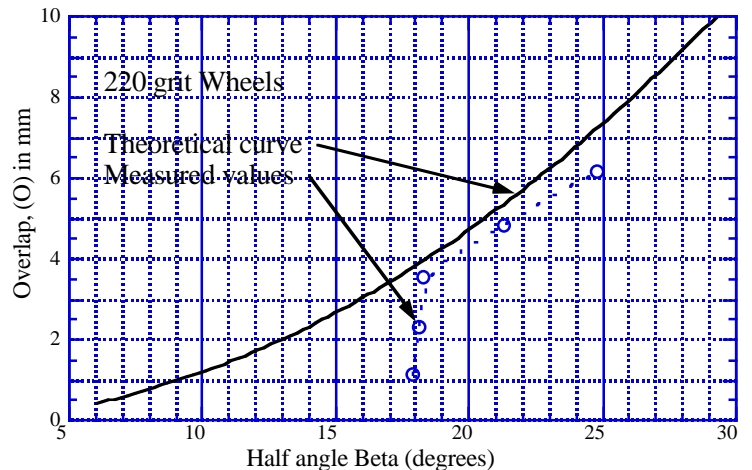

Figure A14 Comparison of calculated and measured values of β angle on T edges of SS blades

To overcome this problem with grinding rate dependent on the angle of a pre-ground surface, experiments were done in which an edge was ground on the non-sharpened side of the stainless blades, shown as the A edge of Fig. 1. These edges were ground with 100 grit wheels and around 150 passes were required to produce a fully ground edge. Four overlap values, O , were used and the blades were sectioned, mounted and polished as above and average values of the tip angle were measured and are presented in Fig. A15. It was found that the measured and calculated angles deviated by roughly a constant amount over the entire range of measurements. The results show that the change in the calculated angles with change in overlap is a close match to the measured data, but that the actual tip angle values appear to be consistently lower than the calculated values by around 0.8 to 1.2 degrees. This final result shows that the measured tip angles agree with the calculated values fairly closely. Hence, the equation for calculating the tip angle provides a good estimate, provided one grinds the blades adequately.

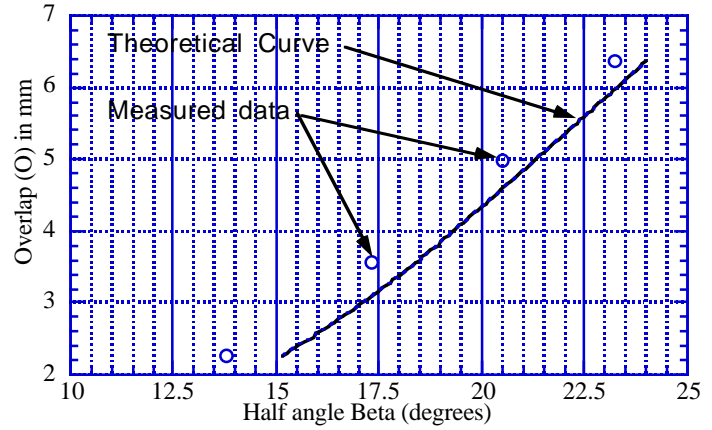

Figure A15 Comparison of calculated and measure β angles on A edge of SS blades.

In several of the experiments done with the Tru Hone machine the final 2β grind was done with an angle slightly increased from the subsequent grind to insure that the final grind was restricted only to the final sharpened edge. This was always done when using the 1000 grit wheels for the final grind. Because the 1000 grit wheels have a significantly smaller wheel diameter, and because the wheels had to be interchanged prior to this final treatment, the equation for calculating tip angle proved very helpful. The desired increase in tip angle was used to calculate the required distance between wheels, i.e., the d dimension. Examination of the ground tips in the SEM showed that setting the overlap this way was very effective in providing a small increase in tip angle, so that only the tip region was ground in the final operation.

Figure A16 presents the calculation for the reduction in edge angle (Eqn. 5, page 52) with the 3 inch diameter wheels used on the Tru Hone machine. The $T = 0.68$ mm curve should apply to the SS blades for the A edges. Hence the edge angle in these blades ground to a 2β angle of 40° would be reduced by around 3° . The $T = 0.1$ mm curve gives the maximum reduction expected on grinding blades with a pre-existing α bevel, the T edges. The values are expected to be only a fraction of a degree.

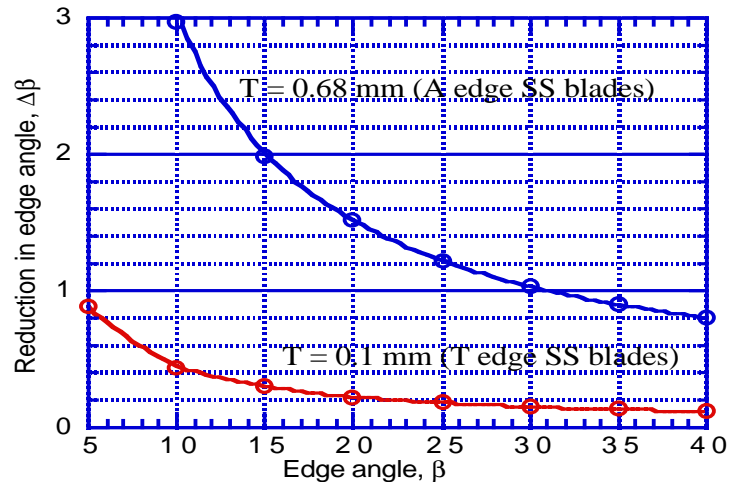

Figure A16 Reduction in edge angle due to wheel curvature for a 3 inch wheel.