

**SPECIFIC OPERATIONS**

**VOLUME 2**

**ARCTIC AND SUB-ARCTIC OPERATIONS**

**PART 1**

**BASIC COLD WEATHER TRAINING**

**STOCK REPRINT:** All changes incorporated up to and including change 1  
dated 1982-08-04

**THIS PUBLICATION CONTAINS CLASSIFIED INFORMATION  
AFFECTING THE DEFENCE OF CANADA, AND SHALL BE  
PROTECTED IN ACCORDANCE, WITH THE REGULATIONS  
PRESCRIBED FOR THE SECURITY CLASSIFICATION APPEARING  
HEREON, RELEASE OF THIS PUBLICATION, OR INFORMATION  
CONTAINED HEREIN, TO ANY PERSON NOT AUTHORIZED TO  
RECEIVE IT, IS PROHIBITED BY THE OFFICIAL SECRETS ACT.**

**Issued on authority of the Chief of the Defence Staff**

**OPI: FMC**

**1974-03-15**  
**Ch 1 - 1982-08-04**

## LIST OF EFFECTIVE PAGES

Insert latest changed pages; dispose of superseded pages in accordance with applicable orders.

This change includes the new NDID number. Holders are required to amend the remaining pages of the publication to reflect the new number.

NOTE - On a changed page, the portion of the text affected by the latest change is indicated by a vertical line in the margin of the page. Changes to illustrations are indicated by miniature pointing hands, or black vertical lines.

Total number of pages in this publication is 287 consisting of the following:

Page No.	Change No.	Page No.	Change No.
Title Page	1	2-49 to 2-90	1
A	1	3-1 to 3-43	0
i/ii	1	4-1 to 4-22	0
iii to xv/xvi	1	5-1 to 5-46	0
1-1, 1-2	0	6-1 to 6-21	0
1-3 to 1-6A/1-6B	1	7-1 to 7-18	0
1-7, 1-8	0	A-1, A-2	0
2-1 to 2-6	0	B-1 to B-4	0
2-7, 2-8	1	C-1 to C-9	0
2-9 to 2-48	00	D-1 to D-6	0
		E-1/E-2	1

Zero in Change No. column indicates an original page.

## **FOREWORD**

15 March 1974

1. B-GG-302-002/FP-001 Specific Operations, Volume 2, Arctic and Sub-arctic Operations, Part 1 - Basic Cold Weather Training, is issued on authority of the Chief of the Defence Staff.
2. This manual is effective on receipt and supersedes CFP 302(2) Part 1 dated 28 February 1971.
3. Any loss or suspected compromise of this publication, or portions thereof, should be reported in accordance with A-SJ-100-001/AS-000, Chapter 34.
4. Suggestions for amendments shall be forwarded through normal channels to Headquarters Mobile Command, Attention SSO CD Coord.

## **TABLE OF CONTENTS**

### **CHAPTER 1 - INTRODUCTION**

#### **SECTION 1 - GENERAL**

101	Aim
102	Scope
103	Areas of Winter Operations
104	(Not Allocated)

#### **SECTION 2 - INTRODUCTION TO COLD**

105	General
106	Types of Cold
107	Windchill
108	Effects of Cold on Man
109	Adjustments
110	Leadership Requirements
111	Conclusion

### **CHAPTER 2 - PERSONAL CLOTHING AND EQUIPMENT**

#### **SECTION 1 - COLD WEATHER CLOTHING**

201	General
202	Principles of Clothing Design
203	Footwear
204	Principles of Keeping Warm
205	Military Requirements of Cold Weather Clothing
206	Types of Military Clothing
207	General
208	Sleeping Bag - 1951 Pattern
209	Sleeping Bag - 1965 Pattern
210	General
211	Description
212	Assembly - Attachment of Strap Components to the Frame
213	Packing
314	Adjustment
215	Camouflage
216	Care and Maintenance
217	Conclusion

## **SECTION 4 - LANTERN COLEMAN**

- 218 General
- 219 Description
- 220 Stripping, Assembly, and User Repairs
- 221 Operation
- 222 Light Discipline
- 223 Care and Maintenance
- 224 Safety Precautions
- 225 Common Faults and Remedies
- 226 Conclusion

## **SECTION 5 - STOVES M1950 C1B1 AND COLEMAN MODEL 431 TWO BURNER**

- 227 General
- 228 M1950 Stove
- 229 Description
- 230 Stripping and Assembling
- 231 Common Faults, Stoppages, and Remedies
- 232 Filling
- 233 Lighting
- 234 Stove C1B1
- 235 Description
- 236 Stripping and Assembly
- 237 Common Faults, Stoppages, and Remedies
- 238 Filling
- 239 To Pump
- 240 Lighting
- 241 Care and Maintenance
- 242 Stove Coleman Model 431 - Two Burner Stove
- 243 Description
- 244 Stripping and Assembly
- 245 Common Faults, Stoppages and Remedies
- 246 Filling
- 247 To Pump
- 248 To Install Tank
- 249 To Light Main Burner
- 250 To Light Auxiliary Burner(s)
- 251 To Shut Off Burners
- 252 To Pack Stove
- 253 Care and Maintenance
- 254 Safety Precautions - All Stoves
- 255 Conclusion

## **SECTION 6 - TOBOGGANS**

256	General
257	Loading
258	One-man Toboggan
259	Two-man Toboggan
260	Conclusion

## **CHAPTER 3 - CAMPSITES, SHELTERS, AND TENTAGE**

### **SECTION 1 - SELECTING A CAMPSITE AND BIVOUAC ROUTINE**

301	General
302	Selection of a Defensive Position
303	Campsites
304	Entering a Campsite
305	Establishing a Campsite
306	Collecting Ice or Snow for Cooking
307	Constructing a Latrine
308	Digging a Garbage Pit
309	Camp Routine
310	Duties of Tent Group Commander
311	Duties of Cook
312	Preparation of Rations
313	Bedding Down
314	Position of Air Mattress
315	Responsibilities
316	Security
317	Breaking Camp
318	Conclusion

### **SECTION 2 - INSPECTION, PREPARATION AND STOWAGE OF TENTS**

319	General
320	Description
321	Inspection of Outer Tent
322	Assembling the Tent
323	Stowage of Tents
324	Folding for Toboggan
325	Conclusion

### **SECTION 3 - PITCHING AND STRIKING TENTAGE**

326	General
327	Tent Pitching and Striking Squad
328	Duties of Tent Pitching Squad
329	Tent Pitching Drill
330	Method
331	Striking Drill
332	Conclusion

### **SECTION 4 - IMPROVISED SHELTER**

333	General
334	Siting of Shelters
335	Areas for Shelters
336	Building
337	Types of Shelters
338	Shelters in Wooded Areas
339	Double Lean-to
340	Wigwam
341	Tree-pit Shelter
342	Chopped or Fallen Tree Shelter
343	Shelters in Open Country and Barrens
344	Conclusion

## **CHAPTER 4 - WEAPONS AND FIELD WORKS**

### **SECTION 1 - SMALL ARMS AND AMMUNITION**

401	General
402	Weapon Problems
403	Care and Maintenance of Weapons
404	Condensation
405	Snow and Ice
406	Weapon Mechanisms
407	Breakages
408	Cold Weather Handwear
409	Ice Fog
410	Weapon Cleaning General
411	Weapon Platforms
412	Ammunition
413	Conclusion

## **SECTION 2 - FIRING POSITION IN SNOW CONDITIONS**

- 414 General
- 415 Small Arms
- 416 Method
- 417 Support Weapons
- 418 Methods
- 419 Conclusion

## **SECTION 3 - FIELD DEFENCES**

- 420 General
- 421 Penetration Table
- 422 Walls and Forms (Frameworks)
- 423 Snow Defences
- 424 Ice-crete Defences
- 425 Ice-crete and Snow Defences
- 426 Other Types of Defences
- 427 Additional Points
- 428 Conclusion

## **CHAPTER 5 - MOVEMENT**

### **SECTION 1 - LAND NAVIGATION**

- 501 General
- 502 Navigation Problems
- 503 Methods of Land Navigation
- 504 Navigation by Dead Reckoning
- 505 Method of Dead Reckoning
- 506 Distance Measuring
- 507 Direction
- 508 Hints for the Navigator
- 509 Conclusion

### **SECTION 2 - MARCH DISCIPLINE**

- 510 General
- 511 Before the March
- 512 During the March
- 513 End of March
- 514 Conclusion



### **SECTION 3 - TRAIL-BREAKING**

515	General
516	Planning
517	Navigation
518	Route Selection
519	Composition
520	Organization
521	Trail Marking
522	Conclusion
(523)	not allocated

### **SECTION 4 - SKIING AND SNOWSHOEING**

524	General
525	Characteristics of Snow
526	Ski Techniques
527	Walking Step
528	Step Turn
529	Kick Turn
530	Falling and Recovery
531	One Step
532	Variations
535	Downhill Running
536	Braking Methods
537	Turns
538	Skiing over Variable Terrain
539	Ski-joring
540	Ski Drill
541	Snowshoeing
542	Types
543	Maintenance
544	Snowshoe Harness
545	Training and Rate of Movement
546	Snowshoe Technique

## **CHAPTER 6 - TACTICS**

### **SECTION 1 - GENERAL**

601	Introduction
602	Concept of Operations - Arctic
603	Concept of Operations - Subarctic

## **SECTION 2 - BASIC PLANNING AND OPERATIONS**

- 604 Winter Problems
- 605 Standard of Training
- 606 Planning
- 607 Fire Support
- 608 The Advance
- 609 The Attack
- 610 The Defence
- 611 Patrolling
- 612 Conclusion

## **SECTION 3 - CAMOUFLAGE AND CONCEALMENT**

- 613 General
- 614 Individual Concealment
- 615 Equipment Concealment
- 616 Field Defences
- 617 Tracks and Trails
- 618 Light Discipline
- 619 Vapour Clouds
- 620 Noise Level
- 621 Deception
- 622 Examples of Vehicle Camouflaged
- 623 Formula of Paint Used

## **CHAPTER 7 - COLD WEATHER INJURIES AND HEALTH RULES**

### **SECTION 1 - FIRST AID**

- 701 General
- 702 Shock
- 703 Frost-bite
- 704 Advanced Cold Exposure
- 705 Snow Blindness
- 706 Immersion Foot (Trenchfoot)
- 707 Sunburn and Wind Chapping
- 708 Carbon Monoxide Poisoning
- 709 Fume Irritation (Tent Eye)
- 710 Constipation
- 711 Dehydration
- 712 Casualty Bag
- 713 Casualty Evacuation by Toboggan

## **SECTION 2 - HEALTH RULES**

- 714 General
- 715 Individual Adjustment
- 716 Personal Hygiene
- 717 Food
- 718 Latrines and Garbage
- 719 Conclusion

## **ANNEXES**

- A SUGGESTED FORMATIONS IN THE ADVANCE**
- B NOTES ON ICE CROSSINGS**
- C THEORY AND USES OF THE ASTRO COMPASS**
- D MAINTENANCE UNDER WINTER CONDITIONS**
- E REFERENCES**

## LIST OF FIGURES

FIGURE	TITLE
--------	-------

### CHAPTER 1 - INTRODUCTION TO WINTER WARFARE

1-1	Geographical Division Between the Arctic and the Subarctic Environments
1-2	Windchill Graph
1-3	Danger from Freezing Exposed Flesh

### CHAPTER 2 - PERSONAL CLOTHING AND EQUIPMENT

2-1	Cap, Knitted (Toque) - Cold Weather
2-1A	Face Mask - Cold Weather
2-1B	Extreme Cold Weather Undershirt
2-1C	Extreme Cold Weather Drawers
2-1D	Shirt-coat and Trousers Light-weight
2-1E	Coat and Trousers General Service
2-1F	Liner Coat General Service
2-1G	Parka Combat and Windpants
2-1H	Mukluk
2-1J	Caps Combat
2-1K	Outer Garments and Rucksack
2-1L	Trousers for AFV Crew
2-1M	Jacket for AFV Crew
2-2	Bag, Sleeping, Cold Weather Complete with Hood and Liner
2-2A	Bag, Sleeping, Cold Weather Complete with Hood and Liner
2-2B	Bag, Sleeping, Cold Weather Complete with Hood and Liner
2-2C	Sleeping Bag - Container
2-3	Rucksack, Universal, C1
2-3A	Frame and Shelf, Cargo Carrying
2-3B	Straps Rucksack, Universal, C1
2-4	Assembly
2-4A	Assembly
2-4B	Assembly
2-4C	Assembly
2-4D	Assembly
2-4E	Assembly
2-4F	Assembly
2-4G	Assembly
2-4H	Assembly
2-4J	Assembly
2-4K	Assembly
2-4M	Assembly
2-4N	Rucksack with Frame (Front View)
2-4P	Rucksack with Frame (Rear View)

2-4Q	Rucksack Complete with Frame and Sleeping Bag
2-4R	Thermos Bottle
2-4S	Thermos Bottle and Insulating Cover
2-5	Packboard Assembly
2-5A	Packboard Assembly
2-6	Coleman Lantern
2-6A	Coleman Lantern 621B
2-6B	Coleman Lantern 621B
2-7	Stove M1950
2-7A	Stove M1950
2-8	Stove C1B1
2-8A	Stove C1B1
2-8B	Stove Coleman Model 431 Two Burner
2-8C	Stove Coleman Model 431 Two Burner
2-9	One-Man Toboggan
2-9A	One-Man Toboggan
2-10	A Properly Lashed Toboggan
2-10A	Suggested Toboggan Load
2-11	The Whippetree Method of Lashing Toboggans Together

### **CHAPTER 3 - CAMPSITES, SHELTERS AND TENTAGE**

3-1	Use of Camouflage and Deception in a Campsite Area
3-2	Selection of Route when Entering a Bivouac in a Forest
3-3	Layout of Five-Man Tent
3-4	Layout of Ten-Man Tent
3-4A	Ten-Man Tent
3-5	Guys and Tie-downs
3-6	(Not Allocated)
3-7	Single Lean-to - Stage 1
3-8	Single Lean-to - Stage 2
3-9	Single Lean-to Side View - Stage 3
3-10	Fire Base and Log Fire
3-11	Log Reflectors
3-12	Double Lean-to
3-13	Wigwam Shelter with Reflector Wall
3-14	Tree-pit Shelter
3-15	Chopped or Fallen Tree Shelter with Fire and Log Reflector
3-16	Tent Roof Shelter - Stage 1
3-17	Tent Roof Shelter - Stage 2
3-18	Tent Roof Shelter - Stage 3
3-19	Tent Roof Shelter - Stage 4
3-20	Snow Trenches
3-21	Cross Section of Snow Trench
3-22	Snow House - Stage 2
3-23	Snow House - Stage 3

- 3-24 Sleeping Behind Snow Wall
- 3-25 Snow Cave

## **CHAPTER 4 - WEAPONS AND FIELD WORKS**

- 4-1 Weapon Platform
- 4-2 Weapon Platform
- 4-3 Prone Position in Soft Snow
- 4-4 Prone Position Using Snowshoe as a Weapon Platform
- 4-5 Prone Position Using Skis
- 4-6 Kneeling Position on Snowshoes
- 4-7 Kneeling Position on Skis Using Poles as Weapon Support
- 4-8 Kneeling Position on Skis Using Poles as Weapon Support
- 4-9 Standing Position on Skis Using Poles as Weapon Support
- 4-10 Standing Position on Skis Using Poles as Weapon Support
- 4-11 Machine-gun Mounted on a Toboggan
- 4-12 Snow Defences - Type 1
- 4-13 Snow Defences - Type 2
- 4-14 Snow Defences - Type 3
- 4-15 Ice-crete Defences - Type 1
- 4-16 Ice-crete Defences - Type 2
- 4-17 Ice-crete Defences - Notched Log - Type 3
- 4-18 Ice-crete and Snow Defences - Wall Building
- 4-19 Snow Trench

## **CHAPTER 5 - MOVEMENT**

- 5-1 Route Card or Log
- 5-2 The Issued Pedometer
- 5-3 Organization of Trail-breaking Section
- 5-4 Breaking a Multiple Trail
- 5-5 Breaking a Triple Track
- 5-6 Ski and Touring Pole
- 5-7 Binding - Ski - Universal
- 5-7A Ski Binding
- 5-7B Ski Binding - Mounting Instructions
- 5-8 Repair kit - ski
- 5-8A Items of Ski Repair Kit
- 5-9 Step Turn Using the Heels as a Pivot
- 5-10 Step Turn Using the Tips as a Pivot
- 5-11 The Kick Turn
- 5-12 Herringbone
- 5-13 Half-Herringbone
- 5-14 The Snowplow
- 5-15 The Half-Snowplow
- 5-16 Trail Snowshoe

- 5-17 Snowshoe Harness
- 5-18 Attaching Harness to Snowshoe, Step 1
- 5-19 Attaching Harness to Snowshoe, Step 2
- 5-20 Attaching Harness to Snowshoe, Step 3
- 5-21 Attaching Harness to Snowshoe, Step 4
- 5-22 Attaching Harness to Boot, Step 1
- 5-23 Attaching Harness to Boot, Step 2

## **CHAPTER 6 - TACTICS**

- 6-1 Heavy Forested Areas
- 6-2 Low Patchy Bush or Light Scrub Area
- 6-3 Open Snow Covered Areas with Dark Woods in the Background
- 6-4 Open Snow Covered Areas with Dark Woods in the Background
- 6-5 Open Snow Country
- 6-6 Open Snow Country
- 6-7 Tent in Thin or Scattered Tree Cover - Before
- 6-8 Tent in Thin or Scattered Tree Cover - After
- 6-9 Tent in Thin or Scattered Tree Cover with Net
- 6-10 Deception Area Showing Trails and Bivouac Area
- 6-11 Dummy Oversnow Vehicle
- 6-12 Example of Ice Fog Caused by 90 mm Gun
- 6-13 Example of Camouflaged Vehicle
- 6-14 Example of Camouflaged Vehicle
- 6-15 Example of Camouflaged Vehicle
- 6-16 Example of Camouflaged Vehicle

## **CHAPTER 7 - COLD WEATHER INJURIES AND HEALTH RULES**

- 7-1 Superficial Frost-bite
- 7-2 Deep Frost-bite
- 7-3 Deep Frost-bite
- 7-4 Casualty Bag
- 7-5 Casualty Bag
- 7-6 Casualty Bag
- 7-7 Casualty Bag
- 7-8 Casualty Evacuation - Toboggan
- 7-9 Casualty Evacuation - Toboggan

## **ANNEX C - THEORY AND USES OF THE ASTRO COMPASS**

- C-1 Astro Compass

## CHAPTER 1

### INTRODUCTION

#### SECTION 1 - GENERAL

##### 101. Aim

The aim of this part of the manual on arctic and subarctic operations is to describe in detail the drills and training required for the individual soldier and infantry section to operate in winter.

##### 102. Scope

1. The scope includes information on personal clothing and equipment; campsites, shelters and tentage; weapons and the construction of field works; movement; cold weather injuries and health rules; and section and platoon tactics for winter operations.
2. The information given has been primarily written for use by instructors involved in cold weather training.

##### 103. Areas of Winter Operations

1. The arctic, subarctic, and the cold temperate regions of the Northern Hemisphere all have a winter season of varying length and intensity. Part 11 of this manual, Unit and Formation Tactics, describes the terrain and climate of the arctic and subarctic environments. Figure 1-1 shows the geographical division between the arctic and subarctic regions. These two regions include most of Canada, Alaska, and Northern Europe; the major winter operational zones for Canadian Forces.
2. A clear differentiation is made for operational and training purposes in all parts of CFP 302(2), Arctic and Subarctic Operations, between arctic and subarctic operations. These differences are discussed in detail in Part II of the manual. Generally, the absence of trees and low amount of precipitation set off the arctic from the subarctic environment. The latter is the home of most of the coniferous forest of North America and Eurasia. The cold temperate region is south of the subarctic and includes areas such as the Maritime Provinces, Southern Ontario and Quebec, parts of the prairies, coastal areas of British Columbia, and most of the Central European area. For purposes of teaching basic cold weather skills there is no requirement to differentiate between the subarctic and cold temperate regions.



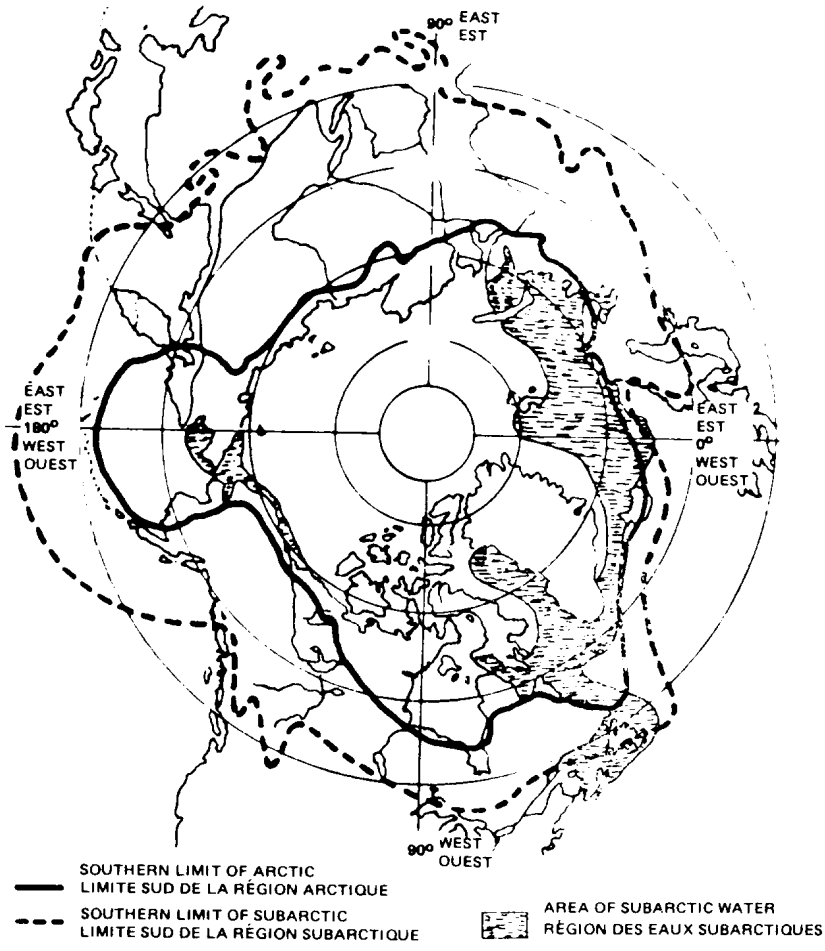

Figure 1-1 Geographical Division Between the Arctic and Subarctic Environments

(104: not allocated)

## SECTION 2 - INTRODUCTION TO COLD

### 105. General

1. A study of man's military history in northern areas leads to one basic conclusion - his successes and failures are measured in terms of his regard for the dominant characteristic of the North - COLD. As Canadians, we must be prepared to live, move, and fight in winter conditions. To be able to do our job effectively, we must know and understand COLD.

2. From his experience in the cold, man has learned that he who recognizes and respects the forces of the environment can do his job and even use these forces to his advantage. He who disregards or underestimates these forces is doomed to failure, if not destruction.

### 106. Types of Cold

- a. Wet Cold. Wet cold conditions occur when temperatures are near freezing and variations in day and night temperatures cause alternate freezing and thawing. These conditions are also often accompanied by wet snow and rain causing the ground to become slushy and muddy. With these conditions troops require clothing that consists of a waterproof or water-repellent, wind resistant outer layer, and an inner layer with sufficient insulation to provide ample protection in moderately cold weather (above -10EC). Waterproof foot-wear is essential.
- b. Dry Cold. Dry cold conditions occur when average temperatures are lower than -10EC. The ground is usually frozen and the snow dry. These low temperatures plus wind increase the need for protection of the entire body. For these conditions troops require clothing that will provide adequate insulation for the body for windchill factor of -62EC. These inner layers of insulation must be protected by a water-repellent, wind resistant outer layer.

### 107. Windchill

1. We know from our own experience that when a high wind is blowing it feels much colder than when it is calm. Temperature alone does not, therefore, give a true indication of the relative comfort of outdoor activities. Some scale has to be used, based on both temperature and wind, and the most common one is the windchill scale. Human comfort depends on the rate at which heat is lost from the human body. Windchill, which is a measure of the combined effects of wind and temperature, is defined as the number of calories lost during one hour from a square meter of a surface kept at + 33EC (neutral skin temperature).

2. Look at the graph at Figure 1-2. It has been drawn to show a value representing the amount of heat lost for any wind speed and temperature. For example, you will see that a temperature of 7EC and a wind speed of 48 miles per hour produces the same effect as a temperature of -28EC and a wind speed of 5 miles per hour. Both these sets of conditions result in the loss of about 1,400 kilo calories in an Hour and both, therefore, are said to have a windchill factor of about 1400. You will find that other combination of comparatively mild temperatures and high winds produce chilling effects on the body equal to those produced by sub-zero temperatures combined with light winds.

3. The lesson to remember here is that thermometer readings alone will not give you a valid indication of the effects to be expected on the body. With comparatively high temperature and high winds, you must be prepared to protect yourself in the same way you would at much lower temperature readings.

4. Note that the curves of the graph have Such labels as "Bitterly cold", "Exposed flesh freezes, travel and life in temporary shelters becomes disagreeable." The "Key" windchill factors are 1400, 2000, and 2300.

5. As a ready reference, the condition Under which exposed flesh freezes one hour at a windchill factor of 1400 is as follows:

**WIND SPEED**

**TEMPERATURE**

77 km/h (48 mph)	-7EC (20EF)
42 km/h (26 mph)	-9EC (15EF)
29 km/h (18 mph)	-12EC (10EF)
22 km/h (14 mph)	-15EC (5EF)
21 km/h (13 mph)	-18EC (0EF)
14 km/h (9 mph)	-21EC (-5EF)
11 km/h (7 mph)	-25EC (-10EF)
9 km/h (6 mph)	-26EC (-15EF)
8 km/h (5 mph)	-29EC (-20EF)
6 km/h (4 mph)	-32EC (-25EF)
5 km/h (3 mph)	-34EC (-30EF)
3 km/h (2 mph)	-40EC (-35EF)

6. The windchill scale is not strictly applicable as a measure of human comfort because it does not take into account many important factors such as activity, humidity, loss of heat in the breath, radiation from the sun, and the effects of lowered skin temperature. It is, however, a simple and practical guide and shows the condition under which cold weather travel is dangerous, when exposed flesh is likely to freeze, and when special precautions must be taken against the cold. An additional guide is contained in Figure 1-3 which shows equivalent temperatures in relation to the windchill factor.

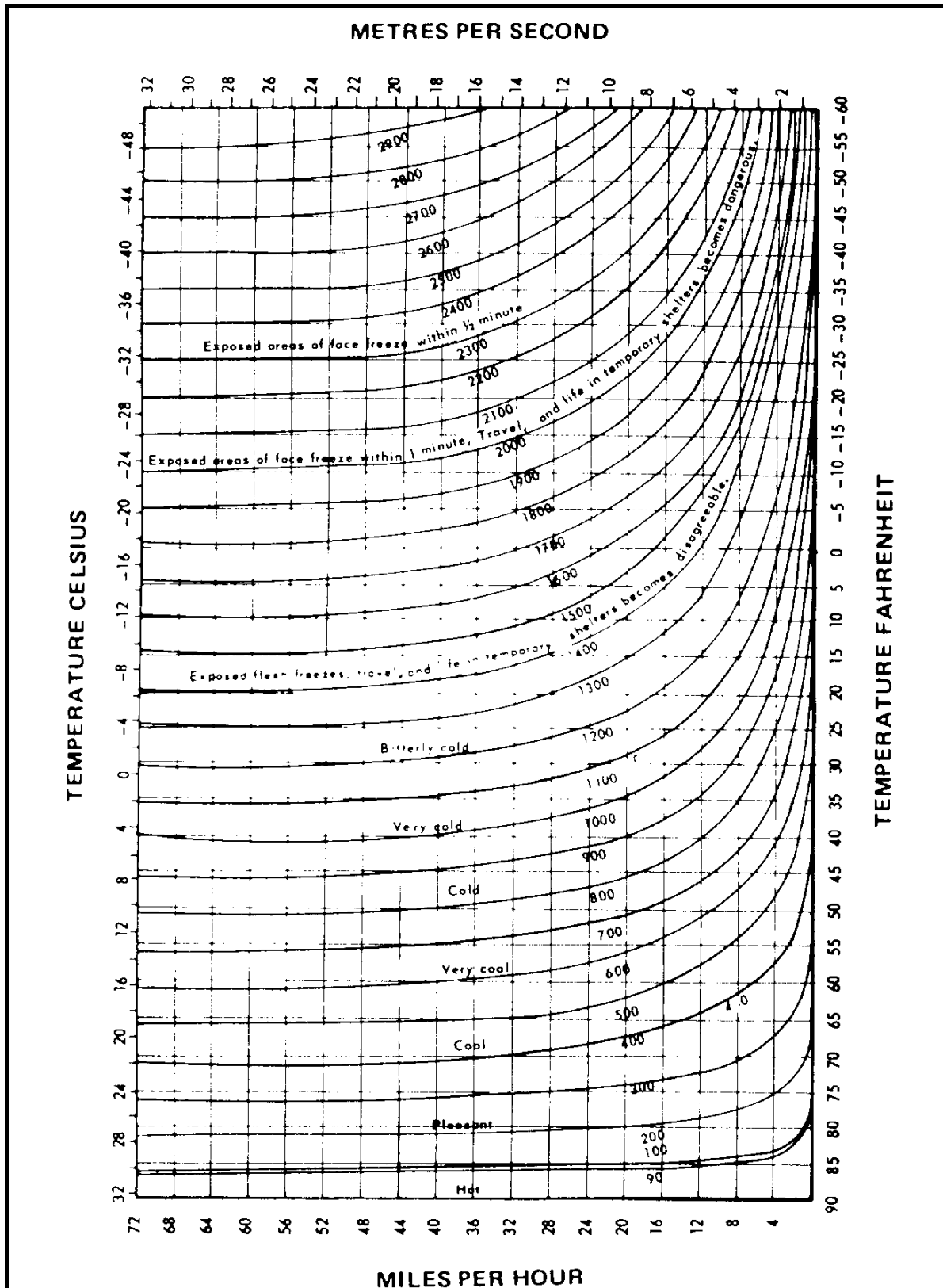

Figure 1-2 Windchill Graph

## **108. Effects of Cold on Man**

1. In extreme cold, a man can become numb and indifferent to nonessential tasks. Essential tasks require more time and effort. It has been repeatedly demonstrated that at temperatures lower than -23EC all other problems and requirements lose significance in man's personal battle for survival.
2. The destructive Influence of cold on the human body falls into two categories; general or local hypothermia (cooling and freezing).
3. General hypothermia is an Injury by cold to the entire body, either by immersion or exposure. Prolonged exposure will result in death.

WINDCHILL FACTOR												
WIND SPEED (Km/h)	LOCAL TEMPERATURE											
	0	-5	10	-15	-20	-25	-30	-35	-40	-45	-50	
	EQUIVALENT TEMPERATURE											
CALM	0	-5	-10	-15	-20	-25	-30	-35	-40	-45	-50	
8	6	7	12	17	-23	-28	-33	-38	-44	-49	-54	
16	-8	-14	20	-26	-32	-38	-44	-51	-56	-63	-68	
24	-11	18	25	-32	-38	-48	-52	-58	-65	-72	-69	
32	-14	-21	28	-36	-42	-49	-57	-64	-71	-74	-78	
40	-16	-23	31	-38	-46	-53	-61	-68	-76	-83	-85	
48	-17	-25	32	-41	-48	-56	-63	-72	-78	-86	-90	
56	-18	-26	34	-42	-49	-57	-65	-73	-81	-88	-94	
64	-19	-27	35	-43	-51	-59	-66	-74	-82	-91	-97	
72	-19	-28	36	-43	-52	-59	-67	-74	-83	-91	-99	
80	-20	-28	36	-44	-53	-60	-68	-76	-84	-92	-100	
LITTLE DANGER FOR PROPERLY CLOTHED PERSONS			CONSIDERABLE DANGER				VERY GREAT DANGER					

Figure 1-3 Danger from Freezing Exposed Flesh

4. Local hypothermia refers to cold injuries to specific areas of the body that destroy tissue and result in gangrene and death unless proper medical care is received. Frostbite (Exposure) and immersion foot are examples.

5. It can generally be expected that exposure to the extremes of cold will aggravate or intensify the effects of any physical disorder with which the man is affected at the time of initial exposure.

## **109. Adjustments**

1. The human body must be protected. To remain functional, it must be kept clean, dry, and reasonably warm with normal body processes maintained. Rest and nourishment are vital.

2. The right approach to cold weather living will go a long way towards keeping you healthy and seeing you through. Here are four basic rules to remember:

- a. Keep in Shape. Cold weather clothing is heavy and you will burn up a lot of energy just walking in the snow. By keeping fit, you will do your job without becoming exhausted. A sleeping man will not freeze unless he is exhausted. A healthy man will awaken long before he reaches the danger point.
- b. Drink Plenty of Water. Because water may be hard to get, you may drink less than you need. Tests show that in cold climates men normally drink only when they are thirsty. This may not give them the water they need and they may become dehydrated. Drink plenty of water to avoid dehydration, and the fatigue which follows.
- c. Eat to Keep Fit. Regular, satisfying hot food is essential for top performance. Even if you are not hungry, eat your fill. If you do not, you will not stay fit very long.
- d. Maintain a Healthy Attitude. You will find yourself up against a lot of new problems - but none that a trained soldier cannot overcome. Keep alert and cheerful, and work hard. This combination will automatically give you the right attitude.

## **110. Leadership Requirements**

In no other part of the world is individual leadership more apparent or important than in the North. The raw nature of man comes quickly to the surface. Unless skilfully guided and led, a man's basic urge for survival may become his most dominant characteristic. Leadership must be by example.

## **111. Conclusion**

Remember. Cold may make our tasks harder and they may take longer to do, but it does not make them impossible. With knowledge, equipment, and training, you can beat the cold.

**(112 to 199 inclusive: not allocated)**



## CHAPTER 2

### PERSONAL CLOTHING AND EQUIPMENT

#### SECTION 1 - COLD WEATHER CLOTHING

##### 201. General

1. The human body can be compared to a constantly running furnace, which, to run efficiently, must always maintain a certain temperature. The food we eat is our fuel and it burns into heat to maintain our normal body temperature. Just as a furnace gives off heat to the surrounding air, so does your body. During cold weather, therefore, when we lose more heat to the surrounding air, we must "wall-in" the heat next to our body, because when heat leaves the body we become cold.
2. Our clothing acts as an insulator, preventing body heat from escaping to the outside air. Some types of clothing are better insulators than others. For example, a woollen sweater is one of the best because air, an excellent insulator, is pocketed in thousands of tiny air cells between the woollen fibres. Another good insulator is fur because air is trapped in the hair and is kept close to the body.
3. Clothing can be added to prevent heat loss; or can be removed to release some of the heat produced during strenuous activity.
4. In very cold weather, especially in high winds, the skin can freeze - even before the rest of the body begins to cool. If bare skin is in contact with cold metals, it cools and freezes very rapidly.
5. In most areas of Canada during the winter months, soldiers must wear special clothing to protect themselves. To get the most out of the special clothing, which has been proved entirely adequate on cold weather exercises, the soldier must understand the principles underlying the design of the clothing and must know how to use it properly.

##### 202. Principles of Clothing Design

1. General. Cold weather clothing must provide insulation and at the same time permit ventilation to prevent overheating.
2. Insulation. Any material that resists the flow of heat is known as an insulating material. Dry air is an excellent insulator, and in addition, is light. Materials that hold quantities of motionless or dead air are the best insulators, eg., wool and fur. The most practical method of insulating the body is to use clothing in the layer method.

## 1. Layer Method

- a. Several layers of medium weight clothing keep you warmer than one heavy garment even if the single heavy garment is as thick as the combined layers. Layers of dead air trapped between the clothing, as well as the minute air pockets within the fibres, resist the passage of your body heat to the outside.
- b. The layers of clothing are of different design, the inner garments being more porous and having many air pockets, and the outer garments are made of windproof water-repellent fabric. The outer garments prevent the outside cold air from displacing your trapped, body-warmed, still air.
- c. Using the layer method you can adjust clothing rapidly for a wide range of temperatures and activities by merely adding or removing a layer of clothing at a time. This permits you to maintain your body heat balance.

4. Ventilation. Cold weather clothing is designed not only to reduce your heat loss but also, by ventilation, to prevent you from becoming overheated. When you are overheated you perspire and this fills the air space with moisture, reducing the insulating qualities of the clothing. Moreover, when perspiration evaporates, it not only robs clothing of its insulating value, but it chills the body.

## 203. Footwear

1. The feet are more vulnerable to cold than are other parts of the body. Cold attacks feet most often because they get wet easily both externally and from perspiration. Footwear, therefore, is one of the most important items of cold weather clothing.
  - a. Principles. The rule of wearing clothing loose and in layers also applies to footwear. The layers are made up by the boot itself and different combinations of socks and insoles. Care must be taken not to restrict circulation. Two or more socks worn too tightly might easily mean freezing of the feet. For the same reason avoid lacing the footwear too tightly. The rules about avoiding overheating and keeping dry are difficult to follow as far as the feet are concerned, because the feet perspire more readily than any other part of the body. Footgear is more often subjected to wetting than are other items of equipment, but is designed to decrease this disadvantage as much as possible. A dry change of socks should be carried at all times. Whenever the feet get wet, socks should be changed as soon as possible. If wearing mukluks, both socks and insoles should be changed when they become wet. Footgear should be dried at the first opportunity and be kept clean. Socks and feet should be washed frequently. This washing will help keep the feet and socks in good condition. The feet should be exercised. Stamping the feet, double-timing a few steps back and forth, and flexing and wriggling the toes inside the boots will require muscular action which produces heat and will keep the feet warm. The feet should be massaged when changing socks. Boots are designed to be attached

to individual oversnow equipment (skis and snowshoes). **SKI OR SNOWSHOE BINDINGS MUST BE ADJUSTED CAREFULLY.** If they are too tight, the circulation of blood is restricted and the feet will get cold. Improperly adjusted bindings may soon chafe the feet or cause excess wear and tear to the boot.

## **204. Principles of Keeping Warm**

1. The principles of keeping warm can be remembered by the catch-word "COLD".
  - a. C - Clean clothing.
  - b. O - Overheating must be avoided.
  - c. L - Loose and layered clothing.
  - d. D - Dry clothing.
  
2. Keep Clothing Clean. This is important from a standpoint both of sanitation and comfort. In cold weather it is also necessary to have maximum warmth. Dirt and grease will mat clothing and fill the air pockets; this allows the heat from your body to escape more readily. Underwear requires the closest attention and frequent changing because it will be the dirtiest. Woollen underwear and socks should be washed in lukewarm water or, if warm water is not available, rinsed in cold water. Woollens should not be boiled or washed in hot water. When outer clothing gets dirty it should be washed with soap and water. All the soap must be rinsed out of the clothes. Soap left in the clothing will lessen its water-shedding qualities.
  
3. Avoid Overheating. To stay warm - avoid getting hot. Overheating causes perspiration which causes clothing to become damp and dampness fills the air holes in the clothing with heat-conducting moisture, permitting the body heat to escape. Another reason for avoiding overheating is that when perspiration evaporates your body will cool faster. Overheating can be prevented by ventilation (partially open parka or jacket) or by removing layers of clothing. In cold temperatures, it is better to be slightly chilly than too warm.
  
4. Wear Clothing Loose and in Layers. Clothing and footwear that is too tight restricts the blood circulation, increasing the danger of frost-bite. On the other hand, clothing must not be worn too loose; this will allow movement of the trapped air between the layers of clothing, resulting in a heat loss.
  
5. Keep Clothing Dry. Moisture will soak into your clothes from both inside and outside. Frost or snow that collects on your clothing will be melted by the heat you radiate or by the higher temperature encountered when you enter heated shelters. Brush or shake off all snow and frost before entering shelters. Even in the coldest weather you cannot entirely avoid perspiring. Take advantage of each and every opportunity to dry out your clothes. Here are some tips on how to do it:

a. Drying Wet Clothes

- (1) Handle each piece separately.
- (2) Do not hang things directly above the stove or heat source; they may fall and catch fire.
- (3) Do not place anything too close to a stove or hot pipes. Nylon melts easily and wool quickly becomes scorched.
- (4) Do not hang clothes over steaming pots.

b. Drying Damp Clothes

- (1) Hang damp clothes on your rucksack on the march.
- (2) Do not place damp clothing in your sleeping bag to dry. This only transfers moisture from your damp clothing into the down of your sleeping bag.

**IF YOU WANT TO KEEP WARM, REMEMBER THE CATCH WORD "COLD".**

**205. Military Requirements of Cold Weather Clothing**

1. To be usable and efficient in all types of military operations, cold weather clothing should have the following characteristics:

- a. provide adequate insulation for a windchill factor of -80EF;
- b. be suitable for wear at above zero temperatures;
- c. be light in weight;
- d. be flexible;
- e. have minimum bulk;
- f. be moisture-proof;
- g. be durable;
- h. be POL resistant, if possible; and
- j. be capable of withstanding a storage temperature of 100EF or greater.

**206. Types of Military Clothing**

1. Two types of military winter clothing are available for wear in winter operations:

- a. personal winter clothing as per Ordnance Scale 23 - 500, Table "A" prior to 1965; and
- b. 1965 pattern combat clothing;

2. The 1965 pattern combat clothing consists of the following items:
- a. Toque. This is a wool and nylon close fitting headgear that affords protection to the head, forehead, and ears.
  - b. Scarf. This is a knitted cotton optional item of wear to protect the neck and face and is much larger than the old issue being 24 X 72 inches.
  - c. Undershirt and Drawers. These are long sleeved and long legged honeycomb knit cotton garments generally known as thermal underwear and replace the string vest and flannelette drawers.
  - d. Shirt-Coat. Normally is an outer garment in hot weather but used as an under garment under all other conditions.
  - e. Trousers, Lightweight. Normally an outer garment in hot weather but may be used as an inner garment in early winter and spring conditions.
  - f. Coat and Trousers, General Service. These are water repellant nylon/cotton garments that are normally worn under spring and fall conditions as outer garments. They may be worn as outer garments in the early winter and spring or as under garments under severe weather conditions
  - g. Liner, Coat, General Service. This garment provides supplemental insulation for early winter or spring conditions. It is buttoned into the coat but no insulation is provided in the sleeves.
  - h. Parka, Combat, Lightweight. This is a very light cotton/nylon shell with adjustable hood and fur ruff and is the normal outer garment worn over the general service combat clothing.
  - j. Windpants. A very light nylon cotton shell and the normal lower outer garment worn over the general service combat clothing.
  - k. Cap, Field, General Service. This is a skull-type cap with visor and all around brim with adjustable ear flaps and is crushable. It can be worn in either winter or summer.
  - m. Jacket and Trousers, AFV Crew, Cold Weather. These garments consist of a jacket with hood and retrieval straps at the back and shoulders plus bib-type trousers with a drop seat. They are designed for protection down to -20EF when operating in shut-down unheated armoured vehicles.
  - n. Sweater. It is used for extra insulation and worn over the shirt in periods of extreme cold. It is normally worn in lieu of the parka when inside the tent.
  - p. Mukluks, Insoles, and Duffle Socks. Should be loose fitting and worn with the mesh insole next to the mukluk then the felt insole, grey woollen socks, and duffle socks. The mukluk should not be laced too tightly.
  - q. Inner and Outer Mitts. Should be loose fitting. The back surface is fitted with a pile patch which is used to thaw minor cases of frost-bite on the nose and cheeks should they occur. The inner liners should never be worn alone as dampness will destroy their insulating qualities.
  - r. Camouflage Parka and Trousers. Worn over the parka and windpants as directed by the sub-unit commander.

- s. Boot, Combat, General Service. This boot is issued for general service in temperate climates. It is 18 inches high with a DMS process, water repellent (silicone treated) upper. It has a speed lace closure and a mesh insole with a nylon top.
- t. Overshoes. For wear in cold/wet conditions. It is 11 inches high and has a slide fastener closure. Insulation is provided by a 5/10 inch felt insole and foamed-in-place rubber in ankle region.
- u. Woollen Shirt. This is worn during extreme cold weather operations.
- v. Face Mask. The face mask protects the face and lungs against extreme cold. It has an easily detachable mouth cap.

Note: For examples see Figure 2-1 to 2-1M.

### **Conclusion**

The principles and points mentioned in the preceding section have been thoroughly tested and both types of clothing meet all the requirements. In teaching these points, unit instructors should show the film No 10018 - Army Films 1958, HOW TO USE COLD WEATHER CLOTHING.



Figure 2-1 Cap, Knitted (Toque) - Cold Weather



Figure 2-1A Face Mask - Cold Weather



Figure 2-1B Extreme Cold Weather Undershirt





Figure 2-1C Extreme Cold Weather Drawers

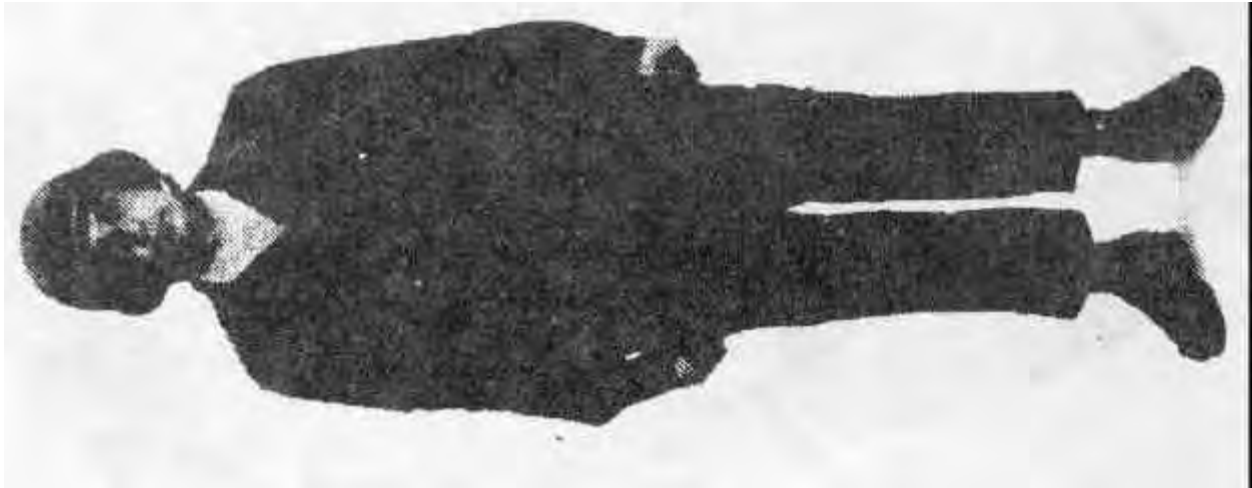

Figure 2-1D Shirt-coat and Trousers Light-weight



Figure 2-1E Coat and Trousers General Service



Figure 2-1F Liner Coat General Service

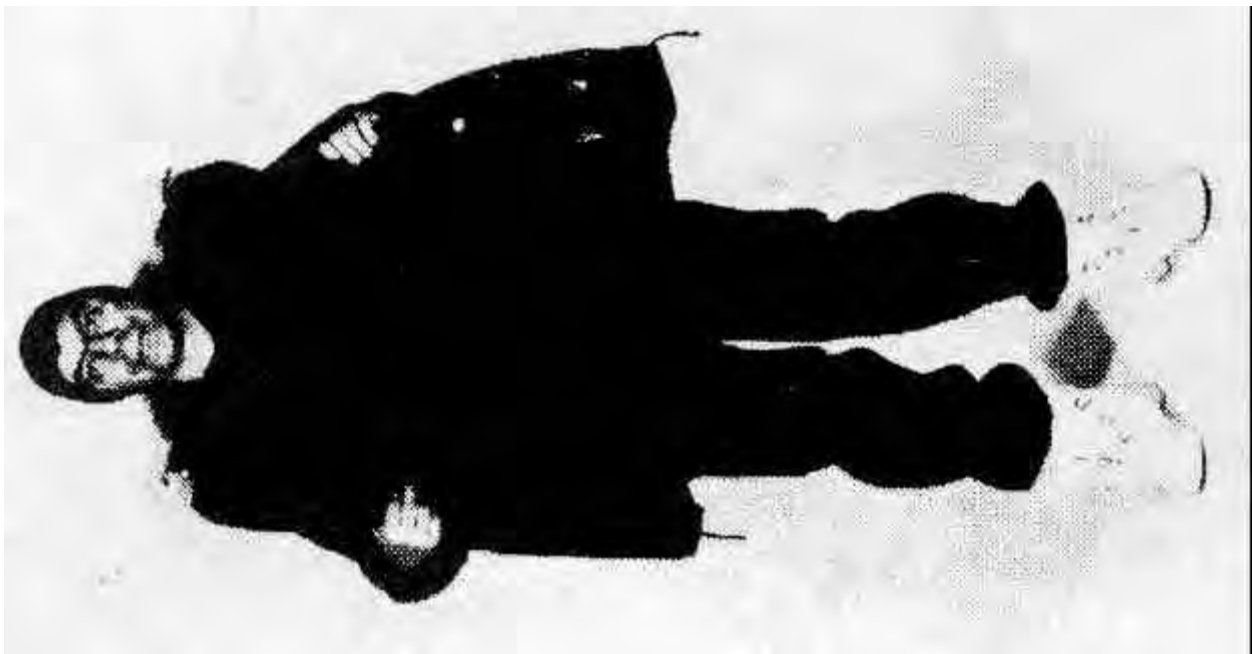

Figure 2-1G Parka Combat and Windpants



Figure 2-1H Mukluk



Figure 2-1J Caps Combat



Figure 2-1K Outer Garments and Rucksack



Figure 2-1L Trousers for AFV Crew



Figure 2-1M Jacket for AFV Crew

## SECTION 2 - SLEEPING BAG

### 207. General

1. The possibility of freezing to death when sleeping outdoors in below zero temperatures is one that haunts a man who has never had any experience living outdoors in cold weather conditions. This is a needless worry as the cold will always awaken you first. It is a known fact that people can sleep outdoors in sub-zero temperatures with no additional equipment or clothing with no fear of freezing to death as long as they are not physically exhausted. The issue sleeping bag and air mattress allows you to sleep comfortably in any weather conditions ranging from the tropics to areas of extreme cold providing you use it properly.

2. Personnel who do not exercise proper care and maintenance of their sleeping bags and air mattresses will find that the insulation value of them will be lost in a short period of time. They will then become a liability to their tent group. In order that you can spend an extended period of time in the field in cold climate conditions you must know how to care for and maintain your sleeping bag and air mattress.

### 3. Air Mattress

#### a. Characteristics of the air mattress:

- (1) the general shape conforming to the sleeping bag;
- (2) the six panels or tubes;
- (3) the inflating bellows, valves, and stoppers;
- (4) the inflating instructions stamped on the bellows;
- (5) the "D" rings on each side which enables several mattresses to be tied together or allows the sleeping bag to be tied to the mattress. The latter is only used when securing casualties for evacuation;
- (6) that the air mattress should not be inflated orally otherwise the stopper will freeze to the inlet stem and ice will form inside the air mattress from condensation of the breath. This will cause the rubber to crack when removing the stopper or rolling up the air mattress.

#### b. Inflate the air mattress as follows:

- (1) Insert the bellows valve into the air mattress inlet stem.
- (2) Using both hands, open the top of the bellows and punch it together. Lift the open end upwards in a quick motion and close the top quickly trapping air inside the bellows.
- (3) Roll the bellows towards the air mattress thus forcing air into the air mattress. Continue until the air mattress is inflated. Correct inflation can be determined by pressing on the centre of the air mattress with the flat of the hand so that it just touches the ground.



- (4) To insert the stopper, grasp the flat portion of the air mattress inlet stem firmly between the forefinger and thumb, remove the bellows valve and insert the stopper using a twisting motion.
  - (5) The air mattress should be left inflated overnight to check for leakages.
- c. The following additional points should be noted:
- (1) When pine boughs, etc., are used as additional insulation, care must be exercised in keeping sharp ends downwards to prevent air mattress punctures.
  - (2) Minor punctures can be repaired with adhesive tape.
  - (3) If an inflating bellow or valve becomes unserviceable on one air mattress, inflation can be accomplished by using the bellows of another air mattress.
  - (4) If air mattresses are not issued, or if the air mattress becomes unserviceable, tree branches, boughs, packboards, cardboard, etc., can be used under the sleeping bag to provide insulation.

## **208. Sleeping Bag - 1951 Pattern**

1. The 1951 pattern sleeping bag consists of four main parts:

- a. the cover;
- b. the outer bag;
- c. the inner bag; and
- d. the liner.

Note: There is also a waterproof carrying bag, if required.

2. The Cover. The cover of the sleeping bag is made of moisture-proof nylon. It has tie tapes along the sides which are used to fasten it to the rings on the air mattress, but this is done only when carrying a casualty; otherwise the bag is not tied to the air mattress. The two long tapes at the bottom of the bag are used to secure the sleeping bag when it is rolled up. The cover should not be removed from the bag as its main purpose is to keep the bag clean and protect it from moisture. There are two tapes at the top of the cover to secure it to the outer bag.

3. The Outer Bag. The outer bag is downfilled. At the bottom of the bag there are two sets of snap-fasteners which are used to adjust the length of the bag to the sleeper's requirements. At the top of the bag there are a series of snap-fasteners. There are two loops at the top to which the ties of the cover are fastened. A drawstring with a toggle and quick-release fastener is used to close the bag snugly around the user's neck. The second drawstring in the outer bag is used to draw the bag closer around the body.

4. The Inner Bag. The inner bag is made in the same way as the outer. There are two ties at the bottom. A small slit in the body of the bag admits the body drawstring of the outer. There is a drawstring at the top. The flannel flap at the top of the bag is used as a hood when sleeping. Loops on the inside of the bag are used for attaching the liner.

5. The Liner. The flannelette liner attaches to the inner bag by means of tapes. It has three leather-reinforced slits through which the body drawstrings and the top drawstrings of toe inner and outer bags are threaded. There is a flap at the top of the liner which is used in conjunction with the flap of the inner bag.

6. Assembling the Sleeping Bag

- a. Lay the inner bag on a flat surface inside out with the loops on the sides.
- b. Place the liner on top with the tapes out; flannelette flaps must match (long side to long side, short side to short side).
- c. Tie the tapes of liner to the loops of the inner bag.
- d. Reach inside the inner bag, grasp the foot of the liner and turn right side out.
- e. Thread the drawstring and quick release of inner bag through the liner.
- f. Thread the long tapes of the flannelette flap of the liner through the loops of the flannelette flap of the inner bag.
- g. Turn the outer bag inside out and place it on top of the inner bag.
- h. Thread the body draw string, toggle, and quick release through the slit of the inner bag and leather reinforcements of the inner.
- j. Thread the top drawstring, toggle, and quick release through the slit in the leather reinforcement on the flannelette of the inner bag and through the slit of the leather reinforcement of the liner.
- k. Tie the bottom tapes of the inner bag to the bottom loops of the outer bag.
- m. Reach in the outer bag, grasp the foot of the inner bag and turn right side out.
- n. Fasten the snap fasteners at the top of the inner and outer bags.
- p. Adjust the length of the sleeping bag by clipping together the snap-fasteners at the bottom of the outer sleeping bag.
- q. Slip on the nylon cover and tie the two top tapes of the cover to the top loops of the outer bag. The sleeping bag is now assembled.
- r. The remaining tapes along each side of the nylon cover are only used to secure a casualty in a sleeping bag to the air mattress.

7. Using the Sleeping Bag

- a. To prepare the bag for use proceed as follows:
  - (1) Lay the bag on the air mattress with long portions of the flannelette flaps down.
  - (2) Fluff up the down in the sleeping bag to get the maximum benefit from the insulation.
  - (3) Get into the bag.
  - (4) Wrap the flannelette flaps around the head like a hood and secure them with the long tapes.
  - (5) Tighten the top drawstring of the inner and outer bags and adjust the body drawstring.

- (6) On getting up, squeeze the warm moist air out of the sleeping bag, fluff up and squeeze out the air again.
- (7) Stow the sleeping bag away or turn it inside out and air it.
- b. To get out of the sleeping bag quickly stand up inside the sleeping bag and loosen the drawstrings. This allows the bag to fall to the ground.
- c. Do not wear more clothing than needed to keep warm because perspiration must be kept to a minimum to keep the bag dry:
  - (1) The parka can be placed between the sleeping bag and air mattress with the head above the top of the bag opening. This will provide additional insulation and the hood can be worn over the head for added comfort.
  - (2) Never keep dirty, damp socks on when getting into the sleeping bag. Keep a clean pair in the bag and use them only for sleeping.
- d. Extra clothing can be used for added insulation under the sleeping bag, especially under the shoulders and hips. The sleeping bag is compressed at these points and as a result loses some of its insulating qualities.

## 8. Care and Maintenance

- a. Inspect the bag before use for rips and tears. Any defects in the covering of the bag should be repaired immediately or the insulating down will be lost.
- b. Keep the bag clean. Always remember to use the liner and the outer cover.
- c. Dry the sleeping bag at every opportunity. The flaps will become quite wet from breathing into them while the user is asleep, and must be dried frequently.
- d. Before assembling the bag, test all the tapes. If they are not secure, re-sew them.
- e. Never take damp clothes into the sleeping bag to dry out. The sleeping bag only absorbs the dampness and loses some of its insulating value.
- f. Do NOT eat or drink in your sleeping bag. If you spill liquid or food on the bag, the insulation value is lost.
- g. Do NOT smoke while in your sleeping bag. The bag is covered with nylon and is highly inflammable.
- h. When the sleeping bag is not in use or being aired out, it should be stored in the waterproof valise or in the rucksack.

## 209. **Sleeping Bag - 1965 Pattern**

- 1. General. The 1965 pattern sleeping bag consists of five main parts:
  - a. the outer bag;
  - b. the inner bag;
  - c. tile liner;
  - d. the hood; and
  - e. waterproof carrying bag.

2. The Outer Bag. The outer bag is filled with 40% down and 60% feathers. At the bottom of the bag on the outside there are two tapes that are used to shorten the bag by Lying the tapes into the webbing loop at the bottom of the zipper, thus adjusting the length to the sleeper's requirements. At the top of the bag there are three snap-fasteners that snap into three corresponding ones on the inner bag. The zipper can be easily opened by grasping the bag on each side of the zipper, pulling outwards. On the inside of the bag there are two loops at the foot and four double tapes, two at the shoulder and two at the waist. These are used to fasten the inner and outer bags together. There are no drawstrings or toggles on this pattern of sleeping bag.
3. The Inner Bag. The inner bag is made in the same manner as the outer. There are size loops on the inside, two at the foot, two at the waist, and two at the shoulder. There are ten snap-fasteners on each side of the zipper and one at the back of the neck which corresponds to similar fasteners on the liner. In addition there are two single tapes at the shoulder. They are all used to fasten the bag to the liner. On the outside of the inner bag there are three pairs of double tapes which are used to fasten the inner and outer bags together. The three snap-fasteners at the neck are also used for this purpose.
4. The Liner. The flannelette liner attaches to the inner bag by corresponding double and single tapes and snap-fasteners as described above.
5. The Hood. The hood is a separate item made of the same material as the outer and inner bags. The shoulder length skirt has two elastic loops on each side through which the arms are placed thus holding it firmly in place on the wearers head. There are two "Velcro" fasteners, one at the neck and one at the bottom of the skirt.
6. Assembly, Use, Care, and Maintenance. Except for minor changes, the instructions contained in paras 6, 7, and 8 above apply.



Figure 2-2 Bag, Sleeping, Cold Weather Complete with Hood and Liner



Figure 2-2A Bag, Sleeping, Cold Weather Complete with Hood and Liner

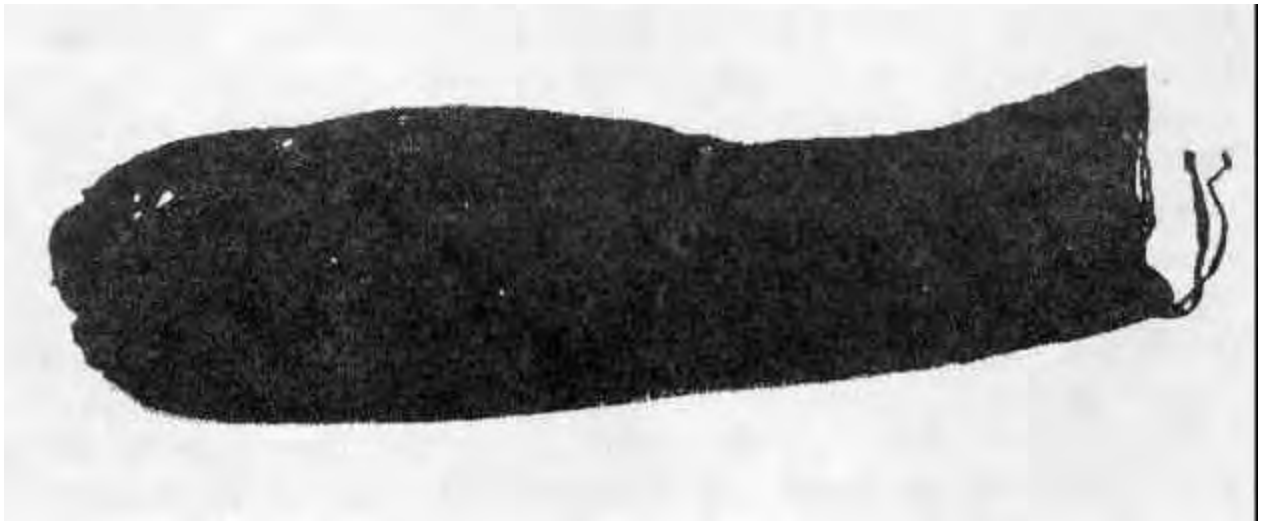

Figure 2-2B Bag, Sleeping, Cold Weather Complete with Hood and Liner



Figure 2-2C Sleeping Bag - Container

## SECTION 3 - THE RUCKSACK

### 210. General

1. Field operations in cold weather will often be conducted where the use of vehicles will be limited or where they cannot be used at all. This means that packs and equipment must be carried or towed on toboggans, by manpower. This is not a new problem in Canada. Trappers, hunters, and prospectors have been carrying their equipment on their backs for years. For instance, at one time the Hudson Bay Company would not hire a man who could not make 80 miles in 4 days, carrying in addition to a 90 pound company load, his own food, weapon, bedding, and any other personal equipment he required. You are not expected to do that. For planning purposes, we expect you to be able to move 12,000 m on tundra and 8,000 m in forest in eight hours carrying your normal full load of equipment and rations. These standards are only a guide since the distance you travel will depend on the snow and weather conditions and the tactical situation.

2. The rucksack is the normal general issue load-carrying item of equipment for troops engaged in cold weather training and operations. It carries the soldier's immediate needs of clothing and equipment. He therefore must know how to assemble, pack, and adjust it, for maximum comfort and balance.

3. The rucksack can be packed and adjusted for skiing, snowshoeing, and marching. When properly fitted it permits:

- a. freedom of the shoulders and hips;
- b. a natural erect posture; and
- c. a normal gait.

### 211. Description

1. The rucksack is a normal cold weather pack and is ideal for carrying medium-weight loads of 30 to 65 pounds. Most of the weight is distributed on the hips so that the shoulders take only a part of it. The frame holds the load off the back, allowing the air to circulate between the clothes and the back of the pack. This reduces the perspiration that collects on the back. Another good feature is that the shoulder straps can be adjusted when wearing mitts. Other uses for the rucksack are:

- a. as a pillow while sleeping;
- b. as a wind-break while resting;
- c. as part of a component of a packboard;
- d. as a foot-warmer, by placing your feet inside the bag; and
- e. in an emergency, for transporting a casualty by seating a man in the sack, after holes have been cut for his legs.

2. The Rucksack, Universal, C1, consists of:
- a. a tubular frame to which a number of strap and belt components are attached;
  - b. a cargo shelf which is positioned to the lower or centre horizontal bar of the frame when the frame is used as a packboard,
  - c. straps, including shoulder straps, cargo retaining straps and back rest straps;
  - d. a nylon canvas bag (combat pack) having pockets with quick release tabs, back straps and side straps for attachment to the frame, a double eyelet webbing hanger and securing straps on each side for attachment of the canteen and mess tin carriers-, and
  - e. a webbing belt with a quick release aluminum buckle assembly.

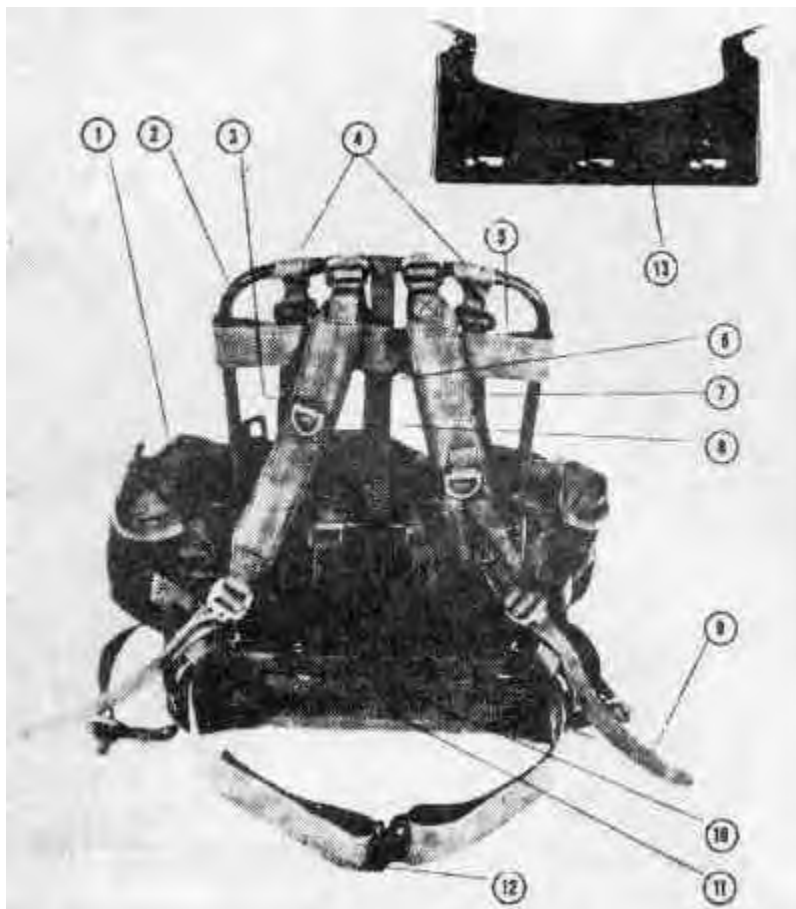

Figure 2-3 Rucksack, Universal, C1

- (1) Bag, Nylon (Combat Pack)
- (2) Frame
- (3) Strap, Retaining, Cargo (Quantity 2)
- (4) Strap, Retainers, with Buckle (Quantity 2)
- (5) Strap, Backrest, Upper
- (6) Strap, Shoulder, Upper Section, Right Hand
- (7) Strap, Shoulder, Upper Section, Left Hand



- (8) Strap, Backrest, Vertical
- (9) Strap, Shoulder, Lower Section (Quantity 2)
- (10) Belt, Waits 2-1/4" Width
- (11) Strap, Backrest, Lower
- (12) Buckle, Assembly, Black Anodized, Aluminum
- (13) Shelf Cargo Support

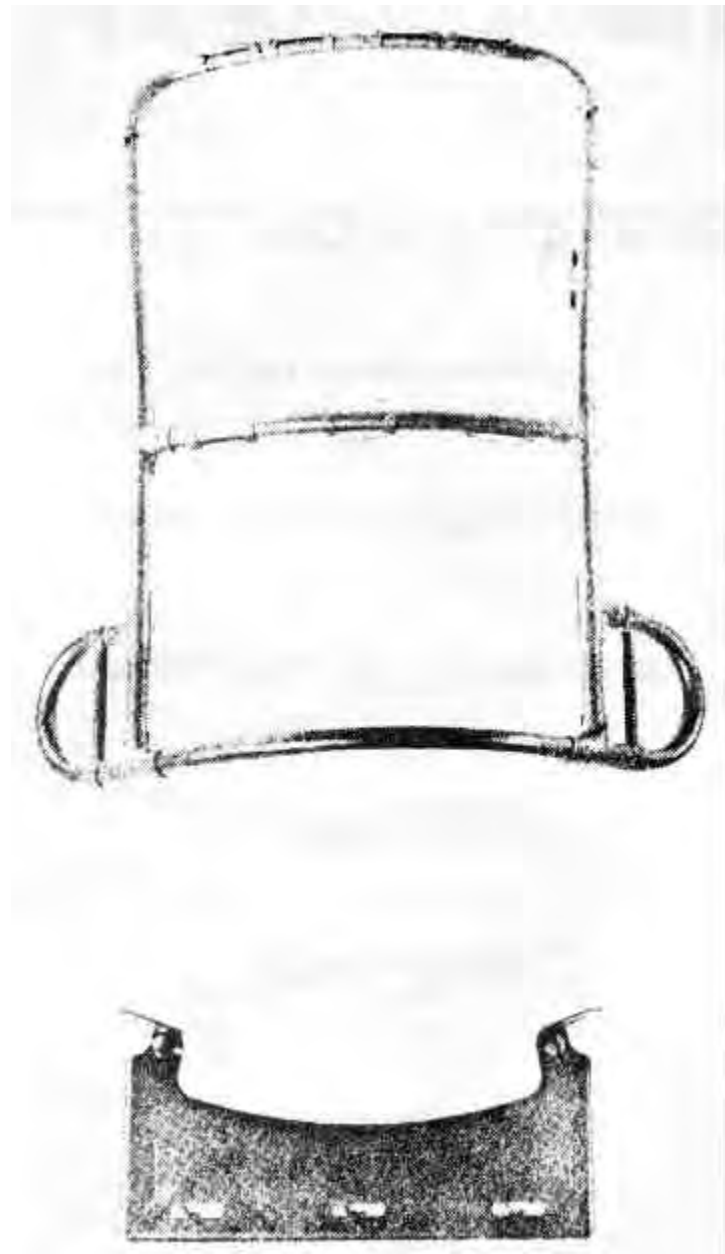

Figure 2-3A Frame and Shelf, Cargo Carrying



Figure 2-3B Straps, Rucksack, Universal, C1

Note: The above shows the complete types and number of straps required as component parts for the Rucksack, Universal, C1.

## 212. Assembly - Attachment of Strap Components to the Frame

1. Sliding bar plastic buckles are used for attachment of most of the strap components to the frame. Figure 2-4 show the sequence of operations for threading a strap through the buckle.

- Step 1 - Strap end is threaded through the buckle behind the sliding bar.
- Step 2 - Strap end is looped over the sliding bar and through the buckle.
- Step 3 - Strap end is pulled tight.

2. To loosen strap lift up on the tapered projection on the front of the buckle.

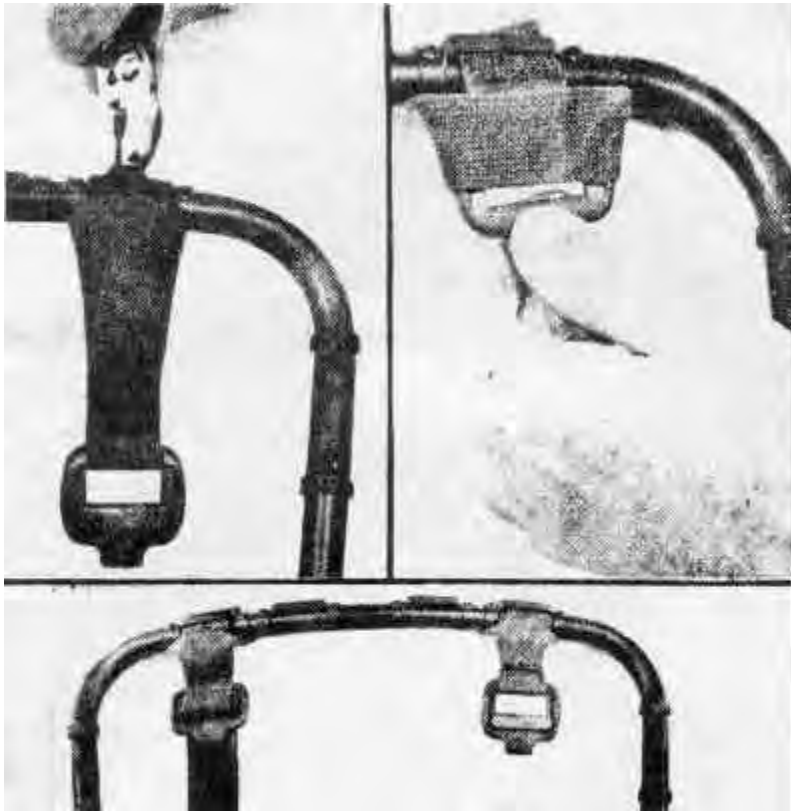

Figure 2-4 Assembly

Note: The first step in the assembly of the strap components is the attachment of the two strap retainers (with buckle) to the top horizontal bar of the frame as illustrated here. It may be a little difficult to get the folded strap ends through the strap keeper; these may be opened out slightly with the aid of a screwdriver or other like object.

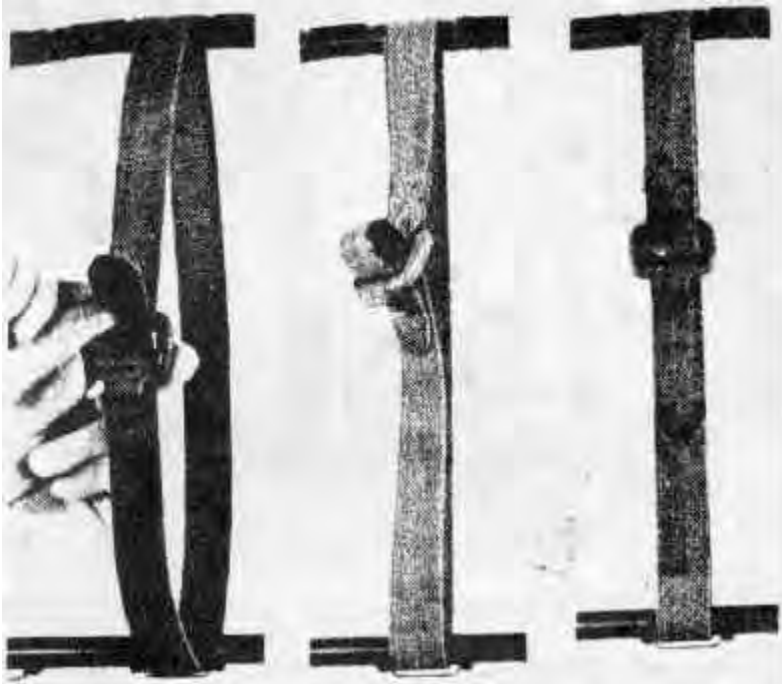

Figure 2-4A Assembly

Note: Attachment of Strap Components to the Frame Sliding bar plastic buckles are used for attachment of most of the strap components to the frame. The following photographs shows the sequence of operations for Threading a strap through the buckle.

- Step 1 - Strap end is threaded though the buckle behind the sliding bar.
- Step 2 - Strap end is looped over the sliding bar and through the buckle.
- Step 3 - Strap end is pulled tight.

To loosen strap lift up on the tapered projection on the front of the buckle.

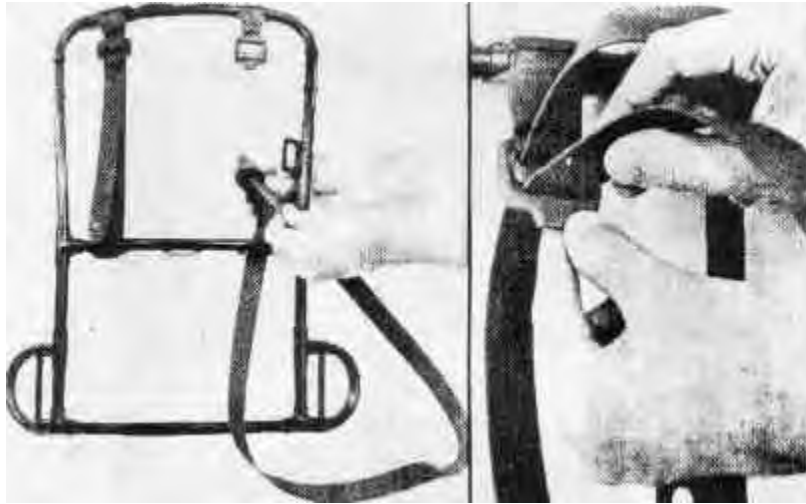

Figure 2-4B Assembly

Note: Attachment of the two straps, retaining, cargo and the strap, backrest, vertical. The free end of each cargo retaining strap is passed through each of the outer strap keepers of the centre horizontal bar of the frame, through the loop of the strap and then through the buckles as shown.

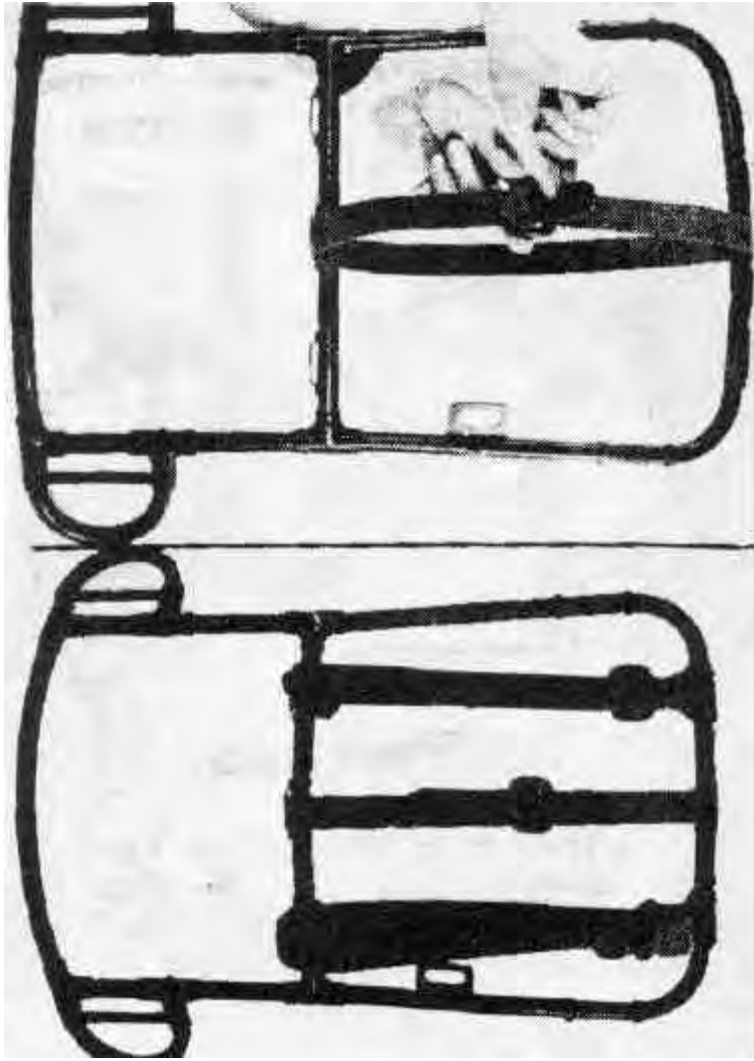

Figure 2-4C Assembly

Note: Because of the length of the retaining straps each is looped around the horizontal bar and through the buckle a second time. The free end of the strap, backrest, vertical is passed through the centre strap keeper of the centre bar and the buckle end is placed over the top horizontal bar of the frame. Ensure that all buckles are facing outward as shown.

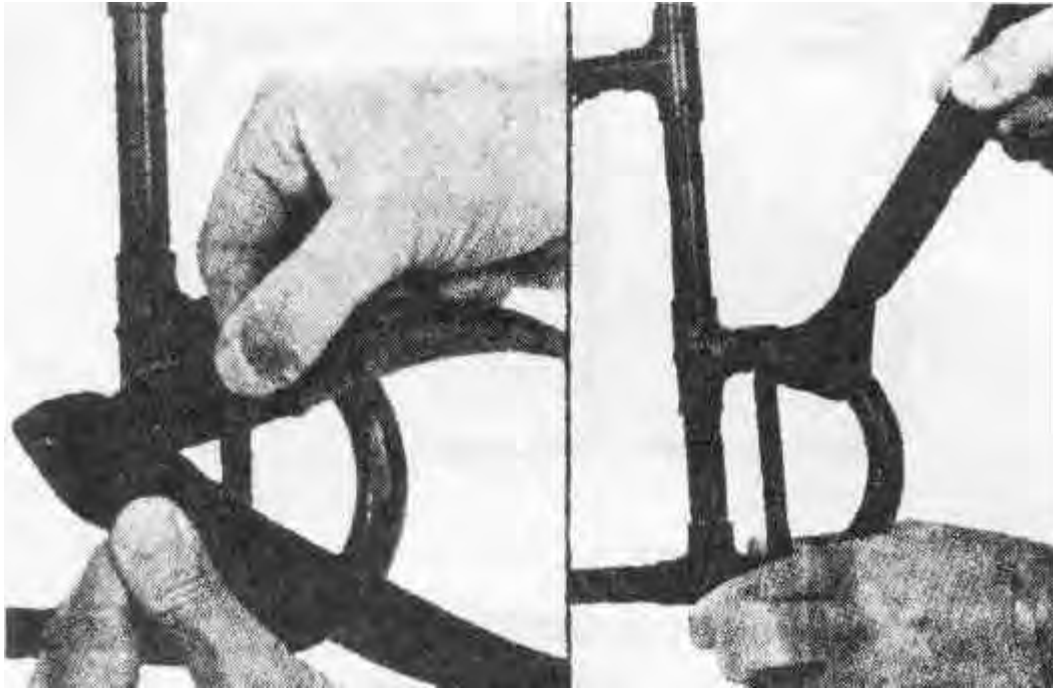

Figure 2-4D Assembly

Note: Attachment of the strap, shoulder, lower section. The strap is attached to the D section of the frame by positioning the strap as shown in the left photo and then the free (plastic) end is passed through the loop and the strap is pulled taut. The other strap is attached to the opposing D section of the frame in the same manner.



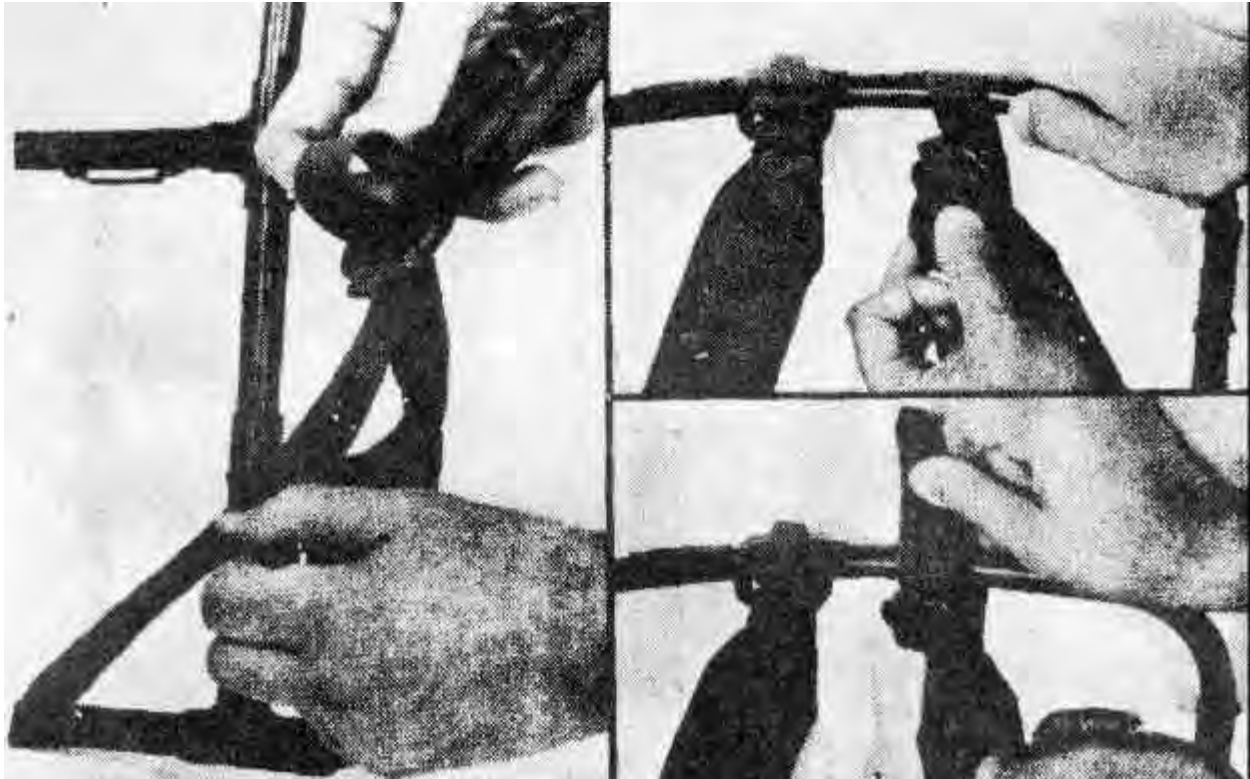

Figure 2-4E Assembly

Note: Above photo shows the method of securing the left lower shoulder strap to the buckle of the lower end of the strap, shoulder, upper section left. The photos at the right shows attachment of the top of the strap shoulder to the top horizontal bar of the frame; the strap is passed through the strap keeper then through the buckle as shown. This process is repeated to secure the straps on the right side (wearer's right) of the frame.



Figure 2-4F Assembly

Note: Above photo shows the frame with ail shoulder straps attached. Note the quick release feature on wearer's left shoulder strap shown in right photo.

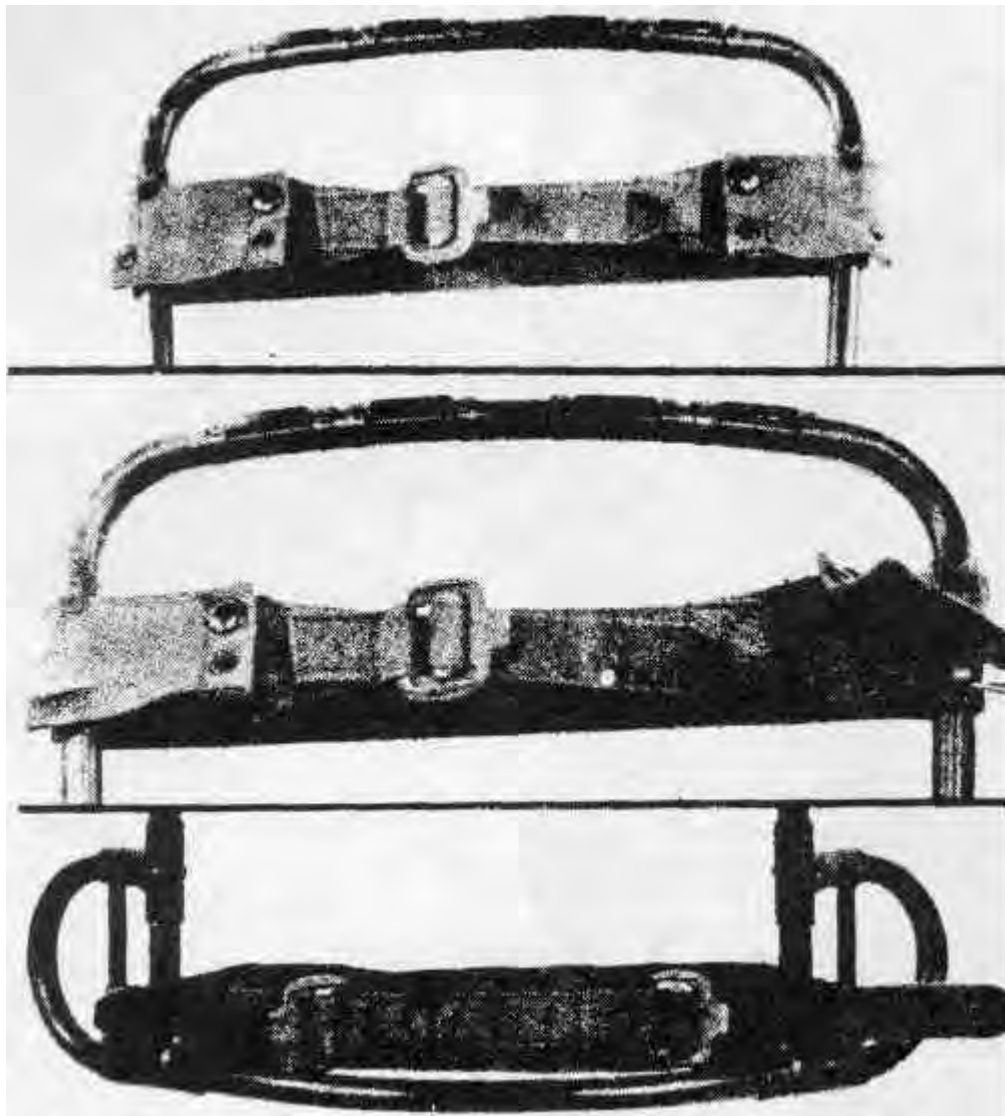

Figure 2-4G Assembly

Note: Attachment of upper and lower backrest straps. Note the position of the upper strap as well as the attachment of the lower strap to the smaller diameter vertical tubing in the centre of D section of the frame.

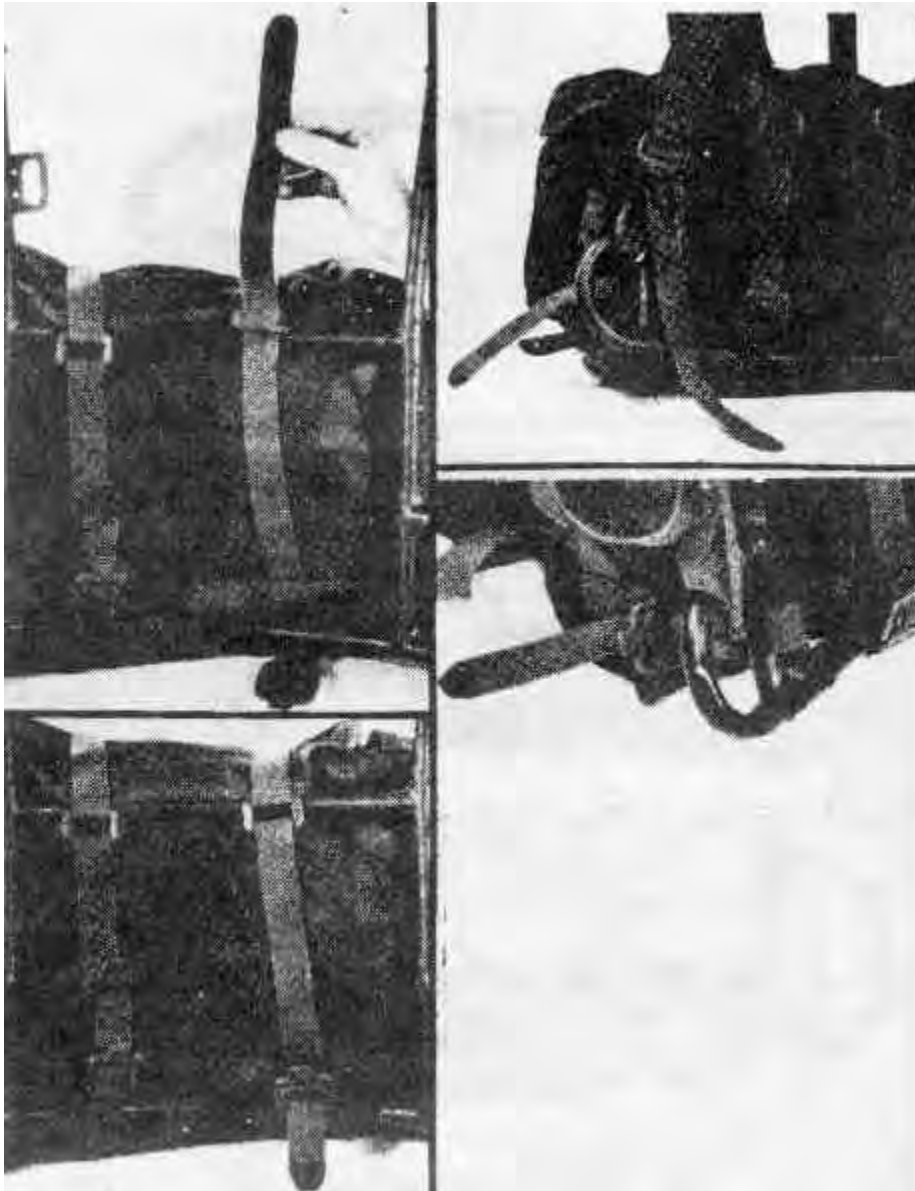

Figure 2-4H Assembly

Note: Attachment of bag (combat pack) to the frame. Bag is placed against the frame and each of the two vertical back straps is threaded through the rectangular loop and through the buckle as shown. Strap at each side of bag is looped around inner vertical bar of D section of frame and buckled down.



Figure 2-4J Assembly

Note: The above photo shows the bag and the basic strap components attached to the frame. It should be noted that the upper backrest strap rests unobstructed against the wearer's back. After the bag (combat pack) has been secured to the frame the lower backrest strap is attached to the smaller vertical tubing in centre of the D section of the frame.

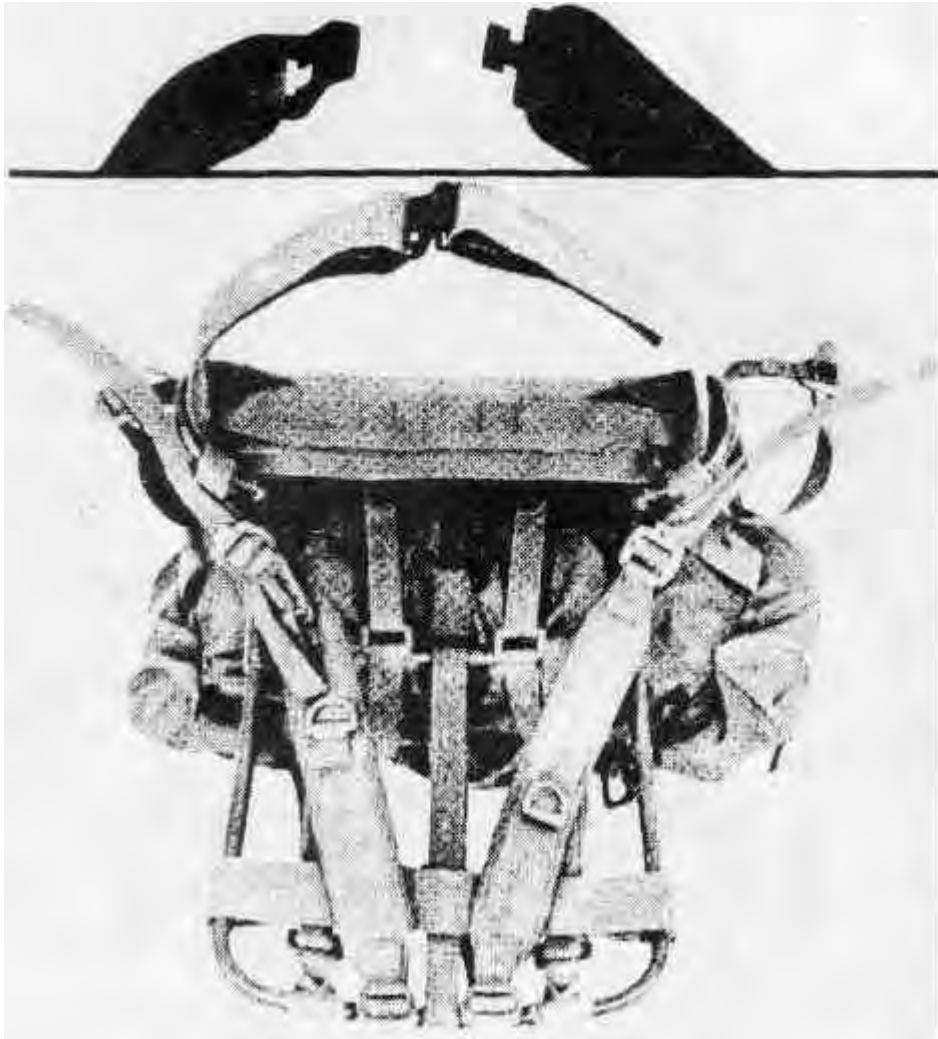

Figure 2-4K Assembly

Note: Attachment of waist belt. The waist belt is threaded through the D section behind the backrest strap and then the buckle is attached as shown. The buckle may also be positioned with the female section on the wearer's right and the male portion on the wearer's left, depending on his preference, however the buckle must be so positioned so that the wearer can lift up on the female portion for quick release.

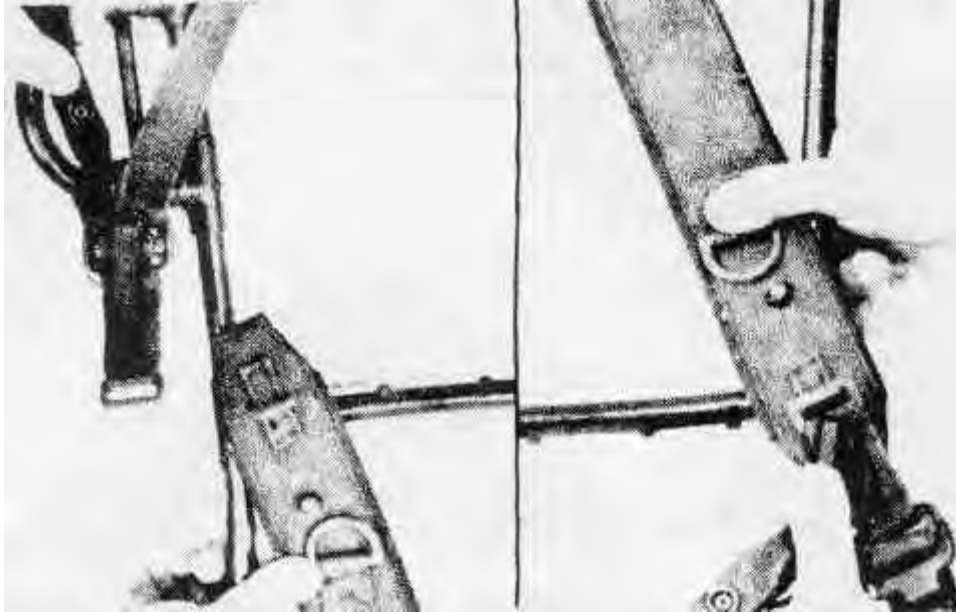

Figure 2-4M Assembly

Note: Shows the components that make up the quick release feature of the left shoulder strap. To buckle the strap place the rectangular loop over the loop attached to the upper section then insert the webbing tip (emphasized by the dark outline in right photo) into the opening, and secure the two parts of the dome fastener together.

### 213. Packing

1. When you load your rucksack pack heavy items at the bottom next to the frame. This places most of the weight on your hips, which you need for good balance.
2. When loading:
  - a. place heavy objects near the frame;
  - b. place sharp and hard objects inside where they will not rub on the bag;
  - c. place frequently needed articles in the outside pockets; and
  - d. keep maps and other flat objects in the flap pocket.
3. The many pockets and partitions make it unnecessary to unpack the entire load to find frequently needed items or changes of clothing.
4. Explain and demonstrate the following suggested method of packing:
  - a. Place the items in the sequence listed in the main pouch:
    - (1) duffle socks,
    - (2) 1 pair woollen socks,
    - (3) 1 pair felt insoles,
    - (4) shirt woollen,

- (5) undershirt, extreme cold weather,
  - (6) drawers, extreme cold weather,
  - (7) sweater high neck.
- b. Centre outside pocket - 24 hour rations.
- c. Side outside pockets:
- (1) 1 pair wool socks,
  - (2) length of lampwick,
  - (3) gloves anti-contact,
  - (4) match box, and
  - (5) toilet articles.
- d. Flat pocket - white camouflage suit.
- e. Tie white camouflage cover on top of rucksack.



Figure 2-4N Rucksack with Frame (Front View)





Figure 2-4P Rucksack with Frame (Rear View)



Figure 2-4Q Rucksack Complete with Frame and Sleeping Bag

5. Thermos Bottle and Insulating Cover

- a. The thermos should be attached to the outside of the rucksack where it is immediately available.
- b. If the thermos cup is frozen to the thermos, the cap must be removed from the bottle carefully to ensure that the seal between the outer and inner bottles is not broken. If possible, hold the thermos cup over a steaming pot, and, by revolving the thermos slowly, gently work the cap free. Wash out the thermos with hot water whenever you have the opportunity (see Figures 2-4R and 2-4S).



Figure 2-4R Thermos Bottle



Figure 2-4S Thermos Bottle and Insulating Cover

## 6. Pocket Items

- a. Do NOT leave pocket items scattered about where they can be covered with snow and buried, or where someone will step on them.
- b. If your waterproof match box is cracked, get it replaced,
- c. Keep your sun glasses in their case when not in use to prevent them from getting cracked or scratched. To prevent the glasses from fogging adjust your parka hood so that your breath will not be channelled over your glasses.
- d. Keep your knife sharp, using the file provided in the snow tools case, and keep it free from rust.
- e. Anti-chap lipstick is provided to protect your lips from chapping. Keep it with you at all times.

## **214. Adjustment**

1. The straps should be adjusted so that the upper part of the body can move freely. The arms must be able to swing freely. Rules for fitting are:
  - a. adjust the shoulder straps so that the frame is in the centre of the back, with the weight evenly distributed on both hips;
  - b. see that the strap on the rucksack frame is tight enough to allow a comfortable fit across the back of the hips; and
  - c. see that the waist strap is adjusted to fit snugly.

## **215. Camouflage**

1. The white camouflage cover gives complete camouflage for your rucksack except for the shoulder straps and the curved part of the frame which fits around the hips. To fit the cover:
  - a. place it over the rucksack so that the bottom of the sack is fitted into the sewn-seam part of the cover;
  - b. secure the tip-tapes (which should be at the top of the frame of the leather pocket); and
  - c. tighten the side draw-cords and tie with a slip knot between the frame and the sack.

## **216. Care and Maintenance**

1. Check the rucksack for damage before, during, and after an operation. A great deal of discomfort can be caused by a strap or a buckle that has been torn away while on the march. Main points are:
  - a. Check all the buckles, straps, and seams (missing, torn, or parting).
  - b. Check the sack, for rips and tears (repair immediately, a hole may cause you to lose valuable equipment).

- c. Keep away from excessive heat and moisture.
- d. Check for any pulled seams or stitches and reinforce them until permanent repairs can be made.

## 217. Conclusion

The rucksack is one of the most important pieces of load carrying equipment and must always accompany the soldier on extended marches, or whenever the soldier is to be absent from his bivouac area for an extended period. Only minimum survival equipment need be carried on patrols and this may be combined into one or two rucksack loads.

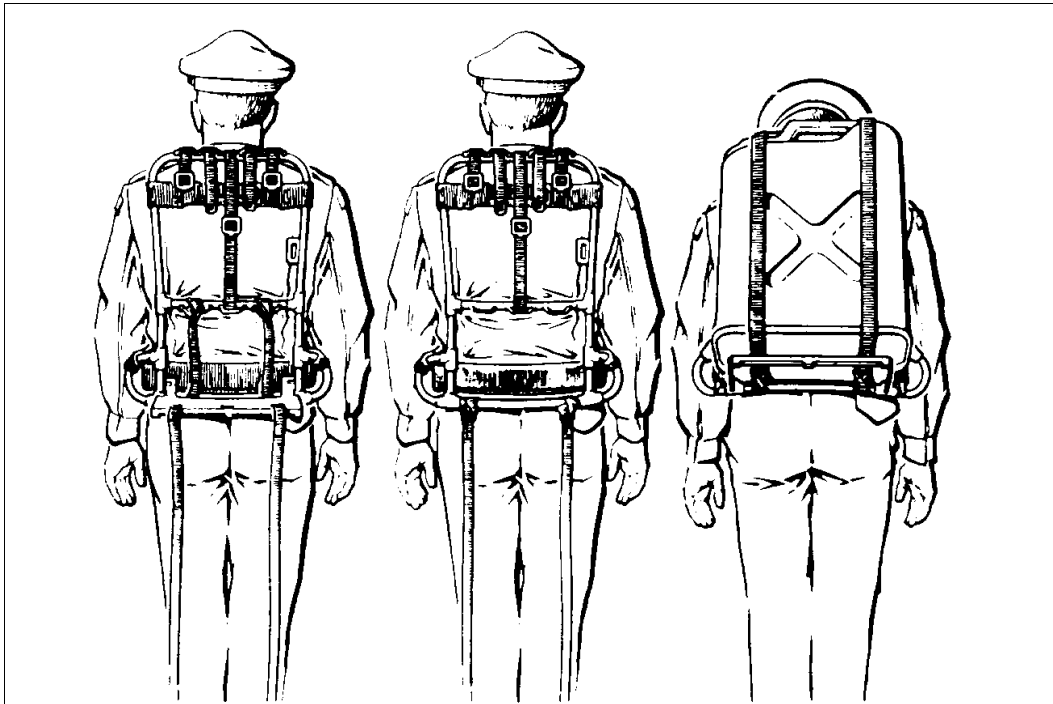

Figure 2-5 Packboard Assembly

Note: This photo shows the frame put to use as a packboard for carrying bulky items. Note the various arrangements of the straps, retaining, cargo, and the attachment of the shelf. The shelf may be fitted on the centre or lower horizontal bar of the frame depending on the size of the article to be carried. The retaining straps are laced through slots provided in the shelf then around the article to be carried, and the strap ends are secured to the buckles of the retainers located on the top horizontal bar of the frame.

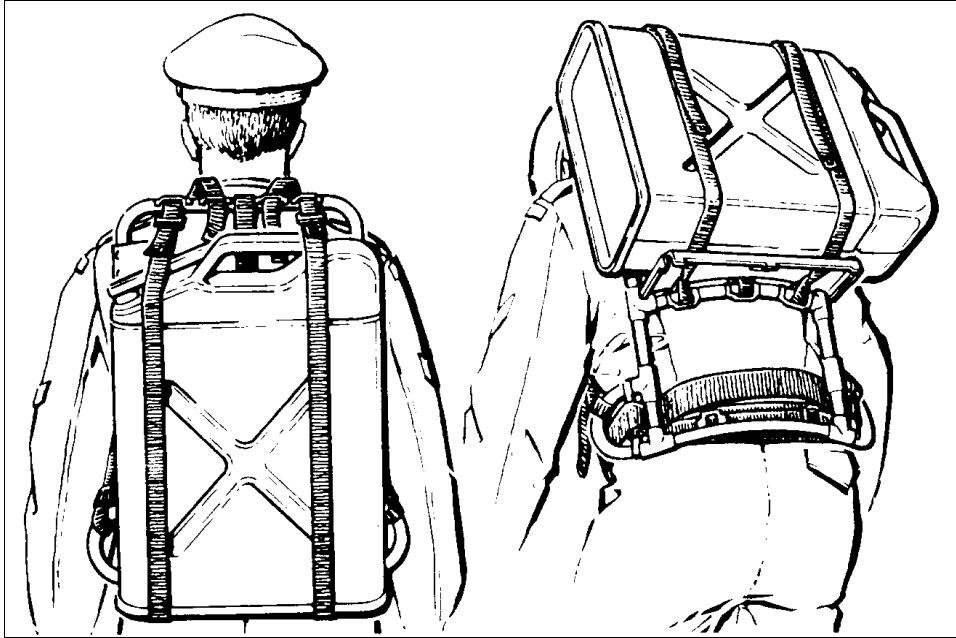

Figure 2-5A Packboard Assembly

Note: This photo shows the frame put to use as a packboard for carrying bulky items. Note the various arrangements of the straps, retaining, cargo, and the attachment of the shelf. The shelf may be fitted on the centre or lower horizontal bar of the frame depending on the size of the article to be carried. The retaining straps are laced through slots provided in the shelf then around the article to be carried, and the strap ends are secured to the buckles of the retainers located on the top horizontal bar of the frame.

## SECTION 4 - COLEMAN LANTERNS

### 218. General

1. The long hours of darkness and use of shelters necessitates the use of lanterns during winter operations. In actual operations, only a few lanterns would be issued and these would be used by such key groups as unit and sub-unit headquarters and the unit aid station. For training purposes, lanterns are generally issued to each tent group.

2. When used for any length of time the lantern will require new mantles, generators, and possibly repairs to the pump. Also, when lanterns are first issued, they will require some maintenance and a new mantle before they be used. To keep your lantern in good operating condition over an extended period of time, you must know how to use and maintain it.

### 219. Description

1. The main outer parts are shown in Figure 2-6.

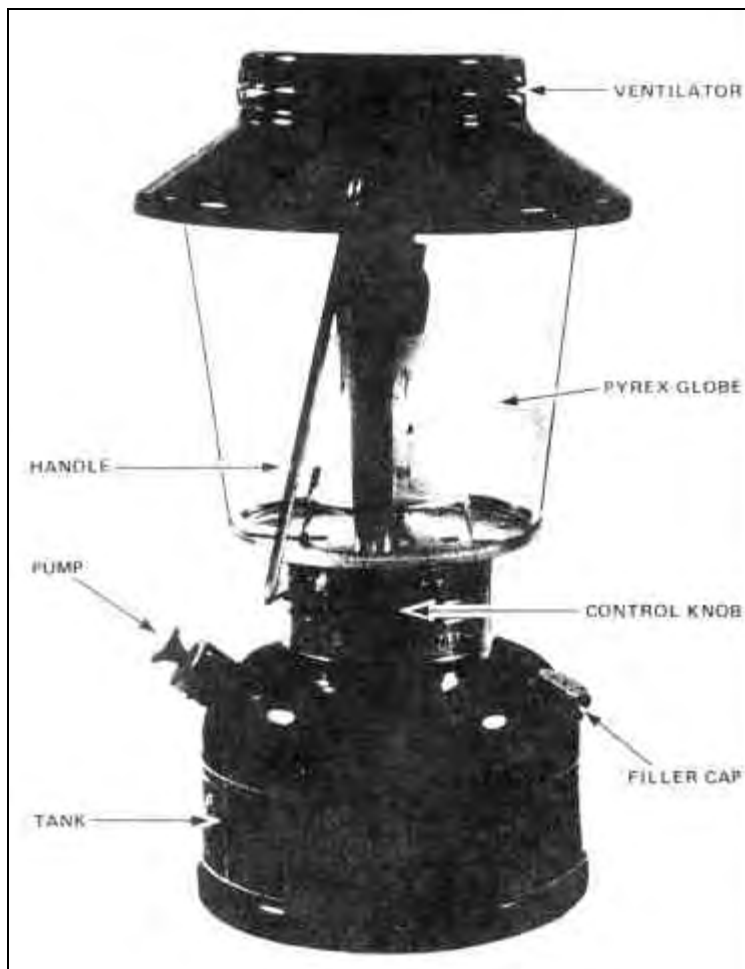

Figure 2-6 Coleman Lantern 621 B



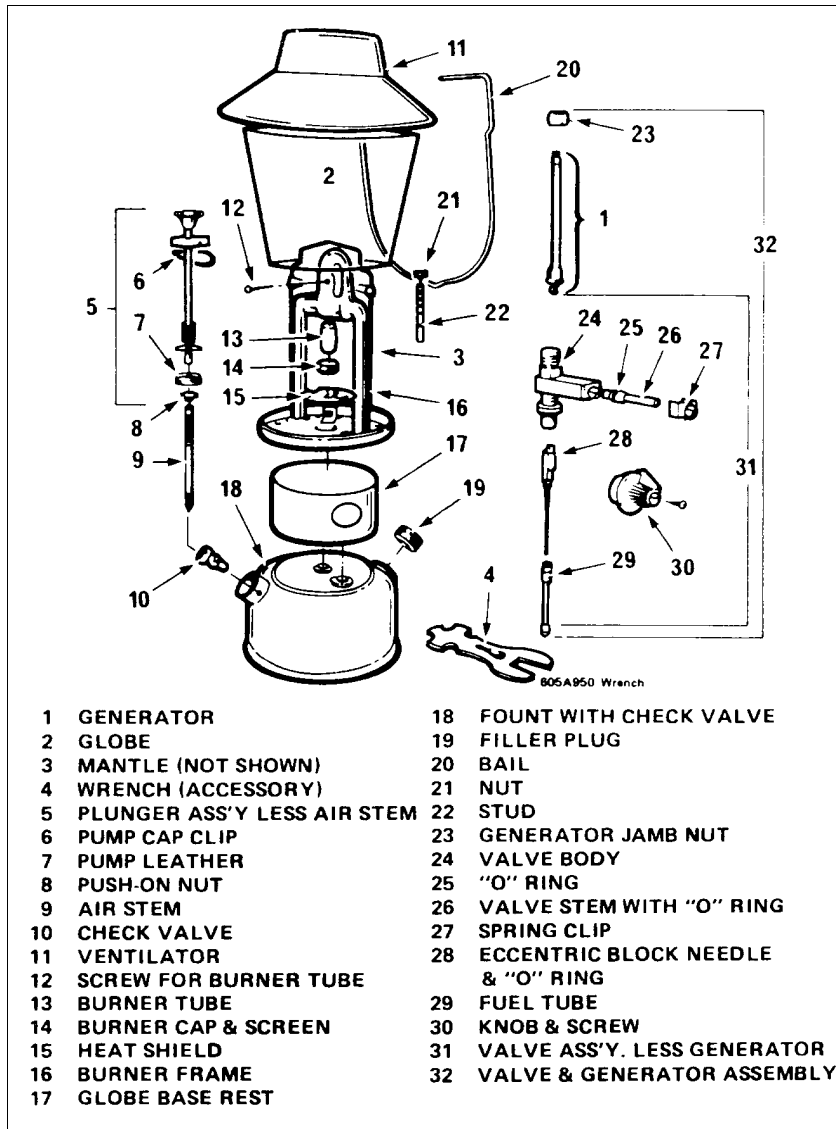

Figure 2-6A Coleman Lantern 621 B



Figure 2-6B Stowage Case

## **220. Stripping, Assembling and User Repairs**

(See Figure 2-6A for stripped lantern details.)

### **1. Replacing and Burning New Mantles**

- a. Remove lantern handle from sockets.
- b. Remove Ventilator and Glass Globe.
- c. Tie Mantle around groove in Burner Cap. Use Mantle number as indicated on Globe Base Rest (Collar).
- d. Distribute folds of Mantle evenly around Burner Cap.
- e. Cut off surplus string.

- f. Light bottom of Mantle and burn evenly until only white ash remains.
- g. Allow Mantles to cool before lighting lantern.
- h. Reassemble lantern making sure Heat Shield is in place.

## 2. Replacing Generator

- a. Remove handle, ventilator and pyrex globe.
- b. Remove the nut from the centre of the valve body.
- c. Remove the burner flame.
- d. Unscrew the generator jamb nut.
- e. Remove and discard the old generator , keeping only the generator jamb nut.
- f. Withdraw the new generator needle out of the new generator tube about 13 mm (1/2 inch).
- g. Place the hook of the generator needle through the eccentric block with the closed side of the generator hook in the cut away portion of the eccentric block.
- h. Holding tile generator tube down, screw on and tighten the jamb nut.
- j. Assemble tile lantern in the reverse order.

## 3. Replacing New Pump Leather

- a. Empty tank of fuel.
- b. Turn Pump Knob to left to open - approximately 12 turns.
- c. Remove Pump Cap Clip and pull out Pump Plunger Assembly.
- d. Remove nut from end of plunger.
- e. Replace Pump Leather.
- f. Push nut onto plunger.
- g. Work several drops of oil into new pump leather, until soft and pliable.
- h. Re-insert Air Stem into plunger and place Pump Plunger Assembly into tank. Be careful that Pump Leather does not fold, crimp or invert when being inserted in tube.
- j. Replace clip and add two or three drops of oil through oiling hole in cover.

## 4. Replacing Valve Stem 'O' Ring

- a. Rotate the handle, ventilator and pyrex globe.
- b. Remove the nut from the staid at the centre of the valve body.
- c. Remove (lie burner frame.
- d. Remove the screw in the control knob and pull knob from the valve stem.
- e. Remove spring clip.
- f. Pull out valve stem.
- g. Remove pieces of the 'O' Ring and replace with a new 'O' Ring.
- h. Assemble in reverse order.
- j. Pump up lantern to test the valve stem for leaks.

## **221. Operation**

### 1. To Fill

- a. Always fill lanterns outside of shelters.
- b. Remove the filter plug and using a filter funnel, fill the tank with naphtha gasoline. This is the only type of gasoline this lantern will burn properly.
- c. Replace the filter plug and tighten firmly with the fingers.
- d. The lamp will burn from six to eight hours.

### 2. To Pump

- a. Ensure that the Control Knob is at the "OFF" position.
- b. Turn the pump rod handle to the left three turns, placing the thumb on the hole in the pump rod handle and pump 30 to 35 full strokes.
- c. Turn pump rod handle to the right until tight.

### 3. To Light

- a. Insert lighted match through hole in bottom of burner frame.
- b. Turn Control Knob to "LITE" position.
- c. When Mantle burns "BRIGHT WHITE", turn Control Knob to "ON" position.
- d. Add more air pressure to tank. Air pressure may be added while lantern is in operation. Good air pressure is important for maximum light output.

4. To extinguish, turn Control Knob to "OFF" position.

## **222. Light Discipline**

Pressure lanterns produce a brilliant light. In operations a door shade should be constructed and the lantern dimmed by turning up the gas tip cleaning lever. If a shade is not constructed, the lantern must be extinguished when the door of the tent or shelter is opened, otherwise, a flash light, visible for miles, will be produced.

## **223. Care and Maintenance**

1. Care and maintenance must cover the following:

- a. Always use clean naphtha gas.
- b. Use a filter funnel.
- c. Clean the tank at least once each month.
- d. Oil the pump leather at least once each month.

- e. When the control knob is turned from the "OFF" position to the "LITE" position, it passes the "CLEAN" position. When this occurs, a needle inside the generator cleans the Orifice of dirt, etc., allowing fuel to reach the mantle.
- f. Should light begin to pulsate or grow dim, add more air pressure and turn Control Knob to "CLEAN" position and back to "ON" position. If condition continues, it may be the lantern requires refining.
- g. When using the wrench, be careful not to strip the threads.

## **224. Safety Precautions**

- 1. The following safety Precautions must always be adhered to:
  - a. Make sure that the filler plug is tightly closed before pumping the lantern, otherwise gas will escape and may ignite.
  - b. Do not release the pressure near another burning lantern or stove. Escaping gas or fumes may ignite.
  - c. Release the pressure after the lantern has been turned off and is cool. Do this outside the tent or shelter.
  - d. Keep a burning lantern away from any inflammable material (to liners, dry clothes, etc).
  - e. When a lantern is burning, keep your shelter or tent well ventilated.
  - f. The lantern should never be placed in a position over a stove because this causes a pressure build up in the fuel container and there is the likelihood of an explosion.

## **225. Common Faults and Remedies**

- 1. Generator
  - a. Fault. No gas comes through the generator to the mantle. This is caused by the generator being completely carboned up or the tip of the gas cleaning needle has been sheared off and is jammed in the generator tip.
  - b. Remedy. Replace generator.
  - c. Fault. The lantern will not burn with a bright white light. This is caused by the generator being almost clogged up by carbon or when the generator was replaced, the generator needle became disengaged from the eccentric block.
  - d. Remedy. Remove generator. Check the position of generator needle. If disengaged, engage needle; if needle was engaged, replace with new generator.
  - e. Fault. The lantern burns with a flickering white and yellow light. This is caused when the tip of the cleaning needle has been burned or blunted from cleaning the carbon from the gas tip and as a result it cannot completely clean the opening of the gas tip.
  - f. Remedy. Replace generator.

2. Burner Cap

- a. Fault. When the lantern is lit, the fuel does not burn in the mantle in an even bright light but burns with a jet of flame and blows out the bottom of the mantle. This happens when a part of the screen in the burner cap has been burned away or the screen has fallen out of the burner cap.
- b. Remedy. Replace burner cap; if no new burner cap is available, and the screen of the burner cap has fallen out but not burnt, replace in burner cap and clinch in place with a pair of pliers. This is only a temporary repair and the burner cap must be replaced with a new one at the first opportunity.

3. Pump.

- a. Fault. There is no pressure or there is a lack of pressure on the downward stroke. This is caused by one of the following:
  - (1) Pump leather placed on pump incorrectly or the pump leather creased, curled, or folded back on itself when the pump was being assembled.
  - (2) Pump leather worn out.
  - (3) Pump leather dry.
  - (4) Ice on the pump leather. This generally happens after the stove has been turned off and in the process of cooling, moisture condenses on the Pump leather. As the stove cools this will freeze and as a result when the stove is pumped, the ice riding between the pump leather and the pump tube will allow the air to escape.
  - (5) Pump leather nut has become unscrewed. This along with the pump leather will remain at the bottom of the air stem and will not move when the pump rod is drawn up.
- b. Remedy. See art 220-3.

4. Filler Plug. See stove C1B1 art 237-3.

**226. Conclusion**

1. Efficient operation depends upon a good knowledge of lanterns and proper maintenance.
2. Safety precautions must be strictly enforced.

## SECTION 5 - STOVES M1950 C1B1 AND COLEMAN MODEL 431 TWO BURNER

### 227. General

1. In cold weather operations or undergoing cold weather training a vital necessity is hot food and drink. To aid you in the preparation of these you are issued with gasoline stoves.
2. Heat for tents or shelters and all cooking is supplied by gasoline stoves. Every soldier must be capable of operating and maintaining stoves under all weather conditions. Issue stoves are efficient only if given proper care.

### 228. M1950 Stove

1. Characteristics. The M1950 stove is a most efficient item of equipment with characteristics that make it particularly suitable for field operations, in cold weather. The main characteristics are:

- a. When shielded from the wind, it can be used in temperatures down to  $-52^{\circ}\text{C}$ .
- b. Operates on naphtha or leaded fuel (but naphtha is preferable).
- c. Burns for approximately 2 1/2 hours on three-quarters of a tank, of fuel.
- d. Flame can be quickly extinguished.
- e. Capable of operating with a clean, smokeless flame.
- f. Easily ignited in cold weather.
- g. Hazards are few if proper precautions are taken.
- h. Does not rattle when man-packed.
- j. Easy to refuel.
- k. No obnoxious odours.
- m. Fuel in tank will not spill when being carried in any position.
- n. Cools off quickly.
- p. Easily cleaned and repaired.

### 2. Technical Data

- a. Weight of stove - 0.7 kg with spare parts.
- b. Weight of container - 0.3 kg.
- c. Weight complete - 1 kg.
- d. Capacity of tank (three-quarters full) - 340 ml (1/13 litre).
- e. Approximate burning time - 2 1/2 hrs.

3. Container. The container has two parts, the top (or lid) and the bottom. There are two knobs punched out from the inside bottom of the container. The lid has two vertical and two horizontal slots. To close the container, place the lid so that the vertical slots of the lid are over the knobs of the bottom, push down and turn clockwise. The first set of slots are used if carrying rags or cleaning materials in the top of the stove. The second set of slots are used if no cleaning materials are carried. The container should not be used to Treat drinking liquids nor should cooked food be placed directly into it as it is almost always contaminated with fuel and under

field conditions it is impossible to get rid of this contamination completely. In an emergency, the container can be used for heating cans of food.

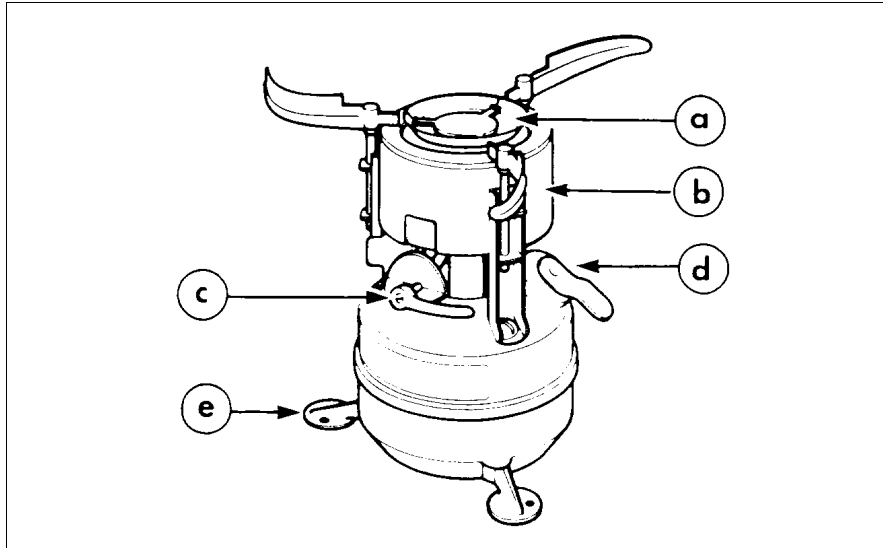

Figure 2-7 Stove M 1950

## 229. Description

1. The main outer parts are as follows:
  - a. Burner Head. This consists of the baffle plate, stem, and cup. The baffle plate in the centre of the burner head initially halts the stream of raw gasoline and allows it to drip down into the cup. The burner head is heated by igniting the gasoline. The baffle plate now spreads the vaporized gasoline and forces it to burn with a circular flame.
  - b. Cook Stand. The cook stand consists of a wind guard, three extension arms, and three legs, the wind guard has a small rod attached to one side which acts as a control valve stop. The legs attached are fastened to the tank by three screws. The extension arms can be swung outwards and locked into slots in the wind guard to support cooking utensils.
  - c. Control Valve. The control valve and plastic handle are fastened at right angles to the centre piece which screws into the tank.
  - d. Pump Assembly. Pump assembly is fitted into the tank filling hole and is held in place by a pump cap clip.
  - e. Legs. Three folding legs are attached to provide a stable platform.



## 230. Stripping and Assembling

(See Figure 2-7A for stripped stove and list of parts)

### 1. Cook Stand

- a. To strip, remove the three screws securing the stand to the tank using a screwdriver or pump handle flange.
- b. To assemble, replace in the reverse order ensuring that the indentation on the side of the wind guard containing the control valve stop rod is placed over the control valve handle.

### 2. Burner Head

- a. To strip, remove the cook stand.
- b. Unscrew the burner head anti-clockwise.
- c. To replace, screw hand tight.
- d. Replace the cook stand.

### 3. Generator

- a. To strip, remove the cook stand.
- b. Remove the burner head.
- c. Unscrew the jamb nut with the cup attached and lift off.
- d. Keep the control valve handle at the OFF position. Lift up the generator tube far enough so you can see the lower end of the automatic cleaning needle. Disengage this needle from the hole in the eccentric block.
- e. To replace, pull down the lower or hooked end of the cleaning needle and with the control valve handle at the OFF position, insert the hooked end of the needle into the hole at the top of the eccentric block. Hold the generator upright with one hand and place the jamb nut with attached cup over the top and screw down. Tighten with a wrench.

### 4. Pump Assembly

- a. To strip, unscrew the pump cap clip and remove the pump assembly from the stove.
- b. To separate the two brass tubes, unscrew the two milled head retaining rings. Remove the inner tube from the outer tube.
- c. To remove the leather pump plunger from the bottom end of the inner tube, unscrew the pump screw and remove the brass washer and pump leather plate. The pump leather will now be loose.
- d. From the top of the inner tube unscrew the pump handle. The inner tube should contain the following spare parts:

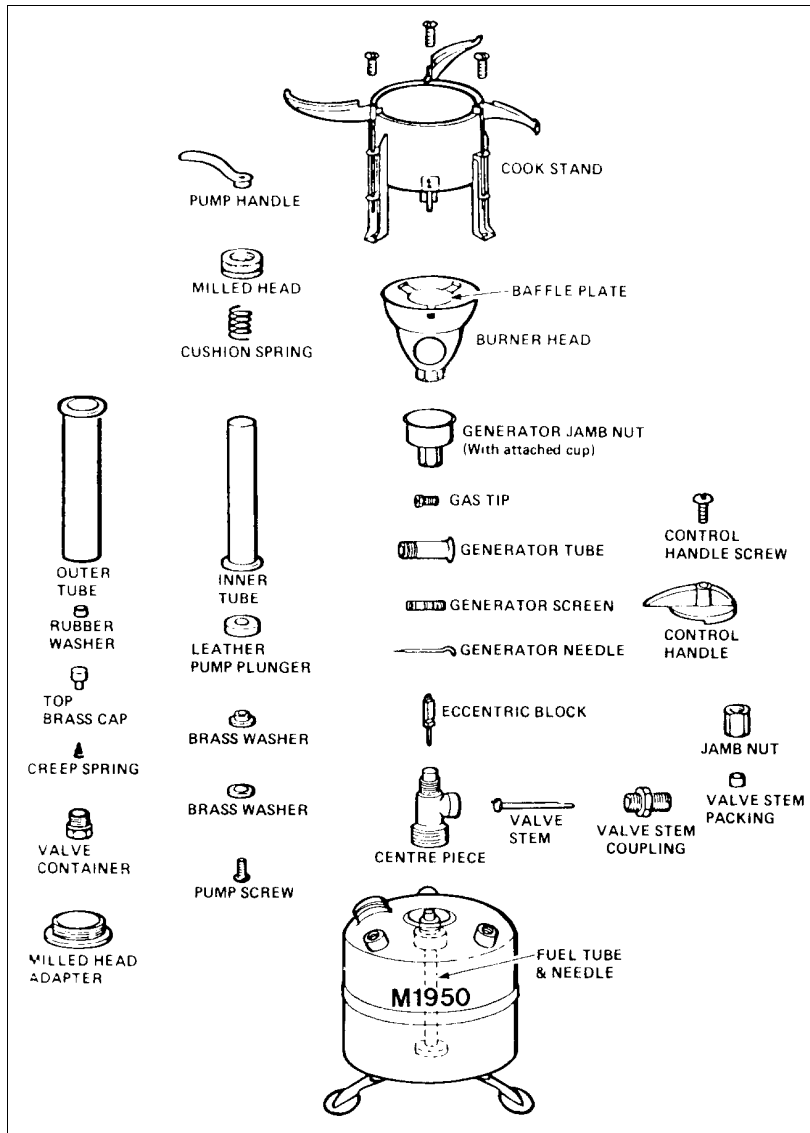

Figure 2-7A Stove M1950

- (1) One rubber washer for the groove under the lip of the outer tube to seal the pump assembly to the filling hole.
  - (2) One air valve assembly complete with spring.
  - (3) One length of graphite.
  - (4) One pump leather.
  - (5) One generator.
- e. When packing the spare parts, the leather and rubber washers should be packed last.
  - f. To remove the air valve assembly from the bottom end of the outer tube, unscrew the valve container. With this off, (lie creep spring and brass top cap topped with a rubber will drop out.
  - g. To assemble reverse the above stripping sequence.

## 231. Common Faults, Stoppages, and Remedies

1. Experience has proven that during winter usage, stoppages in the stove operation becomes prevalent. In many instances, users are prone to exchange the stove for a new one because they do not understand the reason for the stoppages and a logical sequence for making user repairs:

### a. Generator

- (1) Fault. Stove burns in spurts. This happens when the gas tip aperture starts to become fouled with carbon and will not permit the cleaning needle to clear the fouling.
- (2) Remedy. Replace generator.
- (3) Fault. No gas comes through the generator to the burner head. This happens when the gas tip is completely fouled by carbon or the tip of the cleaning needle has become brittle and has snapped off jamming the gas tip aperture. This will not be apparent as the gas needle still can be operated by the control handle.
- (4) Remedy. Replace generator.
- (5) Fault. The stove loses its roar and burns with a low flame. This will happen when the screen in the generator is starting to clog up.
- (6) Remedy. Replace generator.
- (7) Fault. Stove burns with a low yellow flame. This will take place when the generator screen is almost clogged up or the aperture of the gas tip cannot be cleaned by the cleaning needle.
- (8) Remedy. Replace generator.
- (9) Fault. Stove burns with a high yellow flame. This will occur when the baffle plate of the burner head and the generator was not given enough time to pre-heat.
- (10) Remedy. Carry out proper lighting drill.

### b. Pump

- (1) Fault. No pressure or lack of pressure on downward stroke. This can be caused by one of the following:
  - (a) Incorrectly assembled pump leather. This happens when the inner tube is inserted into the outer tube and the pump leather folds back on itself or it gets a crease in it allowing air to escape.
  - (b) Ice on pump leather. This generally happens after the stove has been turned off and in the process of cooling, moisture will condense on the pump leather. As the stove cools this will freeze and as a result, when the stove is pumped up the ice riding between the pump leather and the surface of the inner tube allows air to escape,

- (2) Remedy. To remedy the above faults, inspect tile pump leather and carry out one of the following:
  - (a) Replace with new pump leather.
  - (b) Replace pump leather correctly.
  - (c) Oil pump leather.
  - (d) Clean ice off pump leather.

c. Air Valve Assembly

- (1) Fault. When pumping up the stove, gas sprays out of the pump. This is caused by an incorrectly placed air valve.
- (2) Remedy. To remedy this, remove the valve container and assemble it correctly. To do this the rubber washer must be placed between the outer tube and the recess in the top brass cap. The small end of the creep spring is fitted over the small stud of the top brass cap. Then the valve container is screwed on.
- (3) Fault. Gas sprays out when pumping or the inner tube rises slowly and then a gas leak develops. This is caused by a worn air valve rubber.
- (4) Remedy
  - (a) Replace with a new air valve.
  - (b) If no new parts are available, reverse the rubber in the top brass cap. This is only a temporary repair and must be corrected with new parts at the first opportunity.
- (5) Fault. When pumping up the stove the pressure takes a long time to build up and drops quickly. There may also be a slow leak at the bottom of the milled heads. This is caused by one of the following:
  - (a) The pump is not screwed in tightly.
  - (b) The rubber gasket under the lip of the outer tubes may be worn out.
  - (c) When the stove was being filled, the pump may have some snow in the nailed heads. When the pump was screwed in, this snow was compressed and formed ice, not allowing the gasket to make an air tight seal.
- (6) Remedy. To remedy this, carry out one of the following:
  - (a) Screw the pump in tight.
  - (b) Replace the gasket.
  - (c) Clean the ice off the gasket.

d. Valve Stem Packing

- (1) Fault. After steady usage a leak may develop from the jamb nut and gas will drip down onto stove and ignite.
- (2) Remedy. Tighten jamb nut; if this does not stop the leak, remove the small screw from the centre of the control handle, unscrew the jamb nut and remove the old piece of valve stem packing, (short length of graphite). Replace with a new piece and tighten jamb nut. Do not tighten up any more than is necessary to stop the gas leak as this also regulates the tension of the control handle.

- e. Centre Piece
- (1) Fault. At times a very slow leak will develop at the juncture of the centre piece and the tank. When the gas leaks out it spreads over and down the tank. When the stove is burning, the heat causes some of this seepage of gas to vaporize. When the rising fumes come in contact with the flame, they ignite and in turn ignite the raw gas on the tank of the stove. A gas leak at the centre piece and tank will probably not be noticed until this action takes place. Do not attempt to extinguish the stove in the tent. Get the stove outside as quickly as possible by any available means and smother the stove in snow. When the flame is out, turn the control handle to off and release the pressure from the tank. Releasing the pressure from the tank will stop the gas leakage as the control valve is above the leak.
  - (2) Remedy. Tighten up the centre piece slightly. This will throw the valve control handle off centre but the stove will, still operate.
- f. Burner Head
- (1) Fault. Over a period of long steady use the flame from the stove will be funnelled off to one side of the baffle plate. This is caused by a build up of carbon on the underneath side of the baffle plate.
  - (2) Remedy. Remove the burner head and with a screwdriver or other tool scrape off the build up of carbon.

### **232. Filling**

1. Filling should be carried out as follows:
  - a. Always fill the stove in the open.
  - b. Remove the pump assembly and fill three-quarters full with naphtha using a filter funnel.
  - c. Replace the pump assembly inspiring the milled heads are screwed on hand tight.

### **233. Lighting**

1. In operations or when undergoing operational training where concealment is considered mandatory by the officer in charge, stoves may be lit under cover or in a tent. Lighting will only be carried out after all excess fuel has been carefully wiped off the stove and the stove has been moved to the highest or centre part of the tent or shelter. Under all other conditions stoves will be lit in the open.
2. The method of lighting is as follows:
  - a. Ensure the control handle is in the OFF position.
  - b. Pump seven full strokes.
  - c. Turn the control handle to the ON position for three seconds to fill the cup and turn to the OFF position.
  - d. Apply a lighted match and allow to burn until the flame dies, to a low height.

- e. Turn the control handle to the LIGHT position (control handle pointing straight up and down), and wait for the flame to turn blue.
- f. When the stove is burning with a steady blue flame turn the control handle to the ON position.
- g. Pump another seven full strokes.

Note: If the stove has too much pressure in the tank because of overpumping, the increased amount of gas being forced up through the generator to the baffle plate will become a cooling agent. This increased flow will cool the burner parts enough to stop the gas from being vaporized. This will result in a high yellow flame.

### 234. Stove C1B1

1. The C1B1 stove has similar characteristics to the M1950 stove, but with differences as follows:

- a. It is a pressure gasoline burning stove in which only naphtha gasoline can be used.
- b. It burns approximately four hours on a tank of fuel (1/2 litre).
- c. The flame produces more heat and its height can be controlled.
- d. It has a larger, steadier cooking platform.

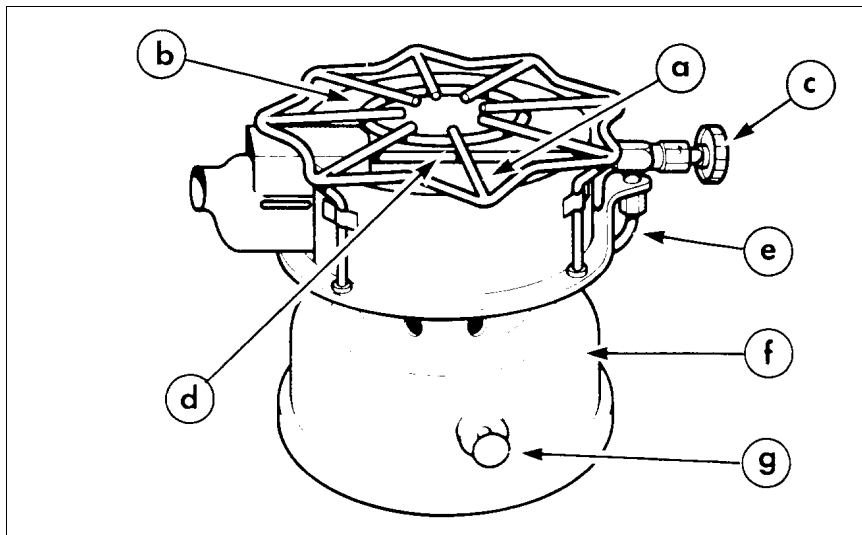

Figure 2-8 Stove C1B1

## 235. Description

1. The main outer parts as shown in Figure 2-8 are:
  - a. Burner Head. This consists of the burner head, base plate and base rest fastened to the fuel tank by two screws. Two additional screws fasten the burner head to the base plate. The burner head's function is to vaporize the gasoline before ignition.
  - b. Cook Stand. This consists of a top grill with four legs fitting through metal loops fastened to the wind guard and bolted to the base plate.
  - c. Control Valve Assembly. This consists of the valve wheel, nut, and body. Its function is to regulate the flow of pressurized raw gasoline from the fuel tank through the generator to the burner head.
  - d. Generator. This consists of a tube, gas tip, jamb nut, spring, and needle. The whole assembly is connected to the valve body with the needle being connected to the valve wheel. Its function is to vaporize the raw gasoline and control the flow in conjunction with the valve assembly.
  - e. Fuel Line. The fuel line is a metal tube connecting the gas regulator soldered to the top of the tank to the control valve assembly.
  - f. Fuel Tank
  - g. Pump Assembly. The pump assembly is fitted into the fuel tank by a separate aperture and not into the filling hole as for the M1950 stove. It is held in place by two small screws.

## 236. Stripping and Assembling

(See Figure 2-8A for stripped stove and list of parts).

1. Generator
  - a. Unscrew the fuel line nut and with the nut loose, disengage the fuel line from its recess in the valve assembly.
  - b. Loosen the lock nut. This is right above the fuel nut screwed onto the valve assembly.
  - c. This frees the control valve assembly and allows the assembly and generator to be removed from the stove.
  - d. To remove the generator from the valve assembly, unscrew the jamb nut and slide the generator tube and spring off the generator needle.
  - e. Unscrew the valve nut until it is free of the valve body. With this nut free, unscrew the valve wheel until it, along with the generator needle can be withdrawn from the valve body.

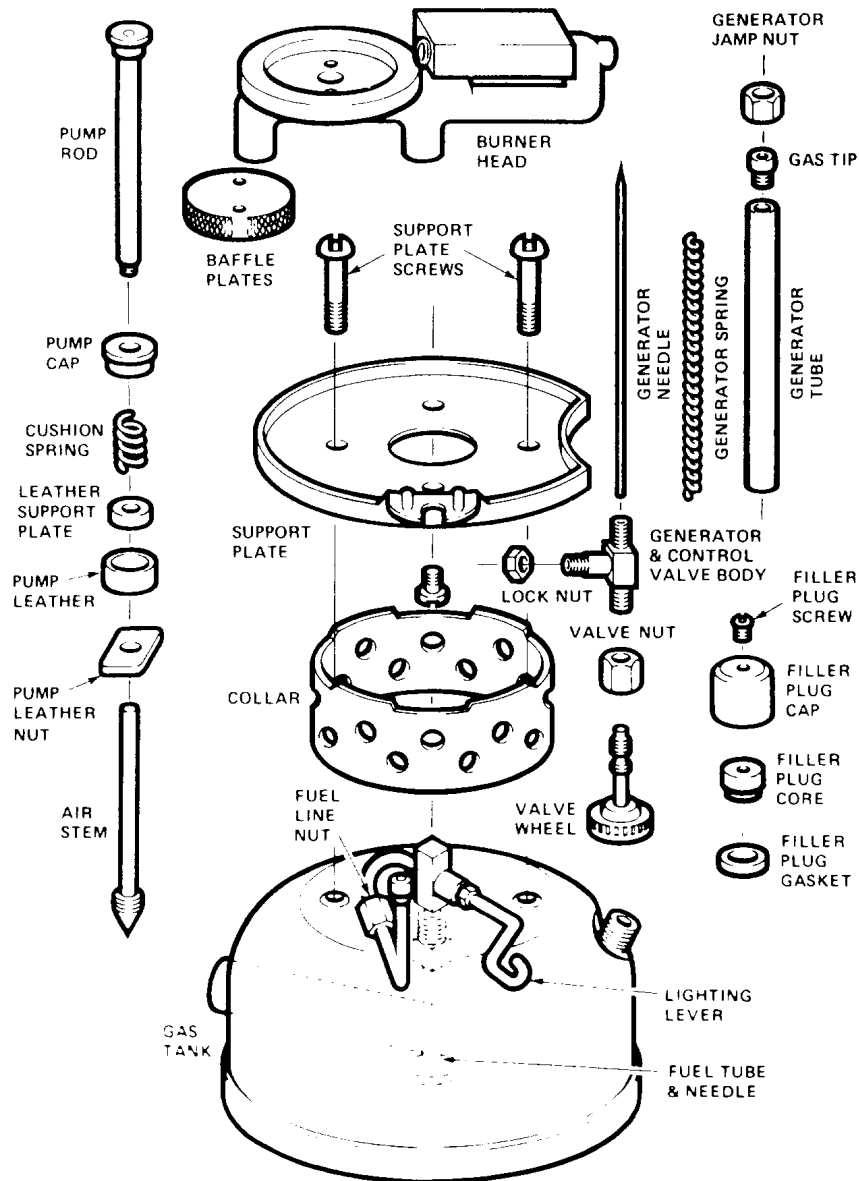

Figure 2-8A Stove C1B1

- f. To separate the valve wheel from the generator needle, grasp the generator needle with a pair of pliers and unscrew the valve wheel.
- g. Assemble in reverse order, being careful not to strip or crossthread any of the four nuts. Particular care must be taken when tightening the generator needle into the valve wheel stem. This needle is made of soft metal and twists off with only a slight bit of tension. With the valve wheel and generator needle assembled and in the valve body, then, after tightening the valve nut, the valve wheel must be unscrewed to allow a proper seating of the gas tip of the generator tube to the tip of the generator needle. When the jamb nut has been tightened securing the generator tube to the valve body, then scate the tip of the generator needle by screwing in the valve wheel until it is tight.



## 2. Pump

- a. Turn the pump handle clockwise to ensure the air stem is closed.
- b. Remove the two screws from the side of the pump cap.
- c. Withdraw the pump from the tank. The air stem will remain in the tank and must be left in the closed position to prevent the escape of any fuel.
- d. From the pump, unscrew the pump leather nut. The pump leather will now slide off.
- e. Unscrew the pump leather support plate. The cushion spring and pump cap will now slide off the pump rod.
- f. Assemble in reverse order. When replacing the pump in the tank, make sure that the pump leather does not crease, curl, or fold back on itself. This is easily done by rotating the pump slightly. This rotating motion also lines up the square end of the air stem and the square hollow of the pump rod.

## 3. Filler Plug

- a. Unscrew the filler plug from the tank.
- b. Unscrew the filler plug screw from the filler plug core. This screw fits loosely through the filler plug.
- c. Remove the filler plug gasket from the filler plug core.
- d. Assemble in the reverse order.

## **237. Common Faults, Stoppages, and Remedies**

### 1. Generator

- a. Fault. No gas comes through the generator to the burner. This happens when the generator is completely carboned up or the tip of the generator needle is sheared off and is jammed in the end of the gas tip preventing any fuel from getting through.
- b. Remedy. Replace generator.
- c. Fault. Stove will only burn with a low yellow flame. This happens when the generator is just about clogged up from carbon.
- d. Remedy. Replace generator. There is no use trying to strip the generator to clean it, as most of the carbon is concentrated on or between the generator tube and the generator spring. This cooks or welds the spring to the tube. When the generator is in this condition, the only way to remove the spring is by pulling it out with a pair of pliers and this stretches the spring hopelessly out of shape.
- e. Fault. The stove will not burn with a blue flame; it roars and flares. This happens when the gas tip has carboned up and the generator needle is bent or twisted due to it being forced against hard carbon.
- f. Remedy. Replace generator.
- g. Fault. The stove burns with a low yellow flame with raw gas in the bottom of the burner head. This is caused by the stove being flooded.

h. Remedy. Carry out proper lighting drill.

## 2. Pump

a. Fault. There is no pressure or there is a lack of pressure on the downward stroke. This is caused by one of the following:

- (1) Pump leather placed on pump incorrectly or the pump leather creased, curled, or folded back on itself when the pump was being assembled.
- (2) Pump leather worn out.
- (3) Pump leather dry.
- (4) Ice on the pump leather. This generally happens after the stove has been turned off and in the process of cooling, moisture condenses on the pump leather. As the stove cools this will freeze and as a result when the stove is pumped, the ice riding between the pump leather and the pump tube will allow the air to escape.
- (5) Pump leather nut has become unscrewed. This along with the pump leather will remain at the bottom of the air stem and will not move when the pump rod is drawn up.

b. Remedy. To remedy any of these faults carry out one of the following:

- (1) Check position of pump leather.
- (2) Replace pump leather.
- (3) Oil pump leather.
- (4) Remove any ice from pump leather.
- (5) Remove the pump rod, the air stem may have to be removed to recover the pump leather and the pump leather nut. Replace on pump rod.

## 3. Filler Plug

a. Fault. When the stove is pumped up or is being pumped up and gas either sprays out or leaks out of the filler plug, one of the following will be the cause.

- (1) Filler plug not tight.
- (2) Ice in filler plug.
- (3) Gasket of filler plug worn out.

b. Remedy. To remedy any of the faults, carry out one of the following:

- (1) Tighten filler plug hand tight.
- (2) Remove any ice from filler plug gasket.
- (3) Replace filler plug gasket.

## 4. Baffle Plates.

a. Fault. When the flame burns unevenly and of light yellow colour, it indicates that foreign objects are blocking the baffle plate openings.

b. Remedy. Remove the two retaining screws, baffles, and spacers, and clean with steel wool. Then reassemble and when tightening down the screws ensure

pressure is equal on both sides of the baffle plates. Light the stove. Flame should burn blue and even around the baffle openings. If not, adjust when burning, with screwdriver.

### **238. Filling**

1. Always fill the stove in the open.
2. Remove filler plug and fill stove.
3. Replace filler plug, hand tight.

### **239. To Pump**

1. Make sure the generator valve is closed.
2. Turn the pump rod two full turns to the left.
3. Place the thumb over the air vent of the pump rod handle.
4. Pump thirty to forty full strokes.
5. Turn the pump rod to the right until it is closed tight.

### **240. Lighting**

1. In operations or when undergoing operational training, where concealment is considered mandatory by the officer in charge, stoves may be lit under cover or in a tent. Lighting will only be carried out after all excess fuel has been wiped off the stove and the stove has been moved to the centre or the highest part of the tent or shelter. Under all other conditions stoves will be lit in the open.
2. Make sure the lighting lever is in the light position.
3. Hold a lighted match to the burner cap and open the generator valve two full turns to the LEFT. When the stove has been burning for one minute, turn the lighting lever to the burn position.
4. After turning the lighting lever to the burn position, turn the generator valve wheel either to the RIGHT or LEFT to adjust the amount of flame required. Keep the flame as low as possible. Fuel conservation is of paramount importance.

### **241. Care and Maintenance**

1. Care and maintenance should cover the following:

- a. Use only naphtha gasoline.
- b. Use a filter funnel when filling the stove.
- c. Clean the gas tank at least once a month.
- d. Keep the pump leather soft by applying a few drops of oil each month.
- e. Handle with care. Do not force the parts and carry all the necessary spare parts.

#### 242. Stove Coleman Model 431 - Two Burner Stove

1. Characteristics. The Coleman Model 431 stove is an efficient item of equipment with characteristics that make it particularly suitable for field operations in cold weather. Its main characteristics are:

- a. When shielded from the wind, it can be used in temperatures down to  $-52^{\circ}\text{C}$ .
- b. Operates on naphtha.
- c. Flame can be quickly extinguished.
- d. Capable of operating with a clean, smokeless flame.
- e. Easily ignited in cold weather.
- f. Hazards are few if proper precautions are taken.

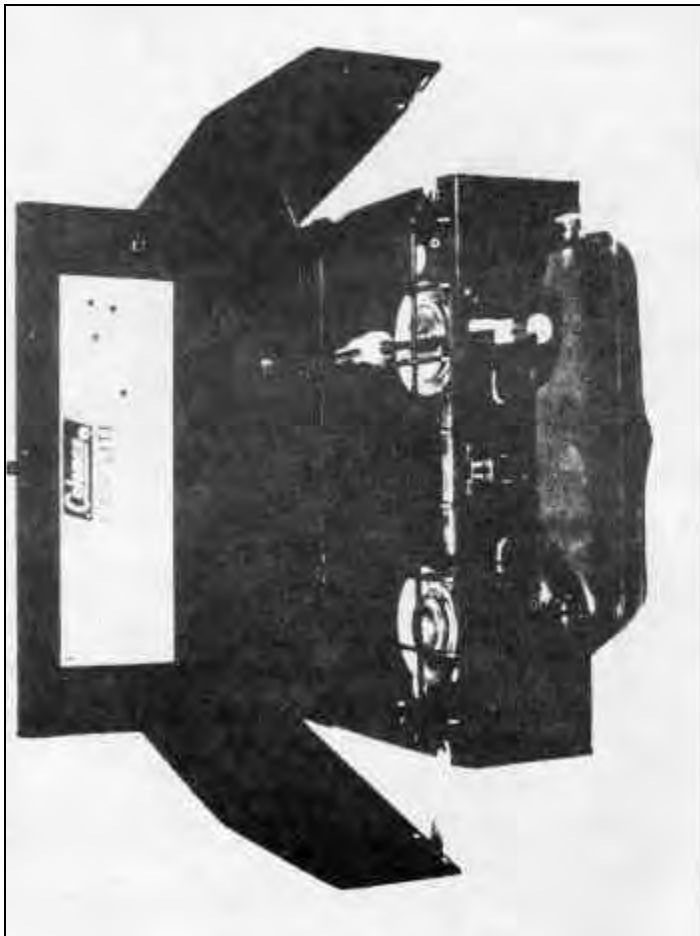

Figure 2-8B Stove Coleman Model 431 Two Burner

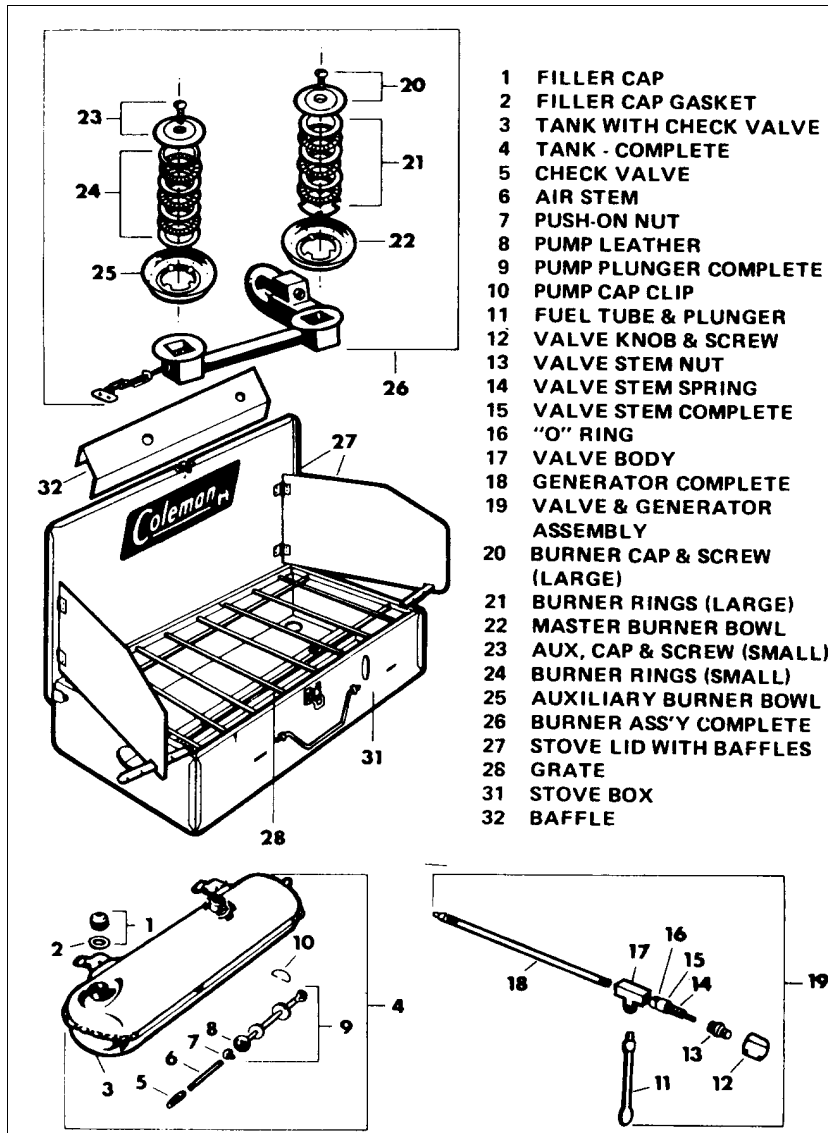

Figure 2-8C Stove Coleman Model 431 Two Burner

- g. Does not rattle when man-packed.
- h. Easy to refuel.
- j. No obnoxious odours.
- k. Fuel in tank will not spill when being carried in any position.
- m. Cools off quickly.
- n. Easily cleaned and repaired.

## 243. Description

1. The main outer parts are as follows:
  - a. Stove Box. This is the container in which the burner assemblies are stored along with the fuel tank and generator assemblies.

- b. Control Valve Assembly. This consists of the valve wheel, nut and body. Its function is to regulate the flow of pressurized naphtha from the fuel tank through the generator to the burner head.
- c. Main Burner Head. The main burner head is located on the right of the stove and consists of a burner cap and screw (small) along with a series of large burner rings. The entire assembly sits in a large burner bowl. The main burner control knob is located on the valve and generator assembly.
- d. Auxiliary Burner Head. The auxiliary burner head is located on the left of the stove and consists of a burner cap and screw (small) along with a series of small burner rings. The entire assembly sits in a small burner bowl. The auxiliary burner control is located in the left end of the stove box.
- e. Pump Assembly. Pump assembly is fitted into the tank filling hole and is held in place by a pump cap clip.
- f. Fuel Tank
- g. Wind Baffles
- h. Stove Grate

#### **244. Stripping and Assembly**

1. To replace the generator:
  - a. Unscrew the generator from the valve assembly using a pair of pliers. Discard old generator.
  - b. To separate the generator needle from the valve assembly, grasp the needle with a pair of pliers and unscrew from the valve assembly. Discard old needle.
  - c. Replace with new generator and assemble in the reverse order.
2. To replace pump leather:
  - a. Empty tank of fuel.
  - b. Turn Pump Knob to left to open - approximately 12 turns.
  - c. Remove Pump Cap Clip and pull out Pump Plunger Assembly.
  - d. Remove nut from end of plunger.
  - e. Replace Pump Leather.
  - f. Push out onto plunger.
  - g. Work several drops of oil into new pump leather, until soft and pliable.
  - h. Re-insert Air Stem into plunger and place Pump Plunger Assembly. into tank. Be careful that Pump Leather does not fold, crimp or invert when being inserted in tube.

#### **245. Common Faults, Stoppages and Remedies**

1. Generator
  - a. Fault. No gas comes through the generator to the burner. This happens when the generator is completely carboned up or the tip of the generator needle is sheared off and is jammed in the end of the gas tip preventing any fuel from getting through.
  - b. Remedy. Replace generator.

- c. Fault. Stove will only burn with a low yellow flame. This happens when the generator is just about clogged up from carbon.
- d. Remedy. Replace generator.
- e. Fault. The stove will not burn with a blue flame; it roars and flares. This happens when the gas tip has carboned up and the generator needle is bent or twisted due to it being forced against hard carbon.
- f. Remedy. Replace generator.
- g. Fault. The stove burns with a low yellow flame with raw gas in the bottom of the burner head. This is caused by the stove being flooded.
- h. Remedy. Carry out proper lighting drill.

## 2. Pump

- a. Fault. There is no pressure or there is a lack of pressure on the downward stroke. This is caused by one of the following:
  - (1) Pump leather placed on pump incorrectly or the pump leather creased, curled, or folded back on itself when the pump was being assembled.
  - (2) Pump leather worn out.
  - (3) Pump leather dry.
  - (4) Ice on the pump leather. This generally happens after the stove has been turned off and in the process of cooling, moisture condenses on the pump leather. As the stove cools this will freeze and as a result when the stove is pumped, the ice riding between the pump leather and the pump tube will allow the air to escape.
  - (5) Pump leather nut has become unscrewed. This along with the pump leather will remain at the bottom of the air stem and will not move when the pump rod is drawn up.
- b. Remedy. See art 244-2.

## 3. Filler Plug

- a. Fault. When the stove is pumped up or is being pumped up and gas either sprays out or leaks out of the filler plug, one of the following will be the cause.
  - (1) Filler plug not tight.
  - (2) Ice in filler plug.
  - (3) Gasket of filler plug worn out.
- b. Remedy. To remedy any of the faults, carry out one of the following:
  - (1) Tighten filler plug hand tight.
  - (2) Remove any ice from filler plug gasket.
  - (3) Replace filler plug.

## 246. **Filling**

- 1. Always fill the stove in the open.

2. Remove filler plug and fill stove.
3. Replace filler plug, hand tight.

#### **247. To Pump**

1. Make sure the control knob is in the off position.
2. Turn the pump rod two full turns to the left.
3. Place the thumb over the air vent of the pump rod handle.
4. Pump thirty to forty full strokes.
5. Turn the pump rod to the right until it is closed tight.

#### **248. To Install Tank**

1. Insert generator into large hole in front of stove, then into opening in mixing chamber above the burner.
2. Engage hanger brackets on tank, into slots on front of stove case.

#### **249. To Light Main Burner**

1. Ensure Auxiliary Valve(s) is in closed position and tank is pumped up.
2. Do not lean over stove while lighting.
3. Hold lighted match to master burner.
4. Turn Control Knob to "LITE" position. Burner will light and burn with a high yellow flame.
5. When flame turns blue in colour (approximately one minute), turn Control Knob to the desired heat setting "Hi - Lo".
6. When operating or turning stove to "Lo" position, check flame to be sure that it has not gone out.

NOTE - Should stove fail to light to match go out before ignition, turn Control Knob to the "OFF" position and wait for two minutes before relighting stove.

#### **250. To Light Auxiliary Burner(s)**

1. After master burner has been lit, the Auxiliary Burner may be lighted.



2. Hold match to Auxiliary Burner, open Auxiliary Valve located on end of stove, next to the burner.

NOTE - Master Burner may require adjustment after lighting Auxiliary Burner

### **251. To Shut Off Burners**

1. Close Auxiliary Burner Valve(s).
2. Remove cooking utensils from stove, turn control knob (clockwise) to "LITE" position for 60 seconds, then turn to "OFF" position. Do not force past "OFF" position.

NOTE - Small flame on master burner will continue to burn for a few minutes, until fuel empties from generator.

### **252. To Pack Stove**

1. Allow Stove to cool before packing.
2. Reverse procedure in opening stove. The Tank and Generator assembly go in the left end of the stove, as you face it, with the Control Knob at rear of case.

### **253. Care and Maintenance**

1. Care and maintenance should cover the following:
  - a. Use only naphtha gasoline.
  - b. Use a fitter funnel when filling the stove.
  - c. Clean the gas tank at least once a month.
  - d. Keep the pump leather soft by applying a few drops of oil each month.
  - e. Handle with care. Do not force the parts. Carry all the necessary spare parts.

### **254. Safely Precautions - All Stoves**

1. The following safety precautions are to be taken.
  - a. Make sure the filler plug is tightly closed before pumping the stove otherwise gas will spray and may be ignited.
  - b. Do not release the pressure near another burning stove. If the stove is pumped and the filler plug loosened, gas will spray out or fumes will blow out. If these come in contact with flame, they will ignite.
  - c. Release pressure when the stove has been turned off and is cool. Do this outside.
  - d. Keep a burning stove away from any inflammable material (tent liners, dry clothes, etc).
  - e. When a stove is burning keep your tent or shelter well ventilated.

## **255. Conclusion**

The stove is an important item of tent group equipment. Instructors must stress the need for strict adherence to safety precautions and point out the importance of the requirement for a high standard of maintenance.

## SECTION 6 - TOBOGGANS

### 256. General

1. In cold weather operations troops may be called upon to man-haul for short distance all the weapons, ammunition, and group equipment they need for an operation. For instance, it will normally be necessary to man-haul:

- a. When evacuating casualties to a unit aid post.
- b. When moving arms, ammunition, rations, etc, from a DZ or LZ to the scene of operations.
- c. When it is necessary to move heavy weapons from where they are dropped by parachute or air landed to their firing positions.

2. The accepted method of transporting equipment in cold weather operations when other means of transport are not available is by toboggans. There are two types, the one-man toboggan and the two-man toboggan.

### 257. Loading

1. Whether or not toboggans can be hauled easily depends upon how they are loaded. Regardless of what must be loaded, the following rules should be followed to get the best results:

- a. Loads should be as light as circumstances permit. Non-essential equipment must be eliminated.
- b. Heavy objects should be low and slightly rear of centre. Heavy objects placed too far forward will make steering and hauling difficult.
- c. Long objects should be carried lengthwise on top of the packed load,
- d. The load should be spread evenly along the toboggan.
- e. The loaded toboggan should not be top-heavy or overloaded. Overloading the toboggan will make it difficult to pull.
- f. Place tools you may need on the move, such as shovels, axes, etc, on top of the load where you can get at them easily.

### 258. One-Man Toboggan

#### 1. General

- a. The one-man toboggan weighs approximately 10 pounds and has a load capacity of 100 pounds. It has two runners and six "D" rings on the upper edge, three on each side. There is a white nylon cover in which to pack the load. The towing harness consists of a short web waist-band, at each end of which are metal rings. Attached to each metal ring is approximately eight feet of towing cord (see Figures 2-9 and 2-9A).

- b. The toboggan can be handled by one man, is particularly good for hauling in deep snow, and is easy to manoeuvre in wooded areas. It is very suitable for light loads such as tent group equipment.

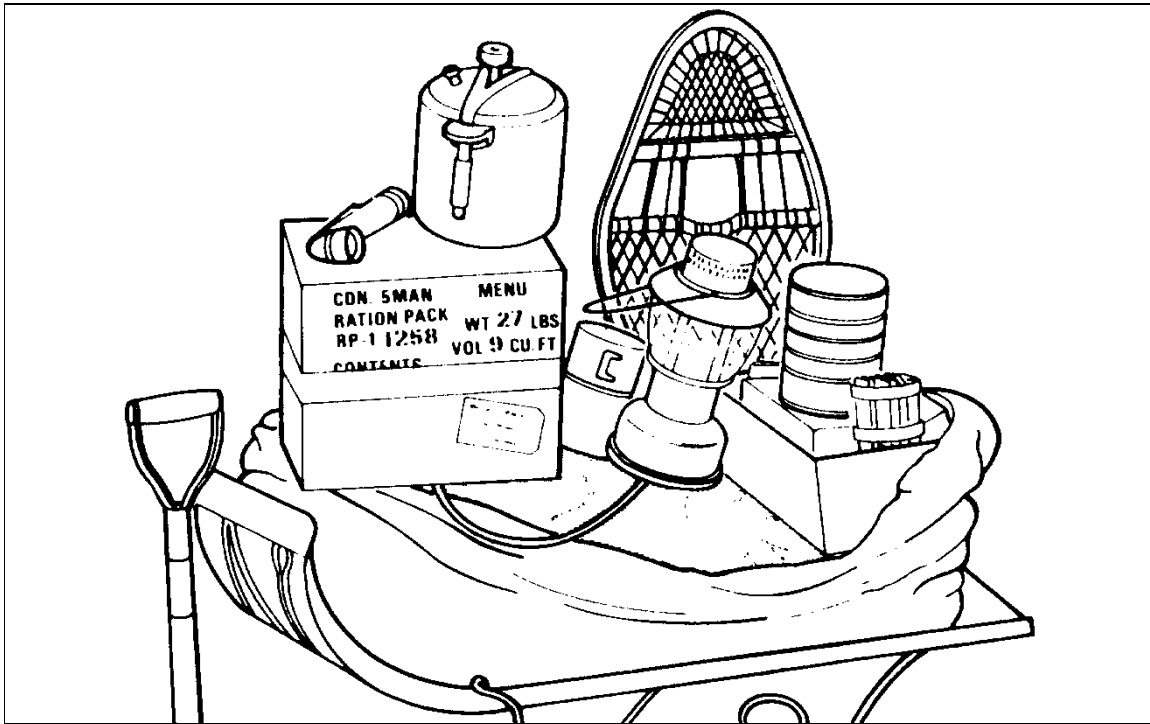

Figure 2-9 One-Man Toboggan Before Lashing

2. Preparing the Lashing

- a. Before loading, the one-man toboggan should have a lashing permanently attached to it. This will take about 25 feet of cord, preferably 3/16 inch nylon. Follow these steps:
- (1) Attach one end of the lashing, using a bowline, to either the left or right front "D" ring. Leave a loop of about five or six inches.
  - (2) Extend the lashing rearwards to the centre "D" ring and attach it with a clove hitch, adjusting the loop forward until it lies approximately half-way across the toboggan.
  - (3) Extend the lashing to the rear "D" ring and again attach it with a clove hitch, leaving the same sized loop as before.
  - (4) Cross the cord over to the opposite rear "D" ring and this time form a loop approximately 10 inches high.
  - (5) Extend the lashing up the opposite side, forcing similar loops.
  - (6) Roll up the rest of the lashing so that it will be ready for use when loading is completed.

3. Attaching Towing Harness

- a. Attach each end of the towing cord, using a bowline, to the two front "D" rings of the toboggan.
- b. Adjust the length of the towing cords so that they are approximately seven feet long and even.
- c. Adjust the web waist-band to hang around your neck, leaving your hands free. To do this tie a piece of light cord through one of the holes near the centre of the waist-band, passing it around your neck and tying it to the other centre hole with a slip knot. The waist-band can then be adjusted to suit your height, the cord around your neck holding it in a comfortable position and leaving your hands free.
- d. When operating in, rolling or hilly country, attach a length of cord to the two rear "D" rings of the toboggan. This will allow a rear man to control it on a down grade.

4. Lashing. Before a move, the toboggan must be properly and securely lashed. Careless lashing may result in the loss of valuable equipment and loose lashing will cause unnecessary hardship for men who have to stop and relash on a cold day. Follow the drill given here to do, a good job (see Figure 2-9A).

- a. Check to ensure that all items fit securely within the nylon cover. The cover has two metal-ringed holes which should be to the front and rear of the toboggan. Secure a piece of cord to one of these holes, pass it through the other and draw the cover together. Secure it with a slip knot or prevent the load from spilling out.
- b. Tuck in and overlap the top of the nylon cover to make sure that the load is well covered.

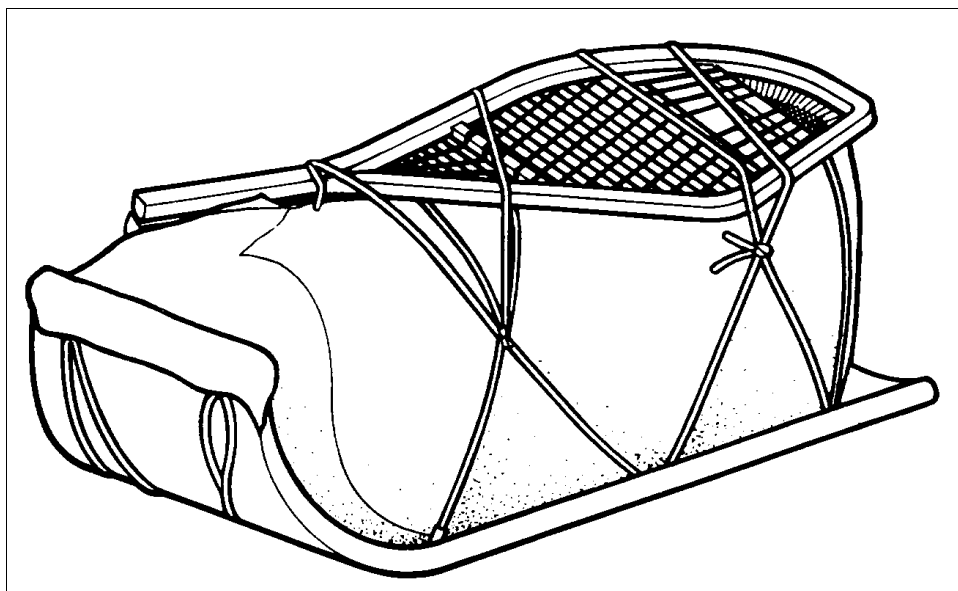

Figure 2-9A One-Man Toboggan Secured

- c. Take the surplus lashing at one end and pass it through the loop formed by the lashing on the rear end and draw tight.
- d. Pass the lashing through the opposite side rear loop and draw tight.
- e. Pass the lashing back through the rear loop and tighten.
- f. Pass the lashing through the opposite side rear loop and draw tight.
- g. Take the lashing diagonally across the load to the opposite front loop and draw tight.
- h. Pass the lashing once again through the loop on the opposite side of the toboggan and pull tight. Then take the free end of the lashing back over the load, pass it through the five or six-inch loop in the bowline at the front "D" ring, pull as tight as possible, and secure with a slip knot.
- j. Tuck the rest of the free end of the lashing cord under the lashing.
- k. Raise the front end of the toboggan and give it several vigorous shakes to test the security of the load and lashing.

5. Care and Maintenance. During a move, bare rocks and gravel patches should be avoided to prevent undue wear on the runners. To ensure a toboggan is in serviceable condition, check the following points:

- a. runners not worn or broken;
- b. lashing "D" rings not broken or cracked;
- c. lashing cord not frayed or broken;
- d. nylon cover not torn; and
- e. harness cords not frayed or broken.

## **259. Two-Man Toboggan**

1. General. The two-man toboggan weighs approximately 35 pounds and has a load capacity of 250 pounds. The white nylon cover has 12 brass books around the edge which are used for lashing. There are five hooks on each side, one at the front, and one at the back. There are two runners and two tow rings, one at the front and one at the rear. Attached to the rear of the toboggan is a hooped handle-bar which can be folded over the toboggan. This handle-bar is used to assist in pushing and steering. Each toboggan normally has two sets of towing harness (similar to the harness provided with the one-man toboggan) (see Figure 2-10).

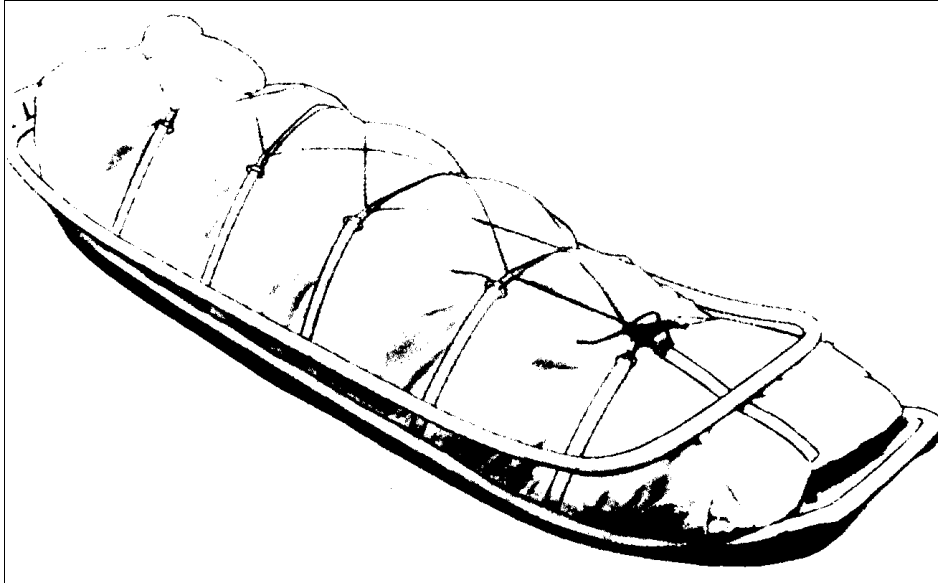

Figure 2-10 A Properly Lashed Toboggan

2. Preparation for Lashing. Explain and demonstrate that the two-man toboggan needs little preparation for lashing since the brass hooks around the nylon cover are used for this purpose. To prepare:
  - a. Obtain a length of cord, preferably plaited spun nylon, approximately 30 feet long.
  - b. Form an overhand loop at the centre of this cord and tie it to the front hook of the cover.
  
3. Attaching Towing Harness. In attaching the towing harness with two men in single file, one man secures the cords of his harness to the front tow ring by means of a bowline. The other man attaches the two ends of his towing cords to the two rings on the first man's web waist-band. When attaching the harness with two men abreast, each man secures the ends of his towing cords to the front two rings of the toboggan. The cords should be adjusted to allow for a straight pull.
  
4. Lashing. Before a move, the toboggan must be correctly and securely lashed (see Figure 2-10). The drill is:
  - a. Use two men, if possible, one on each side.
  - b. Starting from the back end or from where the handle hinges on the toboggan, load the toboggan as follows (see Figure 2-10A):
    - (1) On Bottom of Toboggan
      - 2 billy cans
      - 1 lamp lying flat and crosswise
      - 1 can of gas (upright)
      - 3 stoves (upright), 2 M1950, 1 C1B1
      - 1 pressure cooker
      - Board for stove stand 2' by 1' by 1/4"
      - 2 axes arctic (normally on top in forest country)
      - 2 snow kits (normally on top in tundra)

- (2) Spare Parts Box  
2 flashlights (may be carried by personnel)  
Spare batteries for flashlights  
Flare projector 10 gauge (may be carried)  
Flare for projector (5 red 5 green) (may be carried)  
Mantles  
Generators (lamps, C1B1, M1950)  
Wrench 8" adjustable  
Pliers slip joint  
Screwdriver 8" flat tip  
First aid kit  
Protractor (may be carried)  
Pace counter reciprocating hand held (may be carried)  
Compass (may be carried)  
Pump leathers (M 1950 and C1B1)  
Spare burner cap for the lamp  
Spare filler plugs (C1B1 & lamp)  
1 pr snowshoe bindings  
5 candles



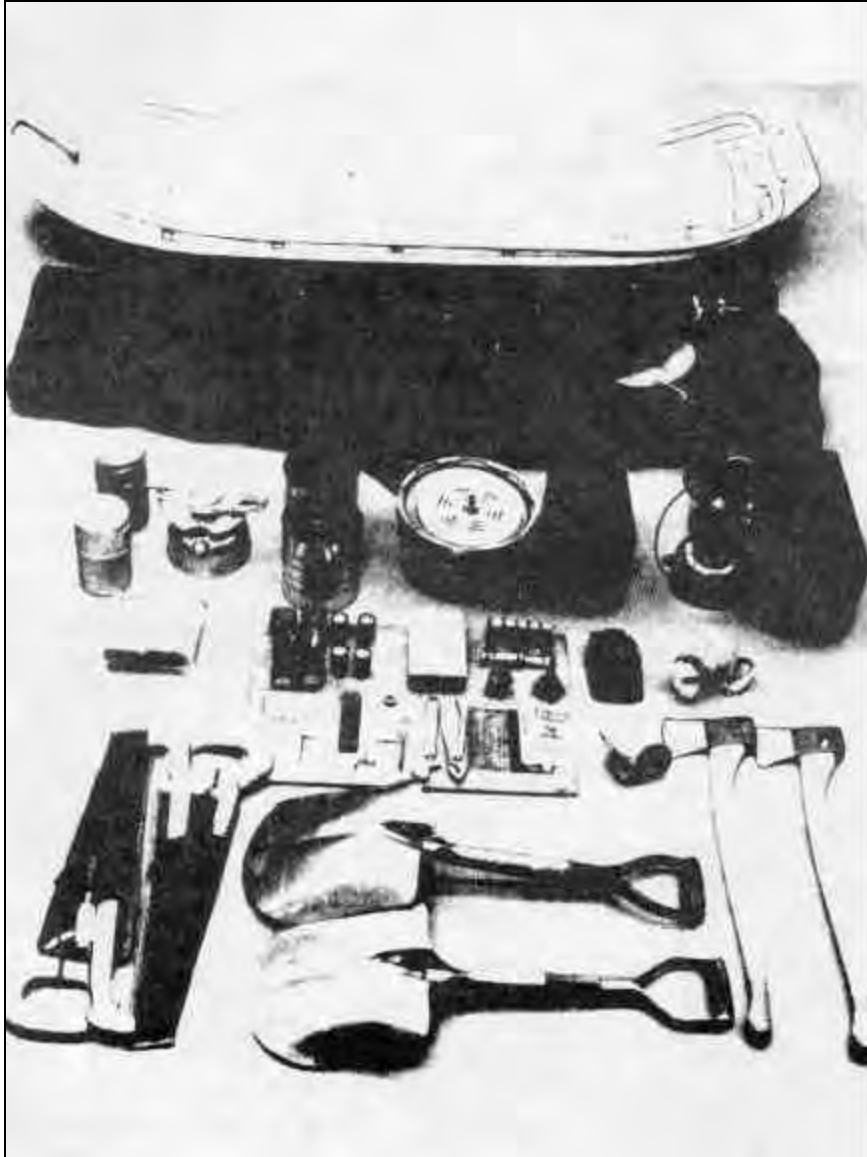

Figure 2-10A A suggested Toboggan Load

Note: Missing is the First Line Ammunition

(3) On Top of Load

Tent folded with 1 crossfold and laid on top of load with base plate  
2 snow shovels on top of tent, spade end of shovel facing down and placed  
at the rear of toboggan.

- c. Tuck in the nylon cover, making sure it covers all the load.
- d. Lash the load in crisscross fashion, passing each end of the cord from side to side. When each side is finished, pass two ends around the rear hook and tie them tightly with a slip knot. If there is enough cord left over, pass the ends back to the front hook and tie again.

Note: The practice of separating fuel containers from rations as taught in previous manuals is unnecessary. If leaks, spillage, or seepage in fuel containers occurs, the continuous movement of the waterproof boat-shaped toboggan will cause the fuel to contaminate the rations regardless of where they are packed. Proper drills and maintenance prevent food contamination by fuel.

5. Hauling

- a. The two-man toboggan can be hauled by two men in single file, approximately seven to eight feet apart (preferable in deep snow and wooded area) or by two men abreast (preferable in open areas). In either system, a third man normally operates at the rear of the toboggan, using the handle-bar. This man assists by:
  - (1) Keeping a cheek on the load and lashing.
  - (2) Preventing the toboggan from overtaking the haulers on a down grade.
  - (3) Pushing in hard going.
  - (4) Preventing the toboggan from tipping when traversing a steep slope.
  - (5) Controlling the toboggan on rough snow or ice.

6. Towing by Vehicle - Whippetree Method (see figure 2-11). To prevent toboggans from upsetting when being towed behind a vehicle the following is a suggested method of lashing the toboggan:

- a. Place 2, 3, or 4 toboggans abreast, with the handle folded and tied down.
- b. Across the hinge portion of the handles, lash a log, using two lashings per handle, one on each edge.

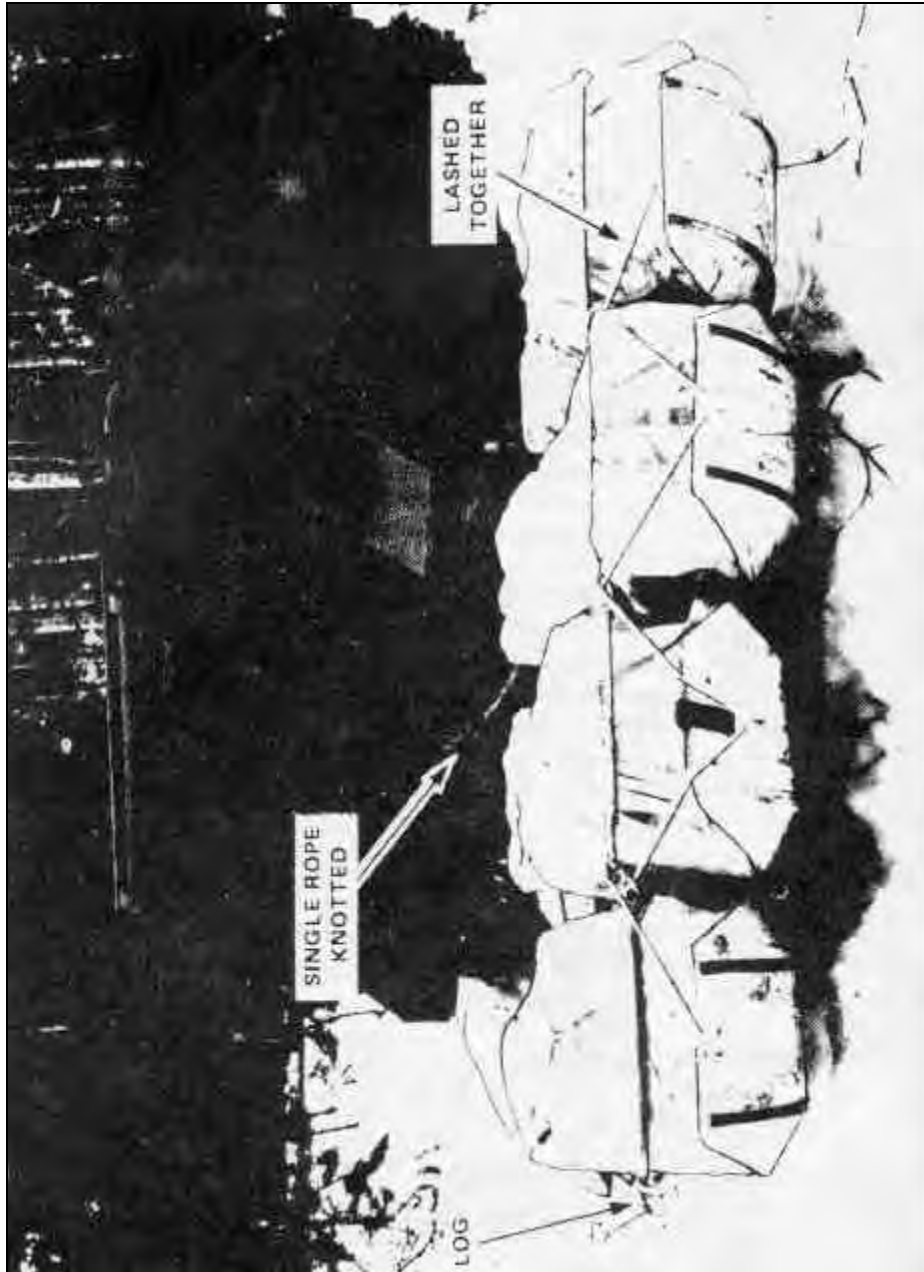

Figure 2-11 The Whippetree Method of Lashing Toboggans Together

Note: This method facilitates movement of toboggans. This number of toboggans could be increased by a factor of 3. (3 rows of four).

- c. Lash the toboggan handles together or if the toboggans are equipped with hooks, fasten them.
- d. Lash each end of a tow rope to a whippetree near the ends of the log. Tie an overhand thumb knot in the centre of the tow rope and place the small loop thus formed in the towing hitch of the vehicle.

7. Care and Maintenance. Before a move, the toboggan must be carefully checked. The points to note are the same as for the one-man toboggan. Also check to see that:

- a. Tow rings are intact.
- b. The handle-bar is free to move and is undamaged.
- c. Hauling a toboggan can be tiring work unless you are fit. Men detailed to pull toboggans should be changed as often as circumstances permit. In deep snow, it is less tiring if the haulers follow a packed trail. Men detailed to pull should make sure that the web band of the towing harness is fitted to their waist, riding at hip bone level. If it slips too far down it will be very tiring on their legs.
- d. The brass hooks on the cargo pack become very brittle in very cold weather and will snap easily if pried or forced. Once they have been adjusted, they should be treated with care when the toboggan is unloaded. Emergency replacements can be made from nails or wire (see Figure 2-9A).

## **260. Conclusion**

Summarize, emphasizing that whatever toboggan is used, correct lashing and loading will make travel less tiring and will prevent the loss of essential stores.

**(261 to 299 inclusive: not allocated)**

## CHAPTER 3

### CAMPSITES, SHELTERS, AND TENTAGE

#### SECTION 1 - SELECTING A CAMPSITE AND BIVOUAC ROUTINE

##### 301. General

1. To select a campsite and establish a routine is normal drill for well-trained troops. However, under winter conditions, the setting up of camp and establishing a routine must be given special attention because of the extra duties necessary. The many duties also require extra effort and organization if a routine is to be effective.
2. Setting up a campsite is a routine based on specific drills and procedures which enables the commander to control the campsite, have it always protected, camouflaged, and the personnel ready to fight. For you to be able to fit in and become a member of this team, you must know your drills and procedures of camp routine.
3. The development of a defensive position is the top priority when a bivouac is being set up. The provision of food and shelter comes next.
4. When defences are complete or nearly complete, tents will be erected in places selected by commanders. The concealment, camouflage, and security of the bivouac are most important and the sitting of the tents will conform to the tactical layout.
5. The possibility of using improvised shelters, built close to or as a part of the field defences should not be overlooked. This can only be done when local materials such as snow and timber are readily available. If improvised shelters are used, tents will probably not be unpacked at all. Apart from the tactical advantage gained by men occupying their actual defences, this system also increases their mobility since a move can be made without having to strike tents.
6. The selection of a campsite and a defensive position are normally considered at the same time. To clearly define the factors to be considered in each case, they are given in this section under two separate paragraphs.

##### 302. Selection of a Defensive Position

1. General. The defensive role is assumed for the same general reasons as for summer conditions plus some northern phenomena such as break-up or freeze-up seasons when the advantage is favourable to the defender because of the poor movement conditions for the attacker. A defensive role may be assumed during periods of severe snow storms or extremely low temperatures.
2. Conduct. Conduct of the defence under northern conditions is the same as under other conditions. The main difference being that the defences will be drawn closer together. Shelters

should be sited close to the fire positions and time permitting, emergency or improvised shelters should be constructed in or as part of fire positions.

### 3. Siting and Location

- a. A defensive position should be selected so as to force the enemy to attack under unfavourable conditions such as through long narrow passes or through deep snow and obstacles where movement is difficult.
- b. The selection of a defensive position in snow, particularly deep, soft snow will aid in the construction of field defences, have a smothering effect on neutralizing fire, and hamper an attacking force.
- c. All around defence is essential since an attack may be launched from any direction. The strong points of this all around defence must be sited to cover any likely enemy approaches and also sited into the prevailing wind.
- d. Defensive strong points should be located on high commanding ground. The value of high ground is much greater in winter than it is under summer conditions, because an enemy force will have to attack up-hill through snow and if possible be made to cross long fields of direct small-arms fire. If a portion of this high ground is iced, it will give the defenders an additional obstacle which will slow down and help exhaust an attacking force. If icing of a position is planned, the distance from the iced area to the defenders should be carefully considered. For instance, if the iced area is near the defenders and on a fairly smooth or steep slope, an attacking force would be slowed down to almost a complete stop and the fragmentation of hand grenades would be greatly increased. An iced area could also be sited in registered defensive fire tasks. This icing would also increase the lethal effects of ground burst artillery or mortar fire and would greatly increase the number of ricochets from low air bursting artillery.
- e. Obstructions such as dense forests, thickets, fallen timber and other natural obstructions collect snow and create obstacles to the attacker. Cliffs, steep banks, rocks, and tree trunks are potential AFV and APC traps or obstacles. The effectiveness of these natural terrain features can easily be increased by; A/P and A/TK mines, automatic weapons firing on fixed lines, stringing barbed or concertina wire in, around, and through them, the laying of booby traps and icing the obstacles. The use of vehicle ice traps, artificial thaws, and artificial avalanches either of snow or rock must not be overlooked.

### **303. Campsites**

1. General. The factors to be considered in selecting the location of a campsite are discussed in paras 2 to 5.

2. Forested Areas. Forests provide excellent campsite, material for camouflage, building material, firewood, and boughs for insulation. They also provide cover against enemy air and ground observation. The coniferous forests are better than deciduous forests. Pine and spruce grow on well-drained soil and usually these areas offer the best campsites.

3. Marshy Ground. In winter when the ground is frozen, good campsites can often be found in wet or swampy areas. Normally the banks of rivers and the shores of lakes provide the best vegetation and other materials needed for a campsite.

4. Open Terrain. Because of strong winds, drifting snow, and poor concealment, campsites on the barren tundra or prairie must be carefully chosen. Tents should be pitched where they can be sheltered by natural wind-breaks whenever possible. The wind-break may be depressions in the ground or pressure ridges of ice on lakes. A visual inspection will indicate the degree of drifting, direction of the prevailing wind, and the suitable protected areas for locating the shelters. In areas where natural wind breaks do not exist, some type of windbreak can usually be constructed from local material. A wind-break constructed from local materials not only gives the shelters protection from the wind, but to a certain extent conceals the location from enemy ground observation. In open areas with high winds, snow will gather rapidly in the lee side of obstructions making it necessary to clear the snow frequently to prevent the weight of the drifting snow from collapsing the tents or cutting off ventilation. If the snow cover is deep enough and the time is available, shelters should be dug in.

5. Mountain Areas. Mountainous terrain is characterized by strong winds, cold, and lack of concealment above the timberline. In mountainous country the strong overhead winds usually create an area of no wind or very little wind on the lee side of slopes. Cold air is heavier and normally settles in valleys. The point where the temperature starts changing is low or near the floor of the valley in the summer and higher and much more noticeable in winter. In some instances, it is better to establish a campsite up the hillside above the valley floor and below the timberline. Avalanches occur in mountainous areas, therefore, these areas must be avoided if possible. They occur when a mass of snow slides down the mountain. Thaws, gunfire, or vibrations from gun fire, or movement across the face of a loose mass of snow may set an avalanche in motion. High temperatures, steep slopes, and newly fallen snow are caution signs. Generally, avalanches are like the cracks in the ice of a large frozen body of water. That is, they occur or appear at the same place year in and year out. Their paths are easily seen as the signs of them remain winter and summer. Avalanche paths are generally always in the low ground on the sides of mountains. The signs to look for are:

- a. swaths cut through a bush;
- b. bent trees stripped of their branches;
- c. tree stumps of different heights;
- d. a fairly smooth clear strip of ground running down the mountain;
- e. a mass of boulders in the area where the avalanche stopped; and

- f. loose melting snow rolling down the mountain side leaving what looks like a stream of snowballs.

### 304. Entering a Campsite

1. The camouflaging of a position begins before the position is occupied. Where possible approaches should be made under cover of trees or bushes, behind snowdrifts or slopes, and in shaded areas. Poor track concealment at this point may make the camouflaging of the campsite ineffective. If tracks cannot be concealed, then they should lead through or by the campsite to one or more dummy positions.
2. On entering a campsite the unit or sub-unit commander, in addition to his normal temperate climate responsibilities, will be responsible for:
  - a. temporary placement of weapons and equipment to prevent loss in the snow;
  - b. siting and designating the types of field defences to be constructed;
  - c. determining the exact tent locations providing the best natural shelter and camouflage. This must be coupled with the siting of defences;

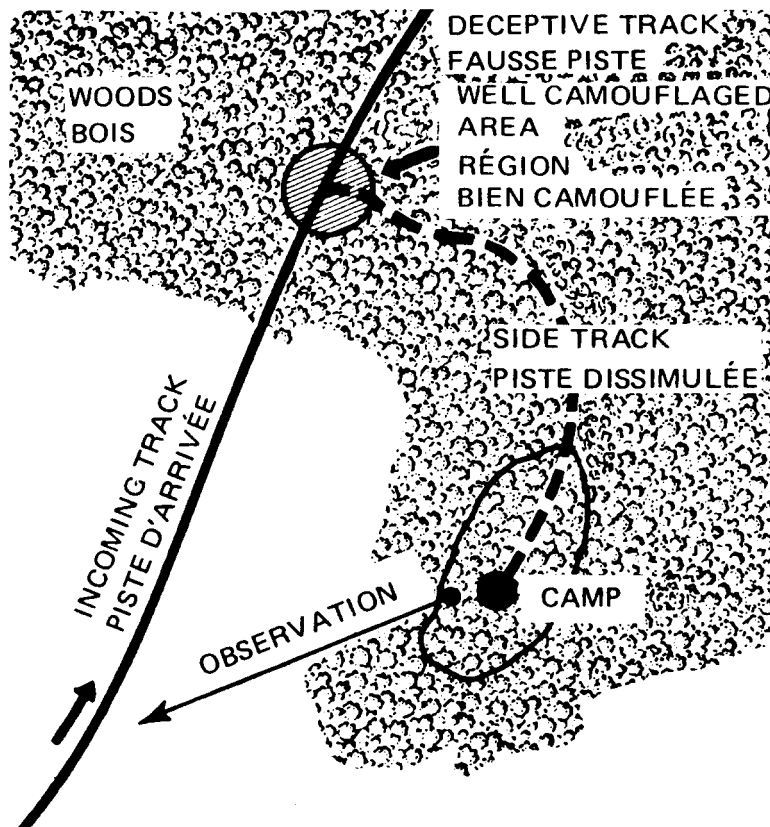

Figure 3-1 Use of Camouflage and Deception in a Campsite Area



- d. breaking or marking the trails to be used in the campsite areas;
- e. designating areas from which construction material, and snow or ice used for cooking will be obtained, and where latrine and garbage disposal sites will be located; and
- f. if no tents are issued, the construction of improvised shelters best suited to the area concerned.

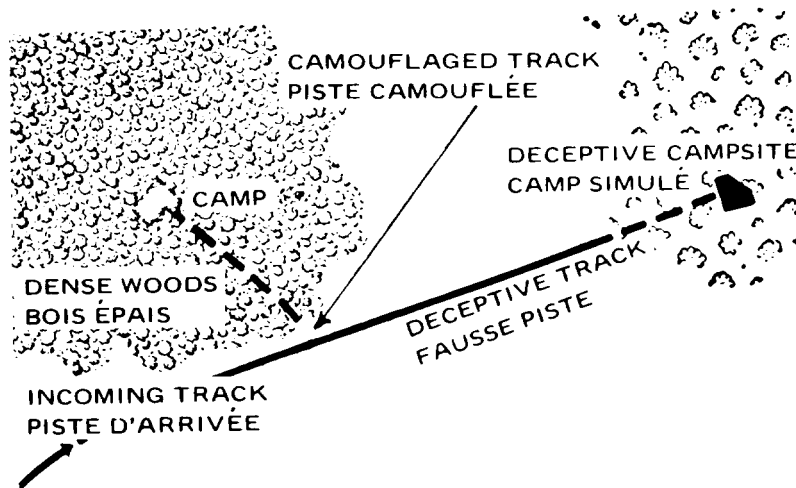

Figure 3-2 Selection of Route when Entering a Bivouac in a Forest

### 305. Establishing a Campsite

1. Under no circumstances should the erection of shelters or the preparation of food take priority over the security of the campsite or the construction of field defences. The commander will issue orders for the erection of tents or shelters when work on the defence is well under way and he feels that some of the men can be spared from their tactical duties. An exception of this will be in the first few days of training, all men must stop work on the field defences and proceed with the duties involved in the pitching of tents. This is done to maintain camp drill and allow all the tent group members to learn and practice the drills and procedures.
2. Once the tent has been pitched, there are a number of tasks which must be done. Generally, those few men who have been relieved of building the defences would, after the tent is pitched, carry out other camp tasks.
3. After a long march, followed by work on the field defences, a hot drink is a good morale booster. However, this must not be allowed to interfere with the progress of the work.
4. A snow-wall around each tent is one of the better wind-breaks. In a tactical position it should not exceed three feet in height. The shadow from a snow-wall is easily spotted on air

photographs or by visual reconnaissance. To overcome this, the sides must be banked to conform to the natural snow contours.

### **306. Collecting Ice or Snow for Cooking**

1. Areas designated for ice or snow that are to be utilized for water must be sited well away from and up-wind of the latrine and garbage disposal sites.
2. To save time and fuel and to obtain a good supply of fresh water, chop or cut a hole in the ice of a nearby lake or stream. Normally, the thickness of the ice south of the tree line will not exceed four feet, however, in extremely cold areas five feet is not uncommon. By using an ice auger of the thread or spoon design, one man can drill a five inch hole through three feet of ice in one and a half minutes. If a water hole is used, place snow blocks or loose snow over the hole to retard freezing and mark it so it can be relocated easily should it become covered with drifting snow.
3. When it is not possible to get fresh water, snow or will be melted. Ice is a better source because it produces more water in less time, thereby saving fuel. When melting snow, place a small amount in the container to begin with; when this has melted, add more snow until you have enough water to absorb any additional snow required. This water will prevent the bottom of the container from burning.
4. Whatever the source of water, it should be purified if it is to be consumed. Either boil it rapidly for three minutes or treat it with water purification tablets. Chemical sterilization of water under freezing conditions requires a longer period because the disinfecting compounds act with retarded efficiency under such conditions. The time allotted should be two to four times longer than the normal directions on the sterilizing containers. Eating snow or ice is unsatisfactory and may result in painful cracking of lips, as well as the danger of infection.

### **307. Constructing a Latrine**

Tent groups will normally build a central latrine if dispersion within the camp is not too great. One latrine will usually serve the needs of three or four shelters or a unit of platoon size. It must be placed down-wind of the campsite, but not so far from the shelters as to encourage individuals to break sanitary discipline. A pit or crosstree type of latrine is usually the type built and is windproofed by branches, snow-blocks, ponchos, or any other available material and properly camouflaged. Individual tent group urinals may be sited ten to fifteen yards from each tent or shelter.

### **308. Digging a Garbage Pit**

Whenever possible all garbage should be disposed in garbage pits and either burnt or buried prior to departure. All empty tins should be flattened thus saving on the size of the pit required.

### **309. Camp Routine**

1. After the camp has been established, there are a number of responsibilities for all tent group members. These must be attended to at all times.
2. In below freezing temperatures, individual weapons should be left outside to avoid condensation, however, for security reasons it is advisable to keep at least one weapon in the shelter. One or two weapons can be rotated to allow individuals concerned to give their weapons a thorough cleaning. For details see Chap 4, Sect 1.
3. Before entering the shelter, frost and snow must be brushed off clothing and equipment. This keeps the clothing dry and the shelter clean.
4. Living comfortably in a shelter is not an easy art. You are usually crowded and you must keep your equipment orderly and out of the way of others. Unnecessary running in and out of the shelter must be avoided whenever possible.

### **310. Duties of Tent Group Commander**

1. The tent group commander is responsible for the control of the shelter and will ensure that:
  - a. housekeeping duties are performed on a roster basis;
  - b. the tent is correctly pitched so that the maximum space is obtained;
  - c. equipment, arms, and stores are conveniently placed outside the tent with weapons, stores, and equipment on one side of the entrance and POL on the other;
  - d. sleeping space is fairly allotted;
  - e. guards and sentries know where their reliefs are sleeping so that reliefs may be made without confusion;
  - f. blackout is maintained;
  - g. track and camouflage discipline is maintained;
  - h. fire precautions are observed;
  - j. stoves and lamps are filled outside;
  - k. soldiers dry their clothes at every opportunity.
  - m. sleeping bag discipline is observed;

- n. the tent is de-iced;
- p. stoves, lamps, and stores are regularly maintained;
- q. all the ration is consumed or that any remaining portions are saved for in-between snacks and that each man receives the proper portion;
- r. constant checks are made to ensure that cooking utensils are clean; and
- s. all members carry out their own personal hygiene and sanitation.

### **311. Duties of the Cook**

1. The drill outlined below is a good method of easing congestion in the tent when it is first pitched.

- a. The cook is the first man to enter the tent and:
  - (1) arranges the rucksacks and air mattresses around the wall of the tent, as they are handed to him; and
  - (2) places the cook stores in the tent, unpacks them, and places them under the stove-pipe hole.
- b. He will begin to prepare the meal, assisted by any members of the tent group not employed on other work. They can help by:
  - (1) filling stoves and lamps;
  - (2) gathering ice and snow;
  - (3) opening cans.
- c. Air mattresses should be blown up and arranged as chairs or couches before the remainder of the men enter the tent.
- d. When members of the tent group enter the tent, they should sit in their allotted places and should not be allowed to move about except to perform some duty.

### **312. Preparation of Rations**

1. When the situation permits, meals should be hot and eaten inside a shelter. Men should have time to eat their meals in a leisurely manner and, if possible, a short period of relaxation should be permitted before continuing with normal duties. To assist the tent group commander in his planning, the approximate food preparation timings based on past experience are:

- a. breakfast, including preparation of beverage for the noon halt - 1 1/2 hours to prepare and consume;
- b. lunch - 1/2 hour (normally eaten during the noon halt);
- c. dinner - 1 1/2 to 2 hours to prepare and consume;
- d. melting and boiling sufficient snow for beverage - 30 to 40 minutes;
- e. melting and boiling sufficient ice for beverage - 25 to 30 minutes;
- f. thawing and heating tinned meats - 15 to 20 minutes; and
- g. thawing and heating tinned desserts - 5 to 10 minutes.

2. Snow and ice are the most common sources for water in the winter. To save time and fuel, try to get running water from a nearby lake or stream. The soldier detailed as cook must plan his meals carefully, bearing in mind the time factor and the fuel supply. The following suggestions will be of assistance:

- a. When beginning a meal, use as many stoves as possible to heat water, as this is what takes the most time in meal preparation. Start the meal with a hot drink or soup.
- b. As soon as one course, such as the hot drink, has been served place the next course on the stove.
- c. Know how to use the pressure cooker. Approximately one-half inch of water is all you require to produce enough steam to thaw out and heat tinned foodstuffs.
- d. Use gloves anti-contact when handling frozen tins, hot stoves, or hot utensils.
- e. When opening tins to be placed in the pressure cooker, leave enough of the lid attached to the tin to act as a handle.
- f. Keep the lids on containers that hold fluids to prevent your shelter from steaming up.
- g. Release the steam from the pressure cooker outside the shelter or wait until the pressure diminishes, (test, using the safety valve).
- h. Take every opportunity to prepare a hot drink for the group by having hot water on hand. Hot water not immediately required should not be wasted but stored temporarily in thermos bottles.

- j. If a move is planned after breakfast, heat the tinned portions of the group's noon meal. These can be carried in shirt pockets where tins will be kept thawed out by body heat.
- k. A little imagination on the part of the cook will go a long way towards making meals more palatable. For example, potatoes, onions, or bacon, when available, will provide extra flavour and can satisfactorily be added to many foods.
- m. Before retiring for the night, make sure that all stoves are filled, and that water is melted for the next morning's breakfast, part of which may be in thermos bottles. The habit of having the next morning's breakfast all prepared except for actual heating will save time and simplify the preparation of the morning meal.

### **313. Bedding Down**

1. When arranging the sleeping spaces in a tent or improvised shelter, the position of every man, especially the position of reliefs for sentries should be carefully planned. Each man must know where his relief is sleeping. The floor space is occupied in accordance with the duty roster. In this manner starting from the door, the relief is easily located without waking up the remaining occupants. A systematic sleeping arrangement will also permit exit from the tent in an organized manner in the event of an alert.
2. Ground insulation is most important and often occupants will have to improve insulation using any available material. A six to twelve inch thick shingle bed of spruce, fir, or balsam boughs gives excellent insulation and provides a soft mattress. If boughs are not available, cardboard from ration cartons can be used.
3. The tactical situation dictates whether or not sleeping bags are used. The amount of clothing to be worn when sleeping on a bough bed or in a sleeping bag can be best judged by experience. As a rule of thumb when sleeping in the bag, wear as little clothing as possible. When sleeping in a heated shelter, mukluks are usually removed, situation permitting, and personnel sleep on top of the sleeping bag, fully clothed and covered with their parkas. When sleeping in a shelter with a fire burning, it is essential to have an alert, wide awake fire guard on duty.

### 314. Position of Air Mattress

The following Figures 3-3 and 3-4 show tested methods of positioning air mattresses.

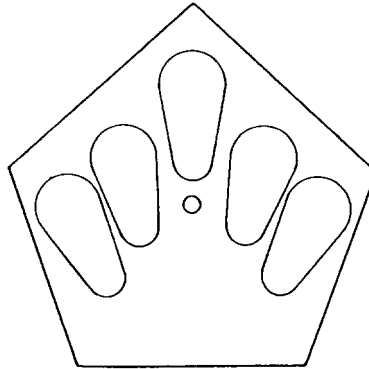

Figure 3-3 Layout of Five-man Tent

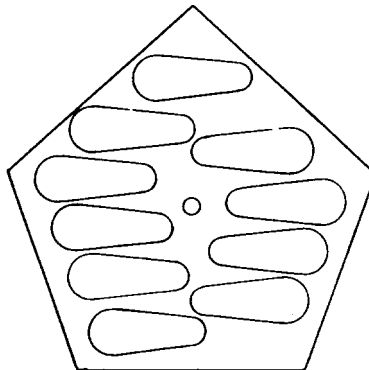

Figure 3-4 Layout of Ten-Man Tent

### 315. Responsibilities

1. After the camp is settled into routine, the unit or sub-unit commander along with the tent group commander is responsible for:
  - a. maintaining and emphasizing cleanliness, tidiness, and teamwork;
  - b. maintaining a duty roster for exterior guards, fire guards, or similar assignments;
  - c. rotating individuals on all jobs on a daily basis;
  - d. inspecting the area, examining the security, camouflage, cover, weapons, skis, snowshoes, vehicles (if applicable), and the condition of the men and their equipment; and
  - e. outlining and rehearsing the action to be taken in the event of an attack.

### 316. Security

1. The problem of maintaining guards and sentries under winter conditions is more difficult than would first appear. The climatic conditions are often so severe that soldiers cannot remain alert except for very short periods of time. Sentries cannot look into the wind for very long and in spite of frequent reliefs can hear and see very little. Therefore, commanders must use a sliding scale of how long an individual will be on sentry duty for any given time. This scale of time will vary with the temperature, wind-chill, and visibility. The following are some of several solutions that have been tried and have been successful to varying degrees.

- a. Perimeter defences surrounded by a perimeter track may be used. This track is patrolled at irregular times to check for enemy activity or patrolled frequently if the threat is imminent.
- b. The location of a living-fighting position for a security force on an outer perimeter. A warning system is then established from the security force position to the forward defence force position. All movement on the outer edge of the perimeter and in the vicinity of the living-fighting force position is kept to a minimum to preclude observation or attack by hostile air or ground forces.
- c. A duty sub-unit may be used for sentries thereby allowing remaining sub-units an extended period of time out of the cold for rest and warmth.
- d. The detailing of two guards for one post for two hours. This is done by having one man on guard and one man acting as a fire guard in the shelter. These positions are rotated every 15 minutes with the fire guard going out to relieve the sentry on the post. By doing this each man will be outside on sentry duty for one hour at 15 minute shifts. This allows the remainder of the tent group to get a longer unbroken sleep. Also with a fire guard on duty in the shelter tending the stoves and lamp, the troops would be more ready to meet an enemy threat because there would be no need for them to be in their sleeping bags, but sleeping fully clothed on top of them and covered with their parkas.

2. Regardless of what system is used the following points must be observed:

- a. In the defence, particular precautions against surprise must be taken during blizzard conditions. The number of listening patrols and sentries must be increased and continual checking will be necessary to ensure that sentries maintain a vigilant watch particularly to the windward and most dangerous flank.
- b. Any type of surveillance and mechanical devices such as PPS 4, trip flares, mines, etc, should be employed to thicken the security measures.
- c. If a defensive position is to be ready to meet an enemy threat at all times, troops must sleep fully clothed and in shelters which have been built in as part of the



field defences. The point to bear in mind is that when an enemy threat is imminent, living and sleeping in tents is extremely dangerous.

### **317. Breaking Camp**

When the commander issues his orders for pull pole time, tent groups commanders must ensure that their tents will be ready to strike at this time. Prior to pull pole time all garbage and latrine sites must be filled in and covered with at least two feet of compacted earth or snow. The security of the campsite at this time must not be relaxed nor should the track, camouflage, light, or noise discipline be forgotten.

### **318. Conclusion**

The procedures in this section have been thoroughly tested and should be incorporated in Unit Standing Operating Procedures. When teaching this subject, unit instructors must use practical methods and sufficient time must be allowed for practice.

## SECTION 2 - INSPECTION, PREPARATION, AND STOWAGE OF TENTS

### 319. General

1. To maintain a high level of efficiency in cold weather, heated shelters must be provided. Permanent shelters will usually be scarce in areas of operations and tents will normally be issued. Living in tents limits freedom, therefore, control and team work are essential. Because the tent is a vital part of your equipment, keep it as close as possible to the scene of activity. It should never be abandoned except in case of extreme emergency and then you must be prepared to live in whatever shelters you can find or build.
2. Tents when first issued come as separate components. They, therefore, must be inspected for any defects and assembled correctly before use.



Figure 3-4A Ten Man Tent

### 320. Description

1. The tent is really two separate tents - an outer made of a light weight fabric which is resistant to moisture and an inner made of rubberized nylon which is inflammable. Both tents are tied together by a system of loops and toggles, allowing an air space between tents.
2. The tent is generally bell-shaped, with a five-sided wall. Each section of the wall has a snow flap attached to the bottom portion of its panel.
3. The inner tent has the following, which corresponds to similar features on the outer tent: zipper door, base tie down points, air vents, stove pipe openings, and reinforced apex for pole insertion.
4. The tent is supported by a single telescopic centre pole and 16 guy lines. The guy lines are pegged down with light-weight alloy pegs, which can be driven into frozen muskeg but not frozen ground.

### **321. Inspection of Outer Tent**

1. The outer tent must be inspected to ensure the following faults are not present:
  - a. reinforced ring on apex damaged or torn;
  - b. air vents can be opened and are not damaged;
  - c. tears or holes in panels;
  - d. broken threads or torn seams.
  - e. tie ropes and guy rope loops are not broken or frayed;
  - f. zipper on stove pipe opening in good working order with cover and ties present;
  - g. the zipper on the outer door runs freely;
  - h. snow flaps with eyelets are intact and not torn away from the walls;
  - j. drying line keepers are all present and not torn away from the seams; and
  - k. toggles are all present for attaching the liner.
  
2. The inner tent will be inspected for the following:
  - a. reinforced ring on apex not torn away;
  - b. air vents must be open clear and undamaged;
  - c. tears or holes in panels;
  - d. broken threads or torn seams;
  - e. the zipper on the cover of the stove pipe opening and the ties present;
  - f. the zipper on the door runs freely;
  - g. snow flaps with the eyelets are intact and not torn away from the walls;
  - h. drying lines are not frozen or broken and of sufficient length (5-man tent - 20 ft; 10-man tent - 40 ft); and
  - j. the seam and drying line splits are serviceable.
  
3. Accessories
  - a. Telescopic pole (10-man tent); all sections run freely with no bends or splits and the pole keeper pin is attached.
  - b. Tent pole (5-man tent); sections have no bends or splits and fit together properly.
  - c. Base plate has no cracks and, in the case of a 5-man tent, the base plate keeper pin is attached.
  - d. Pegs have no broken points or bends.

### **322. Assembling the Tent**

1. To assemble the tent the following drill should be followed:
  - a. Lay out the outer tent, flat, apex in the centre and panels outwards with the inside facing upwards, and the door zipper fastened.
  - b. Lay out the inner tent liner on top of the outer tent, with the inside facing upwards.

- c. Attach the top and bottom stove pipe toggles. By lining up the stove pipe openings of the outer and inner liner and attaching the top and bottom toggles, then the inner and outer portions are positioned properly.
- d. Working either way, attach the remaining toggles. Use the corners of the tents as check points to make sure you did not miss a toggle. Continue until all toggles are through the seam grommets of the inner liner.
- e. Thread the long or the lower drying line through the drying line keepers. To get the drying line keepers through the inner seam splits, feel through the liner at the peak or centre of the doorway, follow up the seam on the panel of the outer tent, when you reach the drying line keeper, insert it through the split seam of the liner and thread the drying line on. There is a keeper on every seam. This means there are 10 keepers for the lower drying lines.
- f. Thread on the short or upper drying line. Start at the door seam again and carry out the same drill as for the lower drying line. There will be a keeper on each side of this one and then one on every second seam. This means that there will be six drying line keepers on the top.
- g. Insert the spike of the tent pole through the apex of the inner and outer tents and lash these three securely.
- h. Attach the five bottom tie-down pegs. To do this, run a rope (15 inches) through the bottom wall eyelets of the outer and inner tents, tying the pegs to the outside.
- j. Attach the wall guy lines (11) to the guy line loops on the outer tent. To do this, thread the guy lines through one hole of the runner then through the guy line loop of the tent and back through the outer hole of the runner. Tie a figure 8 knot on this end of the guy line to prevent it from slipping out of the runner hole. The other end of the guy line is threaded through the eye of the peg of the guy line and is prevented from being pulled out of the peg by a slip knot. This method of attaching guy lines must be used as the rope will invariably freeze in the peg hole and the reverse of the above procedure will prevent tightening of guy lines. In addition, when the ground is too hard, or snow too soft and deep, the pegs can be secured by wrapping several turns of the guy line to the centre of the peg and either freeze the peg in the snow or place a large stone or log on top of the peg.
- k. Attach the five top guy lines (10-man tent) in the same manner.
- m. The tent is now assembled and ready for use, however, when the tent is pitched and the doors are opened, quite often the zippers become disengaged. To prevent this, close the zipper and near the top of the door, sew the track of the zipper together. This will act as a stopper, preventing the zipper from becoming disengaged. Do this to the outer and the inner tent zippers.
- n. The fly screen is of no use in cold weather and should be rolled up and secured by the ties running each way from the door to the outside corners. Roll and secure this screen, only after the tent has been pitched. If done when the tent is struck, the tent will be misshapen when pitched.
- p. To prevent the guy lines from being left hanging loose and becoming tangled, roll the guy rope around the tent peg and in the guy rope loop. In most cases the guy rope loops are sewn too far down and the loop is not large enough for the peg to fit in. To overcome this, thread short pieces of the rope through the guy line loops and tie with a square knot. Adjust the knot so the peg will fit securely in it.

### **323. Stowage of Tents**

1. To stow the tent, four men are required and positioned as follows:
  - a. one at the appex;
  - b. one on either wing; and
  - c. one at the door.
  
2. To fold the tent:
  - a. Lay out the tent with the tent door up and in the centre and with zippers closed.
  - b. Make sure there are no double folds on the underside.
  - c. Hold the apex securely. The first long fold is made by the wing men folding the wings to the centre, with the pegs straight up and down.
  - d. Straighten and flatten out.
  - e. Fold in snow flaps across the base.
  - f. Make the second long fold, repeating the action as for the first long fold.
  - g. Straighten and flatten out.
  - h. Make the third long fold.
  - j. Straighten and flatten out.
  - k. Fourth long fold - flip folds one on top of the other.
  - m. Make the first cross fold; fold in base at top of wall.
  - n. Make the second cross fold by folding the apex into the base of the inserted pole section, allowing approximately four inches of loose fold at the base of the pole section to avoid wear and tear. Top of pole should be offset.
  - p. Third cross fold - place the folds one on top of the other.
  - q. Insert in the bag, (baseplate and spare pegs have already been placed in bag).
  - r. Place the remaining two pole sections in the bag alongside the tent.
  - s. Tie up the top of the tent bag.

### **324. Folding for Toboggan**

1. When folding the tent for the toboggan the following action is taken:
  - a. Carry out thee folding instructions as detailed in art 323 as far as and including subpara k of para 2.
  - b. Fold tent in half by taking the apex down to the base of the tent.
  - c. Place tent on toboggan.

### **325. Conclusion**

The above detail is based on the 10-man tent. The principles also apply to the 5-man tent with slight difference in assembly procedures. Unit instructors must point this out when teaching this subject.

## SECTION 3 - PITCHING AND STRIKING TENTAGE

### 326. General

1. Heat, shelter, clothing, and rations in general are your living necessities. The combination of heat and shelter form a major factor contributing to your efficiency and comfort in cold weather. Your main type of shelter will be the arctic tent. Once a campsite has been selected it is important to pitch your tent quickly, efficiently, and quietly. You must be capable of doing this day or night under all weather conditions. In addition, when a commander orders a move, all tent groups may be ready to move at the same time. This means that all tentage will be struck at the same time and loaded and lashed on the toboggans.

2. It is very seldom that the same crew will pitch and strike the tent. There will always be men on sentry duty, building field defences, on patrols, or other duties. In order that all members of the tent group function as a well-drilled team operating on a standard routine, all must know the pitching and striking drills.

### 327. Tent Pitching and Striking Squad

1. The drills for pitching and striking a tent have been devised for a 5-man team, but, if necessary, fewer men may be used. As a result of these drills, the tent group as a whole, functions more efficiently because:

- a. men are not needlessly standing around in the cold;
- b. they prevent confusion, especially during the hours of darkness;
- c. they allow the commander to maintain control at all times; and
- d. each member of the tent group knows the location of his weapon, rucksack, snowshoes, or skis at all times.

2. The squad used in the pitching and striking drill is made up of the following:

- a. Tent group commander;
- b. No. 1;
- c. No. 2;
- d. No. 3; and
- e. Cook.

### 328. Duties of Tent Pitching Squad

1. The Commander:

- a. sites the tent;
- b. supervises the layout and erection;
- c. raises the pole and secures the door guy; and
- d. reinforces the tent pole by lashing a wooden stave to it.

2. The No 1 works on the left side of the tent and is responsible for (see Figure 3-5):
  - a. the left front and left side tie-down points;
  - b. the three guys on the left side.
  - c. the snow flaps on the left side; and
  - d. the two high guys on the left side (10-man tent only).
  
3. The No 2's duties are the same as the No 1's, but on the right side of the tent (see Figure 3-5).

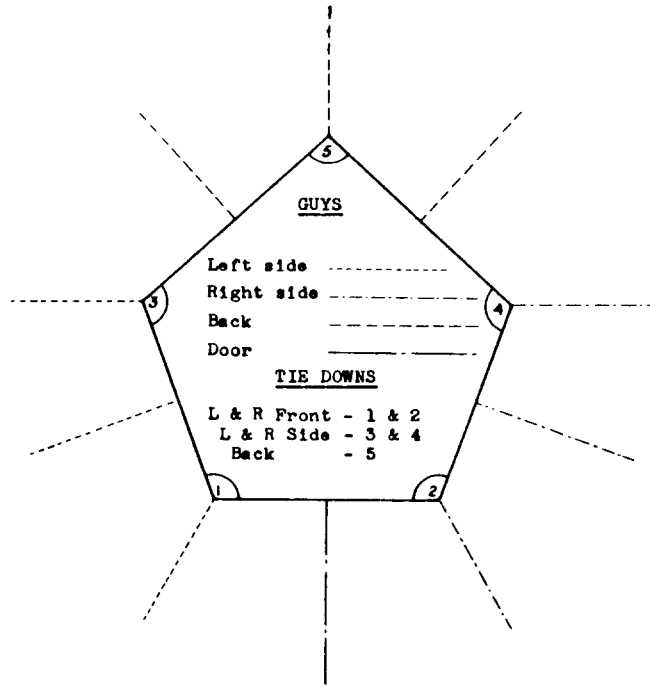

Figure 3-5 Guys and Tie-Downs

4. The No 3 is responsible for (see Figure 3-5):
  - a. the back tie-down point;
  - b. the three back guys; and
  - c. the two back snow flaps.
  
5. The Cook:
  - a. assists No 3 if there is a strong wind; and
  - b. assembles the pole sections and base-plate for the commander.

Note: Assembling the pole section is required only with the magnesium tent pole. The new Canadian telescopic pole may be lashed complete to the apex ring of the tent and left in this position.

### **329. Tent Pitching Drill**

1. The drills for pitching a tent are divided into three steps. They are:
  - a. siting and preparation.
  - b. layout of the floor plan and erection; and
  - c. weatherproofing the tent.

Note: Instructor will demonstrate and each tent group will follow his actions, using the group tent.

### **330. Method**

1. The steps in siting and preparation are:
  - a. The tent area is allotted to the tent group commander.
  - b. The tent group commander selects the best spot to pitch the tent.
  - c. The squad members place their rucksacks, arms, and equipment in a row to the left of where the door will be.
  - d. The tent site is levelled, and if time permits dug down to a minimum of six inches for insulation.
  - e. Nos 1 and 2 unlash the tent.
  - f. No 3 and the cook unlash the cooking equipment. (This applies only in the case of the 5-man tent as all stores are together for the 10-man tent.)
  - g. The tent is removed from the sled and laid out on the spot indicated by the commander, with the door quartering downwind so that snow will not bank around the door.
  
2. Layout of the Floor Plan and Erection
  - a. The drill continues without pause with all squad members working together. The men position themselves as follows:
    - (1) Commander - at the door;
    - (2) No 1 - at the left front tie-down point;
    - (3) No 2 - at the back tie-down point;
    - (4) No 3 - at the back tie-down point; and
    - (5) Cook - may assist No 3, if there is a strong wind, or he may assemble the pole for the commander.
  - b. The commander takes a handful of slack at the door to make sure that the zippers will operate easily, and then directs the positioning of the tie-down points.
  - c. Nos 1 and 2 peg down the front tie-downs.
  - d. Nos 1 and 2 move to the side tie-down points and peg them down under the commander's guidance.
  - e. No 3 pegs down the back tie-down when Nos 1 and 2 peg down the side tie-downs.



- f. Nos 1, 2, and 3 take hold of the guys directly above the side tie-downs and the back tie-down, and reel out the guys to the fullest extent.
- g. The commander unzippers the door and moves inside. He adjusts the pole by inserting the pole sections into the section lashed to the top of the tent or by extending the telescopic pole, depending on which is being used. No 3 orders "Up Pole", on receiving the order from the commander.
- h. Nos 1, 2, and 3 peg in the guys they are holding.
- j. The commander holds the pole until the guys are secure.
- k. Nos 1 and 2 peg in the remaining side guys, working towards the front of the tent.
- m. No 3 pegs down the remaining back guys.
- n. The cook takes the cooking equipment into the tent and carries on with his duties.
- p. The commander adjusts the door guy. He may use a sled, snow blocks, or a pole, to raise the guy higher.
- q. With a 10-man tent the upper five guy ropes are secured last.

### 3. Weatherproofing the Tent

- a. After the tent has been pitched, the squad makes it weatherproof and secure as follows:
  - (1) No 1 shovels snow or places snow blocks on the snow-flaps on the left side of the tent;
  - (2) No 2 completes the same task on the right side of the tent;
  - (3) No 3 places snow on the flaps at the rear;
  - (4) Nos 1, 2, and 3 erect a three-foot snow wall around the tent; and
  - (5) the commander cuts a pole and lashes it to the tent pole as a reinforcement against high winds.

### **331. Striking Drill**

1. There are two phases in striking tentage:

- a. the preparatory phase; and
- b. the striking phase;

Note: As the instructor details the drill, a tent group will carry out the actions described.

2. Preparatory Phase. In order to be ready to strike the tent at pull pole time, the following procedure is initiated:

- a. Fifteen minutes before pull pole time, the tent is cleared of everyone except the cook.
- b. The cook begins packing all the cooking equipment.
- c. Nos 1, 2, and 3 loosen all the tent pegs and remove the snow from the snowflaps.
- d. Nos 1, 2, and 3 roll up all the guy ropes (except those at the left, right, and back tie-down points) and secure them to the tent.

- e. The commander goes into the tent and unlashes the pole that has been used to reinforce the tent pole.

### 3. Striking Phase

- a. The tent is now ready to strike and the squad members take up the following positions:
  - (1) the tent commander - inside at the tent pole;
  - (2) No 1 - at the guy rope above the left side tie-down point;
  - (3) No 2 - at the guy rope above the right side tie-down point;
  - (4) No 3 - at the guy rope above the back tie-down point; and
  - (5) Cook - continues packing his equipment.
- b. When all are in position and pull pole time arrives the tent is struck:
  - (1) No 3 makes sure that everyone is in position and orders "Pull Pole".
  - (2) The commander pulls the bottom of the pole towards the door and lowers the tip to the rear of the tent. He disconnects the lower section or telescopes the pole, depending on which pole is being used.
  - (3) No 3 grasps the apex of the tent.
  - (4) The commander backs out of the door, carrying the pole sections and base-plate, and zippers the door closed.
  - (5) Nos 1 and 2 pull out the remaining pegs, roll up the guy and secure them to the tent.
  - (6) Nos 1, 2, and 3 pull the tent to the rear and spreads it out on the ground.
  - (7) The commander orders "Shake Out". All Nos spread around the tent, shake the snow and ice out of it and fold it up for stowing.
  - (8) Nos 1 and 2 load and lash the tent toboggan.

### **332. Conclusion**

The above drills provide an efficient method of pitching and striking tents even under the most adverse weather conditions. Unit instructors should ensure that all personnel under instruction are rotated to ensure that they are familiar with all duties.

## SECTION 4 - IMPROVISED SHELTERS

### 333. General

1. The arctic tent is the type of shelter normally used in cold weather operations. It is easily and quickly erected and will give you good protection from the weather. However, there are times when you will not have tents and if no other shelter is readily available you will have to build an improvised shelter.
2. To conduct successful military operations in cold weather and maintain a high level of combat efficiency and morale, you must have some type of heated shelter. If your normal shelter, the arctic tent, is not available, you must be able to build an improvised shelter so you may be able to work, live, move, and fight under extreme climatic conditions.
3. Improvised shelters are normally built for the following reasons:
  - a. Normally small reconnaissance patrols are not equipped with tents because they must be hauled on a toboggan or man-packed. This will hamper a patrol's mobility and speed.
  - b. In a theatre of operations your tent is generally pitched as near as possible to the scene of activity. This increases the chances of your tent being destroyed by being shredded by artillery or mortar fire, burned by hot shell splinters or exploding phosphorous, or by small arms tracer fire.
  - c. In certain areas or types of terrain concealment may be of vital importance to the operation and tents cannot be effectively camouflaged.
  - d. In a vital defensive position where a large percentage of the troops are on a 24-hour guard, then shelters may be built in as part of the field defences.

### 334. Siting of Shelters

1. Shelters must not be sited on likely enemy approaches. The siting of shelters applies in winter as in summer, however, the main difference to bear in mind is that rivers, lakes, or streams which are natural obstacles in summer, become a level and at times a concealed avenue of approach for an enemy force in winter.
2. The direction of the prevailing wind must also be considered because blowing snow always drifts in the lee of obstacles.
3. Shelters should be sited in a location which provides the best natural camouflage from enemy air and ground observation or in a location which requires the least amount of modification as there is less requirement for disturbing its natural appearance.

### 335. Areas for Shelters

Shelters can be built in wooded areas, open country, and barren areas. Wooded areas provide the best location whereas the barrens have only snow to build with. The wooded areas

provide timber for building, wood for fires and heat, cover from air and ground observation, and a good windbreak.

### **336. Building**

The shelters described in this section are not laid down as hard and fast rules that you must follow. As these are improvised shelters using only the tools and equipment that a tent group is normally issued, the described way of building and the measurements are only a guide for you to follow. The type and shape of the shelter you build will depend on the natural material that is available, the type and condition of the terrain, and the individuals own imagination and initiative.

### **337. Types of Shelters**

#### **1. Wooded Areas**

- a. single lean-to;
- b. double lean-to;
- c. wigwam;
- d. tree-pit shelter; and
- e. chopped or fallen tree.

#### **2. Open Country and Barrens**

- a. tent roof shelter;
- b. snow trench;
- c. snow house;
- d. snow wall; and
- e. snow cave.

### **338. Shelters in Wooded Areas**

#### **1. Single Lean-to**

- a. Select two live trees about eight inches thick as uprights. The distance between them should be at least two feet per man. If the time and the depth of snow permits, clear it to near ground level.
- b. Place on the top crosspiece. This should be four to five inches thick at the butt end and about four feet longer than the distance between the uprights. This top crosspiece should be about five feet or shoulder height off the ground and on the roof side of the lean-to. It can be placed in a crotch of a tree or propped up (see Figure 3-7). If the distance between the trees is over 15 feet, then the crosspiece should be braced in the centre. Use a pole three to four inches in diameter and about six feet long. Make sure that the bottom of the pole is on solid footing (see Figure 3-7).

- c. Place in the front bottom crosspiece. This is the same size just so it spans the distance between the two uprights. It is placed on the roof side of the lean-to and its purpose is to prevent the sleeping bags from sliding into the fire as well as holding the boughs used for insulation in place (see Figure 3-8).
- d. Place in the bottom rear crosspiece. This is the same size as the front crosspiece and is placed about seven feet from the front bottom crosspiece. Its job is to help raise the back of the lean-to roof and also hold the boughs in place (see Figure 3-8).
- e. Place on the back pieces. These should be two to three inches thick at the butt end and ten to twelve feet long. The butt ends are set on the ground and resting against the rear bottom crosspiece, the top ends are resting on top of the top crosspiece and are spaced no more than eighteen inches apart (see Figure 3-8).
- f. Cover the roof of the lean-to. This is done by shingling boughs on it from the bottom and building up. The thickness of the roof should be at least six inches, or thick enough for a man to walk on as the roof is being built up (see Figure 3-8).

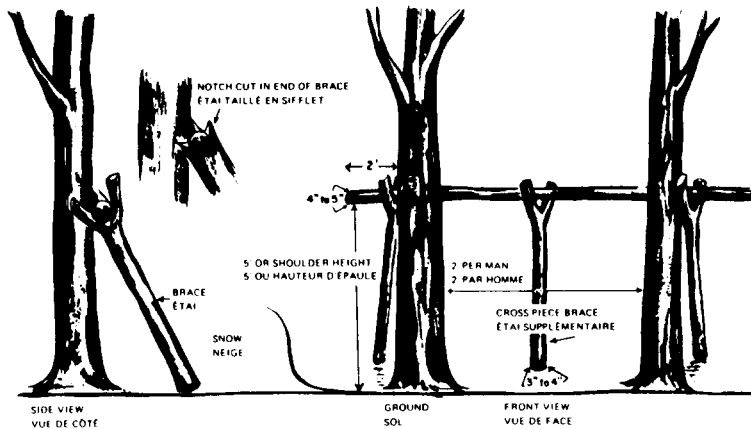

Figure 3-7 Single Lean-to - Stage 1

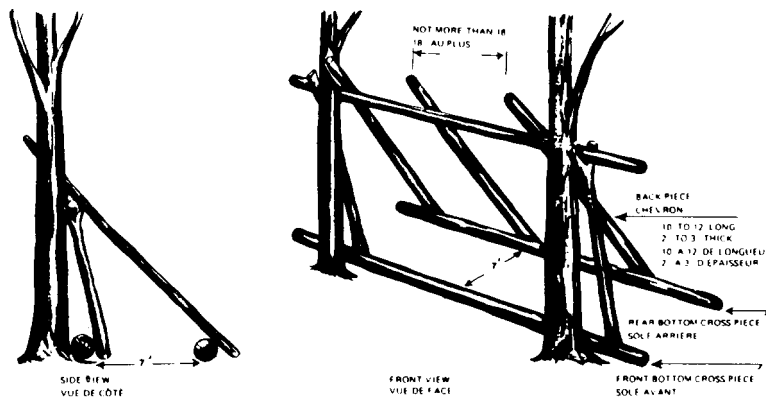

Figure 3-8 Single Lean-to - Stage 2

- g. Close in the sides of the lean-to. The most common method is to cut short trees or to use the tips of large trees, lean these against the sides of the lean-to with the cut or butt end up (see Figure 3-9).
- h. Place boughs on the bottom of the lean-to for insulation from the ground. This bed of boughs at least six inches thick, is made by using only the tips of the branches. They are placed in with the sharp or broken end down, leaving the tips of the boughs pointing up. This method takes a lot of time and a lot of boughs. If the time does not permit or the cutting or boughs is restricted for concealment purposes, make a bed of boughs by laying them down flat. Make certain there are no sharp points sticking up or any small dead twigs pointing up because these will puncture the sleeping pad.
- j. Trim off any branches or tips of boughs hanging down between the backpieces and bank the back and sides of the lean-to with snow.
- k. If canvas, ponchos, or some other type of material is used to cover the roof of the lean-to, place logs against the backpieces, with the roof covering between them. This will prevent the roof from being lifted or blown off by the wind. This completes the building of the lean-to.
- m. The lean-to can be heated by an open fire, preferably a log fire. To build a log fire:
  - (1) place short green logs on the ground to hold your fire up for better draft;
  - (2) take two dry logs at least the length of the lean-to and eight to fifteen inches thick and place these over the top of the smaller green logs;
  - (3) place a green log the same size on top of and in the centre of the two dry logs;
  - (4) fire is started in several places to help it spread the entire length of the logs. For better burning the log surfaces facing each other should be chipped (see Figure 3-10);
  - (5) if the fire is built on top of deep snow, it will only sink down and go out. To prevent this, build the fire on a fire base. The fire base must be as long as the fire (see Figure 3-10);
  - (6) if using smaller dry logs, the tendency for troops who first start living in a lean-to is to underestimate the amount of firewood that will be required to keep a fire burning all night. As a rule of thumb, gather the amount of firewood that you estimate you will require and then triple this amount.

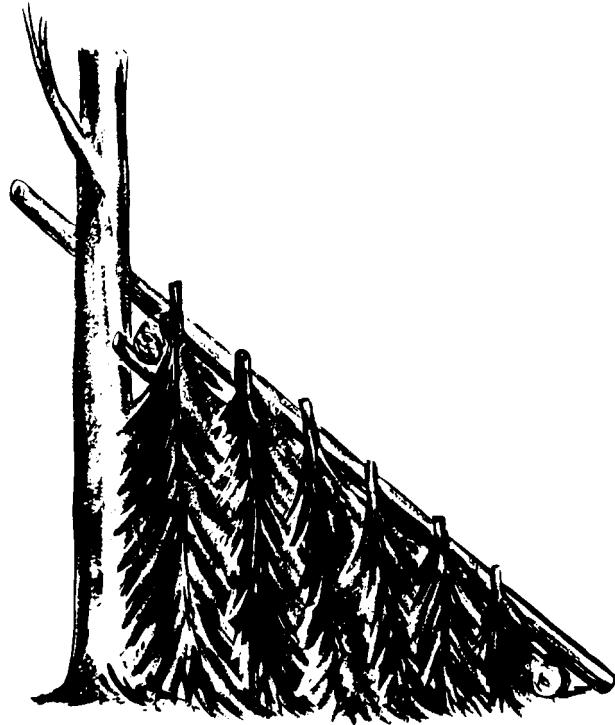

Figure 3-9 Single Lean-to Side View - Stage 3

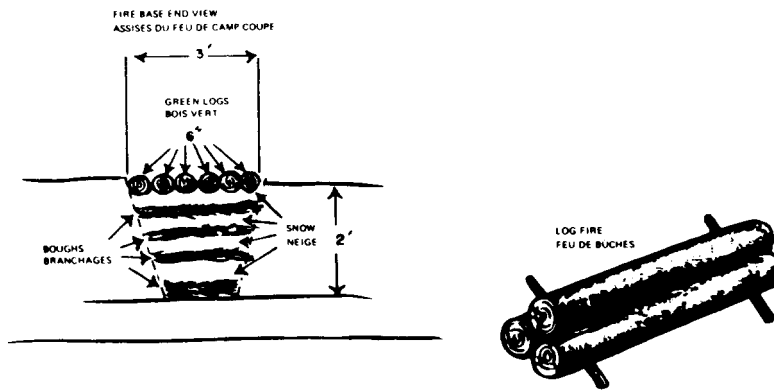

Figure 3-10 Fire Base and Log Fire

- n. Reflector Wall. To reflect the heat of the fire into a lean-to and also to act as a small windbreak, a reflector wall should be constructed. It is made of green logs the length of the lean-to and build up like a wall approximately three feet from the outside edge of the fire. For an example of walls see Figure 3-11.

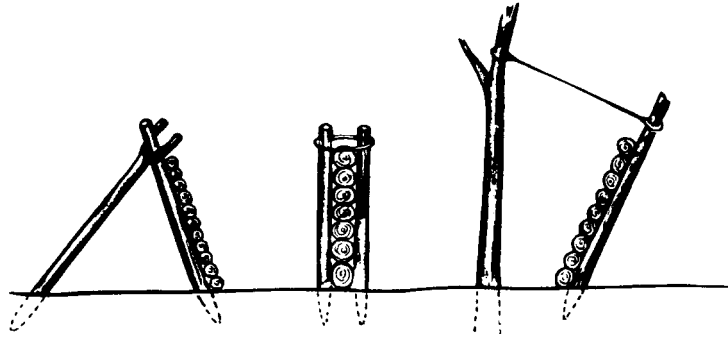

Figure 3-11 Log Reflectors

### 339. Double Lean-to

A double lean-to is built the same as two single lean-tos facing each other. The front of the second lean-to is generally where the reflector wall would normally be positioned. For an example, see Figure 3-12 showing a double lean-to with the near ends not closed in.

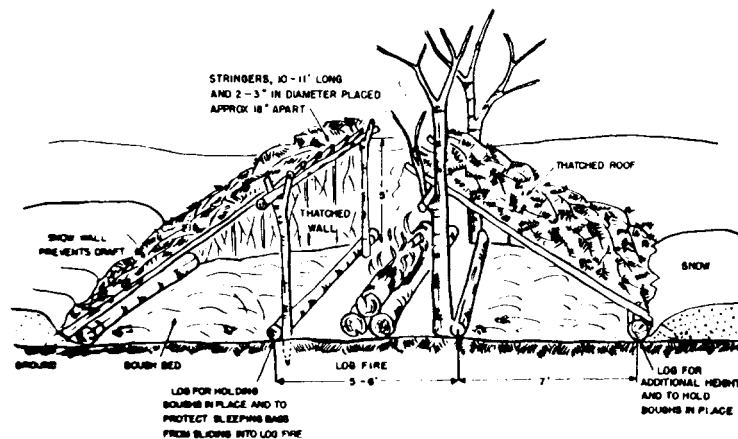

Figure 3-12 Double Lean-To

### 340. Wigwam

1. In lightly wooded areas, a wigwam will provide shelter for up to 10 men. Take three poles about 10 feet long and three inches thick and tie them together about one foot from the small end. Place them in an upright position with the tied ends uppermost. Then spread the poles so that the distance from the ground to the point where the poles are secured is about eight feet.
2. To provide support for the cover of the wigwam, select several side poles, two inches thick or less, and about the same length as the main poles. Lean these side poles against the tie position of the main poles.
3. To hold the side and main poles in position, place short poles flat on the ground between the ground ends of the side and main poles. Cover the frame with ponchos, canvas, or other



suitable material, tying separate pieces of this covering together. Leave an opening for an entrance. When boughs or branches are the only available material, use more side poles to provide a closer frame on which to weave. Bank the lower edge of the completed wigwam with snow to prevent draft.

4. A bough bed should be built up in the same manner as for a lean-to.
5. Hang an improvised fire box from the top of the lean-to by a wire. The fire box can be made out of a large tin can. A draft channel under the wall will give added comfort and there should be a smoke hole at the apex.
6. The wigwam can also be heated by building a fire and a reflector wall outside the door (see Figure 3-13).



Figure 3-13 Wigwam Shelter with Reflector Wall

### **341. Tree-Pit Shelter**

In wooded areas a large tree often has a natural pit at its base where the snow will be fairly shallow. A shelter can be built here which will give good temporary protection. Enlarge the natural pit at the base of the tree to the depth and size required. Line the walls with boughs and branches and build a bough bed in the bottom of the pit. Make an overhead covering of boughs and branches or other available material. Dig in an entrance (see Figure 3-14).

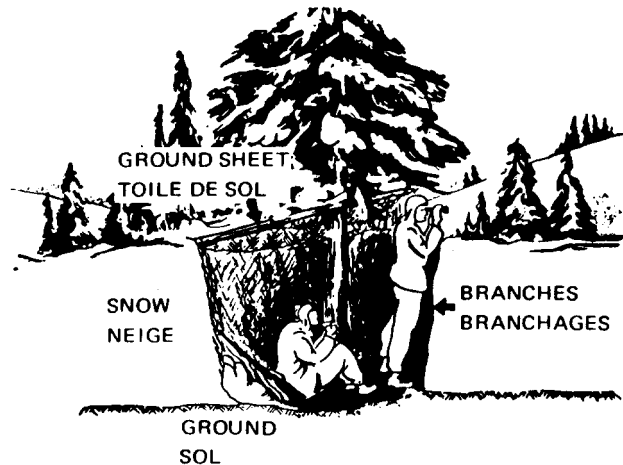

Figure 3-14 Tree-Pit Shelter

### 342. Chopped or Fallen Tree Shelter

A low tent like shelter can be made from a chopped or fallen tree. Use a tree with the main stem about four feet off the ground. Either find a fallen tree, chop a tree down or lift the butt end up. Whichever way is used, make sure that the butt is securely held off the ground. Trim the inside boughs off and use these to thicken up the remaining ones on the sides. Make a bough bed. Heat your shelter with a small fire in the front (see Figure 3-15).

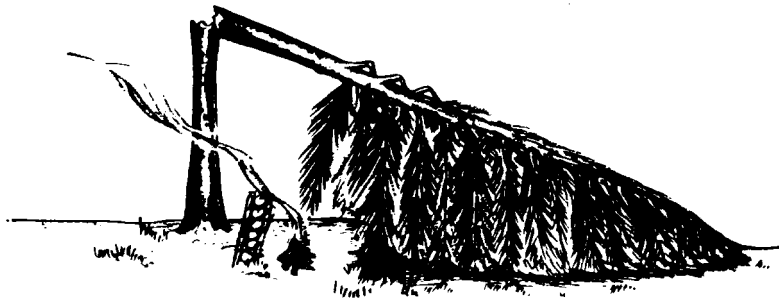

Figure 3-15 Chopped or Fallen Tree Shelter with Fire and Log Reflector

### 343. Shelters in Open Country and Barrens

1. **Tent Roof Shelter.** The tent roof shelter for 10 men is the quickest and simplest of all the types of snow shelters to build. A complete tent or parts of a destroyed tent can be used. It is also the easiest one to conceal from air and ground observation.

- a. To build this type of shelter, lay the tent out on the ground and shape it for the first phase of tent pitching. Mark the outline in the snow.
- b. With the tent removed, mark the snow again, approximately eight inches inside the first mark (see Figure 3-16).

- c. Dig out the snow from inside this last mark to a depth of four feet.
- d. Place on roof supports. This can be done by laying logs across the hole. About 10 logs will be required (see Figure 3-17) or if no logs are available, remove the pole and guy ropes from the tent and with the pole upright in the centre of hole, tie all the guy ropes to the top of the tent pole and extend them out around the hole in a wagon wheel fashion (see Figure 3-18). The top of the pole should not extend above the surface of the snow.
- e. Lay the tent over the roof supports and pile snow on the outside edges and snow flaps. When the tent is laid over the roof supports, if in an all white area, the tent liner must be to the outside. If the liner was completely destroyed, use the outer tent as a cover and camouflage with ruck-sack covers. If no camouflage material is available, cover the roof with snow. When covering the roof with snow, the heat of the shelter must be kept very low to prevent the snow from melting and soaking through the roof covering.
- f. If the snow is not deep enough or the need for concealment is not great, the hole need only be dug to three feet with a row of snow blocks 11/2 feet high placed between the first and second marks of the tent outline, around the complete hole (see Figure 3-19).
- g. The shelter exit should go out level with the floor and then down so that the top of the tunnel entrance is eighteen inches below the floor level. This acts as an air trap, keeping the cold air from entering the floor of the shelter (see Figure 3-19).

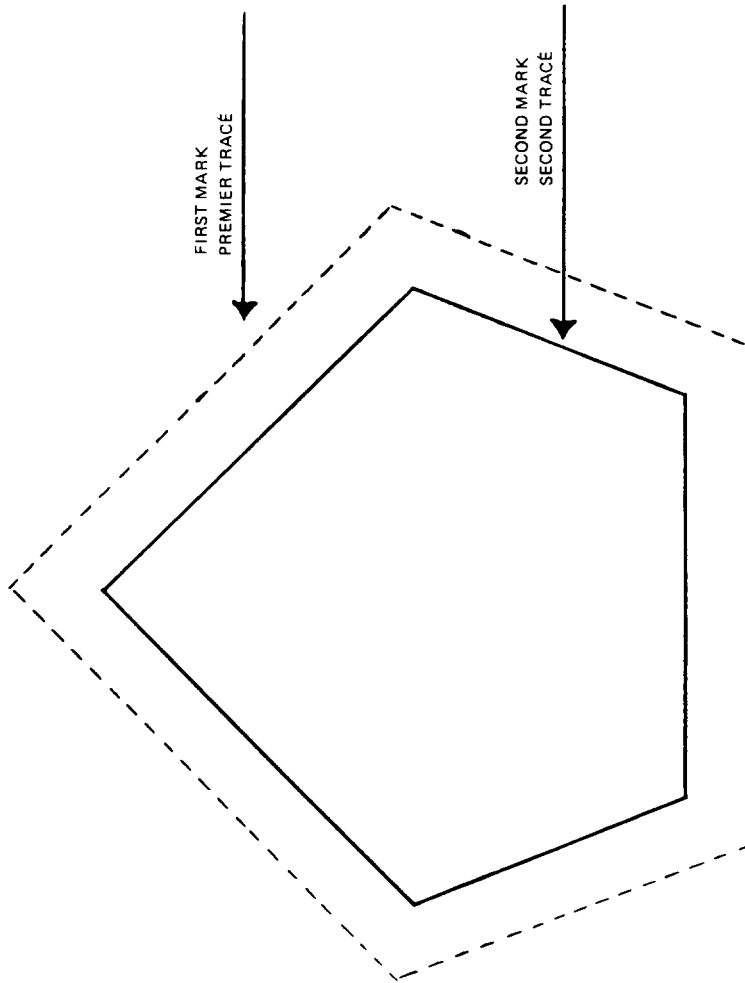

Figure 3-16 Tent Roof Shelter - Stage 1

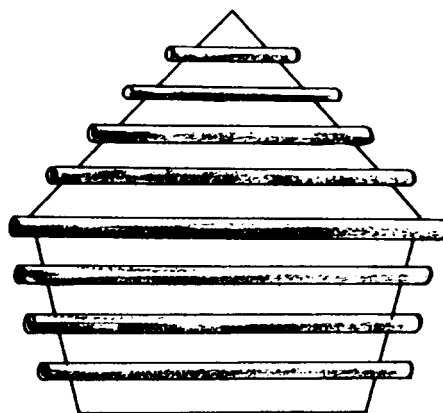

Figure 3-17 Tent Roof Shelter - Stage 2

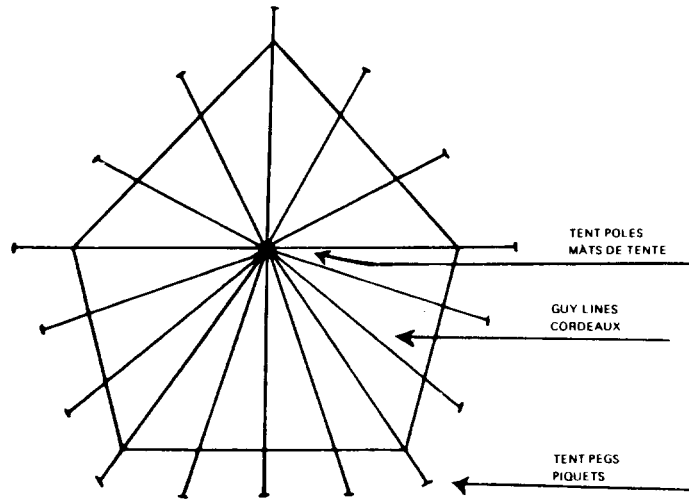

Figure 3-18 Tent Roof Shelter - Stage 3

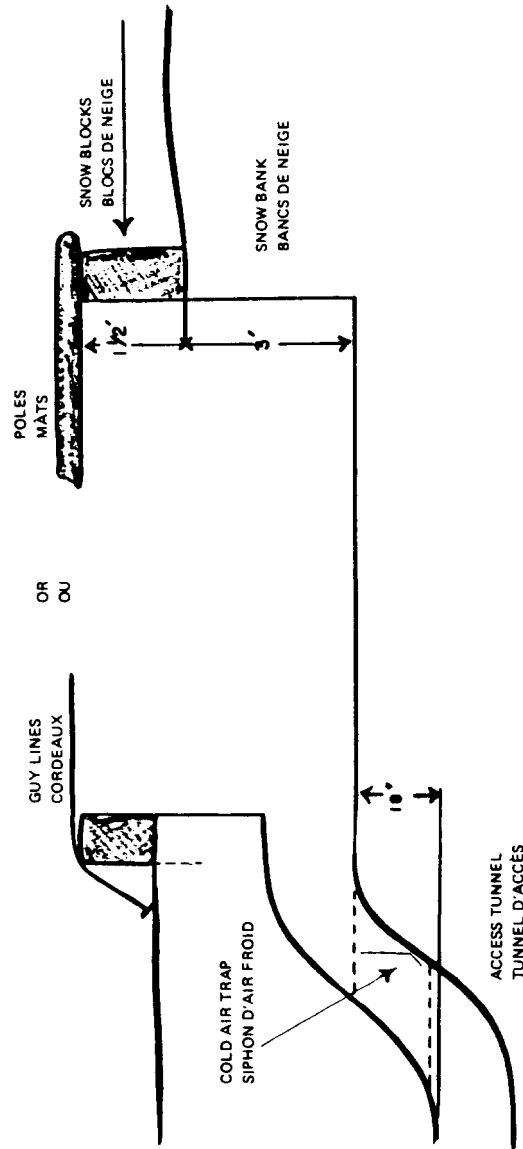

Figure 3-19 Tent Roof Shelter - Stage 4

## 2. Snow Trench

- a. If you are faced with the problem of finding shelter quickly and no other type of shelter is available, a snow trench can be used.
- b. To build a snow trench all you need to do is scoop or dig out a trench about seven feet long and two feet wide.
- c. Cover the roof with a poncho, boughs, or snow blocks laid over skis, or snowshoes. Line the bottom with boughs for added insulation.
- d. Leave a small entrance and exit hole at one end.
- e. If the snow is not deep enough you can always build a trench around you (see Figure 3-20).
- f. For an improved version of the snow trench see Figure 3-2 1.

### 3. Snow House

- a. A snow house is an improved version of the snow trench using only snow blocks for its entire construction.
- b. The first stage of building is the same as for a snow trench.
- c. To close in the roof, use as many snow blocks as required to build up the ends. Trim these ends to a sharp peak (see Figure 3-22).
- d. Lay snow blocks alternately along the sides and leaning in to each other. Cut all the snow blocks the same width, this will keep the joints staggered. Trim the top of the snow blocks for a close fit (see Figure 3-23).

4. Snow Walls. In open country when no other type of shelter is available, a snow wall can protect you from winds. Use snow blocks cut from compact snow and build a semi-circle to a height of about three feet. Bank up with loose snow on the windward side. This provides a windbreak behind which to sleep (see Figure 3-24).

### 5. Snow Cave

- a. The snow cave is the most wind-proof of all the improvised shelters, however, it is the most time consuming one to build. Snow caves are built on the principal of five men to a sleeping bay. For more men, add more sleeping bays but leave a supporting wall, at least one foot thick between bays.
- b. The quickest method to build a snow cave is to dig a trench seven feet deep, two feet wide and ten feet long.
- c. Dig in the sleeping bay, 18 inches up oil the bottom of the trench and hollowed out to a comfortable sitting height, usually about four feet. When digging out the sleeping bay any snow that melts will either run off to the sides or to the foot of the sleeping bay (see Figure 3-25).

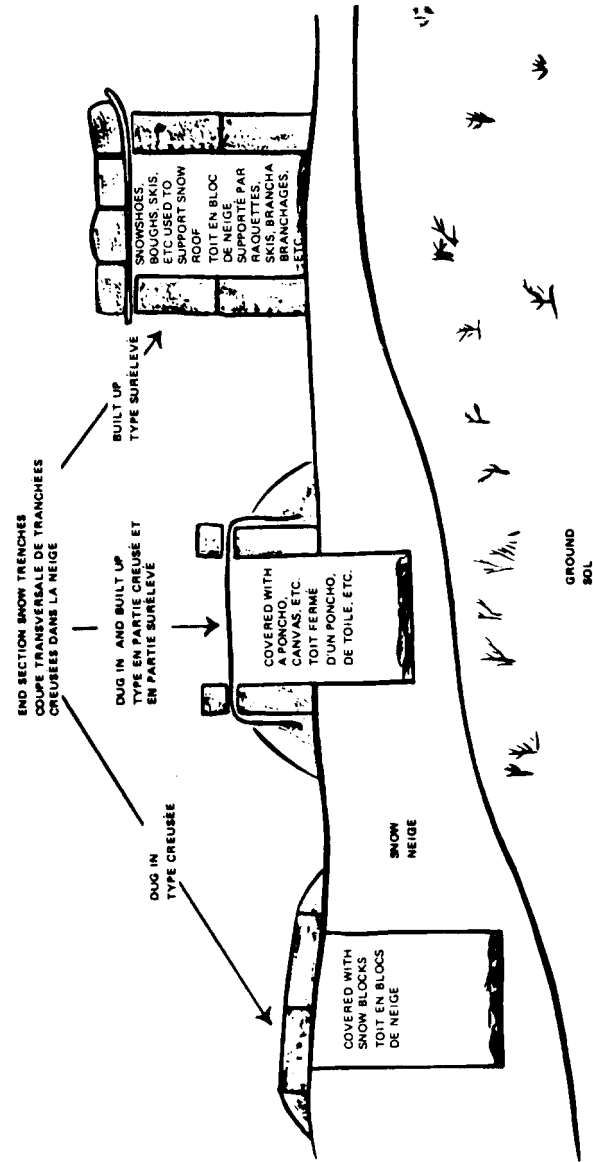

Figure 3-20 Snow Trenches

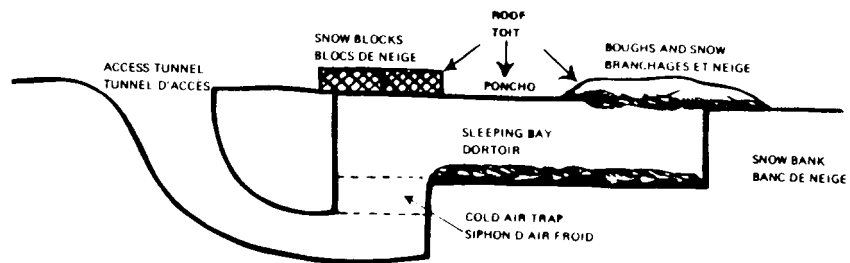

Figure 3-21 Cross Section of Snow Trench



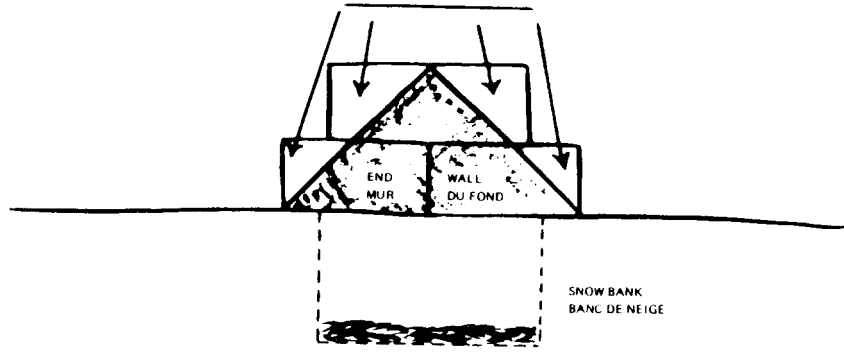

Figure 3-22 Snow House - Stage 2

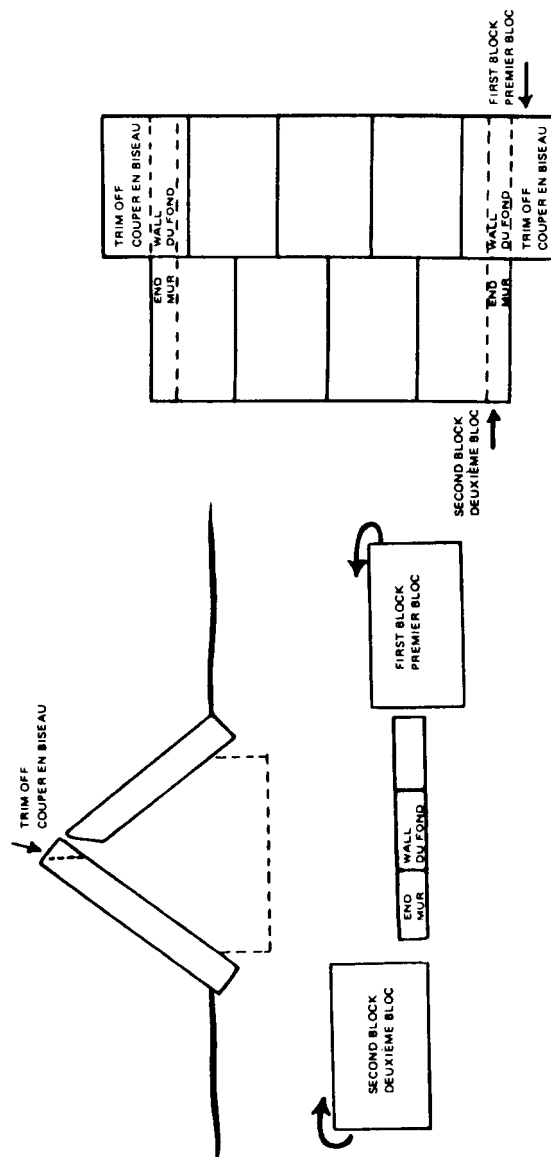

Figure 3-23 Snow House - Stage 3

- d. Dig in the entrance on the same principal of the tent roof shelter and close in the roof of the trench with snow-blocks.
- e. After the cave has been dug, improvements can be made as shown in Figure 3-25.

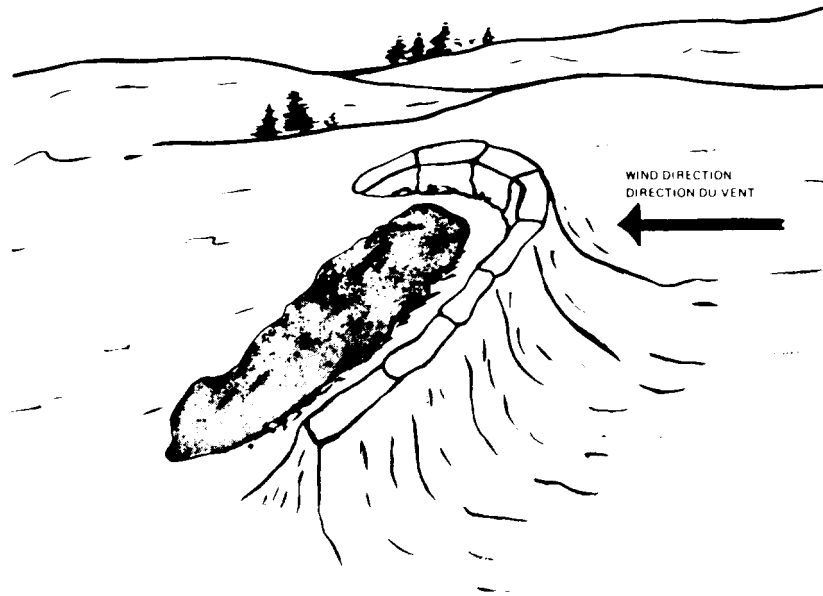

Figure 3-24 Sleeping Behind Snow Wall

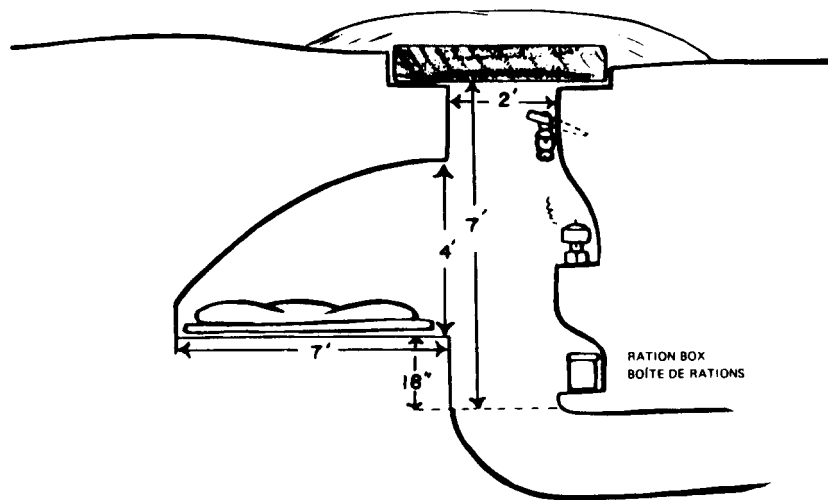

Figure 3-25 Snow Cave

- f. Snow caves can be made larger or smaller as long as a few principals are followed, these are:
  - (1) The top of the tunnel entrance should be 18 inches lower than the sleeping platform.

- (2) The roof must be arched for support as well as to drain any water formed by melting snow.
- (3) There must be at least one ventilation hole. A pole should be left in this hole so that in the event of a snowstorm a few periodic pokes with the pole will keep the vent hole clear.
- (4) The sleeping bay must be high enough to provide a comfortable sitting position.

#### **344. Conclusion**

By using your initiative and imagination and using only the natural materials available, you can build an adequate shelter in any season and in any area.

**(345 to 399 inclusive not allocated)**

## CHAPTER 4

### WEAPONS AND FIELD WORKS

#### SECTION 1 - SMALL ARMS AND AMMUNITION

##### 401. General

In cold areas many climatic conditions will greatly affect the operation and employment of infantry weapons. All individuals must be aware of these conditions in order that they may properly handle and care for their weapons under these adverse circumstances.

##### 402. Weapon Problems

1. The main problems are:
  - a. care and maintenance of weapons;
  - b. breakages and malfunctions due to extreme cold;
  - c. handling and firing while wearing cold weather handwear;
  - d. creation of fog when firing automatic weapons at low temperatures;
  - e. need for a base or platform when firing weapons from a tripod or bipod in deep Snow;
  - f. cold weather effects on ammunition; and
  - g. poor fragmentation in snow.

##### 403. Care and Maintenance of Weapons

Lubrication. Because oil and grease thicken at low temperatures, weapons must be completely stripped down and cleaned with a solvent, naphtha for example (not hot water), and re-lubricated sparingly with special light oil, 3GP 335. If 3GP 335 is not available, weapons should be fired dry at very low temperatures, since no oil at all is better than heavy oil or too much oil. All weapons with a return spring will be cleaned of all oil or grease and re-lubricated accordingly.

##### 404. Condensation

Condensation forms on weapons when they are taken from the extreme cold into any type of heated shelter. This is called "sweating". When weapons are taken out into the cold again, this film of condensation freezes and the ice so formed will seriously affect the weapon's operation. For this reason, leave weapons outside in sub-zero temperatures. When left outside, put them where they are readily accessible but where ice and snow will not get into the working parts, sights, or barrel. Weapons may be taken inside for cleaning but weapons taken into a shelter may "sweat" for as long as an hour. Therefore, if time is available, wait one hour then clean off the weapon.

#### **405. Snow and Ice**

Keep snow and ice away from the barrel, sights, and working parts of the weapon. Breech and muzzle covers must be kept on weapons when they are not in use. If covers are not issued, improvise them from plastic bags from the ration packs or any suitable material.

#### **406. Weapon Mechanisms**

1. Special care must be taken to prevent the bolt or breech-block from freezing.
2. The most common time for the bolt or breech-block to freeze in the closed position is shortly after being fired when condensation will form at the head-space of the bolt or breech-block and the cartridge chamber. This condensation is formed by the cooler face of the bolt or breech-block being in contact with the much warmer mouth of the cartridge chamber. This condensation will form and freeze very quickly, producing a stoppage that at times is almost impossible to remedy, with the exception of thawing out the weapon in a heated shelter.
3. It must also be noted that after a weapon has been fired condensation will form in the barrel as well as the cartridge chamber. When the condensation freezes, it produces a stoppage by not allowing a round to be fully seated, thereby making it impossible to fire the weapon. This is overcome by leaving the live round in the chamber. If this round freezes in the chamber and cannot be extracted by using the cocking handle, it can be fired. It must be understood that the instant this round is fired, that the great heat that is immediately generated will melt any frozen moisture that is between the casing and the cartridge chamber, before any ejection action begins to take place. To help prevent stoppages, because of the effects of cold weather, carry out the following drills:
  - a. After firing, work the mechanism every few minutes, leaving a live round in the chamber, until all danger of freezing is past. This may take up to an hour.
  - b. Check your weapon at each halt to ensure that snow is not seeping in through the breech cover.
  - c. Work the firing mechanism by hand before firing to ensure it functions freely and to reduce the possibility of misfires.

#### **407. Breakages**

Another problem that faces the soldier in areas of severe cold is a higher rate of breakage. Cold makes the metal in the weapons brittle and when a weapon is fired in sub-zero temperatures, breakages will occur to the working parts early in the firing. Weapons should first be fired at a slow rate and once the parts have warmed up the rate of fire can be increased to the weapon's normal rapid rate of fire.

#### **408. Cold Weather Handwear**

1. When wearing mitts your speed in handling and firing weapons will be reduced. However, the use of the trigger mechanism will solve the problem. No particular problems exist in the use of hand grenades in extremes of climate, with the exception that:

- a. The handgear must be completely dry. Handling of snow and ice with gloves or mittens may result in grenades freezing to the wet handgear.
- b. Grenades must be held near the neck to avoid slipping or turning of the grenades when the safety pins are removed.
- c. An aid in preventing hand grenades from sinking down in the snow before exploding is to tie a broad stick to the grenade to give it increased floatation.

#### **409. Ice Fog**

1. When an automatic weapon is fired in temperatures below -20°F, the water vapour in the air is crystallized as the round leaves the weapon. This creates very small ice particles which produce ice fog. This not only obscures the vision of the man firing but could also give away his position. When faced with this problem, the weapon should be:

- a. fired at a slower rate of fire to produce little or no fog; and
- b. fired from alternate positions.

#### **410. Weapon Cleaning General**

1. The time for the cleaning of weapons will depend upon climatic conditions, hours of daylight/darkness, and types of operations.

2. The following are some suggested methods that have been tried and found to be successful to varying degrees:

- a. Method one is to bring half your tent group weapons into the tent, let them condensate, clean, and place them outside. Repeat this procedure.
- b. Method two is to place the weapons in the tent at half hour intervals; ie, one being cleaned, one finished condensating, and one starting to condensate. The first weapon should not be cleaned until it has condensated.
- c. Method three is if the commander decides he may order all weapons from one (1) tent group to be cleaned at one time.
- d. C-2 and MGs must never be left in a tent longer than the required time for cleaning. During the hours of darkness the C-2 or MGs should not be brought into the tent unless it is for repairs. To speed up condensation lash your weapon to the tent pole directly over the lamp.

#### 411. Weapon Platforms

Bipods and tripods of automatic weapons will sink in the snow. To solve this problem you will have to improvise some method of giving them added flotation on the snow. This can be done by tying the legs to a snowshoe or by tying a strip of cloth from one leg to another (see Figures 4-1 and 4-2).



Figure 4-1 Weapon Platform



Figure 4-2 Weapon Platform

#### 412. Ammunition

1. Extreme cold weather does not materially affect the accuracy of weapons or the performance of ammunition. Ammunition, however, should be kept at the same temperature as

the weapons and should be carried in bandoliers, with additional ammunition in the pockets of the outer parka and the rucksack. Ammunition clips and magazines must be cleaned of all oil and preservative and must be checked frequently. All ice and condensation must be removed.

2. Ammunition should be stored in its original container, raised off the ground, and covered with a tarpaulin. It should be suitably marked so that it can be located easily after a snowfall.

3. The burning rate of various types of propellant charges are affected by severe cold. Weapons zeroed under temperate conditions will fire low in severe cold because the propellant charge burns slower. Rocket bombs burn at an uneven rate causing wobbling in flight and less accuracy.

#### **413. Conclusion**

Extra care is called for in cold weather operations, plus the realization that snow and cold winds can make weapons unserviceable unless the soldier beats them by maintaining a high standard of protective maintenance.



## SECTION 2 - FIRING POSITIONS IN SNOW CONDITIONS

### 414. General

Firing positions under winter conditions do not differ greatly from those used in summer. The essential difference is a knowledge of snow depth, type, and how to combat the difficulties encountered. Soft deep snow allows the firer and weapon to sink, hence some form of support is required. Hard packed, wind driven snow on the other hand provides firm support, but causes weapons to slide or jump unnecessarily. An added factor is the necessity to use skis or snow shoes, depending on snow cover. The methods of overcoming these problems are outlined in paras 415 to 418.

### 415. Small Arms

1. All shoulder fired weapons fall into the small arms category and at the present time include:

- a. Rifle FN 7.62mm C1;
- b. Rifle Light Automatic FN 7.62mm C2.
- c. Sub-machine Gun 9mm;
- d. M 72 Light Anti-tank Weapon; and
- e. Carl Gustaf.

2. These weapons can be fired from the following positions:

- a. prone;
- b. squatting;
- c. kneeling; and
- d. standing;

### 416. Method

1. Only four methods are described. Several more may be adopted.

- a. Prone Position. This position is normally adopted when fired upon by the enemy. When this happens, immediately go to the ground, then, by using your hands and feet while squirming the body, dig down to a depth of approximately 18 inches. Under hard snow condition, break the surface by using either snowshoes, skis, poles, or rifle butt. Once the body is below snow level, if necessary, use the snowshoes or skis as an elbow rest or weapon platform (see Figures 4-4 and 4-5). If pulling the toboggan, adopt the prone position behind it and use it as a cover and weapon platform.

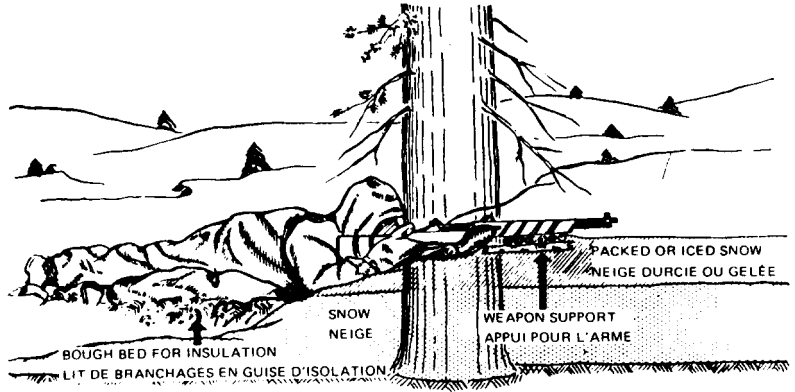

Figure 4-3 Prone Position in Soft Snow



Figure 4-4 Prone Position Using Snowshoe as a Weapon Platform



Figure 4-5 Prone Position Using Skis

- b. Kneeling and Squatting Positions. These positions are normally adopted during the attack phase where low cover, such as snow drifts or brush, is available. No difficulty should be encountered when wearing snowshoes, using either position, or skis using the squatting position. In the kneeling position wearing skis, the right ski is lifted backwards and placed diagonally behind the left with the instep of the foot facing towards the ground. In soft snow, the right knee can be supported by placing a ski pole under it. In both positions the ski poles may be used as a weapon rest (see Figures 4-6, 4-7, and 4-8).
- c. Standing Position. This position is normally adopted in forested areas where adequate tree cover is available. In some instances the ski poles may be used as a weapon support (see Figures 4-9 and 4-10).



Figure 4-6 Kneeling Position on Snowshoes



Figure 4-7 Kneeling Position on Skis Using Poles as Weapon Support



Figure 4-8 Kneeling position on Skis Using Poles as Weapon Support



Figure 4-9 Standing Position on Skis Using Poles as Weapon Support



Figure 4-10 Standing Position on Skis Using Poles as Weapon Support

#### **417. Support Weapons**

1. Support weapons, because of their weight and bulk, provide additional problems under winter conditions. Weapons considered are:

- a. 7.62 mm General Purpose Machine-gun (GPMG);
- b. 50 Calibre Browning Machine-gun;
- c. 81 mm Mortar C3;
- d. 106 mm Recoilless Anti-tank Gun;
- e. SS11;
- f. Entac; and
- g. 60 mm Mortar.

#### 418. Methods

1. Firing position considerations are as follows:

- a. GPMG and 50 Calibre Browning Machine-gun. In most cases normal firing positions can be used. Platforms can be improvised by placing snowshoes or skis under the tripod. When on the move, both weapons can be mounted on the toboggan, as shown in Figure 4-11. When firing either weapon across the toboggan, the No 2 should lie across the toboggan to provide a stable platform and to prevent the toboggan from sliding.



Figure 4-11 Machine-gun Mounted on a Toboggan

- b. 81 mm Mortar. The main problem to be overcome using this weapon, is to provide a stable platform and avoid contact directly with the frozen ground which will cause the base plate to crack, buckle, or break. In all cases, filled sand bags (with snow or earth) should be used. These should be carried on vehicles or on a separate toboggan. On completion of firing, where possible, the contents from split sand bags should be retained to avoid the necessity of breaking frozen ground. Where earth is too difficult to obtain, a brush-covered two layer log platform with the layers at right angles can be used. The logs should be approximately three inches in diameter and not less than five feet long.
- c. 106 mm Recoilless Anti-tank Gun. The main problem is to provide a stable gun platform to support the weapon (483 pounds). If the snow depth will not permit

digging down to ground level (18 inches of clearance between the breech and surface level of ground or snow are required) a platform similar to that described in subpara b above, must be constructed. Where possible, the position should have hard packed snow to the rear to prevent the excess vapour clouds which will form from the melted snow cloud blown up by the back blast.

#### **419. Conclusion**

In view of the variety of conditions encountered in winter operations the above procedures are to be used as a guide only. Unit instructors must use common sense and adapt their instruction to the practical aspects of this subject.

## SECTION 3 - FIELD DEFENSES

### 420. General

1. In cold weather operations, you will have two opponents: the enemy who must be defeated and nature who must be made an ally. Basically the defensive layout of a unit or sub-unit remains the same, summer or winter. The main difference in winter is that the defences may be closer together or the shelters will be closer to the fire positions. You will find that frozen ground and severe cold are not ideal conditions for the construction of field defences. However, when the snow is so deep or the ground is frozen to such an extent that you cannot dig down, you can usually build up, and by using a few special cold weather techniques you can build effective fire positions.

2. When the time and stores are not available or the tactical situation rules out the use of explosives or fires to either break up the ground or thaw it enough to permit the digging of fire positions, then you must utilize the available material and build effective field defences.

### 421. Penetration Table

1. Snow surface has a smothering effect on all types of fire. However, hard frozen bare ground or ice, when not covered with snow, greatly increases the number of ricochets and the fragmentation effects. The resistance or protection offered by snow, ice, or frozen ground against enemy fire varies a good deal.

2. Penetration table. The minimum thickness for protection from small arms fire and shell fragments is shown in this table:

<u>Material</u>	<u>Minimum Thickness in Feet</u>
Newly fallen snow (no wind)	13
Wind-driven snow	8
Packed snow	7
Ice	31/2
Ice-crete	1
Frozen snow/water mixture (snow-crete)	4

3. It is emphasized that although these thicknesses will give adequate protection they will not withstand sustained fire. If time is available the minimum thicknesses should be increased. It should also be noted that if a thaw occurs, the ice-crete will become a loose gravel wall and if built only one foot thick, it will not stop small arms fire.

### 422. Walls and Forms (Frameworks)

The problem of building any type of winter fire position is the construction of some type of form or wall against which or into which the material used to smother small arms fire will be



placed. The methods for making walls or forms shown in this section are not hard and fast rules that you must follow. They are only a guide for some of the types of walls and forms that can be built, as well as some of the materials that can be used. The only factors that regulate the type of walls or forms that can be built is the available material and the individuals own initiative. There are no measurements shown of the length of the fire positions. Its width and its height will depend on how many men are going to man it, what material is used for fill, the depth of the snow, and whether or not you can dig down into the ground.

#### **423. Snow Defences**

1. The types of walls that one usually constructs to pile or pack snow against are as follows:
  - a. Type 1. Select two trees as uprights and by laying logs against them, one on top of the other and holding them in place by banking them with snow, a wall can be built to the required height (see Figure 4-12).
  - b. Type 2. Construct two tripods and have one leg facing to the rear, and two to the front. On these four front legs build up a wall of logs by laying them one on top of the other to the required height. This type of wall will to some extent provide some overhead cover (see Figure 4-13).
  - c. Type 3. Cut two short logs for uprights and one heavy log for an anchor. Tie a rope, wire, or signal cable around the top of an upright. Leave about six feet of slack, and tie the other end around the heavy log. Tie another rope, wire, or signal cable to the bottom of the upright and the other end around the heavy log. Before securing, adjust the bottom line so that the top of the upright is leaning slightly towards the anchor. Do the same to the other upright. Pile logs in front of upright and bank with snow to hold in place (see Figure 4-14).

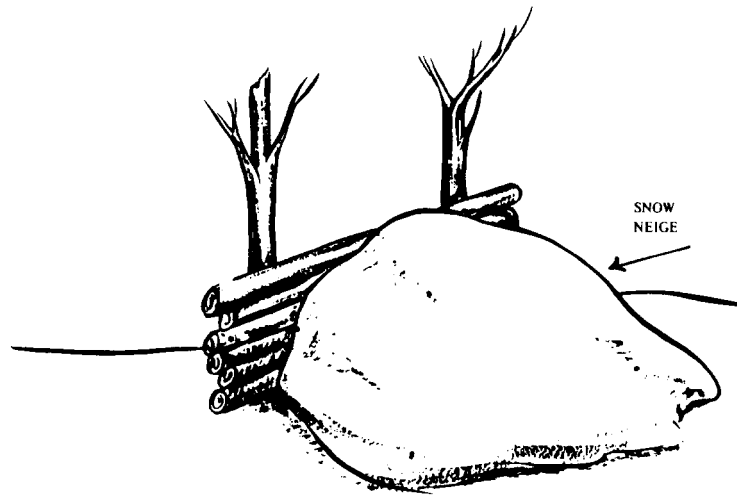
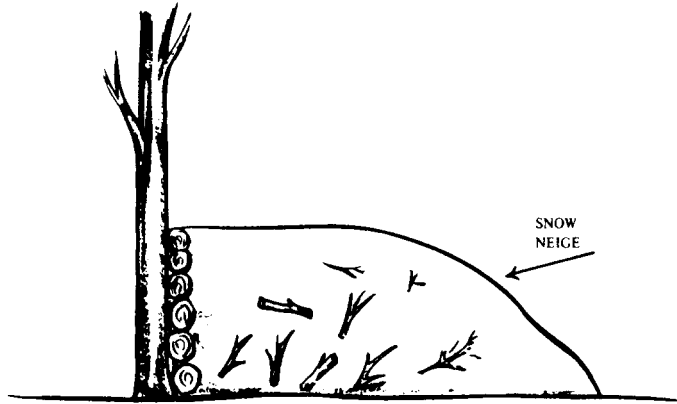

Figure 4-12 Snow Defences - Type 1



Figure 4-13 Snow Defences - Type 2

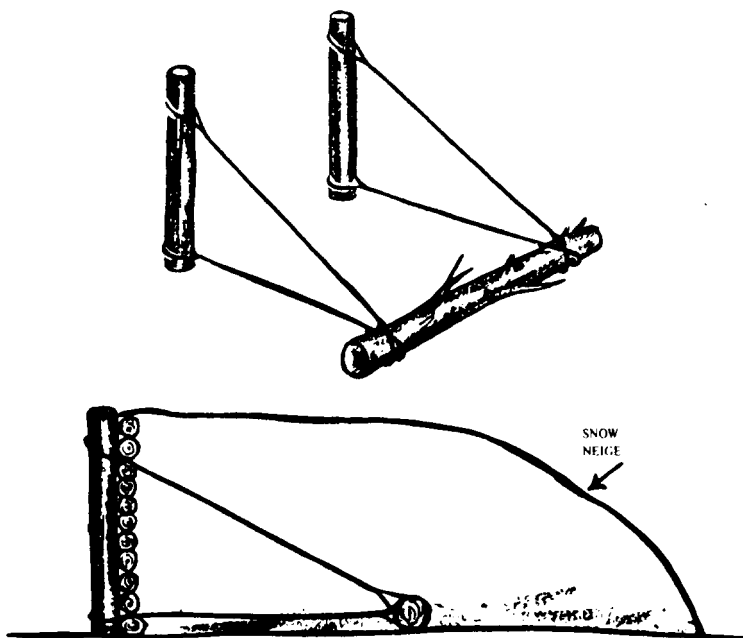

Figure 4-14 Snow Defences - Type 3

424. Ice-crete Defences

1. The types of forms usually constructed to be filled with ice-crete are as follows:

- a. Type 1. Select two trees, the diameter must be at least one foot. If they are not at least one foot thick, lash a log upright to the tree or one on each side to gain this thickness of one foot. Cut two logs for uprights and loosely lash a rope, wire, or signal cable around the bottom and top of the uprights. Do the same to the other tree. In the spaces between the uprights and the tree, pile small logs one on top of the other. Build up both sides at the same time to the required height (see Figure 4-15).
- b. Type 2. Cut logs the required height of the walls; and lay them side by side. The number of logs will depend on their thickness, but they should, when placed together, be one foot across. Across the top and bottom of these logs lash a crosspiece. The crosspiece should be about two inches thick and two feet long. Take two more uprights and lash them to the crosspieces, leaving a gap of about three inches. Make two of these frames. Standing the frames upright, lay logs one on top of the other with the butt ends being alternated in the gaps of these frames. This will end up like a rectangular box shape one foot thick. To make a form for a thicker wall simply add more uprights and use longer crosspiece (see Figure 4-16).

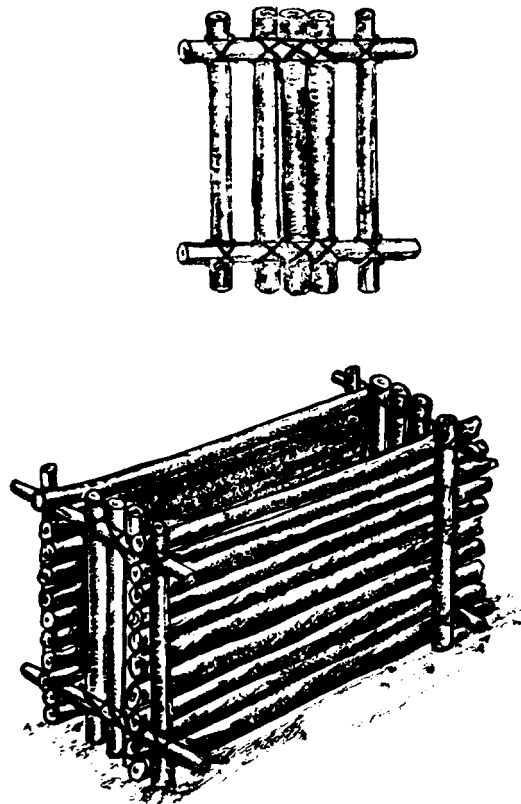

Figure 4-16 Ice-crete Defences - Type 2

- c. Type 3. This is simply building up a form on the principle of a log cabin. It has been found that this is the most time consuming one to build because all logs must be near the same thickness and all logs have to be notched at the corners to interlock with each other (see Figure 4-17).

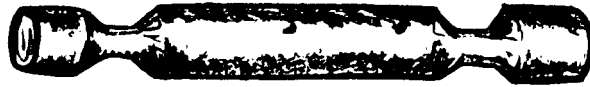

Figure 4-17 Ice-crete Defences - Notched Log - Type 3

#### 425. Ice-crete and Snow Defences

1. The following are some items that tent groups will have or can get to build walls and forms (see Figure 4-18).
  - a. Ration Boxes. These can be ration boxes of any size or any other type of cardboard box. To build a wall with them, fill them with snow, gravel, dirt, sand, etc., and stack them up one on top of the other with the joints staggered. To make the wall more secure, wet the top of each bottom layer so the next layer of boxes will freeze to it. If water is not available use short stakes and peg the layers together as the wall or form is being built.
  - b. Ammunition Boxes. Use only wooden boxes as the metal boxes will only increase the danger of ricochets. Build up the wall or form the same as for the ration boxes. With the wooden box, break out the centre bottom board or cut holes in the bottom of the box. Each layer can then be pegged together with short stakes or if gravel is available, fill the bottom layer of the boxes with gravel, then place on a layer of empty boxes and fill with gravel, then soak this layer of boxes with water. The gravel that would run out of the bottom hole to the layer under it being soaked with water and allowed to freeze will give you almost a solid wall of frozen gravel or ice-crete.
  - c. Sand Bags. Sand bags can be filled with snow, dirt, gravel, sand, etc., and built up into a wall or form. If the sand bag and the material in it is soaked with water, it will freeze into a solid wall or form. If using snow in the sand bags, then only dampen the outside of the bags so they will freeze together.
  - d. Snowblocks. If in an area where the snow is hard enough, cut out snowblocks. These can be used to build up forms or walls. The ideal size of a snow block to work with is 30 inches by 18 inches by 8 inches (76cm by 46cm by 20cm).

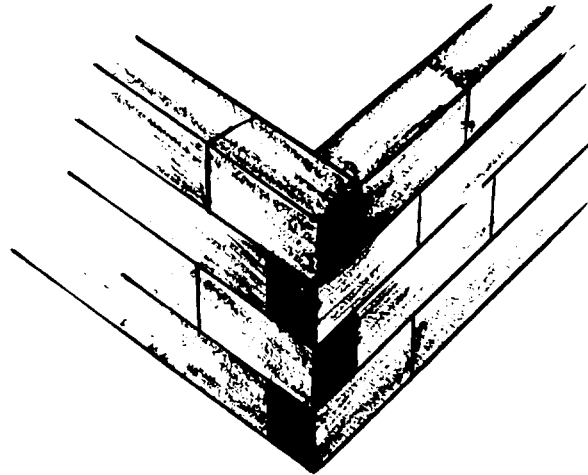

Figure 4-18 Ice-crete and Snow Defences - Wall Building

#### 426. Other Types of Defences

1. Snow-scrape. This is used only as an emergency fire trench. It can be dug down in the snow or by simply laying on the snow and pawing and scooping with the hands, twisting and squirming and kicking and digging with the feet and toes you can be below the surface level of the snow and have an elective fire position in a very short period of time.
2. Snow Trench. With the snow deep enough, this is the one most commonly used. It is dug into any deep snow and should be deep enough for a man to stand in (see Figure 4-19).

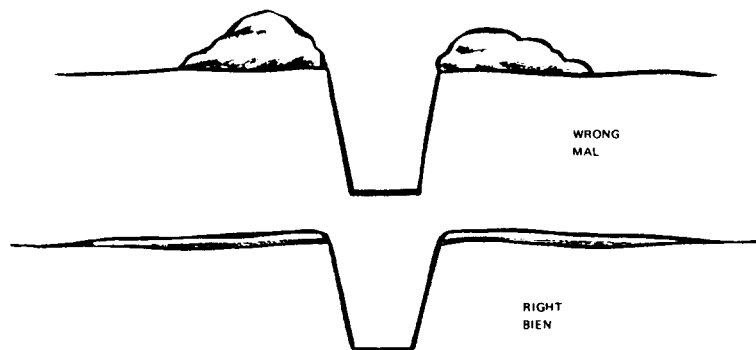

Figure 4-19 Snow Trench

3. Communication Trenches. These should connect all positions and be dug about 18 inches deep to give the men some protection when moving to and from weapon positions.

#### 427. Additional Points

1. All branches that were trimmed off the logs used in building fire positions should be used as part of the snow fill for added strength.

2. Ammunition boxes should be filled with wet gravel and used as part of the fill.
3. The icing of all fire positions adds greatly to their strength.
4. Where possible the forms should be left as part of the fire position. This will help prevent the fill from crumbling away if undergoing sustained fire.
5. The fire positions must be sloped in front and at the sides as an aid to camouflage.
6. One way to make ice-crete is to put in a layer of gravel about six inches deep and soak it with water and so on up. The best way is by using a pile of gravel (four sand bags full) mixed with lots of snow, then mix in the water. When well mixed it is shoveled into the form.
7. The best gravel for ice-crete is very coarse. It should be 50 per cent sand and pebbles and 50 per cent stones ranging from marble size up to the size of golf balls.
8. If the ground is soft enough or the snow hard enough to drive pickets in, all of the bottom lashings on the described walls or forms can be omitted.
9. No mention has been made of what could be built if lumber, saws, hammers, and nails were available. The walls and forms described can be built with the normal issue tent group stores.

#### **428. Conclusion**

Improvisation is most important. Unit instructors must adapt their instruction to the varying conditions and areas in which they have to operate.

**(429 to 499 inclusive: not allocated)**

## CHAPTER 5

### MOVEMENT

#### SECTION 1 - LAND NAVIGATION

##### 501. General

Map reading and navigation in winter follow the same principles as in summer. In cold weather operations, however, map reading and navigation are more difficult and men taking part in such operations must know how to overcome the additional difficulties and hazards. Being lost at 70° above zero may be serious; being lost at 30° below zero could be fatal.

##### 502. Navigation Problems

1. Long nights, fog, snowfall, blizzards, and drifting snow all will drastically limit visibility and, at times, an overcast sky and snow-covered ground will create a condition of visibility (white-out) which makes it difficult to recognize ground features.
2. Heavy snow may completely blot out tracks and trails, the outlines of small lakes and similar landmarks. Because the country looks different in winter, special attention must be paid to identifying landmarks, both on the ground and in air photos.
3. Lack of adequate large scale maps, especially in far northern regions, will increase the need for air photos.
4. Air photos taken in winter will be difficult to read because of the monotony of detail, absence of relief, contrasts and, in the more isolated areas, the absence of manmade works for use as reference points.
5. Magnetic disturbances may be encountered in northern regions which will make magnetic compass reading inaccurate.
6. Handling maps, compasses, and other navigation instruments with bare hands in low temperatures is difficult.

##### 503. Methods of Land Navigation

1. Methods of land navigation under winter conditions are the same as under temperate conditions. They are:
  - a. map reading;
  - b. map reading and compass combined-essential when there are few landmarks or when visibility is limited; and
  - c. dead reckoning used when there are no landmarks, or when landmarks are inadequate.



2. In the Canadian Arctic because the earth's magnetic lines of force are almost vertical to the surface, the horizontal component of our planet's magnetism is too weak to provide a reliable reading reference on a magnetic compass. Therefore the astro compass is used to calibrate the magnetic compass. The astro compass gives an accurate indication of true direction by sighting on the predicted position of a celestial body. The theory and uses of the astro compass are given in Annex C.

#### 504. Navigation By Dead Reckoning

1. Dead reckoning is finding where you are located by a continuous plotting of where you have been. More exactly, dead reckoning consists of plotting and recording a series of courses, each measured both as to distance and direction from a known starting point. Using this method a navigator can determine his position at any time, either by following his plot, or by comparing his actual position on the ground in relation to his plotted course, which he has previously worked out and recorded. The most important action in navigating by dead reckoning is to keep a log, a written record of the direction and distance of each course (see Figure 5-1).

DESCRIPTION		START POINT			DESTINATION			NAME	
GRID REFERENCE								DEPART AT	
								(TIME)	(DATE)
LEG NO	START POINT		BEARING		DISTANCE		TIME		ROUTE DESCRIPTION
	GRID REF	DESCRIPTION	GRID	MAG	METERS	PACES	ARRIVE	DEPART	
1	ESTIMATED								
1	ACTUAL								
2	ESTIMATED								
2	ACTUAL								
3	ESTIMATED								
3	ACTUAL								

Figure 5-1 Route Card or Log

Note: When this form is prepared prior to departure it is a ROUTE CARD (estimation). As the march proceeds it is completed by recording each bearing taken and distance covered as well as any changes to the original route necessitated by terrain difficulties or any activity by the enemy. It then becomes a LOG.

2. Equipment requirements are as follows:
  - a. Maps - for selecting the route and for plotting the actual route taken as the march progresses. (Air photographs, when available, are valuable aids).
  - b. Compass - for direction finding.
  - c. Protractor - for plotting direction and distance on the map and air photographs. Remember to convert magnetic to grid bearings.
  - d. Route Card - to outline the distance and direction of the proposed march.
  - e. Log - to record the distance and direction that you have covered. Any notebook can be used.
  - f. Pace Counter - for keeping track of the number of paces taken (see subpara c).
  - g. Cable - to measure distance (if pace counter not used).

## **505. Method of Dead Reckoning**

1. Knowing his starting point and destination, and having examined the map and/or air photos for the best route, the navigator makes out a route card. This describes each leg of the proposed route in terms of distance and direction (see Figure 5-1).
2. When the route card has been made out, the navigator is ready to begin. As the march proceeds, a careful record is kept of each bearing taken and the distance covered on each bearing. This record is the log. It is vital that the log be kept up to date. Memory is not good enough. **WRITTEN RECORD MUST BE KEPT.**
3. A navigator may not be able to follow his proposed route (the route card) because of some obstacle or change in the tactical situation. If this happens, adjustments are made in the route, using air photographs or maps as a guide, and are recorded in the log.
4. In summary, dead reckoning consists of.
  - a. selecting the route;
  - b. plotting it on a map or air photograph;
  - c. making out a route card;
  - d. maintaining a log on the march; and
  - e. adjusting the plot as required.

## **506. Distance Measuring**

1. Pacing. This is the simplest way of measuring distance and consists or-keeping track of the number of metres taken between any two points on a straight course. A record must be kept of the paces taken. There are many ways of doing this. Stones, matches, or other articles can be transferred from one pocket to another for every 100 metres travelled. Their total will represent the distance travelled in hundreds of metres. Another good method is to use a mechanical pace counter. Whichever method is used, remember you must know the length of your pace. This can be learned only by pacing a known or measured distance. When calculating your pace, you should select ground similar to the country over which you will be marching. The length of your pace will alter with varying conditions, such as listed below.

- a. Slopes. Going up a slope, the pace will shorten; going down, it will lengthen.



Figure 5-2 The Issued Pedometer

- b. Surfaces. Sand, gravel, mud, snow, and similar surface material tend to shorten the pace.
  - c. Wind. A headwind will reduce the pace; a strong tail-wind will increase it.
  - d. Clothing. Excess weight of clothing shortens the pace and the "type" of footwear affects the foothold and therefore the pace.
  - e. Stamina. Fatigue greatly influences the length of the pace. The pacer must always guard against a general tendency to overestimate the distance travelled.
2. Cable. A piece of cable of known length (for instance, 100 metres of signal cable) can be used to determine the distance travelled. Here is how it is done:
- a. A lead man marches off in the desired direction trailing the cable behind him until the man at the end of the cable signals to him with a jerk on the cable that he has gone 100 metres from the starting point. The lead man then places a marker on the spot and marches on again. The rear man follows, keeping the cable taut.
  - b. When the man at the end of the cable draws up to the first marker, he picks it up and signals for another marker to be dropped by the leadman. The second marker will, therefore, be 100 metres ahead of the first that is to say the length of the cable ahead.
  - c. This procedure is repeated again and again, with the lead man dropping the markers and the rear man picking them up each 100 metres. If nine markers are used, the lead man will have gone 1,000 metres when the rear man closes up to the last marker.

- d. At 1,000 metres the rear man will have all markers. The lead man will now wait for the rear man to close up with his and give him back his markers. Then the procedure is repeated all over again for another 1,000 metres, and so on, until the end of each leg is reached. The number of 1,000 metres marched is recorded each time the nine markers change hands.

## 507. Direction

1. The magnetic compass is the oldest and most common of all direction finding instruments. There are two general types of magnetic compasses; the liquid filled, and the dry card. In extreme cold liquid filled compasses may become sluggish. When available, dry card compasses should be used in extreme cold.

2. Aiming Marks. An aiming mark is a well-defined point used to maintain direction when travelling. (The wind may be used if it is steady and strong enough to be felt.) It is easier to take a bearing on an aiming mark with a compass, and then march on the aiming mark, than it is to refer continually to the compass.

a. By Day

- (1) Lone trees, mountains, or distant clouds near the horizon may be used as steering aids. Check cloud rate of movement with your compass every 10 to 15 minutes. The rate will normally be fairly steady.
- (2) A steady wind, if checked periodically by compass to make sure it has not changed direction, will help you to keep on course.

b. By Night

- (1) Often the only steering marks are stars. A star near the horizon, with a bearing within two degrees of your compass course, may be used. It will be good for up to 30 minutes when you are heading North, but only for 15 minutes when you are heading South. After these intervals choose another star.
- (2) In latitudes under 70 degrees, when travelling North, the pole star makes a good aiming point since its bearing is usually only about one degree from True North, and is never more than 2 1/2 degrees away from it. In higher latitudes the North Star is too high in the sky to indicate good direction.

## 508. Hints for the Navigator

1. Remember the object of navigation is not merely to get from "A" to "B" but to get there by the best possible route, in keeping with the tactical situation, and with the minimum of delay and fatigue.

## 2. **Direction Keeping**

- a. Keeping the compass warm will speed-up the taking of bearings.
- b. When no aiming marks exist to your front, march on a back bearing. Your aiming mark may be a natural feature to your rear or an artificial aiming mark left behind by you. If the only aiming mark available is poorly defined, keep your eyes on it constantly after taking your bearing so you will not lose it.
- c. Never take bearings in the vicinity of metallic objects since even small amounts of metal will affect your compass, eg, metal frames on glasses and rucksacks, small arms, etc.
- d. When visibility is poor, only close-in aiming marks will be seen. Under these conditions the navigator should try to pick up further aiming marks along the correct bearing as he approaches each one. This can only be done accurately when the route to each mark follows a straight line. Frequent compass checks should be made to ensure that the correct bearing is being maintained. The compass should be set for night marching.
- e. A steady unshifting wind will aid you in keeping direction.

## 3. **Distance Measurement**

- a. Pace counting is useful only if you know the length of your pace.
- b. Remember to convert paces to metres.
- c. Measuring distance by cable is more accurate than by pacing.

## 509. **Conclusion**

Unit instructors should summarize the main points stressing the difference in terrain and landmarks when they are covered by snow. Also stress the importance of accuracy and the necessity for being observant plus remembering the features of the country through which the men are passing.

## SECTION 2 - MARCH DISCIPLINE

### 510. General

1. March discipline is the observance of the drills and precautions taken before, during, and after a march to ensure that a body of troops arrive at a destination fully equipped, and capable of carrying out further operations. It involves adequate march control, care of equipment, obedience to march instructions, proper conduct and performance of duty, suitable formations, suitable rate of march, correct distances, and effective use of cover and concealment.
2. March discipline in winter is basically the same as march discipline in warm weather operations. However, severe cold and snow are factors which must be taken into consideration in the winter and march discipline must include drills and rules for overcoming these additional hazards.
3. March discipline is the responsibility of every officer, NCO, and man. It must be observed at all times so that you will arrive at your objective fighting fit. Without good march discipline this is not possible.

### 511. Before the March

1. Planning
  - a. Before the march begins, the route should be planned in detail from route reconnaissance, maps, and air photographs. The easiest route, consistent with tactical demands, should be chosen. Obstacles such as open water, rocky or hilly terrain, soft snow, etc, should be avoided when possible.
  - b. Route cards should be completed before the march begins. The commander of the trail breaking party must be briefed thoroughly.
2. Briefing. Not only commanders and navigators, but all troops should know the route and a briefing should be held before the march. During the march the men should be kept informed of their progress, and, at each halt, should be told the distance yet to be marched and how long it will likely take plus any changes to the route that are necessary.
3. Dress
  - a. Dress should be detailed in the commander's orders. It should be as light as possible, consistent with the weather. Men should be allowed to decide upon the amount of underclothing to be worn as each man knows his own requirement for warmth and comfort.
  - b. Orders for the wearing of camouflage must be foreseen and detailed, although adjustments may be made from time to time during the march.
  - c. The choice of footwear will vary with the temperature. When the temperature is likely to go above the freezing point, a wet-cold boot should be worn in place of mukluks.

4. Ski Waxes. If used it is the responsibility of the commander to detail the type of ski wax to be used during the march. If the march is a long one, provision must be made for re-waxing during the march.
5. Inspection. Clothing and equipment will be inspected in sufficient time to allow for any necessary adjustment or re-loading. Particular attention will be paid to:
  - a. fit of rucksacks;
  - b. loading and lashing of toboggans;
  - c. proper waxing and fit of skis and bindings; and
  - d. weapons and equipment readily available.
6. Trail Breakers. This is a tiring job. Trail-breaking parties should be on the move ahead of the main body. Arrangements should be made beforehand for a system of reliefs.
7. Rations. Orders must include the amount of rations to be carried, both on the man and on the toboggans.
8. Protection. There is a great tendency in the cold to ignore normal precautions. This must be resisted. Protection on the move must not be forgotten, nor must protective measures slacken off while camp is being made or broken. Orders must be given for points, flank guards, etc, if the safety of the column is to be ensured.

## **512. During the March**

1. Halts
  - a. Ten to fifteen minutes after the march begins, a halt should be made so that equipment and clothing can be adjusted.
  - b. Subsequent halts should be taken frequently but should be short, merely long enough to allow a short rest and a change-over of duties but not long enough to get chilled. Two or three minutes in every fifteen or twenty may be used as a guide.
  - c. Halts should coincide with navigation checks, if possible, to reduce needless waiting about in the cold.
  - d. Do not sit or lie on the snow during halts but use snowshoes, mitts, or rucksacks, etc, as insulation from the snow.
2. Hot Drinks. These should be prepared before the march and carried in thermos bottles. You will be urged to drink them during halts. Thermos bottles should be shared and the contents of one finished before another is opened since the contents cools quickly once they have been partially used.
3. Stragglers. No straggling will be allowed and no one will be allowed to fall out of the column during a march. Stragglers may become cold casualties if separated from the main body.

4. Supervision. The second in command of sub-units and units will travel fit the rear of the column and will move forward along the column during halts to ensure that frostbite cheeks are being carried out. He will be responsible for the collecting and guiding of casualties and must also be prepared to navigate.

5. March Formations. These will vary and change with tactical demands. Normally, during approach marches, the best information to adopt is single file by sub-units since it maintains track discipline and camouflage, reduces the number of trail breakers and reconnaissance parties required, and makes toboggan pulling easier on a broken trail. On firmly packed snow where it is not necessary to break trail, you will probably travel in parallel columns since this is faster and gives the commander better control.

6. Security. Security instructions issued for a march will be rigidly adhered to. They will normally include:

- a. measures to cover the trail (eg, no litter);
- b. need for silence on the march;
- c. use of camouflage clothing; and
- d. track discipline, deception, etc.

7. Camouflage Clothing. Changes in camouflage clothing will be dictated by the type of terrain. Commanders must be constantly aware of this and will ensure that clothing is changed to conform to the surroundings.

8. Frost-Bite Checks

- a. By Day. Frost-bite cheeks will be carried out during the march and at halts. The best method for checking is to pair of using the "buddy" system. This makes each man responsible for checking his buddy from time to time during the march and at halts.
- b. By Night. To carry out frost-bite checks at night the commander of a unit or sub-unit must take into consideration the tactical situation, weather conditions, need of light discipline, need to preserve a unit's or sub-unit's night vision, etc. Therefore, frost-bite checks during the hours of darkness will more than likely become an individual responsibility.

9. Windbreaks. During short halts the rucksack may be used as a windbreak. During long halts windbreaks of snow blocks, trees, etc, should be constructed.

### **513. End of March.**

When the march is completed and the destination reached, march discipline must continue. Security must be maintained and track discipline rigidly enforced. Commanders will check all sub-units to ensure that men who require medical care get it as quickly as possible.



#### **514. Conclusion**

Unit instructors should summarize main points emphasizing that, although travel on the trail in cold weather is necessarily slower and more difficult, by following good march discipline, it can be carried out in good order without mishap.

## SECTION 3 - TRAIL-BREAKING

### 515. General

1. The purpose of trail breaking is to make the march of the main body as easy and as fast as possible. Trail-breaking, at the best of times, is a difficult and time consuming task.
2. The progress of the trail-breaking party is dependent on:
  - a. terrain;
  - b. weather;
  - c. snow conditions;
  - d. vegetation;
  - e. physical condition of the trail-breaking party; and
  - f. tactical situation; plans must be carefully made and the trail-breaking party well organized.
3. In addition to breaking a trail, the trail-breaking party will have two other tasks:
  - a. route selection; and
  - b. navigation.

### 516. Planning

1. The commander responsible for trail breaking will select the most suitable route, based on the following factors:
  - a. tactical situation;
  - b. terrain;
  - c. snow and weather conditions; and
  - d. type of equipment moving with the main body.
2. Route selection, whenever possible, will be made from reconnaissance, maps, and air photographs.
3. Based on the above considerations, the commander will make out a route card (see Figure 5-1). He will provide each of his navigators with a copy of the route card and brief them thoroughly.
4. The factors outlined in subpara I will determine the number of trails to be broken and whether separate routes must be selected for vehicles and skiers/snowshoers.
5. The trail-breaking group must be dispatched well in advance of the move of the main body. Their rate of march will depend on terrain, snow conditions, difficulty or ease of navigation, number of trails to be broken, amount of improvement which must be made to the trail, etc. No general rule of thumb can be given for the time of their dispatch. The unit

commander must assess the difficulty of the task and the capability of his trail-breaking group in order to determine how far in advance he must dispatch the trail breakers. They must be within radio communication distance.

### **517. Navigation**

See Sect 1, Land Navigation by Dead Reckoning.

### **518. Route Selection**

1. General. The route, in the form of a route card, will have been given to the trail breakers. However, the detailed selection of the route is their responsibility. The following paragraphs discuss some of the considerations for the detailed selection of a route.

2. Open Terrain. Normally, only one track will be broken when crossing open ground. This will usually follow beside the tree line. If, however, more than one track has been ordered, they will be widely dispersed (a minimum of 100 yards between tracks) and will follow natural terrain features. In some instances, eg speed is essential and the open terrain is extensive, oversnow vehicles may be used to break the trail. In this case the trail-breaking party will ski-jore behind the vehicles.

3. Close Terrain. The trail should not lead through dense forest as this will usually impose an unacceptable delay on the trail-breaking party. Whenever possible the trail should be broken at the edge of the wooded areas or through the dense portions. This will mean deviating from the route given on the route card but will save time. Multiple tracks will usually be no more than 25 to 50 yards apart. Any turns in the track will have to be quite wide if the main body is pulling toboggans.

4. Mountainous Terrain. If possible, the trail should be broken along the valleys, preferably on frozen rivers or streams. If it is necessary to travel on the mountain slope, gentle traverses should be used to climb or descend. A very careful study of the map and terrain should be made so as to select the slope with the least number of re-entrants. Once the trail has reached the desired altitude, every effort should be made to follow the contour of the slope.

5. Water Routes. Frozen lakes, rivers, and streams offer the most suitable routes for trails. However, before they are used, the thickness of the ice must be tested as well as a test made to determine whether there is water on top of the ice (see Appendix 1, Annex B). If this condition exists, either the water route must be abandoned or snow piled so as to form a raised trail. (The water will cause ice to form on the bottoms of toboggans and skis, restricting movement). To gain the maximum protection and concealment, the trail should be broken very close to the shore or bank.

6. Obstacles. Even very minor obstacles impede the progress of the main body, in particular when pulling toboggans. If possible they should be by-passed. Should larger obstacles, eg a steep hill, ridge, or steep river bank be encountered, many trails should be broken across it in order to

allow the main body to cross the obstacle on a wide front. Brush should be cut below the level of the ski/snowshoe track, to avoid it becoming entangled in bindings and tow ropes.

7. Snow Conditions. In early winter there is more snow in open areas than in dense forests; in late winter the reverse is true. In early spring the most snow is found in ditches, ravines, and the lee side of hills.

8. Night Marches. Skiing or snowshoeing at night is very slow and exhausting. The trail for a night march must be broken over the easiest possible terrain. Navigation is particularly difficult, therefore, the fullest advantage must be taken of every navigational aid such as streams, ridge lines, and the edges of woods. A trail broken for night marching will be much longer than one broken for a day march. Dependent on weather, a guide must be left at any point where the main body could take the wrong course.

9. Enemy. When marching in forward areas, the trail will normally be broken where the terrain affords the best concealment and less emphasis will be placed on ease of movement. It will often be necessary for the trail-breaking party to send detachments to clear terrain features near the trail. In some instances, these detachments may have to remain on these terrain features until the main body has passed in order to provide security. These security forces will then fall in the line of march at the rear of the main body. In some instances it may be desirable to create numerous false trails, crisscrossing and angling off in different directions in an effort to deceive the enemy.

## **519. Composition**

1. The trail-breaking group will normally consist of approximately one-quarter of the force making the march. Thus, for a battalion move, one rifle company would be given the task of breaking trail. The lead platoon of this company is designated as the trail-breaking party.

2. Depending on terrain conditions, one or two over snow vehicles should be allotted to the trail-breaking company. These vehicles are used for breaking trails in open terrain, ski-joring, and carrying the trail-breaking party's equipment. The vehicles may remain under higher echelon control when unfavourable terrain conditions exist.

3. The rifle company assigned the task of trail breaking will normally retain this task for a complete day. The trail-breaking party can be expected to break trail for approximately half a day. Sections within the trail-breaking party must be rotated as frequently as is necessary to maintain the speed necessary to complete the march in the time allotted.

4. The trail-breaking company should be mounted on skis if the main body is so mounted; and on snowshoes if the main body is snowshoeing.

## 520. Organization

1. The trail-breaking party will retain its rifle platoon organization. If only one trail is to be broken, one section will break trail with the others rotating as the lead section tires. If more than one trail is to be broken, a section will be used to break each trail (see Figures 5-3 and 5-4).

TASK	EQUIPMENT
Breaker	Axe or machete
Straightener	Axe or machete, wire cutters
Section Commander	Compass, map, route card
Right Cutter	Axe or machete
Left Cutter	Axe or machete
Packer	Shovel
Packer	Shovel
Packer	Shovel, trail marking material

Figure 5-3 Organization of Trail-breaking Section

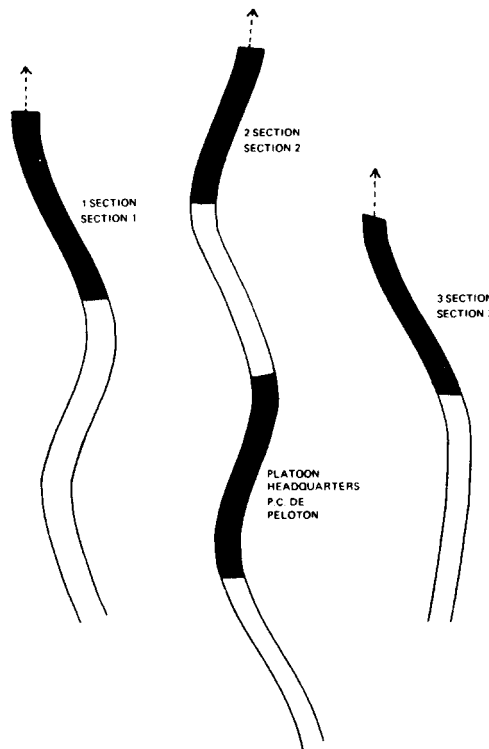

Figure 5-4 Breaking A Multiple Trail

2. The trail-breaking section will be organized as follows:
  - a. Breaker. Breaks the trail in the direction indicated by the section commander. He will not attempt to travel in a direct line to his objective, but will take the easiest route.

- b. Straightener. Straightens curves and improves the direction of the trail. He will rotate frequently with the breaker.
  - c. Section Commander. Selects the route, navigates, and rotates the teams.
  - d. Right Cutter. Cuts obstructions from the right side of the trail.
  - e. Left Cutter. Cuts obstructions from the left side of the trail.
  - f. Trail Packers. The remainder of the section improves the trail by filling small depressions and ditches, improving small gradients, marking the trail, etc.
3. When the section commander rotates the duties within the section, it will be done as follows:
- a. Breaker and straightener become packers.
  - b. Right and left cutters move forward and become breaker and straightener.
  - c. Two of the packers move forward and become right and left cutters.
  - d. Each team leaves its tools beside the trail before moving forward to assume their new duties. The new team picks up these tools as they arrive at their new task.
4. If the trail is being broken with skis, a triple track will usually be necessary as a normal ski track is not wide enough for toboggans. If this is necessary, it will be done as follows:
- a. The breaker breaks a trail with his skis approximately one foot apart.
  - b. The straightener and section commander ski in his tracks.
  - c. The right cutter places his left ski in the right track and breaks a new track with his right ski.
  - d. Thereafter, men alternate skiing in the right and left tracks (see Figure 5-5).

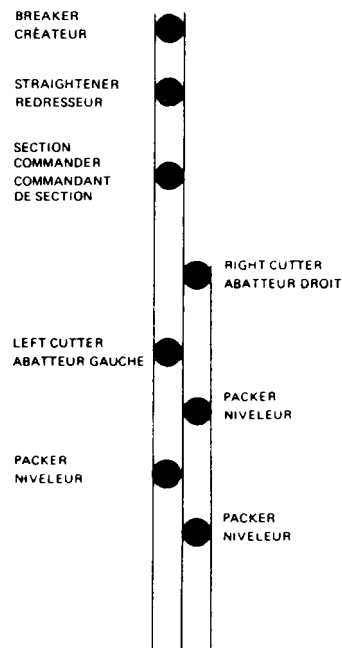

Figure 5-5 Breaking a Triple Track

## **521. Trail Marking**

1. If the trail being broken leads over existing trails or is to be used over a period of time, it will often be necessary to mark it. Any of the following methods can be used. The method used must be known to the main body before marking:

- a. branches of trees and shrubs broken in a predetermined manner;
- b. sticks or guiding arrows planted in the snow;
- c. markers made of rags or coloured paper tied to trees; or
- d. rock cairns or small piles of brush.

2. If the trail is to be used over a long period of time, permanent markers tied to the branches of trees should be used as the other types will be covered by fresh falls of snow.

## **522. Conclusion**

An experienced trail-breaking party can ease the movement of the main body so that they can arrive quickly and in good condition at their main objective. In addition, they provide a measure of frontal security to the main body.

**(523: not allocated)**

## SECTION 4 - SKIING AND SNOWSHOEING

### 524. General

1. Cross-country mobility is seriously reduced in snow covered areas. Skiing and snowshoeing are two methods of restoring mobility. By using snowshoes, individual mobility is restored to a point approximately equal to foot movement on hard ground. Well trained troops on skis will be more mobile than troops moving on hard ground.
2. During cross-country marches and while fighting, the soldier will have to move over various types of terrain and under different weather and snow conditions. He will usually be carrying heavy loads and often be pulling toboggans. In order to accomplish his mission without becoming completely exhausted, he must know and be able to apply the techniques of skiing and snowshoeing required for the varying conditions he may meet.
3. There will be opportunities where mobility can be increased even further by using oversnow vehicles, either to lift small bodies of troops or to tow skiers. These opportunities will be limited by the terrain and availability of over-snow vehicles.

### 525. Characteristics of Snow

1. Newly fallen snow undergoes many alterations on the ground. As the snow on the ground becomes denser, the snow flakes consolidate and the trapped air is expelled. These changes are effected primarily by the conditions of temperature, sunlight, and wind which prevail.
  - a. Temperature. In general, the lower the temperature, the drier the snow and the less consolidation. As the temperature rises the snow will compact more readily. If the temperature rises above freezing, wet snow conditions will prevail. Low night temperatures will cause wet snow to form a hard crust.
  - b. Sunlight. In the spring, sunlight may melt the surface of the snow even though the air temperature is below freezing. This will usually cause dry, powder snow in shaded areas and wet snow in sunny areas. Low night temperatures will cause the wet snow to form a crust.
  - c. Wind. Wind drifts and packs snow. The more constant the wind is, the harder the snow will be packed. Skiing, snowshoeing, or even walking will usually make no impression on its surface. Alterations in below freezing temperatures and warm winds will cause an ice crust to form. Movement under these conditions is difficult. Loose snow will drift in the wind causing a wavy surface.
2. There are three main characteristics of snow that are of interest to the soldier:
  - a. Carrying Capacity. The harder the snow has been packed, the greater weight per square inch it will support and movement will be easier. An ice crust may have a good carrying capacity but movement will be difficult because of the slippery surface.



- b. Sliding Characteristics. This is of great importance when moving on skis. Generally, dry snow, packed snow, and crusted snow provide the better sliding characteristics, and wet snow, falling snow, and newly fallen snow provide the poorer sliding characteristics. Great attention must be paid to the selection of the proper ski waxes.
  - c. Holding Capacity. This is of interest only to ski troops. Snow is able to act upon ski wax in such a way that back-slipping is prevented without impairing the sliding quality of the skis. This will vary greatly with each different snow condition. Great care must be paid to the selection of the proper ski wax as any amount of back-slipping will tire skiers quickly.
3. Snow is classified into four main categories:
- a. Wet Snow. This usually occurs in the spring but may be found, occasionally, in early autumn or late winter. It can be made readily into a solid, heavy snowball.
  - b. Moist Snow. Usually found in early winter, but may occur in mid-winter during warm periods. It can be made into a snowball, but has a tendency to fall apart.
  - c. Dry Snow. Generally found in mid-winter, but can occur at any time during periods of low temperature. It may be packed from the action of the wind, or powdery. At very low temperatures, this snow will be like sand and will have poor sliding qualities.
  - d. New Snow. It may be wet, moist, or dry.



Figure 5-6 Ski and Touring Pole



Figure 5-7 Binding - Ski - Universal

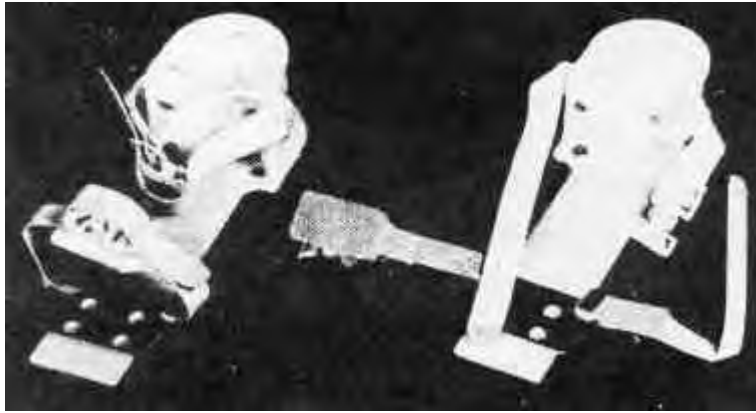

Figure 5-7A Ski Binding

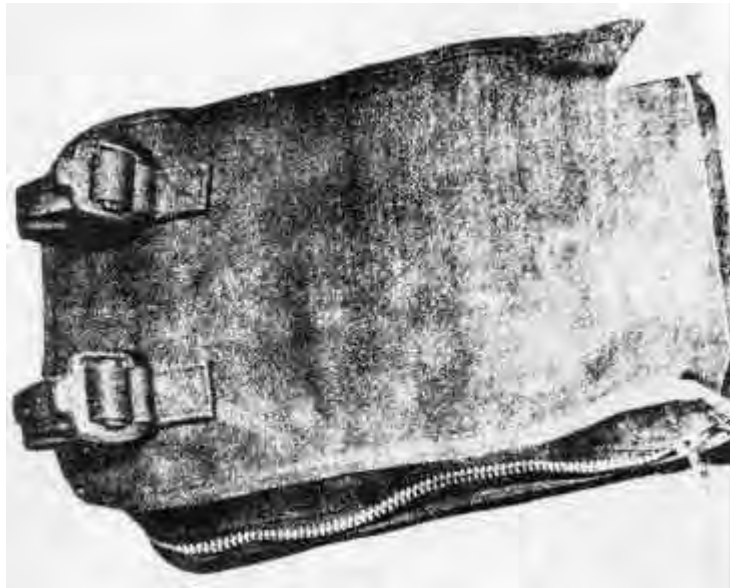
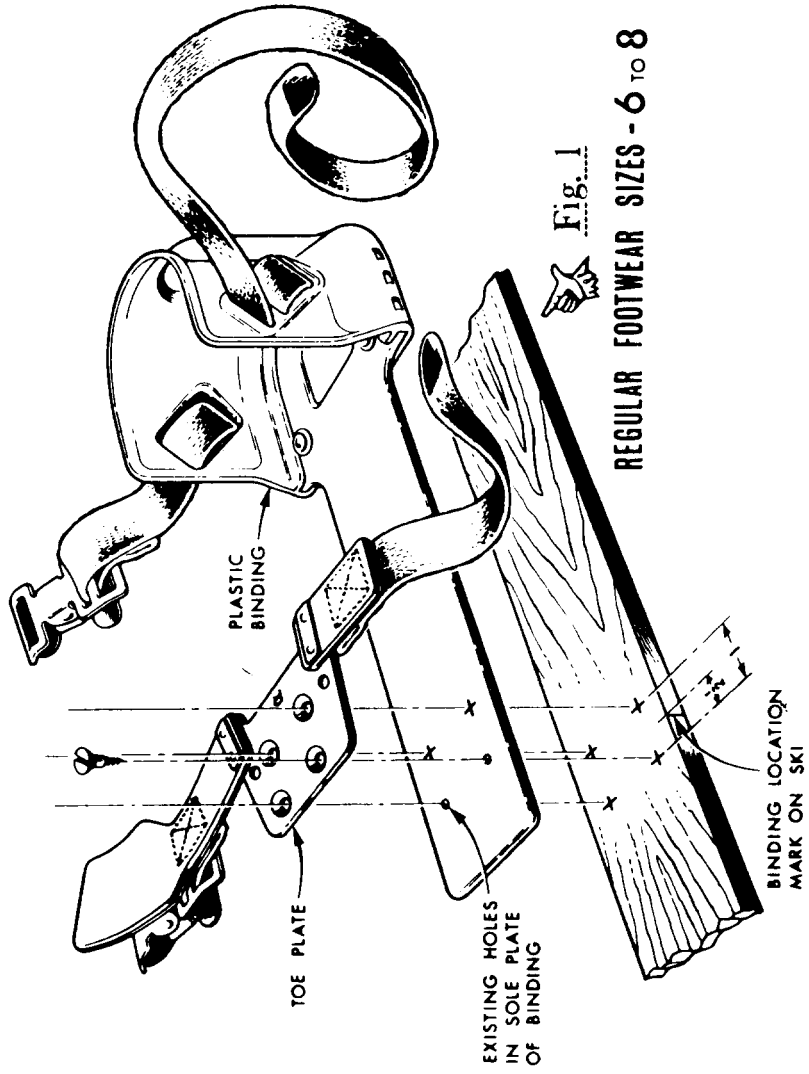

Figure 5-8 Repair Kit - Ski



Figure 5-8A Items of Ski Repair Kit



UNIVERSAL SKI BINDING: X69-1057

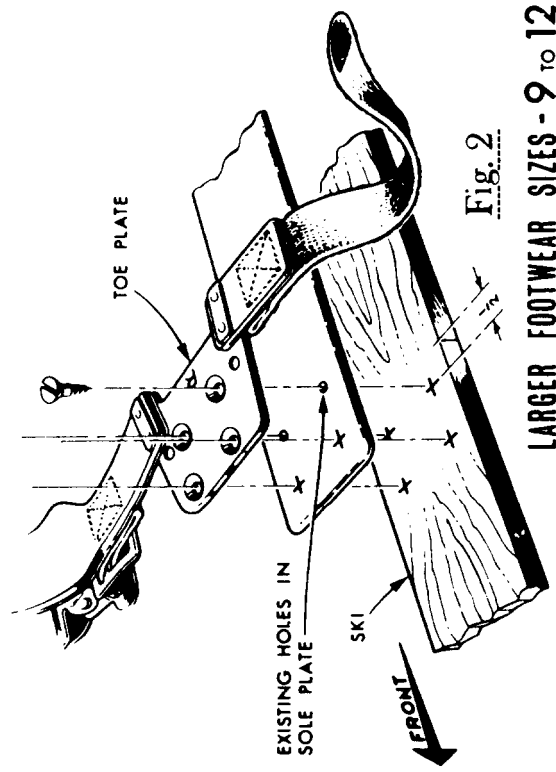

**HARNES**  
**INSTALLATION**  
 RIGHT HAND SHOWN, LEFT OPPOSITE

Figure 5-7B Ski binding – Mounting Instructions

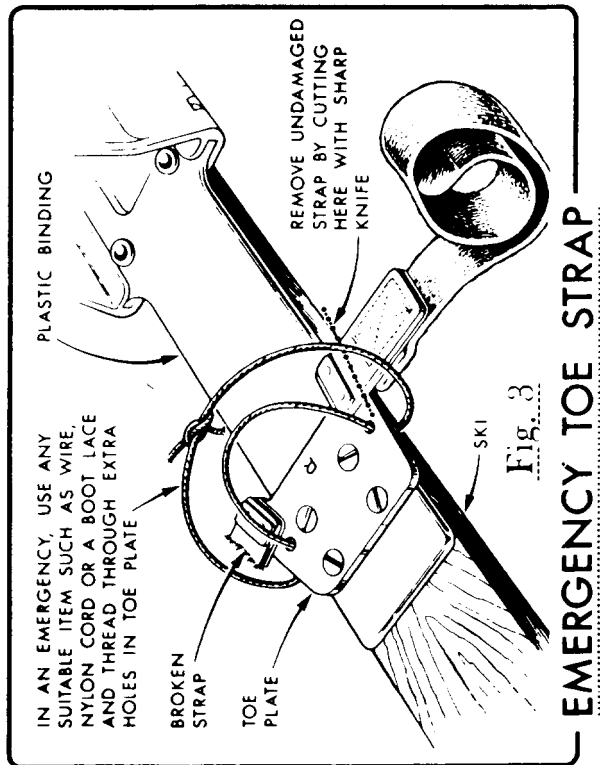

## MOUNTING INSTRUCTIONS •••

1. Toe plate and plastic binding to be placed on ski in position shown in Fig. 1 and Fig. 2, depending on the size of foot-wear.
2. With the toe plate and sole plate of the binding securely clamped in the proper position and location, drill four holes, using a No. 30 (.128) drill and the toe plate as a template. Holes to be drilled through the sole plate and into the ski itself to a depth of 5/8 inch exactly.
3. With ski, binding and toes plates still held together, insert screws (4) to full depth. A small smear of grease on screws will assist in this operation.
4. Skis previously having Balata or other bindings should be checked to determine if the holes in the new toe plate and the old screw holes coincide. If so, insert the new screws with the new binding. If not, plug the non aligning holes with a waterproof wood filler and drill the new holes as above. Care should be taken to ensure that no holes come closer together than 1/2 inch.

NOTE

If the binding location point is not marked on the skis this may be determined by measuring 40-1/2 inches from back end of ski. This note applies to 7-foot length skis only.

5. See Fig. 3 for Emergency Toe Strap.

NOTE

If the binding location point is not marked on the skis this may be determined by measuring 40-1/2 inches from back end of ski. This note applies to 7-foot length skis only.

5. See Fig. 3 for Emergency Toe Strap.

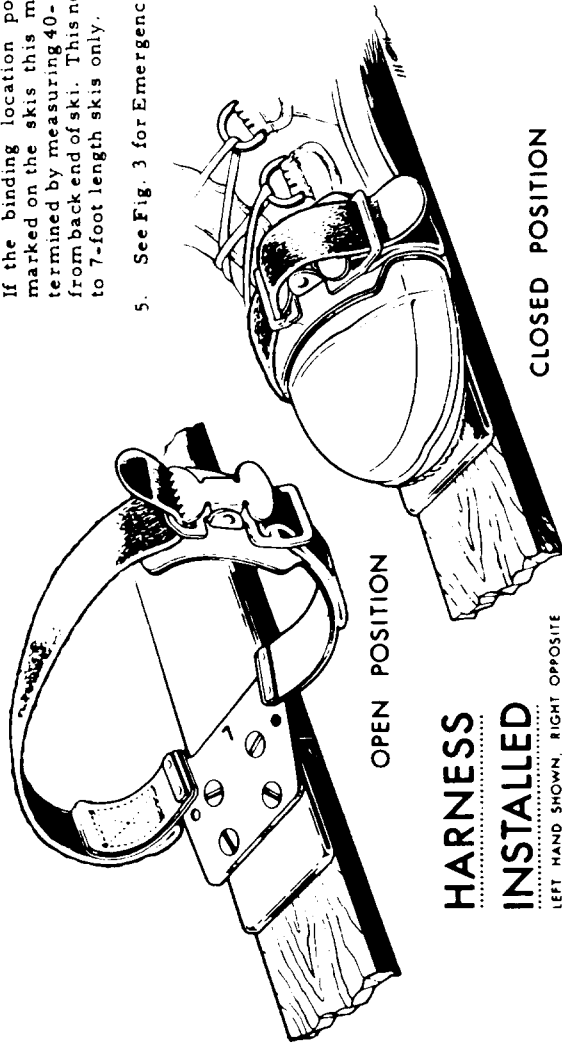

Figure 5-7B Ski Binding - Mounting Instructions

## 526. Ski Techniques

For most beginners, movement on skis is difficult because of lack of the proper balance and co-ordination. To overcome this difficulty, the initial lessons should be taught on level ground without using ski poles.

## 527. Walking Step

1. The walking step is the basic step used in all forward motion. It is used whenever walking or climbing is necessary. As the beginner gains proficiency, this step will be developed into the lunge.

### 2. Technique

- a. Begin with the skis parallel and body weight equally distributed on both skis. To take a step with the left foot, transfer the weight to the right ski; bend both knees slightly and slide the left ski forward, the length of a normal walking pace. Shift the weight onto the left ski; straighten the knees and raise the right heel. Keep the weight on the left ski and advance the right ski in the same manner and repeat at a walking pace.
- b. As proficiency is gained in transferring body weight, balance, timing, and control of the skis, the student begins to glide at the end of each pace. This will then develop into the lunge.
- c. To do the walking step with ski poles, place the right pole beside the right ski and approximately even with the left toe as the pace with the left foot is completed. A push to the rear with the pole will assist forward motion. Repeat with the left pole as the right ski is advanced.

## 528. Step Turn

1. The step turn is the simplest method of changing direction from a stationary position. It is of particular value in brush and other confined areas (see Figures 5-9 and 5-10).

2. **Technique.** Begin with the skis parallel and weight equally distributed on both skis. To turn to the right, transfer the weight to the left ski; using the heel as a pivot, place the right ski in the direction you wish to turn; transfer the weight to the right ski and place the left one parallel to it. To turn to the left, reverse the procedure. This turn can also be done using the toe as a pivot.

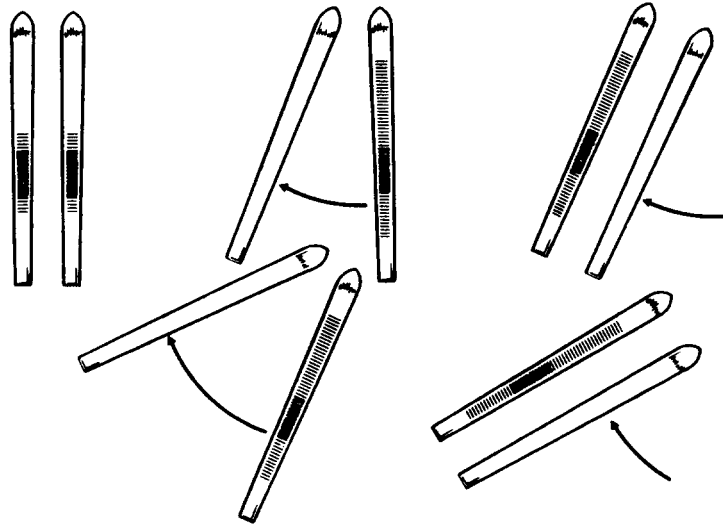

Figure 5-9 Step Turn Using the Tips as a Pivot

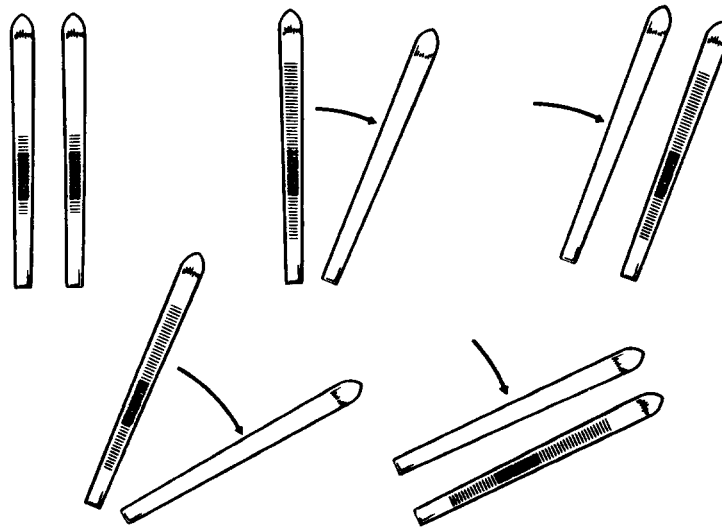

Figure 5-10 Step Turn Using the Heels as a Pivot

Note: Shaded areas in all diagrams indicate location and proportion of body weight.

## 529. Kick Turn

1. The kick turn is the quickest method of reversing direction while stationary; it can be used on flat ground and on steep slopes (see Figure 5-11).

### 2. Technique

- a. Begin with the skis parallel and the weight equally distributed on both skis. To turn to the right, place the left ski pole beside the left ski and approximately 24



inches in front of the left foot; place the right ski pole beside the left foot; transfer the weight to the left ski; slide the right ski slightly to the rear then kick it forward and up so that it is perpendicular, with its heel alongside the tip of the left ski; pivot the right ski on its heel and lower it so that it points in the opposite direction to, and parallel with, the left ski; bring the left ski and pole around and place it parallel with the right. To turn to the left, reverse the procedure.

- b. When doing the kick turn on a slope, ensure that the skis are placed horizontally with the slope before attempting to turn. The downhill ski should be turned first on steeper slopes.

### **530. Falling and Recovery**

1. Controlled Falls. This is a deliberate fall used when adopting a firing position, taking cover, avoiding hitting obstacles or avoiding excessive speed if no other method is practicable. It should be attempted only at slow to moderate speed; otherwise the individual is likely to be injured.

2. Unintentional Falls. Unintentional falls may cause injury and tend to tire troops unnecessarily as well as slowing the pace of the marching column. These falls are usually caused by poor skiing ability, snow conditions, skiing at night, excessive speeds, and loss of control.

3. Technique.

- a. If a fall is desirable or unavoidable, try to relax, lower the body by bending the knees and fall sideways and to the rear.
- b. Attempt to land on the hips or buttocks, with the body stretched to full length, ski poles pointing to the rear, and the skis kept close together.
- c. When falling on a slope, attempt to fall into the slope and not downhill.

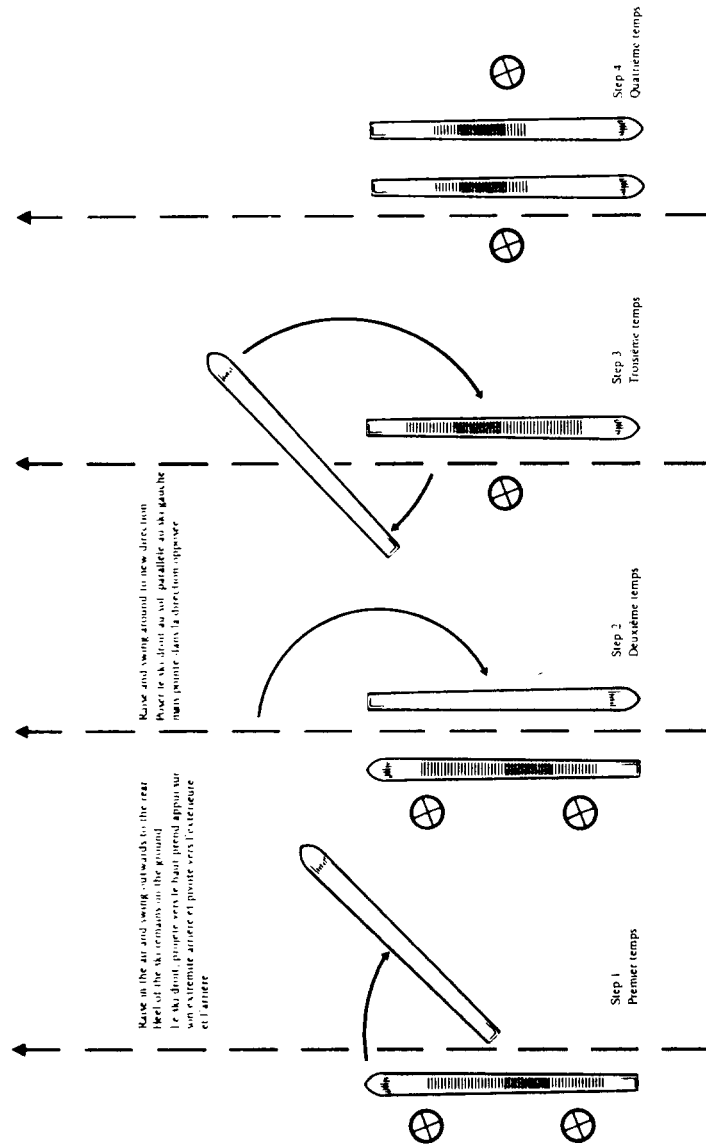

Figure 5-11 The Kick Turn

4. Recovery

- Before attempting to rise, take stock of the situation and plan how to get back on your feet.
- Remove the rucksack or any other restrictive load.
- Untangle your skis and bring them together and parallel. If on a slope, place the skis across the slope and on the downhill side of your body.
- Bring the skis close to the body by bending the knees, move your body forward and raise it, pushing with the poles if necessary.
- To use the poles, remove the hands from the straps, place the poles together with the baskets in the snow slightly to the rear; place one hand near the baskets with the other at the handles and push yourself up.

### **531. One Step**

1. The one step is a progression from the walking step and is a combination of the lunge and the walking step. It is the most widely used of all the skiing steps. It is used mainly on level ground but can be used when skiing slightly uphill or into the wind.
2. Technique. The one step is made in the same manner as the walking step, except that the rear leg is straightened with a Springing or lunging motion. This gives added speed and distance to the glide.

### **532. Variations**

1. It will become quite tiring to use the same step while skiing over long distances. By using some of the following variations, the skier can rest some of the muscles in his body while continuing to ski:
  - a. Two Step. This is a combination of an accelerated walking step and a one step. A walking step is taken with either ski; on completion, a lunge is made from the same ski. This has the advantage of always lunging from the same leg thereby resting the other.
  - b. Three Step. Made in the same manner as the two step except that two walking steps are taken before lunging. In the three step, lunges are made from alternate feet.
  - c. Double Poling. Used to rest the legs when sliding conditions are good or when skiing down slight gradients. To double pole, place both poles approximately even with the toe of the boot, bend the knees and push to the rear with the poles, straighten in the knees at the same time.

### **533. Step Turn in Motion**

1. A step in motion is a slow speed turn which can be used in all snow and terrain conditions. It is particularly useful under adverse snow conditions and in confined areas.
2. Technique
  - a. To turn to the right, place the weight on the left ski and edge it slightly to the right; raise the right ski and place it on the snow pointing in the new direction; quickly transfer the weight to the right ski; raise the left ski and place it on the snow beside the right one.
  - b. The steps can be continued until the desired direction is achieved. No individual step should constitute too great a turn.
  - c. Skating Turn. A variation of the basic step turn which can be made at greater speeds. The technique is the same except that a lunge is made from the weighted ski, into the direction of the turn.

## 534. Climbing

### 1. Walking Step

- a. Used on gentle slopes and on steeper slopes when the holding quality of the snow is good. It is the fastest and least tiring of the climbing methods.
- b. Technique. Lean the body forward and keep the knees well bent. On gentle slopes, slide the skis forward; on steeper slopes, a complete transfer of body weight will be necessary, therefore, the skis will have to be raised and placed in the snow. Use the ski poles as an aid to minimize backslip.

### 2. Sidestep

- a. Used on short, steep slopes also useful for stepping over low obstacles, such as logs, fences, etc.
- b. Technique. The skis are placed close together and horizontally across the slope; the uphill edges of both skis are edged into the slope; weight on the downhill ski; the uphill ski and pole are lifted directly up the slope; weight is transferred to the uphill ski; downhill ski is brought beside the uphill ski and the weight is transferred to it; repeat until the desired elevation is reached.
- c. On longer slopes it may be desirable to turn so as to rest the previous uphill leg. To do so use the kick turn.

### 3. Herringbone

- a. Used to climb short, moderate or steep slopes. It is quicker than the sidestep, but more tiring. It is difficult to use in confined areas (see Figure 5-12).
- b. Technique. Face directly uphill with the skis spread to form a broad "V"; edge the skis inwards and bend the knees inwards and forward; place the weight on one ski; raise the other ski and advance it one walking step; transfer the weight to the uphill ski; move the downhill ski in the same manner and place it slightly ahead of the first ski; use the ski poles in the same manner as in the walking step, but keep them to the rear of the body; repeat until the desired elevation is reached.

4. Half Herringbone. Done as for the herringbone, but one ski is slid to the front while the other is angled to the side (see Figure 5-13).

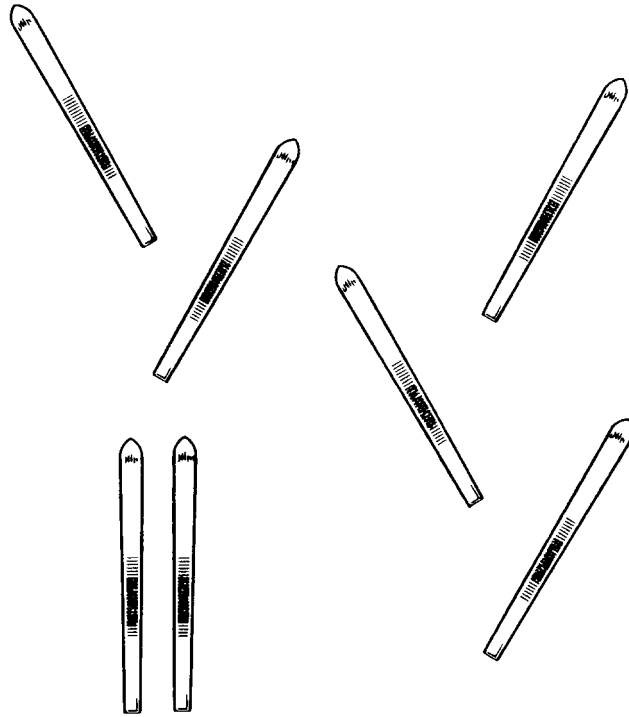

Figure 5-12 Herringbone

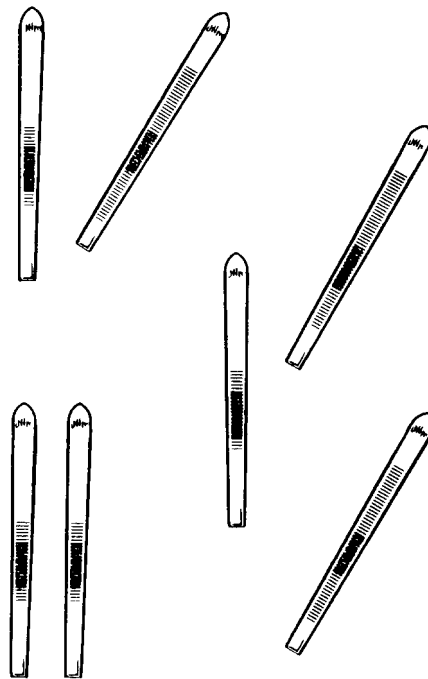

Figure 5-13 Half Herringbone

5. Herringbone Turn. Used to change direction while traversing to move into a herringbone climb from a traverse.

- a. Technique. Place the weight on the downhill ski; move the uphill ski in the desired direction, place the weight on the uphill ski; bring the downhill ski up into the herringbone position; repeat until the desired direction has been reached.

6. Traversing

- a. Traversing is climbing diagonally up a hill. The walking step, side step or half herringbone, may be used.
- b. Traversing is the longest route up a hill but, as it is the least tiring, should be used on all long and very steep slopes.

**535. Downhill Running**

1. Straight Downhill Running. The first technique learned is downhill running. It teaches the individual the balance and technique necessary before he can be taught more advanced methods of descent. As it is the fastest method of descending a slope, the beginner should be taught this skill on gentle, open slopes.

- a. Technique. Begin with skis flat and parallel; advance one ski a few inches; weight evenly distributed on both skis; knees bent and forward of the ankles; body leaning slightly forward but not bent from the waist; hold the ski poles pointing to the rear with the baskets above the snow. The body should be as relaxed as possible with the knees acting as shock absorbers. The ski poles are used where necessary to help maintain balance.

2. Traversing. The most commonly used method of descent. Not only does this method eliminate the need to ski over unfavourable terrain, but it also controls the speed of descent.

- a. Technique. The body position is similar to that used in straight downhill running except that it is always the uphill ski which is advanced with most of the weight placed on the downhill ski. Standing directly over the skis and not leaning into the slope will edge the skis sufficiently to avoid sideslipping on most slopes. Edging the skis should be controlled by using the knees.

**536. Braking Methods**

1. Ski Pole Riding

- a. This is an efficient braking method suitable for use in very confined areas.
- b. Technique. Remove the hands from the straps of the ski poles and place the poles together. For straight downhill running, place the poles between the legs with the baskets to the rear; grasp the poles near the handles and near the baskets; partially sit on the poles and with the rear hand, force the baskets into the snow. The amount of braking action depends on the weight applied to the baskets. For traversing downhill, grasp the poles near the handles and near the baskets holding

the poles on the uphill side of the body. Force the baskets into the snow with the rear hand.

2. Snowplow

- a. This is a method of controlling forward motion on all types of terrain. On gentle slopes, or on the level, it can be used for stopping (see Figure 5-14).
- b. Technique. From the straight downhill running position, push both heels outwards evenly, keeping the ski tips even and close together; weight is equally distributed on both skis; knees are bent forward and inwards. To increase the braking action, widen the "V" and edge the skis more. From a downhill traversing position, place the weight on the uphill ski; move the downhill ski into the snowplow position; transfer the weight to the downhill ski; move the uphill ski into the snowplow position; keep most of the weight on the downhill ski.

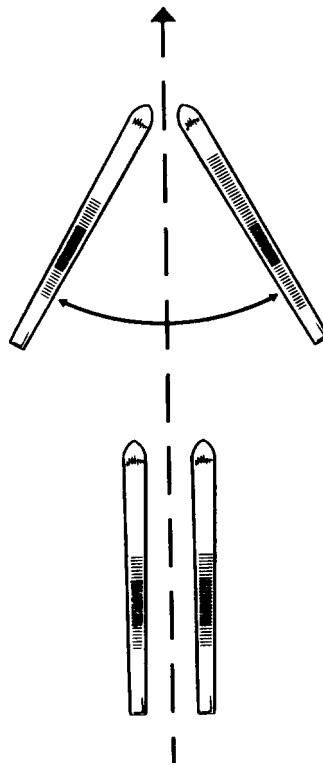

Figure 5-14 The Snowplow

3. Half Snowplow. This is used in confined areas and while traversing. Only the downhill ski is moved into the snowplow position. Braking action is controlled by the amount of weight placed on the downhill ski (see Figure 5-15).

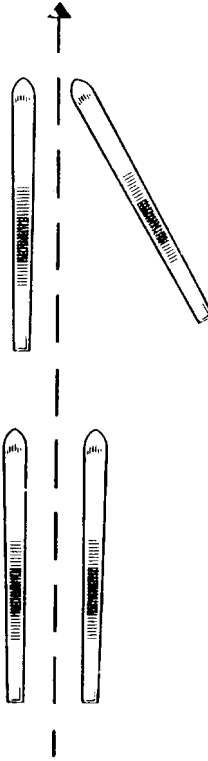

Figure 5-15 The Half Snowplow

4. Side-slipping

- a. As well as being a braking method, side-slipping is a basic movement in some of the more advanced turns.
- b. Technique. From the downhill traverse position, decrease the amount of edging of both skis. This will lessen the holding power of the skis and allow the skier to slide sideways down the slope. The weight should be centred on the skis. The downhill ski pole should not be placed in the snow during side-slipping. Shifting the weight forward of centre will cause the ski tips to side-slip faster; shifting the weight to the rear of centre will cause the heels of the skis to side-slip faster.

**537. Turns**

1. Snowplow Turn

- a. This slow speed turn is of particular value when skiing with rucksack and rifle. As the snowplow position is maintained throughout the turn, the individual is able to maintain good control. It is an excellent turn to use when changing direction during downhill traversing.
- b. Technique. To make a turn to the right while snowplowing straight down a slope, the weight is transferred onto, and over, the left ski by rotating the body and shoulder in that direction. This rotation of the body initiates the turning action. As



the turn progresses, the bend of the left knee is increased forward and the right knee is kept well bent with this ski flat and unweighted throughout the turn. On reaching the desired direction, resume the normal snowplow position. To make the turn from the downhill traversing position, adopt the snowplow position, then decrease the edging of the downhill ski and lean the body forward.

## 2. Stem Turn

- a. Although this turn is made at a faster speed than the snowplow turn, it is classed as a slow speed turn.
- b. Technique. Begin the turn as for the snowplow turn. As the skis cross the fall line, the speed of body rotation is increased and the upper body leaned out from the slope. The downhill knee is bent well forward and leaned into the slope. As the desired direction is reached, bring the body back to the downhill running position and bring the uphill ski parallel to the downhill one.

## 3. Stem Cristiania Turn

- a. This is a high speed turn which can be performed while skiing with a rucksack and rifle.
- b. Technique. Begin the turn as for the snowplow or stem -turns. The various body actions are the same as in the stem turn but, due to the much greater speed, must be executed more rapidly and with more force. The skis are brought parallel as, or just after, they have reached the fall line. The knees are now kept well bent and leaned toward the slope, thus edging the skis. A controlled skid results. As the desired direction is reached, resume the normal down hill traverse position.

## 538. **Skiing Over Variable Terrain**

### 1. Level Ground

- a. Particularly in forested areas, there are many places where the surface of the snow is uneven. A skier must learn to take advantage of this terrain as a relief and change. He must not let it slow down his movement.
- b. Technique. With small hummocks, the lunge is made from the bottom of the depression; the other ski is slid over the crest of the next hummock keeping the knee of the sliding leg well bent. As the lunge is made, the skier reaches with one ski pole over the next hummock so that an effective thrust can be made once he has slid onto the hummock, if the depression is deep (four feet or more), one ski is placed about two feet ahead of the other as he skis through the depression. Most of the weight is kept on the skier's rear foot, the body is straight. The knees are bent as you slide over each hummock and straightened while sliding through the depression.

## 2. Downhill

- a. Technique. The knees are kept bent and flexible so that they can move up and down in the manner of shock absorbers. Knees are bent at the crests of hummocks and the lips of depressions and are straightened while skiing in the hollows. One ski is kept well ahead (approximately two feet).

### **539. Ski-joring**

1. General. Special oversnow vehicles and through snow vehicles, full tracked, and wheeled vehicles, can be used for pulling skiers. The best routes for ski-joring are snow covered roads and trails, frozen lakes, rivers, or paths made by tracked vehicles. Speeds up to 15 miles per hour may be maintained on level ground by trained troops, depending on weather and trail conditions. Normally, one rifle section can be towed behind a light carrier and two sections behind a section carrier. Towing more than two sections by one vehicle is impractical due to the delay caused by the increased number of individuals falling.

2. Technique. Tow ropes, 120 feet in length, are used for pulling the squad. The skiers are in columns, and are on the outside of the tow rope. The normal towing configuration is two ropes, one following each track. Several methods of towing can be used according to the situation, the terrain, and the distance of movement. Each skier grasps a bight of rope and makes an eight to ten inch loop by tying an overhand knot. The loop is held with one hand and poles are held in the other. Another method is for each skier to form a long loop by tying an overhand knot in a five to six foot bight of rope. He leans against the loop after placing it around the buttocks. He does not place the body through the loop, but brings the entire bight around his body. Using the ski pole method, the skier rests both arms and body, and can arrive at the destination in better physical condition. Another advantage in this method is that a skier can easily exercise his hands to prevent frostbite during movement in extreme cold. When being towed through dense wooded areas, or when contact with the enemy is imminent, skiers may simply grasp the rope without tying the overhand knot or using ski poles as a rest. Thus, they can manoeuvre through narrow trails and are more ready for immediate contact with the enemy. No matter what method of towing is being used, individuals must never be allowed to fasten themselves to the tow rope. In case of a fall they must be able to release their hold immediately to avoid serious injury to themselves or other skiers. The ski poles are usually kept in the hand and available for instant use. During training and in a combat situation when contact with the enemy is not probable, the ski poles may be loaded on the vehicles to avoid accident.

3. Steep Slopes, Obstacles, and Sharp Turns. When these cannot be bypassed the speed must be reduced in order that the skiers can manoeuvre. One man, usually the assistant driver, is responsible for stopping or slowing the vehicle in order to prevent casualties because of speed or obstacles. When the vehicle begins its forward movement, each man on the rope should move forward under his own power for a few steps gradually placing tension on the towing rope to prevent being suddenly jerked into motion causing a fall. When underway the skier's body is leaned slightly backward, the knees are bent slightly, and the upper body is nearly straight. Skis may be farther apart than in normal skiing. One ski is kept slightly ahead. If a skier falls he should release the tow rope immediately. When approaching a sharp curve where the area for

movement is confined the vehicle should be slowed down or in some instances stopped. The skiers on the inside of the curve simultaneously move the rope overhead to the outside until the curve is negotiated. Failure to do this may result in being pulled off balance by the sudden change in direction as the vehicle completed the turn.

#### **540. Ski Drill**

1. Dismounted. All movements are done as in ordinary foot drill. The skis may be carried on the left shoulder or placed on the ground beside the soldier.
  - a. Skis on the Shoulder. Thread one ski through the harness of the other. Thread one ski pole through the basket of the other. Hook one of the baskets into the tip of one of the skis. Place the skis on the left shoulder with the tips pointing to the rear.
  - b. Skis on the Ground. Place the skis, on the running edges, beside the right foot; toe of the bindings in line with the toe of the foot. Lay the ski poles to the right of the skis, handles even with the toe of the bindings, and baskets to the rear.
  
2. Mounted on Skis
  - a. Attention. Skis are parallel and close together; the weight of the body evenly distributed on both skis; poles are held in the hand with the baskets on the snow even with the toes.
  - b. At Ease. Slide the left ski forward a half pace.
  - c. Stand Easy. Place the baskets of the poles approximately two feet behind the heels and relax.
  - d. Left and Right Turns. Turn by using the step turn, employing the tips of the skis as a pivot.
  - e. About Turns. Turn by using the kick turn.
  - f. Right Dress. Normal foot drill. Interval is 1 1/2 ski lengths behind the man in front; one arm and ski pole length from the man on the right.
  - g. Mount - Dismount Skis. From the position of attention, simply step into, or out of, the ski bindings and resume the position of attention.

#### **541. Snowshoeing**

Like skiing, snowshoeing is a method of retaining mobility in deep snow. Movement is not as fast on snowshoes as it is on skis. However, a soldier can become quite proficient with snowshoes in a few periods of instruction, whereas on skis he cannot. Snowshoes are of particular value in dense forest and around the bivouac area.

#### **542. Types**

1. Bearpaw. It is a short, oval shaped snowshoe. It is not in general use in the Canadian Forces.

2. Trail. Trail snowshoes consist of a magnesium alloy extruded frame with a mesh centre of galvanized aircraft cable covered with nylon. The ends of the mesh cable are fastened by means of a metal clip. Two cross-bars are welded to the frame to reinforce it. The frame is finished in a white baked enamel. Two sizes of cable are used in the snowshoe. The heavier is 3/32 inches in diameter and is used for the centre area. The lighter is 1/16 inches in diameter and is used for the toe and tail of the frame, see Figure 5-16.

#### **543. Maintenance**

1. Check the extrusion and mesh for breaks.
2. Check the frame for chipped paint and re-paint as required.

#### **544. Snowshoe Harness**

1. Figures 5-16 and 5-17 show the new type of snowshoe harness.
2. Figures 5-18 to 5-21 illustrate the manner in which it is attached to the snowshoe.
3. Figures 5-22 and 5-23 illustrate the manner in which the harness is attached to the boot.

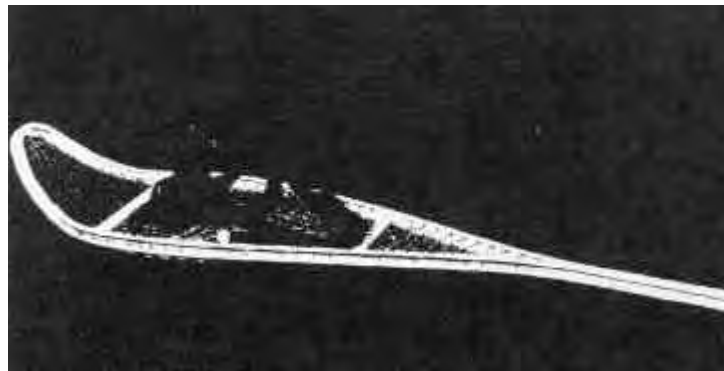

Figure 5-16 Trail Snowshoe



Figure 5-17 Snowshoe Harness

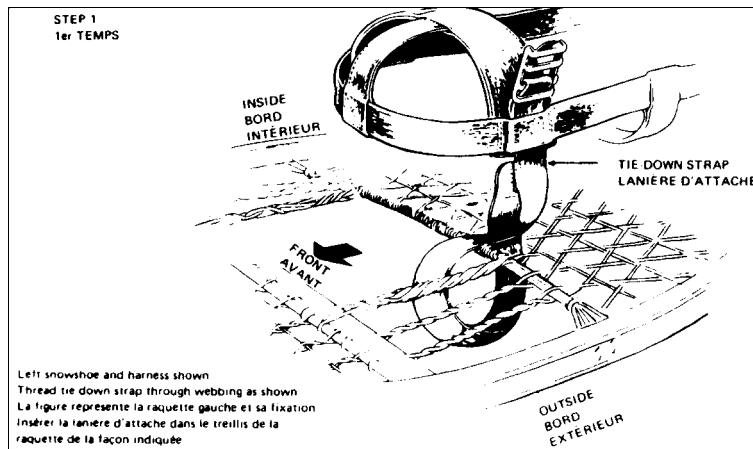

Figure 5-18 Attaching Harness to Snowshoe Step 1

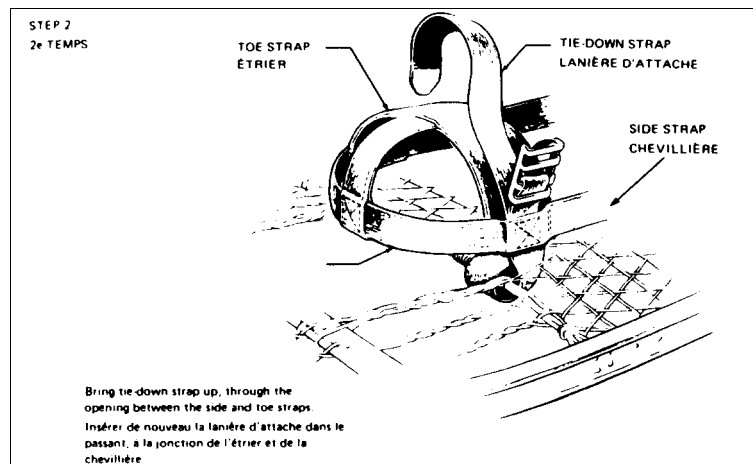

Figure 5-19 Attaching Harness to Snowshoe Step 2

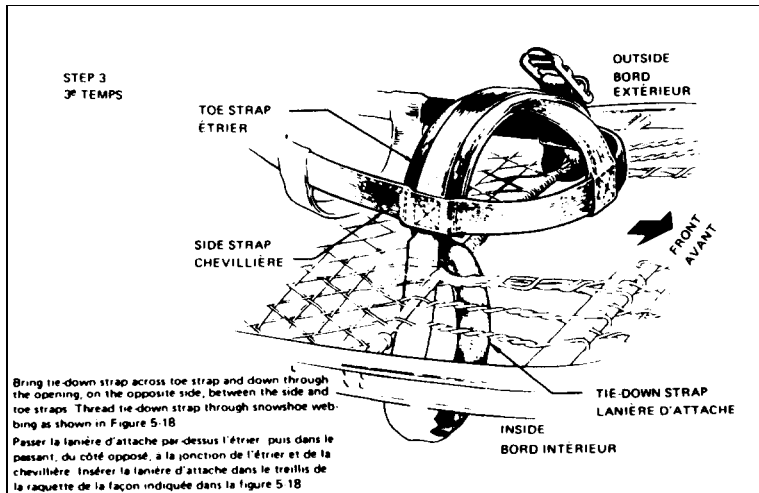

Figure 5-20 Attaching Harness to Snowshoe Step 3

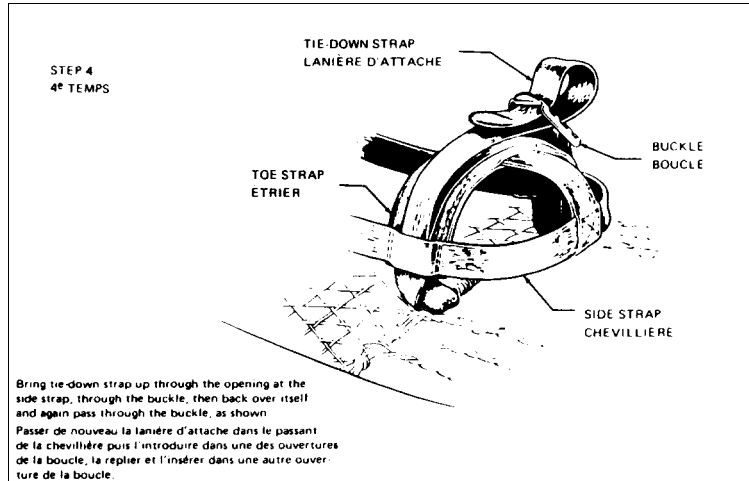

Figure 5-21 Attaching Harness to Snowshoe Step 4

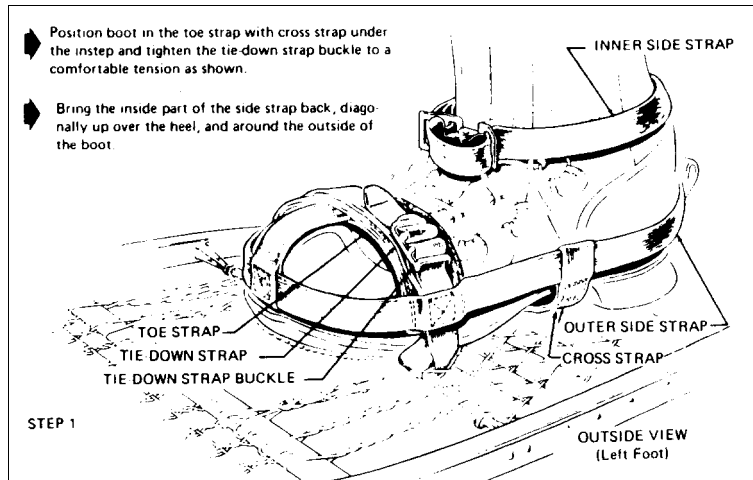

Figure 5-22 Attaching Harness to Boot Step 1

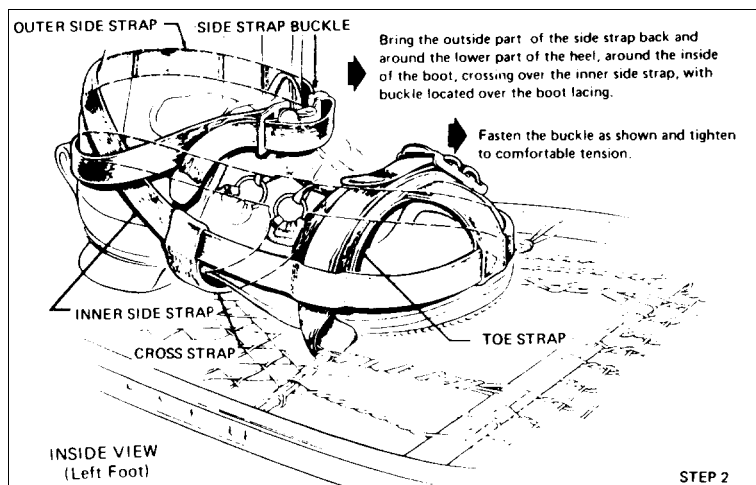

Figure 5-23 Attaching Harness to Boot Step 2

## 545. Training and Rate of Movement

1. Training. Although one can learn to snowshoe in a very short time, one has to keep in practice so that feet and muscles, not used in ordinary marching, become hardened. After a short period of instruction, conditioning marches over increasingly difficult ground with increasingly heavy loads will quickly give the skill and muscle hardening needed.

2. Rate of Movement. The rate of movement on snowshoes is about the same as the normal marching rate. However, the weight of the individual's load, the type of ground, and the type and depth of the snow will all have a bearing on speed of travel.

## 546. Showshoe Technique

1. General. There are a number of techniques to learn before one can say he knows how to snowshoe. Knowing the techniques is not enough, they must be practised.
2. Soft Snow. To save energy on long marches in soft snow, adopt a loose-limbed, rolling gait. Lift the snowshoes to clew the snow and thrust them forward to complete each pace. If a snowshoe catches in the snow, pull the foot back, lift it up and then continue the stride. This paragraph does not apply if additional weight, such as a packboard or rucksack, is carried.
3. Hard Snow. Use a shorter stride in hard or packed snow that gives good support. When marching on hard snow, the spring-like tension on the webbing is lost, and the "heel-and-toe" long stride is tiring on the knees. The quickest and least fatiguing method of travel, under these circumstances, is a loose-knee, short, rocking gait. This paragraph does not apply if additional weight, such as a pack-board or rucksack, is carried.
4. Obstacles. Never bridge two obstacles with snowshoes. Bogs and ditches, fallen trees, etc, may be jumped, but do not let the trails of the snowshoes fall downward. If the trail is vertical on landing, it will strike the snow surface first and may throw the user.
5. Kick Turn. Use a kick turn to turn on the trail. Lift the right leg, swing it back, and then kick it forward and upwards. At the top of the kick, just as the trailing edge of the snowshoe clears the snow, turn the foot outward. Continue to turn the foot as the leg is lowered until the foot faces the rear as it comes to rest on the snow. Shift the weight to the right foot and then raise the left foot. Bring it over the trailing edge of the right snowshoe, and face it in the direction of the right foot. The turn is complete. Follow the same drill, leading with the left foot, to make a turn to the left.
6. Rough Ground. The trail type snowshoe is better for marching in mountainous country where the snow is normally very deep and the ground uneven. In this type of going, the turned-up toe of the trail type snowshoe prevents the front from catching when descending the steeper slopes. When snowshoeing on steep slopes where the snow is soft and deep, make a trail across the slope by packing down the snow with the snowshoes to form a platform. If following this kind of trail, step lightly on the downhill snowshoe.

**(547 to 599 inclusive: not allocated)**



## CHAPTER 6

### TACTICS

#### SECTION 1 - GENERAL

##### 601. Introduction

This chapter deals with minor tactics under winter conditions with particular reference to the arctic and subarctic regions of North America and Northern Europe.

##### 602. Concept of Operations - Arctic

1. General. Operations in the arctic must be simple and highly mobile because of the vast distances, the low population density, and the hostile environment. The key to operations in the arctic is air mobility from strategic aircraft to helicopters and small fixed wing aircraft. The disadvantages in the use of most means of ground transportation are such as to give top priority both tactically and administratively to aerial movement. Aerial assaults either by air dropping or air landing men and equipment will be the norm.

2. Enemy. It is unlikely that in the foreseeable future that large scale sustained operations will be conducted in the Canadian Arctic. The threat is from commando type raids against specific targets with the aim of destruction and quick withdrawal.

##### 603. Concept of Operations - Subarctic

1. General. The subarctic is the home of most of the primary coniferous forest in North America and Eurasia, and man has exploited and developed this region far more than the arctic. Large scale and sustained military operations have taken place in the subarctic in all seasons in the past.

2. Mobility. The subarctic is dominated by forest, swamp, rivers, streams, and lakes. Normally, few roads are available and often operations will be based on only one road, which may not be all weather. In winter the keeping open of roads will be a major operation requiring large engineer resources. Great reliance must be placed on the use of all forms of air transport. Ground mobility in winter will be based on skis, snowshoes, and oversnow and throughsnow vehicles. Wheeled vehicles can be used when the resources are available to keep the roads open.

3. Tactics - General. The enemy, as well as us, will depend on the maintenance of his line of communication by road and air for the survival of his forward troops. The aim should be the interdiction by air and ground attack of his line of communication. Airborne capabilities should be fully exploited to achieve this aim. Frontal attacks are difficult to mount in deep snow and when possible should be avoided. Envelopment and infiltration across country using skis, snowshoes, oversnow vehicles, and helicopters are to be preferred. In essence superiority in battle will go to the force which is the least restricted to roads and is better trained to live and move lightly in the cold and snow.

## SECTION 2 - BASIC PLANNING AND OPERATIONS

### 604. Winter Problems

1. Tactical principles for winter operations are the same as those employed in more temperate zones. It must be appreciated, however, that some adjustments to standard operating procedures will be necessary. Three major problems that influence every phase of military operations in winter are:

- a. the cold;
- b. snow and ice;
- c. frozen ground.

2. The three factors in para 1 necessitate changing procedures in order that tactics will be as effective under winter conditions as they are under milder climates. In winter, the human element becomes all important, equipment and weapon effectiveness are reduced, mobility may be restricted, and momentum is difficult to achieve. These problems can be overcome by training and the application of the techniques for the various phases of operations. Remember these problems apply to the enemy as well as your own forces.

### 605. Standard of Training

1. Success in winter operations depends on the development of individual and sub-unit efficiency. Good leadership is essential at all levels. Leaders must be carefully selected for specific tasks. They, as well as all other personnel, must be trained to a high level of physical stamina. This coupled with mental conditioning will enable them to carry on for long periods of time under continuous adverse weather. Greater attention must be paid to detail and sub-unit morale.

2. Tactically, the main problem is to keep mobile and this must be stressed in all training. Adverse weather conditions, restricted visibility, and in many instances the difficulty of recognizing terrain features make training in map using and navigation of paramount importance. This aids in ensuring that all movement is efficient in the expenditure of time and effort.

### 606. Planning

1. Planning for winter operations does not differ from any other type, however, the restrictions imposed by extremes of climatical conditions constitute the major changes. These restrictions may, unless proper provisions are made, constitute major obstacles to the successful conduct of operations. The following special factors will influence operational planning.

- a. Logistics. Planning of any scope must emphasize the overall support problem. The lack of roads or snow clearance of existing roads, lack of shelter, plus climatic severity, and other environmental difficulties require that logistical plans be flexible and adaptable to permit adjustment of supply means without endangering the overall effort.

- b. Timings. Rates of advance and movement are slower and more time is required to accomplish simple tasks. Time is consumed in striking shelters and loading equipment which must be transported with, or by the troops. If vehicles are included, engine warm-up time is necessary. Trail breaking is also time consuming and frequent halts are necessary for rests, adjustment of equipment and loads, or frost-bite checks. The effects of sub-zero temperatures on men, equipment, and weapons increases the need for maintenance and slows up activities. All these factors must be taken into consideration in time and space calculations.
- c. Snow Cover. Snow, depending on type and depth, improves the movement of suitably equipped and well trained troops but reduces mobility of troops lacking proper equipment and training. It also reduces the effectiveness of exploding type of projectiles from support weapons.
- d. Lakes and Waterways. These may either aid or hinder operations depending upon ice thickness. For load-bearing capacities see Annex B.
- e. Weather. Sudden changes in weather are common. These include severe frosts, mild weather, snow storms, strong winds, and dense fogs. Accurate weather forecasts are essential to provide planning aspects to enable tactical advantages to be seized.
- f. Daylight and Darkness. The long winter nights must not be considered a bar to operations. For example, movement, camp building and breaking, scouting, and patrolling must be considered normal night activities. The proper use of available daylight hours assumes major importance in planning.
- g. Ice Fog. Ice fogs form when temperatures drop below -20'17 and the air is still. They are caused by the copious local production of water vapour given off by human activity, coupled with the inability of stagnant air at such low temperatures to hold water. Ice fog obscures the firer's vision along the line of fire and may disclose the location of weapons, troops, and vehicles.
- h. Forested Area. Forested areas offer concealment and present excellent opportunities for ambushes and hit and run tactics. They provide comparatively good protection against wind and snow storms but present a serious obstacle to cross-country mobility.

## **607. Fire Support**

Restricted mobility of heavier weapons and extended periods of low visibility may limit the availability of fire support. Considerable reliance will have to be placed on infantry support weapons which can be transported by toboggans or oversnow vehicles if available. Fire and movement are also of prime importance.

## **608. The Advance**

1. The Vanguard. In addition to the normal vanguard role of reconnaissance and protection, the vanguard will, in winter operations, be required to perform the role of trail breaking.

2. Formations. When danger is not imminent, sub-units may travel in single file in open country and in bush. This formation is the simplest to camouflage and requires fewer trail breakers. When contact is imminent, single file should be avoided and sub-units move in parallel columns. This will aid deployment to the front or flanks and avoids excessively long columns. Trail breaking ends on contact with the enemy, and sub-units and individuals must then do this themselves.
3. Navigation Party. During the advance when danger is not imminent, the navigation party should move well forward in the column. When danger is imminent, this party should be well back in the column. Each sub-unit should be prepared to navigate for itself, at least to the extent of marching on rough bearings. The navigating party will be used as a final check and authority.
4. Toboggans in the Advance. When toboggans are pulled during an advance they travel more easily on a broken trail, therefore, they should be grouped to the rear of their sub-units. When danger becomes imminent toboggans should be deployed well to the rear. A duty sub-unit may be appointed to pull toboggans leaving the front sub-units free and immediately available for action. For suggested formations see Annex A.

## **609. The Attack**

1. Patrolling. Before the attack in winter conditions, reconnaissance patrols should be used to a greater extent than is usually the case, although the information desired will be the same. Patrols should be used to harass the enemy, deny him rest, and upset his routine. This will pay greater dividends in winter operations than any other type of operation.
2. Achieving Surprise. Surprise may be achieved by various methods; timing of the attack to coincide with the hours of darkness or limited visibility, or direction of the attack. For example, attacking with the wind during periods of high windchill the attacker has the advantage of the wind on his back while the defender must fire into it. Attacking during storms although conferring an advantage on the attacker will also impose considerable difficulty on control, navigation, and movement.
3. Preparation for Move to Start Line. After the commander's reconnaissance and orders, or concurrent with them, routes to the Forming Up Place and Start Lines should be opened up, marked, and guides made ready. Marking devices must be positioned so as not to be obscured by drifting snow.
4. Action in the Forming Up Place. This will parallel action in normal operations with the exception that the tent group toboggans may be left here and the troops move forward with individual equipment only.
5. The Assault. In the early stages it may not be necessary that a sub-unit deploy, and each sub-unit will break its own trail until fire becomes effective. Deployment must then take place and trail breaking becomes an individual responsibility. In deep snow, snowshoes may have to be worn during the final assault, and should not affect close quarter fighting except where steep slopes are encountered. Skis should not be worn during this phase. Once the assault is

committed, sub-unit commanders must press home the attack with determination and maximum speed.

6. Support Weapons. During preparation for the move to the Start Line, sub-unit support weapons should be ready to move forward to prepared positions.

7. Recognition. Recognition markers or signals will normally be required to identify friend from foe. Where possible these should not prejudice individual camouflage and concealment.

8. Reorganization. Because of difficulty of movement and lack of shelter, reorganization will normally take place on the enemy position using his shelter and defensive positions. They should be vacated as soon as possible because of the likelihood of the enemy having his own position registered as a target. Reserves should be moved forward as quickly as possible to relieve the assaulting troops. These reserves may bring forward the tent group toboggans left in the Forming Up Place.

## **610. The Defence**

1. Deployment. Deployment will vary from the normal only in that no troops are likely to be available to provide a screen. A temporary screen may be provided by the point to allow deployment and the commencement of work by the main body. Sub-unit commanders must on arrival do a quick reconnaissance, and troops must be allowed to quickly commence work on the position to avoid any standing around in the cold.

2. Selection of the Position. Selection of the position will often be affected by the depth of the snow, particularly in open country. Siting the defensive position in an area of deep soft snow will aid construction of the position and hamper enemy movement in attacking it. It has the additional advantage of having a smothering effect upon his neutralizing fire. A position may be "dug in" by positioning it in deep snow drifts. High ground is of greater value in winter as the enemy must then attack uphill. Defensive positions constructed in snow banks along rivers or lakes will provide long open fields of fire. Advantage may be taken of these snow banks to construct snow caves connected to the fire trenches by tunnels or communication trenches. Generally speaking, defences in winter operations will have to be drawn closer together. Shelters should be sited close to fire positions, and time permitting, emergency shelters should be constructed in the fire positions. An improvised shelter may be quickly constructed by roofing over the communication trench.

3. Security. The security of a defensive position in winter operations presents an extremely difficult problem. During periods of high windchill the problem is acute. Sentries cannot look into the wind for very long and in spite of frequent reliefs can hear and see very little. Several solutions have been tried and been successful to varying degrees. A duty sub-unit may be used for sentries, thereby allowing remaining sub-units an extended time out of the cold for rest and warmth. Perimeter defences surrounded by a perimeter track may be used. This track is patrolled at irregular times to examine for enemy activity, or patrolled constantly if the threat is imminent. Mechanical devices in the form of trip flares, bounding mines, and automatic weapons firing on

fixed lines may be employed to thicken the security measure. It has been found that the most likely method of success is:

- a. To site the defensive position to obtain the maximum advantage of ground.
- b. Confine all work and movement to the hours of darkness and rest during the day.

4. Battle Preparedness. If a defensive position is to be ready at all times to meet an enemy threat, troops must live in shelters built into the defences. When the enemy threat is imminent, living and sleeping in tentage is extremely dangerous. Under these conditions troops must sleep fully clothed and within immediate reach of their fire positions.

## **611. Patrolling**

1. Type of Patrols. Under conditions imposed by winter operations, patrolling to provide information and security takes on increased importance. Patrols under these circumstances will consist of.

- a. short range patrols similar to those in temperate climates, but equipped with individual survival equipment; and
- b. long range patrols to effect deep penetration over an extended period of time. Dropping and pick up of the patrols may well be done by light aircraft or helicopter, although penetration on foot could be accomplished given sufficient time. Perimeter patrols are not discussed here as they are sentries performing a security role.

2. Conduct of Patrols. Normal conduct and patrol orders will apply with the following additional detail being considered by patrol commanders:

- a. Warning time must be increased to allow for maximum preparation.
- b. Emergency rations and survival gear must be carried.
- c. Route planning must be meticulous, and should be diagrammatic as opposed to written. Each member should be familiar with the route and know the bearing and distance for each leg. Each member should be prepared to return on his own, if necessary.
- d. When plotting routes to an objective, it is often wise to select a secondary objective close to the final objective. The patrol can then navigate to this point with reasonable assurance of security and freedom from enemy interference. The approach to the final objective can then be made unencumbered by the problem of recording and navigating. This may also serve as a rendezvous and dumping spot for heavy packs.
- e. Because patrols will generally be of short duration, they need not carry radio sets unless rapid transmission of the information is imperative.
- f. A prearranged homing device utilizing a system of flares has been found desirable. Various methods may be devised to prevent compromise of the home position with this device.

- g. Reconnaissance patrols may require at least two extra members to assist in breaking trail. Patrol commanders must consider this additional requirement when planning patrols.

## **612. Conclusion**

Normal tactics remain unchanged for winter operations. They require only adjustments to fit them to this type of operation. Strong forceful leadership is demanded of commanders at all levels. All ranks must be indoctrinated with the knowledge that their normal skills can be adapted to living and fighting under winter conditions, and they must be in excellent physical condition.

## SECTION 3 - CAMOUFLAGE AND CONCEALMENT

### 613. GENERAL

To achieve camouflage and concealment, the individual must always try to copy nature and blend in with his surroundings as much as possible. It is merely a case of using common sense. In winter, the whiteness of the countryside emphasizes any item which does not blend in naturally with its surroundings. Every movement leaves clearly defined tracks. Backgrounds are continually changing. Although white is the predominant colour, the texture of the white materials used for camouflage must also be considered. Arts 614 to 623 outline the main points to be borne in mind.

### 614. Individual Concealment

1. Individual camouflage is the concealment a soldier uses in combat to surprise, deceive, and outwit the enemy. The ground is the soldier's observation post, routes for advance and attack, fortification, protection, and communication. He must know how to use ground and adapt his dress for the best concealment when in a firing position or in motion. Individual concealment is using your brains and making the best use of available material. The main point to remember is that a soldier does not become invisible when he wears his camouflage suit. Other principles must be followed.

a. Clothing. The issue of winter clothing is in five separate pieces of two colours:

- (1) olive drab wind pants;
- (2) olive drab parka;
- (3) white camouflage pants;
- (4) white camouflage parka; and
- (5) white rucksack cover.

b. By using these colours in combination, four different sets of clothing are available, they are:

- (1) all dark;
- (2) all white;
- (3) dark pants and white parka; and
- (4) white pants and dark parka.

c. Terrain and Concealment. Although the terrain, over which winter operations are carried out, varies considerably as far as cover is concerned, it can be classified into four basic types. The types and recommended clothing combination for each type are as follows:

- (1) Heavy Forested Areas. These consist mainly of coniferous trees, or heavy deciduous trees with thick underbrush and willows; all dark clothing is best (see Figure 6-1).



- (2) Low Patchy Bush or Light Scrub Areas. These are mostly found in hilly or rolling country of poor soil where open snow background predominates and in the northern tree-line limit. A combination of dark pants and white parka is generally the most suitable (see Figure 6-2).
- (3) Open Snow Covered Areas with Dark Woods in the Background. These are found in hilly or mountainous regions. White pants and dark parka are generally the best combination (see Figures 6-3 and 6-4).
- (4) Open Snow Country of the Prairies or Tundra. All white clothing is the most suitable but care must be exercised in ensuring weapons and accoutrements are similarly camouflaged (see Figures 6-5 and 6-6).



Figure 6-1 Heavy Forested Areas



Figure 6-2 Low Patchy Bush or Light Scrub Area



Figure 6-3 Open Snow Covered Areas with Dark Woods in the Background



Figure 6-4 Open Snow Covered Areas with Dark Woods in the Background



Figure 6-5 Open Snow Country



Figure 6-6 Open Snow Country

- d. Movement. Before any move of his force, each commander must make a careful study of his proposed route, task, and time available before ordering the clothing combination to be worn. It may be necessary to change the colour combination to blend into the background, however, the value of such changes must be weighed against the importance of the task. No set rules can be laid down as to when and what combination of clothing should be worn. Any clothing changes must be made under cover, with half the force making the change while the other half provide observation and fire protection. The demands of the tactical situation, whether the move takes place in daylight or darkness and the need for concealment from aerial observation must all be taken into consideration.

## 615. Equipment Concealment

1. Small items of equipment and weapons are relatively easy to camouflage with excellent results being achieved by the use of flat white paint. Larger items such as tents and vehicles require more consideration. The methods of camouflaging and concealing the tent given below also apply in principle to other large items:

- a. Tent in Heavy Forested Areas. A quick method of camouflage is to cut trees to thicken up the area around the tent after it has been pitched. Care must be taken not to disturb the snow cover on the trees being cut. Another method is to suspend small trees by wire over the tent. The silhouette of the tent can be lowered by removing a section of the tent pole, or telescoping the pole to a shorter length and tightening the guy ropes.
- b. Tent in Thin or Scattered Tree Cover. In some instances, the principles for heavy forested areas apply, however, the main object is to break up the dark pyramidal shape of the tent which is easily seen against the open snow areas which are always present. This is easily achieved by stringing white objects such as rucksack covers or camouflage clothing together and draping them over the tent (see Figure 6-7 before, 6-8 after with net Figure 6-9).



Figure 6-7 Tent in Thin or Scattered Tree Cover – Before



Figure 6-8 Tent in Thin or Scattered Tree Cover - After



Figure 6-9 Tent in Thin or Scattered Tree Cover - with Net

- c. Tents on the Prairies or Barrens. In such areas, tents are visible for great distances because of their marked contrast to the white background. Two camouflage methods are available:

- (1) Dig the tent into a deep snow drift and lower the silhouette by telescoping the pole. The excavated snow should be smoothed as much as possible to erase the change in texture and make it conform to the surrounding drift. This is not necessary where blowing snow is encountered.
- (2) A second method is to increase the height of the protective wall and use the rucksack camouflage covers on the outside of the tent to break the tent outline.

## **616. Field Defences**

1. All field defences must be camouflaged whether they are dug down into the snow, or built up above the snow level. All defences should be connected by communication trenches. Where possible they should be sited under the overhead cover of the surrounding trees and brush. The following points should be noted:

- a. The side and ends of all trenches should have pronounced slopes and rounded edges to prevent the formation of shadows.
- b. Do not dig to ground level as dead grass, twigs, leaves, etc., mixed with the excavated snow make a sharp contrast with the surroundings and the bottom of the fortification becomes obvious. If this is unavoidable, break up the regular pattern by adding twigs, branches, or trees.
- c. Troops walking back and forth will pack the snow in the bottom of trenches and fresh snow must be added from time to time.
- d. Snow spoil from all excavations should be brushed smooth with twigs or boughs and not left lumpy or in uneven piles.

## **617. Tracks and Trails**

Tracks and trails are very difficult to conceal. The only effective method is strict track discipline and the use of deceptive trails. Tracks can be partially concealed from air observation by breaking up the sharp edges that cast shadows. This can be achieved by trailing large trees behind each track of oversnow vehicles, and similarly in the case of ski, snowshoe, and toboggan tracks. It is a tiring procedure for troops and should not be attempted over long distances.

## **618. Light Discipline**

1. During winter operations, the hours of darkness are long. Troops must be trained to accomplish many of their tasks without the use of lights. Light reflections from the snow and vapour in the air can be seen from great distances, especially in clear cold nights. Most infractions occur in bivouac areas during normal camp routine. Points to note are as follows:

- a. Tents. Light escapes from the door and stove pipe hole. The stove pipe hole should be covered with a loose layer of boughs but only enough to allow moisture and steam to filter through. The coleman lamp control valve lever should be turned down and a parka held in front of the lamp each time someone enters or leaves the tent. The door should be kept zippered at all times.

- b. Flashlights. All flashlights should have the lenses covered with a filter or tissue paper so they can only produce a diffused beam. Troops should be trained to operate as much as possible without flashlights as a light beam destroys night vision to which the human eye will become naturally accustomed.
- c. Fires. Open fires should be restricted to rear areas or daylight only when blowing snow conditions exist. Garbage should be burned in dummy positions.

### **619. Vapour Clouds**

In very cold still air local fogs or vapour clouds form above anything that gives off heat such as vehicle exhausts, firing of weapons, and natural heat given off by a man in breathing. In some instances these fogs can be minimized but when conditions remain constant, the only solution is to move. Vehicles should be left in rear areas. Troops should breathe through their face masks or neck squares and all tent openings should be kept covered during daylight hours.

### **620. Noise Level**

In still cold air sounds travel great distances. Conversations can be heard up to a mile away - while the click of a rifle bolt and the sound of skis and snowshoes can be heard at half a mile. Troops must be constantly reminded about silence and keeping noise to a minimum. Orders must be given quietly and, where possible, all the necessities of daily living kept to inside tents or shelters which assist in muffling sounds.

### **621. Deception**

In winter operations many opportunities exist for individual or unit deception, however, its value is reduced if it does not follow a logical sequence and fit into the tactical plan. All deception measures taken, such as dummy positions, vehicles, and tracks must be maintained and made to look as if they were in constant use. A few skiers or oversnow vehicles can create a network of tracks and trails to mislead the enemy about direction, strength, location, and intention. Improvised devices can be made of snow, tree branches, and discarded ration boxes, and should appear camouflaged. Small fires should be lighted to produce smoke to simulate vehicle exhaust or bivouac areas (for examples see Figures 6-10 and 6-11).



Figure 6-10 Deception Area Showing Trails and Bivouac Area



Figure 6-11 Dummy Oversnow Vehicle

## 622. Examples of Vehicle Camouflaged

See Figure 6-12, 6-13, 6-14, 6-15, and 6-16.



Figure 6-12 Example of Ice Fog Caused by a 90 mm Gun





Figure 6-13 Example of Camouflaged Vehicle



Figure 6-14 Example of Camouflaged Vehicle



Figure 6-15 Example of Camouflaged Vehicle

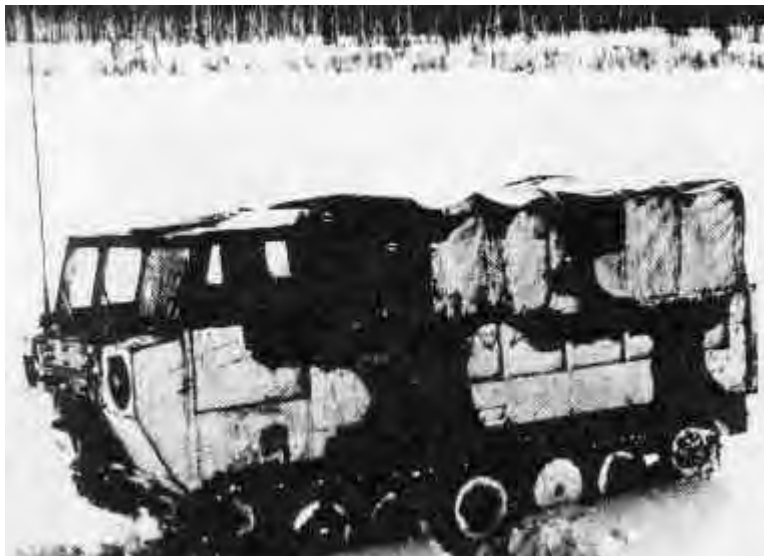

Figure 6-16 Example of Camouflaged Vehicle

**623. Formula of Paint Used**

1. Formula for paint is as follows:
  - a. Four parts water and one part glue (wall sizing) and four or more parts hydrated lime equals a white solution suitable for application on a smooth metal surface.
  - b. The water should be heated to approximately 180°F. The glue should be added slowly, at the same time stirring vigorously. When the glue has dissolved add four or more parts of hydrated lime and stir until the lime is well blended. Apply with brush or spray gun.

**(624, to 699 inclusive: not allocated)**

## CHAPTER 7

# COLD WEATHER INJURIES AND HEALTH RULES

## SECTION 1 - FIRST AID

### 701. General

1. The fundamentals of first aid are the same whether the temperature is - 30° or + 70°F; but prevention and treatment measures in the severe cold have to be modified to meet the added hazard of freezing temperatures. Moreover, there is a constant danger of cold weather injuries or ailments. You must, therefore, add to the first aid knowledge you already have so that you will be an "expert" on cold weather first aid.

2. In cold weather, casualties should be given first aid treatment, protected from the cold and shock effects and evacuated to an aid station with a minimum of delay. They should be placed in a casualty bag, sleeping bag, or the best available substitute. Here, for example, are additional points to remember when operating under cold weather conditions:

- a. Wounds bleed easily because the low temperature keeps the blood from clotting and increased bleeding increases the likelihood of shock.
- b. Wounds open to the weather freeze quickly. The body loses heat in the area around the injury, as blood soaks the skin around the wound, and clothing is usually torn. Therefore, early first aid treatment becomes even more important at low temperatures.

3. Remember these rules:

- a. Stop the bleeding, apply a dressing and, when necessary, put on a splint.
- b. Quickly cover the area to keep out the cold.
- c. Begin anti-shock treatment as soon as possible.
- d. Casualties must not be left unattended.

### 702. Shock

1. General. Shock is a condition caused by the reduction of the effective circulating blood volume. It can be caused by severe injuries, loss of blood, pain, and many other factors. The normal reaction of the body to severe cold is very similar in its reaction to shock. Therefore, shock will usually develop more rapidly and progress more deeply in extreme cold than it will in normal temperatures.

2. Signs of Shock

- a. apprehension;
- b. sweating;
- c. pallor;

- d. rapid, faint pulse;
- e. cold, clammy skin; and
- f. thirst.

### 3. Treatment

- a. Reassure the casualty. Pain can be reduced by proper positioning, good bandaging, and splinting.
- b. The stretcher should be positioned so that the casualty's head and chest is lower than his lower body and legs. About one foot difference is right. This should not be done if it will cause discomfort to the casualty.
- c. The casualty must be kept warm, normal body temperature is best.
- d. Do not move the casualty anymore than necessary. This is not movement, over distance, but the movement of a casualty from one stretcher to another or any unnecessary lifting or turning over when bandaging or splinting, or moving a casualty from a sleeping bag into a casualty bag, etc.
- e. Loosen the clothing at the neck, chest, and waist, weather permitting.
- f. If the casualty is conscious he should be given sips of warm soup, tea, cocoa, coffee, or any other available liquid - but no alcohol.
- g. Casualty should receive medical attention as soon as possible.

### **703. Frost-bite**

1. Frost-bite is the freezing of some part of the body. It is a constant hazard in sub-zero operations, especially when there are strong winds.

#### a. Signs

- (1) Usually there is an uncomfortable sensation of coldness, followed by numbness.
- (2) There may be a tingling, stinging, or aching sensation, even a cramping pain.
- (3) Skin first turns red, later becomes pale or waxy white.
- (4) Parts affected, in order of common occurrence, are:
  - (a) nose,
  - (b) ears,
  - (c) cheeks,
  - (d) forehead,
  - (e) wrists (if no gauntlets or wristlets are worn),
  - (f) toes, and
  - (g) fingers.

(This list shows the importance of watching the face for early warning of frost-bite).

b. Types. Depending on the damage caused to the tissue, the following classification is given to frost-bite; superficial and deep (see Figures 7-1, 7-2, and 7-3):

- (1) Superficial. This involves only the skin or the tissue immediately beneath it. There is a certain amount of whiteness or "waxy" appearance. After rewarming, the frost-bitten area will first become numb, mottled blue or purple and then swell, sting, and burn for some time. In more severe cases, blisters will occur in 24 to 36 hours beneath the outer layer of skin. These slowly dry up and become hard and black in about two weeks. Generally swelling of the injured area will subside if the casualty stays in bed or at complete rest - it will last much longer if he refuses to remain quiet. Throbbing, aching, and burning of the injured part may persist for several weeks, depending on the severity of the exposure. After the swelling finally disappears, the skin will peel and remain red, tender, and extremely sensitive to even mild cold, and it may perspire abnormally for a long time.
- (2) Deep Frost-bite. This is a much more serious injury and its damage not only involves the skin and subcutaneous tissue but also goes deep into the tissue beneath, (even including the bone); it is usually accompanied by the formation of large blisters. In marked contrast to superficial frost-bite these take from three days to a week to develop. Swelling of the entire hand or foot will also take place, and may last for a month or more. During this period of swelling, there may be marked limitation of mobility of the injured fingers or toes, and blue, violet, or grey (the worst) discoloration takes place. After the first two days, aching, throbbing, and shooting pains may be experienced for as long as two to eight weeks. The blisters finally dry up, blacken, and slough off, sometimes in the form of a complete cost of the finger or toe, nail and all, leaving beneath an exceptionally sensitive, red, thin layer of new skin, which will take many months to return to anywhere near normal. Sometimes, itching and abnormal perspiration persists for more than six months after the initial injury, and the part will suffer lengthy or permanent sensitivity to cold. In extreme cases of severe frost-bite that have not been rewarmed rapidly, permanent loss of some tissue almost invariably occurs. In such cases the skin does not become red and blistered after it has thawed, but turns a lifeless grey and continues to remain cold. If blisters occur they will probably appear along the line of demarcation between the acutely frostbitten area and the healthy remainder of the limb. In cases of acute deep frost-bite of the foot, adjacent swelling can extend as high as the knee. In a week or two after the injury, the tip of the injured area begins to become black, dry, and shrivelled, but the rest of the damaged area may progress in one of two entirely different ways: the tissue may all become black, dry, and shrivelled to almost half the normal size and mummified right up to the beginning of the healthy flesh; or it may become wet, soft, and inflamed, if infection enters the picture. In the dry type, the uninjured remainder of the limb usually does not become intensely swollen or painful, and there is a clear line of demarcation

between damaged and undamaged tissue. In the wet type, the whole limb tends to become painful and swollen, and originally undamaged tissue may suffer serious damage unless the infection is promptly checked. Surgical intervention is rarely needed in less than two months. Even minor surgery on frost-bitten tissue should never be performed in the field. Under normal circumstances, in an extreme case in which the loss of some tissue is inevitable, despite careful treatment, the necrotic material will simply slough off at the proper point and at the proper time, with a maximum saving of the sound underlying tissue. Occasionally, when unsuccessful treatment has resulted in wet gangrene, hospitalization and professional surgical intervention to stop cellulitis may be needed. However, if even this type of case is kept scrupulously clean and sterile, the proper use is made of antibiotics, and the patient stays constantly in bed at rest throughout the illness, the chances are high that auto-amputation will eventually occur.

c. Prevention

- (1) It is easier to prevent frost-bite or stop it in its earlier stages, than to thaw and take care of badly frozen flesh.
- (2) Enough clothing must be worn for protection against cold and wind. Clothing and equipment must not restrict the circulation.
- (3) Do not touch cold metal with bare skin at extreme low temperatures.
- (4) Exercise the face, fingers, and toes from time to time to keep them warm and to detect any numb areas.
- (5) Use the buddy system. Men should pair off and watch each other closely for signs of frost-bite. Any frozen spots must be thawed immediately.

d. Treatment

- (1) Do NOT use:
  - (a) snow,
  - (b) grease,
  - (c) oil,
  - (d) rubbing,
  - (e) massage, or
  - (f) pressure.
- (2) Superficial Frost-bite
  - (a) A minor case of superficial frost-bite is fairly common and serves as a warning. It should not interfere with a man's job except for the time it takes to get the affected area thawed out.
  - (b) A frozen nose is the most common type of minor frost-bite. Holding the pile on the back of the mitt over the lower face and

breathing into it will warm the nose quickly. A scarf or cap comforter worn over the face will usually prevent frost-bite.

- (c) Minor frost-bite can usually be thawed with body heat. Place your bare warm palm against a frostbitten cheek or ear, or place frost-bitten hands against your chest, between your thighs, or under your armpits.
- (d) A more severe case of superficial frost-bite, which produces blisters, may require that the casualty be evacuated to a rear area for medical aid and convalescence. This may require several weeks.



Figure 7-1 Superficial Frost-bite

(3) Deep Frost-bite

- (a) Remove casualty to a heated shelter to avoid danger of further frost-bite.
- (b) All constricting items of clothing such as boots, gloves, and socks should be removed from the area of injury if this can be done without causing further damage to the frost-bitten part.
- (c) The frozen part should be placed against an unfrozen portion of the body or exposed to warm air. Rapid thawing by the application of external heat may be harmful. Gradual warming by body heat is the safest way to relieve frost-bite.
- (d) Avoid infection by cleaning and dressing.
- (e) No attempt should be made to thaw frozen parts by exercising them or by heating them in front of an open fire.
- (f) Early treatment by a medical officer is vital.



Figure 7-2 Deep Frost-bite



Figure 7-3 Deep Frost-bite

#### **704. Advanced Cold Exposure**

1. This is sometimes called "advanced general freezing". The body temperature drops, the man becomes drowsy, then semi-conscious, and finally, unconscious. In the initial stages his body is stiff, he feels cold to the touch, and his pulse and breathing are slow and weak.

#### 2. Treatment

- a. Get the casualty into a heated shelter as quickly as possible.
- b. Do not heat the casualty too quickly, otherwise his condition will become worse.
- c. Improvise heating pads from gravel, tinned rations, etc., wrapped in woollen socks or other cloth material and place them on the vital organs, in the following order:
  - (1) pit of stomach,
  - (2) small of back,
  - (3) back of neck,



- (4) under armpits,
  - (5) on wrists, and
  - (6) between legs from crotch to ankles.
- d. When he comes around, treat any signs of frost-bite on his body and give him hot, sweet fluids in large amounts - hot tea with lots of sugar is particularly good.
  - e. Evacuate the casualty to a medical officer as soon as possible after he has revived.

## **705. Snow Blindness**

1. Well trained troops should never suffer from snow blindness. Snow blindness is caused by the effect of infrared or ultra-violet rays reflecting from a snow covered surface. These rays, unlike visible light rays, are readily absorbed by clear or coloured glass. Danger of snow blindness is greatest, not on a clear bright day, but on dull, cloudy days or when crystalline snow mist is present.

2. Symptoms. These appear in about six to eight hours, usually in the following order:

- a. irritation and gritty feeling in the eyes;
- b. eyes feel hot and sticky and tears flow excessively;
- c. sight becomes blurred;
- d. pain develops in and over the eyes;
- e. the casualty develops a fear of light (photophobia); and
- f. objects develop a pinkish tinge.

3. Prevention

- a. Wear eye-glasses or sun-glasses.
- b. If you lose your glasses, cut very narrow horizontal slits in a thin piece of wood or cardboard the width of your face. Fit the wood across your eyes as you would sun-glasses and secure with string.
- c. Wear your cap comforter, woollen sock, or cuff off of your parka and look through the small squares of the knitted material.
- d. Blacken the lower eye lid and cheeks to absorb the sun's rays and to stop them from reflecting off your face into your eyes.
- e. You can improvise a pair of sun-glasses out of any available material. All you must do is cut down the amount of light getting through to your eyes.

4. Treatment

- a. The only effective remedy is rest and darkness. Keep the casualty in a dark room or have him wear a lightproof bandage.
- b. The pain can be relieved by cold compresses if the air temperature is above freezing.
- c. If alone when you find yourself developing the symptoms, get into your sleeping

bag while you still have partial vision, cover your eyes, and stay there until you can see again.

- d. Do not use eye drops or ointment of any kind. They will not speed recovery and some types will damage the eyes.

Note: Most minor cases will recover within 18 hours without medical treatment, a severe case will take from three to four days to recover.

## **706. Immersion Foot (Trenchfoot)**

1. Immersion foot is a cold injury resulting from prolonged exposure to temperatures near freezing. Remember the temperature does not need to be below 32°F to cause this injury.

### a. Signs

- (1) In the early stages the feet and toes are pale and feel cold, numb, and stiff, and walking becomes difficult.
- (2) If preventive action is not taken, the feet will swell and become painful. In extreme cases the flesh dies and amputation of the foot or of the leg may be necessary.

### b. Prevention. Because the early stages are not painful, individuals must be constantly alert to prevent the development of immersion foot. To prevent this condition:

- (1) check feet often when operating in wet cold;
- (2) feet should be kept dry by wearing waterproof footgear and by keeping the floor of shelters dry;
- (3) socks and boots should be cleaned and dried at every opportunity;
- (4) the feet should be dried as soon as possible after getting them wet. They may be warmed with the hands. Foot powder should be applied and dry socks put on;
- (5) if it becomes necessary to wear wet boots and socks, the feet should be exercised continually by wiggling the toes and bending the ankles. Tight boots should never be worn.

### c. Treatment. In treating immersion foot, the feet should be handled very gently. They should be rubbed or massaged. If necessary, they may be cleansed carefully with soap and water, dried, elevated, and exposed to air. Although it is desirable to warm the patient, the feet should always be kept cool by exposure to room air. Early treatment by the medical officer is vital. Casualties should be evacuated by litter.

## 707. Sunburn and Wind Chapping

You can get sunburned even though the temperature of the air is below freezing. On snow, ice, and water, the sun's rays are reflected from all angles and attack where the skin is sensitive around the lips, nostrils, and eyelids. Sunburn cream applied to the parts of the face exposed to reflected light will give effective protection. Soap or shaving lotions with a high alcoholic content should not be used since they remove natural oils that protect the skin from the sun. If the skin blisters, report to the unit aid station, since blistered area, especially lips, may become badly infected. Chapping due to cold and wind is rarely serious. Any greasy substance can be used for treatment. Care must be exercised in the use of sunburn cream or any other type of greasy substances, as any substance with a greasy base will attract the cold.

## 708. Carbon Monoxide Poisoning

### 1. General

- a. Carbon monoxide is a deadly gas, even in low concentrations, and is particularly dangerous because it is odourless.
- b. Carbon monoxide is not the same as "fumes". Carbon monoxide can be present when there are no fumes; and fumes can be strong when there is no carbon monoxide.
- c. The most common sources of carbon monoxide are engine exhausts and coal stoves. Although tests reveal there is less danger of carbon monoxide poisoning from army gasoline stoves or lamps, this cannot be taken for granted and ventilation must constantly be checked. A fatal dose is one part carbon monoxide to 800 parts oxygen.
- d. Carbon monoxide is produced by any combustion that produces carbon or uses carbon in combustion.

2. Signs. Usually there are no signs. However, the following symptoms may be present; headache, dizziness, impaired vision, mental confusion, yawning, weariness, nausea, and a ringing in the ears. Later on, the heart may begin to flutter or throb. Normally, however, the gas will strike without warning and a soldier may not know anything is wrong until his knees buckle.

### 3. Treatment

- a. The casualty must be moved into the fresh air at once, but must be kept warm.
- b. The casualty should not be exercised since this increases his need for oxygen.
- c. If a casualty stops breathing, or breathes only in gasps, artificial respiration should be started immediately.
- d. Carbon monoxide poisoning is serious and a casualty who survives it must be kept absolutely quiet and warm for at least a day in a well ventilated place.

## **709. Fume Irritation (Tent Eye)**

Fumes are produced by gasoline stoves and lamps and, if ventilation is poor, they will build up steadily and cause eye irritation. This often happens when men first begin living in tents. This condition can be prevented if stoves and lamps are kept clean and tents are properly ventilated. Fresh air is the only effective permanent treatment, although holding snow on the eyes will relieve the irritation.

## **710. Constipation**

1. When operating under cold weather conditions there is a general tendency for individuals to allow themselves to become constipated. This condition is brought about by the desire to avoid the inconvenience and discomfort of relieving themselves under adverse conditions. This condition is also caused by changes in eating habits and failure to drink a sufficient amount of liquids.

2. Symptoms. If this condition exists for a prolonged period, it could result in mild to severe stomach cramps, headaches, dizziness, and the setting-in of a feeling of general tiredness and weakness.

3. Treatment. Constipation can usually be prevented by adjusting the normal eating and drinking habits and by not "putting-off" the normal, natural processes of relieving the body of waste matters. Mild laxatives can be taken to restore natural body functions. Medical personnel should be consulted if severe constipation persists.

## **711. Dehydration**

1. Dehydration results when you are deprived of water. Just as a growing plant will wither and dry up if it is deprived of water, our bodies will suffer if they do not have a steady supply of water. The human body is constantly losing water, and the more strenuous the work, the greater the loss of water. Surprisingly, the danger of dehydration is just as great in cold regions as in hot dry regions. The difference is that in hot weather you realize your body is losing liquids because you can see and feel the perspiration. When you are bundled in layers of clothing in the cold, it is hard to realize the same danger exists, but it does. It is just that perspiration is quickly absorbed by the heavy clothing or evaporates in the air.

2. Symptoms

- a. Mouth, tongue, and throat become parched and dry, swallowing becomes difficult.
- b. General nausea, possibly accompanied by faintness, extreme dizziness, and vomiting.
- c. General tiredness and body aches, especially in the legs.
- d. Difficulty in keeping the eyes in focus, and fainting or "black out".

3. Prevention

- a. Men must constantly be reminded of the importance of drinking plenty of liquids.
- b. When possible, have mid-morning and mid-noon breaks for drinks from a thermos.
- c. Make it a habit to have a hot drink (cocoa or soup for example) before turning in at night.

4. Treatment

- a. Casualties should be kept warm but clothes loosened to allow good circulation.
- b. Liquids and salts should be fed to the casualty gradually. When salt tablets are not available, common table salt may be used.
- c. Plenty of rest is essential.

**712. Casualty Bag**

See Figures 7-4, 7-5, 7-6, and 7-7.



Figure 7-4 Casualty Bag



Figure 7-5 Casualty Bag



Figure 7-6 Casualty Bag



Figure 7-7 Casualty Bag

### 713. Casualty Evacuation by Toboggan

See Figures 7-8 and 7-9.



Figure 7-8 Casualty Evacuation Toboggan



Figure 7-9 Casualty Evacuation - Toboggan

## SECTION 2 - HEALTH RULES

### 714. General

1. Cold weather is healthy weather - providing you know how to look after your body when the thermometer drops below freezing. There is nothing difficult or complicated. The rules of hygiene and sanitation you have already been taught apply, with a few common sense modifications to cold weather living. The chief difference is that you pay a bigger penalty if you ignore the rules when the mercury is hovering around, or below, the zero mark.
2. By following hygiene and sanitation rules described in this section, the toughest cold weather will be a challenge you can easily meet.

### 715. Individual Adjustment

1. Men whose outdoor living has been restricted to summer training concentrations at Wainwright, Petawawa, or Gagetown, may be uneasy about the prospect of living outdoors in below freezing temperatures. The right approach will go a long way towards keeping you healthy and seeing you through what can be an invigorating experience. Here are four basic rules to remember:
  - a. Keep in Shape. Cold weather clothing is heavy and you will turn up a lot of energy just walking in the snow. By keeping fit, you will do your job without becoming exhausted. A sleeping man will not freeze unless he is exhausted. A healthy man will awaken long before he reaches the danger point.
  - b. Drink Plenty of Water. Because water may be hard to get, you may drink less than you need. Tests show that in cold climates men normally drink only when they are thirsty. This may not give them the water they need and they may become dehydrated. Drink plenty of water to avoid dehydration, and the fatigue which follows.
  - c. Eat to Keep Fit. Regular, satisfying hot food is essential for top performance. Even if you are not hungry, eat your fill. If you do not, you will not stay fit long.
  - d. Maintain a Healthy Attitude. You will find yourself up against a lot of new problems, but none a trained soldier cannot overcome. Keep alert and cheerful, and work hard. This combination will automatically give you the right

### 716. Personal Hygiene

1. **Care of the Body**. To stay healthy on cold weather operations, keep clean. This will not always be easy because of the lack of bathing and sanitary facilities. But here are the rules you must follow as closely as circumstances permit:
  - a. Wash your face and hands daily. There are not likely to be baths around, but you should wash your feet, crotch, and armpits at least twice a week, and oftener if possible.



- b. Comb your hair daily and do not let it grow too long. Moustaches should be kept short (some men find them a nuisance in cold weather since they serve as a base for the build-up of ice from moisture in the breath and may mask the presence of frost-bite).
- c. Shave every day. The best time is just before turning in for the night.
- d. Socks should be changed and the feet washed as often as possible - at least twice a week. But boots and socks should be removed every night and the feet massaged and dried. By sprinkling the feet liberally with foot powder and then rubbing the powder off, the feet can be efficiently "dry cleaned".
- e. Teeth should be cleaned daily. If you have no toothbrush, use a clean piece of gauze or other cloth wrapped around the finger, or end of a twig chewed into pulp.
- f. Underwear and shirts should be changed at least twice weekly. If this is not possible, they should be crumpled, shaken out, and aired for about two hours.

## **717. Food**

1. Calories. You need more calories when living in the cold to meet the increased energy requirements. This extra energy is needed for:

- a. heating the air you breathe;
- b. humidifying the air you breathe;
- c. making up for body heat lost to the cold; and
- d. extra work of moving about in snow wearing 25 pounds of clothing.

2. Efficiency. If you do not get the calories you need, your efficiency may fall off noticeably in a few days, resulting in:

- a. fatigue;
- b. listlessness; and
- c. instability.

3. Healthy Rules

- a. Eat your fill of frequent hot meals, drinks, candy, and dried fruit on the march.
- b. Eat a fourth meal whenever possible.
- c. Save snacks (cookies, chocolate bars, etc.) for between meals.
- d. Prepare haversack lunches for meals to be eaten on the move.

## **718. Latrines and Garbage**

Details concerning latrines and garbage disposal are contained in Chap 3, Sect 1, arts 307 and 308.



## **719. Conclusion**

The points made in this section are all common sense. By following them you will increase your comfort and good health will be retained.

**(720 to 799 inclusive: not allocated)**

## SUGGESTED FORMATIONS IN THE ADVANCE

LEGEND

-  Trail breaking group
-  Navigating group

1. PLATOON FORMATIONS DANGER NOT IMMINENT

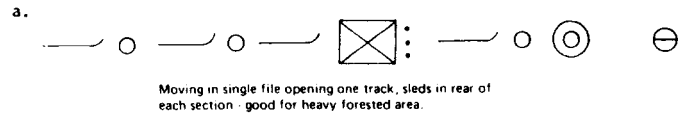

OR

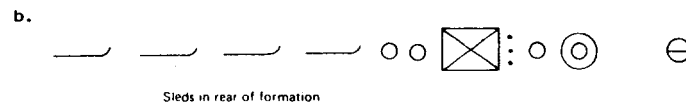

2. COMPANY FORMATIONS DANGER NOT IMMINENT

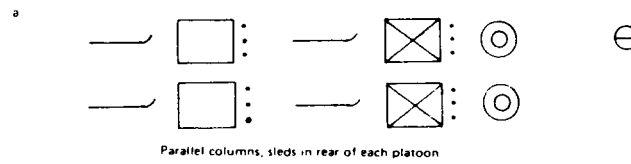

OR

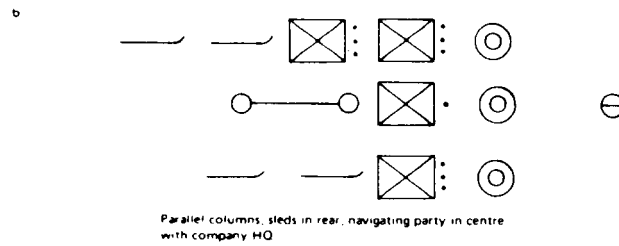

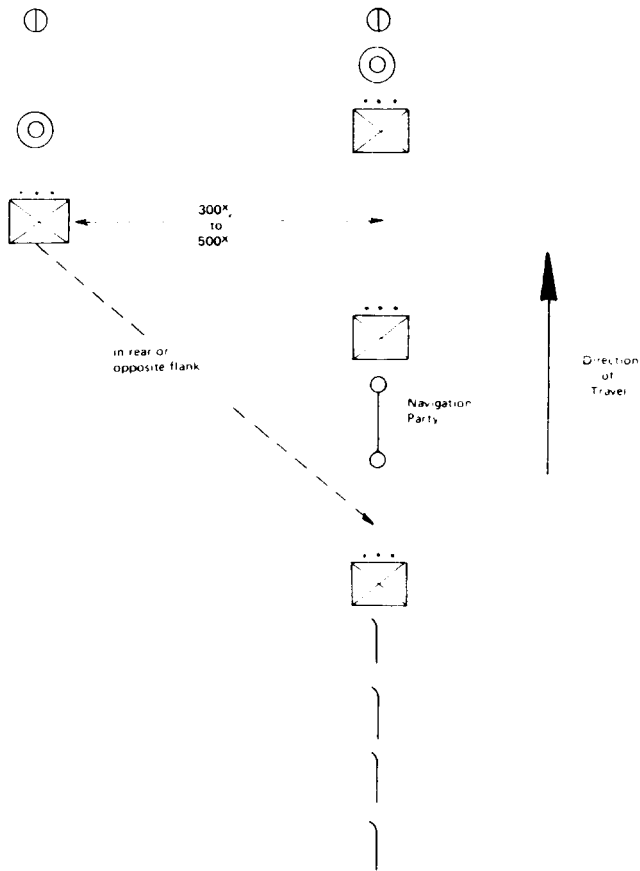

It is advantageous to deploy a flank platoon, breaking its own trail under these conditions. The heavy soft snow generally found in forested areas dictates single file movement to maintain momentum. It also facilitates ambush. Should this happen, the flank platoon should be available as an undisturbed attacking force. The flank platoon, in this instance, must have its own Navigating Party.

## NOTES ON ICE CROSSINGS

### 1. Introduction

Ice is at best a product of poor quality control. This paper covers the following:

- a. type of ice;
- b. ice reconnaissance;
- c. best crossing sites;
- d. reinforcing ice;
- e. safety precautions; and
- f. load bearing capacity.

### 2. Types of Ice

a. Blue Ice. Good ice is indicated by:

- (1) blue or green colour;
  - (2) few cracks; and
  - (3) no air bubbles (cloudiness);
- (This is ice used for Load Table Appendix 1)

b. Lake Ice. It is often weak in the vicinity of:

- (1) stream inlets/outlets;
- (2) banks, islands (false ice); and
- (3) decaying water vegetation because of gas inclusion.

c. Candle Ice. Candle ice crystals have a definite vertical structure which is very weak. Found on some lakes, and not to be used if another route is available.

d. Rotten Ice. Usually found at the top or bottom of clear ice. It is dull, chalky, brittle and has no load carrying capacity.

### 3. Ice Reconnaissance

a. Factors to consider are:

- (1) thickness,
- (2) quality,
- (3) location,
- (4) continual use,
- (5) cracks.

b. Thickness Measurement

- (1) Chop a hole in ice.
- (2) Push a pole into hole to ensure all ice layers penetrated.
- (3) Measure the depth of ice.
- (4) Put axe in hole and pull up hard against bottom of ice - take that measurement.
- (5) Repeat every 30 feet for vehicles and, when questionable areas are encountered.
- (6) Beware of multi-layer ice sheets, for strength see para 6.

c. Quality. If the ice is not good ice (see para 2a) then discount its thickness.

d. Location. The following locations will usually have weak ice and must be checked closely:

- (1) river and lake banks for false ice (not resting on water) that is usually weak;
- (2) suspected sand bars for fast water and false ice;
- (3) fast flowing water because it retards ice growth by erosion; and
- (4) decaying water born vegetation (bogs, muskeg) because the gas gets into the ice structure and weakens it.

e. Continual Use

- (1) Inspect route twice each day for:
  - (a) erosion,
  - (b) cracks,
  - (c) deterioration of surface of route by vehicle use and melting,
  - (d) that snow cleaned off road way and verges, and
  - (e) route markers visible.

f. Cracks

- (1) In extreme cold, cracking is caused by ice contraction. These must be noted and watched closely and repaired if necessary during milder weather.
- (2) New Cracks appearing after a Route is in Use
  - (a) A single crack which is in the same direction as the flow of river water or in a lake at right angles to the route does not necessarily indicate weakness but should be inspected.
  - (b) Cracks along the axis of the route are signs of weakness and must be repaired or the route reinforced (see para 5).

4. Best Crossing Sites

- a. A stream where it is broad and straight.
- b. A location where banks are low and gently sloping.
- c. Where water velocities are low and uniform.

5. Reinforcing Ice

a. Flooding and Freezing

- (1) The temperature should be 16°F or less.
- (2) For roads clear snow cover 15 feet on each side of the roadway.
- (3) Spray water in 1/8 to 1/4 inch layers and repeat when frozen.

b. Reinforcing Materials

(1) Blocks of Ice Laid on Track

- (a) Minimum of 4 feet long and 4 inches deep for each track.
- (b) Laid so there is 2 feet on each side of track.
- (c) Must have good contact with ice surface below by use of straw-water mixture or a thin layer of water-snow mixture or plain water.

(2) Straw or Brush Wood. Laid in 2 to 4 inch layers cemented down with water along whole roadway.

(3) Planks (2 inches or more) or Small Logs Along Wheel Track

- (a) Must be frozen into place.
- (b) Three feet wide under each wheel track.
- (c) In good contact with bearing surface.

(4) Freezing Times for One Inch of Ice

- (a) Two hours at 14°F.
- (b) One hour at 4°F.

6. Safety Precautions

a. Men Crossing

- (1) Follow the existing route.
- (2) Keep skis/snowshoes unstrapped.
- (3) Make sure rucksack comes off quickly.

- (4) A rescue party should be standing by wearing skis and with 50 feet of rope looped at both ends.

b. Vehicles

- (1) Spacing interval as at Appendix 1.
- (2) No stopping.
- (3) No turning around.
- (4) Keep a slow steady speed (see Appendix 1, Note a).
- (5) Keep on marked routes.
- (6) Move slowly from bank on to ice surface.
- (7) Ensure driver and passengers can get out quickly.
- (8) Passengers will not wear rucksacks and if feasible they should walk across ice.



**APPENDIX 1**

**GUIDE TO LOAD BEARING CAPACITY OF FRESH-WATER ICE**

LOAD	ICE THICKNESS FOR (0° to 10°F) Temperature (-18° to -12°C)				SPACING INTERVAL IN METRES
	RISK		NORMAL		
	inches	cm	inches	cm	
(a)	(b)	(c)	(d)	(e)	(f)
Single soldier on skis	1-2/3	4	2	5	5
File of soldiers - 2 pace intervals	3-1/4	8	4	10	N/A
<b>Vehicles</b>					
1/4 ton	5	13	8	20	15
3/4 ton	6	17	10	25	20
2-1/2 ton	13	33	16	40	25
5 ton cargo	18	45	22	55	60
5 ton tractor with loaded trailer	32	80	36	90	80
XM 548 Cargo carrier	8	20	10	25	20
M 548 Recovery vehicle	20	50	26	65	60
M 113A1 APC	13	33	18	45	25
LYNX	10-1/2	26	16	40	20
M 109 Howitzer, SP 155 mm	18	45	20	50	40
Nodwell	8	20	10	25	20
Tractor D7	18	45	20	50	40
Tractor D8	20	50	24	60	50
Crane 20 ton	20	50	24	60	70
Grader	14	35	16	40	50

**Notes:**

- a. Vehicles should maintain speeds of 10 mph where water depth under the ice is up to 20 ft deep and 20 mph if the water is deeper.
- b. First crossing always DANGEROUS.
- c. Reinforced ice calculations: Working thickness = original thickness + 1/2 of added thickness
- d. Continual use of critical load might require additional ice thickness.
- e. Ice strength increases from freezing to zero °F then remains constant.
- f. Approximate vehicle class =  $\frac{\text{Total weight of vehicle} + \text{Load}}{2000}$

## THEORY AND USES OF THE ASTRO COMPASS

### Introduction

1. In the Canadian Arctic, the earth's magnetic lines of force are almost vertical to the surface. As a result, the horizontal component of our planet's magnetism is too weak to provide a reliable heading reference on a magnetic compass. Therefore, other means, independent of magnetism, have to be relied upon. The celestial bodies are ideally suited as an alternate method. The familiar magnetic compass is now replaced by the astro compass. The astro compass gives an accurate indication of TRUE DIRECTION by sighting on the predicted position of a celestial body (see Figure C-1).

### Basic Astronomical Concepts

2. The earth is a sphere, rotating about its spin axis in 24 hours. This rotation is carried out from West to East at a rate of  $15^{\circ}$ F of longitude per hour. Therefore all celestial bodies appear to move around the earth, from East to West at a rate of  $15^{\circ}$ H per hour.

### The Air Almanac

4. This publication is released three times a year by the Royal Greenwich Observatory. It contains all the astronomical data that you may need in order to use the celestial bodies. Each issue contains four months of data. The first volume of the year covers the period 1 Jan to 1 May inclusive, the second 1 May to 1 Sep inclusive, the third 1 Sep to 1 Jan inclusive.

5. Pages 1 to 242 cover the Greenwich days. The odd-numbered pages cover midnight till 1150 Greenwich Mean Time (GMT) and the even-numbered pages cover noon till 2350 GMT.

6. The top of each page gives the date and the weekday in GMT. Each celestial body which is available on that day is listed in a column. For the sun, the moon and the planets, there are two columns. The left column is labelled GHA (Greenwich Hour Angle) and the right column is labelled DEC (Declination). GHA and DEC correspond respectively to longitude and latitude on the earth. In other words, GHA is the celestial meridian of the body. On the earth, longitude is measured east and west from the Greenwich ( $0^{\circ}$ ) meridian, GHA is also measured from the Greenwich ( $0^{\circ}$ ) meridian but always westward. Latitude on earth is measured from  $0^{\circ}$  to  $90^{\circ}$  from the equator. DEC is measured in the same manner.

7. For the stars, we have only one column on the daily pages: that column is labelled ARIES. The reason for this is quite simple. It would require a huge volume to list the celestial meridian of each star in GHA. Since the stars appear fixed with respect to each other, we just established a reference meridian among the stars and we measure only the GHA of that reference meridian. The Celestial meridian used as a reference is referred to as the first point of ARIES. On the backside of the front cover of the air almanac you will find a list of the main navigational stars with their SHA (Siderial Hour Angle) and DEC. The SHA of a star is simply the angular

difference measured westward from ARIES to the celestial meridian of that star. It is considered nearly constant. The DEC is still the celestial latitude of the star.

Note: It is of the utmost importance that you always remember to use GMT in all your celestial work. GMT is five hours later than EST and six hours later than CST.

### **The Astro Compass**

8. The astro compass is an instrument designed for the purpose of integrating various astronomical data in order to display directional information to the user. It is not a sextant. A sextant is an instrument which gives the position of the observer by measuring the elevation of a celestial body above the horizon. A sextant does not display direction as readily as an astro compass.

9. Components (from bottom to top):

- a. a clamping device to hold the instrument firmly on a standard;
- b. two levelling screws;
- c. two cross levels to monitor the horizontal alignment;
- d. a bearing plate graduated from  $0^{\circ}$  to  $360^{\circ}$  which is free to rotate along with the instrument. It is the compass card of the astro compass;
- e. a Local Hour Angle (LHA) drum which is controlled by the Hour Angle knob. Note that on one side of the LHA drum you set LHA and you set True Bearing on the opposite side;
- f. opposite the Hour Angle knob is the latitude scale which is controlled by the adjacent latitude knob. Latitude is labelled in tens of degrees of latitude north or south;
- g. mounted on top of the Hour Angle drum is the declination scale from  $64^{\circ}$  south to  $64^{\circ}$  north.
- h. the sight assembly is attached to the DEC index and sweeps the latter in front of the DEC scale; and
- j. the sight assembly is made up of one open end with a shadow bar and two fluorescent markers. The opposite end is made up of a white plastic plate and lens. The open end is pointed at the celestial body.

Note: In the northern hemisphere, use only the white markings on the instrument. Disregard all the red markings.

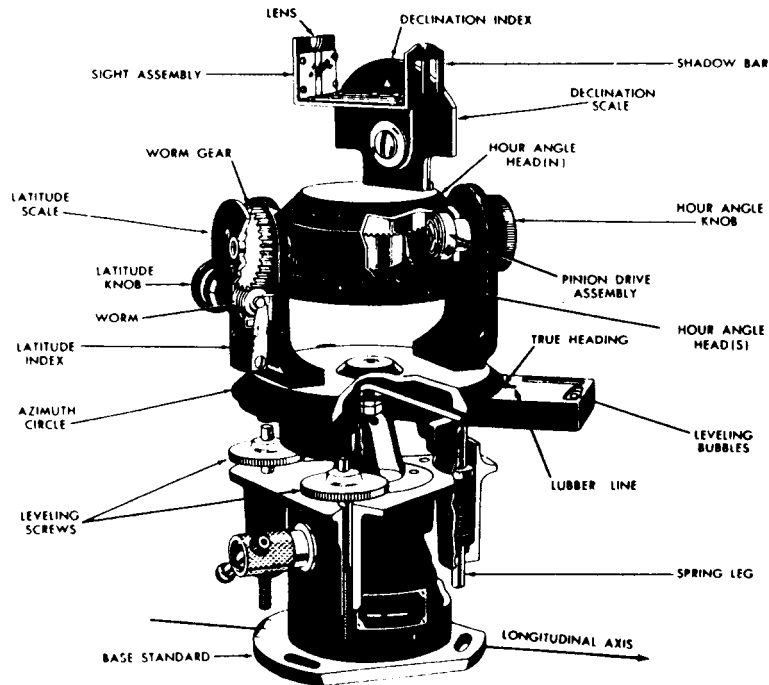

Figure C-1 Astro Compass

10. In order to determine your orientation with the astro compass, you must know:
  - a. the correct GMT;
  - b. your position in latitude and longitude;
  - c. the GHA of the body; and
  - d. the DEC of the body.
  
11. The astro compass requires three inputs to indicate your true direction:
  - a. LATITUDE of the observer;
  - b. LHA of the celestial body; and
  - c. DEC of the celestial body.

### Standard Operating Procedures

12. To operate the astro compass, the following procedure should be used:
  - a. Place the astro compass firmly in its mount.
  - b. Level the instrument using the levelling screws.
  - c. Using the Latitude knob set your latitude (in white).
  - d. Establish the time of your intended observation in GMT.
  - e. Using daily page of air almanac, compute LHA of body and note DEC.

For Sun, Moon, and planets:

LHA body = GHA body - Longitude

For stars:

LHA star = GHA ARIES SHA STAR - Longitude

- f. Using Hour Angle knob, rotate Hour Angle drum until your LHA can be read on the Hour Angle index.
- g. Set DEC on the DEC index (white) by moving the sight assembly up or down.
- h. At the computed time (GMT) rotate the bearing plate until the body is visible in the sight assembly. The bearing plate is now CORRECTLY ORIENTED.
- j. Without moving the instrument on the mount, set latitude  $90^\circ$  (9 in white).
- k. Set  $0^\circ$  DEC by moving the sight assembly.
- m. Using the Hour Angle knob set your desired TRUE COURSE against TRUE BEARING marker on Hour Angle drum.
- n. Using the sight assembly, you will have an aiming point on your horizon, along your intended TRUE COURSE.
- p. Repeat operation for improved accuracy.

### Using The Sun

13. The sun is ideally suited for heading determination since it is quite easy to recognize and it is not concealed by clouds as easily as the stars or the planets. The sun is basically responsible for the seasons. The seasons are directly related to the sun's DEC.

21 MARCH: DEC  $0^\circ$  (SPRING)

21 JUNE: DEC  $23\text{-}1/2^\circ$  NORTH (SUMMER)

21 SEPTEMBER: DEC  $0^\circ$  (FALL)

21 DECEMBER: DEC  $23\text{-}1/2^\circ$  SOUTH (WINTER)

14. The only time when the sun rises directly east and sets directly west is on or near March 21 and September 21. In the spring and summer the sun rises in the north-east and sets in the north-west. In the fall and winter, the sun rises south-east and sets south-west. However, there are two simple methods to estimate your orientation through time using the sun as a reference. Remember that at noon, the sun is south ( $180^\circ$ ). The sun, like other celestial bodies, travels at  $15^\circ$  per hour. Therefore for each hour short of 1200 (noon) the sun is  $15^\circ$  east of  $180^\circ$ . For each hour in excess of 1200 (noon), the sun is  $15^\circ$  of  $180^\circ$ .

Example: at 0900 the sun is  $3 \times 15^\circ = 45^\circ$  East of  $180^\circ$  or  $135^\circ$  azimuth.

15. Another method is to compute the sun's LHA and subtract  $180^\circ$  from that figure. Therefore, the reciprocal of the LHA is close to the actual azimuth. The sun can also give you your latitude if you observe the angle it makes with the horizon at sunrise. The angle is equal to  $90^\circ$  minus your latitude.

Example:     the sun rises at  $22^\circ$   
               $90^\circ - 22^\circ = 68^\circ$  latitude north.

16.     If you use the astro compass on the sun, use the shadow cast by the shadow bar on the white plastic plate.

### Using The Moon

17.     The moon, like the sun, is quite easy to recognize. However, unlike the other celestial bodies, it does not travel westward at  $15^\circ$  per hour. It is somewhat slower because of its easterly orbital motion. The moon rises by an average of 50 minutes later each day. Therefore, if you know the phase of the moon, you can predict the moonrise and moonset times and also the moon's azimuth fairly accurately:

	MOON RISE	MOON SET	AZIMUTH
NEW MOON:	sunrise	sunset	same as sun's
FIRST QUARTER:	noon	midnight	$90^\circ$ east of sun's
FULL MOON	sunset	sunrise	$180^\circ$ west of sun's

18.     The moon's declination varies between  $28\ 1/2^\circ$  north to  $28\ 1/2^\circ$  south. When you use the moon, try to aim at the center of the disc or where the center ought to be.

### Using The Planets

19.     Only four planets are suitable for our purpose. These are; Venus, Mars, Jupiter, and Saturn. Venus is either visible as a morning planet (before sunrise) or as an evening planet (after sunset). As a morning planet it is in the south-east, as an evening planet, south-west. Venus is never more than 3 hours or  $45^\circ$  away from the sun. Venus is the brightest celestial body after the sun and the moon.

20.     The other planets are visible in the night sky only. They are used like the moon and their DEC ranges normally from  $15^\circ$  north to  $15^\circ$  south.

21.     Jupiter looks like a very distant full moon. In the summer evening sky, three or four of the Jovian satellites are visible to the unaided eye.

22.     Mars is a reddish planet looking perhaps like a distant tangerine orange.

23.     Saturn appears very much like a star. It is yellowish in colour but displays a steady glow unlike the stars.

Note: In the Arctic, a steady shining celestial body is not necessarily a planet. Indeed, the cool air may make most stars appear like planets.

## Using The Stars

24. The stars, because of their incredible number, will always present a challenge to most observers. Their DEC's range from  $90^\circ$  north (Pole Star) to  $0^\circ$  and almost all the way to  $90^\circ$  south although there is no Pole Star at the South Pole. The significance of POLARIS, (the Pole Star) has long been recognized. The elevation of POLARIS above the northern horizon is equal to the observer's latitude. Indeed, at the equator, POLARIS is on the northern horizon and at the North Pole, POLARIS is directly overhead, at  $90^\circ$  elevation. Furthermore, the early navigators noticed that the direction to POLARIS was remaining constant through the night and they used it as a heading reference. The migrating birds make constant use of POLARIS. Without POLARIS they are hopelessly lost. However, in the Canadian Arctic, POLARIS is of little use since it is almost directly overhead.

25. There are two primary star patterns which are easy to recognize and these two suffice to find all other stars. In the arctic, there is seldom a problem of finding the MILKY WAY. It is always there, very bright. As one looks at the MILKY WAY, the rim of the Home Galaxy, he will come upon a group of bright stars shaped like a "W". This constellation is called CASSIOPEIA. It contains two stars of interest. One of them, SCHEDAR (number 3), is the star at the bottom right side of the "W", and is the brightest star in the constellation. The star that terminates the "W" on the upper right hand side is also very significant. It is not used as a navigational star, however it defines for you the direction to the first point of ARIES from which the SHA of every star is measured. As you depart from CASSIOPEIA in the direction of the open end of the "W", you will come to a large "dipper" shaped constellation of bright stars. It resembles a frying pan with a bent handle. It is called the BIG DIPPER. The air almanac will tell you which stars may be used in this constellation. Now join the stars at the extreme ends of the BIG DIPPER, diagonally, to the stars at the extreme ends of CASSIOPEIA, you will cross the two imaginary lines very close to POLARIS in the SMALL DIPPER. If you can locate CASSIOPEIA, the BIG DIPPER, and POLARIS, you can find your orientation very easily if you know the date and the standard time.

26. First of all, remember that the stars move westward (or counterclockwise around POLARIS at a rate of  $15^\circ$  per hour. It is a known astronomical fact that each day the stars rise 5 minutes earlier. This is due to the earth's motion along its solar orbit. As a result, if you look at the sky at midnight two days in a row, you will notice (if you can measure it), that the stars are  $1^\circ$  west of the previous night's position. Therefore, every month, the sky turns by  $30^\circ$ . Every season the sky turns by  $90^\circ$ . If you establish a reference position in the sky on a certain date, you can define your orientation on any day of the year providing you observe the sky at the same time of the night.

27. As a reference use midnight (Standard Time) on March 21. The BIG DIPPER is then in the south and CASSIOPEIA is above the northern horizon. On June 21, 3 months later, CASSIOPEIA is directly east. On September 21, CASSIOPEIA is south, on December 21,

CASSIOPEIA is directly west. For each hour prior to midnight imagine stars  $15^\circ$  further east than midnight. For each hour after midnight, imagine the stars  $15^\circ$  further west than at midnight.

Note: Remember that you must compensate for the orbital motion of the earth first ( $1^\circ$  west per day). Then you compensate for the daily rotation ( $15^\circ$  per hour).

28. Another problem that may puzzle the observer is to define which stars will always be above or below the horizon and which stars rise or set through the night. Only two factors must be considered:

- a. the observer's latitude; and
- b. the star's DEC.

Example: Subtract your latitude from  $90^\circ$ : if I am at  $70^\circ\text{N}$ ;  $90^\circ - 70^\circ = 20^\circ$  therefore, all the stars whose DEC is north of  $20^\circ$  north, will always be above the horizon, at the stars south of  $20^\circ$  south will never be visible and those between  $20^\circ\text{N}$  and  $20^\circ\text{S}$  will rise and set.

## Conclusion

29. The astro compass is generally accurate within  $2^\circ$  if all settings and adjustments are correct but the accuracy will be consistently within  $1^\circ$  if certain precautions are taken:

- a. Use a celestial body close to the horizon, when this is possible.
- b. Make a habit of doing the calculations, settings, and course finding adjustments twice in order to increase the confidence in your results.
- c. At night, go through the procedures two or three times in a row using different celestial bodies. If your sight keeps pointing at the same point on your horizon, the odds are that your work was done correctly.
- d. Always MONITOR THE LEVELS BEFORE EACH READING.

30. If you have set the LHA Body, DEC Body, and your LAT on the astro compass and you do not succeed in lining up the desired body in the sight assembly by turning the bearing plate only:

- a. check levelling;
- b. read all calculations (check for extraction errors);
- c. check your settings of LHA and DEC;
- d. check your latitude;
- e. check your GMT;
- f. Check if the body is likely to be above the horizon;
- g. check that you have the right celestial body; and
- h. check if your instrument is damaged.



31. Remember that if your calculations and your settings are correct, your instrument is serviceable and levelled, and your time is accurate; all you need is to rotate the bearing plate in azimuth to obtain perfect alignment with the desired body.

32. Keep your work simple by calculating for times such as 0100, 0110, 0120, etc. Watch your additions and subtractions of degrees and minutes.

33. It is recommended that all potential users of the astro compass become familiar with the Air Almanac. Particular reference should be made to pages A4 to A25.

### **References**

Training Command Publication No. 13, Chapter 254, The Astro Compass.

The Air Almanac (A.P. 1602).

The Observers Handbook, The Royal Astronomical Society of Canada.

CFP 139(1), Part Two, Celestial Navigation and Guidance and Control.

## MAINTENANCE UNDER WINTER CONDITIONS

### General

1. Maintenance under winter conditions is a necessary and time consuming task. If operations become prolonged, it can be expected that maintenance will consume a high proportion of the total support attached to a task force.
2. Units must plan their winter maintenance programme and maintain constant supervision over all maintenance activities.
3. The winter operating and maintenance procedures for vehicles are contained in their respective operator's manuals.

### Preliminary Considerations

4. Heaters
  - a. Personnel compartment and engine coolant heaters are now available for most military vehicles. Not every vehicle will require an engine coolant heater, however consideration should be given to equipping vehicles which normally operate independently. One running vehicle can be used to slave the electrical systems of other cold-soaked vehicles which have not been equipped.
  - b. All heaters must be specifically inspected, and overhauled as necessary, prior to the commencement of winter operation. Faulty heaters can cause discomfort, hardship, casualties, and accidents. A working heater will increase operational effectiveness.
  - c. Herman-Nelson heaters provide the heat necessary to stimulate the productivity of personnel in cold weather, but they are also a high risk fire hazard. A course of instruction is required for all potential operators, and laid down procedures must be followed when servicing this equipment.
  - d. Regulations require that any vehicle which does not have a proper windshield defroster, must have frost shields to prevent icing which might obscure the driver's vision.
5. Winterization
  - a. Low viscosity lubricants are a necessity for most equipment. The Operator's Manual is the guide to specific requirements, supplemented by EME Instructions, and special procedures on staff direction. Advice is always available through maintenance channels when specific direction is required.
  - b. Anti-freeze is vital to prevent the freezing of engine coolants. Protection to - 60°F to - 90°F is a necessity, and strength must be checked regularly because of the

leakage which occurs in coolant systems. Low strength anti-freeze will sludge in extreme cold, and cause overheating and boiling of the coolant.

6. Shelters. In cold weather, with a high windchill factor, it will be very difficult for personnel to perform maintenance operations unless they have a proper windbreak. Tentage and heat greatly increase their effectiveness, therefore, every effort should be made to provide an adequate form of maintenance shelter.

7. Personnel. The maintenance workload can be expected to be greater than normal, therefore, the maximum number of maintenance personnel should be made available for winter operations.

## **Unit Maintenance**

8. Operators. Maintenance problems can be minimized with vigorous supervision of equipment operators. Proper cold-weather starting techniques, warm-up, driving, gear selection, route choice, servicing, inspection, and fault reporting procedures will result in a continued high level of operational readiness.

9. Lubrication. Maximum lubricant penetration is effected when a bearing surface is still warm. Lubrications should be carried out immediately after equipment has been operating.

10. Optical Equipments. Sudden or extreme changes of temperature can cause severe damage to optical equipment. Warn personnel to exercise caution.

### 11. Self-recovery

- a. All vehicles should be equipped with chains, a shovel, sand, a tow cable, and other self-recovery aids.
- b. Winches should be checked for serviceability, and spare shear pins carried in the glove compartment of vehicles. The use of a bolt or nail for a shear pin can cause unwarranted damage to the winch casing.

### 12. Fuel

- a. Condensation of moisture inside fuel tanks can be minimized by refilling immediately after stopping for the night.
- b. Fuel may freeze in gas lines and fuel strainers because of water in the system. Denatured alcohol in the proportion of 1 quart to 30 to 50 gallons of gasoline may be necessary to prevent undue trouble.
- c. Keep fuel containers tightly closed to prevent condensation.

### 13. Batteries

- a. Battery capacity is severely decreased at low temperatures. Every effort should be made to keep them warm, or to warm them prior to operation.

- b. Batteries can be carried inside clothing or in insulated containers. Heating devices can be used, but temperatures should not exceed 100°F.
  - c. Charging should not be attempted under - 20°F, and high charging rates must be avoided because of excessive gassing from cold batteries.
14. Shafts. Excessive oil or grease can hamper the operation of shafts on cameras, telephones, and other devices in cold weather. Low speed shafts can be wiped dry (with discretion), but prolonged use may cause undue wear.
15. Brakes. To prevent vehicle brakes from freezing, the wheels should be chocked instead of setting the hand brake, whenever possible.
16. Oil Consumption. It can be expected that low viscosity engine lubricants will leak past piston rings and seals. Operators must check lubricant levels more frequently than normal.
17. Rubber. Rubber products can be expected to become stiff and brittle. Cables and hoses should be flexed slowly and carefully to minimize cracking. Rubber should be warmed prior to laying if at all possible. Frequent failures can be expected, especially in lines which have been reeled up while cold. Abnormal usage of rubber products should be anticipated.
18. Radios. Cold may cause radios to change frequency calibration, and low battery voltage will reduce the capability. Operators should make regular checks to maintain proper frequency.
19. Microphones. Moisture from the breath freezes on the button and perforated cover plates of microphones, causing the instrument to become inoperative. Covers should be used if available. Thin cellophane or a cloth membrane is an improvisation.
20. Malfunctions. Plugs, jacks, keys, shafts, bearings, dials, switches, and camera shutters are subject to malfunctions. Binding, difficulty in turning or adjusting, or complete locking may be experienced. These malfunctions can be caused by differential contraction of metals, moisture condensation (freezing), or hardened lubricant. DO NOT force the equipment to operate - severe damage may occur. The problem can usually be alleviated by warming the equipment.
21. Breathing and Sweating
- a. Any equipment which generates heat will usually create a flow of cold air which can cause breakage of hot glass, plastic, or ceramic parts'
  - b. When warm air passes over cold parts, moisture condenses to create "sweating". Cold equipment should be wrapped in a blanket before being moved into a heated shelter.
22. Insulating Tape. Normal insulating tape is inadequate at low temperatures. Special cold-weather insulating tape is required for wire splicing.
23. Miscellaneous Equipment. Individuals should be trained to make minor repairs on special items such as sleds, skis, tents, stoves, lanterns, and snowshoes.

24. Ether. The use of ether is a specialized technique for engine starting which must not be used by operators. Regulations prevent general use because of the severe damage and danger which result from an excessive charge.
25. Slave Cables. It is recommended that approximately one out of three vehicles be equipped with a slave cable. One operational vehicle can start others if a cable is available.
26. Engine Coolant Heaters. The engine coolant heater is a fuel consuming device which also drains current from the vehicle batteries. Heaters must not be permitted to exceed the recommended time of operation, otherwise the engine may not start.
27. Carbon Monoxide. The vehicle exhaust contains a poisonous gas. The vehicle inspectors must continually check for leaks in exhaust systems. The exhaust fumes (which contain carbon monoxide) must not be used to directly warm personnel.
28. Chains
- a. Tire chains should be reserved for difficult driving conditions, and should be removed as soon as possible to prevent excessive tire wear.
  - b. They should be installed properly, in accordance with the Operator's Manual for the vehicle, and inspected frequently during operation.
  - c. When a link breaks, the operator must stop and repair the broken link immediately.
  - d. Chains must not be installed on the front wheels of vehicles. Broken cross chains can cause a vehicle to flip. When mounted on the front wheels of 2-1/2-ton trucks, they cause excessive sprag clutch wear and power train damage.
29. Tire Pressure. Reduced tire pressures will increase tractive effort and vehicle control on ice and snow. Authorized tire pressures are as follows for mud, sand, and snow:
- a. 1/4 ton - 15 psi.
  - b. 3/4 ton - 15 psi.
  - c. 2-1/2 ton - 35 psi.

(Tires must be re-inflated before driving on highways at high speed.)

## **Repair**

30. When practical, second line (field) repair will be carried out in situ by a Mobile Repair Team. It should be appreciated that technicians working in extreme cold may require abnormal time to complete even minor repair tasks, therefore, consideration should always be given to providing shelter and heat, or backloading a casualty, where possible.
31. The second-line maintenance facility will normally have some measure of protective shelter for the relatively rapid repair of priority equipments.

32. Since standard repair times may be increased by a factor of up to five depending on the weather conditions and lack of facilities, it will be very difficult for the, field maintenance element to provide normal operational support.

### **Spare Parts**

33. It can be expected that re-supply of spare parts will be slower than normal. The spare parts element should carry a higher than normal float level on all stocks, but the lift capability may not permit the desirable holding. Units must start operations with their full entitlement of spare parts, plus increased holdings of items which are anticipated to be high usage requirements in cold weather.

34. Immediate operational requirement (IOR) procedures must be available for re-supply of critical spare parts.

### **Recovery**

35. Normal recovery support can be provided, however self-recovery aids should be employed before assistance is requested. Better driving practices can reduce recovery requirements.

### **Summary**

36. Maintenance under winter conditions is not impossible, but it will be difficult. Maintenance elements are designed to support the operational forces, and they will provide that support. However, maintenance starts with the user, and everyone must do his share of the work. Adequate preparation, careful operation, proper servicing, and vigilant maintenance will ensure that maximum operational readiness is attained.

37. Every unnecessary requirement must be avoided, and every expedient utilized to reduce wasted effort. Preventive maintenance is all important, since equipment failure can jeopardize accomplishment of an operational mission.

### **REFERENCES**

1. The following publications are related to and should be used in conjunction with this manual:

- a. B-GG-302-002/FP-002 Specific Operations, Volume 2, Arctic and Subarctic Operations, Part 2 - Northern Operations,
- b. B-GG-302-002/FP-003 Specific Operations, Volume 2, Arctic and Subarctic Operations, Part 3 - A Soldier's Guide to the Cold; and
- c. Branch tactical manuals.

# **SPECIFIC OPERATIONS**

## **VOLUME 2**

### **ARCTIC AND SUBARCTIC OPERATIONS**

#### **PART TWO**

#### **NORTHERN OPERATIONS**

(This publication supersedes CFP 302(2) Part Two dated Jan 74)

THIS PUBLICATION CONTAINS CLASSIFIED INFORMATION AFFECTING THE DEFENCE OF CANADA, AND SHALL BE PROTECTED IN ACCORDANCE WITH THE REGULATIONS PRESCRIBED FOR THE SECURITY CLASSIFICATION APPEARING HEREON. RELEASE OF THIS PUBLICATION, OR INFORMATION CONTAINED HEREIN, TO ANY PERSON NOT AUTHORIZED TO RECEIVE IT IS PROHIBITED BY THE OFFICIAL SECRETS ACT.

**OPI: DLP 4**

**14 Jan 77**

**ISSUED ON AUTHORITY OF THE CHIEF OF THE DEFENCE STAFF**

## LIST OF EFFECTIVE PAGES

Insert latest changed pages; dispose of superseded pages in accordance with applicable orders.

NOTE - On a changed page, the portion of the text affected by the latest change is indicated by a vertical line in the margin of the page. Changes to illustrations are indicated by miniature pointing hands, or black vertical fines.

Total number of pages in this publication is 229 consisting of the following:

<b>Page No.</b>	<b>Change No.</b>
Cover	0
Title Page	0
A	0
i to xvii	0
1-1 to 1-16	0
2-1 to 2-18	0
3-1 to 3-12	0
4-1 to 4-9	0
5-1 to 5-15	0
6-1 to 6-13	0
7-1 to 7-9	0
8-1 to 8-9	0
9-1 to 9-21	0
10-1 to 10-13	0
11-1 to 11-25	0
12-1 to 12-21	0
A-1 and A-2	0
B-1 and B-2	0
C-1 and C-2	0
13-1 to D-6	0
E-1 to E-5	0
F-1 to F-10	0
GL-1 to GL-7	0

Zero in Change No. column indicates an original page.



## **FOREWORD**

1. B-OG-302-002/FP-002, Specific Operations, Volume 2, Arctic and Subarctic Operations, Part Two, Northern Operations, is issued on authority of the Chief of the Defence Staff.
2. B-OG-302-002/FP-002 replaces CFP 302(2), Part Two, Units and Formations, dated January 1974.
3. Any loss or suspected compromise of this publication or portions thereof, shall be reported in accordance with CFP 128(1), Chap 60.
4. Suggestions for changes should be forwarded through the usual channels to Mobile Command Headquarters, Attention SSO Doctrine.

## **PREFACE**

1. Volume 2 of this publication is published in three parts:
  - a. Part One, Basic Cold Weather Training - Describes in detail the drills and training required for the individual soldier and infantry section (or equivalent) to operate in winter.
  - b. Part Two, Northern Operations - Provides guidance for land and tactical air doctrine for operations.
  - c. Part Three, A Soldier's Guide to the Cold - A summary of Part One in informative, informal style. Designed as a pocket book for ready reference in the field.
2. Part Two contains much more 'how to' information than the manual it will replace. It is more oriented to the Canadian north and the capabilities of the Canadian Forces, but this does not preclude its use in other theatres.

## **TABLE OF CONTENTS**

### **CHAPTER 1 - INTRODUCTION**

#### **Section 1 - General**

Aim  
Scope

#### **Section 2 - Area of Operations**

General  
The Arctic  
The Subarctic  
The Arctic Ocean

#### **Section 3 - Concept of Operations**

General  
The Threat  
Canadian Northern Operations  
Mounting of Operations

#### **Section 4 - Organization**

Grouping  
Command and Composition

### **CHAPTER 2 - THE ENVIRONMENT**

#### **Section 1 - Introduction**

General  
Operating Conditions

#### **Section 2 - Climate**

General  
The Arctic  
The Subarctic  
Special Problems

### **Section 3 - Terrain**

General  
The Arctic  
The Subarctic

### **Section 4 - Infrastructure**

General  
Problem Areas  
Development

### **Section 5 - Effect on Military Operations**

Leadership  
Mobility  
Firepower  
Logistics

## **CHAPTER 3 - FACTORS AFFECTING MOVEMENT**

### **Section 1 - Introduction**

General

### **Section 2 - Movement on Foot**

Scope  
Individual Load  
Mobility Aids

### **Section 3 - Vehicle Movement in Winter**

General  
Effects of Deep Snow  
Ice Crossings

### **Section 4 - Vehicle Movement in Other Seasons**

Spring Break-Up  
Summer  
Fall Freeze-Up

## **Section 5 - Vehicle Operating Techniques under Extreme Cold Conditions**

Driving  
Parking  
Starting  
Crew Comfort

## **CHAPTER 4 - FIRE SUPPORT**

### **Section 1 - Introduction**

General  
Ice Fog

### **Section 2 - Direct Fire Weapons**

Anti-personnel Weapons  
Anti-armour Weapons

### **Section 3 - Indirect Fire Weapons**

General  
Fire Control Procedures  
Movement  
Gun and Base Plate Positions  
Observation  
Ammunition  
Artillery Survey  
Mortars

### **Section 4 - Offensive Air Support Weapons**

General

## **CHAPTER 5 - ENGINEERING**

### **Section 1 - Introduction**

General

### **Section 2 - Defences and Obstacles**

Field Defences  
Mines and Mine Warfare

### **Section 3 - Maintenance of Mobility**

Roads and Tracks  
Ice Roads  
Bridges  
Ferries  
Fords

### **Section 4 - Construction of Airfields**

General  
Construction Site Criteria  
Runways on Snow  
Runways on Ice  
Preparation of Landing Sites for Helicopters  
Problems of Heavy Equipment Operators

### **Section 5 - Water Supply**

Supply  
Transportation

### **Section 6 - Base Installations**

Air Portable Modules  
Heated Accommodation

## **CHAPTER 6 - COMMUNICATIONS**

### **Section 1 - Introduction**

General  
Environmental Problems

### **Section 2 - Radio Communications**

Propagation Characteristics  
Auroral Effect  
Ionospheric Disturbance  
Atmospheric Static  
Antennae and Grounds  
Batteries and Power Supplies  
Electronic Warfare  
Tactical Nets

### **Section 3 - Line Communications**

General  
Laying Line

### **Section 4 - Visual Communication**

General

### **Section 5 - Hand Carriage**

Air  
Vehicles

### **Section 6 - Peculiar Operating Procedures**

General  
Mechanical Malfunctions  
Radios  
Microphone Assemblies  
Breathing and Sweating  
Rubber and Rubber Like Compounds  
Supply

## **CHAPTER 7 - TACTICAL AVIATION**

### **Section 1 - Introduction**

General  
Weather

### **Section 2 - Flight Operations**

General  
Planning Factors  
Navigation  
Safety

### **Section 3 - Aircraft Maintenance and Facilities**

Maintenance  
Facilities

## **Section 4 - Characteristics of Aircraft**

General  
Light  
Intermediate  
Heavy  
Helicopters  
Fighters

## **CHAPTER 8 - OPERATIONS - GENERAL**

### **Section 1 - Introduction**

General

### **Section 2 - Planning**

Factors

### **Section 3 - Intelligence**

Essential Elements of Information  
Other Intelligence Requirements  
Intelligence Collection  
Battle Indicators  
Patrolling  
Deception

### **Section 4 - Security**

General  
Camouflage  
Concealment  
identification

## **CHAPTER 9 - OPERATIONS**

### **Section 1 - Introduction**

Scope

### **Section 2 - Offensive Operations**

General  
Planning  
The Deliberate Attack



Reorganization  
Exploitation and Pursuit

### **Section 3 - Defensive Operations**

General  
Planning Considerations  
Conduct of the Defence  
Location of Reserves

### **Section 4 - Retrograde Operations**

General  
Planning Factors

### **Section 5 - Particular Tactics**

General  
Composition of Forces  
Location and Engagement  
Containment  
Harassment  
Destruction  
Resupply  
Rotation of Troops and Equipment

### **Section 6 - Airmobile and Operations**

General  
Conduct of Operations

### **Section 7 - Chemical and Nuclear Operations**

Chemical Operations - General  
Toxic Chemical Agents  
Protective Measures  
Smoke  
Nuclear Operations - General  
Protection  
Monitoring and Survey

## **CHAPTER 10 - OPERATIONS - SPECIAL**

## **Section 1 - Introduction**

General

## **Section 2 - Airborne Operations**

Scope

Limitations

Selection of Drop Zones and Landing Zones

Forms of Assault

Special Considerations for Paratroop Assault

Conduct of the Assault

Summer Considerations

## **Section 3 - Amphibious Operations**

General

Limitations

## **Section 4 - Riverine Operations**

General

Characteristics of Northern Inland Waterways

Limitations

## **Section 5 - Raids and Rear Area Operations**

General

Tasks

Selection of Personnel

## **Section 6 - Operations on Permanent Ice and Snow-Covered Areas**

General

Equipment

## **CHAPTER 11 - ADMINISTRATION**

### **Section 1 - Introduction**

General

### **Section 2 - The Logistic Concept**

Mounting

Forward Base

Airhead  
Holdings  
Distribution  
Maintenance

### **Section 3 - Logistic Planning**

General  
Preparation Prior to Deployment  
Local Resources  
Siting of Administrative Areas  
Rear Area Security

### **Section 4 - Transportation**

General  
Air  
Road  
Off Road  
Traffic Control  
Rail  
Water

### **Section 5 - Supply**

General  
Stock Levels  
Storage  
Distribution  
Laundry and Bath

### **Section 6 - Maintenance**

General  
Maintenance Personnel  
Preventive Maintenance  
Winterization/Articization  
Recovery  
Miscellaneous Tasks

### **Section 7 - Medical**

General  
Medical Installations  
Treatment  
Evacuation

Medical Standards  
Cold Casualties

### **Section 8 - Personnel Matters**

Replacement  
Morale and Discipline  
Prisoners of War  
Burial  
Salvage/Garbage  
Canex Supplies

## **CHAPTER 12 - TRAINING**

### **Section 1 - Introduction**

General  
Training Objective  
Training Areas  
Instructor Requirement

### **Section 2 - Characteristics of Seasonal Exercises**

Winter  
Spring Break-Up  
Summer  
Fall Freeze-Up

### **Section 3 - Cold-Weather Training**

General  
Training Emphasis  
Training Phases  
Indoctrination Training at Home Stations  
Specialist Training at Home Stations  
Preliminary Training in Exercise Area

### **Section 4 - Warm-Weather Training**

General  
Training Phases  
Indoctrination Training at Home Stations  
Specialist Training at Home Stations

## **Section 5 - Restrictions on Training**

General  
Land-Use Regulations  
Wildlife  
Weather  
Local Population  
Food and Sundries

## **Section 6 - Coordination with Government and Other Local Agencies**

Northern Region  
Federal Agencies  
Territorial Government  
Annual Resupply Programmes

## **Section 7 - Planning for Exercises**

General  
Scope  
Pre-exercise Training  
Recce of Exercise Area  
Tactical Exercises without Troops  
Exercise Security

## **ANNEXES**

- A     Equipment Operating Techniques
- B     Assessment of the Enemy - Northern Operations
- C     Battle Indicators
- D     Commanders' Guide Lines for Northern Operations
- E     Lessons Learned
- F     Notes on Russian and Finnish Winter Warfare Tactics

## **GLOSSARY OF TERMS**

## LIST OF FIGURES

<b>FIGURE</b>	<b>TITLE</b>
---------------	--------------

- |     |   |
|-----|---|
| 1-1 | Map of Northern Canada and Neighbouring Countries with Inset of Northern Europe |
| 1-2 | Arctic and Subarctic Regions  |
| 1-3 | Diagrammatic Layout Base System for Mounting Operations                         |
| 1-4 | Battle Group for Arctic Operations  |
| 1-5 | Battle Group for Subarctic Operations (Canadian Scenario!)                      |
| 1-6 | Company Group for Northern Operations   |
| 2-1 | Mean Windchill Factor in January  |
| 2-2 | Mean Windchill Factor in July   |
| 3-1 | Vehicle Turn-off  |

## LIST OF TABLES

<b>TABLE</b>	<b>TITLE</b>
2-1	Windchill Cooling Rates
5-1	Guide to Load Bearing Capacity of Fresh-Water Ice
5-2	Rate of Growth of Fresh-Water Ice per Degree-days of Frost
11-1	Classification of Vehicles

# CHAPTER 1

## INTRODUCTION

### SECTION 1 - GENERAL

#### **Aim**

1. To provide the tactical doctrine for all season operations in the north.

#### **Scope**

2. This manual discusses the northern area of operations, and the unique concepts required to operate in that environment. It covers the spectrum from foot patrols to mechanized operations within the context of a brigade group. Those special aspects of communication, engineering, and tactical aviation are highlighted prior to discussing their use in a tactical setting. The all important factor of administration is discussed in some detail as is the type of training required for northern operations.
3. Throughout the manual the emphasis is on the environment - how it can be used in our favour and against the enemy, as well as the problems it presents to us. Mobility is a factor of prime importance, and a great deal of stress is placed on means of improving our movement techniques, no attempt is made to reiterate doctrine where it does not differ from conventional operations, indeed a thorough understanding of conventional doctrine is necessary before study this manual.



## SECTION 2 - AREA OF OPERATIONS

### General

4. The area of northern operations for the purpose of the manual, is defined as those areas which lie north of the temperate zone where environmental conditions require the application of special techniques and equipment. About 45 per cent of the North American continent and 65 per cent of the Eurasian land mass lie in this area. The land mass contains mountainous regions, open, flat or rolling country, and light to heavily wooded areas. This area is snow covered for periods of weeks, months or even continuously. In the mountainous regions, areas of permanent ice fields or glaciers are common. The Arctic Ocean has heavy ice conditions with ice islands encountered north of latitude 70°. See Figure 1-1 for map of Northern Canada.

### The Arctic

5. For military purposes, the arctic is defined as that region in which the average temperature in the warmest month is less than 10°C and the mean annual temperature is below 0°C. This definition describes the area north of the tree line, although small patches of trees may be found there as a result of drainage patterns and southern exposures. The northern limit of trees is generally restricted to 1° or 110 kilometres (km) (60 nautical miles) north of the tree line. See Figure 1-2 for map of arctic area.

6. The factors that characterize the arctic in relation to other geographical regions are:
- a. location in the higher latitudes of the northern hemisphere;
  - b. reception of less solar radiation and hence, less warming because of the oblique angle of incident solar radiation;
  - c. mean temperature substantially lower than those of temperate regions;
  - d. the absence of trees;
  - e. an area consisting mainly of an ice-covered ocean and contiguous seas;
  - f. wide ranges of duration of daylight and darkness;
  - g. many areas receiving no more precipitation than most deserts;
  - h. permafrost (permanently frozen ground) preventing drainage, and resulting in many lakes, rivers, and poorly drained areas;
  - j. long periods of reduced visibility due to blowing snow, ice crystals or fog; and
  - k. complete snow cover which, because of the barren ground, changes the appearance of the terrain.

7. The Canadian arctic, which includes the Canadian Arctic Archipelago, contains the largest amount of land in the arctic. The Canadian arctic is 32 per cent of the total area of Canada. Greenland (Danish) is completely within the arctic and is the largest island land mass. Only a small portion of Alaska, Norway, and the Soviet Union is classed as true arctic.

### **The Subarctic**

8. The subarctic for military purposes may be defined as the vast area of climatic transition between the temperate regions and the arctic. The main difference between the arctic and the subarctic is that the subarctic is the home of the coniferous forest or tiaga land. See Figure 1-2.

9. The factors that differentiate the subarctic from other geographical regions are:

- a. the dominating presence of coniferous trees;
- b. the higher precipitation than arctic areas;
- c. areas of discontinuous and continuous permafrost preventing drainage, and resulting in many lakes, rivers, and poorly drained areas;
- d. extremes of temperature in excess of  $-57^{\circ}\text{C}$  in the winter and  $32^{\circ}\text{C}$  in the summer are common;
- e. wind velocity is Generally low with many periods of cold, calm weather in winter, and extreme hot weather in summer;
- f. heavy, late winter snowfall;
- g. spring break-up producing much local flooding; and
- h. fall freeze-up resulting in freezing from the surface down, and freezing from the permafrost level up - resulting in corresponding difficulty with mud.

10. Subarctic Canada embraces most of the forested areas but the main part is north of the more densely populated areas of eastern Canada, and to a lesser degree of western Canada. Northern Europe, and most of Alaska and the Soviet Union are within the subarctic. The subarctic is a primary area for exploitation and development because of its resources, and their accessibility by a rapidly developing transportation system.

### **The Arctic Ocean**

11. The Arctic Ocean surrounds the North Pole and is bordered by Canada, Alaska, Greenland, Europe, and Asia. Its unique feature is the presence of almost continuous ice cover. Throughout the winter, there are breaks in the pack ice, called leads, which are continuously opening and closing exposing areas of relatively warmer water to cold temperature. In summer,

the contrast between the colder ice and water and the overlying warmer air causes low, stratus cumulus clouds which can inhibit flying both in the arctic basin and its surrounding islands.

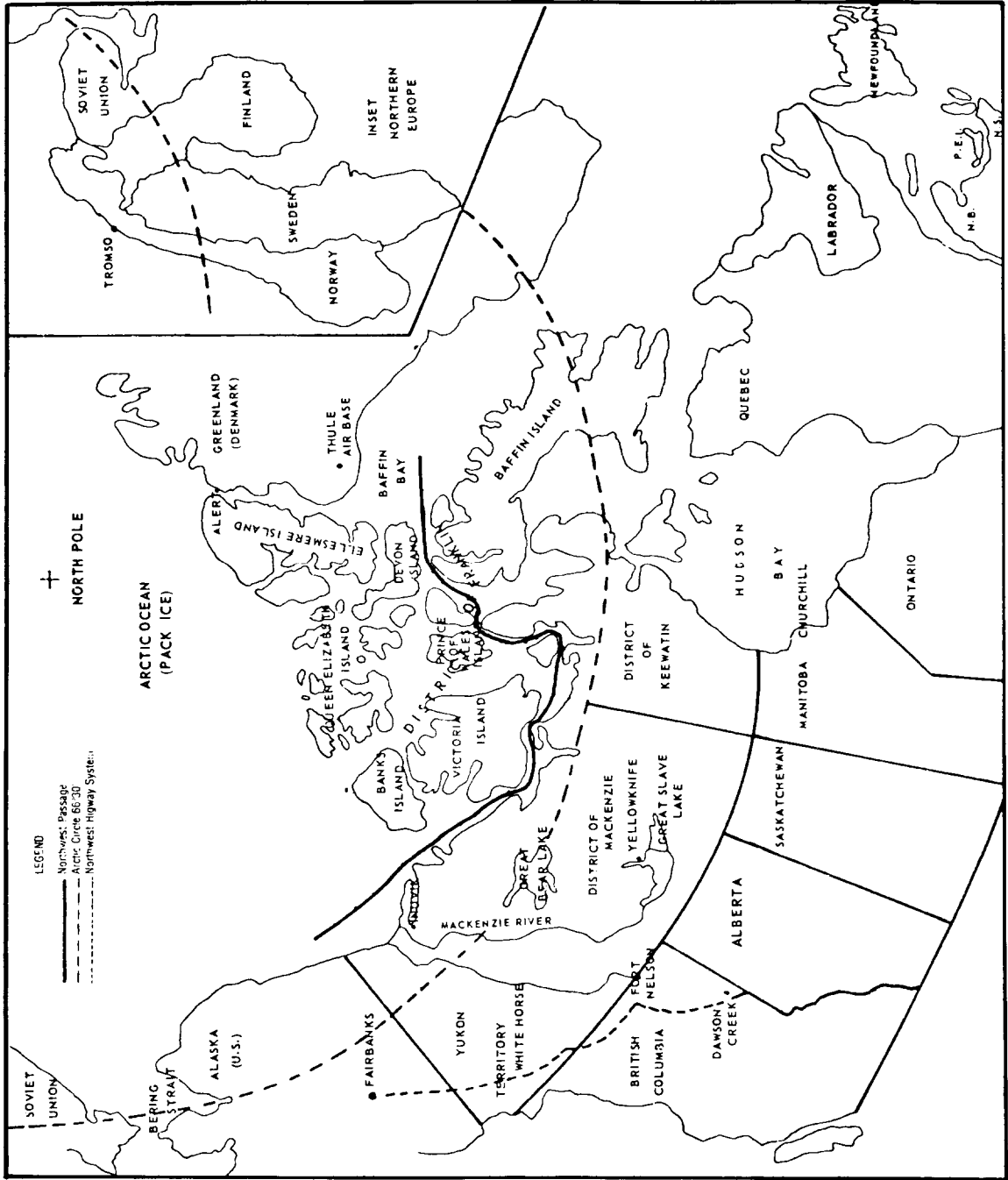

Figure 1-1 Map of Northern Canada and Neighbouring Countries with Inset of Northern Europe

12. Ice islands are very extensive pieces of fresh-water ice that circulate in the central Arctic Ocean. They may be up to tens of kilometres in linear dimension, and have a height of 7 metres (m) or more (23 feet (ft) or more) above sea level. Such islands can be used as bases for both fixed-wing and rotary-wing aircraft.

13. Throughout the Arctic Basin there are a large number of multi-year ice floes. These ice floes consist of large areas of cold sea ice which may be as much as 9 m (30 ft) thick. These ice floes have been used as sites for research and meteorological stations on which aircraft have been based.

## **SECTION 3 - CONCEPT OF OPERATIONS**

### **General**

14. Northern operations will vary greatly depending on the theatre, eg, between North America and northern Europe and between the arctic and subarctic. The differences fall into two categories:

- a. those imposed by the military structure. Conventional operations are more likely in Europe because of the military infrastructure, ie, corps, divisions, and third-line logistic support, etc, will be available. In North America almost the reverse situation will apply; and
- b. those imposed by climate and terrain. Operations in the arctic will be severely restricted while in the subarctic large scale and sustained combat is militarily possible. Greater use of armour and air resources will be a characteristic of European subarctic operations.

15. Because of the variations in the theatres, and the fact that operations in subarctic Europe will be largely conventional, the concept of operations discussed in this manual is oriented toward operations in the Canadian north.

### **The Threat**

16. The principal land threat against northern Canada is considered to be small raiding type operations against specific targets. These raids would be conducted in support of a main operation in a theatre other than the Canadian north, probably Europe. The raiding parties would have the mission of destroying key facilities and/or tying down our forces. The enemy force would have limited mobility, and little direct support from the home land. They would require quick extraction or alternatively have to seize and hold existing facilities to give them food, fuel, and shelter.

17. This type of threat will require a quick response in order to destroy the lodgement, minimize destruction of our own facilities, and free our forces for employment elsewhere.

### **Canadian Northern Operations**

18. Northern operations in Canada would not likely entail employment of a force larger than a brigade group. While smaller forces may be adequate to meet incursions at the lower end of the probability spectrum, the extensive demands for security, operational support, and tactical mobility will require the resources of the brigade group to sustain one battalion group in offensive operations for a prolonged period. Failure to achieve early success will involve the formation in a protracted operation with a logistic build-up essential to the accomplishment of the mission. Detail on the organization of forces is included in Section 4.

19. The probable sequence of events following an enemy incursion would be:
  - a. determination of the location and strength of the enemy, and, if possible, his intentions;
  - b. the alerting and dispatching of a force to contain and harass him;

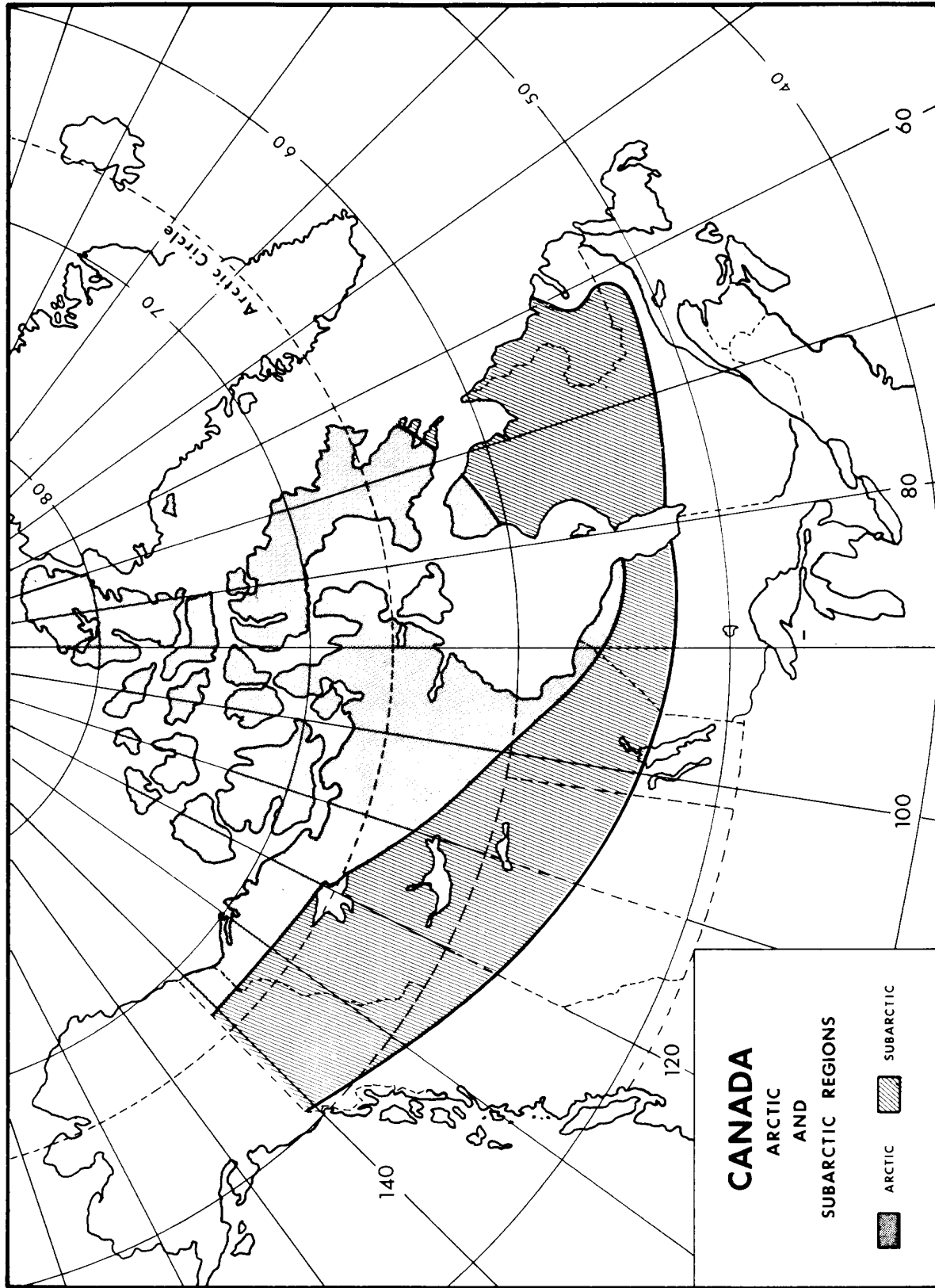

Figure 1-2 Arctic and Subarctic Regions



- c. the destruction of the enemy;
- d. the repair or replacement of any facilities vital to the operation or the local community which may have been destroyed by the enemy; and
- e. the withdrawal of the force.

20. Airborne forces are normally held as an immediate reaction force. They are ideally suited for the destruction of minor incursions, and the containment of larger ones until the arrival of the main force. Airborne forces are also suitable for deployment to seize or secure an airfield, develop airstrips, and provide local reconnaissance. Upon completion of their mission or the arrival of the main force, the airborne forces will be withdrawn and reconstituted as an immediate reaction force.

21. Commanders at all levels must show great initiative and imagination. The difficulties in deploying large forces to the area of operations, and the corresponding problems in extracting our own wounded, mean that more emphasis must be placed on economy of effort. The aim must be to confound the enemy with a multitude of problems while minimizing our own exposure. The environment must be used as a weapon in our favour. Unconventional tactics employing the indirect approach will predominate.

22. Some possible tactics which are elaborated on later in the manual are:

- a. greater emphasis on destroying enemy supplies rather than attacking the main force;
- b. denying shelter and heated accommodation;
- c. forcing the enemy to move, thus requiring his use of resources, and wearing him down;
- d. forcing him to stay awake by harassing fire, bombing, raids, etc;
- e. engaging him at maximum range in order to reduce our own casualties; and
- f. we must possess greater mobility to surround, surprise, and harass while reducing our own potential as a target.

23. Notwithstanding the foregoing, there will be occasions when speed of destruction predominates and risks will have to be taken. In this case, maximum firepower must be brought to bear on the enemy while utilizing the terrain and weather to our own advantage. Attacking downwind and downhill, for example, would put maximum pressure on the enemy while minimizing our own losses.

24. The key to the above concept is good mobility and logistic support. This can only be accomplished by detailed planning and a high state of training. The theme of achieving superior mobility and logistic back up will be emphasized throughout this manual.

## **Mounting of Operations**

25. Operations will be mounted using a system of bases and airheads. Initial deployment will normally be by air although ships, road, and railways may be used, particularly in the subarctic. The final approach to the airhead or enemy lodgement may be by parachute, aircraft, ground vehicles or a combination thereof. Some possible methods of mounting an operation are shown in schematic form in Figure 1-3.

26. A mounting base is one specially designated to dispatch military forces for an operation. It is usually, but not necessarily, the 'home' base of the unit or formation tasked.

27. A supporting base is the one through which most or all of the administrative support for the deployed force is channeled. The higher command of an operation may sometimes operate from here.

NOTE - Mounting and supporting bases may be one and the same, particularly in the early part of an operation. They will be existing CF bases.

28. A forward base will be established when the distance between the supporting base and the enemy lodgement is so far that command and logistic support is difficult or impractical. When possible, the forward base should be located on or near an airfield that is capable of accepting medium transport aircraft, or at a minimum, tactical transport.

29. An airhead is the area seized in the assault phase of an airborne operation. The airhead will be as close as possible to the enemy lodgement. An airhead may have to be developed but may already contain a facility for a fixed-wing aircraft or helicopters. The airhead will evolve into the task force administrative area in protracted operations.

## **Grouping**

30. Normally the senior headquarters tasked with a northern operation will be that of a brigade group. Grouping of subunits or units for a specific task will be the responsibility of this headquarters. A commitment may be known in advance and a force can be grouped and trained for it. An example is Canada's commitment to the defence of the northern flank of NATO. On the other hand commitments may arise from the contemporary situation, and subunits will be grouped to form a task force, for example a Defence of Canada operation. None of these eventualities present a major difficulty, for with minor modifications current unit establishments are suited for northern operations. Nevertheless, some tailoring of components in both equipment and personnel in order to cater to the terrain, the environment, and the mission is mandatory.

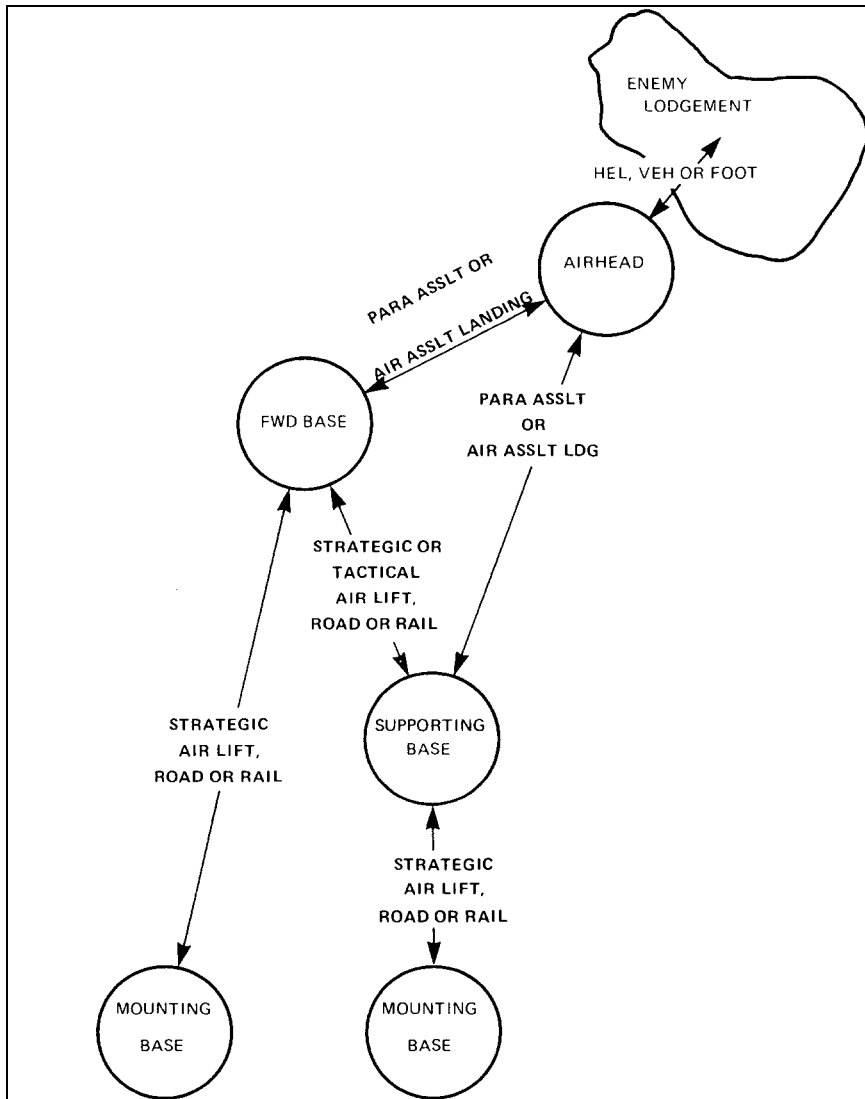

Figure 1-3 Diagrammatic Layout Base System for Mounting Operations

31. The character of the grouping will be altered as the need to enhance mobility is catered for. This will usually be as a result of the attachment of major engineer equipment and a greater degree of reliance on tactical air. Administrative elements will be hard pressed to keep pace with routine support tasks and must be provided with security either by the fact of distance or the use of reserves. Tactical air transport will be an essential part of the administrative support plan.

32. Assuming the enemy will attempt to use a captured civilian installation including its resources of shelter, transportation, foodstocks, etc, they may become self-sufficient on arrival, and may operate independently of their own supply sources until extraction. Friendly forces tasked with a quick assault will have to employ mobility and firepower, possibly in excess of the traditional three to one ratio in order to defeat them.

## **Command and Composition**

33. A Canadian force operating in a northern environment will normally be under Canadian control, however, it could be part of a NATO or United States formation. Foreign units or formations conversely may be under command or in support of a Canadian formation.

34. A possible composition of a battle group task force for an arctic operation is shown in Figure 1-4. The amount of airlift available will be the major factor, but the force must deploy with the maximum number of high mobility vehicles. The battalion headquarters will have to be augmented for sustained operations, in any case meteorological and communication facilities will have to be added.

35. A similar task force deployed in the subarctic might be organized as shown in Figure 1-5. Short distances, more dependable flying weather, and the presence of ground-transportation systems will allow heavier scales of equipment. Task forces operating from existing road or rail heads in the Canadian north will be within 325 km (200 miles) of most potential areas of operation.

36. Very minor incursions may be dealt with using a small force based on a rifle company. Possible composition of such a force for operations anywhere in the north is at Figure 1-6.

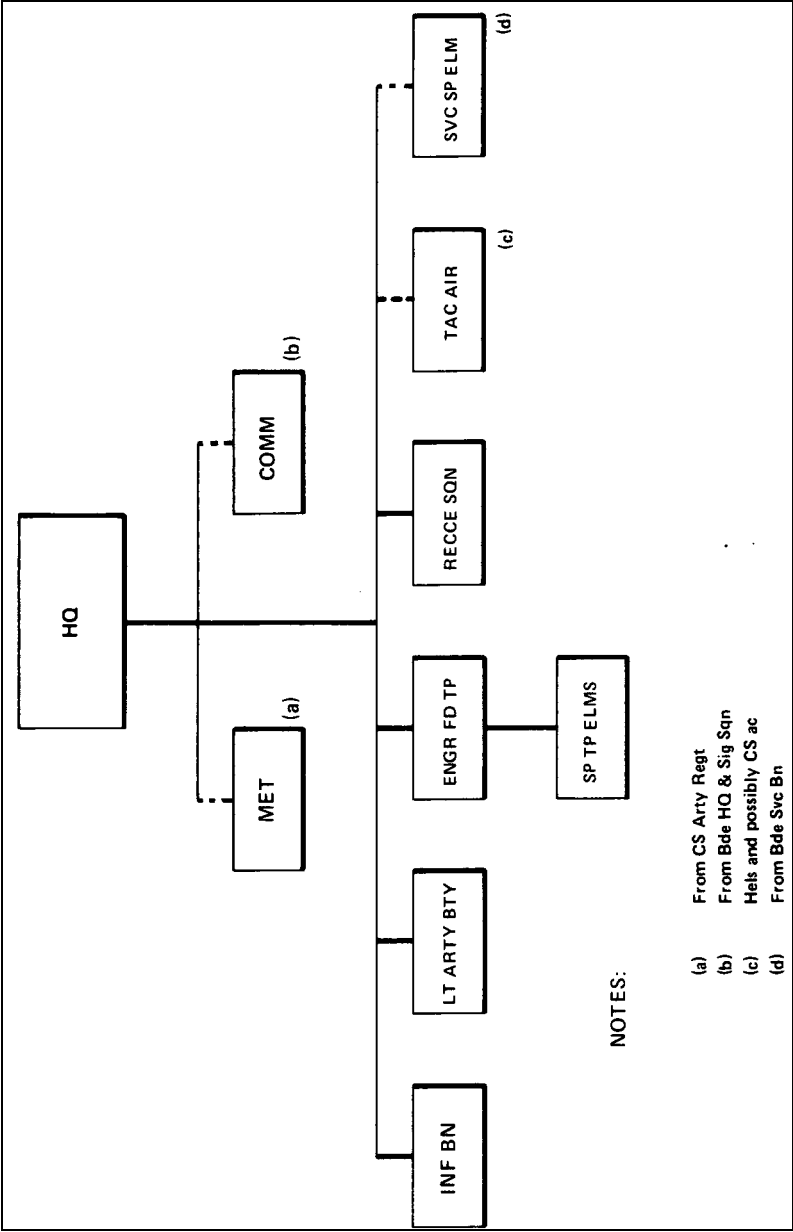

Figure 1-4 Battle Group for Arctic Operations

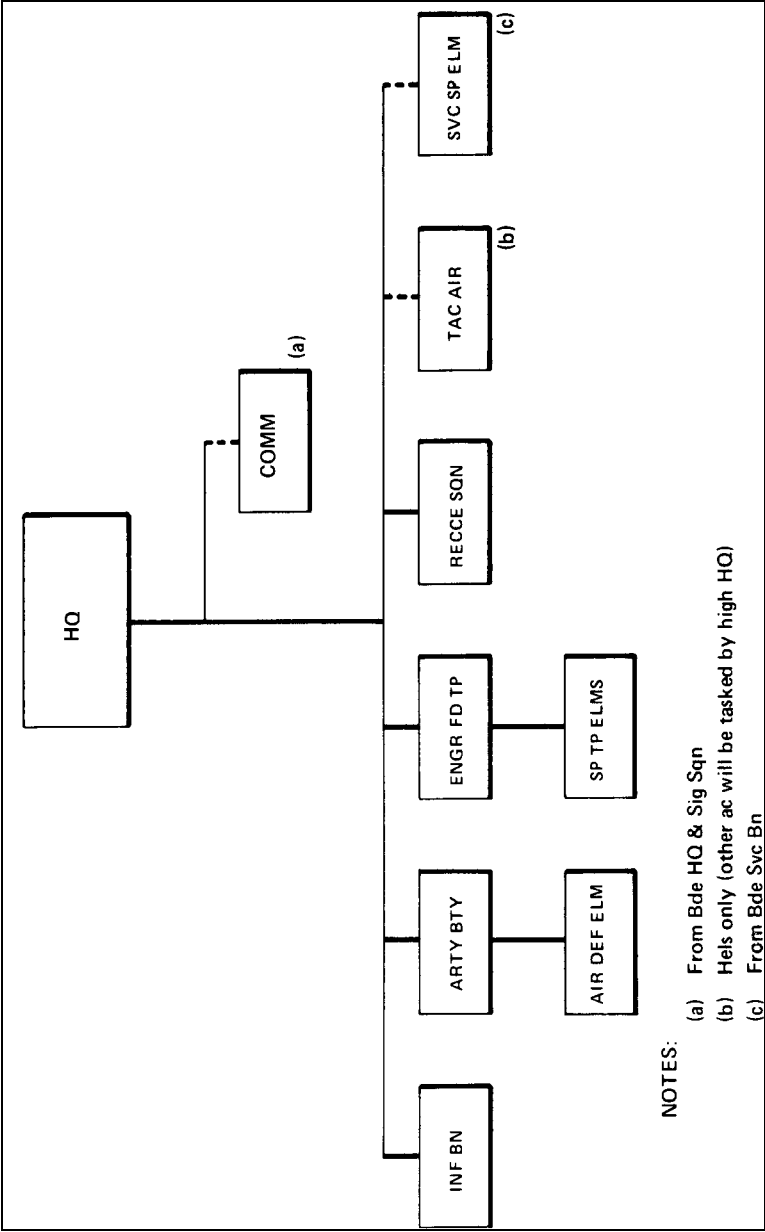

Figure 1-5 Battle Group for Subarctic Operations (Canadian Scenario!)

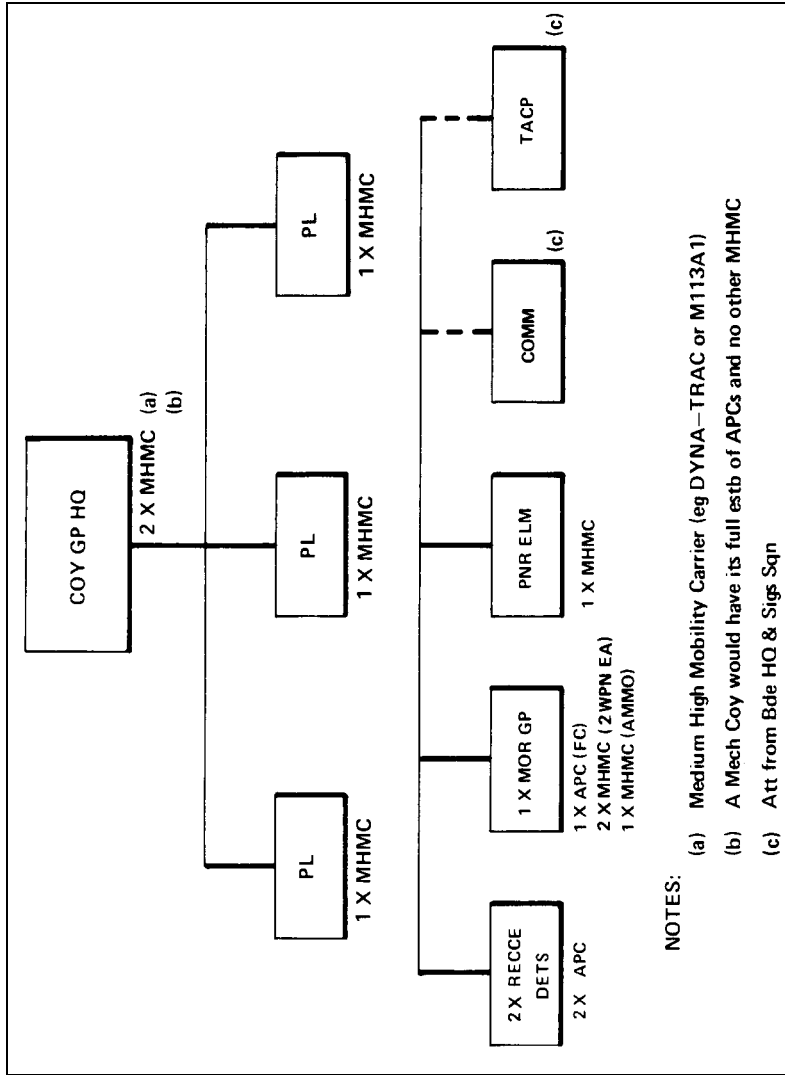

Figure 1-6 Company Group for Northern Operations

## **CHAPTER 2**

# **THE ENVIRONMENT**

### **SECTION 1 - INTRODUCTION**

#### **General**

1. The environment is defined as the aggregate of things, conditions or influences affecting existence or development. It is the environment of the north that is the dominating influence in military operations. Climate, terrain, and the lack of infrastructure are the principal environmental factors which must be considered.
2. The military force that best utilizes the northern environment will be the victor. The principles of war, and the elements of tactics do not change in the north. What is different is the emphasis placed on them in order to use the environment to best advantage.
3. Movement and firepower, used in combination, result in manoeuvre. Manoeuvre is the basis of tactics. The north presents problems in both movement and the application of firepower, and therefore influences tactics. This chapter first discusses operating conditions in general and then the environment under the three headings of climate, terrain, and infrastructure. It then examines the effect on military operations, primarily in the areas of leadership, mobility, firepower, and logistics.

#### **Operating Conditions**

4. Winter - The most suitable time for ground operations is from midwinter to early spring before the break-up. Within the tree line the snow is settled, and above the tree line it is packed; thus affording improved mobility in the subarctic, and excellent going in the arctic. In early winter, after the formation of ice but before the arrival of heavy snow, cross-country movement is improved, however careful reconnaissance of ice crossings is essential. The winter cold requires the use of special clothing and equipment, and places a premium on fuel for warmth. Tracks in the snow and fog created by heat sources complicate the camouflage of positions. The blending of the terrain features make land navigation difficult. High winds and phenomenon of white-outs interfere with air operations. High winds make moderately cold weather dangerous. Long periods of darkness dictate that most activities are carried out during periods of restricted visibility.
5. Spring - Spring is characterized by increasing periods of daylight, light winds, and warmer weather. Day-time thaws and night-time freeze-up leave only a thin layer of mud on the deeply frozen ground. Lake and stream ice is still firm. Limited operations are feasible if timed for the period of easier movement when the day-time thaws are countered by the night frosts. However, these operations may be interrupted by a sudden break, causing them to either slow down or stop entirely. Fortunately the spring break-up period is normally very short, numbering only three to four days in the high arctic, and to a period of a few weeks in the subarctic.



6. Summer - From the end of break-up season through to the autumn, operations can be resumed only after ground has dried sufficiently to allow cross-country movement. The permafrost table will recede, therefore deep mud conditions increase during the summer. When operating in low areas the numerous streams and swamps will require greatly increased engineer effort, and the use of special equipment. The many rivers and streams can sometimes be used for the movement of troops and supplies. Dust conditions are a problem during this period of the year.

7. Fall - Late autumn and early winter is the period of most difficulty. Normally fall rains, wet snow, and heavy fog conditions turn the countryside into a morass. Poor drainage may cause low-lying country to become isolated. Roads become flooded, and those poorly constructed disintegrate. The permafrost level begins to rise, and within the arrival of night frosts and cool days, surface freezing increases. By late September in the arctic, the surface is normally firm enough to support light tracked vehicles although the rivers and streams are still open. Full cross-country movement is normally possible (with careful reconnaissance) by 1 December annually in areas north of the tree line, and by mid-December in the northern areas of the subarctic.

## SECTION 2 - CLIMATE

### General

8. Climate is the condition of temperature, dryness, wind, light, etc, in a given region. Although we tend to think of the arctic and subarctic as a great mass of frozen waste it must be borne in mind that there is considerable variation in seasonal and geographical conditions. For example, almost half of Norway lies north of the Arctic Circle but the climate there is not much different to that further south because of the effects of the Gulf Stream.

### The Arctic

9. Temperature - The most extreme cold is found, not in the arctic, but in the Siberian (treed) subarctic. However, in the Canadian arctic there are areas where higher wind speeds produce higher windchill values than occur in treed regions. In most areas, winter temperatures are well below  $-18^{\circ}\text{C}$  with drops to  $-40^{\circ}\text{C}$  or lower. In summer, temperatures are around freezing or just above freezing, although in isolated sheltered valleys temperatures may rise to  $10^{\circ}\text{C}$  or higher for a few days at a time.

10. Precipitation - Nearly all the arctic has a mean annual precipitation of less than 38 centimetres (cm) (15 inches (in)), of which two-thirds is likely to be summer rainfall. Some of the islands of the Canadian arctic may receive less than 13 cm (5 in) and the ground is almost bare of snow throughout the winter. Winter snowfall in the interior of the North American continent is, on the average, less than 76 cm (30 in), although in Norway, Labrador, and parts of Baffin Island it may be greater than 380 cm (150 in) a year. Snowfall appears to be more frequent than it really is because the snow is often picked up by winds in excess of 16 kilometres per hour (kmph) (10 miles per hour (mph)), giving the impression of a snowstorm. This is particularly true of west coast regions of Hudson's Bay, where during, about one-third of the mid-winter season, visibility is reduced by blowing snow. This visibility restriction falls off with height above ground, but turbulence in built-up areas will reduce visibility to make vehicle movement impossible while vehicles outside the camp area may operate unhindered. Other areas vary in relation to mean monthly wind speeds.

11. Fog and Cloudiness - Low stratus cloud and fog are very common in warmer months because of the movement of warmer air masses over cold surfaces. Once the freeze-up completes, winter is generally a comparatively clear season, particularly for flying.

12. Windchill - Windchill is the term applied to the cooling power of the atmosphere on a surface having a temperature like that of the human skin. It is a function of windspeed as well as temperature, and is expressed in watts per square metre. By using temperature and windspeed as coordinates, both on linear scales, a graph can be drawn called a "chillgram". (See Table 2-1). The frost-bite line on such a graph is 1625. In the subarctic, trees and scrub will, in practice, decrease the windchill factor. Windchill is discussed in more details in Part 1 of this manual. Figures 2-1 and 2-2 contain the mean windchill factors for January and July.

13. Seasonal Variations - Seasonal variations are as follows:
- a. General - In the arctic, winter generally extends from late September to early May; spring from late May to the end of June; summer from early July to mid-August; and autumn from late August to late September.
  - b. Seasonal Variations in Sunshine and Darkness - Seasonal variations in solar radiation are much greater in the arctic than in other environments. In winter there is a period when the sun never rises, and in the summer when the sun never sets. The length of these periods varies from a minimum of one day at the Arctic Circle to a maximum of six months at the North Geographic Pole. Maximum solar heating is received during the third week in June. The heat received is less than that in lower latitudes because the sun's rays strike the arctic regions at an oblique angle. A tent wall or hillside at right angles to the sun receives as much heat as does level ground at the equator when the sun is in the zenith - possibly more because of the lack of water vapour in the atmosphere.

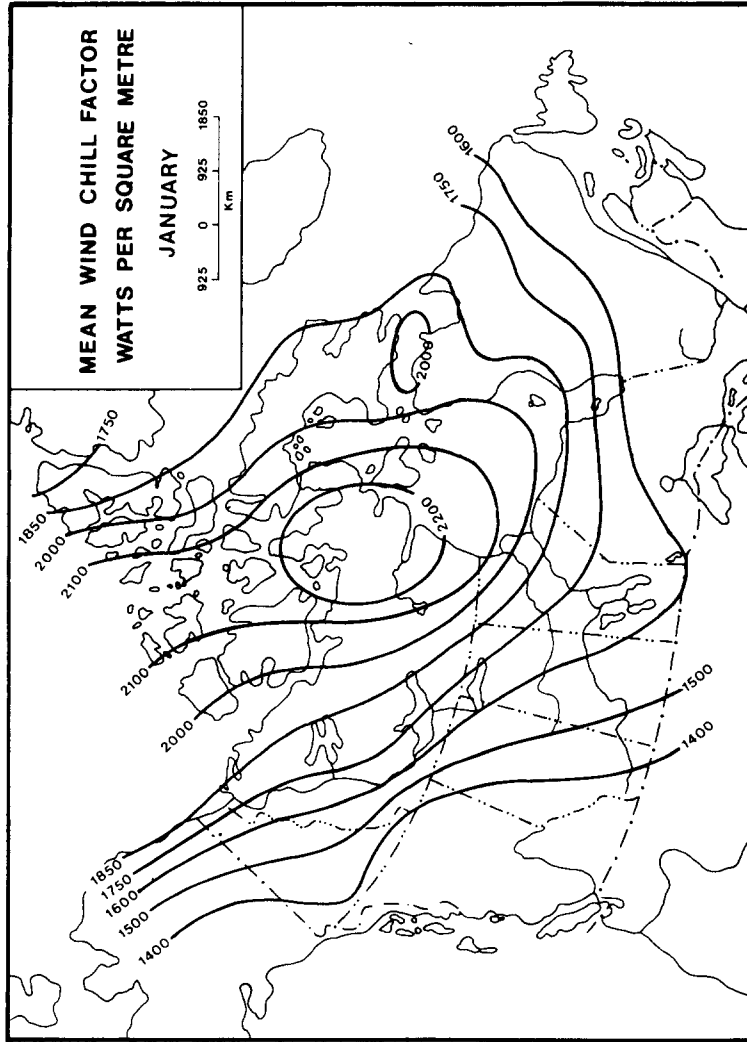

Figure 2-1 Mean windchill Factor in January

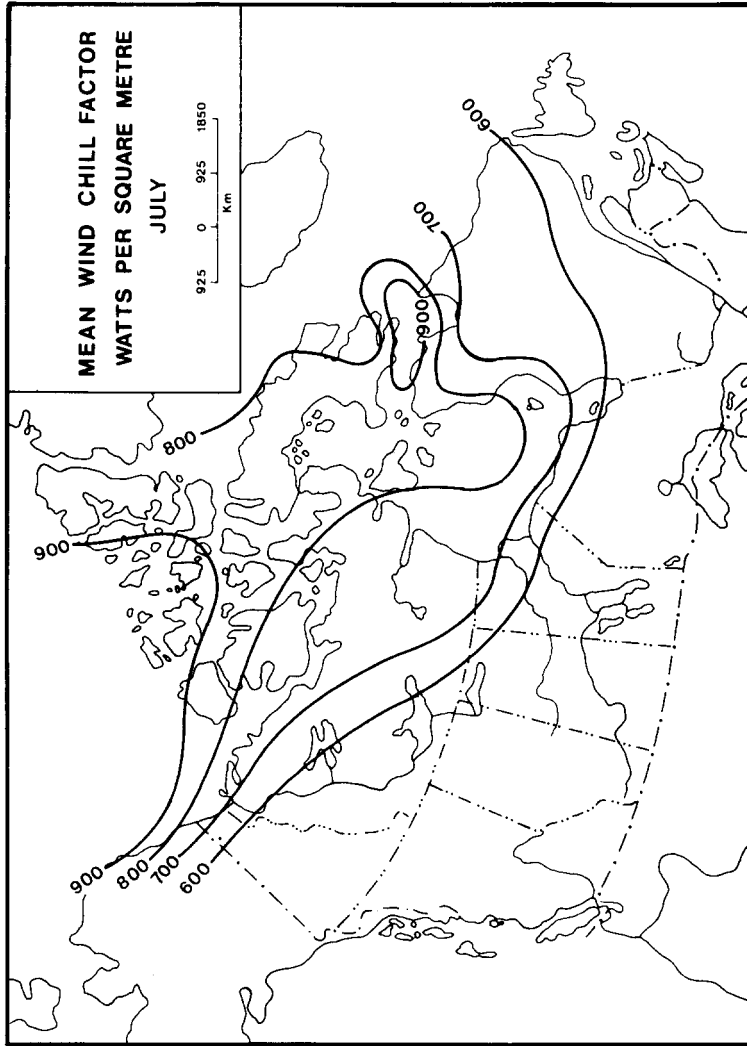
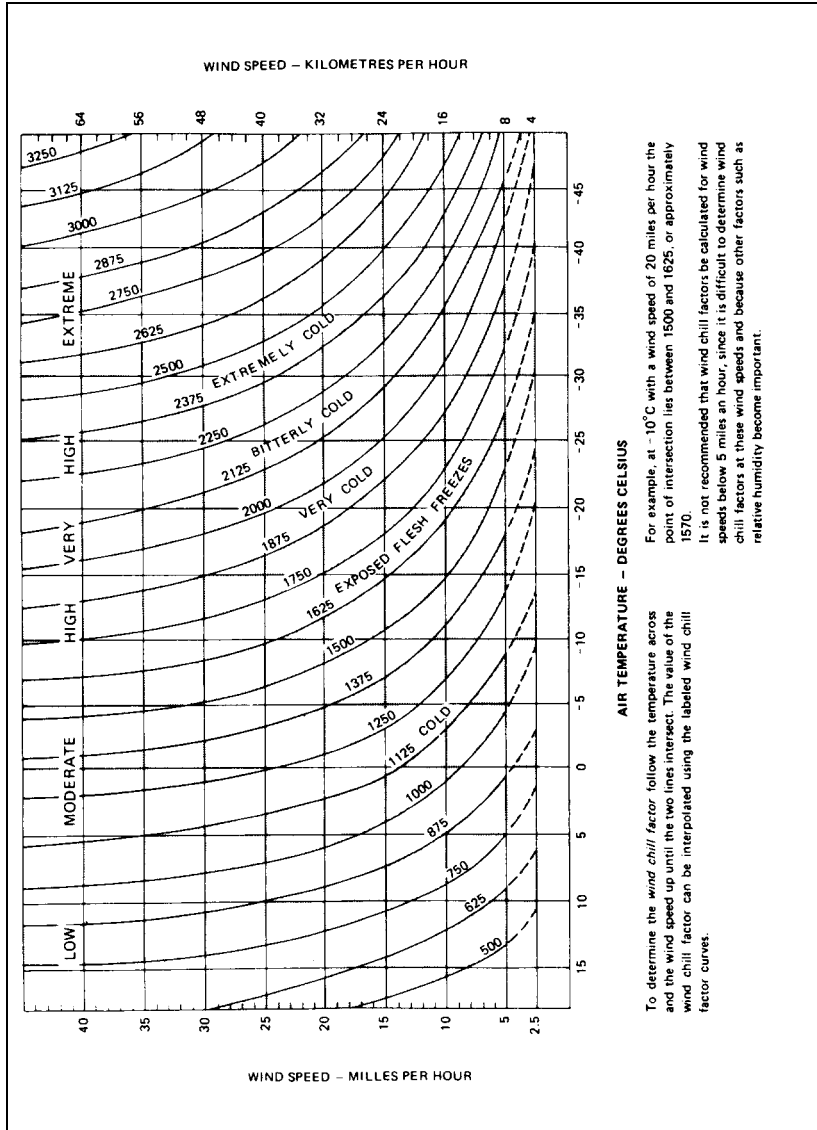

Figure 2-2 Mean Windchill Factor in July



**AIR TEMPERATURE — DEGREES CELSIUS**

To determine the wind chill factor, follow the temperature across and the wind speed up until the two lines intersect. The value of the wind chill factor can be interpolated using the labeled wind chill factor curves.

For example, at  $-10^{\circ}\text{C}$  with a wind speed of 20 miles per hour the point of intersection lies between 1500 and 1625, or approximately 1570.

It is not recommended that wind chill factors be calculated for wind speeds below 5 miles an hour, since it is difficult to determine wind chill factors at these wind speeds and because other factors such as relative humidity become important.

Table 2-1 Windchill Cooling Rates

- c. Seasonal Variations in Snow and Ice Cover - Snow and ice cover in the arctic is at a maximum in late March and early April. At this time the ocean is covered by ice except for small leads. Once melting begins in the spring, it proceeds extremely rapidly so that except for hilltops and gullies, all islands and the mainland are snow free by the middle of June. The permanent ice sheet does not melt in summer, but its surface becomes wet and is generally covered with pools of melt water. Rivers and lakes become ice free in late June or even later, depending on latitude. Rivers may remain open until about mid-October. The foregoing is subject to variation from year to year.

### **The Subarctic**

14. General - The climate of the subarctic differs from the arctic principally in the greater amount of precipitation in all seasons. In winter there is abundant snowfall, generally not less than 125 cm (50 in) and in some areas over 500 cm (200 in). Rainfall is also greater, averaging 25 cm to 50 cm (10 to 20 in) or more in coastal areas. Summer is longer than in the arctic, and mean temperatures range from 10° to 15° C with highs occasionally in the thirties.

### **Special Problems**

15. Ice Fog - The phenomenon of ice-particles fog is a very common occurrence around inhabited areas during cold winter weather. They are found most of the time when temperatures drop below -37°C. Their origins, in marked contrast to that of super-cooled fogs, lie in the copious local production of water vapour by human activities, coupled with the inability of stagnant air at such low temperatures to hold the water vapour. Such sources of water vapour may include the exhaust from vehicles or aircraft, the vents of steam from permanent-type heating systems, the air ventilated from humid rooms, and the stove pipes from space heaters. In the field, such a fog may appear over a body of troops, bivouac areas, vehicle parks, airfields, convoys, and gun positions when firing. Ice fog obscures the gunners vision along the line of fire, and may disclose the location of vehicles, weapons, and troops. During the darkness, ice fog limits or negates the effectiveness of night vision devices.

16. White-Out - White-out is a milky atmospheric phenomenon in which the observer appears to be engulfed in a uniformly white glow. Neither shadows, horizon nor clouds are discernable. Sense of depth and orientation are lost. White-out occurs over an unbroken snow cover beneath a uniformly overcast sky. The white-out phenomenon is experienced in the air as well as on the ground. The effect of this phenomenon on the soldier on the ground is a feeling of uncertainty because he fails to understand it. The quiet, eerie atmosphere with the loss of the third dimension of viewing makes him feel completely isolated. Because of the rarity of these conditions, and the mythical stories of this problem, white-outs are greatly over emphasized. Vehicles can move, particularly if they are of dark colour, and the navigation aids do not require a visual reference. However, movement in mountainous regions or over ground areas with high snow anvils becomes difficult because the driver cannot see changes in the terrain due to the loss of depth perception on a white surface. Natives of the north always watch for a melding of the horizon and sky on an overcast day with low winds to give them warning of this condition. White-outs are normally encountered on sea-ice, and on large frozen lakes, flat plateaus, and flat prairies with no bare rocks, willows or trees. Pilots or aircraft will often experience whiteout in

landing or take off. This can be countered by placing 45-gallon drums outlining the air strip or by positioning dark coloured vehicles on the edge of the air strip to give the pilot a reference point which he can use in relation to height.

17. Grey-Out - Grey-out is a phenomenon which occurs over a snow-covered surface during twilight conditions or when the sun is close to the horizon. There is an overall greyness to the surroundings. When the sky is overcast with dense cloud there is an absence of shadows resulting in a loss of depth perception which increases the hazards of landing an aircraft, driving a vehicle, skiing or even walking. The greatest effect is felt when a person is fatigued. Under certain grey-out conditions it has been found almost impossible when driving to distinguish the road from the ditch. The phenomenon is similar to white-out except that the horizon is distinguishable under grey-out conditions. Keeping direction is not a problem as the horizon will serve as a reference point, however, the ground conditions cannot be clearly observed. Movement is more difficult for the lead vehicles, however, the use of vehicle lights will assist.



## SECTION 3 - TERRAIN

### General

18. Terrain is a tract of land as regarded by the tactician. The terrain encountered in northern operations is more rugged than normal, but he who employs the terrain to his advantage will predominate. The great variety of terrain in the area of northern operations means that different problems exist in different areas.

### The Arctic

19. Tundra - Tundra is flat or gently rolling country, composed of a rock surface or muskeg over permafrost, and its chief characteristic is the absence of trees. The tundra is made up of several transition zones of vegetation which decrease in density from south to north. Bush tundra is composed mainly of dwarf trees of the willow, birch, alder, and mountain ash species, and borders the coniferous forest line. The shrubby tundra further north is composed of a nearly continuous mat of shrubs such as Labrador tea, and the grassy tundra even further north is composed of mosses and lichens mixed with small shrubs that lie flat on the ground. Finally, the grass tundra breaks up into scattered 'oases' of vegetation in sheltered hollows separated by bare rock. This is called desert tundra.

20. Muskeg - This is a cover of organic material overlying mineral soils which has a living cover of mosses, shrubs, grasses, and small trees. Muskeg is a formidable obstacle to overland travel in both summer and winter due to frozen hummocks up to one metre high.

21. Permafrost - Permafrost is perennially frozen ground, and is found throughout the arctic and in much of the subarctic. The annual thaw in the arctic is from 0.5 to 1.5 m (1 to 5 ft), and this depth of thaw is called the active layer. The digging of defensive positions, even in summer, is nearly impossible. The solution is in building up rather than digging down. The blowing of gun and mortar pits has also proved unsatisfactory. Because permafrost restricts surface drainage to the active layer, this layer is frequently saturated with slowly moving water. Any surface disturbance will collect water and, if such a disturbance provides a channel in the direction of the watershed, surface water will flow along the channel. The flow may wash away or otherwise alter the vegetation that binds the surface and insulates the permafrost. In turn this deepens the active layer, and creates the effect of a drainage ditch, which, again, increases the flow of water in and to the area of the channel. Under certain watershed conditions, this vicious circle may convert a single vehicle track into a destructive ditch of erosion. Such ditches may last for centuries, and have pronounced effect on the local ecology.

22. Inland Waters - Because precipitation is low, arctic streams have relatively little volume. Melting snow in the warm months can produce sudden variations in the flow. The rivers of the Canadian arctic mainland usually open sometime between mid-May and mid-June. In comparison, the larger lakes ordinarily are not open until mid-July, and in some years not at all. Ice expansion, continual water inflow, and partial thaws may create pressure ridges in the lake ice. These ridges, often several metres high, can prove to be formidable obstacles to vehicles and aircraft. The ice of arctic lakes may be at least 2 m (7 ft) thick, but this depends more upon the

snow cover than upon the average temperature. The maximum thickness is attained only when the snow is sparse or the ice is windswept. When a thick snow cover insulates the ice early in the winter, only a few inches of ice may form, and motorized travel is most dangerous even in very cold weather.

23. Glaciers - Glaciers are extensive masses of land ice formed by the accumulation and later recrystallization of snow. Glaciers are found on all mountainous islands and some of the lower Canadian arctic islands.

### **The Subarctic**

24. General - It is the terrain and its vegetation that for military operations separates the subarctic from the arctic. Forest of spruce, alpine fir, birch and pine interspersed by rivers, streams, lakes, and swamps dominate the subarctic landscape. The relief varies from the smoothly rolling or nearly level country of the Canadian Northwest, through the hilly relief of Norway with its deep fjords, to the mountains of British Columbia and Alaska.

25. Forested areas of the subarctic are characterized by close tree spacing, deadfall, rocky hummocks and boulders, bogs, rivers, and lakes. In summer, these all combine to make movement difficult. In winter the problem is eased on one hand by the freezing of waterways, on the other it is compounded by huge soft snow drifts which accumulate due to the trees.

26. Swamps, Rivers, and Lakes - In winter, swamps, rivers, and lakes becomes an asset to movement, in summer a liability. From the point of view of tactical movement, they are obstacles in summer, and good approaches in winter. In winter detailed engineer reconnaissance is necessary to determine the ice thickness before use for any vehicle movement or as airstrips. Mosquitoes, black flies, and moose flies in summer make life miserable for troops, and they must be given means of protecting themselves.

27. Mountains - Mountains and the combination of forest and deep snow, which, for example, are found in the Rockies and to a lesser extent in northern Norway, pose particular problems in subarctic mountain warfare. The helicopter provides the main means of overcoming these problems since vehicles of any type can seldom be used over the steep terrain and deep snow.

## **SECTION 4 - INFRASTRUCTURE**

### **General**

28. Infrastructure is the system of airfields, telecommunications, and public services that form a basis for defence. It is the absence, or presence to a minor degree, of this infrastructure in the area of northern operations that makes it a unique theatre. Although an infrastructure is rapidly being established in the Canadian north it is not yet at the stage where it can be fully relied upon. Military operations in the north will have to be conducted without this infrastructure or one will have to be created using integral military facilities.

### **Problem Areas**

29. The principal items of infrastructure that are either absent or in short supply include roads and railways, sophisticated airfields, communication systems, heated shelter, fuel supplies, food stocks, and hospitals. These are further compounded by vast distances and isolation.

30. The direct effects that the lack of infrastructure will have on military operations are discussed in the next section. From the outset, however, it can be seen that greater reliance will have to be put on air transport in order to overcome mobility problems and to allow supply lines to reach from the area of operations to the logistic bases.

### **Development**

31. Although emphasis has been placed on the lack of infrastructure it must be realized that the northern areas of the world are rapidly being developed. This is particularly true in Canada. The Department of Indian Affairs and Northern Development issues annually a publication, North of 60 - Charts, Information and Activity, which is an invaluable aid in understanding the development going on in the north. Similar reference material is available on other northern countries.

## **SECTION 5 - EFFECT ON MILITARY OPERATIONS**

### **Leadership**

32. Operations in the north stress small unit tactics, command is therefore decentralized to ensure maximum flexibility. Because of the demanding requirements on the individual soldier, forceful and personal leadership must be of the highest order. A routine must be established and all must adhere to it. Commanders at all levels must plan and prepare their operations in great detail, actively supervise, keep themselves and their subordinates informed, and maintain close coordination with adjacent and supporting units.

33. A high proportion of troops committed to northern operations, especially in winter, have a basic fear of the environment. They have heard tales of the cold, the dangers of becoming lost, and the great physical exertion required. A tendency in the recent past to stress survival at the expense of fighting capability has further eroded the soldier's confidence in himself.

34. The major task of leaders will be first to overcome this basic fear in their men, and then to use this confidence and esprit to best advantage against the enemy. A positive frame of mind may well spell the difference during operations in the north. Survival is of course a very basic consideration and man's natural tendencies cannot be discounted. Through the exercise of personal discipline and example, leaders can put survival in its proper perspective and not the focal point of every action.

35. Leaders must stress accomplishment of the mission, all training must be directed toward using the environment in our favour and against the enemy. A thorough grasp of tactics, a knowledge of northern conditions, technical competence, and the 'will to win' will lead to victory. All the foregoing will come to naught however, unless strict supervision is exercised at all levels.

### **Mobility**

36. As was mentioned earlier, the combined effect of climate, terrain, and lack of infrastructure has a very limiting effect on land forces mobility. This problem is greatest in the arctic due to the lack of roads, railways, and airfields. The problems with ground transport mean that priority must be given to air, however, due to weather problems ground transport must always be planned for as an alternative.

37. Because mobility problems vary greatly according to time of year, the area, between mounted and dismounted operations, this aspect is discussed in detail in Chapter 3.

### **Firepower**

38. All other things being equal, the ability to deliver superior firepower on the enemy will carry the battle. All commanders strive to reduce casualties by employing firepower rather than human resources whenever possible. In some types of conflict and against certain enemy this tactic may lead to a protracted conflict where the predominant force is worn down and defeated indirectly. This will not likely be the case in the north.

39. Every casualty imposed on the enemy, every shelter destroyed, every supply column intercepted will impose on him a 'snowballing' effect throughout his entire system. The time, effort, and manpower involved in recovering, treating, and evacuating a gunshot-wound casualty is far greater than in a temperate zone. The same penalty applies to us of course, and we must minimize our casualties at the same time we are delivering maximum violence on the enemy.

40. The same factors that demand outstanding leadership and limit mobility also restrict" somewhat our ability to deliver firepower. Mobility problems with weapon systems, ammunition resupply difficulties, increased battlefield obscuration (ice fog, blowing snow, etc) point to greater reliance on close support aircraft.

41. Indirect fire (ie, guns and mortars) is the most effective method of delivering fire with minimum risk to own troops. Unfortunately, difficulties in plotting positions, inaccurate maps, weather effects on munitions, and the shortage of firing data for extreme low temperatures reduce some of the advantages. Techniques of adjusting fire from initial rounds must be practised.

42. Few battles are ever won without employing direct fire weapons. Their characteristics make them less vulnerable to the environment but they also have their problems. Those employing electrical circuits are affected by extreme temperatures, moving parts become brittle and break. Skill and cunning in the use of cover, both artificial and natural, will be necessary in order to reduce casualties among users of direct fire weapons. A good plan will strive to get maximum benefit from indirect fire and weather before direct fire is employed. An enemy worn down by casualties, fatigue, cold, hunger, and thirst will be must less effective in the handling of his own weapons.

43. The potential of the helicopter as a weapons platform must be optimized in northern operations. The stand off ranges of rockets and guided missiles can be used to advantage. Enemy anti-aircraft weapons cannot be discounted, however, and the lack of protective features especially in the arctic must be considered. Armed helicopters deployed forward may be able to take advantage of good local weather while close support aircraft are grounded at distant airfields. Non-conventional use of weapons should be encouraged, eg, smoke-marking rockets might be used as incendiaries to destroy enemy tentage and expose him to the elements.

## **Logistics**

44. Despite outstanding leadership in the tactical sense, a force will not achieve the necessary mobility and hence the capacity to deliver firepower unless it is supported by a sound logistic system. Logistics is important in all theatres but even more so in the north where the infrastructure is minimal, and the task force may have to assume total responsibility for its own maintenance.

45. All logistic functions will invariably take more time in a northern environment. Distance is measured in time rather than space. Simple tasks take longer to execute due to extremes of temperature, bulky environmental clothing, etc. The unpredictability of the weather means that holdings at all levels must be carefully considered. Calculated risks are much more dangerous because of the unforgiving north but this is not a license to over issue. Too many stocks can be almost as much a problem as too few.

46. The scope of any plan will be limited by the amount of logistic support that can be provided. Logistic officers must be consulted early in the planning process so that the mission is tailored to resources. Priority in supply must go to combat requirements, troops must be trained to fight and survive with a minimum of 'comfort' items. Of the four items of combat supplies, petroleum, oils, and lubricants (POL) will probably be the predominant requirement due to the greatly increased consumption for heating, light, cooking, and continual running of engines.

47. Logistic problems are discussed more fully in Chapter 11.

## CHAPTER 3

# FACTORS AFFECTING MOVEMENT

### SECTION 1 - INTRODUCTION

#### General

1. Mobility is the key to operations in the north. This mobility is ideally provided by air vehicles, in the worst case it is provided by the feet of marching infantry. The majority of situations call for overground mobility, however, and it is this aspect that is stressed in this chapter. The most probable type of action in the Canadian north will involve isolated, small unit actions where the ability to strike fast, cut supply lines, surround patrols, and deliver direct fire from protected weapons platforms will carry the day. This means that all-terrain, all-season vehicles capable of carrying out a number of combat and logistic functions are mandatory. Current holdings of equipment are inadequate in some cases but procurement action, and research and development (R and D) are ongoing.
2. The tactical requirement for mobility must be achieved in spite of the tremendous problems presented by terrain and climate. Although standard military pattern (SMP) wheeled vehicles (medium mobility) will be sufficient in many subarctic areas it is the high-mobility vehicles that will be the key to success, especially in the arctic and during the winter season.

## SECTION 2 - MOVEMENT ON FOOT

### Scope

3. All personnel operating in the north will be involved in dismounted activities at one time or another. These activities will range from sentry duty in the logistic area to a snow-shoe patrol within enemy controlled territory. It follows that all personnel must have an awareness of the special problems effecting operations on foot.
4. The psychological pressures on individuals and the requirement for strong leadership to overcome these pressures are discussed in Chapter 2. Operations on foot are probably the most difficult in this regard. The man must rely solely on himself, and his personal clothing and equipment. When removed from his vehicle the man must do without the advantages of shelter, mobility, firepower, and crew companionship usually associated with a vehicle.

### Individual Load

5. Individual mobility on foot is a factor of load carried and mobility aids. The criteria should not be what can be carried but how much can be left behind. Commanders at all levels must stress minimum loads. Only those items essential for combat and emergency survival should be carried on the man. Many times this will only be ammunition and emergency rations, on other occasions sleeping bags will be necessary. If toboggans are necessary they should be pulled by follow-up troops - not leading elements.
6. The motorized load carrier concept is being developed to get the load off the dismounted soldiers back, it will be employed rather like a mule even in forward areas when noise is not a security problem.

### Mobility Aids

7. Mobility aids for dismounted troops range from snow-shoes and skis to motorized load carriers. The choice of snow-shoes or skis will be related to terrain, and state of training of troops. Some considerations are:
  - a. Skis afford great speed in moving, particularly over prepared trails and open country, and they usually require less physical effort than, eg, snow-shoeing. Troops mounted on skis and towed behind vehicles (ski-joring) are an effective means of rapid cross-country movement, depending of course on the training standard of the troops.
  - b. Snow-shoes, although slower than skis, require less training. Troops in good physical condition can develop adequate proficiency in a few hours. Snow-shoe movement is most practical in heavily wooded areas, assembly areas, gun positions, and other confined spaces.
  - c. Operations in the barren do not normally require the use of skis or snow-shoes, however, they can improve mobility, and assist in crossing areas of unequal snow conditions.



8. During winter, when survival is a prime consideration, the positioning and method of movement of subunit tentage, fuel, rations, etc, will be a major concern of all commanders. Imagination and improvisation will be required. High-mobility carriers (eg, armoured personnel carriers (APCs), oversnow vehicles, etc) must be used to full advantage in support of dismounted troops. The helicopter will be an invaluable asset but it is limited by weather and distance. Whatever the method chosen it must cater to two things:

- a. forward troops are not to be encumbered by unnecessary kit; and
- b. the equipment not carried by forward troops must be so positioned and carried that it can be moved forward immediately on demand. Hidden caches of combat supplies may be established well forward.

## SECTION 3 - VEHICLE MOVEMENT IN WINTER

### General

9. In the subarctic, heavy snow will be a prime obstacle to winter movement. In addition, many small lakes and muskeg areas where bacterial action is in progress may not freeze. These areas will be dangerous obstacles but they may be identified by differences in snow texture or signs of flooding through the snow.

10. In the arctic, snow drifts accumulate in the lee of features, and can normally be avoided. Snow anvils are another problem, they are more common, and make for rough going. When crossed at the wrong angle they can upset a vehicle or cause it to throw a track. When snow anvils cannot be avoided, the route selected should be based on the angle of the snow drifts.

### Effects of Deep Snow

11. It is impractical to establish definite rules for through-snow operations due to the varied conditions encountered. Since experience in each particular area is necessary to accurately predict snow trafficability, reconnaissance must be made for each separate action to determine current snow conditions. Low ground-pressure tracked vehicles can generally operate effectively in deep snow, however, snow of more than 75 cm (29 in) depth, especially when granular or powdery, can stop all except oversnow vehicles. The physical strength of snow generally increases with the reduction of temperatures; frequently, movement across a snow-covered area impassable during the day may be possible during the night after a sharp drop in temperature. Through-snow vehicles operating above the tree line with temperatures in the  $-34^{\circ}\text{C}$  level, and snow hard packed, operate as oversnow vehicles leaving tracks impossible to follow when there are blowing snow conditions.

12. In dry-snow conditions the ability to negotiate terrain by tracked vehicles is improved. Normal speeds may be maintained after packed snow trail has been formed by several vehicles. The surface of a packed snow trail becomes compacted into a hard mass resembling well packed wet sand, and is easily traversed by all SMP vehicles. In addition to their normal roles, tracked vehicles are capable of towing or carrying heavy loads such as toboggans or support weapons on sleds, and are excellent for ski-joring of troops. When moving in column, loads should not be included with the first two subunits or vehicles. This will allow them to select the route or to fight if necessary to allow the other vehicles to deploy.

13. In the event of a thaw, proper driving techniques must be used to prevent vehicles from tracking and eventually becoming bogged. Freeze-up frequently follows thaws, and produces glare ice which makes trails practically impassable to tracked vehicles, particularly on slopes of 35 per cent or greater. Again proper driving techniques must be emphasized, as under these conditions it is desirable that all vehicles trail the lead vehicle. The rubber pads of armoured vehicles of the M113 family should be removed when conditions are near the freezing level, however, at temperatures below  $-2^{\circ}\text{C}$  they should not be removed. Wet, clinging snow has a tendency to accumulate on the tracks, suspensions, idler wheels, and sprockets, and will require occasional halts for removal to prevent throwing of tracks or damage to the suspension.

14. In the arctic regions the snow is dry and hard. Few operating difficulties are encountered. The rubber pads should not be removed during any season of the year. During periods of low temperatures, even glare ice presents little problem, however, the extreme cold and the rough, lightly snow-covered ground results in undue damage to the track shoes.

### **Ice Crossings**

15. Lakes and streams may be crossed on the ice during the winter and spring months if ice is of sufficient thickness, and reasonable precautions are exercised. A minimum of 33 cm (13 in) is required for a one-vehicle crossing and 45 cm (17 in) is required for a multi-vehicle crossing at a temperature range of  $-18^{\circ}\text{C}$ . Crossing sites must be inspected for cracks, pressure ridges, and thin spots prior to placing of vehicles on the ice. Lakes above the tree line freeze quickly and normally are quite safe by 1 December annually, and remain safe until mid-April or later depending on the latitude.

16. For planning purposes the rate of fresh-water ice growth can be calculated. With an average temperature of  $-18^{\circ}\text{C}$  over a period of fourteen days, sufficient ice would normally be formed to support an APC (M113). This must be verified in the field by actual measurements. Snow-covered lakes in particular above the tree line normally have snow drifts on the south-east side. This heavy snow cover reduces the freezing process, and normally thin ice results. A guide to load bearing capacities of fresh-water ice for most vehicles suitable for northern operations is contained in Chapter 5, Engineering.

## SECTION 4 - VEHICLE MOVEMENT IN OTHER SEASONS

### Spring Break-Up

17. The poor going conditions during the spring thaw may restrict the movement of tracked vehicles. When operating during the spring break-up, vehicles should not follow in the tracks of others, and should move where the permafrost table is sufficiently high (15 cm (6 in) from the surface) to preclude the vehicle from becoming mired even in mid-summer. Gravel ridges should be selected as routes where possible. In wooded areas where permafrost is near the surface, routes should be selected on the shaded slopes of hills, on shaded sides of woods, on ground with good moss cover, and along crests where drainage is best.

18. Extreme caution is necessary in crossing large streams and lakes. Normally, when water is on the ice it is safe, however, when water recedes below the ice cover the strength of the ice is nil. Shore lines, and the inlets or outlets of streams should be closely checked so that you do not arrive at the other side only to find that the exit areas are not strong enough to hold your vehicles.

19. Movement cross country may be restricted for 24 to 48 hours in the high latitudes due to the crystalization of snow. Crystalized snow has no bearing capacity. In this condition, tracked vehicles become easily high centred and movement is halted. Recovery is complicated because of the lack of a firm footing. Although going may be heavy, the high permafrost level ensures that vehicles normally are not bogged in the mud or gravel.

20. During the spring period, vehicles should carry a reduced load. Traffic should be permitted only at night when temperatures are below freezing. This will allow engineers time to perform necessary maintenance without interruption during the day. When nights become so warm that the roads will no longer freeze, heavy traffic may turn them into morasses. For a time there is nothing that can be done except to minimize traffic.

### Summer

21. The northern regions in summer are characterized by an abundance of open lakes, streams, and swamps which impede movement. In the arctic, movement is much easier with the many eskers or gravel ridges providing good travel conditions. In the arctic islands, medium or heavy tracked vehicles can move on any terrain because of the high permafrost level except where steep hills or cuttings restrict movement. Hills should be climbed straight up because of the danger of slipping surface gravel caused by the ice at the permafrost level (10-15 cm (4-6 in) north of the latitude 75°). Ice on lakes north of latitude 75° may remain throughout the summer, although sometimes 2 m (6 ft) thick, it may be unsafe due to candling.

22. In summer, much of the northern terrain is a soft mud-based marsh land or muskeg, or is a swamp that is covered with a thin layer of moss and lichens. Once the moss layer is ruptured the mud offers no support above the permafrost level. In some areas during summer, the frost layer thaws to a depth that limits tracked vehicle operation. Floating bogs may also be encountered. These floating bogs are masses of thickly massed vegetation and rotting vegetable material that float on bodies of water. They will usually support a man but will not support a

vehicle. If a floating bog is suspected a long probe Dole should be used to determine where the bog lies. Floating bogs must be avoided by careful reconnaissance and route selection. In some areas, muskeg is interspersed with large glacier boulders just below the surface. Damage to suspension systems and tracks is highly probable during operations in such terrain. All tracked vehicles should have their normal rubber track pads, trim vanes, and skirting mounted. When it becomes necessary to cross open muskeg, vehicles should make their own tracks, no abrupt turns should be attempted.

23. During summer operations, in the arctic regions in particular, attention must be given to inspection of sprockets and road wheels. Small limestone rocks, approximately 10 by 5 by 5 cm (4 by 2 by 2 in), become locked by centrifugal force between the rubber wheels, and the friction causes fires. This condition is normally encountered when crossing loose gravel areas which have a high surface-water content. Under these conditions the vehicles should halt, then reverse 1 to 1-1/2 in (3 to 4 ft) before continuing on the move.

24. Recovery in muskeg is exceptionally difficult because vehicles belly down and tracks do not grip the surface. It is frequently necessary to winch the vehicle to a spot where the muskeg is solid enough for the tracks to grip the surface before recovery can be completed. Seldom can recovery be accomplished with less than two additional vehicles.

### **Fall Freeze-Up**

25. In some areas of the north, fall rains complicate military movement. Unpaved roads are thawed during summer, and the fall rains create deep mud. Ruts made in the mud during the day will freeze on cold nights and make movement difficult. Vehicles may break through thinly frozen crusts. Cross-country movement is difficult because leaves on bushes and trees, plus any tall grasses, tend to hide small steep-banked ditches and small streams. Once vehicles become mired, recovery is difficult and time consuming. Warm water springs cause thin ice which when covered with snow is a hazard. The situation is generally most difficult during the first three weeks of fall.

26. In areas north of the treeline the permafrost begins to rise until it meets the freezing action from the surface. Fall rains turn the surface into a quagmire. The willow mats along the edges of streams and swamp will generally support tracked vehicles and should be followed where possible. With leaves on the willows, observations of the ground is sometimes difficult. Vehicles should not follow too closely thereby preventing the rear vehicles from turning out and bypassing a mired vehicle. Foot reconnaissance should be used by crew members. Gravel ridges, shallow lakes, and stream beds normally provide good going conditions. Recovery during this season must be immediate to prevent the vehicle from freezing in. Crews may be required to agitate the water to prevent freezing in of vehicles.

27. During the later part of the fall freeze-up period mobility is greatly increased, although the use of maps in route planning, and reconnaissance carried out by helicopters and confirmed by foot is usually necessary.

## SECTION 5 - VEHICLE OPERATING TECHNIQUES UNDER EXTREME COLD CONDITIONS

### Driving

28. Vehicle driving habits spell the success or failure of the mission. Driving on open tundra areas is restricted by the roughness of the terrain, and the angles of the snow anvils. Vehicles should be operated at low speed to reduce the vibrations which render travelling in the vehicle extremely uncomfortable.

29. When travelling over snow anvils and rough country the speed should be reduced to reduce pitching to the level where antenna bases and suspensions are not damaged. The damage to the antenna bases can further be reduced by tying down the antenna by a three-foot-rope tie down. This also reduces the vehicle silhouette when travelling on the sides of ridges and small features. When driving in loose, deep snow the vehicle should move at the speed required to cause the front of the vehicle to partially plane.

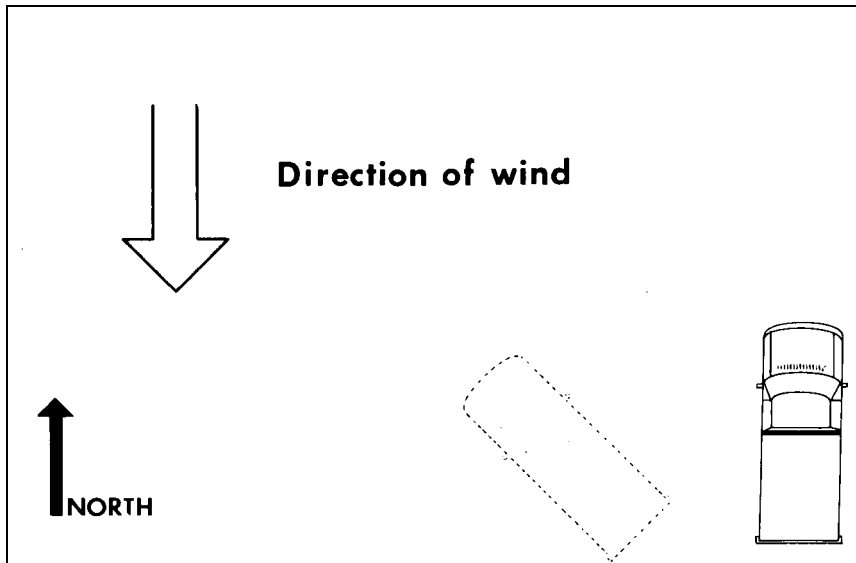

Figure 3-1 Vehicle Turn-Off

### Parking

30. Vehicles should be parked on high ground to prevent freezing in muskeg, marsh, etc, during wet weather conditions or day-time thaw. During high winds, and heavy drifting conditions vehicles should be parked facing one quarter into the wind (Figure 3-1). This reduces the possibility of heavy snow drifts forming immediately behind the vehicle, which may cause difficulties in moving out. The heater units in the crew compartment can blow out because winds on the exhaust cause the heater flame to become extinguished when the setting is normal. Even with the setting at the high position, very high winds may cause the heater to malfunction. Vehicles or stores parked on a lake or sea ice should be moved frequently to prevent snow drift accumulation from depressing the ice below water level and flooding the storage area.

## **Starting**

31. Vehicles should be exercised frequently to prevent the power train from becoming cold soaked. Engines not equipped with external pre-engine heaters should be started periodically to keep lubricants and engines warm.
32. Frozen power trains and engines of extremely cold vehicles are easily damaged by towing in an attempt to start these vehicles. In many cases it is impossible to start tracked vehicles by towing because the suspension and final drives are so cold the tracks will not rotate. Extreme care must be used in towing or pushing to ensure that no sudden shocks are applied. Metal is very brittle in cold; cables, final drives, or push bars may fail under shock loads. However, the engine may be started by towing if no other means of starting is possible.
33. Vehicles equipped with neutral turn capability (tanks) should have it disconnected because of the high stress placed on the power train and suspension when operating in extreme weather.
34. Slave cables to start cold vehicles from another are essential in northern operations. These should be provided on the scale of one for every two vehicles.
35. After the vehicle engine is started and warmed up, the vehicle should move out slowly. The power train should be broken loose gently to prevent failures due to sudden shock. Sharp turns should be avoided until the transmission and differential have had time to warm up. Initial movement should be restricted to first and second gear operation for some distance until final drives, wheel bearings, and support rollers have become free. At each halt, packed heavy snow should be removed from the suspension and drive sprockets to prevent track throwing. Hydraulic lines should be exercised to regain their flexibility to prevent vibration breakage at stress points.

## **Crew Comfort**

36. Vehicle compartments are more crowded, and exit and entry through hatches is made more difficult by heaving clothing necessary for northern operations. Confined crew positions cause parts of the body to become cramped thereby restricting circulation. In these confined positions clothing is drawn tight or becomes compressed and loses its insulation value. Drivers and commanders are subject to increased windchill as they are frequently required to ride with their heads outside the hatches and exposed to the wind generated by the vehicle movement. Constant supervision is necessary to ensure against frost-bite. Frequent halts (the number depending on the cold, and the fatigue of the crew) are required. Personnel may be required to dismount and move around to restore circulation, and warm body parts chilled as a result of a loss of insulation.
37. Wind-shields and, where possible, rotation of hatch covers should be used during movement in extreme cold to reduce the windchill. The present type of wind-shield for armoured vehicles reduces visibility when the sun is low on the horizon. Split image vision is common and

results in loss of depth perception. Frequent checking over the top of the windshields for, brief moments will reduce this problem.

38. Crews must remain constantly alert to the potential hazards to carbon monoxide. Open flame heaters and engine exhaust must not be used to heat closed areas. Vents in the passenger compartments should be kept open at all times.



## **CHAPTER 4**

# **FIRE SUPPORT**

### **SECTION 1 - INTRODUCTION**

#### **General**

1. Fire support is considered to be the fire available from all except personal weapons. The effect of the environment on all forms of fire support is a major consideration in northern operations. The range of some weapons is reduced, and rates of fire are considerably altered. Times in and out of action are increased. Breakage and malfunctions are magnified, reducing the number of weapons available for the task. Techniques and deployment drills must be adjusted to counter the effects of cold weather. This includes siting of weapons, use of alternative positions and fire directing procedures. The level of training must be high with all weapon crews dedicated to the provision of fire when and where required.

#### **Ice Fog**

2. A problem common to all weapons fired at low temperature is the formation of ice fog over the weapon, gun position, etc. This fog has the double effect of obscuring our vision, and giving away our positions to the enemy. Ice fog cannot be prevented, what is required are alternative positions, and offset observers are required to control the fire when the target is obscured.

## **SECTION 2 - DIRECT FIRE WEAPONS**

### **Anti-personnel Weapons**

3. Small Arms - Small arms have a high rate of malfunctioning and breakage due to extreme weather. A greater number of parts will fail, and commanders must ensure that sufficient repair parts are carried. Personnel must be trained to quickly identify breakages, and taught certain repair procedures.

### **Anti-armour Weapons**

4. Rocket Launchers - The main problem with rocket launchers is the ammunition. The propellant, because of the effects of the blast and its slower burning qualities, can be dangerous in cold weather. Rocket-launcher gunners must wear masks for protection from burns, and the back blast danger area must be increased. The range of the weapon is reduced and, therefore, the gunner will be required to aim high (especially at longer ranges) in order to overcome the effect of the slow-burning propellant.

5. Recoilless Rifles - Again propellant tends to burn slower in extreme cold. The weapon must be sight tested for the temperature in which it is operating. The rate of fire will be reduced because of the burning gases left in the barrel (afterburn). Gunners must exercise care to avoid premature explosion of the round in the weapon. A period of at least 60 seconds must elapse between firing and unloading of the weapons. The back blast area, described as the danger area, should be increased by 300 per cent in extreme cold. Problems in sighting are increased because of the effect of solar radiation on the barrel, ie, the barrel will droop. Sight testing must be adjusted from darkness to daylight especially if a warm sunny day is encountered.

6. Missiles - Difficulties in the use of missiles in the cold, in particular wire-guided missiles, are well known. Guidance facilities within the missile, which employ an electrolyte in their source of power, are subject to freezing and therefore malfunction. Control wires become brittle in extreme cold, and abnormal breakage can be expected.

7. Tank Main Armament - These weapons have many problems of the recoilless rifles, however, the breakages and malfunctions are less because of the heated turrets. The primary problem is obscuration of fire and barrel droop caused by solar radiation.

8. The formation of ice fog, blowing snow, and snow blown up by the muzzle blast will add to the normal problems of firing. The burning propellant will create an ice-fog condition in the target area, and masses of dry snow will blow into the area of the burst. First round hits will assume even greater importance. When these conditions cause the gunner's and commander's vision to be obscured, observation from another vehicle may be the quickest way to adjust fire. Because of their elevated position, and the availability of magnifying sights and binoculars, crew commanders have much better visibility and depth perception on snow-covered terrain than have troops on the ground. Correction of fire, therefore, should be carried out from the crew commander's position of another vehicle.

9. Extreme cold decreases muzzle velocity, and hence the accuracy of tank ammunition. Cold-weather firing tables must be provided for all types of ammunition. In the absence of this information, units must determine data by actual firing. An initial round on the ground for observation assumes greater importance, and must be quickly employed keeping in mind the conflicting requirement for a first round hit. Cold ammunition will have different ballistic characteristics than warm ammunition, and the rate of fire will be reduced.

10. There are certain difficulties in handling ammunition. The binding tapes around the fibre cartons are difficult to remove while wearing mittens. Ammunition tends to freeze in the wooden fuze protective ring making it necessary to cut ammunition from the fibre cases. Cold ammunition placed in a warm vehicle will develop frost crystals if the vehicle is slightly warmer than the outer air. These crystals increase the difficulty of ammunition handling because of the slippery surface. Ammunition racks are difficult to operate wearing mittens, however, handling is expedited by the use of leather thongs, extension racks and/or other handles.

## SECTION 3 - INDIRECT FIRE WEAPONS

### General

11. Because of the smothering effect of deep snow, mud, and muskeg on impact rounds, artillery and mortars are less effective in the north during a good part of the year. There are also problems with land proximity fuzes using electrolyte in their power sources; as the extreme temperatures cause them to freeze and malfunction. The indirect fire requirement must be carefully assessed. A good supply of selected ammunition for a few weapons is more desirable than a wide range of weapons with little ammunition.

12. The use of aircraft for observation of targets should be exploited to the maximum. Such aircraft can assist in establishing communication relays, reconnaissance of routes and positions, identification of objectives, and for orienting ground troops, in addition to observation of fire.

13. Although self-propelled artillery is desirable, the limitations on airlift capabilities may well restrict these units to the subarctic where road, rail, and cross-country movement is possible. In any case, prime movers, preferably tracked, are required for movement of guns when helicopters are not available or practical.

### Fire Control Procedures

14. Normal fire control procedures and techniques are valid during northern operations, however certain procedures must be emphasized because they are encountered more frequently in the north than in the temperate zone. Because of a lack of survey control, a battery or regiment will have to establish a common/arbitrary grid to include all fire units and observers. A common grid can be achieved by either employing normal survey methods or expedient measures such as airburst fixation coupled with the use of gyro-orienters, or orientation by astronomical observation. The determination of registration correction data can best be accomplished by visual cross-observation, either ground- or air-burst.

15. During the long periods of darkness in the winter, aiming post lights are continually required. To ensure their operation during cold periods, the power supplies should be located in tents or shelters, and remoted to the lights.

16. Extreme cold weather will affect the ballistic characteristics of the weapons and ammunition, the most significant of which is a reduction in range. Care must be taken when firing initial rounds to assure clearance of friendly positions.

### Movement

17. Successful movement is accomplished as a result of careful, detailed, and comprehensive route recce. During winter operations, most movement will be conducted under periods of darkness. The weight of the guns will necessitate the use of specialized equipment. This will include sleds or skis, and the use of vehicles with dozer blades to prepare the trails. In spring, engineer support must be increased.

18. The use of helicopters for deployment of guns will be desirable in all stages of an operation. This requirement may often conflict with other missions of the helicopters and may be denied. High winds and adverse flying conditions may also preclude movement by this means. The vulnerability of aircraft employed in redeploying a fire unit that may have been located by the enemy must be considered as well as any need to extricate these forces.

### **Gun and Base Plate Positions**

19. Positions should be chosen primarily for tactical reasons, however, consideration must be given to locations affording protection from the elements and allowing ease of resupply. Positions should be prepared prior to occupation whenever possible, and must be built up using snow, rocks, bush or whatever material is available. Extreme difficulty in digging will also be encountered. Effective and continuous operation requires warming tents or shelters within the gun/mortar position. Protection and security of the position is as normal.

20. Camouflage is difficult but not impossible. Maximum use should be made of camouflage paint, camouflage nets, and available terrain features. Units should be dispersed, and camouflage discipline constantly enforced. Periodic displacement to alternative positions will be necessary due to ice fog in extreme cold.

### **Observation**

21. During the winter period, good observation will be restricted due to long periods of darkness. Observation will also be limited by periods of fog, ice fog, snow storm, blowing snow, white-outs, and grey-outs. Snow cover reduces depth perception and obscures ground features and landmarks. Amber filters for observation instruments are required to improve visibility and reduce eye strain. Personnel operating these instruments should be relieved frequently, therefore most observers will be required.

22. Ground bursts are difficult to observe on snow-covered terrain and muskeg due to the dampening effect. Preliminary adjustment by airburst or use of coloured smoke may be required.

23. Difficulties in determination of location will require use of special techniques to bring initial fire into the target area. Magnetic flux in the area near the geomagnetic pole will affect the use of all magnetic direction-finding devices. Observers and controllers will often be required to navigate by dead reckoning for orientation and for location of targets. Resection from adjusting rounds is one method that can be used to assist the observer in determining his location. Safety of friendly troops must be carefully considered at these times.

24. Observers and controllers must be equipped to move with the supported element. The weight of radios, batteries, and other equipment becomes critical if the observers are required to use skis or snow-shoes as a means of transportation.

NOTES - 1. The Canadian Forces now possess passive night vision equipment which can permit effective engagement of targets during darkness. Examples are:

- a. an individual weapon sight for the rifle, light machine-gun (LMG), medium assault weapon (MAW), and sniper rifle; and
  - b. a crew served weapon sight for self-propelled machine-guns (SPMGs), and heavy machine-guns (HMGs) which can be mounted on a tripod for use as a medium-range night observation device (NOD).
2. The effective range of image intensification sights should be greater in the north because:
- a. on large, snow-covered areas the ambient light level is considerably higher than that of snow-free areas; and
  - b. the high contrast between targets and their snow-covered background enhances the performance of image intensification equipment.
3. Limitations of these equipment include:
- a. restrictions due to fog and blowing snow;
  - b. spare, warm batteries must be close at hand (carry in clothing);
  - c. the large objective lens must be kept free of ice and snow; and
  - d. the additional weight must be appreciated.

### **Ammunition**

25. Special care should be taken in selecting fuzes. This will vary with the type of target, however a higher proportion of time fuzes is anticipated. Deep snow and unfrozen muskeg will reduce the effect of impact burst by as much as 80 per cent. Time and variable time (VT) fuzes will malfunction when temperatures are below 18°C. Moisture control measures must be taken at all ammunition supply points to minimize malfunctioning of set back pin mechanisms due to frost or ice particles. The fuzes must be warmed by placing them in prime movers, warming tents or shelters constructed from tarpaulins. Low temperatures will also cause malfunctioning of illuminating rounds by freezing of the parachute and its components. Warming of these rounds in the same manner as fuzes will greatly reduce the problem.

26. Carrier munitions are adversely affected by deep snow. The canister from base ejection shells may be covered in the snow. Phosphorous rounds, although producing the desired smoke, contaminate the area of impact with phosphorous particles which remain buried in the snow and reactivate during thawing.

## **Artillery Survey**

27. Traverse type survey is impractical over extended distances. Triangulation is usually more feasible, and electronic distance measuring devices are the most practical means. Instruments fog up and other mechanical failures are experienced. Recording and computing under winter conditions is exceedingly difficult, and survey control and adequate maps are seldom available. Grid bearings may be determined by astronomic observation or by using a gyroscopic direction determining instrument. Starting coordinates will often have to be assumed.

## **Mortars**

28. Mortars experience an increase in breakage of firing pins and cracking of base plates. When ground-mounted mortars are used, the base plates should be cushioned against the frozen ground by using sand bags, small branches or bushes, evergreen boughs, small logs or similar type material which will provide a suitable cushion. Precautions must be taken to prevent the base plates from becoming frozen to the ground.

## **SECTION 4 - OFFENSIVE AIR SUPPORT WEAPONS**

### **General**

29. The effects of the environment on air weapons are minimal. The effect of the target end may be a reduction in blast radius in heavy snow due to the dampening effect, however, the opposite will normally be true on the hard frozen regions of the arctic during winter periods. Limitations encountered will be the availability of the support because of flying conditions, and the loss of visibility of the ground due to blowing snow. Techniques used in directing aircraft onto the target may be more difficult because of the inaccurate maps, and lack of features on the ground. Conversely, the targets may clearly stand out because of ice fog and appearance in relation to the general terrain.



# **CHAPTER 5**

## **ENGINEERING**

### **SECTION 1 - INTRODUCTION**

#### **General**

1. In arctic and subarctic operations, engineers retain their assigned role and functions as described in CFP 319, Engineers in Battle. Although engineer units are equipped to function in a wide range of conditions, the environmental and climatic extremes of the northern regions require the use of specialized equipment, techniques, and procedures. The environment demands more engineers for additional tasks requiring more time than similar or related functions carried out in temperate areas. The force commander must be aware of this and either allot extra troops to assist in engineer tasks or employ combat troops of the task force to carry out engineering tasks under direction from an engineer advisor.

## SECTION 2 - DEFENCES AND OBSTACLES

### Field Defences

2. Troops must be capable of constructing field defences and obstacles on snow and frozen ground using material available. This may include constructing obstacles with wire, mines, and timber under winter conditions, eg, by icing the banks and preparing traps in the ice on rivers and lakes.

3. Explosives are effective but very brittle when temperatures are low. Whenever moulding is necessary it must be done in a warm place. One suggestion on sunny days is to place or mould explosives inside some dark material, eg, plastic garbage bag or parka cover. Charge calculations cannot be made directly from standard data because of the variations of moisture content, soil type, and vegetation due to property changes resulting from low temperature. Consequently, demolitions must be computed on the basis of experience, and test shots will be necessary in most cases. Even double the amount may not be enough, and on occasions tamping is critical. Most defences will be built up rather than excavated. Use of available materials should be encouraged to the maximum extent to decrease logistical support. Above the tree line the availability of resources is a major problem. See also CFP 302(2), Part One, Chapter 4, Section 3, which contains details on field defences.

### Mines and Mine Warfare

4. The threat envisioned, the weather, and the high costs in manpower and logistics, support the argument for infrequent anti-tank mine use, however, anti-personnel mines may be effectively employed. For use in snow, mines should be white. As much work as possible should be done indoors to increase the efficiency of both the men and the mines, eg, arming some mines is a difficult task in low temperatures, eg, A/Tk Mk 7. When mines are laid, track discipline is essential. To ensure activation, pressure type anti-personnel mines should be placed on a firm bearing surface such as large rocks or an ice base, frozen cardboard, etc. Due to the lack of landmarks and accurate position determination, minefield registration will pose a problem. Consider self-neutralizing mines.

5. Anti-tank mines are not always effective under deep snow cover. When they are buried too deeply the snow causes them to become bridged over. Mines may fail to detonate if water has entered them and become frozen. Mines should not be lifted when they are equipped with anti-lift devices or when frozen to the ground. Under such conditions they should be destroyed in place unless ground/snow melting devices can be employed.

## SECTION 3 - MAINTENANCE OF MOBILITY

### Roads and Tracks

6. Since communication routes in most northern areas are generally limited to primitive roads and trail networks, a major construction effort to assure movement and resupply is necessary. At the same time, lack of maps, natural material, gravel, wood, etc, and the climatic extremes increase the manpower and equipment requirement for construction and maintenance. The numerous streams, swamps, and lakes necessitate increased quantities of crossing equipment in summer.

7. Route, selection criteria vary by season; summer routes being selected for bearing strength, whereas grades and snow depth dictate winter routes. In the tundra area the snow-drift pattern is a major factor. Areas subject to drifting should be avoided, or snow fences should be improvised. All weeds, rocks, and willow should be removed from the immediate up-wind side of the road to reduce drifting across the road. Early snowfall should be removed from the road to accelerate the penetration of frost into any unstable subgrade thus consolidating it. Maintenance of roads made by combat troops for tracked vehicles normally consists of such tasks as straightening sharp curves, filling in holes, building turnouts, and draining surface water.

8. Frequently, winter traffic effects on snow roads will result in loose snow and soil mixtures which cannot be compacted. Sometimes traction can only be restored by removing the unstable material. If temperatures are sufficiently low, this condition can be corrected by mixing vegetation with the snow, adding water, and restoring stability by freezing.

### Ice Roads

9. In some areas the best sites for winter routes will be found along frozen waterways. They have the advantage that they are relatively easy to prepare, requiring only snow removal and possible strengthening of the ice in places. The only slopes found on such routes are at the exit and entry to the waterway. However, disadvantages are many: sudden sustained temperature rise can make the route unusable, many men, and much equipment must be stationed along the route to effect continuous maintenance and repair, convoy speed may be limited, and recovery operations of vehicles which break through the ice may force traffic to seek alternative routes. These factors may make their use impracticable in forward areas, but utilization of ice routes in tactical plans should not be excluded.

10. Reconnaissance of routes over and across lakes and streams must include detailed reconnaissance of ice conditions throughout the full distance. A critical test is to prove the ice is supported by water and not held above it at the ice perimeter. The ability of the ice to support the heaviest vehicle and the proposed density of vehicles must be proven initially, and the route tested periodically thereafter.

11. The strength of ice varies with its structure and temperature. Table 5-1 provides bearing capacity for planning purposes, and Table 5-2 illustrates the rate of growth of fresh-water ice, as the degree days of frost increase so does the thickness of the ice.

## **Bridges**

12. Non-equipment fixed bridges of timber and steel, floating bridges, ferries, and equipment bridges are suitable, within limits, for northern stream crossings. Although bridge construction methods employed in temperate areas are suitable for northern regions, special consideration should be given to:

- a. logistical support including availability to fill;
- b. the construction season in terms of ice, permafrost, and snow characteristics; and
- c. waterway characteristics in terms of variations at change of seasons.

Load	Ice Thickness for Temperatures -18° to -12°C				Spacing Interval in Metres
	Risk		Normal		
	Inches	cm	Inches	cm	
(a)	(b)	(c)	(d)	(e)	(f)
Single soldier on skis	1-2/3	4	2	5	5
File of soldiers - two pace intervals	3-1/4	8	4	10	N/A
Vehicles					
1/4 ton	5	13	8	20	15
3/4 ton	6	17	10	25	30
2-1/2 ton	13	33	16	40	25
5 ton cargo	18	45	22	55	60
5 ton tractor with loaded trailer	32	80	36	90	80
XM548 cargo carrier	8	20	10	25	20
M578 recovery vehicle	20	50	26	65	60
M113A1 APC	13	33	18	45	25
LYNX	10 1/2	26	26	40	20
M109 HOwitzer, SP 155 mm	18	45	20	50	40
Nodwell	8	20	10	25	20
Tractor D7	18	45	20	50	40
Tractor D8	20	50	24	60	50
Crane 20 ton	20	50	24	60	70
Grader	14	35	16	40	50
<p>NOTES-</p> <ol style="list-style-type: none"> <li>Vehicles should maintain speeds of 16 kmph (10 mph) where water depth under the ice is up to 6 m (20 ft) deep and 32 kmph (20 mph) if the water is deeper.</li> <li>First crossing always DANGEROUS.</li> <li>Reinforced ice calculations: Working thickness = original thickness + 1/2 of added thickness.</li> <li>Continual use of critical load might require additional ice thickness.</li> <li>Ice strength increases from freezing to -18°C then remains constant.</li> <li>Approximate vehicle class = <math>\frac{\text{Total weight of vehicle} + \text{Load}}{2000}</math></li> </ol>					

Table 5-1 Guide to Load Bearing Capacity of Fresh-Water Ice

13. Since it is seldom possible to find ideal crossing locations, the design and construction procedure must minimize the difficulties posed by floods, permafrost, and ice.

14. A temporary expedient bridge across small streams may be made in late summer or fall by the use of multiple culverts. The culverts may consist of corrugated iron pipe or open end gasoline drums placed parallel to the flow of the stream and filled over. If these are filled with gravel/rocks the bridge can become semi permanent. These culverts will not likely be able to handle spring run-off because of the ice and snow collected in them. In deep gullies, extra barrels placed above the water line and cleared of snow before the thaw will increase the probability of surviving the spring run-off.

15. Floating bridges may be used during most of the summer and fall, however, reliability of this system is effected by water levels and current velocities.

### **Ferries**

16. The use of ferries and pontoon rafts for stream and river crossing should not be overlooked. Ferry and raft operations during the summer at favourable locations are not difficult. A special application is their employment during the fall freeze-up or during the transition period between ice break-up and the complete absence of floating ice, and intermittent freezing of late spring. During this period, a ferry or pontoon raft can be used in place of a floating bridge to reduce the possibility of damage to a large amount of floating bridge equipment. Continual breaking of the ice and agitation of the water by a small reinforced powerboat or an outboard motor mounted on boards implanted in the ice can keep a ferry channel open for a considerable period during fall freeze-up. A pump connected to a large gauge hose (stationed just under the surface) which has holes along its length is also suitable to keep open a 'bubble channel'. Ferry operation itself will serve to keep the channel open.

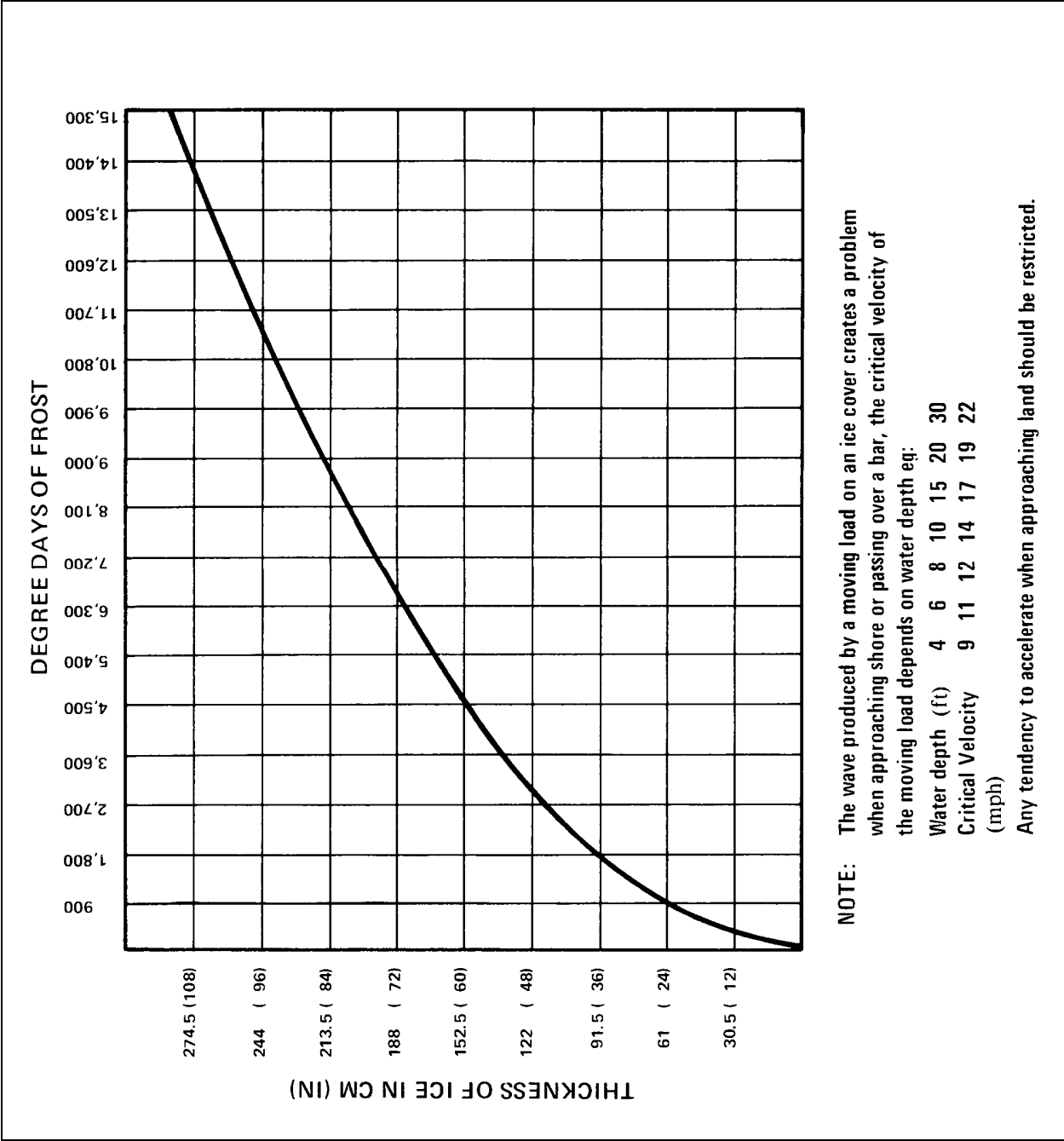

Table 5-2 Rate of Growth of Fresh-water Ice per Degree-days of Frost

## **Fords**

17. Fording streams in the north is generally more difficult than in temperate zones. The basic considerations and practices are the same but several additional factors must be considered. Low temperatures and ice conditions, especially in the stream bed during the spring thaw and the fall freeze-up, severely reduce traction. During the winter, although ice crossings are common, the fording of some streams and rivers may still be necessary.

18. In summer, the variations in stream velocity and depth are important considerations, particularly in streams or rivers from glacial or ice cap areas. Fording of such streams may be feasible only during certain hours of the day when the volume and velocity of the water are at a minimum. Traffic control is necessary to prevent the use of the ford at unfavourable times and to provide assistance when difficulties arise during actual crossing of equipment or personnel.

19. If permafrost is present in streams and river banks, the preparation of approaches is difficult. If the banks are high and steep it is not desirable to cut down approaches to the proper grade. Ramps from the bank to the stream bottom, placed with minimum disturbance of the ground surface, may be necessary for approaches and can be used when the height of the bank is not too great. Exposure of permafrost in the preparation of the approach slopes will require paving of some expedient type to permit the passage of personnel and equipment over the exposed area. The rule is to always build up from the surface/permafrost rather than digging into it.

20. The fording of streams in the winter should be avoided where possible because of the difficulties encountered in actual crossing, and the effects of water on equipment when the ambient temperatures are very low. Some streams, particularly those flowing in broad flood plains in which valley icing occurs, have open channels that continually shift about the valley during the entire winter. Valley ice is treacherous because of the shifting stream leaving unsupported sheets of ice. Equipment breaks through such ice, and is difficult to recover. The sides of open-water channels are frequently steep, and the water is deep. Passage even by heavy tractor equipment is hazardous. If such fording operations are necessary, the route should be marked with care, all unsupported ice should be removed and the route checked after each vehicle passes. Continuous reconnaissance should be maintained upstream from the ford to determine probable shifts in the water channel. The position of the active stream channel can sometimes be controlled by stream damming and diversion. The whole water channel should be kept clear to a point well below the ford.

21. Only experienced drivers should operate vehicles crossing fords in winter. Before starting across, the vehicle must be in the lowest gear necessary to complete the crossing. In low temperatures, wet brakes can freeze and immobilize a vehicle in a few seconds. The momentary stopping of a vehicle when shifting in low gear ranges in extreme cold should be avoided. After vehicle has crossed an open ford under condition of extreme cold, the wheels, rollers, engine, brake, and clutch should be warmed and dried out in a heated shelter if possible. The alternative is to keep the vehicle moving, however avoid high speeds if the windchill factor is extreme.



## SECTION 4 - CONSTRUCTION OF AIRFIELD

### General

22. The location of airfields, airstrips, and helicopter landing zones (LZs) must meet the operational requirement regardless of the construction problems involved. Construction problems can, however, be minimized by careful consideration of the special northern conditions in proposed locations, and by selection of sites in the following order of preference:

- a. existing air facilities;
- b. known natural landing sites;
- c. ground locations suitable for construction of air facilities; and
- d. ice and snow areas suitable for construction of air facilities.

### Construction Site Criteria

23. When construction is deemed necessary, the site selection must be made considering the following criteria (which are in addition to the normal criteria for temperate zone construction):

- a. Suitable subgrade soil, ground water, surface ice folds, snow, and surface drainage.
- b. A runway in an area subject to temperatures below  $-37^{\circ}\text{C}$  for prolonged periods, should be located (other factors permitting) so surface drainage and ground winds clear the runway of ice fog in the shortest periods.
- c. Major heating producing sources including groups of heated buildings should be located downhill and downwind. Apron and airfield facilities installed on the downhill side of the runway will allow surface ice to form downhill of the runway and, therefore, will not interfere with traffic.
- d. Storage space for removed snow (at least 25 m (82 ft) of open ground is required on each side of runways and taxiways).
- e. Eskers, raised beaches, and natural levees along streams make good air strips because of their elevation, and the abundance of unfrozen gravel and sand which can be used to smooth irregularities.

### Runways on Snow

24. The one type of airfield unique to the northern regions is one built on ice or snow. The present state of the art dictates treating of deep snow rather than removal. The preparation of airfields for fixed-wing aircraft depends on the snow conditions encountered. In deep snow the surface must be mixed to remove air, and then packed. With a small amount of pioneer work,

hard wind-packed areas may be made usable for aircraft equipped with ski or large balloon type tires. The deeper a ski sinks into the snow, the longer the ground run required for take off. Repeated pulverization followed by compaction will increase the density of the supporting snow structure for aircraft traffic. The density further increases with time as natural hardening occurs (a function of snow type and temperature). Runways may be constructed on shore fast ice, ice floes, or on ice islands by flooding the hollows or filling the hollows with compacted snow to form a smooth even surface.

25. The following must be considered when preparing runways on snow:
  - a. testing during construction;
  - b. provision of length and height reference items along the runway to assist the pilot in landings (barrels, trees, or even soldiers can be used); and
  - c. lighting - battery-activated lights have seldom proven satisfactory in extreme cold. Railway type fuzes stationed and lit to a pattern agreed with aircraft commanders are a satisfactory substitute.

### **Runways on Ice**

26. Ice is classified into two general types; salt-water and fresh-water ice. These types have widely different problems. A runway on salt-water ice for a given aircraft type requires double the length, and greater thickness than on fresh-water ice. Fresh-water ice is normally smooth, and has greater strength and salt-water ice. During spring break-up, use of the airfields in the early hours of the morning is recommended because normally the airstrip is in the best condition after the night freezing.

27. When aircraft are parked on ice strips or sites, the ice should be checked for deformation periodically. Distance between parked aircraft is a function of ice type, thickness, and aircraft bearing pressure. Aircraft to be de-iced with anti-freezing solutions should be moved from the runway or parking area to prevent contamination and weakening of the surface by excess solution.

### **Preparation of Landing Sites for Helicopters**

28. The amount of effort exerted towards improving sites will depend on their intended use. Little effort is required on the tundra, except in summer conditions when it may be desirable to prepare the ground with oil or some other form of soil stabilizer.

NOTE - Oil should only be used on permanent sites during peacetime, but not on islands or along shore lines.

29. In the subarctic, trees must be cut to clear a landing site and approaches. Tree stumps must not exceed 30 cm (12 in) in height because of the possibility of puncturing the bottom side of the helicopter. The obvious solution of preparing a wooded area by burning is not desirable

because of the dust problem that will be created. Landing sites may be prepared on the sides of hills by blasting a ledge, however, the slope or gradient remaining must be considered.

### **Problems of Heavy Equipment Operators**

30. During periods of extreme cold, high winds or a combination of both, heavy equipment operators are subject to adverse working conditions. This may cause frost-bite when moving at any speed in the open - requiring a change of operators on a greatly reduced time schedule and loss of clothing insulation if contact is made with POL. (Every operator must have a minimum of one full change of clothes.) A loss of clothing insulation due to POL contact is largely prevented if the clothing has a liquid repellent finish.

## **SECTION 5 - WATER SUPPLY**

### **Supply**

31. The problem of supplying water in bulk is much greater than that of individual supply, however, the operational benefits make it desirable whenever possible. The result of melting snow in tents is excessive moisture and condensation causing heavily iced tents, and wet bed rolls. The excessive use of fuel which must be man packed is a severe penalty. Melting of snow is not recommended to supply water in quantity except in an emergency. The chief sources of bulk water in the order of their efficiency and economy are: drawing from under river and lake ice, melting ice, melting snow, and well drilling (semi-permanent and permanent camps).

32. When possible, water points on lakes and rivers are located on the lee side where there is generally clearer water, less drifting snow and more shelter from the wind. Sites on lakes are located as far from the shore as possible within effective camouflage limitations. To cut holes in ice at water points, ice chisels, air tools, steam jets, augers, RDDs (beehives) or other such equipment prove most effective.

33. In extreme cold, heated shelters in which to operate water purification units are necessary, For highly mobile situations, an enclosed, heated, truck mounted unit can be used to advantage as a mobile water supply. Water supply tents should be situated on the ice directly over the hole through which the water is pumped or as close as possible thereto in order to reduce the possibility of water freezing in the intake hose.

### **Transportation**

34. Transportation of water is best carried out by tracked vehicles as the vibration will agitate the water and prevent freezing. Water cans when used should only be filled to the 3/4 full level as the movement of the vehicles will cause agitation of the water and thereby prevent freezing. Cans are stored in heated shelters as soon as possible. Sled mounted 250 to 300 gallon water tanks in which immersion type heaters have been installed, have proven satisfactory. Improvised water carriers include cardboard boxes containing plastic bags which are filled then frozen for transport.

## **SECTION 6 - BASE INSTALLATIONS**

### **Air Portable Modules**

35. The requirements for base installation at the airhead or forward base are essential during fall and winter periods. Air portable, dismantable shelters or complete units which have aluminum insulated walls avoid many of the problems of assembling modular units from panels in the field. These units can be used for operations and communications centres, air control, and logistic facilities.

### **Heated Accommodation**

36. Heated accommodation must be available at the forward base, and should be available at the airhead for the storage of equipment and supplies which must be protected from extreme cold. This includes batteries, special ammunition, rations, medical supplies, and certain spares for engineer plants. Heated accommodation must also be available for some repair and medical facilities. Air-portable electric generators should be provided where ever possible. This reduces the danger of fire and gives improved reliability for communications equipment. Water, sewage disposal, heat, and light are the responsibility of the engineers, and require special attention in relation to reliability and serviceability.

# CHAPTER 6

## COMMUNICATIONS

### SECTION 1 - INTRODUCTION

#### General

1. Military operations in the north are characterized by the employment of forces beyond the range of mutual support, and at considerable distances from controlling headquarters and administrative bases. Because of this dispersion, much greater use must be made of radio at longer ranges than in more conventional operations.
2. Despite a general lack of infrastructure in the north one of the more highly developed aspects is communication systems. Communication liaison with other agencies will greatly enhance operating capabilities. Northern Region Headquarters (NRHQ) has prepared a document, Communication Supplement on Facilities North of 60°, which should be consulted by appropriate staffs.
3. Aircraft can assist in overcoming communication difficulties caused by terrain and extreme climatic conditions by acting as airborne relays and providing air dispatch service.
4. Subsequent articles describe the factors affecting the provision of communication in the northern regions of North America with special reference to the areas affected by the north magnetic pole.

#### Environmental Problems

5. High-frequency (HF) transmission and reception, while capable of spanning the extended distances dictated by tactical requirements is subject to interference by magnetic storms, aurora borealis, and ionospheric disturbances which may completely black out reception for hours or even days. Transmission and reception under most conditions is possible, however, providing proper installation and operating procedures are followed.
6. The combined effect of terrain, cold, ice, dampness, and dust on communication equipment increases maintenance and supply problems to the extent that the utmost effort of operators and repair personnel is required to provide satisfactory communications.

## SECTION 2 - RADIO COMMUNICATIONS

### Propagation Characteristics

7. Radio communication in northern latitudes suffers from propagation difficulties, and exceptional planning steps are essential. Emphasis must be placed on the selection and use of proper frequencies. Use should be made of radio propagation graphs, charts, and prediction data for this purpose. Channel evaluation techniques should be used on northern HF circuits to the extent that equipment make this possible. Even when sophisticated sounding equipment is not available, simultaneous transmissions on several frequencies (similar to the "Fleet Broadcast") from a base station provide quite an effective means for out stations and mobiles to select the best frequency.

8. The transmission of a radio signal from a transmitter to a receiver can occur essentially in one of two ways: by a direct path between the antennae of the transmitter and receiver, called the ground wave, or by reflection from a layer in the upper atmosphere or ionosphere, called the sky wave. Since the reflective power of the ionosphere varies with the frequency and the time of day, there are limitations imposed on the frequencies which can be used. At higher frequencies (over 40 MHz) most of the energy in radio waves passes through the ionosphere and is not reflected.

9. Tactical radio equipment operating in the so called line of sight band (30 MHz and upwards - the frequency-modulated (FM) series of the tactical radio sets are included in this band) is not adversely affected by auroral activity, except as noted in this paragraph. In fact the greater ionization in the upper atmosphere which takes place during aurorals will on occasion increase the range of tactical FM sets. The use of very high frequency (VHF) and microwave radio-relay equipment will provide the best means of short-range communication in northern latitudes. Auroral reflected signals may disrupt VHF communications, especially amplitude modulated (AM) voice.

### Auroral Effect

10. The reflecting properties of the ionosphere are directly related to the density and uniformity of the earth's magnetic field. This is in turn affected by the position and radiation activity of the sun. In-so-far as radio communications are concerned, sky wave is subject to greatly increased absorption and diffusion. This results in fading, distortion, and short term black-out of the received signal during periods of intense auroral activity. The greatest auroral activity takes place between latitudes 60° and 70° North Geomagnetic Latitude, and occurs at intervals of 27 to 28 days with the highest variations being experienced during the fall/winter period. Although all frequencies up to HF are affected they are not all affected to the same degree.

### Ionospheric Disturbance

11. The effect of solar storms and disturbances on the ionosphere is world-wide, however, in arctic areas they tend to be very severe, and are felt almost instantaneously with the occurrence of the solar storm. One type of disturbance termed polar cap absorption, which is caused by solar

flare activity, can result in a complete black-out on sky wave and scatter systems for periods of several hours, and on HF during severe disturbances for several days. The effect of these storms can be greatly magnified when they coincide with periods of maximum auroral activity. For polar areas these disturbed conditions can only be predicted in general terms.

### **Atmospheric Static**

12. Continuous high-level static is rarely experienced in arctic latitudes but sporadic noise is common. Irregularly occurring and steady rushes of increasing noise frequently signify auroral disturbances on the frequency employed. Generally low frequency (LF) is less affected by this type of atmospheric noise than HF. Another source of noise is precipitation static. Flakes or pellets of highly charged snow are occasionally experienced in the north during periods of high winds. Charged particles of snow, driven against metal vehicles, masts, and antennae discharge with a high-pitched static sound that can be heard on all frequencies. This form of noise is more often encountered on aircraft radio and vehicle-mounted stations than on ground stations.

13. Very heavy shocks can be experienced from the ground lead in antennae subject to high winds or blowing snow even when the degree of audible static is not great.

### **Antennae and Grounds**

14. Difficulties will be experienced in erecting antennae in the north. The frozen ground makes it difficult to drive the antennae ground and guy pegs, and the ground plate rods. Care must be exercised in handling lead-in and metal mounts since they become brittle in the cold. Vertical antennae are preferred for ground-wave propagation in the HF band, but the use of fractional wave-length whip antennae is not recommended except for short distances. Antenna towers are easily installed on lake or sea ice utilizing toggles deployed through holes drilled in the ice for guy anchors. The underlying fresh or sea water provides a predictable electrical ground.

15. All large horizontal antennae should be equipped with counterweights arranged so as to give before the wire or poles break from the pressure of ice or wind. Wet snow and sleet freezing to the antennae may be removed by jarring the supports.

16. Ground conductivity in northern areas is generally low with ice cap, permafrost, and snow-covered terrain ranking among the poorest anywhere. At HF and below, effective ground-wave ranges are considerably reduced over this type of terrain, moreover, the efficiency of antennae is lessened when installed over this type of ground. Great care must be taken in siting to secure the best available ground, and considerable effort may be needed to build an artificial system. In no instance should more than one transmitter be connected to one ground or counterpoise, nor should electrical noise producing items such as direct current (DC) battery-charging generators or metal walled huts be connected to a receiver ground system.

17. The use of ground-plane antennae and dipoles for tactical radio must be considered in every operational plan. Telescopic type ground-plane antenna masts will increase the range of the tactical radio sets. The requirement to position the antenna at a minimum of 6 m (20 ft.) above



ground level to counter the effects of the highly charged particles of blowing snow is essential in the arctic. Command vehicles mounted with tactical radio sets should be equipped with facilities to use either a ground-plane antenna or a dipole antenna mounted on an elevated mast or tower.

18. The normal working range for vehicle-mounted tactical radio sets is 32 - 40 km. (20 - 25 miles).

### **Batteries and Power Supplies**

19. Although extreme cold effects all electrical and electronic components it has its most serious effect on batteries, eg:

- a. Dry Batteries - The conventional dry cell loses efficiency rapidly at low temperature, and decreases in capacity as the temperatures drop below 21°C. The terminal voltage is not affected by cold, but the life capacity is lowered, and the ability to supply a given voltage over a period of time falls off drastically at temperatures below -18°C. However, the capacity of a dry cell may be restored by warming it to the operating temperature. Battery warmers are provided to restore cell capacity, and insulated containers are provided to reduce heat loss during operations. Special cold-weather batteries are now available which permit a much longer life span in temperature down to -40°C. Battery packs for fixed installations such as beacons, radio-controlled runway lights or detection systems can be placed in or below lake- or sea-ice cover to provide a constant temperature environment (0°C to -1.7°C).
- b. Storage Batteries - The efficiency of storage batteries varies widely by type. Nickel cadmium batteries have the least variation through the lower temperature ranges, and therefore are a preferred power source. Batteries of the lead-acid type are less effective at low temperatures in that their ability to deliver a rated voltage falls off very rapidly with use. Under these conditions batteries must be kept fully charged at all times as they are liable to freeze. When radios are powered by vehicle electrical systems, great care must be taken to ensure that prolonged or excessive loads do not reduce the potential below that needed to operate the radio or crank the engine.

### **Electronic Warfare**

20. The low temperatures, low visibility, and the lack of ground lines in the northern region impose greater reliance upon radio type devices for command and control of ground combat forces. Radio navigational aids, so necessary because of the scarcity of landmarks, prevailing low visibility, and long hours of darkness are particularly sensitive to EW measures; this is especially true when alternative base stations are few and far between. On the other hand, the enemy must also rely upon electronic aids. A small EW unit properly employed can play a decisive role in northern operations.

21. Operators must be proficient in their trade, and a higher level of training is required so that they can recognize the difference between atmospheric interference and EW jamming.

## **Tactical Nets**

22. Command radio nets must be established first, and priority given to their maintenance throughout the tactical operation. When a unit moves out of ground range of its base of operation, rebroadcast or relay stations must be established or sky wave propagation will have to be depended upon. When it can be anticipated that distances are so long as to preclude communications with equipment normally available, higher headquarters should be requested to furnish communication support. Situations may arise where communications will not meet expectations. Alternative means such as messenger services must always be included in the signal plan.
23. The effects of the environment, including the conditions of the atmosphere, will affect the radio nets at all levels. Loss of contact drills must be initiated, and must be closely followed.
24. The establishment of air-ground nets is of major importance in all tactical operations in northern latitudes because of the dependence on aircraft for airmobile operations, logistical support, observation, and messenger missions.
25. The use of VHF - ultra-high frequency (UHF) radio relay equipment mounted on small tracked vehicles will provide the most reliable means of communications to mobile task forces at unit level. This equipment must have the same characteristics of mobility and concealment as the supported units.

## SECTION 3 - LINE COMMUNICATIONS

### General

26. Because of distances and difficulties in cross-country northern movement, major trunk lines are rarely installed. When line is employed under conditions of deep snow or at low temperatures, much longer times must be allowed for the installation of circuits, and for their restoration in the event of failure.

### Laying Line

27. Line may be laid from helicopter, oversnow vehicle, sled, or on foot. Dispensers are the normal method of laying line, however, oversnow vehicles can be equipped with reel units.

28. Line which is expected to be used for a period of time, should be treed or poled if facilities are available, because if laid on the surface it will be quickly buried by the snow. The recovery and servicing of snow imbedded cable is difficult or impossible.

29. When laid from a helicopter, a slack factor of at least 50 per cent must be allowed on level ground, and a proportional percentage in rolling or hilly terrain. Once laid by this method recovery or servicing is rarely possible and, in case of outage, the only recourse is to re-lay the line.

30. Routes for cable must be carefully selected as follows:

- a. Ground laid cable is subject to damage from heavy tracked vehicles, and is a hazard to personnel riding oversnow vehicles or on foot. Whenever possible, separate line routes should be established away from vehicle or snow-shoe routes.
- b. Cable laid over frozen lakes or swamps tends to sink and become frozen in position. When immersed, it is subject to shearing from ice movement caused by thermal contraction. Therefore, routes should be chosen which skirt frozen bodies of water.
- c. Routes for line which is to be laid by helicopter must be chosen primarily to gain reliability. In general, it is more effective to select a longer route where cable may be less prone to damage than a shorter one requiring less cable but which does not offer this advantage.
- d. Because of the difficulty of obtaining grounds, and the high resistance of the soil, circuits which utilize a ground return should not be used.

## SECTION 4 - VISUAL COMMUNICATION

### General

31. Visual means of communications are particularly effective for air to ground communication; when atmospheric conditions or security requirements preclude the use of radio; and, in mountains country where terrain presents the opportunity for optical signalling except that:
  - a. Blowing snow, haze, ice fog, and other conditions may affect the range and reliability.
  - b. The long period of near or total darkness of the winter restricts the kind of device that can be employed to those of illumination or pyrotechnic varieties.
32. Panels are satisfactory for daylight air-ground communications except that blowing snow can obliterate the signal in a matter of seconds. Light beacons are similarly affected at night, but this problem can be partially overcome by elevating the lights above the blowing snow.
33. Coloured smoke, most easily seen against a snow background, is in order: red, violet, green, and yellow. Smoke grenades, and cannisters tend to be smothered in deep snow if care is not taken to position them properly. A stick tied to a grenade will stop it from sinking in the snow.

## **SECTION 5 - HAND CARRIAGE**

### **Air**

34. Hand-carriage service should be scheduled between units, and should, if possible, be integrated with the aerial resupply missions. The use of helicopters for hand-carriage service will be common as units will seldom be located near landing areas suitable for fixed-wing aircraft.

### **Vehicles**

35. Vehicles, including oversnow vehicles, may be employed for the hand carriage of traffic. Surface travel is slow and is subject to the hazards of changing conditions. The following special conditions apply:

- a. Runners or dispatch riders must be trained in northern navigational techniques.
- b. Personnel must be dispatched in pairs with full survival gear and rations.
- c. Vehicles employed for this purpose should be radio equipped.

## **SECTION 6 - PECULIAR OPERATING PROCEDURES**

### **General**

36. Standard types of communication equipment can be used at very low temperatures with satisfactory results if precautions are taken, and the equipment is properly winterized. Provision must be made in the operational plan to include the special maintenance requirements necessitated by operations in extreme cold. As a general rule, signal communications equipment should be installed and operated in warm shelters. Warm shelters are absolutely essential for maintenance personnel. The general principle of keeping equipment warm and dry, and following winterization instructions closely will ensure the best possible performance of communication equipment.

### **Mechanical Malfunctions**

37. There are three causes of mechanical malfunctioning in communication equipment:
- a. Contraction - The various metals in a piece of equipment contract differently as the temperature falls. Plugs, keys, jacks, valves, shafts, bearings, and dials are subject to malfunctioning because of differences in rates of contraction.
  - b. Lubrication - Normal lubricants and oils become so viscose at low temperatures that they may not furnish adequate lubrication between moving parts. Special lubricants and servicing routines are needed to overcome this problem. Dial mechanisms employing fibre gears require specific attention.
  - c. Freezing - In addition to the trouble caused by differential contraction, moisture condensation which freezes in such assemblies will also render them inoperative, Moisture condensation caused by localized heating may freeze sub-assemblies during shutdown periods and render them difficult to operate.

### **Radios**

38. Upon exposure to extreme cold, receivers and transmitters adjusted for operations in a relatively warm area may exhibit, in their frequency determining circuits, changes of sufficient magnitude to impair their operation. Low battery voltage will also have a detrimental effect. All radio operators must be trained to make frequent checks for proper frequency setting (should the type of equipment allow).

### **Microphone Assemblies**

39. Moisture from breath freezes on presser switches and perforated cover plates of microphones rendering the equipment inoperative. Microphone covers must be employed, but as an expedient the microphone can be carried inside the parka close to the body. Prophylactics make excellent microphone covers.

## **Breathing and Sweating**

40. Rapid changes in temperature result in malfunctions or failures to most electrical or electronic equipment. To counter this problem the recommended policy is not to shut down the radio sets. The rapid changes in temperature are manifested by:
- a. Breathing - A radio set generates heat when in operation. When the set is turned off the air inside cools, contracts, and cold air is drawn from the outside. When this cold air comes in sudden contact with the hot equipment, glass, plastic, and ceramic parts cool too rapidly and break. Vacuum tubes are particularly susceptible to this form of failure. Radios which are operated outside must be suitably enclosed and insulated to guard against sudden changes in temperature.
  - b. Sweating - This occurs when cold equipment is brought into sudden contact with warm air and moisture condenses on the cold surface. Care must be taken in bringing radios, switchboards or test equipment into tents or shelters to avoid sudden warming. Wrapping the equipment in blankets or sleeping bags before it is transferred will check these rapid changes and the consequent formation of moisture or frost.

## **Rubber and Rubber Like Compounds**

41. Rubber and rubber-like compounds become increasingly stiff and brittle as their temperature is lowered. When cold, cordage should be flexed slowly and carefully in order to minimize breakage. When feasible, rubber items should be warmed before flexing. Power cables and co-axial cable transmission lines should be warmed before they are laid in the cold. Frequent failure of this type of cable may be expected if it is necessary to reel it in under extreme cold. Increased requirements for replacements can be expected. Where possible, contact of rubber items with fuel and lubricants should be avoided.
42. Extreme care must be taken in handling insulated wire or cable at subzero temperatures as the insulation tends to become stiff and brittle and is liable to cracking. Standard friction and rubber tapes tend to lose their adhesiveness when subject to extreme cold; special cold-weather type electrical insulating tape is available and may be used without pre-warming. Splicing of field wire and cables is a problem because hands must be protected by mittens or gloves which restrict handling.

## **Supply**

43. More frequent breakdown, and the longer time lag for repairs, necessitates unit holdings of larger pools of replacement equipment and spare parts. Where these stores cannot be moved into the operational area, they must be readily available for call-up from the forward or supporting base.
44. For best results dry batteries should be stored for issue at temperatures between  $-12^{\circ}\text{C}$  and  $2^{\circ}\text{C}$ , and must be slowly warmed to  $21^{\circ}\text{C}$  before use. Batteries, which have been permitted

to cold soak at lower ambient temperatures, require heating for a considerably longer period of time before they are ready for use.



## CHAPTER 7

# TACTICAL AVIATION

### SECTION 1 - INTRODUCTION

#### General

1. While operating conditions in the north frequently inhibit the use of aircraft, the alternative surface movement is such an enormous undertaking, except in very limited circumstances, that the only really viable option to air in many circumstances is to wait. It can therefore be said that aircraft are nearly indispensable for operations in the arctic, and invaluable in subarctic operations. The general principles for employing tactical air support as described in the CFP 311, Tactical Air, series of manuals, apply equally well in northern operations. However a comprehensive understanding of the use of air, and the effect of the environment on tactical air support operations in the north is a particularly essential qualification of command and staff deployed in the north.

#### Weather

2. The best season for flying operations in the north is late winter, (February to May) although this varies slightly with the latitude. During this period there is an increasing amount of daylight, surfaces are generally still frozen, and there is not sufficient open water to cause long periods of fog, low visibility, or indistinct horizons. The weather is mainly clear and cold, but temperatures have moderated to some extent.

3. During the short summer season, air operations can be carried on but with increasing amounts of fog and low cloud formations over the ocean. Icing conditions are more likely, and ice crystal haze is sometimes present. Landings, except those on prepared surfaces become increasingly difficult. Visibility is improved somewhat in late June and most of July over continental areas, but is never as good in the summer as in the winter. Visibility in the arctic islands deteriorates quickly after early July because of fog blowing in from the open water.

4. With the freeze-up in late September, landing conditions gradually improve. However, by the time the fog problem moderates, there is very little daylight, and night operations must be undertaken. Extreme low temperatures make their appearance in mid-winter, and increase the difficulty of carrying out operations.

5. The major restriction to aircraft operations in the winter, besides the cold temperatures and regular droplet fog, is ice fog. Although it is not more hazardous to aircraft operation than ordinary fog it presents a serious problem because of its frequency of occurrence, and its tendency to persist for extended periods. Ice fog normally will be found in the vicinity of populated areas at temperatures of  $-37^{\circ}\text{C}$  or lower but may occur at temperatures as warm as  $-5^{\circ}\text{C}$ . Visibility in ice fog may be reduced to almost zero at ground level, however ice fog usually does not rise above 30 m (100 ft). It can be self-induced by rotor systems and engine exhausts.

Ice fog frequently takes from 15 to 30 minutes to dissipate after aircraft take off, but does not cause icing of aircraft because no water droplets are present.

6. Lack of daylight restricts short take-off and landing (STOL) aircraft operation on unlighted strips during the winter months, reducing the present ability to land within 16 km (10 miles) of any point in the arctic islands to one of landing only at occupied stations for four months of the year.

7. Some degree of turbulence is frequently present in mountain passes, and when this condition is severe, flights are prohibitive or lengthened considerably by the need to choose alternative routes.

## SECTION 2 - FLIGHT OPERATIONS

### General

8. In addition to the weather factor it is necessary to be familiar with other conditions, coupled with the observance of proper precautions, helps to reduce much of the danger of operations in the north.

9. Because of the cold dense air, density altitude is low and aircraft performance is greatly enhanced. However, pilots must study operating data charts carefully to ensure that recommended power settings are not exceeded in low temperatures.

### Planning Factors

10. The payload capability of aircraft is reduced in northern areas due to the added aircraft weight caused by ski or float installation and required survival equipment. The long distances envisaged between suitable airfields will impose limitations in the use of air support. Fuel loads will be higher because of the long distances from the supporting airfield to the forward bases and lodgement areas, and the long distances to alternative airfields. In some cases the alternative airfields may very well be the take-off airfields. This reduction in pay load may be offset in most instances by the increase in aircraft performance due to the favourable density altitude conditions.

11. Higher fuel consumption caused by lengthened warm-up and fuel burning heaters must be considered when planning use of aircraft. On extended flights, refuelling becomes a major problem in the north because of the long distance and inability of surface transport to move fuel to isolated points.

12. The climatological history of the operational area should be studied to determine the probable frequency of poor weather conditions which will limit or preclude flight operation.

13. Information as to all airfields, air strips, and emergency strips in the area of operations must be made available to the task force commander and the air commander. Particular attention should be paid to eskers and raised beaches. Many eskers provide emergency landing strips for both light and medium aircraft. Most eskers run north-west to south-east directly in line with the prevailing winds. These areas are particularly valuable during summer periods when they are fully drained, and during the fall season before the presence of snow drifts make them unsafe. During winter periods, where a frozen lead is surrounded by long ridges it is usually an indication that the ice covering is at least thick enough to support light aircraft.

### Navigation

14. Low level navigation is most difficult due to the similarity of the terrain, and the lack of detail on many maps. In winter, the arctic appears to be a vast expanse of snow and ice; very little of the ground can be seen and winter storms drift snow into gullies and valleys obscuring these

features. Consequently details of the landscape are lost and many features indicated on topographical maps such as shorelines and coastlines are not recognizable.

15. Lakes, which abound in many northern areas, may be used in conjunction with pilotage, however, during the spring thaw, the number of lakes in some regions is multiplied, making accurate identification extremely difficult because of the changes in outline caused by the snow drifts. Pilots must ensure proper orientation at all times.

16. At very high magnetic latitudes, the magnetic compass becomes less reliable because of the proximity to the magnetic pole. Low precession-rate directional inertial systems should be used.

17. Visual navigation during the hours of darkness is extremely difficult due to lack of lights in the sparsely populated country, although reflection from snow-covered terrain serves as an aid to visibility under some circumstances. Navigation through mountain passes after dark under overcast conditions is not recommended except in emergency.

## **Safety**

18. Over the Arctic Ocean and along the coastal areas, the main hazards to aircraft operation are blowing snow and strong surface winds during the autumn, and winter and fog during the summer. Blowing snow is a hazard in all operations but especially hazardous in hovering operations. For this reason, hovering of helicopters should be kept to a minimum. This restriction to visibility may be deceptive to the inexperienced pilot, because the shallowness of the layer of blowing snow usually permits good vertical visibility while, at the same time, the horizontal visibility is very poor within the layer.

19. The very low temperatures and non-standard lapse rate in the arctic causes major errors in altimeter readings. As in all flight operations, pilots must give due regard to the effects of variations of mean sea level (MSL) pressure. Well developed lows and intense anticyclones can be found in the arctic. In fact, pressure can be so high that altimeter sub-scales may not be able to register in that range.

20. Caution must be exercised during external sling load or hoist operations in snow or dry cold air since static electricity is generated more quickly, and at higher voltages, than in operations in higher humidity. Aircrew must ensure that proper grounding of the aircraft is carried out during take-off and landing procedures, and during loading activities. Personnel should receive extensive training in night external loading operations. Lack of visual horizon, blowing snow, and the fact that use of the aircraft lights causes loss of visual reference makes this work extremely dangerous.

21. Windchill factors should be studied, and all personnel should be aware of the very high chill factors encountered in propeller and rotor wash.

22. When operating in mountainous terrain, wind direction and velocity may be indicated by observing drifting snow - swirling actions indicate turbulence.

23. Closer attention to detail in aircraft operation is necessary not only because of the greater strain placed on the aircraft by low temperatures, but also to reduce mechanical or material failure inflight.

## SECTION 3 - AIRCRAFT MAINTENANCE AND FACILITIES

### Maintenance

24. The problems of Increased maintenance stem directly from the low temperatures. Special precautions and equipment are necessary to ensure efficient operation of aircraft. Maintenance time factors may be multiplied by five in areas of extreme cold. Aircraft mechanics are greatly hampered by the heavy winter clothing and gloves. Installation of auxiliary equipment such as winter cowls, oil dilution systems, personnel heaters, and covers also adds a time factor to normal maintenance operations. Maintenance units usually require additional personnel in the airframe sections.

25. Operation of aircraft, particularly helicopters with their inherent vibrations, in temperatures below  $-37^{\circ}\text{C}$  results in a marked increase in metal fatigue. All metal becomes increasingly brittle as the temperature decreases. This will be evidenced by an increase in the number of skin cracks in stress areas. Careful attention must be devoted to these areas in all stages of maintenance. Seals and gaskets are a special consideration because of the effect of cold on contraction of metals and certain other material.

26. Thickening of oils at low temperatures presents problems in operation and starting. Standard winterization kits should be installed. Oil dilution units may be used although it is sometimes necessary to drain the oil from the engines at the end of the day's operations, and to heat it prior to replacing it in the engines.

27. The standard portable combustion type heater, incorporating a blower and flexible hose for application of heat to localized areas, may be used for preheating engines before starting. In addition to preheating before starting, these units may also be employed to heat specific positions of the aircraft so that maintenance personnel can work without gloves. When temperatures remain below freezing, aircraft batteries not in use should be removed and stored in a warm place.

28. Mooring of aircraft is made relatively simple in regions of extreme cold by the expedient of placing one end of a rope on the ground, covering it with snow, melting the snow, allowing it to freeze, and then mooring the aircraft. So far as possible, wheels or skis should be kept on dry surfaces to prevent them from freezing to the ground.

29. Wing and engine covers are essential in northern operations if time involved in removing snow, ice, and frost is to be avoided. Covers serve a secondary camouflage purpose when they are coloured to blend with the background. It is impractical to attempt any maintenance that necessitates ground crews being bare handed for more than a few moments unless the machine is shielded to some extent and the work area is brought up to perhaps  $-17^{\circ}\text{C}$  or warmer. With hanger space nearly non-existent in the arctic and scarce in most areas of the subarctic, maintenance may have to wait for the construction of temporary shelters, preferably fast-built prefabricated buildings.

## **Facilities**

30. When selecting areas for aircraft facilities (servicing, arming, loading, etc) the following must be considered:

- a. tactical and logistical usefulness;
- b. engineering problems (see Chapter 5);
- c. protection from the weather; and
- d. supply considerations, especially those of aviation fuel and munitions.

31. Before the occupation of a selected site, adequate billeting and working areas, roads, and snow parapets should be prepared. If available, prefabricated buildings greatly lessen the time required to build adequate shelters. If maintenance personnel are to be exposed to the weather in servicing and/or repairing aircraft, shelters near the work area are necessary.

## **SECTION 4 - CHARACTERISTICS OF AIRCRAFT**

### **General**

32. Fixed-wing aircraft, either single- or multiple-engined, with wheels, skis, wheel/skis, floats, or wheel/floats are all used by the CF in the north. The important characteristics of several classes of aircraft currently in use are discussed in the following articles.

### **Light**

33. Light aircraft such as the single and twin Otter are suitable for use since they can land in short distances, and can be fitted with a variety of landing gear. They are reliable to operate, and reasonably easy to maintain. Light aircraft provide acceptable coverage for medical evacuation from emergency strips, resupply of long-range ground patrols, carrying of messages, and air reconnaissance.

### **Intermediate**

34. The CC115 Buffalo with its twin engines, truck bed height rear loading capability, STOL performance, and full instrumentation can be a very useful troop carrying, and logistic support aircraft for northern operations. This aircraft was built for field operations, and can operate with a minimum of ground support equipment. Because of its large cargo capacity this aircraft is ideal for resupply of company group size forces. Air drop and air-landed techniques are used.

### **Heavy**

35. The C130 Hercules is used by both civilian and military operators throughout the north. It has a truck bed height rear loading capability, STOL performance, and can operate from rough strips. The large load capacity and reliability of this aircraft make it an ideal transport aircraft for northern operations. It is capable of carrying out air drop and air-landed tasks. Normally the C130 will be the primary aircraft tasked to carry out the deployment and redeployment missions, and resupply from the supporting base to the forward base. When field facilities are adequate and the airhead is assumed safe from enemy action they can deliver direct.

### **Helicopters**

36. Light, medium utility, and heavy helicopters can be used on northern operations. The drawback in the past has been a lack of instrument flying capability, lack of navigation facilities, and short range. New helicopters are turbine powered, and have an instrument flying capability. The light and utility helicopters can be carried in C130 aircraft to forward locations, thus to some extent overcoming their range limitations. Helicopters are now carried on ships operating in arctic waters. Under some circumstances helicopters may be the only practical way of moving troops and supplies from one place to the other in the arctic. When provided with floats or floatation gear, they are capable of landing virtually at will on any relatively level surface.



## **Fighters**

37. Fighter aircraft can be employed in support of Canadian operations in the north, providing suitable airfields are available. The operational range can be extended by air-to-air refueling.

# **CHAPTER 8**

## **OPERATIONS - GENERAL**

### **SECTION 1 - INTRODUCTION**

#### **General**

1. The previous chapters discuss a concept of operations in outline, the special problems presented by the environment, and how particular elements of our forces deal individually with these problems. The purpose of all that information is to provide commanders and staff with sufficient background knowledge to cope with operations in the north. The provision of information is of no value until it can all be pulled together and applied as tactics on the battlefield. Chapters 8 through 10 describe how the background data can be applied.
  
2. Before discussing particular phases of war, and types of operations the remainder of this chapter deals with certain preliminary and supplementary activities related to launching troops into battle, ie, planning, intelligence, and security.

## SECTION 2 - PLANNING

### Factors

3. There are four main factors which must be considered when planning a northern operation:
  - a. The enemy - We must consider his strength, capability, intentions, and actions to date. More detail on how this can be accomplished is in Section 3.
  - b. Terrain and weather - The geographical location, time of year, and prevailing atmospheric conditions.
  - c. Access - Consideration must be given to methods of reaching the enemy, eg, road, sea, air (including type of airlift and availability of prepared airfields, drop zones (DZs) or LZs).
  - d. Lift available - Following from method of access, a study must be made of the numbers and types of transport available.
4. When the above factors have been examined, an outline plan should emerge which will indicate the composition of our own forces, method of operation, probable duration, and long-range requirement (eg, extraction, reinforcement, etc).

## **SECTION 3 - INTELLIGENCE**

### **Essential Elements of Information**

5. In all operations, essential elements of information (EEI) concerning enemy locations, strengths, and intentions are required. In the north an assessment of the enemy's capability to move and fight becomes a critical EEI. A check list that can assist in the formulation of an assessment is at Annex B.

### **Other Intelligence Requirements**

6. Detailed knowledge of the terrain and climatology in the area of operations is essential. The location and condition of the existing road net and railroad, if any, must be determined. Information regarding soil trafficability, vegetation, water routes, expected ice thickness, snow conditions, wind velocity and direction, and average snow depths should be available to the commander as well as the general features of the terrain from a cross-country movement viewpoint. For summer operations it will be necessary to determine water routes in some low-lying areas, and dry ground routes in barren lands.

7. The great effect of weather on military operations in northern areas makes it mandatory that continual and accurate weather forecasts be rapidly disseminated to the lowest level.

8. Data banks (such as that maintained by NRHQ) and area briefs will greatly assist the collection, holding, and dissemination of information.

### **Intelligence Collection**

9. Collection agencies used are essentially the same as in temperate zones although their methods may be different. Increased emphasis must be placed on air reconnaissance.

10. It is especially important during the planning phase of northern operations to secure detailed information of the operational area from strategic intelligence agencies. Every effort should be made to procure basic air-photo coverage for each season. An infra-rad capability during long winter nights, and a photographic capability during full periods of daylight are essential.

11. After operations are initiated, some collection means, such as long-range patrols, are more valuable than usual in obtaining information deep in enemy territory. Vehicle-mounted long-range patrols provide not only information but a threat to enemy installations with the resulting increased security measures necessary. During seasons when waterways are open, boat patrols may be useful in gathering information.

12. Intercept of enemy radio communications will provide a good source of intelligence.

13. Unattended ground sensors and ground surveillance radar can be employed during the summer season in the same manner as they are used in other areas of the world. Their use during

the extreme cold of winter may be limited because of battery failure caused by the temperature. Battery packs and electronic assemblies may be deployed in or below the ice cover of lakes or sea or within the active layer of the permafrost to provide a constant temperature environment (0°C to -1.7°C)

14. In northern Canada, local inhabitants, Canadian Rangers, RCMP, ham operators, Hudson Bay Company employees, church organizations, other government departments, and pilots of local aircraft are all critical to the intelligence collection plan.

### **Battle Indicators**

15. Personnel must be aware of battle indicators that are present in cold weather, and the northern environment. These indicators can be broken down into two categories - those that indicate the presence of a hostile force in the area, and those that indicate the size of the force. If these indicators are recognized by the intelligence staff, the tactical commander will receive an accurate intelligence estimate on which to base his decisions. A check list that can assist in the formulation of this estimate is at Annex C.

### **Patrolling**

16. Patrolling to provide information on the enemy, and to provide our own security will increase in importance since combat units will often be separated by greater than normal distances.

17. Reconnaissance and fighting patrols may operate for extended periods depending upon climatic conditions, and the capability to provide support. Foot patrols should be self sufficient for 3 to 5 days while mobile patrols should remain much longer. The duration of all patrols will depend on the reliability of supply drops or availability of pre-arranged fuel caches.

18. The most economical way to move long-range patrols into enemy territory is by aircraft. Patrols should be deployed immediately prior to anticipated adverse weather conditions so the patrol will gain the extra security required at the start of the mission.

19. In long-range patrolling, communications are a prime consideration, with radio being the principal means. Because of extended distances and difficulty in radio transmission in northern areas, aerial relays or message pick up, and drop techniques may have to be used.

### **Deception**

20. Deception has an important role in northern warfare. The deception plan is formulated at the highest practical level. False trails are made to mislead the enemy as to the size of the force, direction of movement, and scope of activity. Rules must be established such as single file to conceal the number of troops, restricting the blazing of new trails, and the use of individual warming fires. Open camp fires can be started in dry tree stumps in the subarctic areas to deceive the enemy as to the size and location of a force. Dummy gun positions can be constructed, snow and logs can be used as substitute materials. Sound and flash simulators should be used in gun

positions to give them a semblance of reality. All deception missions must be well planned and coordinated at the highest possible level of command. The use of electronic deception, in coordination with tactical cover and deception is essential in concealing the location of major headquarters and operating elements.

## SECTION 4 - SECURITY

### General

21. Tactical security measures employed in normal operations remain essentially the same in northern operations. Because of the long period of winter darkness, and the tendency for sound to travel great distances in cold air, light and noise discipline is even more critical than normal.
22. Security of airfields is of paramount importance in northern operations. Enemy air landed or parachute operations are always a possibility. The commander should consider the use of a mobile force capable of reacting to light airborne operations. This force should be used on the LZ itself during the actual drops, and should the enemy leave the LZ it must be employed as a harassing force to disrupt his planned activities by fire power.
23. Security of lines of communications is difficult because of the distances involved. During periods of darkness, and during storms or inclement weather, columns should move closed up with protection vehicles interspersed in the column. During clear weather, convoys must remain well dispersed if there is an air threat. In the tundra regions the protective vehicles should move out as flank guards and/or patrol to protect the column.
24. Security must be practised in communications: this means proper voice procedure, and radio traffic kept to a minimum. This will limit the value of intelligence gained by the enemy, and reduce the probability of direction finding by enemy patrols.
25. Security of any defensive area can best be achieved by mobile patrols, and also standing patrols tactically sited well out from the positions.

### Camouflage

26. Good camouflage discipline will enhance protection. The problem is most acute during winter because of the sharp contrasts, and the creation of ice fog by weapons, engines, etc. Special white clothing and camouflage nets are issued for winter use. The practice of painting equipment and installations an off white will contribute greatly to the overall camouflage effort.
27. Large installations such as air fields will be difficult to camouflage in winter, and stress may have to be placed on deception. Vehicle tracks are a dead giveaway in winter, and almost impossible to conceal. Track discipline and deception must substitute for camouflage in this area.
28. The general colour of the snow-covered terrain is blue gray. When the snow is disturbed it takes on a flat, white appearance and is easily identified. Camouflage of positions should therefore be based on breaking of the outline, and leaving rough snow conditions in the front of the position. Blowing snow will level and/or fill in the rough snow conditions and result in a better camouflaged position.
29. The proper mix of camouflage clothing in the tree line is mandatory. Above the tree line the use of all white clothing is essential in winter. In the barrens during winter periods, the

grouping of personnel, whether stationary or moving, must be considered. Long, continuous lines of evenly spaced troops are easily observed. Troops should move in small groups unevenly spaced, making use of the terrain and background. In rocky areas or when moving along eskers, the selection of two or more routes is sometimes preferable. During winter months, the practice of camouflaging personal weapons by means of paint, white adhesive tape or strips of white cloth breaks the outline and conceals the troops.

30. The point of consideration with clothing is that a penalty is paid for the body protection with respect to vision and hearing. The parka hood reduces peripheral vision and, in conjunction with high winds, reduces the hearing ability of the troops. These factors, when combined with the requirement for the buddy system as a protection against frost bite, dictate an increased requirement for personnel as guards, sentries, on patrols, etc.

31. Summer presents a different set of problems in the north. The presence of permafrost in many areas will restrict the amount of digging that can be done, and the defences will be built up using peat, rock, etc. Winter camouflage materials will have to be exchanged. In the subarctic, natural vegetation will be available to supplement issued materials, but this will not be the case in the barrens. Desert camouflage techniques will be necessary in the barren lands, and on the arctic islands. This will include use of tone-down paint, covers for wind-whields and other highly reflective objects, use of shadow and broken ground, etc. Again dispersion and deception will be necessary to supplement camouflage.

32. Camouflage is an individual responsibility at all times, however, a camouflage policy will be provided by the highest tactical headquarters. This policy will include guidelines as to the amount of effort, eg, engineer assistance, that will be devoted to camouflage.

### **Concealment**

33. On clear days the opportunity for natural concealment in the arctic areas is much less than in the temperate zones. In the subarctic the terrain and vegetation are not significantly different from areas further south. In addition to the normal protection afforded by darkness, the north provides other natural phenomena which can be utilized for concealment, ie, fog, snow and blowing snow, white- and grey-out, etc.

34. Whenever possible, advantage should be taken of natural vegetation for its concealment value. Snow caves and shelters should be used in lieu of tents when practical. Terrain must be used to best advantage when selecting lines of advance, harbours, etc. Clear air and flat terrain increase the distance over which visual observation is effective. Folds in the ground, river valleys, etc, must be utilized whenever possible, but the best cover is afforded by storms, fog, etc. Extensive training must be undertaken in navigation under extreme conditions in order to take advantage of the concealment opportunities provided.

### **Identification**

35. Long periods of reduced visibility, and the use of white camouflage clothing under snow conditions make identification difficult. Increased vigilance is necessary on the part of all ranks.



Unit standing operating procedures (SOPs) must provide for rank/position indicators of some sort. Contrasting color tape, sew on or tie patches, position of symbols, are some means of achieving identification.

# **CHAPTER 9**

## **OPERATIONS**

### **SECTION 1 - INTRODUCTION**

#### **Scope**

1. Operations in the Canadian north, under current concepts, call for the application of both the normal and particular tactics. The particular tactics are based on the enemy threat, the composition of our own and allied forces, and the environmental factors. This chapter examines offensive, defensive, and retrograde operations, with emphasis on the modifications imposed on them by environmental conditions, and then describes the particular tactical concept in a specific set of circumstances. Air-mobile operations, and combat under conditions of a chemical-nuclear threat are also discussed.

## **SECTION 2 - OFFENSIVE OPERATIONS**

### **General**

2. Offensive operations are directed towards the destruction of the enemy forces. Ideally the objective in northern operations is not to pit rifleman against rifleman but rather to destroy the enemy with fire or with the elements. Actions will be sudden, violent, and decisive. Both forces will strive to retain freedom of manoeuvre. Due to the large operational areas, flanks and rear areas are normally lightly defended. These present excellent targets for envelopment or turning movements.

3. Both sides will be heavily dependent on their lines of communication, and thus must disperse protective elements to ensure they are not severed. Small, well lead forces can cause havoc by attacking these lines, as the severe winter weather will hasten a forces' destruction when its supply lines are cut. A commander must ensure that his own lines of communication are secure and look for opportunities to disrupt those of the enemy. During summer, objectives should be selected where the lines of communication cross a river or pass between two existing natural barriers.

4. Bad weather conditions increase the opportunities for surprise attacks. These include the exploitation of falling snow, blizzards, fogs, low cloud cover, and natural light illumination. Imaginative use of what appear to be weather obstacles may turn them into major advantages. However, conducting offensive operations during severe weather conditions will restrict the use of air support, and increase reconnaissance and control problems.

### **Planning**

5. A commander must inform his staff officers as early as possible of all aspects concerning his concept for offensive operations so that an operation order can be formulated as far in advance as possible. This applies particularly to the administrative staff whose arrangements for logistical support are certain to require additional time in northern operations.

6. Reconnaissance is initiated early over a wide area with as its mission the determining of enemy locations, and examination of routes and terrain, including terrain in enemy hands. The use of aircraft for reconnaissance must always be considered.

7. The opportunity for manoeuvre is usually present. Main attacks usually are directed against the flank or rear areas, while supporting attacks are directed against the enemy front to hold him in position. An additional force may be employed to bypass the enemy position and cut enemy routes of reinforcement or withdrawal. The most mobile troops are used to rupture the enemy lines of communication.

8. The assault should be conducted at night or during periods of low visibility. Surprise is an important factor, and the opportunities for achieving it are numerous. It may be quite feasible to deliver the assault without preparatory fire, but fire support must be available.

9. The communication plan is made in detail, and must provide measures for overcoming difficulties particular to northern operations and the northern environment. At times, distances between two attacking forces may become so great that messages must be relayed. Radio-relay stations must be provided, and aircraft considered as relay stations for ground tactical radio communications, weather permitting.

10. When attacking, units may have large gaps between them, and their flanks are vulnerable. Flank protective requirements increase. Basically, however, security requirements in the offence are not different than in the temperature zones. Low troop density throughout the battle area, plus flexibility in route selection reduces the chances of encountering the enemy without warning.

### **The Deliberate Attack**

11. When reconnaissance is completed, the other preliminary measures are taken for the attack, trails are opened to assembly areas. If this distance is not too great, these trails are not opened until the day before the attacking force starts to move at the earliest. Line communications, when used, are laid simultaneously with the breaking of trails. Movement to assembly areas is executed during periods of darkness or low visibility. Guides may be required. Boundaries may be used of terrain permits designating discernible features. In barren, flat terrain, a bearing may be given to indicate the direction of attack.

12. The attack may be conducted by infantry on foot, skis or snowshoes, or transported by personnel carriers or helicopters. When the attack is conducted on skis or snow-shoes, the attack formation should be that which allows use of trails broken by the lead elements of the attacking force. Every attempt is made to get as close as possible to the enemy before delivering the assault. When possible, the attack on snow-shoes should be conducted down slope with the wind on the attackers back. Troops do not halt to fire until reaching the assault position or until enemy fire becomes effective. Assault lines should generally be closer to the enemy during winter than during summer, especially if the assault is made in foot through snow. The decision as to whether the assault is to be conducted on skis, snow-shoes, or foot must be made by the commander, based on existing conditions. If skis or snow-shoes are removed during the attack they must be brought forward during reorganization.

### **Reorganization**

13. After seizing an objective, immediate attention must be paid to consolidation. The assaulting troops may be fatigued and over-heated from the exertion of the attack. Provision must be made to prevent them from becoming cold casualties. Tent group equipment should be moved forward immediately.

14. In continuing the reorganization, special efforts are directed toward rapid displacement of close support weapons using sled or vehicles. Routes are prepared as far forward as possible to facilitate distribution of required combat supplies.

## **Exploitation and Pursuit**

15. The exploiting force is aided by cross-country vehicles and aircraft. Airborne or airmobile troops are positioned near defiles to block the retreat of the enemy. During summer, waterways may be used by the pursuing force as a means of moving patrols behind the enemy to destroy bridges, and to erect road blocks along the enemy lines of retreat.

## **SECTION 3 - DEFENSIVE OPERATIONS**

### **General**

16. While the current threat to the Canadian north does not appear to be of such a size as to place our forces into a major defensive posture, defensive operations may be conducted by elements near the enemy lodgement, during the build-up of our reaction forces or to contain the enemy in a specified area. In addition, thorough knowledge of the problems of defence will enable the commander of an attacking force to better analyze his enemy's actions or alternatives.

17. In northern operations it may be necessary to assume a defensive posture for short periods during break-up or freeze-up seasons, snowstorms, or extremely low temperatures. The defence may also be adapted to encourage an enemy to attack under conditions of our choosing, such as into long narrow passes, into deep snow, or across obstacles where movement is difficult.

18. In the north it is envisaged that our forces would be involved in the defence of a continuous line. The defence would be based on a series of strong points covering roads, communication centres, and approaches that might be used in the event of a major enemy advance. The gaps are covered by patrols. For this defence to be successful, strong mobile reserves are necessary so that the enemy can be prevented from attacking each strong point in isolation and destroying it. Enemy approaches to strong points must be blocked by obstacles, covered with fire, or destroyed.

19. Every well frozen river or lake must be covered by patrols, the more important ones being covered by fire. They may be turned into obstacles by laying of mines in the ice or in extreme cases by using artillery fire to break it up.

20. Every detached subunit or installation must maintain an all round defence on the move or at rest. Retention of airfields and DZs is of paramount importance so that troops temporarily cut off can be resupplied.

### **Planning Considerations**

21. Defensive operations are difficult in extreme cold, but an enemy force is much more exposed to the elements, especially if warming equipment and other logistical support has not accompanied him. The break-up season is favourable to the defender.

22. Special attention must be paid to maintaining battle readiness in winter. While resting in positions, men must be ready for immediate action. Firing positions must be kept clear of snow. Sentries must be rotated and inspected constantly. If defence is to be of long duration, heated shelters should be constructed and tents eliminated.

23. An enemy offensive will probably begin with extensive probing in depth to locate and define our strong points, the gaps in our defensive layout, or to disrupt supply lines. Next, he will attempt to isolate and destroy strong points that block his advance. Such attacks will probably be preceded or accompanied by deep penetration elements operating to cut and block routes, destroy

headquarters and gun areas, and harass or disrupt the employment of reserves. The battle will likely consist of a series of seemingly unrelated actions fought over a relatively wide area. The aim of the attacker will be to destroy the integrity of the defence by first isolating strong points, and then to destroy the reserves sent in relief, only then will he actually attack the strong point.

### **Conduct of the Defence**

24. The aim of the defender must be to maintain the integrity of his defence, remembering that the attacker must expend more energy on survival than the sheltered defender. The longer the defence holds, the better off it is. Integrity can be maintained by:

- a. ensuring that strong points are strong enough to defeat the initial enemy attacks, and do not become isolated;
- b. not committing reserves until the enemy has partially exhausted himself, and ensuring that, when reserves are committed, they are sufficiently strong with at least equivalent mobility to the enemy; and
- c. acting offensively to disrupt enemy supply lines, harass his headquarters, and interrupt attacks before they can be mounted.

25. Counter-attacks should be of short duration, and executed to hit the flanks and rear of the enemy once the enemy has exhausted himself, and the cold is beginning to take its toll.

26. Because of the vulnerability of a force occupying tents or shelters, a company group is considered the smallest element that can make itself secure and give its troops sufficient rest. Strong points will therefore be organized using the company as the base. In general, company frontages will be narrow, possibly only 100 to 200 m (330 to 660 ft). Companies deployed in a strong point must be mutually supporting, and have all around defence. Positions should be covered by observation posts, mines, wire, and obstacles constructed from local materials. A strong point must be able to continue fighting even when isolated by enemy action or bad weather.

27. Defensive positions sited in deep snow suffer fewer effects from enemy fire. Thick forest, fallen timber, cliffs, and other natural hindrances to movement collect snow and create obstacles to the attacker. Strong points should be located on the high ground, particularly during winter, as the enemy must then attack uphill in snow.

### **Location of Reserves**

28. A high proportion of the force must be held in reserve during winter operations. This reserve must have the maximum cross-country mobility provided by helicopters, personnel carriers, and oversnow vehicles. Reserves must be held centrally where they can react quickly to any, part of the defended area preferably in covered or concealed positions.

## SECTION 4 - RETROGRADE OPERATIONS

### General

29. Although current concepts and the threat to northern Canada do not foresee an extensive need for retrograde operations, the principles of these operations must be understood. There may be a need for local withdrawals, retirements or delaying actions as the tactical plan is executed to lure the enemy onto ground of our choosing or to contain his advance.

### Planning Factors

30. The long hours of darkness in winter will provide cover for the withdrawal or the delaying action, but in summer much of these operations will have to take place in daylight. Maximum use must be made of fog, blowing snow, and sleet storms to cover these operations. Timings should be more flexible than in conventional operations, and report lines close together.

31. The enemy's capability for oversnow movement and his aggressiveness will be the primary considerations in our choice of routes, delaying positions, and allocation of troops to security tasks. The shortage of routes and the problem of keeping them open in the winter can be partially overcome by having the infantry move across country initially, and then, when possible, withdraw by air. The infantry moving across country may also provide flank security for other elements.

32. Trails should be broken rearward from positions before the withdrawal begins, and mined as the rearguard withdraws. Any possible shelter that the enemy could use should be destroyed. If the security of the forthcoming withdrawal does not allow this, then shelters must be booby-trapped and mined.

33. In winter, the long hours of darkness, the deep snow, and the terrain should all assist in successfully breaking contact. It is principally during actual withdrawal that the enemy, using his cross-country capability and air power, may seriously interfere with the withdrawing troops, particularly those that are road bound. Engineer resources must be positioned to deal with sudden snowfalls resulting in route blockage.

34. When withdrawing troops are attacked they should not allow themselves to be drawn into chasing the enemy into areas where they are susceptible to ambush. They should rather restrict themselves to fending off the attack.



## SECTION 5 - PARTICULAR TACTICS

### General

35. The nature of the threat to northern Canada, the size of the possible areas of operation, the hostile environment, the limited availability of our troops, and the difficulties of moving and supporting any force in the North, all mitigate against the employment of large formations in this area. For political as well as military reasons, it is more likely that our operations against a lodgement will be executed by relatively small forces who must achieve their objectives quickly with the minimum of losses. To achieve this aim we must take advantage of our strengths, and also attack the enemy at his weakest point.

36. Any enemy conducting sustained operations in the north will be forced to establish long strategic lines of communication and supply. These will be most vulnerable to disruption by our forces, and to the degrading effects of climate and the harsh terrain. He will be dependent, to a great degree, on local logistic support to seize his initial objective and will be largely confined to a specific geographical area.

37. Capitalizing on our knowledge of the north, and our skills in fighting in this austere locale, our forces will make the maximum use of the climate, and the physical environment to weaken and degrade the enemy's combat power to the point where he "withers on the vine" and loses the capability to effectively resist.

38. A commander must aim to:

- a. locate and define the enemy lodgement;
- b. contain the enemy and isolate him from his support;
- c. harass him by destroying his shelter and supplies, deprive him of sleep, food, and warmth; and
- d. destroy the lodgement when the enemy is weakened.

39. If the enemy tries to avoid engagement by moving, he makes himself even more vulnerable as he must either relocate his logistical base or separate from it. If he decides on the former, he exposes his essential stores to air attack; if he decides on the latter, he must open up local lines of communication which will consume more resources of combat power. In either case he is liable to defeat in detail as our local knowledge, shorter lines of supply, and more available air resources should give us the superior intelligence, mobility, and firepower to defeat him.

40. There are two possible objections to the employment of this tactic in the north. First, for morale, political, and military reasons it may be undesirable to wait for the climate and harassment to reduce the enemy's capability. Second, if the enemy seizes an inhabited area, friendly civilians will be held hostage, and it may be unacceptable to starve or harass our citizens

isolated with the enemy force. Military commanders must be aware of the alternatives in either situation, and be prepared to state these clearly when seeking direction. Commanders should insist on detailed orders with respect to civilian lives, property, and installations. In either case the initial military action should be to identify and isolate the intrusion area, arrange for the deployment of reaction forces, and await political direction.

### **Composition of Forces**

41. A force committed to this type of operation must be highly mobile, preferably mechanized while in certain circumstances skis and/or snowshoes will be sufficient. Helicopters will be invaluable. Rapid deployment may mean that initial operations will have to be carried out on light scales, such as using mortars in lieu of guns. Fighter ground attack aircraft will be of great assistance in increasing the fire power initially available.

42. Because of the emphasis on using the weather as a weapon to assist our operations, accurate data is essential. A meteorological detachment must be part of the force.

### **Location and Engagement**

43. Initial reconnaissance, probably by air, must determine the location, strength, and, where possible, the intentions of the enemy. While friendly ground forces are deploying to the area the enemy will be engaged by tactical air elements. Close support aircraft will select targets in the following order of priority:

- a. accommodation areas
- b. heating, electric, and water supplies;
- c. dumps of food, gasoline, and ammunition; and
- d. vehicle/aircraft parks, and maintenance facilities

44. In addition to the conventional attack methods, aircraft may be used to drop high-intensity flares or to make dummy bombing and strafing runs over the objective. The activities will have the effect of reducing enemy morale by increasing his alert time, destroying his night vision, and reducing his work potential.

### **Containment**

45. Assuming that any airstrip in the immediate vicinity of the incursion will be held in strength, friendly forces may have to seize a separate airhead as close as possible to the enemy but out of range of his effective fire. The force must deploy from the airhead to the objective area as rapidly as possible, and establish a cordon around the lodgement. Depending on the force available and the size of the enemy area, this may be a loose cordon relying heavily on observation posts and mobile patrols or, at the other extreme, it may be a tight perimeter completely sealing off the enemy force.

## **Harassment**

46. Once the cordon is in position, an extensive program of patrolling and probing will start to further define the enemy strength, locations, and intentions. This will be the first stage of land harassing tactics, and will be supplemented by harassing fire from indirect fire weapons. Harassing tactics should be increased during periods of bad weather and low visibility in order to cause maximum discomfort to the enemy. Our forces must attempt to operate upwind of the enemy in order to minimize the windchill effect on ourselves and maximize the enemy problems.

47. Harassment can be increased by using vehicles to circle or approach the enemy positions. Cold clear air or movement upwind will carry the noise into the enemy area and create apprehension. Continuous movement and stop-start tactics will make it very difficult for the enemy to pinpoint vehicle locations. Other noise producing devices can be used to put further pressure on the enemy. Horns, sirens, and the random firing of weapons can all be used to keep him on edge. When these activities are combined with EW activity to reduce the enemy communication capability, the effects will be magnified.

48. Every attempt must be made to have patrols and raiding parties infiltrate the enemy positions to create fear, and impose damage. Maximum use must be made of phosphorus and incendiary devices, booby-traps, and mines to render shelters uninhabitable. Sources of heat and power should be destroyed as well as water and food supplies. Communication means such as telephone line, bridges, and vehicles, should be destroyed.

49. An enemy unit which moves out of its lodgement in force should not be engaged head on. Harassing tactics will still be employed. These tactics are characterized by hit and run attacks to the flanks and rear, air strikes, demolition of routes, and attacks in depth at the enemy base. Columns should be forced to split up into small groups so they can be defeated in detail.

50. Enemy patrols must be cut off and prevented from returning to their base. Ambushes must be laid to destroy any relief forces sent out to assist patrols. Enemy outposts should be isolated and destroyed, and they should be occupied to prevent the enemy from re-establishing himself. Any enemy withdrawal must be followed up, thus gradually reducing the size of his perimeter. Adverse weather may force an enemy to temporarily abandon some locations; these must be seized using the weather as cover.

51. Sustained and aggressive harassment will quickly wear down the enemy to the point where he can be overrun with minimum losses to the attacking force. When these tactics have been used in conjunction with poor weather against an isolated enemy, there may be no need for a deliberate confrontation.

## **Destruction**

52. When the commander decides to end the harassment phase of these tactics, the enemy may be in a condition varying from near surrender to still willing and able to fight. If the enemy is at the lower end of the scale, our forces may be able to conduct a mopping up operation.

However, if the harassment phase has not achieved the desired results, a deliberate attack as described earlier will be necessary to destroy him.

### **Resupply**

53. To maintain pressure on the enemy during these tactics it is imperative that our logistic burden be minimized. Maximum use of air resupply, including parachuting stores, is desirable. Temporary air strips on lakes and eskers can be used by fixed-wing aircraft, but static airfields should be avoided because of the high cost of protecting them.

### **Rotation of Troops and Equipment**

54. A sustained operation of this type will take its toll on friendly forces as well, especially if a cordon has to be maintained for a long time. The high level of activity and long hours without rest dictate a maximum of three to four days in the line before efficiency drops off sharply. Arrangements will have to be made for relief in place and, in the case of mobile patrols, for continuity of effort. Staggering rotation, thorough briefing, and continuity at the command level should allow for a smooth handover.

## SECTION 6 - AIRMOBILE OPERATIONS

### General

55. Airmobile forces can overfly obstacles, cover long distances, and arrive in the objective area ready to fight. Reinforcement can be deployed rapidly in a minimum of time. Support can be accomplished rapidly and effectively under all but the most adverse weather conditions. Conventional doctrine is as applicable to northern operations as it is to the more temperate regions of the world. However, some modifications are required to overcome the limitations imposed by the environmental conditions. These are:

- a. Standard Operating Procedures - The frequent conduct of unit training exercises in the north, and the development of SOPs peculiar to that environment are essential.
- b. Loading Plan - Consideration should be given to increased weight of special equipment required for cold weather, mountain, and glacier operations. On most missions, fully loaded rucksacks will be carried. During winter periods, toboggans with shelters and supplies must accompany personnel on the same aircraft. Additional time is required for loading and unloading with winter clothing and equipment. Protection against sub-zero weather and other adverse weather conditions may be required when using external loads.
- c. Weather - Weather minimums must be established early in the planning to prescribe the least acceptable weather in which the commander will permit the operations to be mounted. Weather factors which must be considered in planning and conducting northern airmobile operations include temperature, density altitude, wind speed and direction, icing, visibility, turbulence, and snow and ice conditions. Current aviation weather forecasts are essential. Despite forecasts the best source of weather information is an on the scene report by a pilot in flight in the area of interest. If possible, a weather reconnaissance flight should be made of the weather is marginal or shows signs of deteriorating.
- d. Aeromedical Evacuation - Plans must be made for aeromedical evacuation of airmobile force casualties. The evacuation problem is of immediate urgency during periods of sub-zero temperatures, because in addition to battle casualties, those from cold injury are likely to increase. Dedicated aircraft must be considered when plans are made and be available throughout the operations.
- e. Night or Limited Visibility Operations - The tactical situation may dictate the conduct of airmobile operations during darkness or periods of limited visibility. This is particularly true in the northern latitudes because of the short periods of daylight during the winter months. Flares, helicopter-mounted searchlights, night vision devices, and other techniques may be used to illuminate the area of operations. Airmobile operations can be conducted during bright moonlight on snow-covered terrain with little or no artificial light. Areas with deep, powdered snow should be avoided or the interval in space or time between helicopters greatly increased if more than one aircraft is to land in the same

location. Spacing could be up to 100 m (330 ft) apart and time interval could be 20 - 30 seconds.

- f. Security of the Landing Zone - Because of the large perimeter of the LZ in an airmobile operation usually it is necessary to economize in the size of security forces. The security force is further reduced because of the requirement of off-load equipment and construct warming shelters during cold-weather operations. A single, security force forward of the objective area may be all that is practical in some circumstances. However, when combatting highly trained ski troops or vehicle-mounted troops it is essential that all-around defence is maintained because of the speed with which the attack can be launched. To enhance surprise for the airmobile assault, and to avoid the tiresome task of breaking trail through deep snow, thick bush or muskeg, security forces may land directly on enemy positions. This will only be possible in lightly defended areas or when heavy suppressive fire is available

### **Conduct of Operations**

56. When helicopters land, troops must not be on the landing site at the time of their touch down because of the dangers inherent in night operation and/or the effects of windchill and blowing snow. Skis and snow-shoes should be tied in bundles. Trails must be broken from the troops positions to the pickup points so that all equipment can be carried and handled easily.

57. During winter periods, lakes should be used as LZs. Ice thickness must be checked by pathfinders before landings are attempted. The use of lakes as LZs meets many desirable characteristics; the approaches to and from LZs will be relatively unobstructed, snow depths will normally be less; and troops can find concealment in trees, vegetation or snow drifts found on shore line. Because of the slowness of unloading troops and equipment from helicopters during winter operations, initial landing should therefore be in an undefended or lightly defended area as close as possible to the objective area. When the enemy does not have aerial surveillance capabilities, various dyes may be used on the snow to mark the LZs for easier identification on subsequent lifts.

58. Troops deplaning should move to mid-distance from other helicopters to avoid the maximum windchill effects and blowing snow caused by the downwash of the helicopter blades. Personnel must protect their faces by turning away from the main blast and pulling their parka hoods over their heads and around their face. Equipment must be pulled away from the skids of the helicopter. Small items of equipment must not be thrown into the snow where they may be lost or blown up into the rotors. After departure of the aircraft, individuals should check each other for frost-bite.

59. When unloading in the landing area, troops will frequently be completely disoriented. As a minimum, a crew member of individual air-craft should tell the ground commander which direction is north in, relation to which way the aircraft is facing. Commanders should orient themselves as completely as possible prior to touch down so that section, platoon, and company assembly can be accomplished with the least delay.

60. During extreme cold conditions, troop warming areas must be established in the immediate vicinity of pickup zones and LZs. Delays caused by below weather minimums are frequent in northern areas. Weather decisions should be made as close to the pickup times as possible. During lengthy flights the interior temperatures of the helicopter should be kept cool to avoid overheating troops dressed in cold-weather clothing.

## SECTION 7 - CHEMICAL AND NUCLEAR OPERATIONS

### Chemical Operations - General

61. The principles of employment of chemical agents and defence against them in northern latitude are the same as for temperate zones. The application of these principles to operations at low temperature (below  $-18^{\circ}\text{C}$ ) must be based on a thorough understanding of the peculiar characteristics of the area of operations, organization, and tactics of the opposing forces, and the technical limitations of chemical agents.

### Toxic Chemical Agents

62. Low temperatures adversely affect the casualty-producing characteristics of most toxic chemical agents. For a chemical agent to produce a casualty through the respiratory system, the agent must be capable of being vapourized or converted into aerosol. Generally the lower the temperature the more difficult it is to vapourize a given chemical agent.

63. The difficulties of taking the necessary protective measures rapidly may result in troops being exposed to chemical agents for a longer period than is expected in temperate climates.

64. The nerve, blood, and blister agents will produce casualties if taken into the body in contaminated food or water. Because of their high freezing point, blister agents are generally non-effective in low temperatures. However, chemical agents in or on frozen ground can become a greater hazard when the ground warms up - even months after the time of contamination.

### Protective Measures

65. Ice and fog must be kept clear of the inlet and outlet valves of the chemical-biological mask (chem-bio). It should be dried regularly. Frostbite may occur if the head harnesses are pulled too tight.

66. Freezing and thawing does not affect the therapeutic value of atropine; however, auto injectors must be protected from freezing. They should be carried under the clothes so that they are kept warm.

67. While multi-layer winter clothing offers a fairly good protection against absorption of frozen persistent chemical agents. There is danger to personnel continuing to wear contaminated clothing.

68. Reagents in the chemical agent detector kits must be protected from freezing. Although the validity of tests are not affected by extremes of temperature, some tests may require longer periods of time for appropriate colour changes under cold-temperature conditions. In extreme cold, the vapour concentrations of chemical contamination may be low enough to escape detection. The detection of these agents may be facilitated by carefully warming a small sample.



## **Smoke**

69. Generally, northern areas provide ideal meteorological conditions for the use of smoke. Base ejection artillery smoke shells containing cannisters are not effective in loose snow because of burying. However, where there is packed snow or ice, they are effective. Although artillery shells filled with white phosphorus (WP) also become buried in loose snow they are generally the most effective smoke shell for use in the winter. Smoke pots work well in low temperatures, but generated heat may cause them to burrow in the snow, therefore, the snow should be cleared beforehand, and the pots placed on a solid platform.

## **Nuclear Operations - General**

70. Because of the limited road network generally found in northern areas, nuclear radiation may severely disrupt all operations unless good cross-country mobility is available.

71. Unfrozen muskeg and tundra provides an average blast-reflecting surface. However, this same terrain when frozen or covered with ice or packed snow becomes a good blast-reflecting surface. A newly fallen, loose blanket of snow makes a very poor reflecting surface and will result in a decrease in blast effects.

72. Muskeg and tundra or wet terrain will reduce the effectiveness of thermal radiation. Terrain covered with snow is a good reflecting surface, and increases the effectiveness of thermal radiation. Under certain conditions ice fogs are easily generated at low temperatures, and this creates conditions unfavourable for the transmission of thermal radiation.

## **Protection**

73. Because of permafrost, positions often cannot be dug, and this leaves the soldier much more exposed than when he can dig in. Shelters and positions constructed from snow and ice offer some protection, and, whenever possible, should be built to gain maximum advantage from the ground. During winter the frozen trunks and branches of trees will break into many projectiles moving at high speed. Winter clothing provides considerable protection against thermal radiation outside the radius at which other effects will govern.

74. Protection from radioactive fallout provided by the tent is virtually non-existent. Maximum use must be made of natural terrain features to provide protection against radiation. Snow and ice, although not as effective as earth in reducing radiation hazards, are readily available and can be used to provide shielding. Loose, falling snow in a contaminated area will reduce the dose rate to 50 per cent when a depth of at least 60 cm (24 in) is reached. Thirty cm (12 in) of hard-packed snow will reduce the dose rate by 50 per cent of the original value. This hard-packed snow will be of value in constructing radiation shields over contaminated areas or around shelters.

75. Low temperatures will make decontamination of personnel more difficult. The requirement that contaminated personnel be provided with bathing facilities and a change of clothing must often be modified and field expedient methods used.

76. Tracking of contaminated snow in shelters and populated areas can be minimized if trails and roads are scraped after fallout ceases. If practical, the removal of the top layer of contaminated snow within the occupied area will materially reduce the radiation dose rate.

### **Monitoring and Survey**

77. Since monitoring for nuclear radiation requires the use of battery-powered radiac instruments it is imperative that these instruments be kept warm to maintain maximum efficiency. Survey is limited to those areas or routes occupied or used. Aerial survey is the most practical method of large area survey. Because of the periods of blowing snow, and the movement of ground particles over long distances, a continuous survey over both radiation hazards and chemical hazards must be considered.

# **CHAPTER 10**

## **OPERATIONS - SPECIAL**

### **SECTION 1 - INTRODUCTION**

#### **General**

1. Special operations, for the purposes of this manual, are those conducted by specially trained or equipped forces, either independently or in conjunction with conventional elements.
2. Only those aspects of special operations peculiar to the north are discussed in this chapter, overall details are covered in the applicable manuals. This information is mainly of a general nature required for commanders and staff and members of conventional units/formations which may be operating in conjunction with specialist troops. Detailed information on specialist northern operations is contained in the appropriate manual, eg. northern airborne operations are discussed in CFP 210(1), The Airborne Regiment in Battle.

## **SECTION 2 - AIRBORNE OPERATIONS**

### **Scope**

3. Airborne operations, by definition, encompass both airborne assault and air-landed operations. Airborne assault means a landing with opposition expected, an air-landed operation would not expect fighting on arrival. Airborne assault may be parachute assault or air assault landing. Parachute assault can only be carried out by specialist troops, air assault landings can be executed by any trained force.

4. Airmobile operations are discussed in Chapter 9. The discussion of the helicopter in this chapter is limited to its use in the air assault landing role. The same general principles apply to helicopters and fixed-wing aircraft when discussing air assault landing. Operations in the far north may, dictate the use of parachutists due to the long distances from the supporting base, or forward base when established, and/or the non-availability of landing fields.

5. Air-landed operations are not considered special operations and are not discussed in this section.

### **Limitations**

6. In addition to the normal limitations on airborne assault the following have particular application in the north:

- a. The increased effect of weather (blizzards, fog, white-out).
- b. Navigational difficulties caused by inadequate charts and maps, and lack of natural landmarks and man-made structures.
- c. Heavy or deep snow drifts on airfields and landing/drop zones with associated equipment recovery or snow removal problems.
- d. Difficulties in constructing landing strips in summer.
- e. Uncertainty of radio communications.

### **Selection of Drop Zones and Landing Zones**

7. The following factors must be considered:

- a. the requirement for visual or photographic coverage;
- b. the preferred use, when possible, of frozen inland-water surfaces of sufficient strength;

- c. a musket area that looks suitable on photographic or map inspection will frequently prove to be covered with frozen hummocks of vegetation one half to one metre (2 to 4 ft) in height;
- d. the depth and type of snow, and configuration of drift; and
- e. in summer, swamp and musket conditions can restrict the use of many otherwise desirable zones.

### **Forms of Assault**

8. When considering the form of assault (parachute or air assault landing), the following should be borne in mind:

- a. the area of the lodgement in relation to the distance from the nearest landing facilities;
- b. the strength of the force capable of being concentrated in the assault area in one lift or at any one time;
- c. the time gap between the initial assault and the arrival of the follow-up assault echelon;
- d. the strength, position, and armament of the enemy; and
- e. availability of tactical close air support.

9. Parachute Assault - A parachute assault will normally be launched if the enemy occupies or is so situated that he denies the use of LZs in the area to which forces could be air-landed, or when vertical assault by helicopters is not possible. Once a landing area has been secured, follow-up troops can be flown in to conduct a conventional land operation to complete the destruction of the enemy. A parachute assault may also be used with a ground assault to cut off, divert or hold vital points behind or on the enemy flanks.

10. Helicopter Air-Landing - The short range of present day helicopters requires that there be air-landing facilities for fixed-wing transport aircraft within helicopter range of the enemy lodgement. This air-landing facility would provide the means to stockpile fuel, and if necessary, to fly in dismantled helicopters. Provided this requirement is met, helicopter-borne assaults can be used when weather, aircraft resources, and anti-aircraft suppression fire support combine to make it feasible.

11. Fixed-Wing Air-Landing - There may be situations where troops can be air assault landed sufficiently close to the lodgement that movement by foot or vehicle to it is possible. Such a situation may occur because the enemy has failed to capture an airfield adjacent to the lodgement, and friendly forces with communications to the outside world are present there.

## **Special Considerations for Parachute Assault**

12. The capability to deliver personnel by parachute is of particular importance in underdeveloped areas when surface routes of communications are limited or non-existent. Experience indicates certain operational and planning factors require special emphasis when airborne units are committed to parachuting in northern areas:

- a. parachute forces employed in northern areas must be capable of self-sustaining operations for seven days without benefit of resupply;
- b. alternative plans must be made for link up and resupply;
- c. to avoid over-heating personnel, aircraft temperatures should not exceed  $-4^{\circ}\text{C}$ ;
- d. DZ assembly procedures, and the use of assembly aids are especially critical in northern operations where considerable difficulties are encountered in assembly in tree-covered areas, deep snow or during extended periods of darkness;
- e. during the snow season, toboggans with tent group equipment must accompany units on the initial drop, and all parachutists should drop with snow-shoes; and
- f. special effort must be made to expedite recovery of equipment that is delivered by parachute.

## **Conduct of the Assault**

13. Marking of DZ and LZ - The difficulties of navigation, short winter days, and the chances of sudden bad weather make the use of pathfinder parties desirable if they will not prejudice the subsequent operation. When a parachute drop is made in close proximity to the enemy lodgement, pathfinders may be inserted using high-altitude low-opening techniques, by dropping them close to P Hr, or by dropping them some distance from the objective and having them infiltrate to the DZ. Variations of this technique can be used to deploy pathfinders by helicopter or fixed-wing aircraft.

14. Assembly on Landing - Featureless terrain and poor visibility may make it difficult for troops to orient themselves and assemble. Assembly areas will have to be marked for both day and night operations.

15. Ground Tactical Plan - Since minimum fire support may be available, movement over featureless terrain may have to be by night or under conditions of low visibility to avoid enemy fire. If the enemy has no indirect fire weapons, his ability to engage targets accurately beyond 1,500 m (5,000 ft) will be restricted. This will allow for close and detailed reconnaissance and will minimize interference. The assaulting force should attempt to destroy all the enemy, but the capture of the objective will probably be the priority task. The environment will do the rest, particularly in winter.

16. Vulnerability - Although the enemy may be lightly armed, the featureless terrain will provide him with an excellent opportunity to shoot down aircraft, especially helicopters, that come within range. Unless surprise is obtained, aircraft will normally have to unload outside the range of small-arms fire. Suppressive fire by artillery, mortars, and tactical air can reduce the degree of vulnerability.

17. Time and Space - If movement on foot is required in winter, the combination of good enemy fields of fire and the greater length of time required for movement should be considered when deciding on a day or night assault.

18. Reorganization - The normal reorganization drill will apply. As soon as possible, shelter and heat must be organized for casualties, the assaulting troops and prisoners. Arrangements must then be made for rapid evacuation of the casualties and prisoners.

### **Summer Considerations**

19. During the summer, in most respects, conditions are similar to those in temperate zones, however, there are some significant exceptions:

- a. Hours of darkness are extremely limited. The number of hours of daylight must be considered for long-range planning.
- b. Water temperatures are low. In some areas, parachutists landing in water could become cold casualties.
- c. Much of the northern area is mountainous, and operations here may require climbing equipment and climbing techniques. Requirements may also exist for winter equipment if fighting in higher terrain.
- d. Muskeg conditions cover much of the lower areas. Foot and vehicle mobility is difficult to impossible in these soft, swampy ground conditions.

## SECTION 3 - AMPHIBIOUS OPERATIONS

### General

20. The extremes of winter weather may impose on an amphibious attacking force conditions which severely limit or make impractical an amphibious assault against a defended beach in northern latitudes. These operations will generally only be practical in summer and fall. The range of high and low tides and beach gradients present in the north must be carefully considered in planning operations. Once the attack is initiated, speed in landing troops, and providing logistical support is of great importance. Logistical plans must include an alternative means of supply by air should the conditions change during a critical part of the operation. Plans should include the use of helicopters in amphibious assault. Once ashore, the conduct of the operations will be the same as for any other attack in northern latitudes.

### Limitations

21. Oceanographic Conditions -

- a. Salt-water ice is one of the factors affecting amphibious techniques in their adaption to northern conditions. In any amphibious operation within salt-water ice areas, the task force commander should be given great latitude in determining where and when he should attack. Positive air protection must be provided as the force will have limited evasive action. The force will probably be accompanied by ice breakers, and progress will be slow. Amphibious operations where ships are required to enter an ice pack may have to be abandoned as impractical because shifting ice may close leads, immobilize ships, restrict landing areas, and in some cases form pressure ridges which are impossible or extremely difficult to negotiate.
- b. Within ice-free areas no departure from standard amphibious techniques is required except that operations may be affected by climate and operating conditions ashore.
- c. Airmobile assault from ships may be necessary because of ice conditions. In such case operations will be limited tactically and logistically.
- d. Data is available to planners which will indicate when and where ice conditions will allow sea movement.

22. Personnel and Equipment - During the beach assault, suits must be provided to troops and crews of landing craft to protect them from sea spray, and, if a dry ramp landing cannot be made, from freezing sea water. Operation of all mechanized equipment, boats, and aircraft in subfreezing temperatures is difficult. Shore party operations may be restricted and efficiency reduced by low temperatures, shelters will be required for the exchange of wet clothing for warm-up purposes.



23. Supporting Elements -

- a. Operations of supporting elements such as naval gunfire support ships and air support (both land and sea based) will be hampered during periods of low visibility and during the long winter darkness. Considerable reliance may be placed upon electronic means for directing fire support.
- b. Because of the difficulties imposed on air operations in northern areas, the highest degree of coordination is necessary between air units and the forces they are supporting.
- c. Naval gunfire will operate with little decrease in efficiency as the heated turrets are not adversely effected by temperature

## **SECTION 4 - RIVERINE OPERATIONS**

### **General**

24. A riverine area is a land environment characterized by water lines of communication. This environment has an extensive network of rivers, streams, canals, swamps or muskeg extending over a broad level terrain, parts of which may be inundated periodically or permanently. Ocean tides may affect riverine areas periodically near the seashore or far inland.

25. The northern regions are characterized by a vast network of rivers, lakes, and canals with sufficient depth to accommodate shallow waterway traffic. In the absence of road and rail networks, these natural arteries will be a highly valuable complement to overland transportation both in summer and in winter. In summer, some inland waterways are navigable for thousands of miles. In winter these waterways become ice routes. On these major waterways, operations can normally be conducted within the context of true riverine operations including naval support. As the operation proceeds inland, the waterways become increasingly shallow, and the use of naval support craft will give way to shallow-draft assault and river boats.

26. Northern waterways can be used during the entire summer season after spring break-up until fall freeze-up.

### **Characteristics of Northern Inland Waterways**

27. Northern inland waterways are characterized by the following:

- a. Many channels (braided). The main river channel may be changed significantly from year to year.
- b. Water is normally filled with silt, sand, and debris.
- c. Current is normally swift 15 to 19 kmph (8 to 10 knots).
- d. Rivers and streams are shallow (61 to 305 cm (2 to 10 feet)). In glacier fed streams the depth of water may double between early morning and noon. This is because of increased melting of the glacier caused by warmer daytime temperature.
- e. the rivers and streams may have many sandbars.

### **Limitations**

28. Operations will be influenced by the following factors peculiar to northern operations:

- a. The long hours of daylight during the summer months in northern areas allow operations to be easily conducted 24 hours a day. This also means the operations can be easily detected from the air.

- b. With few exceptions, major population centres are non-existent along the navigable or tributary rivers in northern areas.
- c. Weather is unpredictable and can change rapidly.
- d. Maintenance requirements are greater, especially on boat motors.
- e. Flooding may submerge or sweep away landing sites. During flooding periods the current may increase, making the river unnavigable.
- f. Low water may reduce channel depth below minimum requirements, and reduce or eliminate temporarily the usefulness of the waterways as a means of transportation.
- g. Land and river navigation is important because of the difficulties caused by -
  - (1) declination and fluctuation of magnetic field,
  - (2) lack of identifiable landmarks, and
  - (3) lack of detail on most maps.

## **SECTION 5 - RAIDS AND REAR AREA OPERATIONS**

### **General**

29. In northern operations there usually are no continuous fronts. Units may operate independently many miles apart. Installations are isolated, and communications, where they exist, are long and vulnerable to attack. Surprise is always a possibility, and security can only be guaranteed by accurate knowledge of enemy dispositions, composition, movement capabilities, and constant vigilance. The enemy is equally vulnerable. Conditions, both operational and environmental, facilitate raids on communications centres, headquarters, and installations of all types. Patrols, and stay-behind forces are well suited for these operations. Severe weather conditions enhance the effect of such operations.

### **Tasks**

30. The primary task of long-range patrols will be reconnaissance and raids on isolated positions and in enemy rear areas.

31. These patrols may form part of the harassment campaign discussed in the previous chapter or:

- a. as diversions during an attack;
- b. to prevent the movement of enemy reserves;
- c. to force further the dispersion of enemy forces;
- d. to impose a presence in contested territory; and
- e. as part of stay-behind forces in the event of a withdrawal.

32. The insertion, supply, and evacuation of patrols, casualties, prisoners or documents will be carried out by air whenever possible. Patrols must be capable of rapid movement, and must be able to operate for long periods without resupply.

### **Selection of Personnel**

33. The effectiveness of long-range patrols fundamentally depends on their ability to live under rigorous conditions, and the speed with which they can move across country. All ranks must have a high degree of endurance and expertise in travel whether it be by ski or snow-shoe. They must be able to survive and live off the land.

34. Every effort should be made to include in the patrol at least one member of any indigenous paramilitary organization, such as the Canadian Rangers, who has a good knowledge of the operational area.

## **SECTION 6 - OPERATIONS ON PERMANENT ICE AND SNOW-COVERED AREAS**

### **General**

35. Operations on permanent ice and snow-covered areas may be required for the establishment of support facilities, and protection of specialized activities. In such instances operations will normally involve small units but the total effect required will be large because of the extreme difficulties of operating in such areas.

36. Operations on an ice cap are so different from other northern areas that different techniques of operations are required. Troops require specialized training for operations in this area of crevasses and high winds. The absence of usable resources except ice and snow necessitate that every item required must be transported into the operating area. The construction of storage and maintenance shelters from snow and ice is feasible.

### **Equipment**

37. Specialized equipment for negotiating the area is required. This equipment will include oversnow vehicles, tractors, crevasse detectors, trail marking equipment, navigational aids, living wanigans, crampons, ice axes, ropes, and related items.

## **CHAPTER 11**

# **ADMINISTRATION**

### **SECTION 1 - INTRODUCTION**

#### **General**

1. The principles of administration do not change in northern operations, however, the techniques employed must be adapted to the environment. Flexibility in planning and use of resources will be the key to success. Each operation will be unique, and the administrative system must be able to conform. Weaknesses or failures will have a more disastrous effect on operational plans than is the case in temperate zones.

2. Northern operations may have to be mounted in short notice, therefore administrative planning must be continually updated. Stocks must be readily available for deployment, and all equipment maintained to a high standard. Training administrative personnel for northern operations must be ensured.

## SECTION 2 - THE LOGISTIC CONCEPT

### Mounting

3. The outline plan for mounting northern operations is discussed in Chapter 1. The system of mounting, supporting, and forward bases used to deploy a force will also be the technique used for follow-up administrative support. All logistic requirements will be tunnelled through the supporting base the forward base and/or to the airhead (when one is required).

### Forward Base

4. Ideally, the forward base will be superimposed on an existing CF installation, in the worst case it will be a civilian complex. The key requirements are heated shelter and storage plus a runway capable of accepting medium-transport aircraft under all conditions.

5. A task force of brigade size would normally have the following located in the forward base:

- a. Headquarters of the administrative unit, normally the service battalion.
- b. Second-line functions of the service battalion, ie, transportation, supply, and maintenance.
- c. Medical holding facility.
- d. Helicopter maintenance element (and possibly elements of the tactical helicopter squadron).
- e. Reserve stocks of combat supplies and spare equipment.
- f. Reinforcement holding unit and battle school.

### Airhead

6. When the distance from the forward base to the enemy renders effective administrative support impossible an airhead will be established. As the combat elements deploy from the airhead, their echelons will build up there. For protracted operations these unit echelons will be centralized under the higher headquarters control. Some elements or functions of the forward base may move into the airhead, but strict control must be exercised so that the administrative facility does not become a burden on the fighting units. Commanders should consider low-altitude parachute extraction (LAPES) and hovercraft when formulating resupply plans.

### Holdings

7. Holdings at all levels must be constantly monitored to ensure sufficient stocks, while at the same time ensuring that forward elements are not over burdened. Supplies will be palletized as far forward as unit echelons. Unit loads of all commodities will be prepared at the forward

base, when possible, in order to economize on bulk and handling in the airhead.

8. Limited lift capability in the forward areas dictates that the minimum holdings consistent with the operational requirement and safety be sent forward. Distance and reliability of resupply must be considered in each case.

### **Distribution**

9. Limited carrying capacity, high fuel requirements, and difficulties of terrain do not lend themselves to the standard distribution system, ie, use of delivery points. The administrative plan must cater to forward delivery of all items.

10. The following distribution systems, all of which lend themselves to use of air (primarily helicopters), must be considered:

- a. Direct Delivery - Supplies are dumped direct in unit or sub-unit echelons.
- b. Staged Delivery - Supplies are delivered to echelon areas where they are crossloaded to unit vehicles for forward movement.
- c. Air "Milk Run" - Logistic aircraft loaded with common requirements fly a circuit delivering requirements direct to sub units. This may later evolve to an "ON Call" system.

11. By virtue of the many uncontrollable factors affecting use of air, ground transport must always be available. This must in no way restrict the use of air which offers those vital requirements of northern transportation; speed, range, and flexibility.

### **Maintenance**

12. Unit maintenance technicians should be formed in teams, and a team should accompany each convoy of vehicles to perform first-line repairs. The forward repair group sited in the forward base will perform recovery tasks, and can, when conditions permit, carry out certain second-line repairs.

13. The forward base will often be the furthest forward area where repair can be efficiently accomplished. Heated and covered accommodation will be mandatory in winter.

14. Unless second-line resources are in physical proximity to A, echelons, or helicopter recovery is guaranteed, limited repair will occur.



## SECTION 3 - LOGISTIC PLANNING

### General

15. The following factors will affect logistic planning:
  - a. Long distances, harsh terrain, and severe climate have a pronounced impact on performance of men and machines.
  - b. The absence, especially in more remote regions of good ground communication systems.
  - c. Problems of camouflage and concealment in open areas leading to problems of concentration vs dispersion.

### Preparation Prior to Deployment

16. All available data on the area of operations must be studied for logistic implications. Government and military data banks must be consulted, and lists prepared of those items that will be required but are not normally part of the military supply system. However, the better method is to tailor equipment scales to the need.
17. All equipment and stores must be checked for serviceability and completeness. Repairs and action to overcome shortages must be expedited. Equipment neither suitable nor required must be exchanged or deleted from equipment tables.
18. Movement staff tables are to be reviewed and adjusted as necessary.
19. Depending on the time of year, arcticization procedures may have to be carried out on winterized equipment.

### Local Resources

20. In the temperate zones, operational considerations will outweigh many civil factors - in the north this may not be acceptable due to problems of moving refugees out or supplies in. Interdepartmental discussions will probably be necessary in order to determine government priorities.
21. The following are some aspects of the problem:
  - a. The impact of local purchase, and hiring of local labour must be considered in light of its effect on the local economy; and
  - b. local stores requisitioned may have to be replaced using military resources.
22. The other side of the coin of course is that considerable expertise, specialized facilities, and equipment are available at many developed sites. The early establishment of liaison with

local government and civilian agencies will determine what assistance can be given to the military.

### **Siting of Administrative Areas**

23. Because the supporting and forward bases will be based on existing facilities, planners will not have too much flexibility in their general layout. The points discussed are more pertinent to an airhead, but may be considered when comparing two suitable locations or when supplementary facilities have to be added to existing plant. Maximum use must be made of local facilities in order to reduce preparation time, and limit tonnage which has to be moved into the area.

24. The following factors should be considered:

- a. Suitability for aircraft.
- b. Availability of hard standing (for vehicles, aircraft, and stocks) Good soil conditions (rock, sand or gravel) are necessary to minimize the unfavourable effects of permafrost.
- c. Suitability for concealment - It will not be possible to conceal the site but the detailed-layout must be disguised. Timbered or built-up areas will assist.
- d. Proximity to local resources (such as fuel, heated accommodation, etc) - These may be natural resources such as forest.
- e. Communications - Local resources may provide access to long-range radio, etc, belonging to other departments. The normal requirement for tactical siting of radio still applies.
- f. Size of area - An enemy air threat will dictate a requirement for dispersal, no air threat will dictate a requirement for dispersal, no air threat or ground threat will call for a tight close-in deployment.
- g. Protection from elements - Facilities located on downwind side of hills, but only part way down the slope are best (cold air flows to the bottom of valleys.) Areas subject to avalanche should be avoided.

### **Rear Area Security**

25. Specific provision must be made for local defence of each logistic complex including vehicle convoys, airfields, LZs, echelon areas, and static stocks. All personnel in rear areas must be integrated into the local defence plans. Defence plans, where possible, should include provision for blocking air strips and other cleared areas against helicopter and airborne landings. The use of troops from the forward units may be necessary because of the increased demands on logistic personnel in the rear areas.

## SECTION 4 - TRANSPORTATION

### General

26. Sometimes the problem of logistic support in the north is oversimplified by saying it is entirely a matter of transportation. This is not true, but if any single factor out-weighs all others in the mounting of northern operations it must be transportation. A good transportation system will provide the lift when and where required, and have an alternative means at hand. Limited resources mean maximum use must be made of what is available. The same systems are used as in temperate zones, but the emphasis changes from land to air. Air is least susceptible to climate and terrain, but is also the most expensive. The correct balance of all available means must be the aim of all transportation planning.

27. Conventional second-line transportation units may have to be reequipped with appropriate vehicles. The transport unit might be located in the forward base or at the airhead if the operation is sufficiently forward of the airhead. The tactical air maintenance section (TAMS) teams will be the most heavily committed single element in the transport unit. Surface transportation will always be an alternative, but will be primarily employed as local transport at the airfields.

28. Throughout this manual, reference is made to medium- and high-mobility carriers with heavy, medium, and light capacity. This classification, along with some examples by type, is shown in Table 11-1.

Mobility	Capacity			Remarks
	Heavy	Medium	Light	
High	AN110, M548	DYNA-TRAK, CF10 M113A1		Primarily off-road vehicle
Medium	5 ton	2-1/2 ton	1/4 and 1-1/4 ton	4 to 6 wheel drive
Low	Commercial Pattern Vehicles			2 wheel drive

Table 11-1 Classification of Vehicles

### Air

29. The characteristics of aircraft and the limitations placed on their operation in the north are discussed in Chapter 7. Despite the limitations, the advantages gained by air movement of personnel and equipment so surpass other methods that air will be the primary technique employed. Air will always be supplemented by other means, and alternative systems must always be available in the event that air movement is not possible.

30. The distribution methods discussed earlier all lend themselves to use of air, however, lead time for planning is extended, and a flexible priority system must be established. Logistic planners must have access to information on aircraft availability, load capacity, and weather in order to make best use of resources.

31. Lack of alternative systems, especially on the arctic island in winter, means that complete aerial deployment and resupply may be necessary. Because the size of forces envisaged is not that large this should not be an impossible task.

## **Road**

32. The subarctic is dominated by forest, swamp, rivers, streams, and lakes. Normally, few roads are available, and often operations will be based on only one road which may not be an all-weather route. In winter, considerable resources will be required to keep roads open, and wheeled vehicles will be limited to those routes. In spring, summer, and fall, the road beds are generally soft which will restrict use of heavy vehicles, and increase the effort of engineers. Facilities at roadheads will be limited.

33. In the arctic tundra, roads are restricted to eskers and high ground. In winter, the ice on rivers, lakes, and the sea becomes a potential roadway. Snow roads may be used without preparation by high-mobility vehicles. Extensive road construction in the arctic is presently beyond the capabilities of engineer field squadrons except in areas around airfields.

34. Second-line transport will be a mix of high- and medium-mobility vehicles. Medium-mobility vehicles will be restricted to roads, therefore a close look must be taken at the organization of transport platoons. Current studies with commercial high-mobility vehicles are encouraging, and should greatly improve the present status. Wheeled high-mobility vehicles will be the most flexible as they will be economical on roads, and still retain a good cross-country capability. Vehicle crews should be provided with snowshoes, shelters, and heating equipment.

## **Off Road**

35. Various types of high-mobility carriers are available for northern operations requiring a cross-country capability. Vehicles will be oversnow or through snow depending on the design. The former category includes such logistic carriers as the Robin Nodwell 110, Dynatrac, and the CF 10, while the latter includes APCs and tanks.

36. Combat vehicles can be employed as prime movers for sleds and trailers when the operational situation allows. Commercial type caterpillar tractors have also been successfully employed as prime movers. The latter can move extensive tonnage over long distances but are very slow.

## **Traffic Control**

37. Road networks are limited, frequently provide only one-way traffic and are normally hazardous during winter months due to ice and snow. Visibility is seriously affected by snow,

frequent ice fog, and long hours of darkness which extend the time of operation of vehicles and under blackout conditions. Good traffic control arrangements are necessary to compensate for these problems.

38. Route markings are standardized by international agreements (civil and military), and are covered in UP 303(9), Road Movement. Local regulations adopted for the north must be advised to all concerned. All hazards such as curves and road junctions should be marked with reflectorized delineator stakes positioned along the outside limits of the road shoulders. Delineator stakes are also useful to indicate bridges and edges of contour bound mountainous roads. In the barren lands the trail should be marked on both shoulders. Normally the marking guides consist of two shapes plus two different colours, eg., green and yellow. This practice shows the road, indicates the direction of travel, and aids driving when using infra-red equipment.

39. Rapid reconnaissance over routes can be achieved by the use of helicopters. The frequency of route reconnaissance depends on traffic density, weather, and types of vehicles on the road.

40. Traffic control posts and check-points requiring continuous operation in winter months will necessitate the doubling of personnel. A "buddy system" must be established and shelters provided. Communications and special reflectorized accoutrements also must be provided for traffic control personnel.

41. Primary land routes and regularly travelled air routes should have survival shelters located at intervals which provide emergency sources of food, heat, and shelter from storms. In addition, vehicle operators and pilots must carry the essentials of survival in their vehicles and aircraft in case of mechanical breakdown away from the shelter. Traffic control personnel must ensure that improperly equipped vehicles do not depart the base area.

## **Rail**

42. Railroads are not available in the arctic, but they do provide normal regular service in adjacent areas of the subarctic. When using rail facilities, tactical loading must be used to allow uninterrupted unloading in the railhead area where limited facilities are available. Particular attention must be paid to the unloading of cold-soaked vehicles. Train weights may be limited due to light-weight rails, and low-capacity trestles and bridges. Use of rail transportation in northern regions is also hampered by heavy snowfall, snow slides, and extreme temperature changes.

## **Water**

43. When inland waterways are used they can only form part of a total support system, and the requirement for ground transport and specialized handling equipment still remains. Natural waterways may be used during the summer season for logistic purposes. The following military and civilian resources should be considered:

- a. Power boats with shallow draft can be employed for both troop transport and supply movement in up stream areas.
  - b. Near the mouths of large rivers, conventional ship-to-shore lighters may be used effectively for support of forces.
  - c. Long-distance bulk river-transport equipment of conventional commercial design may be employed.
  - d. Use of natural waterways for logistic support requires extensive effort for the location of channels and installation of navigational aids.
44. During the winter, ice roads can be prepared on rivers, lakes, and along the sea shore. Details are in Chapter 5.
45. A northern supply expedition by water, during ice-free periods, is less difficult than by other means of transport. Ships are self sufficient, requiring no servicing or refuelling facilities at their destination. Supplies can be delivered on a large scale with a minimum of hazard to personnel or equipment.
46. In the ocean areas of the north, movement possibilities vary widely from year to year depending upon the severity of the preceding winter season. Most areas of the Arctic Ocean bordering on land have about eight weeks each year when ice permits passage of ships. These periods usually occur during July, August, and September.
47. Navigation is restricted by the movement of the ice pack, which is governed by the winds, tides, and current. The prevailing shallow water, and numerous migrating sandbars further complicate the problem. Topographical data is sometimes missing.
48. Cargo discharge is hampered by the lack of sheltered harbours, the absence of wharves, and the distance the ship must anchor from shore. Poor visibility restricts observation, and hampers cargo discharge when vessels must harbour well out from shore. Marker buoys are placed along the entire route from ship to shore.
49. Resupply by submarine may be considered when an insufficient ice-free season exists.
50. Finally, remember that the use of conventional wheeled transport will be severely restricted in both arctic and subarctic regions except in the immediate area of the airhead or existing roads. Forward resupply may have to be carried out entirely with high-mobility carriers or by air.

## SECTION 5 - SUPPLY

### General

51. Transportation difficulties in the north have an effect on the supply function. All levels must carry sufficient stocks to see them through periods when provisions cannot reach them. The second-line supply element will normally be located at the forward base although it might have elements in the airhead. Maintenance and replacement problems mean that no substandard equipment can be tolerated with a force operating in the north.

### Stock Levels

52. Standard loads and consumption rates designed for conventional war in a temperate zone will have to be reconsidered in the light of northern requirements. Each operation will be unique with respect to duration and intensity. Seasonal considerations will have a considerable effect on scaling.

53. Combat Supplies - Of the four items in this category (ammunition, POL, rations, and water) only rations can be predicted with consistency. POL consumption will be greater than normal due to requirements for heating, melting snow/ice for water, extended distances, etc. Ammunition consumption will generally be low due to the nature of isolated small unit actions. Additional considerations with respect to combat supplies are:

- a. Holdings - The following figures are based on rations but also apply to POL and ammunition at the appropriate consumption rate -
  - (1) With the man - 1 day (plus emergency ration).
  - (2) With the tent group or equivalent - 2 days.
  - (3) With the A1 (subunit) echelon - 2 days.
  - (4) With the A2 (unit) echelon - 5 days.
  - (5) Held at the forward base - 10 days.
- b. Water - Production of water by melting at the tent group level is expensive in time and fuel. The high amount of condensation on tentage also carries a penalty in the greatly increased rate of replacement - wet tents lose their insulating characteristics, freeze, and tear. Whenever possible water should be delivered in bulk. Engineers are responsible for provision, but delivery will be a supply and transport function. Bulk water is a must in rear areas, and where ever possible, in forward units. Increased water intake will lower the cases of dehydration in the force, but not provide a saving of POL. A bulk supply of water will reduce the incidence of tent eye.

- c. POL - The extensive use of tracked vehicles with high-fuel consumption must be considered when planning POL requirements. This, coupled with the requirements for heating of buildings and tents will produce an abnormally heavy POL requirement. Arctic-grade diesel, anti-freeze, denatured alcohol, and special cold-weather type oils and greases which remain fluid in extreme cold are some of the peculiar POL requirements for northern operations.
54. Repair Parts - Because of higher equipment failure rates, repair parts stocks must be increased above normal levels. Because unit loads must be kept to a minimum the bulk of these parts will be held to the rear. Back loading of equipment will be more frequent as explained in Section 6. Major assemblies will be flown direct from the supporting base on demand in order to reduce holdings in the operational area.
55. Clothing and Equipment - Environmental clothing, especially during winter, must be immediately available to replace damaged items. Torn, damaged, wet, or POL impregnated clothing and tentage is dangerous and replacements must be held down to company level. Facilities must be made available for drying of tentage whenever possible. Special care must be taken to ensure that sufficient snow knives, shovels, cookers, snow-shoes, skis, etc, are available.
56. The system for supply of vehicles, engineer and defence Stores, and medical supplies will not differ greatly from the norm.

## **Storage**

57. It will not be practicable to hold stores on vehicles. During winter months, supplies must be stacked on pallets to prevent them from freezing to the ground. Supplies stacked in the open should be located to keep the effects of drifting snow to a minimum. Poles and flags should be used to mark the location of the stores to provide a guide for snow ploughs or bulldozers when clearing the snow. Waste and salvage dumps must also be well marked and recorded.
58. Care must be taken with supply items which are subject to freezing. Medical supplies, batteries, special fuzes, and many rations must be kept in dry, heated storage, and away from any contact with moisture.
59. Gasoline and diesel fuel may be stored in flexible containers at low temperatures although the containers cannot be easily moved, and are subject to damage from handling at temperatures below  $-34^{\circ}\text{C}$ . At extremely low temperatures, flexible containers and hoses become brittle and break easily. (If the container or hose breaks allowing spillage on the individual, instant frostbite will result.) Fuel containers and/or drums should be stored vertically tipped at a 20 degree angle. This allows the water to concentrate and freeze in the bottom corner of the barrel. When pumping out with a hand pump the fuel should be drawn to the upper level of the base of the drum. Four to five gallons should be left in the barrel to reduce the possibility of water being transferred to the vehicle tank.
60. During the summer season, well drained ground is selected for storage sites. Supplies should be stacked in pallets to prevent freezing.



## **Distribution**

61. Possible duration methods were mentioned in paras 9 to 11. Whenever possible, unit requirements will be packaged on pallets or containers and moved as far forward as possible. When roads are being used it will be necessary to establish a rendezvous (RV) where stores will be crossloaded to unit high-mobility vehicles for cross-country movement. The principle must be to reduce the number of transfer points to the minimum.

## **Laundry and Bath**

62. The laundry and bath unit is an element of the supply company in a conventional service battalion organization. It will be deployed with any force operating for a sustained period without access to a local facility. Ideally, it is located as close to the forward troops as is tactically possible, however, its requirement for water, fuel for heating, protection, etc, may limit it to the Airhead.

63. The unit must be located immediately adjacent to a lake or river to reduce the problem of water freezing between source and heater unit. It must also have a facility for disposal of waste water.

## SECTION 6 - MAINTENANCE

### General

64. Northern operations are characterized by the requirement for a considerable amount of special care needed to prepare equipment before an operation, and the special treatment required during and after use. The environment causes abnormal wear and tear on all items of equipment. These two factors combine to greatly increase maintenance requirements and problems.
65. Additional factors complicating the maintenance problem in the north are:
- a. the requirement for heated repair facilities;
  - b. difficulties of back loading vehicles over rough terrain;
  - c. problems in moving mobile repair teams (MRTs) forward to broken down equipment;
  - d. high consumption. of repair parts; and
  - e. the inordinate amount of time required for simple repairs.

### Maintenance Personnel

66. Maintenance personnel will be hampered by low temperatures and blowing snow in winter, and dust, abrasive sand, and black flies in summer. A high standard of personal and unit discipline is required to overcome the natural inclination to seek comfort. Bulky protective clothing also hampers efficiency, and extreme care must be taken to ensure bare flesh does not touch cold metal.
67. Fuel coming into contact with the hands results in supercooling due to evaporation, and causes painful freezing within seconds. The repair time factor may be increased by five when personnel are doing field maintenance in extreme cold, eg, at  $-40^{\circ}\text{C}$ . The installation, maintenance, and repair of engine preheaters and personnel heaters, as well as changeover to arctic lubricants requires many manhours.

### Preventive Maintenance

68. The satisfactory performance of any type of mechanical and electronic device is enhanced by a high standard of maintenance, therefore, a good preventive maintenance and high-quality repair program is essential. A prerequisite to improve the performance of modern forces is to ensure that all systems are in good repair, and that lubrication and adjustments have been made in accordance with appropriate technical manuals.
69. Machined surfaces that produce heat will rust rapidly in cold weather because of the condensation caused by cooling, therefore, they must be kept clean at all times. Objects that do not produce heat have little problem with rusting.

## **Winterization/Arcticization**

70. Winter operations in the north dictate that all vehicles and equipment be winterized. During the cold season this must be done prior to deployment from the south. Fuel tanks should be filled with arctic-grade fuel before deployment as well. Failure to carry out these tasks will result in unacceptable performance at  $-40^{\circ}\text{C}$ . Replacement equipment arriving after the commencement of the operation must be carefully checked to see that winterization was carried out.

71. Winterization procedures are detailed in current technical manuals, however, most of the data is concerned with operating conditions above  $-37^{\circ}\text{C}$ . When temperatures are likely to be below this level, arcticization will be required. Maintenance staffs must issue special instructions to cater for this contingency.

## **Recovery**

72. Recovery of damaged or abandoned items of equipment must be accomplished as soon as possible, in order to prevent them being covered by snow or becoming inaccessible in muskeg during thaws.

## **Miscellaneous Tasks**

73. Maintenance elements will be responsible for minor modifications carried out in the forward area. The variety of terrains and climate over a period will create a need for local modifications ("mods") in order to keep equipment at top efficiency. Limited manufacture may be required, but certainly not ahead of the forward base. As already mentioned, the dissemination of technical information to users and subordinate maintenance staffs will be an ongoing requirement.

## **SECTION 7 - MEDICAL**

### **General**

74. The principles of first aid taught in general military training apply in northern regions just as they do in other areas. The extreme cold simply increases the requirement for speed in evacuation and treatment. A serious casualty must have first aid and environmental protection (eg, in a casualty bag) following injury. The possibility of shock from any injury is much greater in the cold.

75. Personal hygiene is of extreme importance. Personal bathing will be difficult, but all ranks must wash regularly. Clean clothes are necessary since dirt and dried perspiration not only encourage the acquisition of disease, but also reduce the effective insulation.

76. An adequate supply of good food and water is essential to health. Fresh, centrally cooked rations should be provided where possible. Arctic pack rations must be properly cooked and fully consumed. Two quarts of liquid per man per day are required.

### **Medical Installations**

77. The increased need for rapid treatment of casualties, coupled with the difficulty of ground transportation at all seasons, means that unit aid stations (UASs) and elements of the field ambulance must be deployed well forward in the combat area.

78. The large tents commonly used for medical installations must be erected quickly and heated easily. Tent flooring is mandatory for those tents where patients are held. Flame-proof heaters are required for any patient area where oxygen or anesthetics are administered, and heated storage must be provided for medical stores.

### **Treatment**

79. Treatment in the forward area is normally limited to that supportive to the immediate emergency and to successful evacuation. A very short term holding policy ahead of the supporting base is normal, however, because of the uncertainty of flying conditions a holding capability must exist at all medical levels.

### **Evacuation**

80. The initial process of evacuation starts where the man is hit or injured. Provision must be made for stretcher bearers in combat units - whether they are provided for an establishment or not. Troops moving on foot must be followed by casualty toboggans pulled by stretcher bearers. A proportion of all vehicles will be fitted with stretcher kits, this is especially true of high-mobility vehicles as they will often be the only means of reaching and moving casualties. Unit medical elements must have mobility equal to the force they are supporting, and vehicles must be heated.

81. Evacuation of walking wounded becomes a problem in a northern environment where there are no prominent terrain features for personnel to follow to the UAS. Snowstorms, blowing snow, fog, and cloud further hamper the movement of wounded personnel by limiting visibility to that area within a few feet of the individual. If walking wounded must be evacuated by foot, groups of no less than two individuals should be sent to the UAS with consideration given to using the full tent group under extreme conditions. Although it is not desirable, it may be necessary for the casualty to remain with his unit until weather conditions permit movement.

82. Air medical evacuation is the primary evacuation means outside the combat area. Helicopters will be used where possible, and commanders will have to give consideration to dedicating some for casualty evacuation when the situation requires. Logistic aircraft returning from resupply missions may be used to carry patients, and in some instances private or commercial aircraft in the area may be obtained.

### **Medical Standards**

83. In addition to the normal prerequisites, field service troops liable for employment in northern operations should be checked for:

- a. circulatory problems affecting body extremities;
- b. skin grafts on the face;
- c. inner ear problems;
- d. previous history of severe cold injury; and
- e. dental fitness.

84. Individuals trained for and assigned to carry out specific duties not involving frequent or prolonged exposure to the elements, or to be employed in the warm season only, are exceptions to the restrictions listed in para 81.

### **Cold Casualties**

85. Cold casualties are often the fault of the individual or faulty decisions by leaders at various levels. Under cold weather conditions, frost-bite is possible when the windchill level reaches 1420. The individual should be responsible for his own protection up to a windchill level of 1800. The section or platoon commander must be responsible for taking the necessary action to counter the hazard of cold weather in the windchill range of 1800 to 2130. This will include close supervision, reducing periods on guard duties, slower movement with short but frequent halts. At windchill levels in excess of 2130, the task force commander should be responsible for the action taken to reduce casualties to troops working outdoors. Troops can move in windchill levels in excess of 2500, however, they must be in excellent physical condition, well trained and well led.

86. Minor casualties can be expected when carrying out simple routine duties. These include cuts and bruises caused by the loss of dexterity as a result of the bulky clothing. Frost burn from touching cold metal with bare hands is a problem. Pouring fuel over the hands when filling stoves and lamps is likely to result in second-degree frost-bite. POL contaminated clothing is cold and will produce frost-bite in the area of contact. Knowledge and supervision will reduce these problems to an acceptable level.

## **SECTION 8 - PERSONNEL MATTERS**

### **Replacement**

87. During winter months, environmental conditions demand that replacements be properly equipped, and receive cold-weather indoctrination at their home bases prior to moving to the operational area. Replacements should arrive at the forward base and become acclimatized prior to reporting to their units for duty. Recommended minimum acclimatization period is 72 hours.

### **Morale and Discipline**

88. Extremes in temperature, and long periods of darkness and isolation are factors which have a marked effect on morale in northern operations. Above average leadership at all levels is essential to maintain good morale. The overall health of each soldier, and his confidence in his ability to meet the rigours of northern operations is related directly to his physical condition. The effect of physical fitness on morale cannot be overemphasized.

89. Well disciplined troops, properly trained, can operate effectively throughout the year. Unceasing supervision at all levels is mandatory particularly during the winter season. The weather and terrain encountered in northern operations may prevent the personal contact desired by the higher commander, which means that subordinate commanders at all levels are required to take on added duties and responsibilities.

90. With regard to mental health, the following important points must be noted:

- a. recreation is of great value;
- b. periods of personal solitude, and group relaxation are necessary; and
- c. all personnel must be alert to signs of mental distress, especially withdrawal, in their commands.

91. Responsibility for the promotion and preservation of health, and for the prevention of disease rests with commanders at all levels. Officers and NCOs must constantly strive to improve the physical and mental health of their men.

### **Prisoners of War**

92. During the winter months, a problem in the evacuation of prisoners of war (POWs) is their protection from the extreme cold, particularly those captured without sufficient clothing and equipment for survival. Therefore, except for initial interrogation, all POWs should be immediately evacuated rearward. Sufficient guards must be allotted to the aircraft to provide security of the POWs until they are delivered to the supporting base.

## **Burial**

93. Because of the weather and terrain conditions, burial of the dead is difficult in northern areas. Dead will be documented, held in "body bags" in accordance with current regulations, and evacuated rearward on logistic transport.

## **Salvage/Garbage**

94. The high permafrost tables and the cold weather preclude the burying of garbage. It is to be collected in central locations and moved to the rear as transport is available. If transport is not available it is to be dumped in ravines or valleys, and covered by the use of bulldozers.

## **Canex Supplies**

95. This aspect will be affected by two main considerations. First, the absence of local suppliers in many areas; second, the effect on the local community where large stocks are available but are purchased by the military. Should the military impose a significant drain on local resources it will be necessary to restock to meet the needs of the local civilian population.



## **CHAPTER 12**

# **TRAINING**

### **SECTION 1 - INTRODUCTION**

#### **General**

1. The principles of training for operations in the north are no different from those employed in temperate zones. What is different is that the environmental training must be superimposed on a solid basis of individual and unit skills. Whenever possible, environmental training should be scheduled to follow the completion of normal training so that maximum time can be spent on the particular aspects of northern operations.
2. Training emphasis will be placed on conquering those special climatic, terrain, and infrastructure factors discussed earlier. The force skilled in movement, maintenance of weapons and equipment, using the weather to advantage, and employing simple logistic methods will dominate the battlefield. A high standard of physical and mental toughness will be required. Small unit operations under semi-isolated conditions with maximum use of non-daylight hours will be stressed.

#### **Training Objective**

3. To train individuals and units to accomplish their tasks under all conditions of weather, climate, and terrain, and to develop and stress leadership and individual initiative.

#### **Training Areas**

4. Care must be taken in the selection of suitable training areas to ensure that all possible conditions of climate and terrain, likely to be encountered during subsequent operations, are experienced during training. The area most suitable for training for non-specific tasks lie in the area on the edge of the tree line. This area provides high wind and hard snow conditions on the one hand, coupled with an area of relatively low wind and soft snow on the other, all within a 48 km (30 miles) radius. Suitable airfields with a minimum of 1 km runway (3,300 ft), and with navigation aids are essential. Consideration must be given to training in glacier and permanent snow-covered areas, but this may entail the use of specialist troops.

#### **Instructor Requirement**

5. All units will have a number of instructors who have qualified on courses run by the Northern Warfare Training Centre or its equivalent. These personnel will train unit cadres who in turn will do the bulk of unit instruction. Units must try and schedule candidates for advanced courses so that they build up a pool of experience in winter and summer operations above and below the tree line.

6. At least one officer and three WOs or senior NCOs per company should be qualified advanced instructors. Ideally, this advanced group will carry out annual refresher training for themselves and the unit instructors prior to starting unit environmental training.

## **SECTION 2 - CHARACTERISTICS OF SEASONAL EXERCISES**

### **Winter**

7. Winter exercises are the supreme test in training for northern operations. During the period 15 December to 15 March, extreme low temperatures, high winds, and long periods of darkness impose restraints on both personnel and equipment. Exercises during this period will call for a high degree of personnel leadership following on meticulous pre-exercise planning. Restrictions on training imposed by government regulations or high-priority civilian operations are at a minimum during winter. A unit which can operate effectively under these conditions will perform well during other seasons.

### **Spring Break-UP**

8. Exercises conducted during the period 15 March to 30 June, generally provide good flying weather coupled with long periods of daylight. Temperatures are normally above  $-35^{\circ}\text{C}$ , therefore, few problems are encountered with personnel or equipment. Casualties encountered are normally the result of sun-burn or snow blindness. High winds coupled with above normal snow conditions may cause short periods where travel is restricted. As the season advances, warm-weather conditions will cause the snow to crystalize, reducing the bearing capacity, and flooding of low areas will result in restricted movement. To gain the most value for the exercise, training at this time of the year should be carried out in the tree line where the problems are more severe.

### **Summer**

9. Exercises conducted during the period 15 June to 15 September, depending on the latitude of the exercise area, provide minimum special training value except in rivering or amphibious operations. Difficulties encountered by men and equipment are minimal, the major restrictions are encountered in the air support and resupply functions. To gain maximum value from training, the exercise area should be selected south of the tree line in the sub-arctic regions.

### **Fall Freeze-Up**

10. Exercises conducted during the period 1 September to 15 December, give a good return on the time invested. Casualties encountered are normally of the wet-cold variety. Cross-country movement is restricted because the active layer in the permafrost area is not frozen. Ice conditions are unsafe, snow and blowing snow is common, and high winds prevail in arctic regions. Daylight hours reduce rapidly each day. Many hours will be spent in vehicle recovery which must be carried out immediately due to the danger of freeze-up. Next to the winter training period, the fall provides the most difficulties for commanders at all levels. Air support and air supply will encounter many delays because of poor flying conditions. To gain the maximum value from training, the exercise area selected should include both tree line and tundra conditions.

## SECTION 3 - COLD-WEATHER TRAINING

### General

11. The basic requirement for training in northern operations is the same for all seasons. Toughness, resourcefulness, initiative, confidence, and the ability to live and operate in the field are required by each individual. Nevertheless, troops trained under extreme winter conditions are normally capable of operating in any other season.

12. The best exercise period is the time frame 1 December to 30 March.

### Training Emphasis

13. To ensure that the basic techniques of northern operations are thoroughly mastered and correctly applied, corrective procedures must be emphasized at all times during training - even very minor errors must be pointed out and the proper corrective action demanded. If men are properly trained during the training cycle they will continue to perform the necessary tasks when confronted with the extreme conditions found in an area of operations. It must be impressed on the troops that their job is to complete the mission and not one of survival.

14. Some of the more common areas requiring emphasis are:

a. Personnel -

- (1) keeping the body clean, and proper care of feet,
- (2) importance of hot food, preventing dehydration, over-heating, and constipation; and
- (3) troop safety to include carbon-monoxide hazards, cold-weather injury, first aid, and self-aid techniques.

b. Weapons -

- (1) proper care of weapons and equipment, and
- (2) proper employment of weapons.

c. Movement -

- (1) moving at night,
- (2) rapid deployment and cross-country movement on skis and snowshoes,
- (3) using expedient means to maintain mobility when confronted with obstacles or equipment failures, and

(4) route selection, trail breaking, and land navigation.

d. Tactics -

(1) proper camouflage discipline, and

(2) using the terrain and weather to advantage.

e. Communications.

f. Vehicles -

(1) driving techniques,

(2) recovery at platoon level, and

(3) field maintenance.

g. Special Training -

(1) glacier crossing techniques, and

(2) mountain climbing techniques and skills.

### **Training Phases**

15. All training requires a well coordinated program. Units should attempt to carry out winter training at their home stations in the coldest winter period. Training falls into the following phases (timings are suggested only):

a. Phase one - Indoctrination training at home station - one week.

b. Phase two - Specialist training at home station - one week.

c. Phase three - Preliminary training at exercise area - 96 hours.

d. Phase four - Unit/combined arms exercise at exercise area.

### **Indoctrination Training at Home Stations**

16. Individual training and small-unit training should cover clothing, camp routine, tent group equipment, land navigation, field defences, first aid and hygiene, dismounted movement, snow-shoe and/or ski training, camouflage, emergency shelters, and patrols. All periods of instruction should be carried out outdoors, and endurance built up by snow-shoe marches carrying full equipment. Although in operations, the normal practice will be to move the comfort items by means of mechanical transport during training, the maximum load should be carried.

## **Specialist Training at Home Stations**

17. During this period, route marches with snow-shoes and rucksacks should be continued daily in order to build the physical fitness of the troops. Emphasis in training for all ranks must be placed on special techniques and procedures necessary to use and maintain all equipment in good condition.
  - a. Driving and Maintenance - The highest standard of driving and maintenance must be achieved. To overcome the difficulties encountered during winter operations, close supervision by officers and NCOs is required to ensure that high standards are maintained. Unit commanders should use the vehicle repair section to supervise maintenance periods. Special training is required in the use of winterized equipment, engine heaters and other special devices, care of batteries, and the treatment of fuel to avoid condensation. Extensive practice in driving and recovery under the most difficult conditions of terrain, snow, and ice, must be practised. Drivers must be trained to make on the spot emergency repairs and in the use of field expedients.
  - b. Communications - Commanders should be aware of the environmental factors that affect communications, and the measures necessary to overcome them. All communication personnel must learn the special techniques necessary to prepare and maintain their equipment and communication nets at operational efficiency under northern conditions.
  - c. Equipment Repair - The conditions of northern warfare cause a high rate of damage to all equipment. All ranks must be aware that supply will be limited, and maintenance of many items of equipment must be undertaken by the individual eg, tents, snow-shoes, skis, tent group equipment, and clothing. The commander will ensure that special emphasis is placed on preventive maintenance of equipment, and make the necessary plans to augment his repair sections as necessary.
  - d. Navigation - In certain regions, and for certain types of operations, the force may require personnel trained in more advanced navigational techniques. This would especially include commanders at all levels, reconnaissance personnel, and messengers. Details are in Part One.
  - e. Chemical and Nuclear Training - Since extreme cold conditions will affect the standard procedures necessary for individual protection this will be included in this phase of training.
  - f. Other Specialized Training - Special attention must be given to training of weapons crews, medical and engineering personnel, and specialists in all supporting arms and services. Emphasis must be placed on special techniques, procedures, and maintenance.
18. The training of officers and NCOs must include the following in addition to all subjects covered above:

- a. Leadership - The qualities of leadership demanded by northern operations are far higher than those normally required for any other type of warfare. Fear of the area of operations must be overcome, and leaders must be impressed with the exacting nature of their responsibilities in this respect. They must have a thorough knowledge of all aspects of northern operations applicable to their unit and appointment, and must constantly supervise. They must be able to anticipate problem areas and take preventive action.
- b. Elementary Meteorology - Officers must be able to interpret meteorological reports, since weather will be a major factor in the planning and execution of operations.
- c. Bearing Capacity of Ice - Each officer and NCO should be thoroughly acquainted with the various factors affecting the strength of ice, and the rules or calculations necessary for the determination of its bearing capacity. (See Chapter 5.)

### **Preliminary Training in Exercise Area**

19. This stage is desirable but not essential. The commander must consider the value of this training based on the prior standard achieved by his unit. One disadvantage is that it detracts from the overall realism and realistic sequence of events when the exercise is based on a deployment from a southern base. The advantage of this type of training is that all troops undergo a refresher and achieve limited acclimatization in the area of operations.

20. This training can be achieved by either a formal training program or a small simple exercise. This allows unit commanders to make final adjustments in arrangements for the major exercise, plus it builds up the confidence of the troops in themselves and their equipment. Lessons learned can be re-examined and the subunit commanders will become more confident prior to the main exercise. Commanders should consider using the deployment phase, when timing and delays are normally encountered before the full force is available on the ground, to insert this type of training.

## **SECTION 4 - WARM-WEATHER TRAINING**

### **General**

21. Operations during the summer period are normally more demanding physically than winter operations. Long periods of daylight require more attention to camouflage or deception. During this period, travel across tundra areas can be very fatiguing because of the continuous slippage in the soft moss-covered terrain, therefore, route selection becomes a major factor. In the subarctic area, temperatures can rise above 32°C with little wind, however, the weather changes rapidly, and temperatures can plunge to near freezing. In the area of open water in the arctic islands, cold wet fog will settle in for days at a time. Insects will force troops to use mosquito nets, and to keep their hands covered. All these factors must be considered when training for summer operations. The period late June to mid-September is generally the best for summer training.

### **Training Phases**

22. Units should carry out northern summer training at their home stations in spring conditions, thus approximating the weather conditions in the area of operations. Training for summer operations might be categorized in the following phases:

- a. Phase one - Indoctrination training at home station - one week.
- b. Phase two - Specialist training at home station - 72 hours.
- c. Phase three - Unit/combined arms exercise at exercise area.

### **Indoctrination Training at Home Stations**

23. The main requirement for phase one is physical fitness of the participating troops. Individual training and small-unit training should include tent group equipment, land navigation, dismounted movement including snow-shoeing, camouflage, and patrols. All periods of instruction should be carried out outdoors. Movement by foot or on snow-shoes requires good stamina. Snow-shoes are a valuable aid when moving cross-country in areas of soft tundra. They are not suitable on certain arctic islands because of the lack of vegetation and the soft clay-like surface which clings to the webbing of the snow-shoes. Particular attention should be given to cold-weather injury as it relates to cold wet weather.

### **Specialist Training at Home Stations**

24. The same subject matter discussed in paras 17 and 18 is required for training in summer operations, what will be different are the techniques employed to cope with the changes in temperature and mobility. Physical fitness remains paramount. Other aspects to be considered in the light of summer conditions are:



- a. Driving and Maintenance - Training of all drivers on driving techniques in soft boggy ground with particular emphasis on the recovery of vehicles at the section and platoon level using their own resources.
- b. Leadership - The requirement for a high standard of leadership, although not as demanding as in winter training, remains high. All officers and senior NCOs must have a thorough knowledge of northern operations under summer conditions. Constant supervision is essential at all levels.
- c. Watermanship - Numerous lakes and rivers in addition to Arctic Ocean shoreline present many opportunities for the use of small boats.

## **SECTION 5 - RESTRICTIONS ON TRAINING**

### **General**

25. The selection of exercise areas must be based on providing the terrain, weather, communications, and other facilities found in an anticipated area of operations. Nevertheless, there are a number of external factors which must be considered prior to selecting an area.

### **Land-Use Regulations**

26. Restrictions on cross-country travel with vehicles having ground pressure in excess of five pounds per square inch (PSI) or a net vehicle weight of 20,000 lbs are in effect for the period 1 April to 1 October annually north of the 600 parallel. This dictates that most exercises will be held in the period November to March in the arctic and parts of the sub-arctic.

27. Disposal of waste water is a constant problem in extreme -cold, and even in the summer in the presence of underlying permafrost. Satisfactory drains can be constructed by digging or blasting deep pits, filling these with large rocks, and covering them with about 50 cm (20 in) of earth. These will last six months under range conditions.

### **Wildlife**

28. Several areas have been set aside as wildlife sanctuaries by the federal government. Restrictions in flying over these areas are in effect from 15 May to 1 September annually.

29. Migration of wildlife, in particular caribou, will affect the selection of training areas. In the spring, the barren-land caribou on the mainland migrate north from their winter feeding grounds in the tree line to their summer pastures. They make the reverse journey in the fall. On the arctic islands the caribou move from winter to summer areas, with migration not restricted to any particular direction. Any major exercise in these areas would provide considerable reaction from the local population.

30. In the Churchill, South Hampton Island, and Devon Island regions, polar bear denning areas are common. This animal is protected under international agreement, although some limited harvesting by the local Eskimo communities is allowed. Some areas such as Banks Island provide excellent trapping for white fox. A major military exercise in these areas is undesirable and will probably not be approved.

### **Weather**

31. Weather conditions in the north change rapidly. Limitations on flying and ground movement are common. Prior to planning any exercise, full use should be made of available meteorological information. This should include average temperatures, wind velocities, and precipitation. Effects on communication by auroral borealis and sun spots should also be considered.

## **Local Population**

32. A study should be carried out on the government and civilian activities at the time of the exercise, and of the attitude of the local communities. Contact with the community councils and the local priest or minister is a sound approach. The location of local graveyards, water lines, and roads must be confirmed.

## **Food and Sundries**

33. Troops should not be allowed to purchase food, cigarettes, candies, etc, from the local stores. The outlets are normally restocked yearly either by river or sea transport. Any additional requirements are transported by air. One company group visiting one store can purchase items which may not be replaced for months. This causes resentment and unnecessary hardship to the local population.

## **SECTION 6 - COORDINATION WITH GOVERNMENT AND OTHER LOCAL AGENCIES**

### **Northern Region**

34. The military headquarters responsible for coordination and supervision of all military exercises within the area of the Northwest Territories and the Yukon is NRHQ. An information bank with well catalogued information on communications, service facilities, fuel, weather, terrain, and local personalities is maintained. The command and control agency of the Canadian Rangers and local cadet corps is located at NRHQ. The Canadian Rangers are active in most larger communities and could provide an excellent source for guides. In Certain communities, the local cadet corps normally provides a source of communications and escorts for visiting parties. These cadet corps have a portion of native children who may be of value during summer exercises.

### **Federal Agencies**

35. The major federal government department active in the Canadian arctic and parts of the subarctic is the Ministry of Transport. In addition to its year round tasks, it is also represented by the Ministry of Transport's Marine Division at Resolute Bay, Frobisher Bay, Churchill, and many smaller communities during the shipping season. Communications by aeroradio at most major airfields and by marine radio during the shipping season are provided by the Ministry of Transport.

36. The Ministry of the Environment provides weather data. for the Canadian north. Most stations are manned by weather observers with weather reports provided by Arctic Central Edmonton from the Toronto terminus. Because of the shortage of forecasters, the weather data is sometimes a few hours old. More timely data is available only on request.

37. The National Research Council has stations at Mould Bay and Resolute Bay, NWT. Although the main functions are the manning of seismographic stations for the recording of earth tremors, they also conduct continuation monitoring of the magnetic field. The direction and strength of the magnetic flux is available upon request through this council. The council also maintains a rocket range at Churchill, Man. A full yearly program is in effect. Restricted air space over Cape Churchill, south to the Nelson River, and covering most of Hudson Bay, restricts air travel from southern Canada. A secondary range is sometimes operated at Resolute Bay, NWT. The Department of Energy, Mines and Resources operates seismic stations for recording earth tremors, and detecting nuclear explosions, as well as magnetic stations for continuous monitoring of the earth's magnetic field at the following locations:

<b>Location</b>	<b>Seismic</b>	<b>Magnetic</b>
Alert NWT	+	
Baker Lake NWT	+	+
Cambridge Bay NWT		+
Churchill Man.	+*	+*
Frobisher Bay NWT	+	
Great Whale River (Poste de la Baleine)	+*	+*
Igloolik NWT	+	
Inuvik NWT	+	
Mould Bay NWT	+	+
Resolute Bay NWT	+	+
Schefferville PQ	+	
Whitehorse	+	
Yellowknife NWT	+	

(\* operated on contract by the National Research Council)

The Polar Continental Shelf project of this department has been providing the coordinating arctic logistics for many government departments including National Defence since 1957. It is the only Canadian agency maintaining camps on arctic icecaps, and on the Arctic Ocean.

38. The Department of Northern Health and Welfare staff nursing stations at many of the small communities. X-ray facilities are sometimes available. Major hospitals are located at Inuvik, Frobisher Bay, and Churchill.

39. The Department of Public Works carries out construction duties in the subarctic and sometimes in the arctic.

40. The RCMP are responsible for the preservation of peace, the prevention and detection of crime, and the maintenance of law and order. The RCMP is the only enforcement agency in the north, and is responsible for enforcing all federal statutes, territorial laws, and, through agreements, municipal by-laws in several communities.

41. The Department of Indian Affairs and Northern Development areas of responsibility include coordination, advice, management, and administration of the following branches:

- a. Indian and Eskimo Affairs;
- b. National and Historic Parks;
- c. Northern Economic Development; and
- d. Territorial Affairs.

42. The Northern Canada Power Commission is responsible to provide utilities in the Yukon and Northwest Territories as authorized by the Governor-in-Council. Each community is

provided electrical power including transmission to the consumer. Some communities are also supplied with heat (steam), water, and sewage.

43. The Department of Communications is responsible for the development and operation of communications. This area of interest includes telephone, radio, and television communications. Telephone links exist to nearly all communities in the north.

### **Territorial Government**

44. The Territorial Government of the Northwest Territories is located at Yellowknife. Land-use regulations, game management, education, local government, and tourism are some of the functions carried out by this government.

45. The Territorial Government of the Yukon, which is located at Whitehorse, carries out the same function for that territory.

### **Annual Resupply Programs**

46. Resupply of military bases in the north is carried out on a twice a year basis. Timings are based on flying conditions, daylight hours, and the condition of the airfield. The main commitment is carried out during the July - August period annually. This affects military exercises due to the non-availability of transport aircraft, the high level of activity at airfields, and the increased traffic on military and civilian communication networks.

47. Resupply of civilian communities is carried out normally by sea transport, particularly in the eastern arctic. In support of these activities, normally all heavy ice breakers are located in northern waters from mid July to late October. Ice patrols are carried out by civilian aircraft under contract to the Ministry of Transport's Marine Division. These aircraft normally are based in Frobisher Bay and Resolute Bay. Facilities are normally strained at this time of year because of the urgency of unloading caused by the short shipping seasons, and the ice floes which sometimes hamper shipping.

48. Forward transport by civilian aircraft is carried out from the main unloading sites when ice conditions preclude penetration by the sea transport to the more remote arctic islands. Resupply to these areas is normally carried out in late April to mid-May when smaller transport aircraft utilize the many ice strips available. The rationale for this timing is the long hours of sunlight with clear flying weather, and ice on the lakes at a thickness of 1 to 2 metres (3 to 6 feet).

49. Fuel requirements for exercises must be stated prior to 1 April annually, and storage facilities made available before exercises can be planned.

## SECTION 7 - PLANNING FOR EXERCISES

### General

50. All major exercises require detailed planning to be carried out well in advance of the exercise data. The following items summarize the factors described earlier.
- a. Land-use regulations may restrict the types and size of vehicles available to the Exercise Director.
  - b. Wildlife sanctuaries and seasonal migration will restrict selection of exercise areas, and use of low-flying aircraft.
  - c. Firing programmes at Churchill Rocket Range will restrict air corridors and land use in certain areas.
  - d. Resupply by both military and civilian programmes will restrict activities at designated airfields, harbours, and some rivers.
  - e. Availability of aircraft fuel must be confirmed by 1 April prior to the exercise year. For planning purposes the exercise year is 1 September to 1 September annually.
  - f. Garbage disposal and land-fill regulations may require, long-distance garbage hauling or complete removal from exercise areas.
  - g. Heavy transportation by rail during and prior to shipping season will affect rail transport schedules, and restrict military exercises in some areas.

### Scope

51. The scope of the exercise will be influenced by the following:
- a. The organization of the unit and/or sub-units to be exercised.
  - b. The equipment scale of unit to be exercised with consideration for specialized and/or new equipment.
  - c. The availability of transport to the exercise area by air, sea or land.
  - d. The physical fitness of the exercise troops.
  - e. The pre-exercise training carried out at home bases prior to the exercise.
  - f. The requirement for indoctrination training in the exercise area prior to the main exercise.

- g. The administrative and logistic support necessary to support the exercise in the terrain and climatic conditions selected.
- h. The effects of the climate on personnel, weapons, communications, and mechanical equipment.
- j. The effects of the terrain on mobility.
- k. The dates and length of the exercise.

52. All exercise timetables must be flexible enough to allow for unforeseen circumstances. Sufficient time must be available to allow completion of all assigned tasks. The survival aspects of exercises must be treated as normal and not an end in themselves. Weather conditions must be utilized to best the predominant factor.

53. The actual content of the exercise must allow for best use of the time available. Subunits must not have too much time on their hands. It is better to have a number of independent but concurrent activities rather than a slow steady build up to a hectic finale.

### **Pre-exercise Training**

54. The scope and duration of pre-exercise training will depend on the standard of training and previous experience in northern areas of the troops to be exercised.

### **Recce of Exercise Area**

55. The recce of the exercise area should be carried out by the unit to be exercised. Included in the recce party must be representatives from the administrative and logistic cells. A representative from the intelligence and security branch is most valuable as contact with the local RCMP detachment will provide advice on local problems, personalities, and possible areas of conflict. Also included should be a representative from other commands which may provide support. A representative from the command headquarters concerned, representing both training and logistic support, must be present.

### **Tactical Exercises without Troops**

56. Consideration should be given to the use of tactical exercises without troops for the training of officers and senior NCOs. This technique of training is both economical and practical. Utilizing local facilities; for accommodation, transport, etc, will familiarize leaders with resources available in various operational areas. This type of training has seldom been used in an arctic or subarctic setting, and is probably one of the areas of greatest value for, peace-time training.



## **Exercise Security**

57. Physical security of equipment is normally not a serious problem, however, with the increase of transient personnel in the north this condition will change. Military stores are of interest because of their value in survival situations.

58. Communication security is a major consideration in the north. Most outports have HIT radio sets, and continuously monitor any nets available. Interference on local HF radio sets, and continuously monitor any nets available. Interference on local VHF bands by military units in southern USA, South Viet Nam, and Northwest Europe indicates that abnormal reception is experienced in northern latitudes under certain conditions. All ranks must be proficient in good voice procedure and security conscious.

59. During the shipping season, ships from many nations are involved in the grain shipping trade from Churchill, Man., and in the fuel resupply to the northern islands. This, coupled with the number of non-Canadian tourists, visitors, and employees indicates that caution in passing military information is essential.

## EQUIPMENT OPERATING TECHNIQUES

1. Training personnel to recognize the difference between temperate and cold-weather operations is mandatory. Operators must know that:
  - a. Linkages are stiff and should not be forced.
  - b. Windshields crack easily when subjected to sudden blasts of warm air or water.
  - c. Vital spots or portions of equipment affected by cold should be kept under cover.
  - d. Familiarity with the cold-weather portions of their operator's technical manuals is mandatory.
  - e. Lubrication should be applied according to the temperature range of the equipment lubrication charts.
  - f. Condensation of moisture inside fuel tanks can be minimized by refilling tanks immediately after stopping for the night.
  - g. To prevent brakes from freezing, the wheels or tracks should be chocked instead of setting the hand brakes.
  - h. Parking on timber, brush or any material that will keep the tires or tracks off the ice, puddles or snow, will prevent them from freezing to the surface.
  - j. Tire stems should always be kept capped.
  - k. Equipment should never be operated in a closed area because of the possibility of carbon monoxide build-up.
  - m. Chains, shovels, and saws must be kept with all vehicles.
  - n. Precautions are required to keep snow and water out of gasoline and fuel oil when refuelling.
  - p. Adding one half pint of denatured alcohol to each 10 gallons of fuel at the time of filling will improve performance. They should check daily for water or anti-freeze solution in the crank case. If fuel or water contamination is found, do not operate the vehicle until cause is found.
  - q. Because of heavy electrical loads in vehicles as a result of radio sets, heater, headlights, fans, etc, they must ensure that batteries are not allowed to run down. Particular attention must be paid to the generators, belts, electrical connections, and battery condition.

- r. Optical instruments must be kept from sudden and extreme changes in temperatures.
- s. Vehicles must be lubricated immediately after operations as working parts are warm, and maximum penetration of lubricants will result.

## ASSESSMENT OF THE ENEMY - NORTHERN OPERATIONS

1. A check list to assist in determining the enemy's capability to move and fight in the north might include the following questions in addition to those used in temperate climates:
  - a. Is the enemy equipped with skis or snow-shoes?
  - b. What is his status of northern training?
  - c. Does he have oversnow or through snow capability?
  - d. Does he have snow removal equipment? What kind?
  - e. What type of artillery (self propelled or towed) does he have?
  - f. Are the guns ski equipped?
  - g. Is he using skids or some other type of oversnow transport to move unit equipment?
  - h. Is he using heated shelter? What kind?
  - j. Is he using improvised shelters?
  - k. What type of winter clothing is he using? What kind of protection does it afford?
  - m. What kind of weapons does he have? Are they effective in extreme cold? What are their effects in deep snow? Can the heavy weapons follow infantry units in cross-country movement?
  - n. What kind of aircraft does he use for transport or fire support?
  - p. What is the capacity of his logistic support systems?
  - q. What is his airmobile capability?
  - r. What are the locations and quantities of local resources (including fuel) available to the enemy?

## BATTLE INDICATORS

1. Examples of cold-weather battle indicators that may indicate the presence or passage or a hostile force are:

- a. signs of a bivouac area -
  - (1) packed snow,
  - (2) emergency shelters,
  - (3) remains of fire,
  - (4) trail networks,
  - (5) trash left in the area, and
  - (6) freshly cut wood;
- b. tracks in the snow that were made by -
  - (1) men on skis or snow-shoes,
  - (2) tracked vehicles,
  - (3) helicopters,
  - (4) aircraft using skis,
  - (5) air cushion vehicles,
  - (6) sleds,
  - (7) wheeled vehicles, and
  - (8) animal transport;
- c. improvement of winter trails;
- d. presence of winter landing strips;
- e. presence of ice bridges;
- f. ice fog;

- g. smoke;
  - h. mechanical or man-made sounds; and
  - j. enemy movement and electronic emissions.
2. Examples of cold-weather battle indicators that may indicate the size of a hostile force in an area are:
- a. site and configuration of bivouac area;
  - b. size and numbers of shelter or tents in a bivouac area;
  - c. the number of trails present within a given area; and
  - d. enemy movement or electronic emissions.

## COMMANDERS' GUIDE LINES FOR NORTHERN OPERATIONS

### Leadership

1. Know, understand, and appreciate the problems of northern operations.
2. Forceful action is the key to success.
3. Ensure your command is safety conscious. Check for fire hazards (especially gasoline handling), carbon monoxide poisoning, frost-bite, and safe driving habits.
4. Planning is one of the most essential elements for the successful conduct of northern operations. Planning time can be shortened by the use of SOPs. A workable, simple, well-rehearsed SOP is mandatory for all units down to and including section levels.
5. Most of the disabling problems associated with winter operations in northern areas can be avoided if commanders at all levels are knowledgeable concerning the individual soldiers response to stress and fatigue.
6. Health is of primary importance. Without dynamic personal leadership the average soldier in northern operations becomes lethargic, dehydrated, and undernourished with resultant mental and physical degeneration. To prevent this, commanders must ensure that personnel consume adequate water and nourishment, and practice good personal hygiene habits.
7. Physical fitness is paramount. Commanders must place great importance in this area. Troops must have an active schedule, and be required to spend periods outdoors regardless of the weather conditions. This includes personnel employed in more sedentary tasks such as cooks, radio operators, and staff officers.
8. As weather or tactical conditions deteriorate, the confident dynamic leader is the best deterrent to problems.

### Tactics

9. Mobility must be considered one of the cardinal principles of operations in the north. True mobility can only be obtained through proper use of tactical aviation, oversnow equipment, and tracked vehicles.
10. Rapid movement of small units with adequate fire power, mobility, and communications plays a vital role in the success of northern operations. Operational planning must include the use of vertical envelopment, and wide flanking attacks to exploit the principle of surprise.
11. Because of the vulnerability of forces in daylight, brought on by slow movement, and problems of concealment, night operations should be a prime consideration.

12. In order to provide protection from air and ground fire, maximum use should be made of weather conditions. Attacks should be launched with the wind at the back of the attacker and in the face of the defender. During heavy fog conditions or blowing snow the elements will tend to nullify the noise problems. Tracked vehicles travelling downwind create a blizzard which may obscure driver visibility.

13. Troops in northern operations are particularly dependent on their lines of communications, whether by air, road, water, or rail. An enemy can be defeated by interdiction of his lines of communication, either by the interposition of forces or by destroying them by air strikes.

14. The construction of adequate ground lines of communications to forward elements is prohibitive in terms of engineer effort required. Therefore, emphasis must be placed on air and sea supply. Where this is not possible, land supply using low ground-pressures vehicles or, when necessary, back carriage will have to be implemented.

15. Combat effectiveness is most difficult to maintain unless troops are kept warm, fully hydrated, and in a condition to fight. Thus, a force that is exposed to the elements for long periods and not accompanied by warming equipment and other essential support is vulnerable to defeat.

16. Accurate up-to-date information on weather, ice, and snow conditions is essential. Information disseminated to all levels as it is received helps tactical planning, work programmes, and even tent group routine.

### **Communications**

17. The communications net is the commander's life line. Communications provide control, and control permits command. Unceasing effort is required to maintain communications.

18. Communications is a system or series of systems. All alternative means must be employed to provide continuous communications to all elements of the task force.

19. Because of reliance on radio, be especially aware of communications security. Use appropriate codes and keep traffic to a minimum.

20. Use vehicles as radio-relay stations. Ensure that vehicles used in this role are equipped the telescopic antennae to place antennae over 6 m (20 ft) above the vehicle to provide communications during periods of blowing snow.

### **Tactical Air**

21. Payload capability of aircraft is reduced in the north because of added weight of ski installation, require survival equipment, and long distances.



22. Rotor systems and engine exhaust often cause ice fog which may create delays in getting aircraft airborne. Because of these delays, use prepackaged loads to save ground time.
23. Use lakes and rivers for airfields to save construction time. Eskers, raised beaches, and flat plains or plateaus can be used during summer periods.
24. Plotting accurate ground positions is difficult in terrain with few recognizable landmarks. Use pilots to assist in determining ground unit positions because of their ability to see units in their relation to other land marks.
25. Arrange for commanders to recce terrain from the air. Use aircraft to guide moving columns.
26. Pilots should habitually monitor command nets and offer to relay messages. Aircraft should be employed on stations as an aerial relay for communications where required.
27. Aircraft loads should be carefully planned and pre-loaded during periods of non-flying weather to permit immediate dispatch at first break in weather or light.

### **Engineers**

28. Make maximum use of engineer-support available. Engineers are vital for: water supply; road and bridge construction; neutralization of barriers, obstacles and fortifications; construction of airfields, camouflage, electrical power, and heating.
29. If an engineer staff officer is not on establishment, use an attached engineer commander to coordinate staff planning and overall engineer effort.

### **Intelligence and Security**

30. Make maximum use of all intelligence collecting agencies including air-photo and air reconnaissance.
31. Route reconnaissance should precede any troop movement. Terrain obstacles often make the "long way around" the best route.
32. Be especially aware of sound and light discipline in forward areas.
33. Emphasize deception (effective camouflage and concealment are extremely difficult).

### **Administration**

34. Preventive maintenance requires more time and effort, and must be a matter of major concern and emphasis by all in the chain of command.
35. Winter driving and operation of equipment must be stressed.

36. Plan logistical support in great detail even for small-unit operations. Ensure that the force is provided adequate support to include sufficient heat, food, clothing, sleeping gear, tentage, POL, and ammunition resupply.

37. During extreme temperatures, plan additional time to accomplish tasks. Experience has shown that five times the norm may be required.

38. Frost-bite causes casualties, do not underestimate the effect of cold.

39. Gather all information on available logistic support including vehicles, fuel, food, communications, airfields, and personnel in any community, or installation in the area of operations. These supplies should be considered as supplements to requirements in emergency circumstances. Plans should include replacement of stores and equipment on the termination of the operation.

## LESSONS LEARNED

### General

1. Since the end of World War II the Canadian Forces have conducted many exercises, courses, and other forms of training activity in the north. The lessons learned from these experiences have been incorporated into doctrine and teaching, yet many of them continue to recur. Although it is intended that the correct lessons be included in one of the parts of the Northern Operations series, some of the more pertinent ones are listed in this annex. Only the problems are highlighted here, the solutions are found in the text or are self-evident. Commanders should review this list with the goal of not rediscovering these long-established truths on operations or training.

### Human Factors

2. Physical -
  - a. The standard of physical fitness is not as high as required for the conditions encountered.
  - b. Soldiers tend to carry a heavier load than is efficiently valid. The aim must be to carry no more than 16 kilograms (35 lbs) including ammunition.
  - c. All ranks fail to observe anti-dehydration precautions. Commanders must ensure sufficient liquid intake to compensate for lost body fluid due to hard work, heavy clothing, and equipment.
3. Psychological -
  - a. Fear of the environment has a degrading effect on efficiency. Knowledge, positive attitude, physical fitness, and leadership can overcome this fear.
  - b. Training must be positive - too much emphasis on the dangers of the north breeds unnecessary caution.
  - c. Troops seek out strong leadership more in a northern environment. Natural leaders emerge among tent group members. Commanders must utilize this natural leadership but within the normal chain of command.

### Common Injuries

4. Frost-bite -
  - a. Normal causes are wet or tight clothing, failure to use the 'buddy system', insufficient supervision, and poor physical condition (troops too tired or hungry to exercise care).

- b. Clothing problems are minimal - those that do exist are being rectified.
- 5. Tent-eye -
  - a. Common cause is improperly maintained stoves, lamps, etc, as well as not allowing proper ventilation in tents and shelters.
  - b. Scientists are working on the clean burning of fuels. In the meantime tent group discipline including cleaning of kit, ventilation of tents, and encouragement to leave the shelter for the open air are the only remedies.
- 6. Snow Blindness - Not as common now as a few years ago, Sunglasses, including temporary expedients, will practically eliminate the danger.
- 7. Sun Burn -
  - a. Surprisingly a common casualty producer, especially in the spring in arctic and alpine regions.
  - b. Commanders should utilize periods of darkness, cloud, etc, to minimize exposure. Something like 72 hours gradual exposure is required for acclimatization.
- 8. Trench Foot - Improved footwear has reduced the incidence. During seasons when mukluks are not appropriate but the going is wet, plastic garbage bags are a temporary substitute. Rubber overboots (or jungle boots for that matter) will help to reduce the danger.
- 9. Frost Burn - Some wrist watches and metal spectacle frames cause frost where the metal touches the skin. Skilful application of adhesive tape is the remedy. Combat glasses (with plastic frames) and "anti-dim" from the mask bio-chem can be usefully employed even when there is no nuclear-chemical threat.

## **Equipment**

- 10. Tents - Current problems (R&D is busy!) are:
  - a. Tent Poles - Despite collapsible metal types, are not immune to high winds. Bracing by wood, double poles, and other expedient material is the only answer.
  - b. Tent Zippers - New models are less vulnerable, but an adequate stock of spares is the most reliable guarantee.
- 11. Toboggans - The runners on the 91-kilogram (200-lb) toboggan last only for 100 km (62 miles) in the rugged arctic terrain when extreme cold is the norm. Icing of runners using warm water will extend the life of the runner.

12. Lamps and Stoves - Common faults leading to failure of these items are:
  - a. water in the fuel;
  - b. improper maintenance (including carbon due to non-cleaning) and wrong assembly of components; and
  - c. ice in fuel caps - when this melts in a warm tent it causes release of gas under pressure resulting in a fire hazard.
13. Axes and Shovels - Troops fail to appreciate effect of cold on metal; rough usage leads to high breakage rates.
14. Ice Augers - Below  $-34^{\circ}\text{C}$  screw type augers are not efficient, ice chisels or crew bars are suitable alternatives.

### **Weapons**

15. Cold-Weather Data - Current firing tables, weapon manuals, etc, do not provide data for operation of weapons in extreme cold.
16. Ancillary Items - Fire control equipment for guns and mortars is not designed for use north of the 70 degree latitude, fuzes are not designed for low-temperature operation.

### **Clothing**

17. Footwear - Most problems with mukluks stem from improper fitting. It is a joint responsibility of the individual and the supply section to ensure proper fit. Tent group commanders must-ensure that footgear is properly dried out during halts.
18. Parka and Windpants - The tendency is to wear form-fitting gear which does not allow proper air circulation. This approach can lead to cold injury and must be stopped.
19. Face Mask - The current mask (spring 75 has not been perfected. While modifications are taking place all ranks must watch for frostbite around the edges of the mask especially in the throat area. Proper use of the combat scarf will alleviate this problem.
20. Mittens - Some mitts, arctic, short, are still in the supply system. At temperatures below  $-18^{\circ}\text{C}$  these mitts allow frost-bite of the wrists. Unit supply officers must attempt to exchange these items before deployment.

## **Training**

### 21. Driving and Maintenance -

- a. Driver training has to be expanded to put more emphasis on cold weather techniques, ie, operations at -34°C. Cold weather starting, use of radiator shutters, and recovery techniques are some of the areas requiring improvement.
- b. Most problems with vehicles in extreme cold can be traced to water in the fuel. Drivers must understand preventive maintenance procedures which will reduce the incidence of this happening.

22. Navigation - While use of the astro compass is taught in northern training it cannot be relied on as a standard navigation aid. Long periods of reduced visibility (ie, when stars are visible) limit the astro compass. Its main value is in providing a check on the magnetic compass. Until better navigation aids (such as a "navaid" for the north) are developed a combination of magnetic compass, map, and dead reckoning must suffice.

## NOTES ON RUSSIAN AND FINISH WINTER WARFARE TACTICS

### General

1. Soviet tactical concepts for winter warfare follow as closely as possible standard Soviet doctrine for modern ground combat, that is, large-scale, armoured formations moving rapidly along parallel axes of advance, and supported by the air-artillery-missile team armed with both conventional and nuclear weapons. Annually, Soviet troops conduct exercises under severe winter conditions.
2. Soviet winter warfare doctrine emphasizes the importance of possessing roads, and of the use of inhabited areas and forests as protection from the cold. On the march along highways and roads, strict security is enforced because of the possibility of enemy surprise attacks to capture the road, and of the slowness of deployment for an encounter battle in heavy snow or other extreme winter conditions.
3. Soviet soldiers are trained for winter warfare, and special winter equipment is used to a considerable extent. Operational plans are flexible to cope with any sudden changes in the weather.

### Rates of March

4. According to Soviet doctrine, the following movements can be accomplished under conditions of cold and snow:

<b>Rates of March</b>	<b>Kilometres per Hour</b>	<b>Miles per Hour</b>
Infantry	3 to 4	2 to 2-1/2
Infantry (snow over 30 cm (12 in) deep)	1-1/2 to 3	1 to 2
Single skier	6-1/2 to 8	4 to 5
Small ski unit 2	4 to 5-1/2	2-1/2 to 3-1/2
Large ski unit	3 to 4	2 to 2-1/2
Motor sled	19 to 24	12 to 15

The rates of march of vehicles is approximately equivalent to that of shi troops.

<b>Day's March (6 to 7 hours)</b>	<b>Kilometres</b>	<b>Miles</b>
Infantry	18 to 24	11 to 15
Ski unit	32 to 40	20 to 25
Motor sled	96 to 112	60 to 70

## **Thickness of Ice**

Infantry	10 cm (4 in)
Medium tanks	70 cm (28 in)
Heavy tanks	80 to 100 cm (32 to 40 in)

## **Depth of Snow - Tanks**

Snow under 50 cm (20 in)	- tanks employed as usual.
Snow 50 to 75 cm (20 to 30 in)	- tanks move only short distances.
Snow over 75 cm (30 in)	- tanks not used.

## **Offensive Operations**

5. In offensive operations under severe winter conditions, Soviet start lines are positioned closer to the enemy front lines than they are during other seasons of the year. Heated shelters, dug-outs, and bunkers are provided in these areas in an attempt to maintain the effectiveness of troops before they close with the enemy.

6. Although considerable importance is attached to the use of ski equipped troops, the assault is conducted without skis. On the other hand, when the battle reaches the depth of the enemy defence, ski troops are employed to outflank and envelop enemy strong points. In the initial assault, machine-guns, mortars, rocket launchers, and accompanying support guns are mounted on sleds.

7. Tanks, assault guns, and other tracked vehicles are used as prime movers, and to break trails through deep snow. Helicopters are employed to bring in supplies and ammunition for the assault echelon, and to fly out serious casualties.

## **Defensive Operations**

8. The Soviet defense system for winter warfare closely resembles a defence in a wide front, in that the front is not continuous. Instead, the defence consists of a series of strong points and battalion defence centres built around high ground, natural obstacles, villages, and hamlets. Dead space is covered by fire, minefields, and other difficult obstacles.

9. Counter-attacking and second echelon troops are usually equipped with skis. The counter-attack routes are preplanned and marked. The entire defence system is organized to minimize the effect of weather on personnel while at the same time exaggerating its effect upon the enemy. The Soviet Army makes extensive use of snow and ice to construct obstacles and dummy installations.

10. Artillery fire is used in an attempt to force the attackers off the road and compel them to advance laboriously across country. The Soviets try to destroy all cover in front of the defensive position which could be used by the enemy so that an attacking force must cross open terrain.



11. Soviet defences are established behind natural obstacles, such as deep snow, ravines, rivers, and streams which will slow or stop enemy tanks and assault guns. If high ground is available, it is defended as part of the plan to exhaust the attacking infantry.
12. In addition to the usual anti-tank and anti-personnel obstacles, the Soviets employ a number of obstacles peculiar to winter warfare. Snowbanks may be turned into slippery obstacles by freezing them with water. On the other hand, the Soviets have been known to use artificial thaws, such as the blasting of frozen rivers, to create water barriers.
13. In laying mines, consideration is given to the depth of snow, and the expected fall. If the snow is extremely deep, mines are placed on boards so that they will not sink into it.
14. Because men tire more easily in extremely cold weather, provisions are made for frequent rest periods, and heavy physical work is evenly divided among the troops. Their diet is watched, and an increased calorie intake is considered important. Hot food and drink, the Soviets believe, must be provided regularly for troops in forward positions.
15. Also, steps are taken to prevent frost-bite. The Soviets believe that frost-bite is preventable. Personnel who neglect to take precautions are severely punished. Heated medical aid stations are located closer than normal to combat units.

## **Equipment**

16. Most Soviet troops are trained under conditions identical with or approximating arctic or subarctic weather, and are acquainted with cold weather survival techniques from childhood. As expected, most weapons and equipment can be used or adapted for cold-weather operations. In extremely cold weather, weapons are protected with light coats of special winter lubricants. Special winter firing tables are employed.
17. Strict snow camouflage discipline is maintained. Personnel wear white camouflage capes; tanks, vehicles, and artillery are painted white. Some special units and equipment are employed in winter warfare. Helicopters play an important role in providing logistic support.
18. Mobility, a limiting factor in extreme cold and snow operations, has received considerable attention in the Soviet Union. Three oversnow vehicles have been developed. These were designed originally for use with Soviet scientific expeditions but are expected to provide the Soviet Army with a high degree of mobility for winter warfare.
19. The smallest of these vehicles, the GAZ-47, is a tracked amphibious transporter. It weighs only 4.2 tons but is capable of carrying a payload of 1,200 pounds or nine men.
20. A medium-weight vehicle, the 12-ton "Penguin", is a tracked amphibious vehicle capable of transporting a 2-1/2-ton payload over snow and across water barriers. The "Penguin" is an interesting example of Soviet standardization practice. It employs the same basic amphibious chassis used on the Soviet light tank, the tracked APC, and several one-round rocket launchers.

The use of one basic chassis on four combat vehicles facilitates not only production but also supply and maintenance procedures.

21. The third and most recent oversnow vehicle is the "Bogatyr" antarctic tractor which weighs 38 tons. This vehicle has a 32.5 square metre (350 square foot) duralumin body containing a laboratory, a radio station, a dormitory, and a kitchen.
22. Of these vehicles, only the GAZ-47 has begun to appear with Soviet Army units, but it is anticipated that the "Penguin" and even the massive "Bogatyr" will be introduced in the middle seventies.
23. With the application of special lubricants infantry and artillery weapons will function at temperatures well below  $-18^{\circ}\text{C}$ . Other measures, such as keeping ammunition dry and clean, removal of snow and ice, and the manual working of firing parts of small arms, and the recoil mechanism of artillery pieces are standard procedures.
24. The Soviet Army has long been adept in the operations of standard vehicles (tanks, trucks, and tractors) under conditions of extreme cold.
25. The PT-76 light amphibious tank, the T-54 medium tank, and the ATT heavy artillery tractor have pre-heater devices for assistance in cold weather starting. This pre-heater is a diesel fuel-fired flash-type boiler with closed circuit lines connected to the radiator, engine block, main oil pump, and oil pump tank.
26. Techniques employed to start vehicles not equipped with pre-heaters range from draining the oil and coolant overnight to using ether through the carburetor to assist starting.
27. Other transportation equipment, particularly aircraft, are playing an increasingly important role under arctic conditions. An interesting feature of this is the chemical de-icing system employed on Soviet helicopters. Soviet transport aircraft are also used to support troop deployment in the arctic.
28. In the fields of other combat equipment such as signal, chemical, and Calss 11, standard items are adaptable to extremely cold conditions. In addition, many of the items designed for use by Soviet arctic scientific research teams could be mass produced for use by Soviet troops.
29. In the field of special weapons, little is known of actual developments concerning cold-weather operations. However, the USSR has fired a large number of weather rockets in the arctic and antarctic areas. The firings in the arctic have been conducted off Franz Josef Land; in the Antarctic from a land base called "Mirnyy" and from an ocean vessel named "OB".
30. The Soviet weather rocket reportedly is 870 cm (29 feet) long, has a gross weight of one ton including payload container, and is fired from a mobile tower. The rocket is capable of lifting a 9-kilogram (20-pound) payload to an altitude of about 90 kilometres (56 miles).

31. Soviet experience with firing these rockets at sub-zero temperatures has a direct application to the solution of the problem of firing military missiles under extremely cold conditions.

### **Finnish "Motti" Tactics**

32. The Finns developed the "motti" during the Russo-Finnish War in 1939-40. It was most successful in the forested area of Finland in the subarctic winter. However, it should be remembered that the Russians at that time were neither prepared nor trained for warfare under such conditions. Also they were almost totally roadbound with few ski troops. The motti tactics are discussed here because they demonstrate how the subarctic winter can be exploited to defeat the enemy.

33. The motti system may be divided into three phases; reconnaissance and stopping, attack and cutting, and isolation and annihilation. Although each of these phases is a distinct part of the overall operation, two of them may be carried out at the same time. Reconnaissance is continuous until the mottis are isolated.

34. Following the initial reconnaissance, fighting patrols attack the enemy from all directions. The strength of patrols varies from a section to platoon. The accomplishment of their tasks depends upon surprise and speed; consequently they are lightly equipped and travel on skis. Ambush and hit-and-run tactics are used to disturb the composure of the enemy, create an air of uncertainty, and prevent uninterrupted sleep and rest. In addition, the enemy is compelled to use more forces on security tasks. The patrols create the illusion that attacking forces are everywhere, and the enemy never knows where to expect the next attack. Maximum use is made of the cover of darkness and the concealment of forests. Enemy security posts are avoided and the patrols hold their fire until within close range of the enemy. Guerilla patrols execute demolitions and plant mines in the rear of the enemy. Some patrols are given both reconnaissance and fighting tasks, but the majority only fighting tasks. Each patrol carries out more than one task; after attacking at one point it moves rapidly on skis to attack a different part of the column.

35. Sporadic attacks in company or battalion strength are made. They are directed at specific limited objectives. After the objective is destroyed or the enemy is forced to deploy, the attacking force disengages. Usually the divisional commander controls the overall operations and establishes the zones of activity for regiments (brigades) and separate battalions. He also retains indirect control over attacks units of company size or larger.

36. In the attack and cutting phase, surprise flanking movements and envelopments are carried out. This phase may be subdivided into three consecutive activities; movement into assembly areas, movement into attack areas near the objectives, and the enveloping and cutting. By these manoeuvres the enemy column is isolated and then sliced into small groups, each of which in turn is isolated.

37. The assembly areas are selected outside the radius of enemy land reconnaissance if possible, and may be as much as three to six miles from the objectives. Movement is in column and measures are taken to preserve surprise. The guiding or navigation detachment is at the head

of the column. The administrative echelon frequently remains in this area, but is split up and dispersed for concealment. The unit remains in the assembly area only long enough to organize and to set its last prepared hot meal before moving out.

38. The advance is made in column along the most concealed route. Reconnaissance for the supply routes is carried out at the same time. Flank patrols, detached from the main column, are sent out to secure potentially dangerous approaches into the route of the column. The march speed is controlled (about 1-1/2 km per hour (one mile per hour)). The troops do not exert themselves, avoiding undue perspiration. To cross open areas, combat teams break into several columns and cross on widely different tracks. Each column then travels on its own azimuth to its portion of the attack area. Since the success of this phase of motti depends on surprise, reconnaissance patrols are seldom dispatched forward of the column.

39. Cutting of the enemy's column is done within 270 metres (300 yards) of the location stated in the original order. The attacking unit is halted at the attack area, 270 to 450 metres (300 to 500 yards) from the cutting point, in a position which provides maximum concealment. The guide detachment advances as close to the cutting point as possible to provide security for the attacking unit, but refrains from combat or contact with the enemy flank patrols. The unit commander designates positions for the supporting weapons. Engineers are attached to the cutting troops. When all is in position, the breakthrough detachment executes the cut, and the cut is widened to 550 to 650 metres (600 to 700 yards). A strong road block is established at each flank of the break. Engineers lay mines and establish obstacles which deny this stretch of road to enemy use and ensure open lines of communication to the attackers. All enemy lines of communication are cut, and the task of isolating the assigned sections of the column begins. A previously designated element of the combat team crosses the road to begin the envelopment of the enemy column from the opposite side of road. In general the operations at all cutting points are executed simultaneously, day or night. When the motti is enclosed and contact established, the bulk of the combat team is withdrawn into assembly areas, in concealment.

40. As the enemy exhausts himself in an effort to break out, the main force regroups and repeats its cutting phase. The isolated mottis are split again by attacks on the flanks. The enemy lines of communication must be kept closed. If there are built-up fortifications, some softening will be necessary by sniper, direct fire weapons, harassing fire, and propaganda.

41. The principal conditions necessary for the success of motti tactics are:

- a. the ability of the attacker to move in deep snow, in dense forest, and on roadless terrain;
- b. the ability to live in the attack zone despite cold and snow to preserve the continuity of the battle;
- c. the ability to keep direction in dense forest, in darkness, and in storms and fog; and
- d. surprise.

## GLOSSARY OF TERMS

### **Accumulation**

Net gain of snow or ice during a specific period of time.

### **Blizzard**

A severe weather condition characterized by low temperatures and strong winds bearing a great amount of snow. Winds 28 knots (52 kmph), (32 mph) or higher, low temperatures and sufficient snow to reduce visibility to less than 152m (500 feet).

### **Break-up**

Period of spring thaw during which the ground surface is excessively wet and soft, and ice is disappearing from streams and lakes. Duration varies from 96 hours to six weeks. The break-up season causes difficult movement problems.

### **Candling**

A condition where deep ice cones melt on a vertical plain. The surface water finds its way through the ice by melting from the surface to the bottom. The ice appears as a series of icicles or candles. This type of ice although up to 13 cm (5 inches) in depth, is extremely dangerous because it has no cohesive strength.

### **Cold Injury**

An inclusive term applied to injuries resulting from cold. The most common are frost-bite, trenchfoot, immersion foot and chilblains.

### **Cold Soak**

A term applied to the accumulative effect of extreme cold weather on mechanical equipment. The maximum contraction for the weather concerned has taken place in the metals. Special techniques have thickened and do not provide lubrication.

### **Crevasse**

A fissure or rift in glacier, shelf ice or other land ice formation caused by thermal changes in the ice or by motion of the ice over underlying obstacles.

### **Emergency Landing Strip**

An unprepared landing strip suitable for small aircraft. It is not lighted, has no snow clearing equipment and fuel is not available or in some cases restricted.

### **Eskers**

Gravel or small boulder ridges deposited by the retreating ice age. They normally run in a North West-South East direction, and can be up to 30m (100 feet) higher than the surrounding surfaces. They may be up to 160 km (100 miles) in length.

### **Floating Bog**

A deep stagnant pool of water where the moss, grasses, and small shrubs have grown out from the edges to completely cover the surface.

**Freeze-Up**

Period during which the ground surface freezes and ice cover forms on streams and lakes. This period varies from one to three months depending on regional or local climatic conditions. Maintaining mobility becomes easier as the period progresses.

**Frost-bite**

A cold injury caused by freezing of the tissues.

**Frost Table**

More or less irregular surface that represents the depth of penetration of the winter frost in the seasonal frozen ground. It may or may not coincide with the permafrost table.

**Glacier**

Any field or stream ice of land origin. It may be either active or stagnant.

**Grey-out**

A weather phenomenon which occurs over a snow-covered surface with a uniform cloud cover during twilight or when the sun is close to the horizon. The result is an overall greyness to surroundings causing a loss of depth perception. Grey-out is similar to white-out except that during a white-out the horizon is indistinguishable.

**Ice Field**

A stagnant glacier.

**Ice Fog**

A type of fog composed of suspended particles of ice crystals 20-100 microns in diameter. It is formed by introduction of water vapour in clear, calm air of low temperature. Ice fog normally will be found in the vicinity of populated areas with temperatures of  $-37^{\circ}\text{C}$  or lower but may occur at temperatures as warm as  $-29^{\circ}\text{C}$ . Ice fog increases in frequency with decreasing temperatures until it is almost always present at air temperatures of  $-46^{\circ}\text{C}$  in the vicinity of a source of water vapour. Ice fog may form over a body of troops, bivouacs, vehicle parks, airfields, convoys and gun positions during firing.

**Muskeg**

Poorly drained organic terrain which is characteristic of the subarctic, covered with a thick resilient carpet of water-sodden mosses or clumps of grass or sedge and underlain by a high water-table, peat of various thickness and often permafrost.

**Permafrost**

Permanently frozen ground. A thickness of soil or other surficial deposit or even bedrock at a variable depth beneath the surface of the earth in which a temperature below freezing has existed continuously for thousands of years. In some areas of the arctic islands the permafrost layer extends to a depth greater than 480 m (1600 feet).

**Tree Line**

The upper limit of erect trees in mountainous regions or the northern limit of erect trees in the north. It is the limiting line of the subarctic and is characterized by the isotherm line where the monthly mean temperature for the warmest months is below 10°C.

**Tundra**

A flat or gently rolling area with a muck or rock surface over permafrost and consisting of a low mat of grasses, shrubs and other plants. This area is found above the tree line.

**White-out**

A condition of visibility which exists when an overcast sky prevents shadows and snow covered terrain reflects light at about the same intensity as the sky, causing the horizon to be indistinguishable and the recognition of irregularities in terrain very difficult. Only dark objects can be seen. Fog, ice fog and blizzard conditions will sometimes create a similar situation.

**Windchill**

The combined cooling effect of wind and air temperature on heated bodies.